

# Causal Models

Lukáš Lafférs

Matej Bel University, Dept. of Mathematics

MUNI Brno

11.11.2021

# Causality

Is it possible to recover a **causal** relationship from observational dataset?

# Graphical models

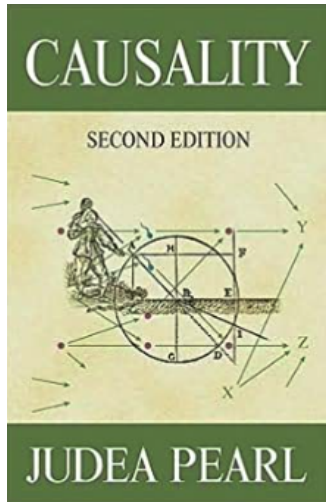

Judea Pearl (UCLA) and his book Causality.

# Graphical models

Unified setup on how to think about causality.

Every problem is visualized in terms of a **causal graph**.

It is easier to think about a problem once you have a graph that visualizes the relationships.

It provides a set of rules that show **when** and **how** it is possible to identify causal effects.

This set of rules may be automated.

It makes the thinking about the identification easier.

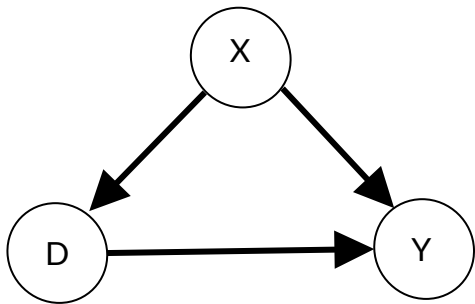

- The relationship of  $D$  and  $Y$  is of interest
- $D$  and  $Y$  are associated directly
- $D$  and  $Y$  are associated indirectly via  $X$

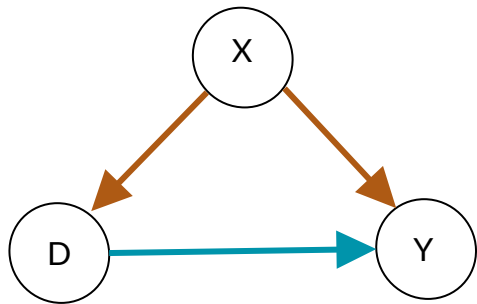

- The relationship of  $D$  and  $Y$  is of interest
- $D$  and  $Y$  are associated directly
- $D$  and  $Y$  are associated indirectly via  $X$
- $X$  is a **confounder**

# Notation

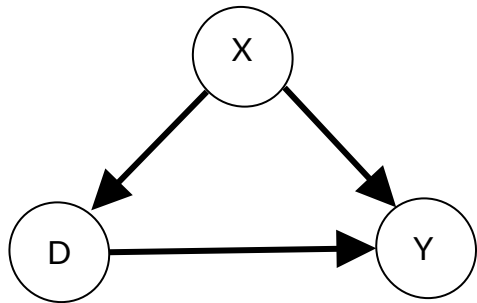

- Node
- Edge
- Path
- Directed path
- Parent/Child
- Ascendant/Non-ascendants
- Acyclic graph

# Directed Acyclic Graphs - DAGs

- **Directed** - arrows have direction
- **Acyclic** - there does not exist a cycle in this graph. Causality is an asymmetric concept
- **Graphs** - object that encodes the causal structure of the problem



## Direct effect

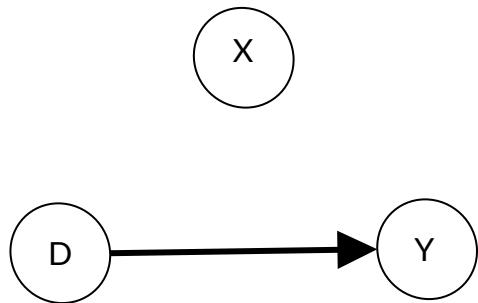

- $P(y, d, x)$  is the joint distribution (shorthand for  $P(Y = y, D = d, X = x)$ )
- $P(x|d, y) = P(x)$  (no edge between  $X$  and  $Y, D$ )

testable implications

$$P(y, d, x) = \underbrace{P(x)}_{P(x|par_x)} \cdot \underbrace{P(d)}_{P(d|par_d)} \cdot \underbrace{P(y|d)}_{P(y|par_y)} \implies P(y, d, x) = P(x) \cdot P(y, d) \text{ and}$$

therefore

$$X \perp\!\!\!\perp (D, Y)$$

# Bayesian factorization

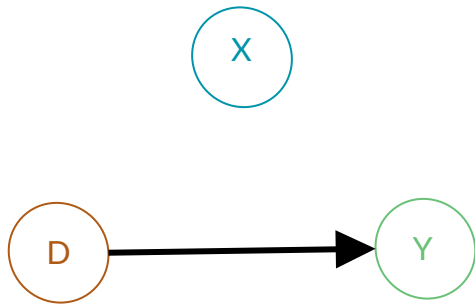

$$P(y, d, x) = \underbrace{P(x)}_{P(x|par_x)} \cdot \underbrace{P(d)}_{P(d|par_d)} \cdot \underbrace{P(y|d)}_{P(y|par_y)}$$

or in general

$$P(x_1, x_2, \dots, x_n) = P(x_1|par_{x_1}) \cdot P(x_2|par_{x_2}) \cdots P(x_n|par_{x_n})$$

Given its parents, the variable is independent of all of its non-descendants.

Every parent is a direct cause of all its children.

## Effect in reverse direction

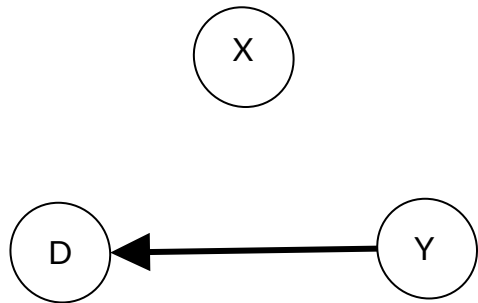

- $P(y, d, x)$  is the joint distribution
- $P(x|d, y) = P(x)$   
(no edge between  $X$  and  $Y, D$ )

testable implications

$P(y, d, x) = P(x) \cdot P(d|y) \cdot P(y) \implies P(y, d, x) = P(x) \cdot P(y, d)$  and therefore

$$X \perp\!\!\!\perp (D, Y)$$

## Confounded effect

Graph includes information about independencies

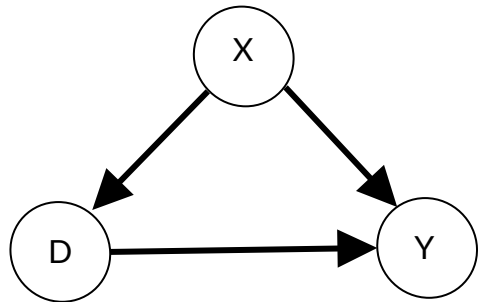

- $P(y, d, x)$  is the joint distribution

No testable implications.

## Direct and Indirect effect

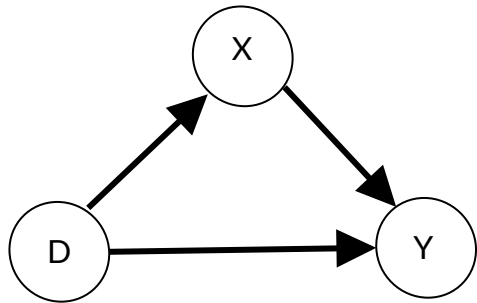

No testable implications.

- $P(y, d, x)$  is the joint distribution

## No effect (fork)

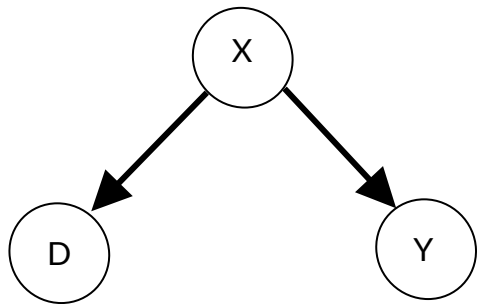

- $P(y, d, x)$  is the joint distribution
- $P(d|x, y) = P(d|x)$   
(no edge between  $D$  and  $Y$ )

testable implications

$P(y, d, x) = P(x) \cdot P(y|x) \cdot P(d|x) \implies P(y, d|x) = P(y|x) \cdot P(d|x)$  and therefore

$$Y \perp\!\!\!\perp D | X$$

## Indirect effect via X (chain)

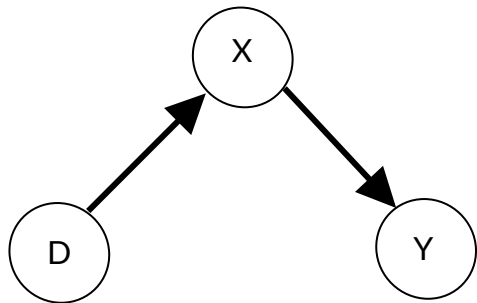

- $P(y, d, x)$  is the joint distribution
- $P(y|x, d) = P(y|x)$   
(no edge between  $D$  and  $Y$ )

testable implications

$$P(y, d, x) = \underbrace{P(x|d) \cdot P(d)}_{=P(d|x) \cdot P(x)} \cdot P(y|x) \implies P(y, d|x) = P(y|x) \cdot P(d|x) \text{ and therefore}$$

$$Y \perp\!\!\!\perp D | X$$



So far, we have seen that **very different setups** (in terms of direction of effects) have the **same testable implications**.

Graphs are helpful if we want to study their implications for statistical independencies.

Graphs alone are not sufficient, we need to equip this setup with something else in order to talk about **causality**.

## Collider (immorality)

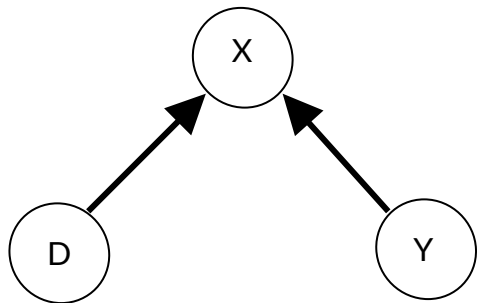

- $P(y, d, x)$  is the joint distribution
- $P(y|x, d) = P(y|x)$   
(no edge between  $D$  and  $Y$ )

testable implications

$$P(y, d, x) = P(x|d, y) \cdot P(d) \cdot P(y) \quad \underbrace{\implies}_{\text{sum across } x} \quad P(y, d) = P(y) \cdot P(d) \text{ and therefore}$$
$$Y \perp\!\!\!\perp D$$

## Collider (immorality) continued

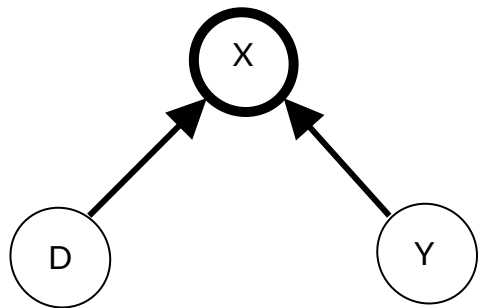

- Conditioning induces dependence
- Conditioned on  $X$ , previously independent  $D$  and  $Y$  are now dependent.

testable implications

$P(y, d, x) = P(x|d, y) \cdot P(d) \cdot P(y) \not\Rightarrow P(y, d|x) = P(y|x) \cdot P(d|x)$  and therefore

$$Y \not\perp\!\!\!\perp D|X$$

# Example 1 (collider bias) - known as "Bad controls"

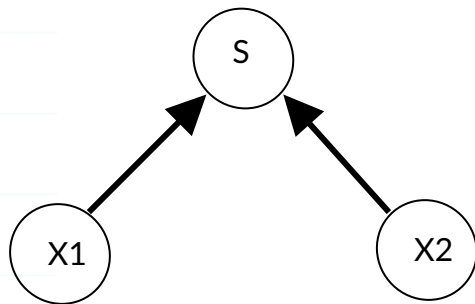
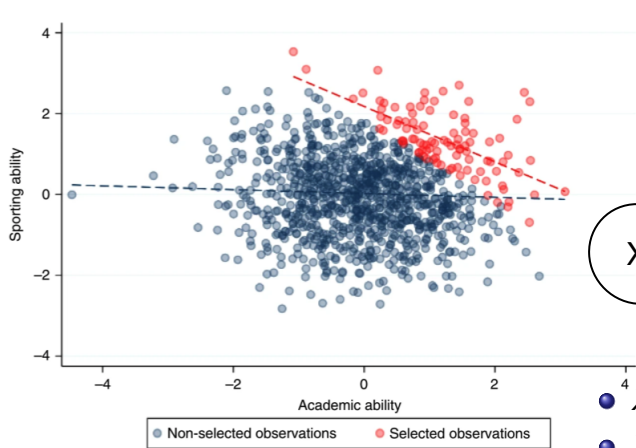

- $X_1$  - academic ability
- $X_2$  - sporting ability
- S - admitted to university

Griffith, Gareth J., et al. "Collider bias undermines our understanding of COVID-19 disease risk and severity." Nature communications 11.1

## Example 2 (collider bias)

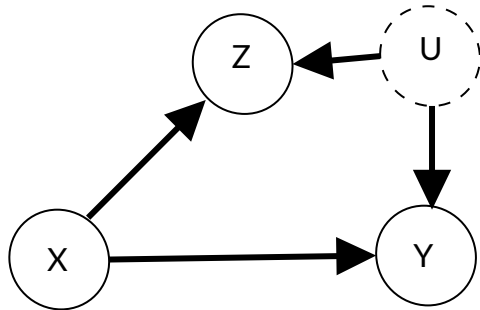

- $X$  - maternal smoking
- $Y$  - infant mortality
- $Z$  - birth-weight
- $U$  - unobserved risk factors (e.g. birth-defects, malnutrition)

Hernández-Díaz, Sonia, Enrique F. Schisterman, and Miguel A. Hernán. "The birth weight "paradox" uncovered?." American journal of epidemiology

164.11 (2006): 1115-1120.

## Example 3 (collider bias) - Obesity paradox

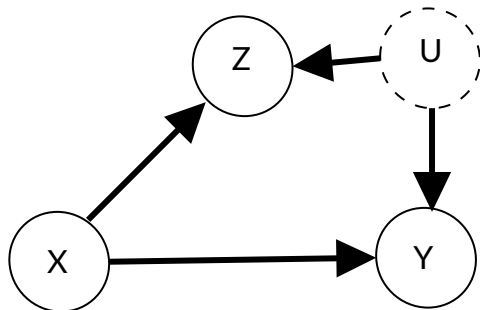

- X - obesity
- Y - mortality
- Z - heart-failure
- U - unobserved risk factors (e.g. genetic factors, lifestyle behaviour)

## Example 4 (collider bias) - Gender wage gap

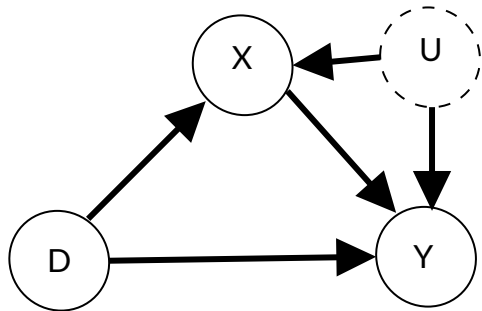

- $D$  - gender
- $Y$  - log wages
- $X$  - {education, work experience, occupation}
- $U$  - unobserved variables

## Example 5 (collider bias) - Nutrition/height puzzle

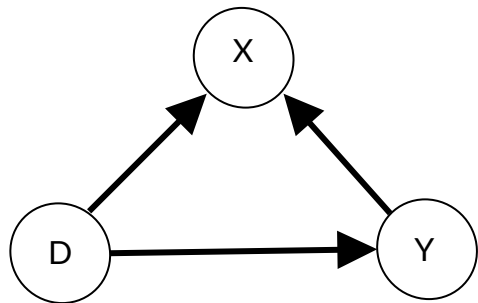

- *D* - childhood nutrition
- *Y* - adult height
- *X* - in military



All these examples show the importance of the **causal structure** of the problem at hand.

Conditioning on certain variables may (or may not) induce an association that is not of interest.

Failing to condition on the right variables may result in a mixed set of associations - also not of interest.

## More notation to come...

- Blocked path
- D-separation
- Causal vs non-causal association
- Manipulated graph
- Intervention - "do-operator"
- Sufficient adjustment set
- Structural Causal Models
- Endogenous vs exogenous variables

## Blocked path

Any path  $p$  is blocked by a set of variables  $B$  if:

(1)  $p$  contains a chain or a fork, such that the middle node is in  $B$

or

(2)  $p$  contains a collider, such that neither the middle node is in  $B$ , nor any of its descendants, are in  $B$

## Blocked path

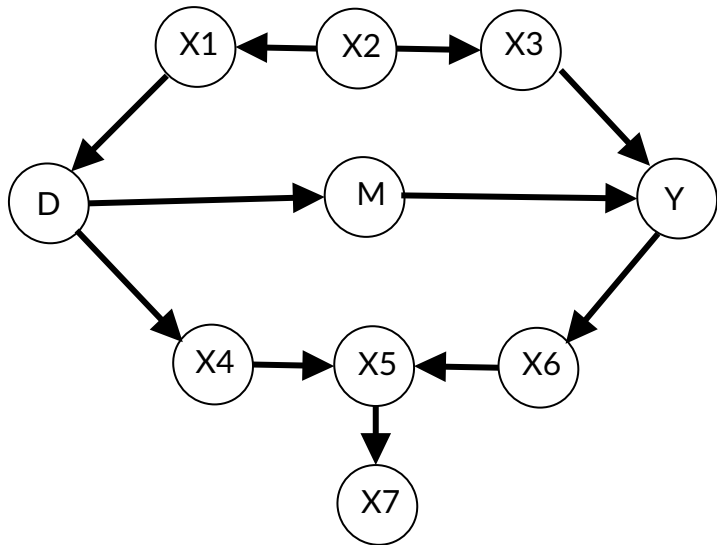

## d-separation

For a given graph  $G$ , let us have three disjoint sets of variables  $B_1, B_2, B_3$ :

$B_1$  and  $B_2$  are **d-connected** by  $B_3 \iff$  there exists an undirected path  $p$  between some vertex in  $B_1$  and some vertex in  $B_2$  such that for every collider  $C$  on  $p$ , either  $C$  or a descendant of  $C$  is in  $B_3$ , and no non-collider on  $p$  is in  $B_3$ .

$B_1$  and  $B_2$  are **d-separated** by  $B_3 \iff B_1$  and  $B_2$  are not  $d$ -connected by  $B_3$

$B_1$  and  $B_2$  are **d-separated** by  $B_3 \iff$  if  $B_3$  blocks every path between  $B_1$  and  $B_2$

$\{D\}$  and  $\{Y\}$  are *d-connected* by  $\{X5\}$ . There are 3 paths.

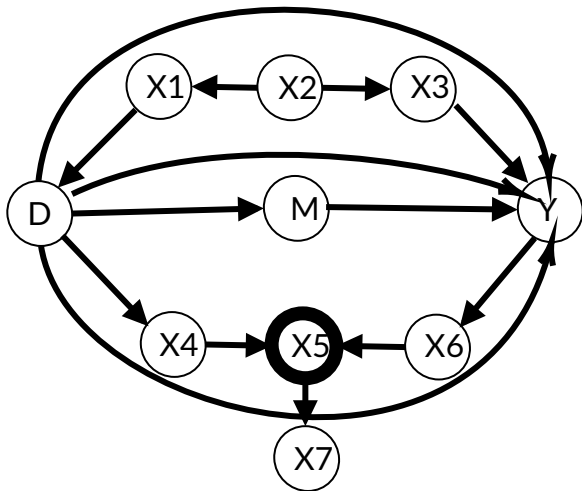

$\{D\}$  and  $\{Y\}$  are *d-separated* by  $\{X1, M\}$ . All three paths are blocked..

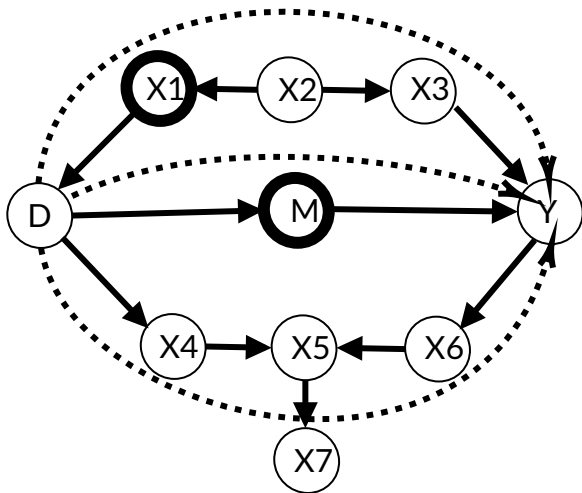

# d-separation and statistical independence

Notation:

$(B_1 \perp\!\!\!\perp B_2 | B_3)_G \iff B_1$  and  $B_2$  are *d-separated* by  $B_3$  in a graph  $G$

$$\implies B_1 \perp\!\!\!\perp B_2 | B_3$$

D-separation implies statistical independence  
(assuming that the graph is correct).



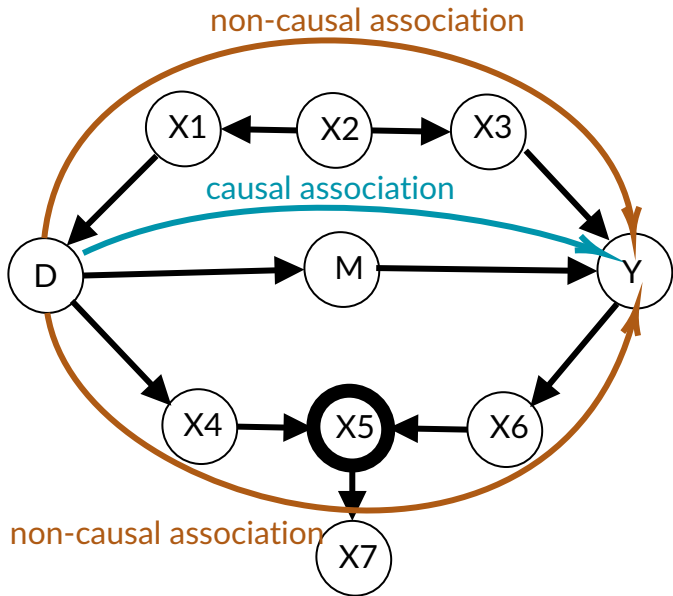

non-causal association

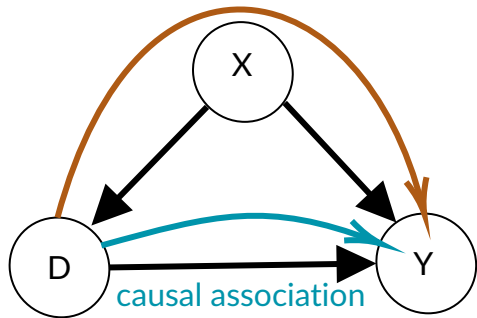

causal association

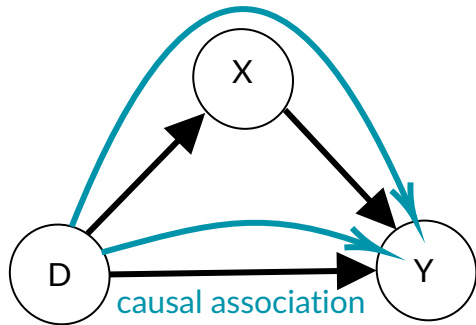

## Intervention - "do-operator"

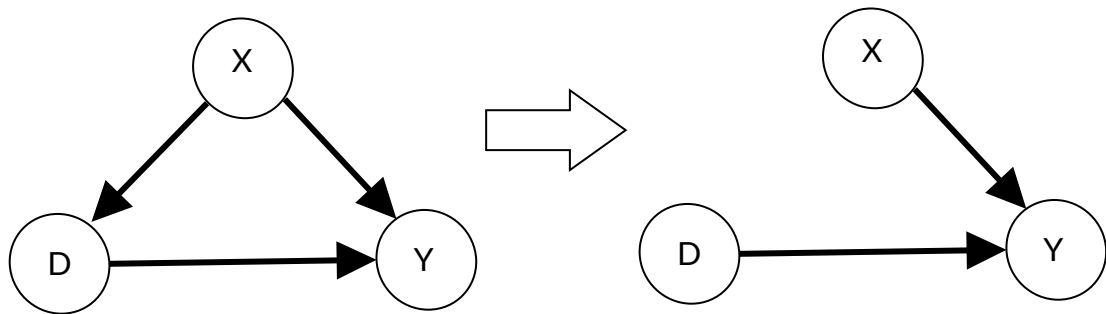

Manipulating  $D$  to be equal to  $d$

$$do(D = d)$$

removes all the parents from node  $D$  and sets  $P(D = d) = 1$ .

## Intervention - "do-operator"

Manipulating  $D$  to be equal to  $d$

$$do(D = d)$$

removes all the parents from node  $D$  and sets  $P(D = d) = 1$ .

It induces an interventional distribution:

$$P(Y, X | do(D = d))$$

which can be used to define potential outcomes:

$$E[Y(d)]$$

# Three different causal graphs

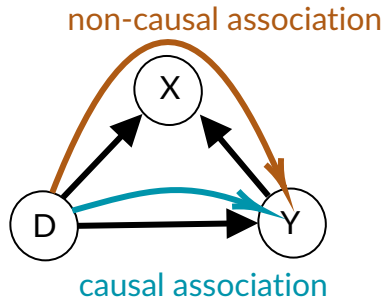
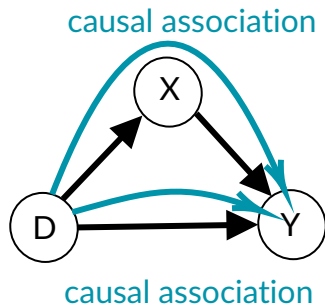
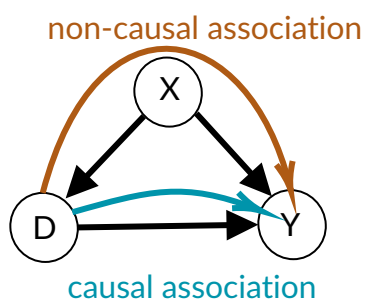

# Controlling for $X$

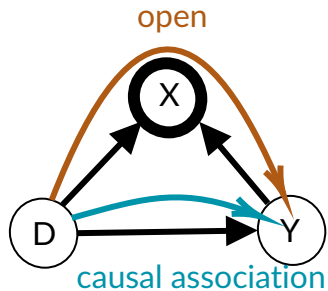
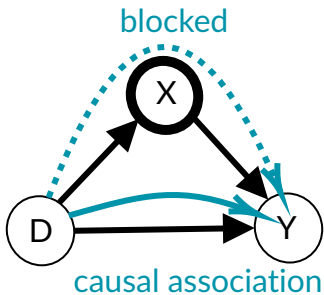
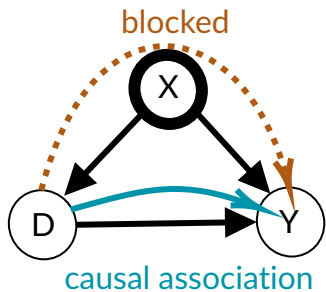

# Not-controlling for $X$

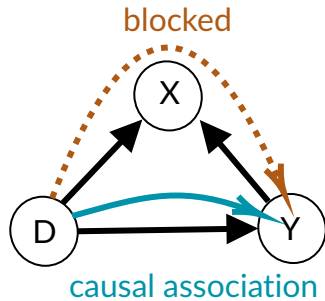
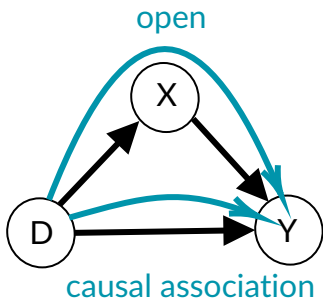
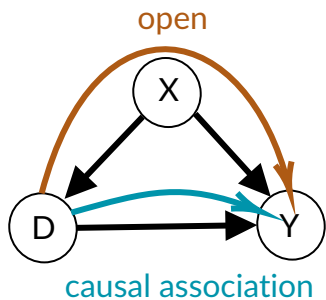

## Back-door criterion

A set of variables  $B$  satisfies the **back-door criterion** if it:

- blocks all spurious paths (non-causal, non-directed) from  $D$  to  $Y$
- does not block any of the causal paths from  $D$  to  $Y$
- does not open any spurious paths (via colliders or their descendants)

Then

$$E[Y(d)] = E[Y|do(D = d)] = E[\underbrace{E[Y|D = d, B]}_{\text{random (due to B)}}]$$

thus we get the mean of potential outcome  $Y(d)$  from non-experimental data (!)

(Note: The **outer expectation** is taken with respect to  $B$ .)



# Back-door criterion

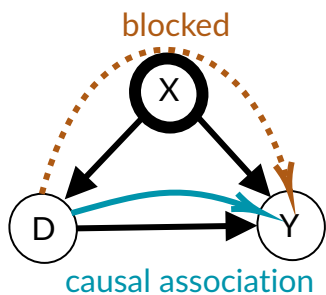

$$B = \{X\}$$

$$E[Y(d)] = E[E[Y|D=d, X]]$$

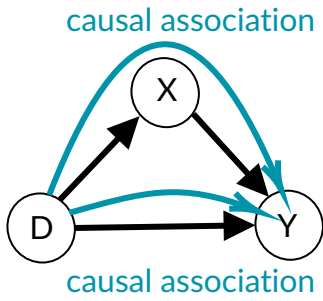

$$B = \{\}$$

$$E[Y(d)] = E[Y|D=d]$$

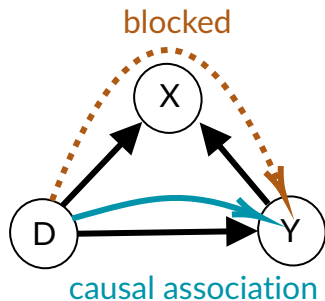

$$B = \{\}$$

$$E[Y(d)] = [E[Y|D=d]]$$

## Example 6: Different conclusions based on the same data

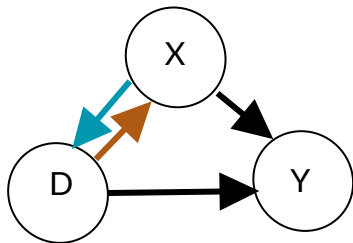

- $X$  - management position
- $D$  - gender or lifestyle
- $Y$  - wage

Causal structure matters. Very different conclusions can be reached from the same data.

## Example 6a:

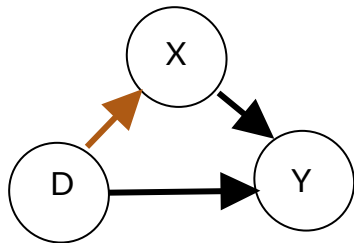

- $X$  - management position
- $D$  - gender
- $Y$  - wage

$$E[Y(d)] = E[Y|D = d] = \sum_{x \in \{0,1\}} E[Y|D = d, X = x] Pr(X = x|D = d)$$

## Example 6b:

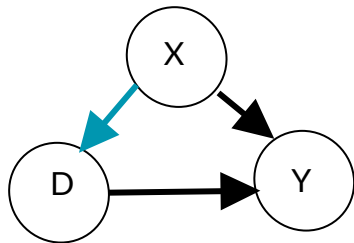

- $X$  - management position
- $D$  - lifestyle
- $Y$  - wage

$$E[Y(d)] = E\left[E[Y|D=d, X]\right] = \sum_{x \in \{0,1\}} E[Y|D=d, X=x]Pr(X=x)$$

## Example 6a:

	♀	♂
Not manager	3163 (87)	3015 (59)
Manager	5592 (13)	5319 (41)

- $X$  - management position
- $D$  - gender
- $Y$  - wage

$$E[Y(\text{♀})] = \sum_{x \in \{0,1\}} E[Y|D = \text{♀}, X = x] Pr(X = x|D = \text{♀}) = 3163 \cdot 0.87 + 5592 \cdot 0.13 = 3478.77$$

$$E[Y(\text{♂})] = \sum_{x \in \{0,1\}} E[Y|D = \text{♂}, X = x] Pr(X = x|D = \text{♂}) = 3015 \cdot 0.59 + 5319 \cdot 0.41 = 3959.64$$

$$E[Y(\text{♀}) - Y(\text{♂})] = 3478.77 - 3959.64 = -480.87$$

## Example 6b:

	☺	☹
Not manager	3163 (87)	3015 (59)
Manager	5592 (13)	5319 (41)

- $X$  - management position
- $D$  - lifestyle
- $Y$  - wage

$$E[Y(\text{☺})] = \sum_{x \in \{0,1\}} E[Y|D = \text{☺}, X = x]Pr(X = x) = 3163 \cdot \frac{87 + 59}{200} + 5592 \cdot \frac{13 + 41}{200} = 3818.83$$

$$E[Y(\text{☹})] = \sum_{x \in \{0,1\}} E[Y|D = \text{☹}, X = x]Pr(X = x) = 3015 \cdot \frac{87 + 59}{200} + 5319 \cdot \frac{13 + 41}{200} = 3637.08$$

$$E[Y(\text{☺}) - Y(\text{☹})] = 3818.83 - 3637.08 = 181.75$$

# Do-calculus

Back-door criterion is only an application of one of the three rules of "do-calculus"

There are three rules that provide exhaustive manipulation with do-operator

- this whole process can be fully automated (!)
- yes, that's correct, automated!

## 1. Ignoring observations

$$P(y|z, do(x), w) = P(y|do(x), w) \iff \underbrace{(Y \perp\!\!\!\perp Z | W, X)_{G_{\bar{X}}}}_{\text{remove all the arrows pointing into } X}$$

## 2. Treating interventions as observations

$$P(y|do(z), do(x), w) = P(y|z, do(x), w) \iff \underbrace{(Y \perp\!\!\!\perp Z | W, X)_{G_{\bar{X}, \underline{Z}}}}_{\text{remove all the arrows pointing from } Z}$$

## 3. Ignoring interventions

$$P(y|do(z), do(x), w) = P(y|do(x), w) \iff \underbrace{(Y \perp\!\!\!\perp Z | W)_{G_{\bar{X}, \bar{Z}(w)}}}_{\text{remove all the arrows pointing into } Z(W) \text{ that are not ancestors of } W}$$



## Back-door criterion?

$$\begin{aligned}P(y|do(x)) &= \underbrace{P(y|do(x), z) \cdot P(z|do(x))}_{\text{Chain rule}} \\&= \underbrace{P(y|x, z) \cdot P(z|do(x))}_{\text{Rule 2}} \\&= \underbrace{P(y|x, z) \cdot P(z|\{\})}_{\text{Rule 3}} \\&= \underbrace{P(y|x, z) \cdot P(z)}_{\text{Backdoor criterion}}\end{aligned}$$

Note that:  $do(x)$  is a shorthand notation for  $do(X = x)$ .  
This is an **event**: "X is manipulated to be equal to x"

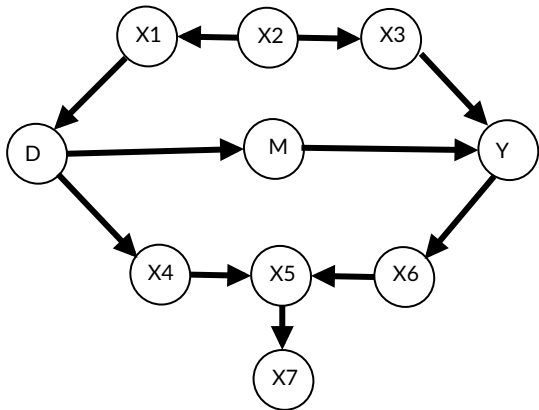

- $D = f_D(X_1)$
- $M = f_M(M)$
- $Y = f_Y(M)$
- $X_1 = f_1(X_2)$
- $X_2 = X_2$
- $X_3 = f_3(X_2)$
- $X_4 = f_4(D)$
- $X_5 = f_5(X_4, X_6)$
- $X_6 = f_6(Y)$
- $X_7 = f_7(X_5)$

# Structural causal models

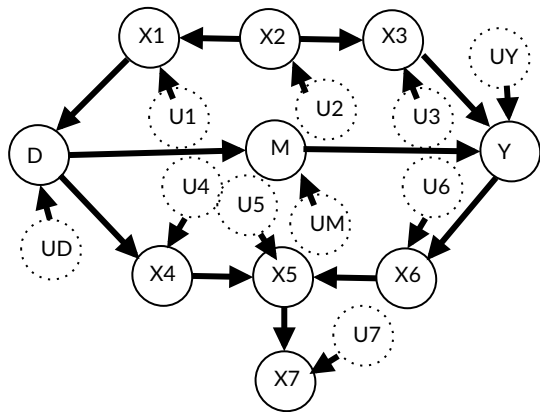

- $D = f_D(X_1, U_D)$
- $M = f_M(M, U_M)$
- $Y = f_Y(M, U_Y)$
- $X_1 = f_1(X_2, U_1)$
- $X_2 = f_2(U_2)$
- $X_3 = f_3(X_2, U_3)$
- $X_4 = f_4(D, U_4)$
- $X_5 = f_5(X_4, X_6, U_5)$
- $X_6 = f_6(Y, U_6)$
- $X_7 = f_7(X_5, U_7)$
- $U \sim P$

# Modified Structural Causal Model

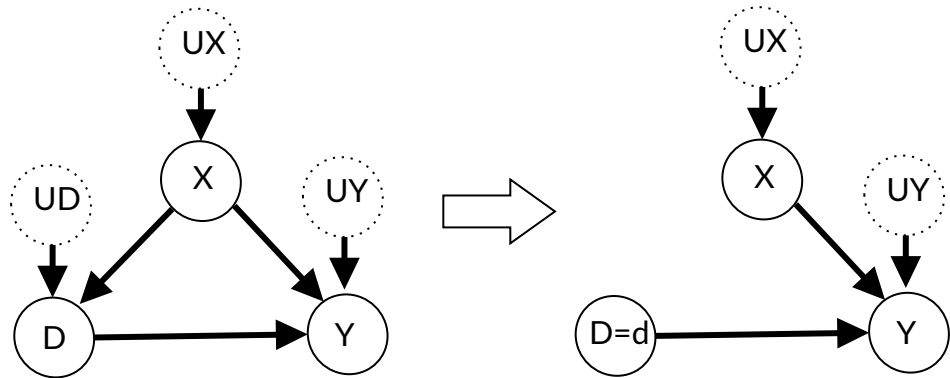

# Modified Structural Causal Model

- $D = f_D(X, U_D)$
- $X = f_X(U_X)$
- $Y = f_Y(D, X, U_Y)$

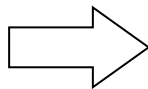

- $D = d$
- $X = f_X(U_X)$
- $Y = f_Y(D, X, U_Y)$

## Example 7 (unobserved confounders) - Returns to education

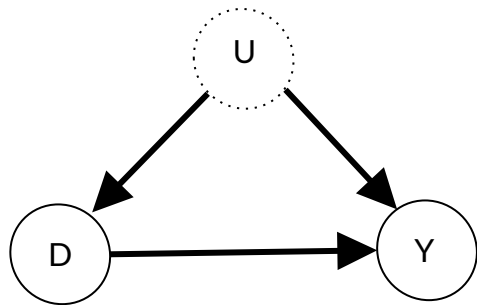

- $D$  - education
- $Y$  - log wages
- $U$  - unobserved ability

We cannot close the backdoor path via  $U$  because it is unobserved.

## Example 8: Human Capital Model (Becker 1994)

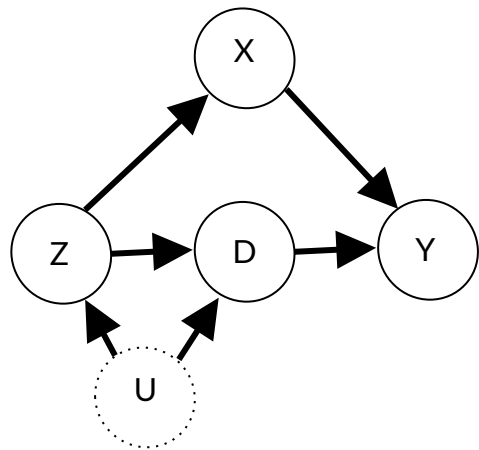

- Z - parental education
- D - education
- Y - log wages
- X - family income
- U - unobserved background characteristics

Conditioning on X closes all the backdoor paths.

## Example 9: Human Capital Model (Becker 1994) - ver.2

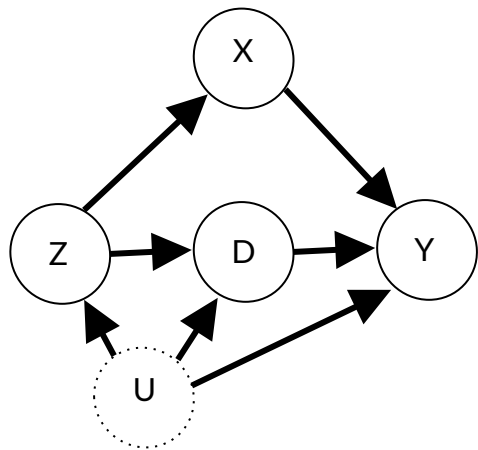

- Z - parental education
- D - education
- Y - log wages
- X - family income
- U - unobserved background characteristics

**Not possible** to close the backdoor path via *U* as it is unobserved



## Example 10: Schooling again

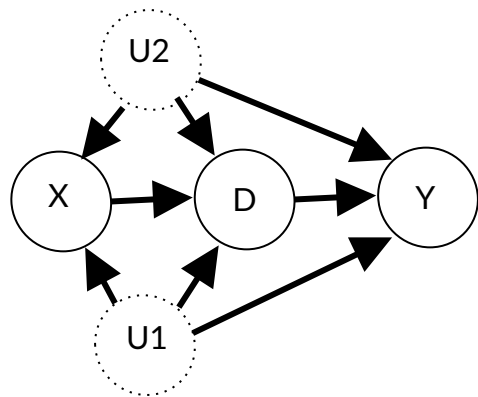

- $D$  - education
- $Y$  - log wages
- $X$  - family income
- $U1$  - unobserved mother's characteristics
- $U2$  - unobserved father's characteristics

conditioning on  $X$  makes things **even worse** as it opens up two new paths

## Example 11: Discrimination

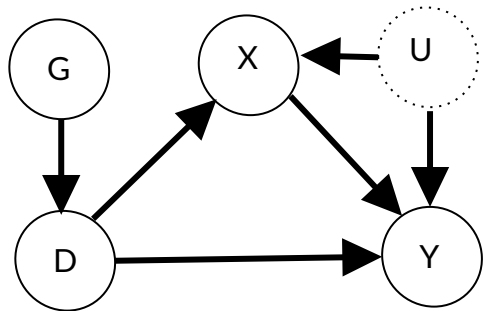

- $G$  - gender
- $D$  - discrimination
- $X$  - occupation
- $Y$  - log wages
- $U$  - unobserved ability

conditioning on  $X$  closes the mediated path but it **opens up a new path**

$$D \leftarrow X \leftarrow U \rightarrow Y$$

## Example 12: Covid risk factors

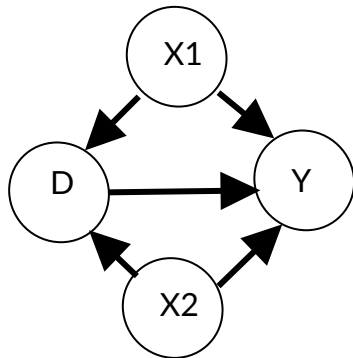

- $X_1$  - smoking
- $X_2$  - frailty
- $D$  - Covid hospitalization
- $Y$  - death

looking at the hospitalized patients only (conditioning on  $D$ ) induces spurious correlation among different independent(!) risk factors: smoking ( $X_1$ ) and frailty ( $X_2$ )

## Example 13: Age adjustment for Vaccine effectiveness

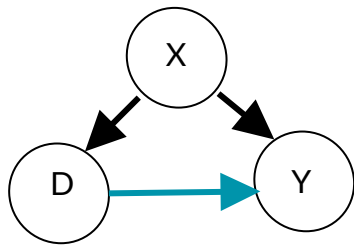

- $X$  - age
- $D$  - vaccination
- $Y$  - severe Covid

Adjusting for age closes the back-door path.

## Example 14 - many confounders

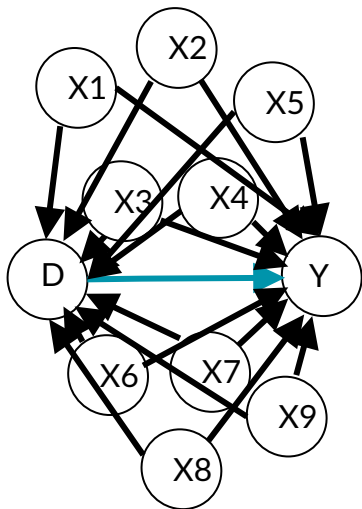

- $X_1, X_2, \dots$  - controls
- $D$  - treatment
- $Y$  - outcome

We can hopefully close all the backdoor paths.

How plausible is this model?

# Example 15 - Gender wage gap decomposition

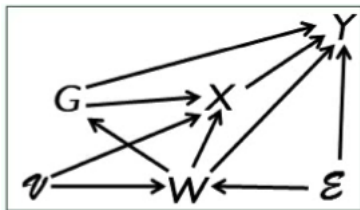
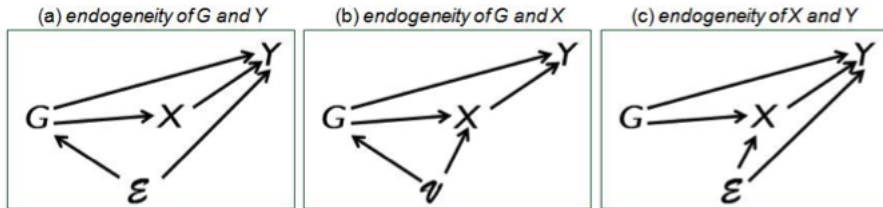

- Y - wage
- G - gender
- X - educ., work exp., occup., region... (in 1998)
- W - parent's education, foreign born (in 1979)

# Example 16 - Mitigating measures and Covid-19

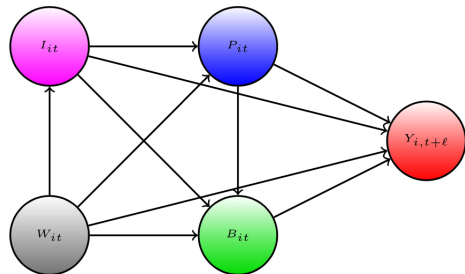

- $I_{i,t}$  - information
- $P_{i,t}$  - adopted policies
- $W_{i,t}$  - unobserved confounding factors
- $B_{i,t}$  - behavior variables
- $Y_{i,t+l}$  - future health outcomes

$$Y_{i,t+l} = \alpha' B_{it} + \pi' P_{it} + \mu' I_{it} + \delta_Y' W_{it} + \varepsilon_{it}^y,$$

$$B_{it} = \beta' P_{it} + \gamma' I_{it} + \delta_B' W_{it} + \varepsilon_{it}^b,$$

$$P_{it} = \eta' I_{it} + \delta_P' W_{it} + \varepsilon_{it}^p,$$

$$\varepsilon_{it}^y \perp B_{it}, P_{it}, I_{it}, W_{it}$$

$$\varepsilon_{it}^b \perp P_{it}, I_{it}, W_{it}$$

$$\varepsilon_{it}^p \perp I_{it}, W_{it}$$

## Lessons to take:

- causal structure is important
- beware of colliders
- working with causal models could be useful, it may clarify your thinking
- there are different views on how useful the whole DAG literature is (Epidemiology, CS vs Economics)



## Further topics

- maybe I cannot manipulate  $D$ , but I can manipulate  $Z$  (surrogate experiments)
- there are tools for addressing external validity (transportability)
- from the data it is possible to create class of admissible DAGs (causal discovery)
- this is currently an area of active research in CS and it seems to be slowly leaking into economics

Thank you for your attention!

# References

- This is an overview written for economists. It is sufficient if you read this up to page 19: Hünernmund, Paul, and Elias Bareinboim. "Causal Inference and Data Fusion in Econometrics." arXiv preprint arXiv:1912.09104 (2019).
- This book is the comprehensive DAG book, there is no book that matches this one in terms of the depth of the exposition. Pearl, Judea. Causality. Cambridge university press, 2009.
- This is a book on the other side of the spectrum. Short and succinct, very readable: Pearl, Judea, Madelyn Glymour, and Nicholas P. Jewell. Causal inference in statistics: A primer. John Wiley & Sons, 2016.
- Please read this, it is difficult to find anything better. Appendix A provides a quick intro in DAG calculus. Cinelli, Carlos, Andrew Forney, and Judea Pearl. "A crash course in good and bad controls." Available at SSRN 3689437 (2020).
- Banack, Hailey R., and Jay S. Kaufman. "The "obesity paradox" explained." *Epidemiology* 24.3 (2013): 461-462.
- Hernández-Díaz, Sonia, Enrique F. Schisterman, and Miguel A. Hernán. "The birth weight "paradox" uncovered?." *American journal of epidemiology* 164.11 (2006): 1115-1120.
- Griffith, Gareth J., et al. "Collider bias undermines our understanding of COVID-19 disease risk and severity." *Nature communications* 11.1 (2020): 1-12.
- Blau, Francine D., and Lawrence M. Kahn. "The gender wage gap: Extent, trends, and explanations." *Journal of economic literature* 55.3 (2017): 789-865.
- Schneider, Eric B. "Collider bias in economic history research." *Explorations in Economic History* 78 (2020): 101356.
- P. Hunermund's course on DAGs (paid): <https://www.udemy.com/course/causal-data-science/>
- P. Hunermund's lecture on DAGs. It is a compact version of the above course: <https://www.youtube.com/watch?v=GtpnWQ9uTL8> based on Hünernmund, Paul, and Elias Bareinboim. "Causal Inference and Data Fusion in Econometrics." arXiv preprint arXiv:1912.09104 (2019).
- Excellent exposition on do-calculus here: <https://www.andrewheiss.com/blog/2021/09/07/do-calculus-backdoors>
- Huber, Martin. "Causal pitfalls in the decomposition of wage gaps." *Journal of Business & Economic Statistics* 33.2 (2015): 179-191.
- DAGs in action on a very relevant topic: Chernozhukov, Victor, Hiroyuki Kasahara, and Paul Schrimpf. "Causal impact of masks, policies, behavior on early covid-19 pandemic in the US." *Journal of econometrics* 220.1 (2021): 23-62.
- Excellent and super clear course on many of the concepts we covered here: <https://www.bradyneal.com/causal-inference-course> It is hard to compete with this one!
- CausalAI Lab of Elias Bareinboim is on the research frontier of Causal inference with machine learning <https://causalai.net>