

# Operation Management (OM) Introduction

Ing.J.Skorkovský, CSc,  
Department of Corporate Economy  
FACULTY OF ECONOMICS AND ADMINISTRATION  
Masaryk University Brno  
Czech Republic

# Coordinates (will be part of OM Intro as well)

- **Lecturer** : Ing.Jaromír Skorkovský, CSc.
  - Department of Corporate Economy (5th floor)
  - [miki@econ.muni.cz](mailto:miki@econ.muni.cz)
  - +420 731113517
- **Study material** : will be updated regularly after every lesson (is.muni.cz and Interactive Syllabi )
- So far there is a lot of material there but mind you that nearly every part will be slightly or more heavily modified this year. So the correct material will have at the end of its name specification ...20YY mmdd e.g. 20YYMMDD if not specified otherwise in advance (e.g. 20210920)
- **Attendance** : seminar and lectures **are obligatory** – see subject specification (is.muni.cz) – first vital condition to be admitted to exam !!!!)
- **Excuses** : if serious reason emerges- **only written form is accepted**
- **Seminar work** : will be assigned after some theory will be presented. Accepted seminar work is the second condition to be admitted to an exam. Assign time: 10.11.2021
- **Tuition plan** : at the **end** of this slide show
- **Name of the tuition plan file** : Tuition plan for AOPR\_20YYMMDD
- For the case of normal contact teaching : AOPR: P312 (308)- every monday on 16:00 and VT206 and every Wednesday on 12:00
- In case of online teaching during a pandemic : MS TEAMS

# Tutor experiences from latest projects

- ITEC Johannesburg
- Peter Paper Johannesburg (<https://www.peterspapers.co.za/>)
- Training of personel for Navertica South Africa
- SW localisations
  - Boltrics (Warehouse Management)
  - Planner One (Ortems)

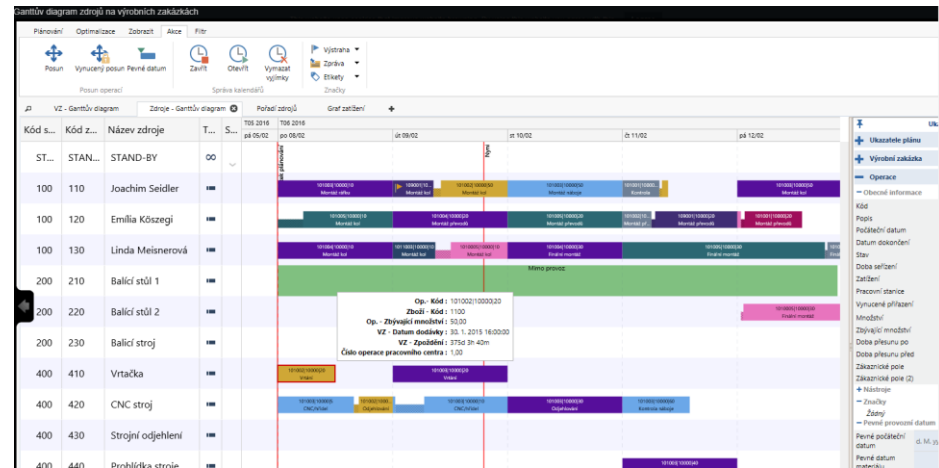

# Principles

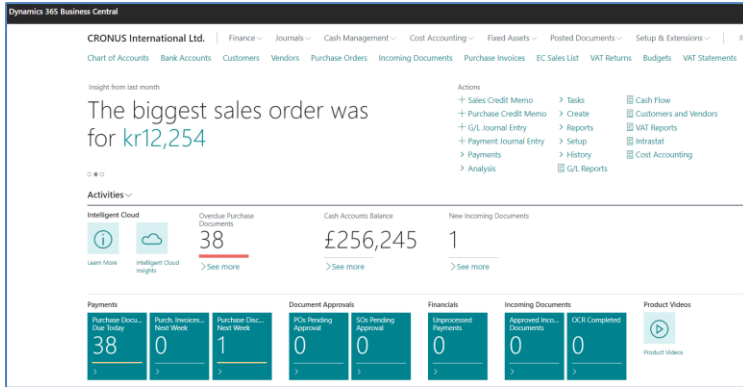

Information technology

Management philosophy

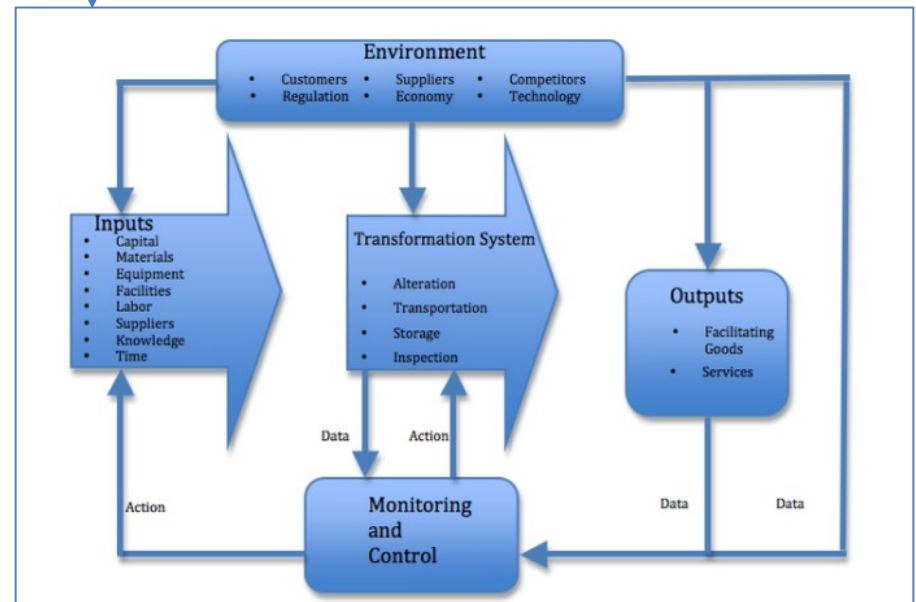

Feedback

# What is going on ?

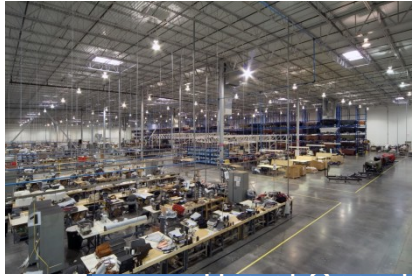

Use of Operations Management (OM) in external environment  
**(main target)**



General knowledge of OM methods acquired at university and long-standing experience

$$= \frac{\sum_{x_1} f_1(x_1) f_2(x_2, x_1)}{\sum_{x_1} f_1(x_1) \sum_{x_2} f_2(x_2, x_1)}$$

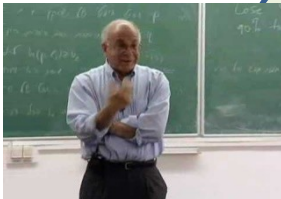
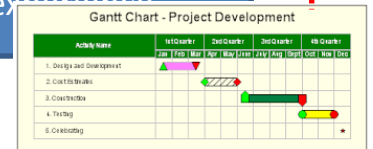

Knowledge of methods and experience from research and literature - **teachers**



Knowledge of methods and experience from outside world - **consultants, managers, ...**

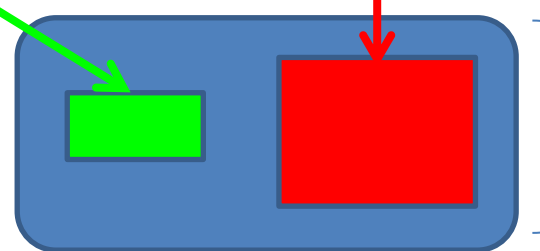
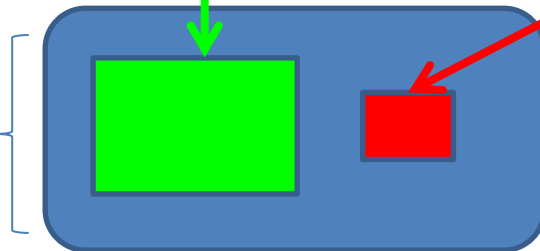

Extent of knowledge

Extent of knowledge



**Synergy and put OM into practice**

# OM all around us

OM is the management of all processes used to design, supply, produce, and deliver valuable goods and services to customers



**INBOUND**

**Processing-transformation**

**OUTBOUND**

TQM = Total Quality Management, Six Sigma, ...

ERP: Logistics, Transportation

MRP, JIT, APS, Lean Manufacturing, Little's law

ERP: Marketing, Selling, Invoicing, Payment, ...

# Selected OM methods, which will be kicked around as time will move on

- Theory of Constraints (TOC) -(AOPR)
- Balanced Scorecard -(AOPR)
- Project Management methods (Critical Chain) -(AOPR)
- Material Requirement Planning (MRP) and Just-in-Time principles  
-(more in detail live in ESP MS Dynamics NAV 2018w1 or MS Dynamics 365 Business Central)
- Advanced Planning and Scheduling (APS) -(AOPR only basics)
- Six Sigma – quality management -(AOPR- reason -> JIT introduction)
- Boston matrix and PLC, SWOT and Magic Quadrant Matrices -(AOPR)
- Little´s Law (relations between WIP, Throughput and Cycle time) -(AOPR)
- Linear programming – optimization principles- (AOPR)
- Yield Management - (AOPR)
- Kepner-Tregoe (support of decision making) - (AOPR)
- Decision trees -(AOPR)

WIP=Work in Progress, APS=Advanced Planning and Scheduling

PLC=Product Life Cycle

# Some tools which have to be used

- **ERP**-Enterprise Resource Planning (MS Dynamics NAV 2018w1 or MS Dynamics 365 Business Central)
  - Necessary installation, handling, and system setup-principles
  - Inventory – Items – Transports –Availability of components (items)
  - Purchase –dealing with Suppliers (**SCM**)>Payables
  - Selling – dealing with Customers-> Reveivables
  - Payment – bank operations
  - Accounting basics
  - **CRM**- **C**ustomer **R**elationship **M**anagement
  - Manufacturing – Planning and Shop Floor Control->WIP,COG
  - Budgets
  - Reporting



**SCM**=Supply Chain Management, **COGS**=Cost of Good Sold

ERP serves as the magnifying glass to processes...



# Controlling processes in Supply Chain Management (SCM)

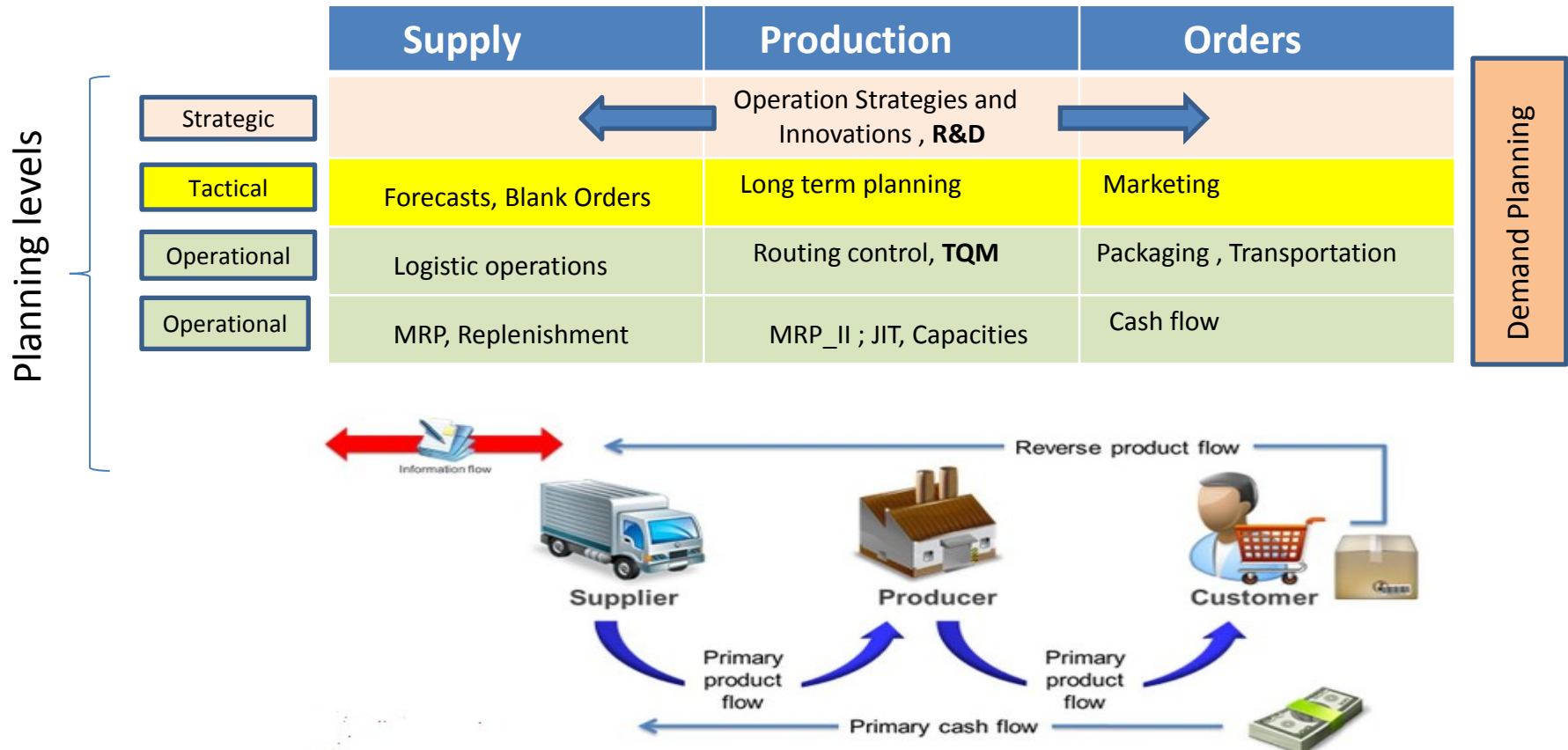

Used abbreviations : **R&D** –Research and Development; **TQM**-Total Quality Management; **JIT**- Just –In-Time; **MRP\_II**-Manufacturing and Resource Planning

Used abbreviations (slide number 3) : **ERP** - Enterprise Resource Planning ; **APS** – Advanced Planning and Scheduling , **MRP**-Material Requirement Planning

# Deming cycle (based on periodicity)

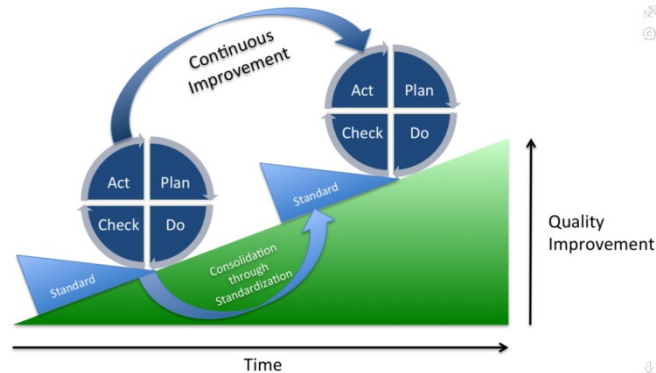

**Plan:** Define the problem to be addressed, collect relevant data, and ascertain the **problem's root cause** (e.g. by use of **TOC**=Theory of Constraint)

**Do:** Develop and implement a solution; decide upon a measurement to gauge (assess) its effectiveness.

**Check:** Confirm the results through **before-and-after** data comparison.

**Act:** Document the results, inform others about process changes, and make recommendations for the problem to be addressed in the next **PDCA** cycle.

# Another PDCA angle of view



This will be modified in following **South African** project show (use of **Balanced Score Card**)

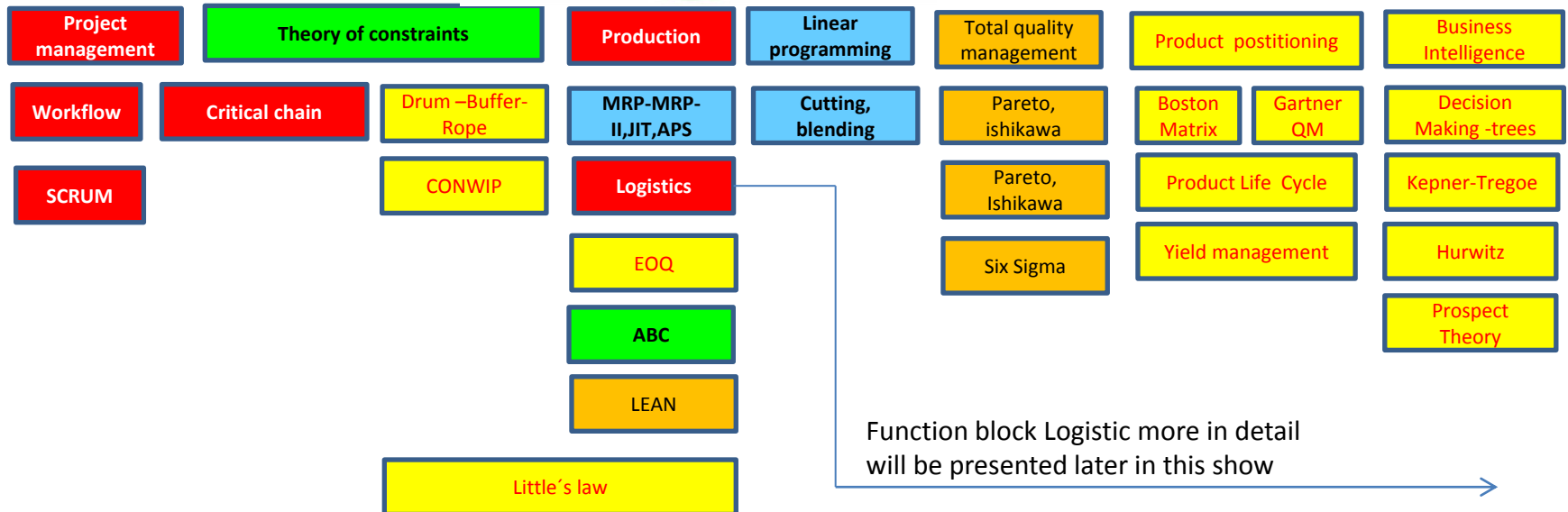

Used abbreviations : QM– Quadrant Matrix; CONWIP – Constant Work in Progress; EOQ – Economic Order Quantity ; MRP - Material Requirement Planning

# A subset of ERP-driven operations (NAV)

See next slide

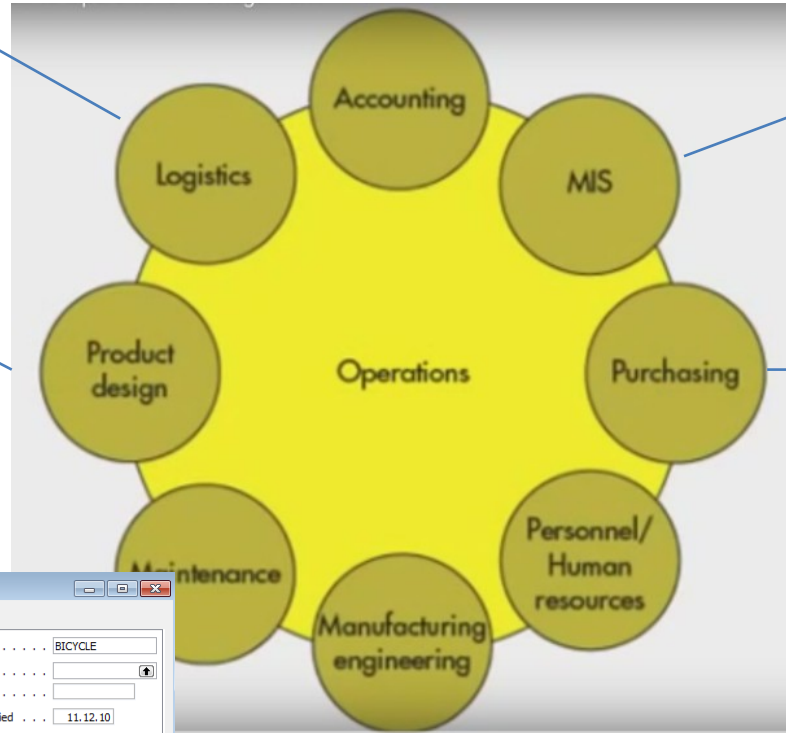

**Microsoft Dynamics NAV 2009 R2**  
 Version W1 6.0 R2 (6.00.32012)  
 Copyright (C) 2010 Microsoft. All rights reserved.  
 This product is licensed to:  
 4805500  
 NAVERTICA a.s.  
 Sumavska 15  
 Brno 602 00  
[Check your license information](#)  
 Warning: This computer program is protected by copyright law and international treaties.  
 Unauthorized reproduction or distribution of this program, or any portion of it, may result in severe civil and criminal penalties, and will be prosecuted to the maximum extent possible under the law.

**Manufacturing**

- Product Design
  - Items
  - Production BOM
  - Routings
  - Families
  - Exchange Production BOM Item
  - Delete Expired Components
  - Calculate Low-Level Code
- Reports
- Capacities
- Planning
- Execution
- Costing

**Purchase**

- Planning
  - Items
  - Vendors
  - Requisition Worksheets
  - Recurring Req. Worksheet
  - Order Planning
  - Production Forecasts
  - Purchase Orders
  - Sales Orders
  - Blanket Sales Orders
  - Planned Production Orders
  - Firm Planned Prod. Orders
  - Transfer Orders
- Reports
- Documents
- Setup
- Order Processing
- Inventory & Costing
- Analysis & Reporting
- History
- Setup

1000 Bicycle - Production BOM

General

No. 1000 Search Name BICYCLE

Description Bicycle Version Nos.

Unit of Measure Code PCS Active Version.

Status Certified Last Date Modified 11.12.10

Type	No.	Description	Quantity	Unit of Measu...	Scrap...	Routing Li...
Item	1100	Front Wheel	1	PCS	0	
Item	1200	Back Wheel	1	PCS	0	
Item	1300	Chain Assy	1	PCS	0	
Item	1400	Mudguard front	1	PCS	0	
Item	1450	Mudguard back	1	PCS	0	
Item	1500	Lamp	1	PCS	0	
Item	1600	Bell	1	PCS	0	
Item	1700	Brake	1	PCS	0	
Item	1800	Handlebars	1	PCS	0	
Item	1850	Saddle	1	PCS	0	
Item	1900	Frame	1	PCS	0	

Prod. BOM Component Functions Help

Bill of material

# MS Dynamics 365 Business Central

**CRONUS International Ltd.** | Finance | Journals | Cash Management | Cost Accounting | Fixed Assets | Posted Documents | Setup & Extensions

Chart of Accounts | Bank Accounts | Customers | Vendors | Purchase Orders | Incoming Documents | Purchase Invoices | EC Sales List | VAT Returns | Budgets | VAT Statements | Intrastat

Account No.	Name	Balance
2910	Cash	199.01
2920	Bank, LCY	2,846.54
2930	Bank Currencies	3,958.03
2940	Giro Account	249,241.29
5310	Revolving Credit	-1,383,297.64

**Cash Flow Forecast**

CF100001 | Combined | Working Date | Month | Source Type (Updated: 3:18:32 PM)

- Payables
- Cash Flow Manual Revenue
- Liquid Funds
- Sales Orders
- Cash Flow Manual Expense
- Tax
- Total

**Report Inbox**

Created Date-Time	Description	Output Type
(There is nothing to show in this view)		

# Function block Logistic-simplified

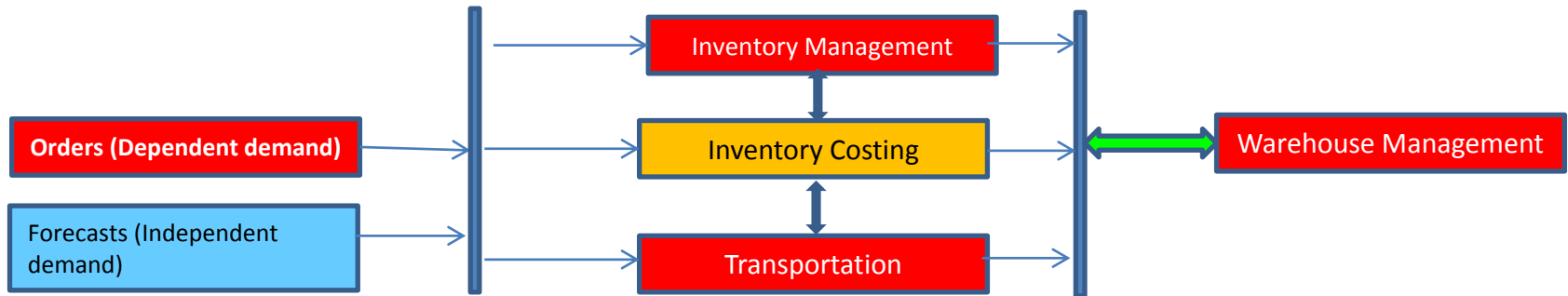

Will be part of our course regarding ERP system MS Dynamics NAV

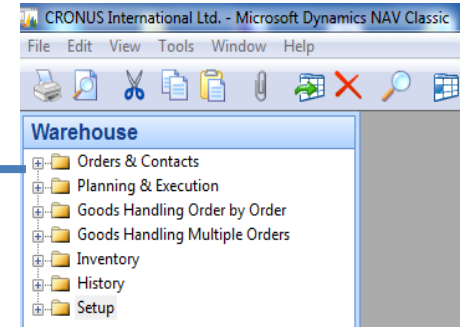
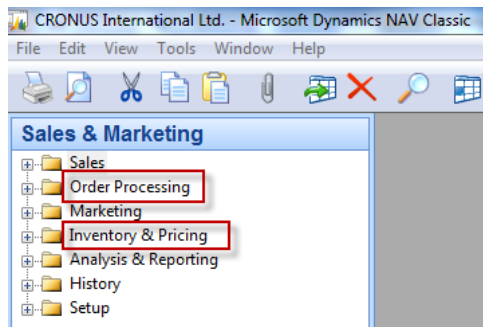

# Procedures-simplified (feedback control)

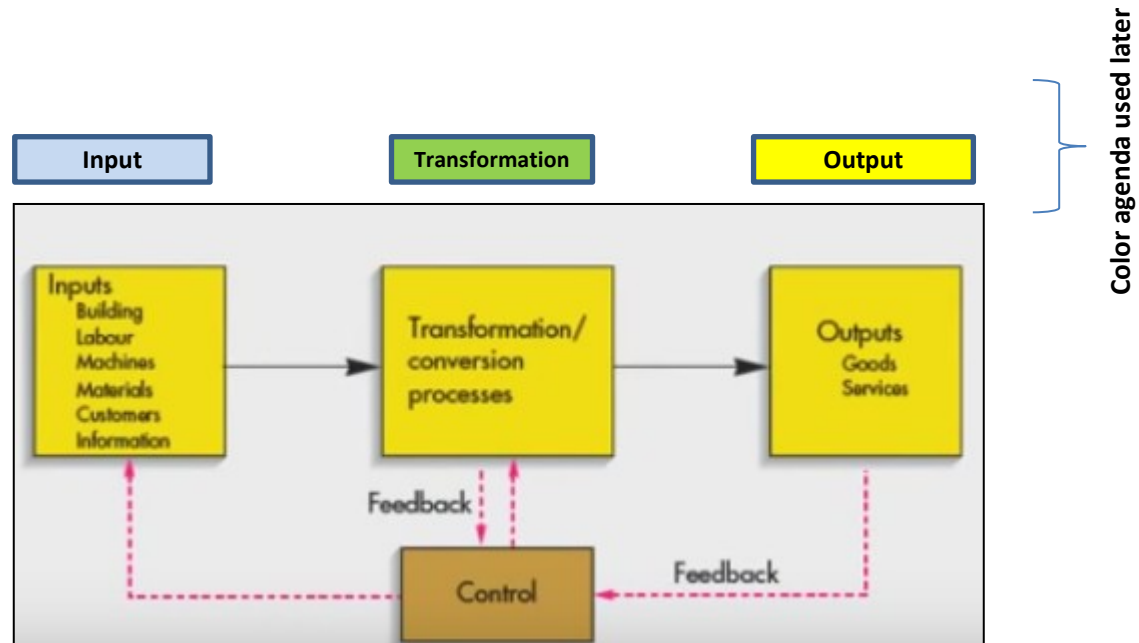

# Processing

(not organised set of processes, will be presented also as a introduction to project management PWP presentation later)



Process flow ?





# Your main task (to organize processes based on business logic)

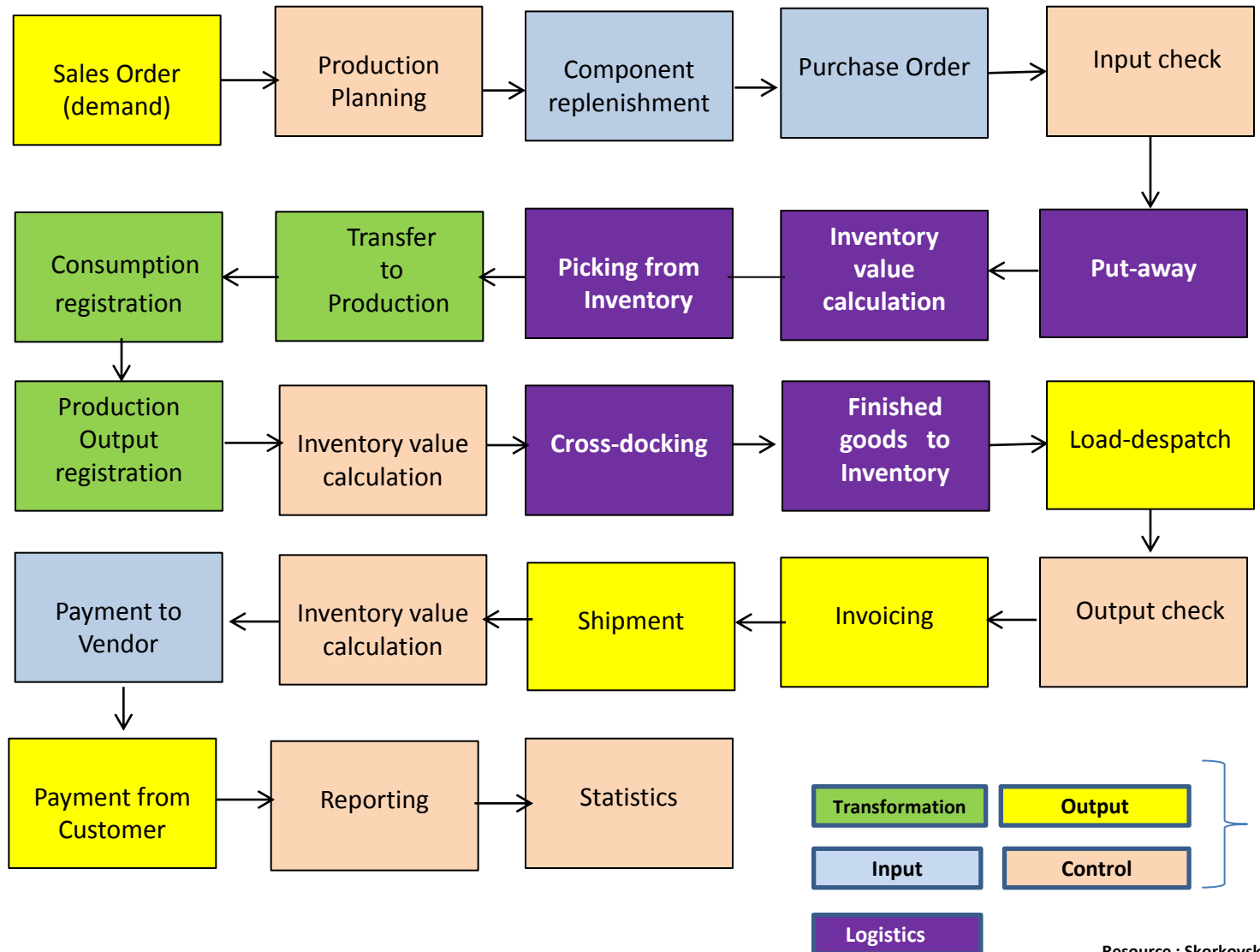

# Your main task (possible problems, bottlenecks, undesirable effects..)

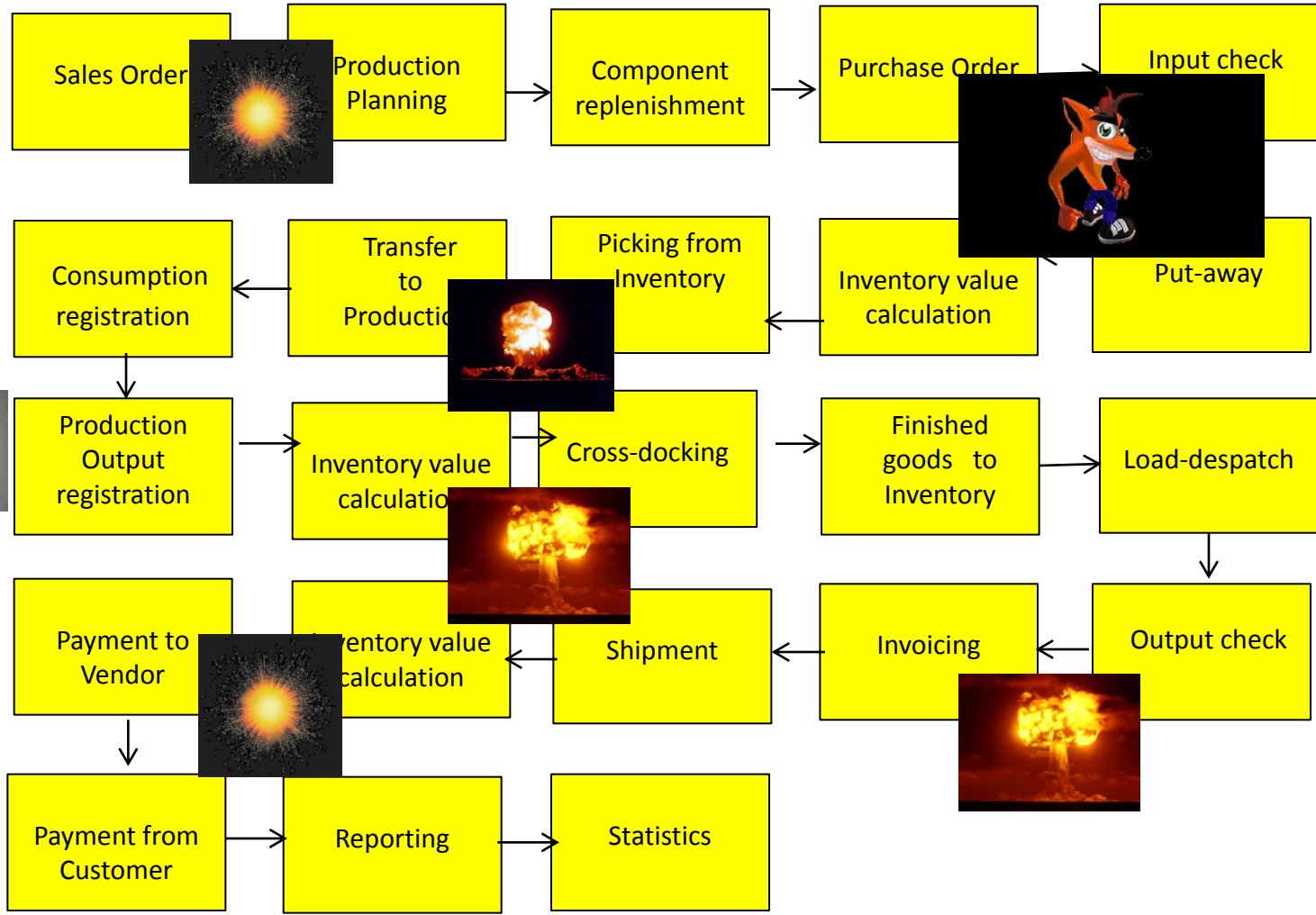

Priorities ?

Application of TOC ->thinking tools->Current Reality Tree – first stage

# Your main task

(Search - **HOW** ??? Measure impacts -**HOW** ??? and Destroy - **HOW** ???)

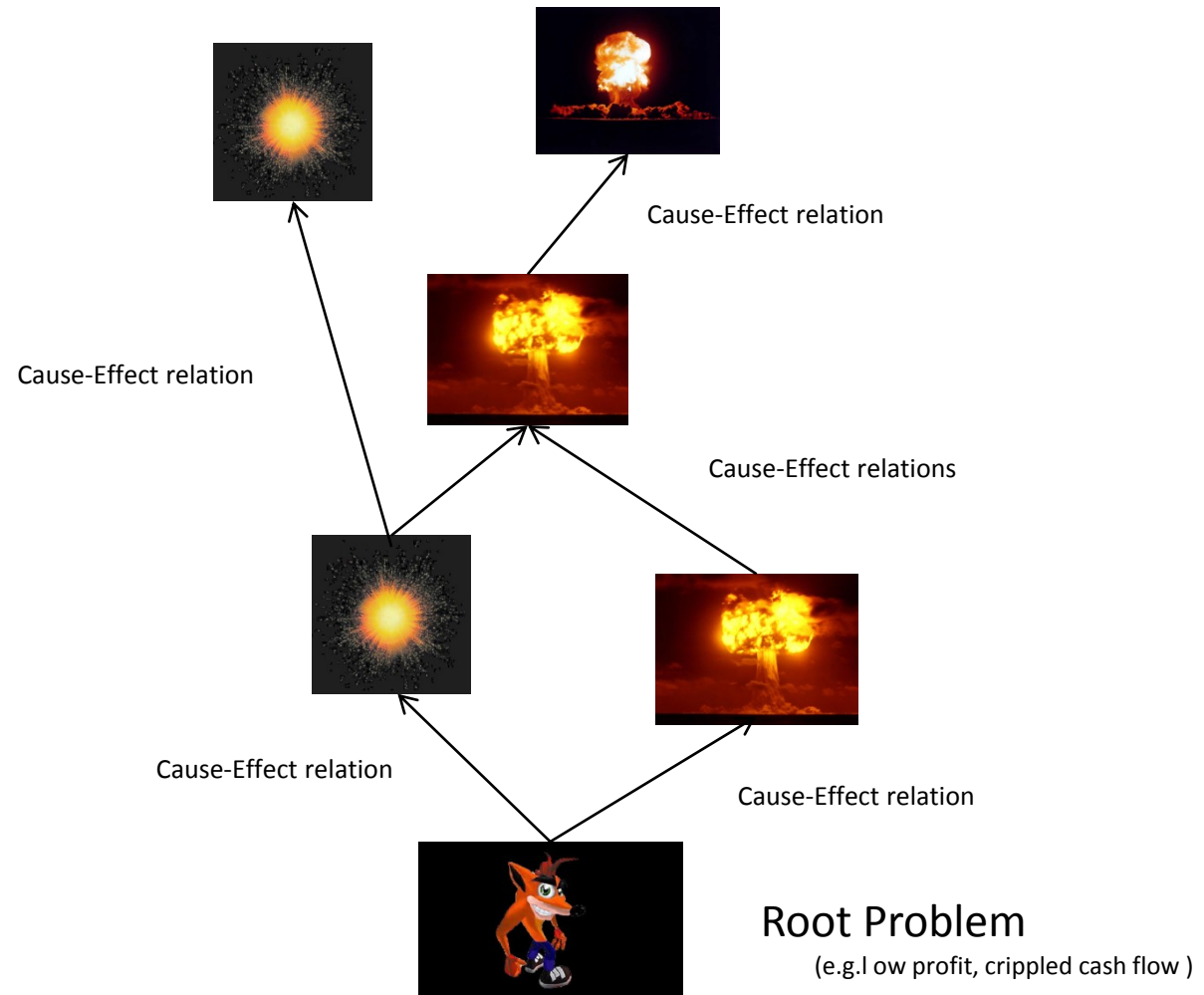

# Basic problem I. (one of many)

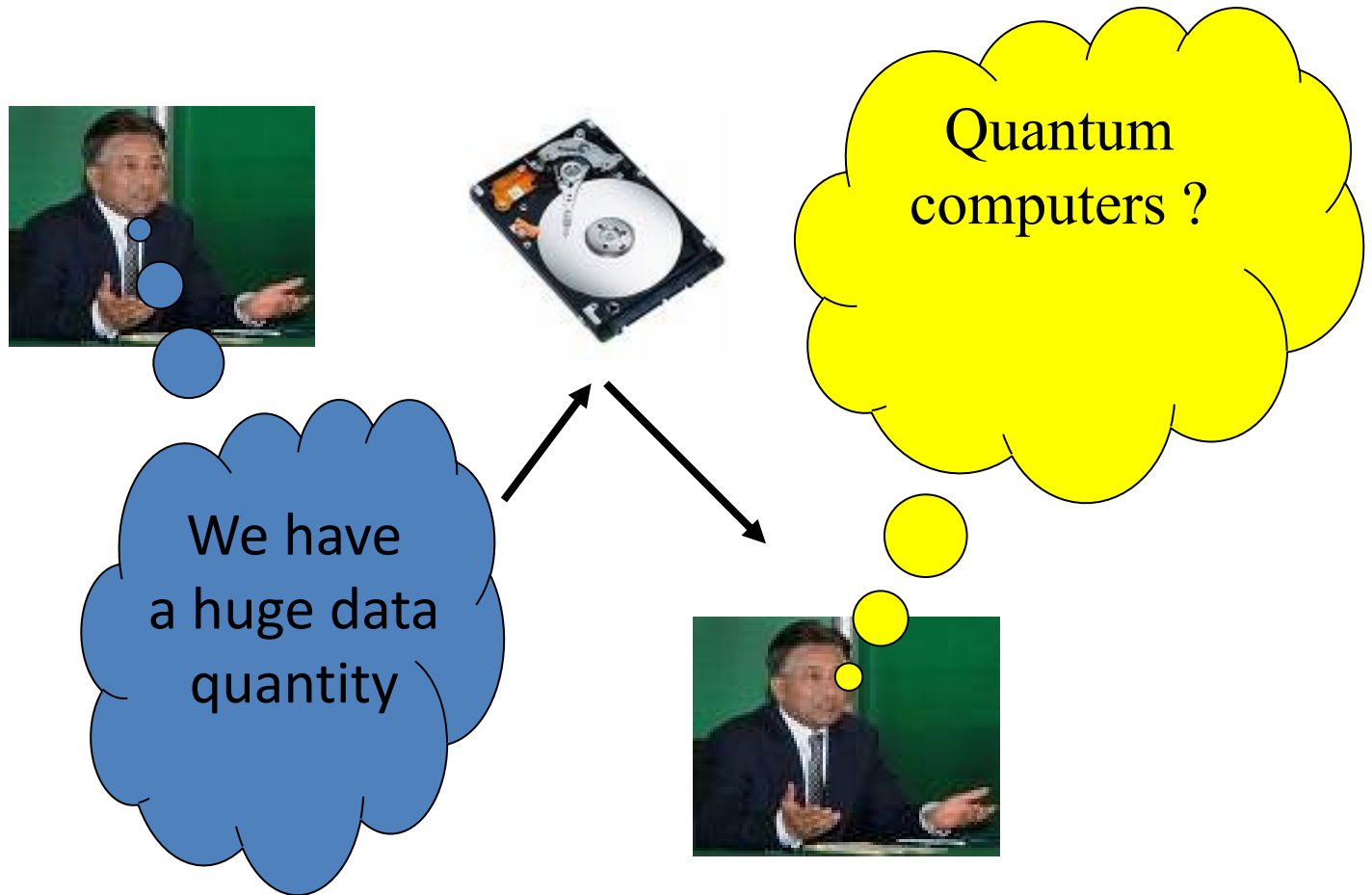

**Moore's law** is the observation that the number of transistors in a dense integrated circuits doubles approximately every two years – so -> capacity of memory is going up -> applications (SW) temporarily solve such a constraint and it is still valid after more than 50 Years !!!

# Big data and analysis problem

In test and measurement applications, engineers and scientists can collect vast amounts of data every second of every day.

- For **every second** that the Large Hadron Collider at **CERN** runs an experiment, the instrument can generate **40 terabytes** of data.
- For **every 30 minutes** that a Boeing jet engine runs, the system creates 10 terabytes of operations information.
- For a single journey across the Atlantic Ocean, a four-engine jumbo jet can create **640** terabytes of data.
- Multiply that by the more than 25,000 flights flown each day, and you get an understanding of the enormous amount of data that exists (Rogers, 2011). **That's "Big Data."**

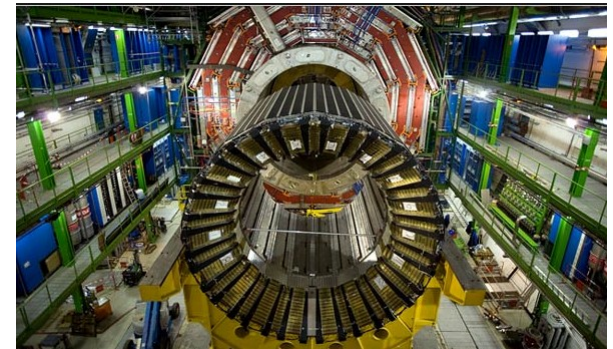

Hardon Collider-accelerator

# \* Basic problem II. (we need reliable data )

To solve it we should use Finite capacity scheduling (APS)- will be presented later

Gantt

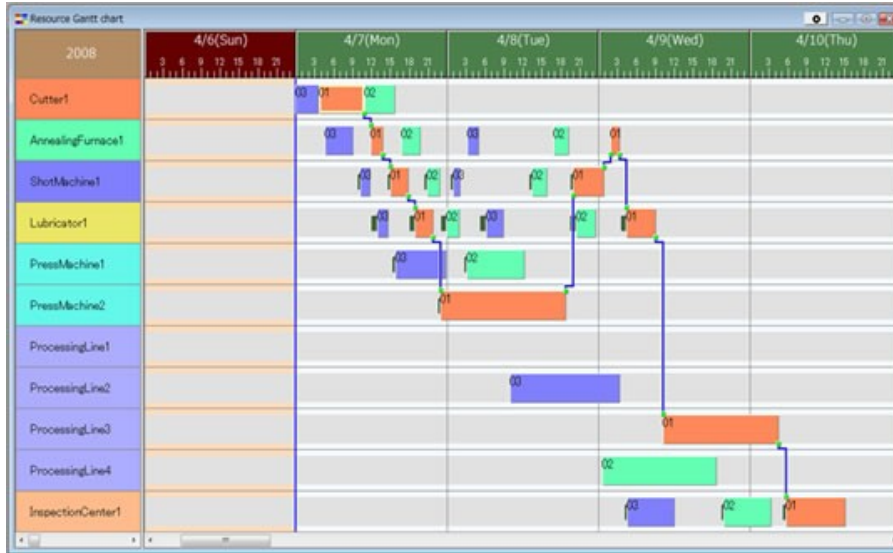

$$T1+T2=X$$

$$Opt=Min(X)$$

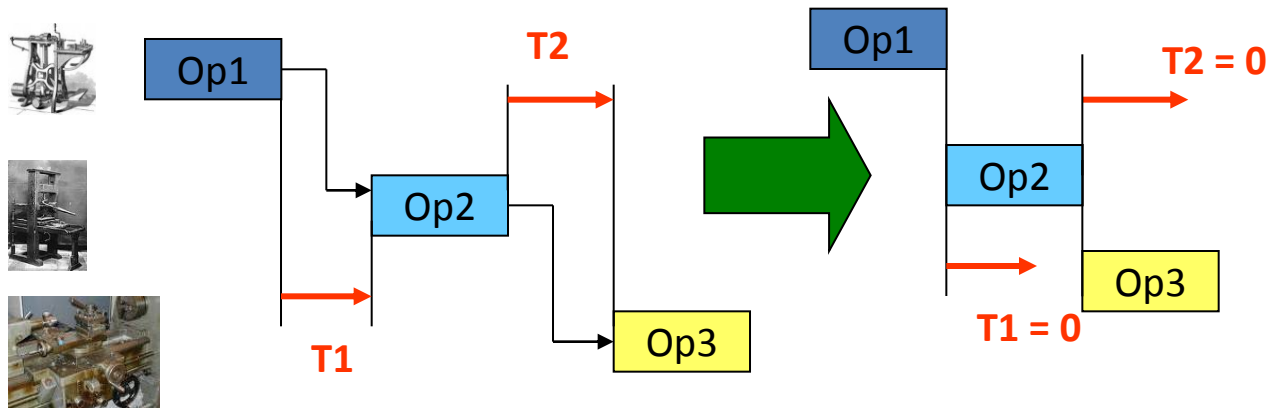

# Basic problem III.

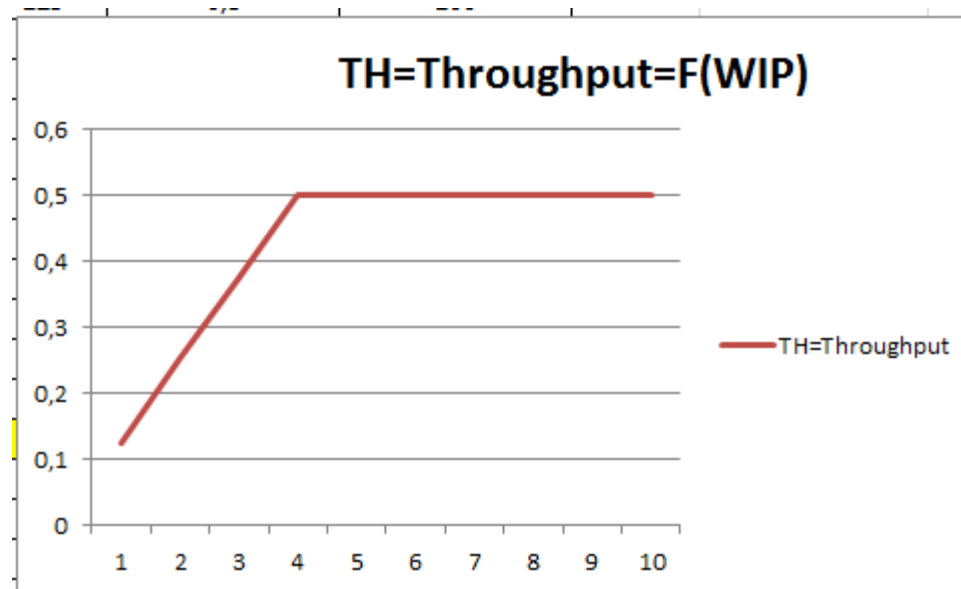

Will be explained in Little's law presentation (AOPR) : **WIP**= **W**ork **I**n **P**rogress

# Basic problem- colouring IV.

**Black**

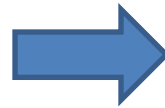

White



White

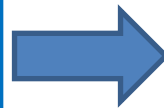

**Black**



**(Black ->White, Setup time=60 minut)**

**(White->Black, Setup time = 20 minut)**

Main aim ->setup time minimization



# Basic problem V-I. (availability of components)

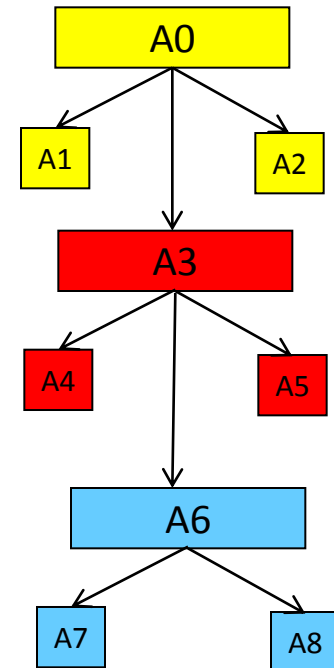
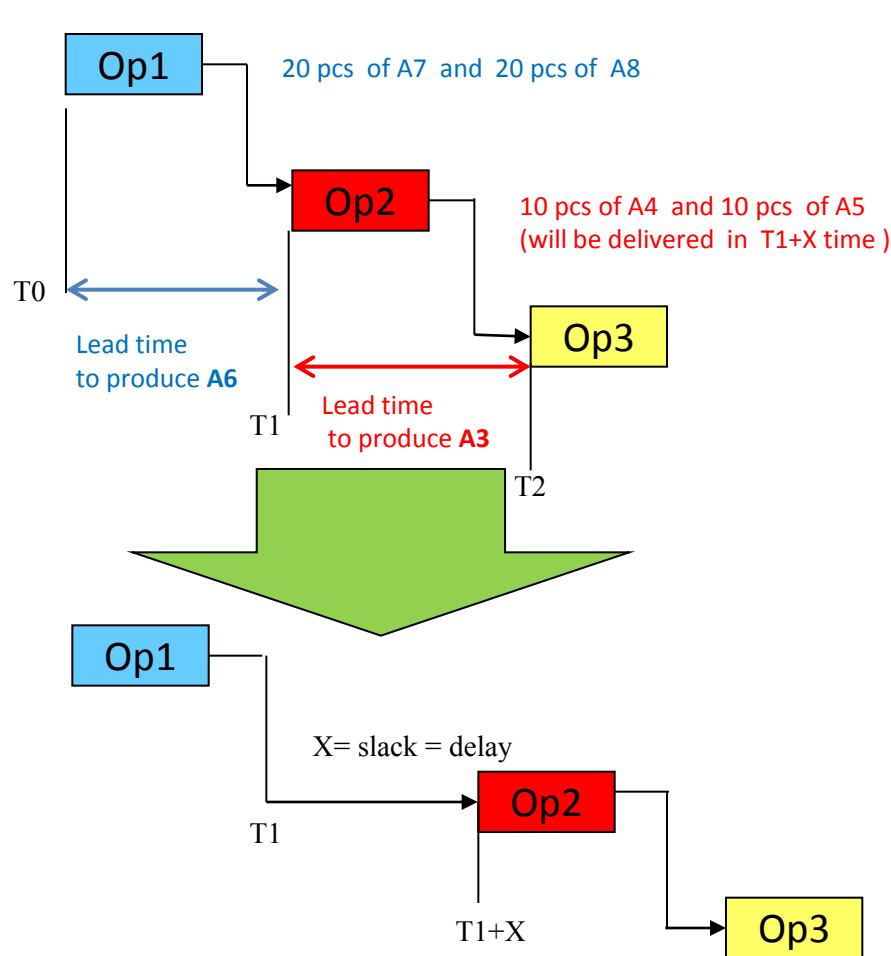

Bill Of Material=BOM (tree structure)

For sake of simplicity we did not mention components **A1** and **A2** and possible delays having cause in delivery times of bad quality !!!  
 Same with capacities of machines allocated to OP1-OP2-OP3 ( due to unexpected sudden breakdowns)

# Basic problem V-II. (availability of components and capacity )

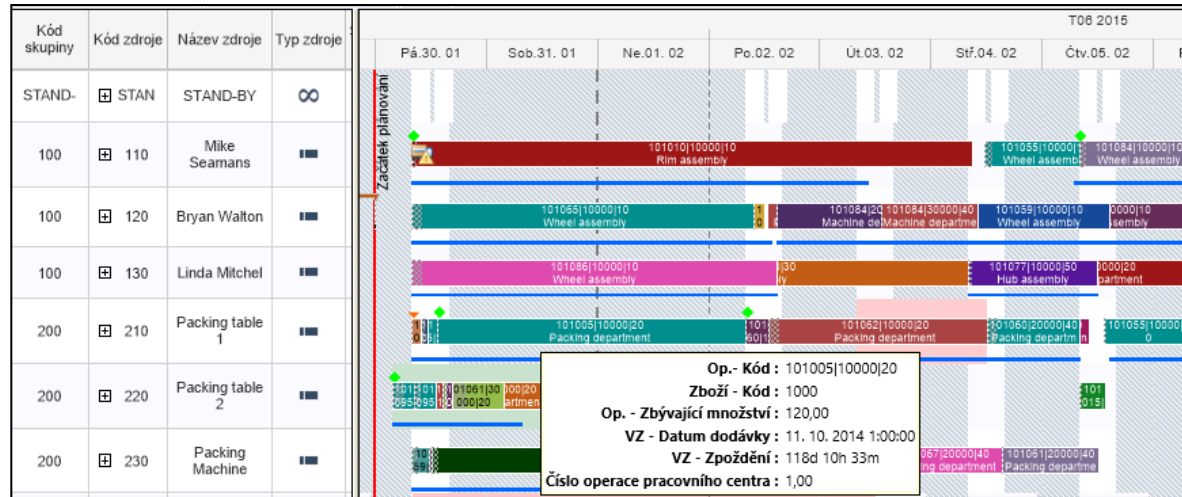

Gantt chart

Operati... No.	Type	No.	Description	Starting Date-Time	Ending Date-Time	Setup Time	Run Time	Material Fixed Date
10	Work Center	100	Wheel assembly	18. 8. 2014 14:41	22. 8. 2014 8:31	110	12	23. 8. 2014 0:00
20	Work Center	200	Packing department	27. 8. 2014 8:31	1. 9. 2014 14:46	15	15	10. 9. 2014 0:00
30	Work Center	300	Painting department	1. 9. 2014 14:46	4. 9. 2014 10:46	10	20	
40	Work Center	400	Machine department	4. 9. 2014 11:11	5. 9. 2014 12:21	10	8	

APS result ->18.8.->23.8. a 27.8.->10.9

APS = Advanced Planning and Scheduling result

# Basic problem VI-I. (budget exceeded)

2012 - Budget

General Filters Options

Budget Name . . . . . 2012 ↑

Show as Lines . . . . . G/L Account ↑

Show as Columns . . . . . Period ↑

Code	Name	Budgeted Amount	26.03.12	02.04.12
<b>8100</b>	<b>Building Maintenance Expenses</b>			
▶ 8110	Cleaning	1 160,00	1 000,00	
8120	Electricity and Heating	1 120,00	1 000,00	
8130	Repairs and Maintenance	1 160,00	1 000,00	
<b>8190</b>	<b>Total Bldg. Maint. Expenses</b>	<b>3 440,00</b>	<b>3 000,00</b>	
<b>8200</b>	<b>Administrative Expenses</b>			
8210	Office Supplies	510,00	500,00	
8230	Phone and Fax	800,00	800,00	
8240	Postage	1 390,00	1 200,00	
<b>8290</b>	<b>Total Administrative Expenses</b>	<b>2 700,00</b>	<b>2 500,00</b>	
<b>8300</b>	<b>Computer Expenses</b>			
8310	Software	1 000,00	1 000,00	

1 7 31 3 12 ⋮ ⏪ ⏩ Balance Functions Help

# \* Basic problem VI-II. (budget exceeded)

1015 London Postmaster - **Purchase Invoice** Creation of the actual costs figures

General Invoicing Shipping Foreign Trade E-Commerce

No. . . . . 1015

Buy-from Vendor No. . . . . 10000

Buy-from Contact No. . . . . CT000066

Buy-from Vendor Name . . . . . London Postmaster

Buy-from Address . . . . . 10 North Lake Avenue

Buy-from Address 2 . . . . .

Buy-from Post Code/City N12 5XY  London

Buy-from Contact . . . . . Mrs. Carol Philips

Posting Date . . . . . 26.03.12

Document Date . . . . . 26.03.12

Vendor Invoice No. . . . . Miki-0983

Order Address Code. . . . .

Purchaser Code . . . . . RL

Campaign No. . . . .

Responsibility Center . . . . . LONDON

Assigned User ID . . . . .

Status . . . . . Open

Type	No.	Description	Location Code	Quantity	Unit of Measure ...	Direct Unit Cost Excl...	Line Amount Excl. VAT	Line Disco...	Qty. to Assign
G/L Ac...	8110	Cleaning		10	HOUR	100,00	1 000,00		
G/L Ac...	8120	Electricity and Heating		20	HOUR	200,00	4 000,00		
G/L Ac...	8130	Repairs and Maintenance		30	HOUR	300,00	9 000,00		
G/L Ac...	8210	Office Supplies		10	HOUR	100,00	1 000,00		
G/L Ac...	8230	Phone and Fax		20	HOUR	200,00	4 000,00		
▶ G/L Ac...	8240	Postage		30	HOUR	300,00	9 000,00		

Invoice Line Functions Posting Help

# \* Basic problem VI-III. (budget exceeded)

G/L Balance/Budget

Options

Date Filter . . . . . 01.03.12..31.03.12      Budget Filter . . . . . 2012

Department Filter . . . . .      Closing Entries . . . . . Include

Project Filter . . . . .

No.	Name	I...	Debit Amount	Credit Amount	Balance/Budget (%)	Budgeted Debit Amount	Budge... Credit Amount	Budgeted Amount
	<b>8100 Building Maintenance Expenses</b>	<b>L...</b>						
▶	8110 Cleaning	I...	1 000,00		100,0	1 000,00		1 000,00
	8120 Electricity and Heating	I...	4 000,00		400,0	1 000,00		1 000,00
	8130 Repairs and Maintenance	I...	9 000,00		900,0	1 000,00		1 000,00
	<b>8190 Total Bldg. Maint. Expenses</b>	<b>L...</b>	<b>14 000,00</b>		<b>466,7</b>	<b>3 000,00</b>		<b>3 000,00</b>
	<b>8200 Administrative Expenses</b>	<b>L...</b>						
	8210 Office Supplies	I...	1 000,00		200,0	500,00		500,00
	8230 Phone and Fax	I...	4 000,00		500,0	800,00		800,00
	8240 Postage	I...	9 000,00		750,0	1 200,00		1 200,00
	<b>8290 Total Administrative Expenses</b>	<b>L...</b>	<b>14 000,00</b>		<b>560,0</b>	<b>2 500,00</b>		<b>2 500,00</b>
	<b>8300 Computer Expenses</b>	<b>L...</b>						
	8310 Software	I...				1 000,00		1 000,00

1 7 31 3 12    Account    Functions    Help