



Komunikační modely

MAKK Marketingová komunikace

MUNI
ECON

- O učitelích
- Seminárka, máme?

Komunikace

- K čemu slouží?

Komunikace

- K čemu slouží?
- Jak ji znázorňujeme?

Komunikace

- K čemu slouží?
- Jak ji znázorňujeme?
- Proč by nás to mělo zajímat?

Komunikace

- K čemu slouží?
- Jak ji znázorňujeme?
- Proč by nás to mělo zajímat?
- Jaké problémy mohou nastat?

Model = zjednodušení

- Popisuje vztahy

A general Model of the Communication Process for Promotions

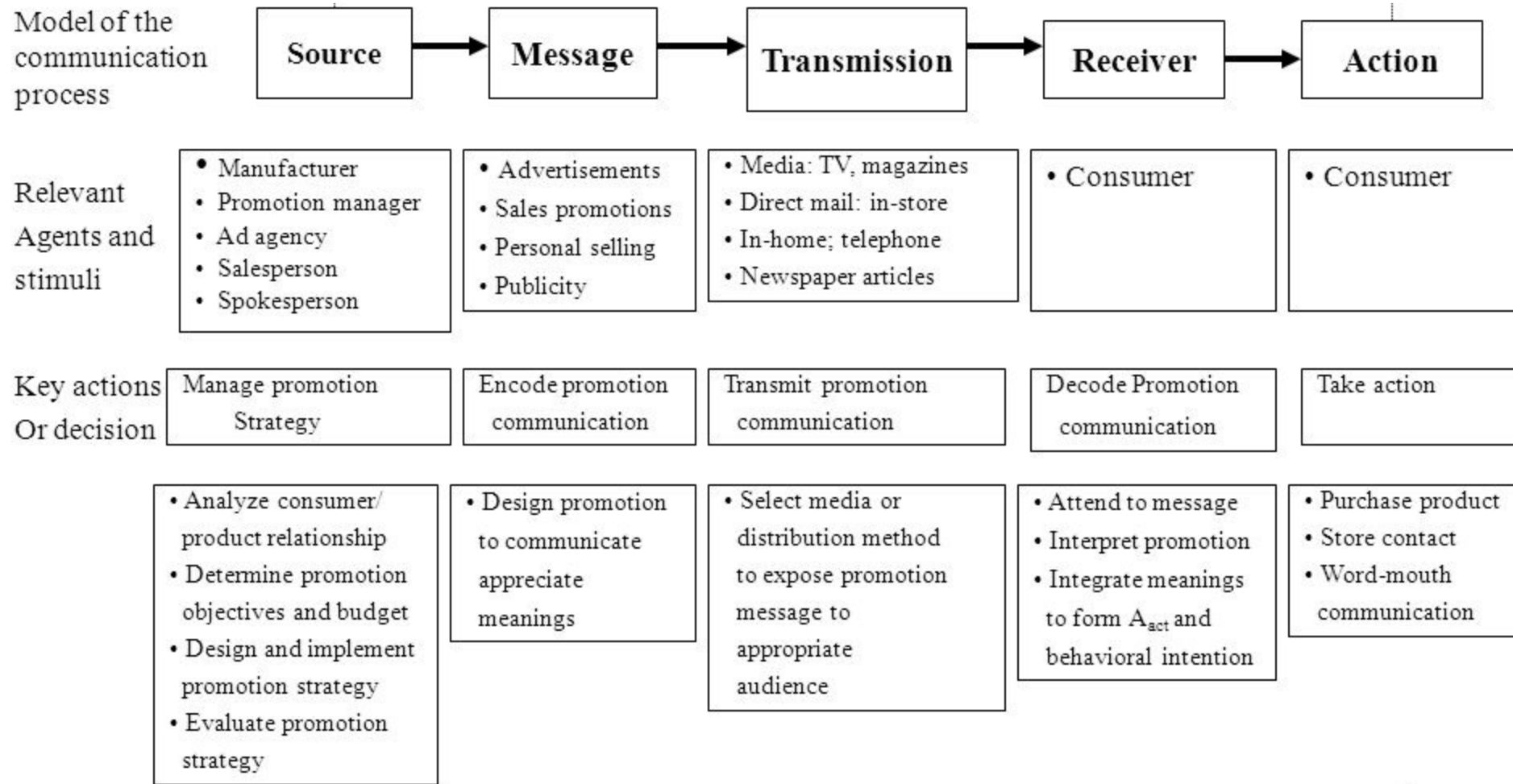

A general Model of the Communication Process for Promotions

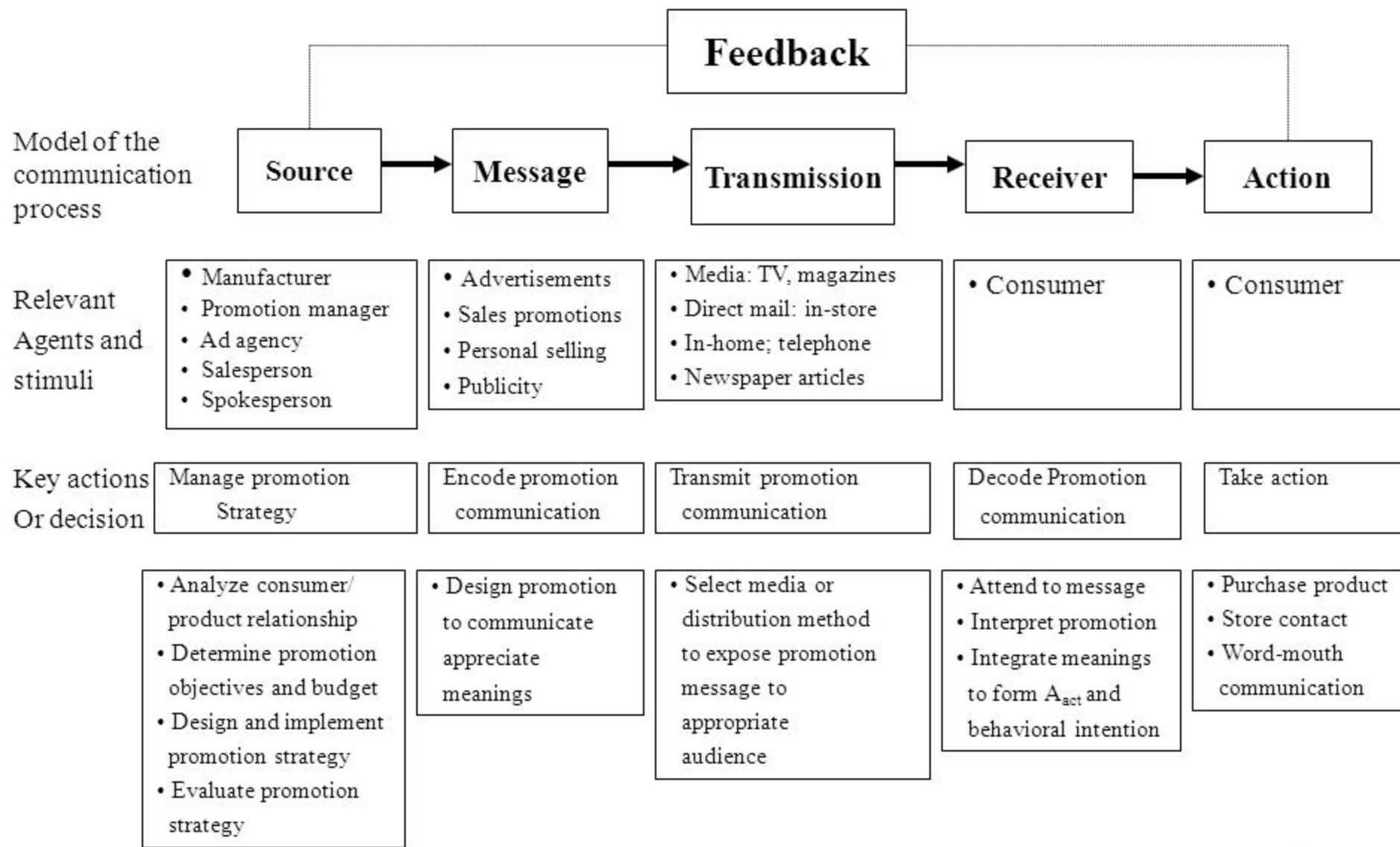

A general Model of the Communication Process for Promotions

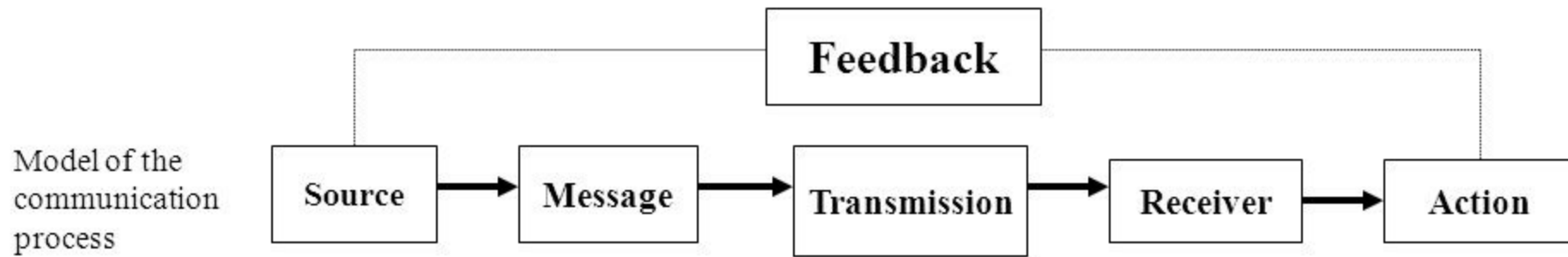

Relevant Agents and stimuli

- M
- P
- A
- S
- S

Key actions Or decision

Man



- Anal
- prod
- Det
- obje
- Desi
- prom
- Eval
- strat

er

n

product

act

th

ation

A general Model of the Communication Process for Promotions



Relevant Agents and stimuli

- M
- P
- A
- S
- S

Key actions Or decision

Man

• Anal
prod

• Det
obje

• Desi
prom

• Eval
strat

er

n

product
act
th
ation

Source: Adapted from Figure 8.1 in Henry Assael, *Consumer Behavior and Marketing Action*, 3rd ed.

Lasswellův model komunikace

LASSWELL MODEL OF COMMUNICATION

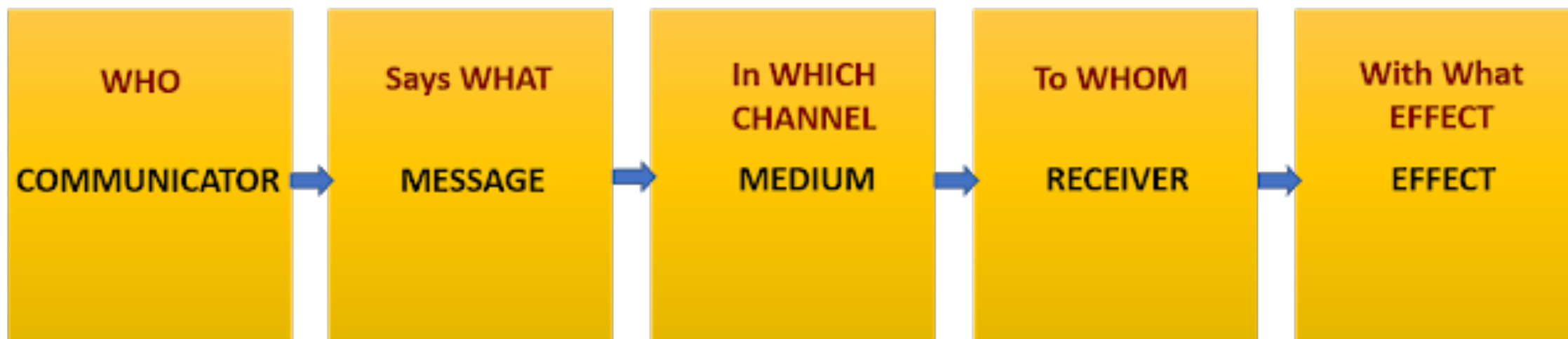

Lasswellův model komunikace (1948)

LASSWELL MODEL OF COMMUNICATION

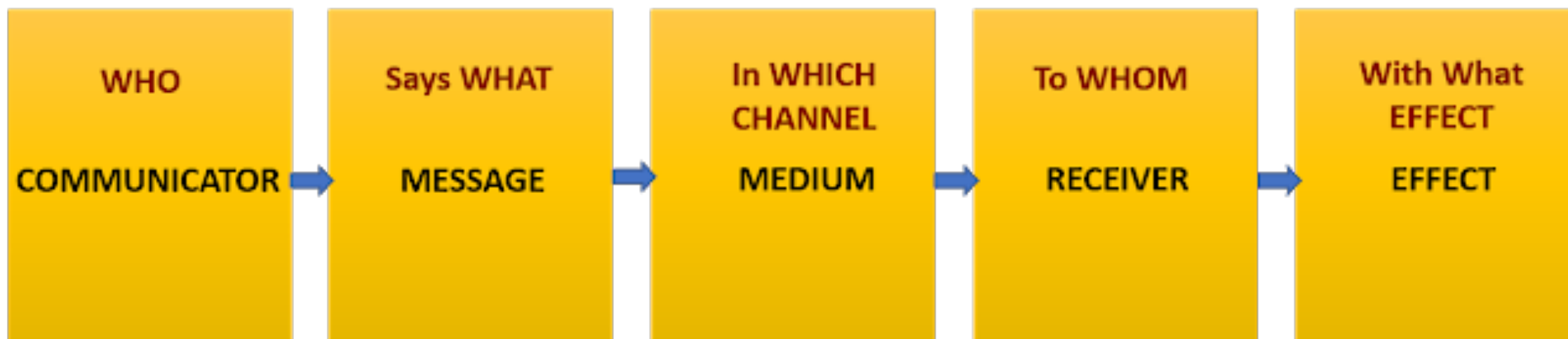

Lasswellův model komunikace

- Lineární = bez zpětné vazby (částečně díky Efektu)
- Přenosový (nese něco někam – informaci adresátovi)

LASSWELL MODEL OF COMMUNICATION

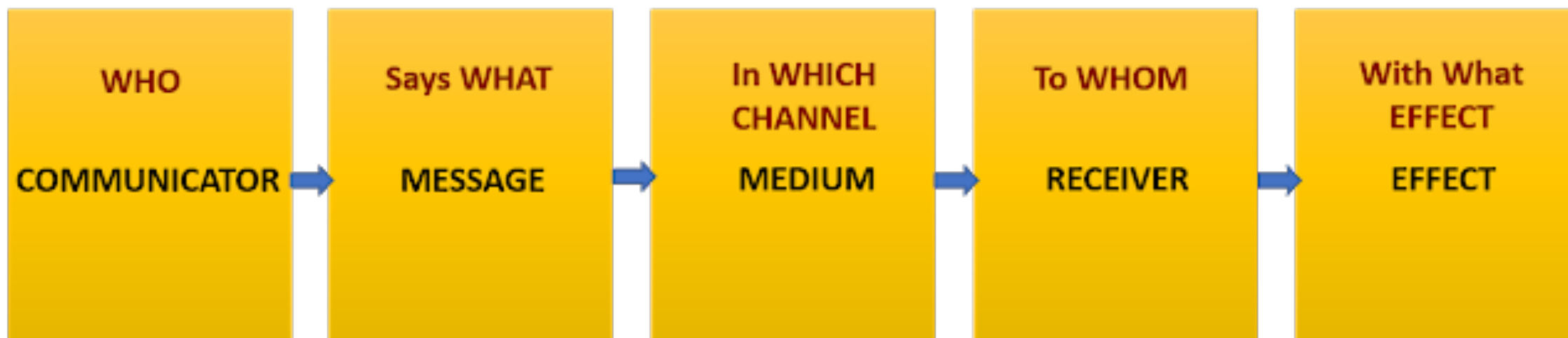

Shannon-Weaver model (1948)

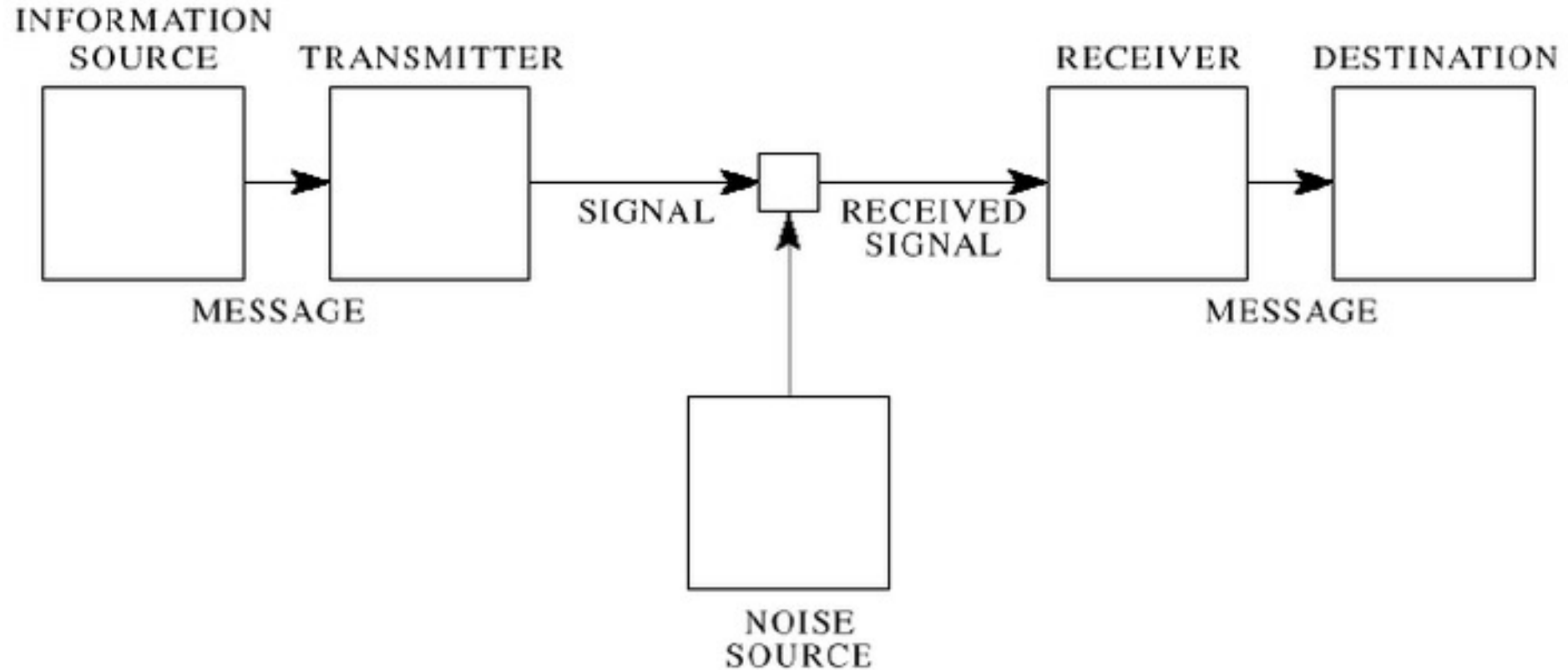

Claude Shannon

- Pracoval pro Bell Telephones, za úkol měl zlepšit kvalitu hovorů.
- Hospoda jako model – není moc slyšet
- Fyzický hluk – slabý signál, pták na drátě, ...

Claude Shannon

- Pracoval pro Bell Telephones, za úkol měl zlepšit kvalitu hovorů.
- Hospoda jako model – není moc slyšet
- Fyzický hluk – slabý signál, pták na drátě, ...



(Cocktail party effect)



Shannon-Weaver model

- Nejen technický problém, i o mezilidské komunikaci
- Weaver model upravil pro běžné smrtelníky

Shannon-Weaver model

- Nejen technický problém, i o mezilidské komunikaci
- Weaver model upravil pro běžné smrtelníky

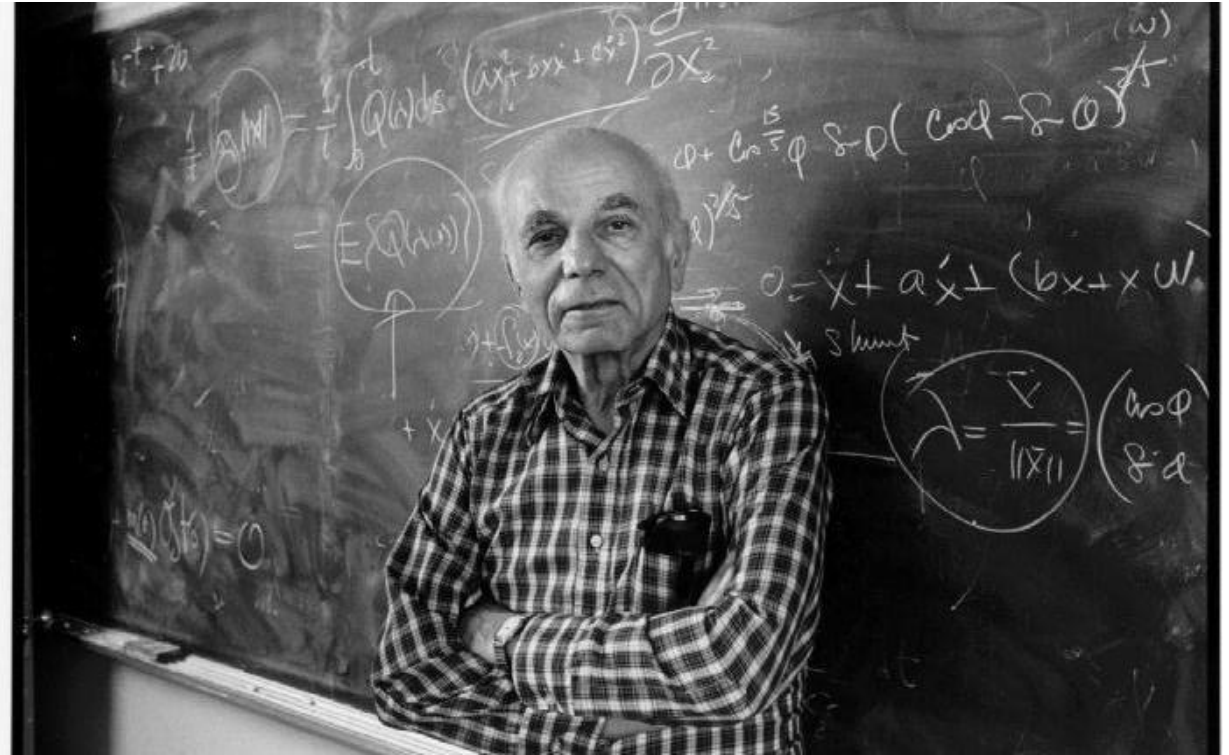

Schrammova extenze Shannon-Weaver modelu

- Sémantický šum
- Nejen “slyším?” ale i “chápu?”

Schrammova extenze Shannon-Weaver modelu

- Sémantický šum
- Nejen “slyším?” ale i “chápu?”

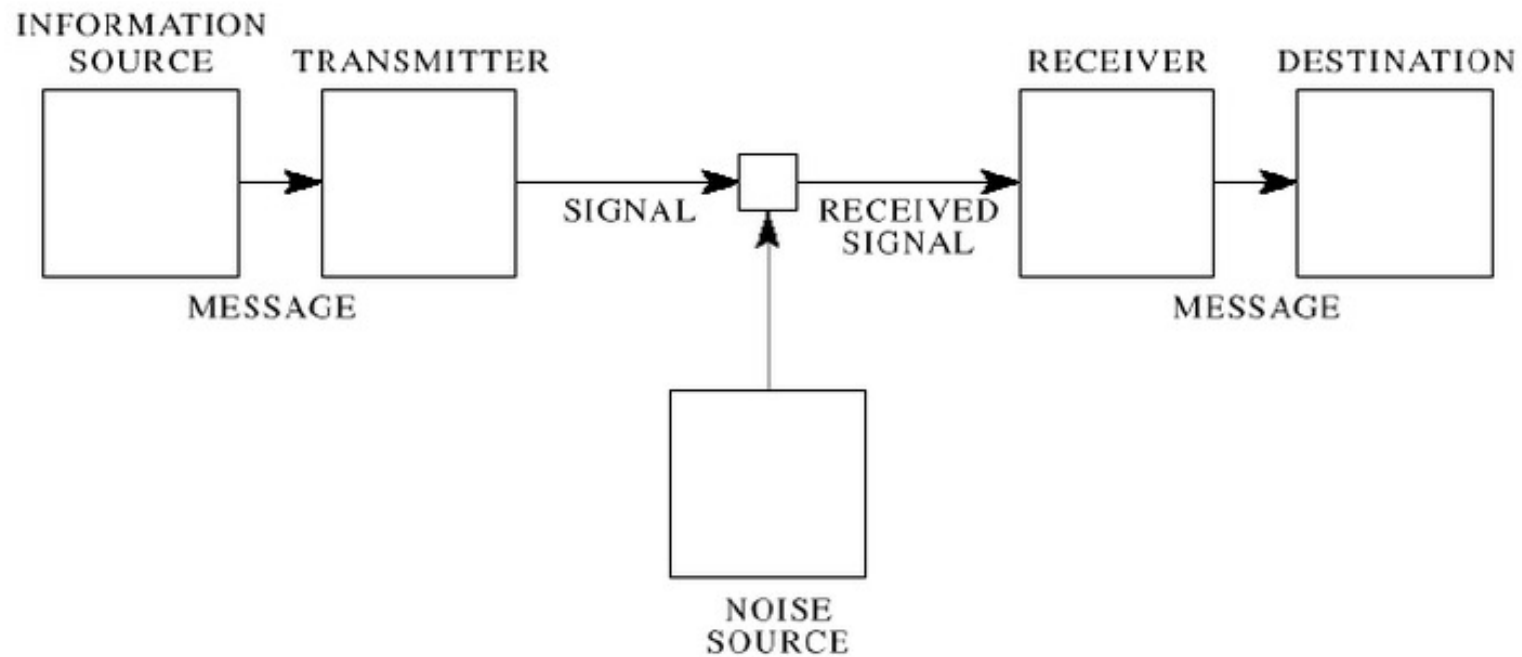

Schrammova extenze Shannon-Weaver modelu

- Sémantický šum
- Nejen “slyším?” ale i “chápu?”

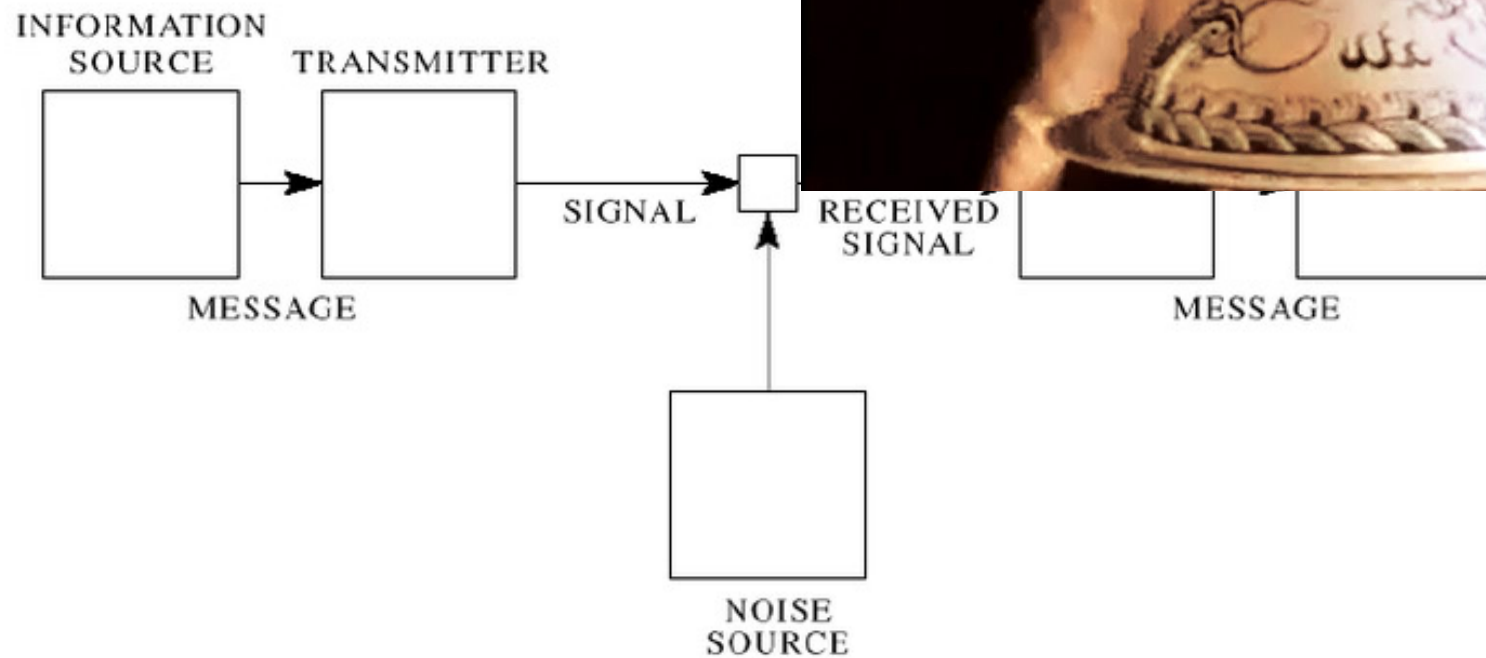

S-W model + Feedback (Norbert Wiener)

- Matematik (další)
- Bombardéry:
 - Zaměř
 - Sleduj
 - Uprav
 - Sestřel
- Feedback loop

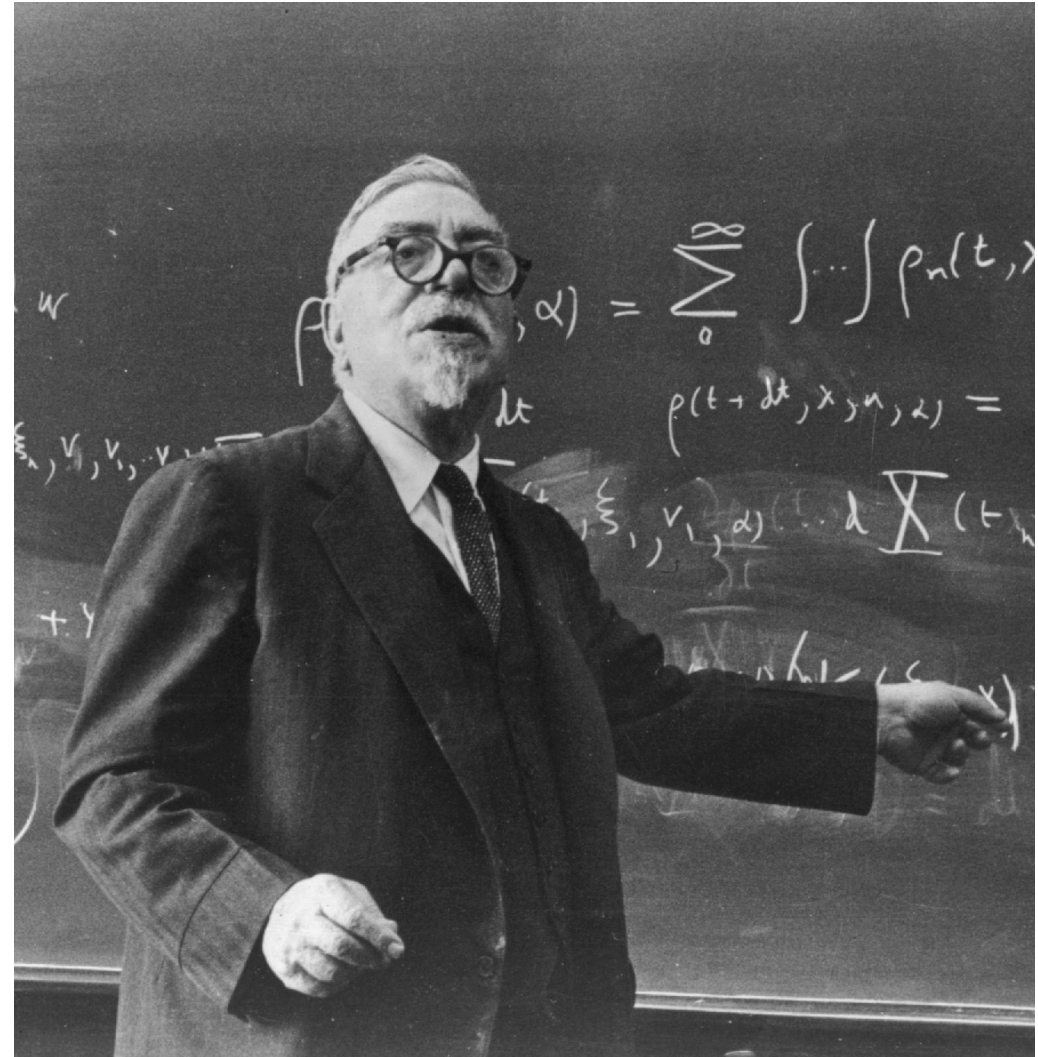

S-W model + Feedback (Norbert Wiener)

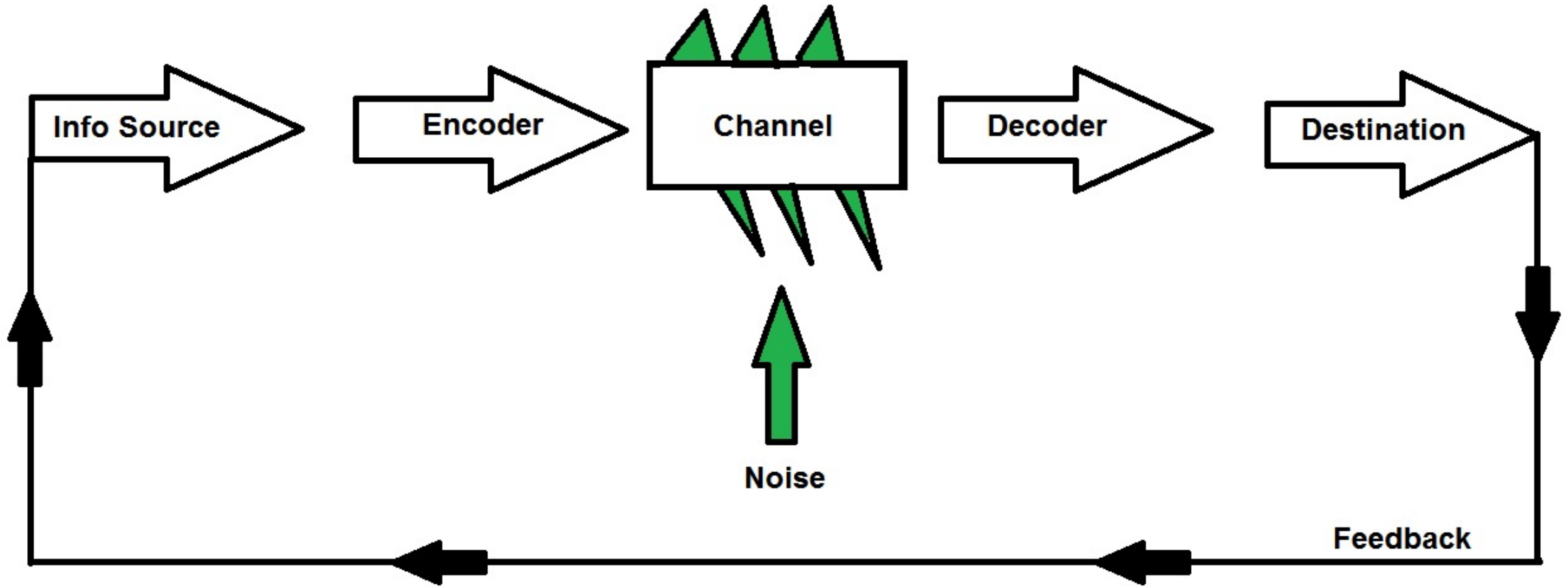

Kritika přenosových modelů

- Jednosměrné, mechanistické
- Ignorují obsah sdělení
- Definují komunikační akt jako persuzivní událost
- Počítají s tím, že příjemce absorbuje sdělení beze změny
- Ignorují kontext (kulturní atd), vztahy účastníků, vliv kanálů

J'aime cette école.
J'ai faim.

Schramm: pole zkušenosti

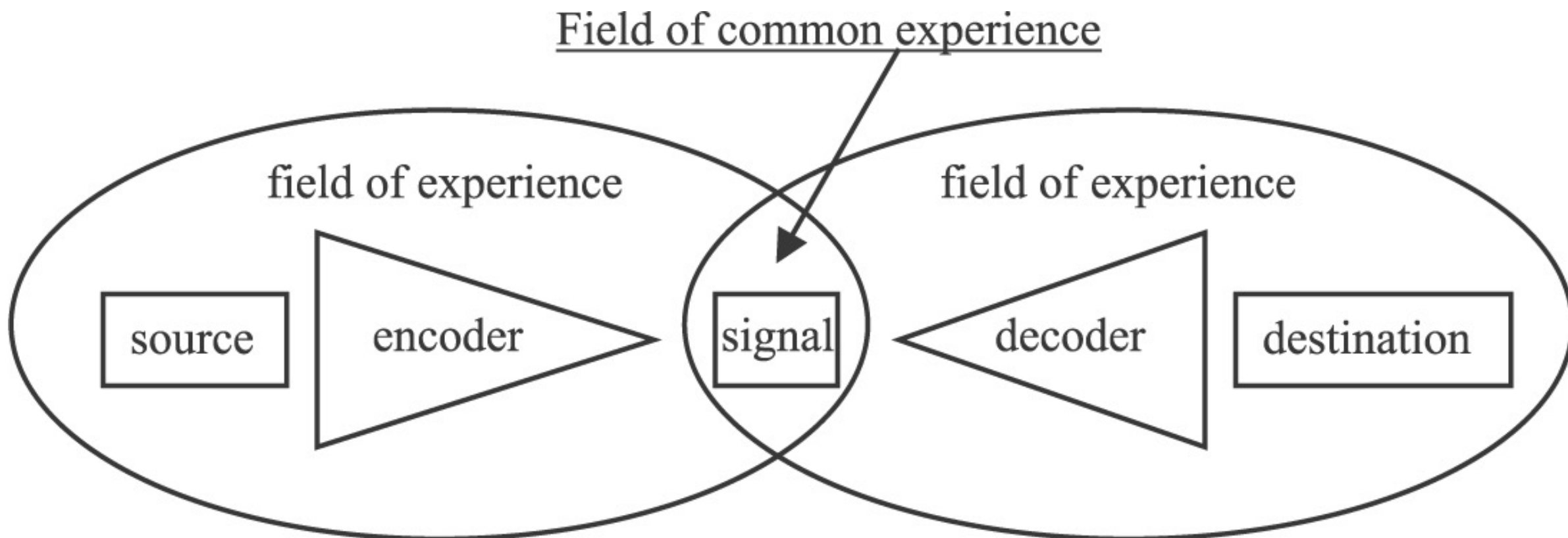

Schramm: pole zkušenosti

- Pokud chci mluvit s cílovkou plynule, musím brát do úvahy jejich zkušenosti, návyky, kulturu, jazyk, ...

Sdílené pole zkušenosti

CREATIVE

ZEN MOZAIC 16GB MP3 PLAYER

- Up to 32-Hours Audio, 5-Hours Video Playback
- 1.8" TFT Display, Built-In Speaker
- FM Radio with 32 Presets
- 8 EQ Settings, Volume Restriction Control



\$129⁹⁹ - 50 = \$79⁹⁹

Regular Price Instant Savings After Instant Savings

#5776582



iPod.
1,000 songs in your pocket.

Berloův model S-M-C-R

- Psycholog, teoretik komunikace



Berloův model S-M-C-R

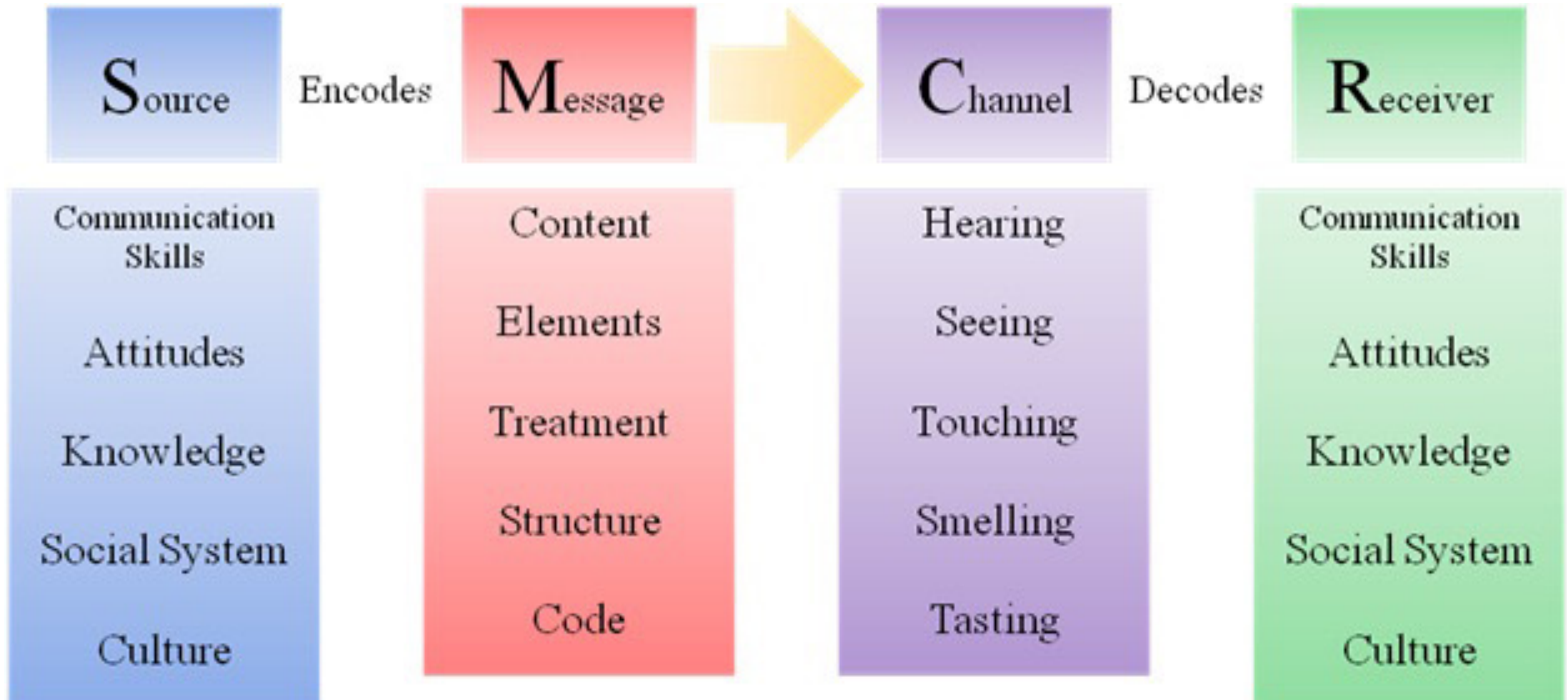

Berlo's model S-M-C-R

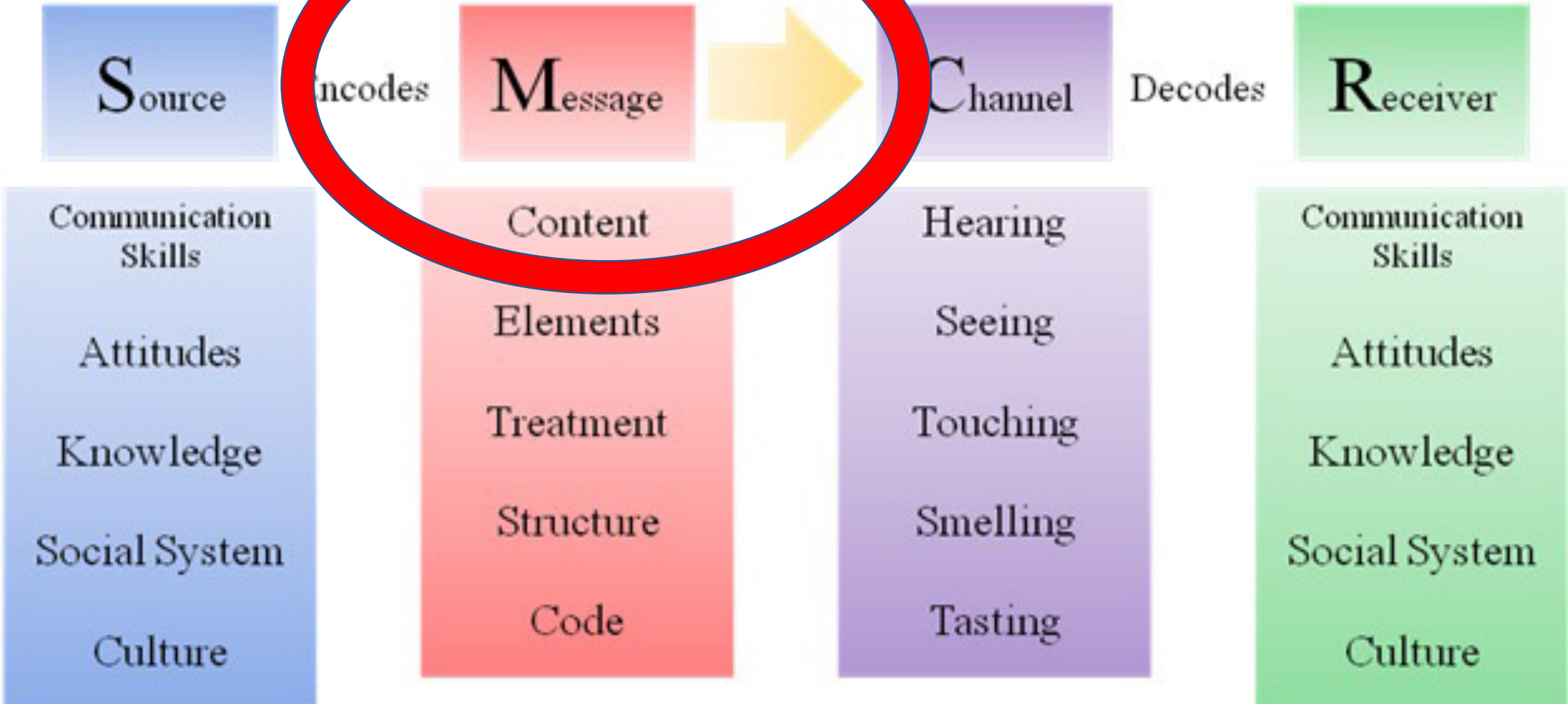

Berloův model S-M-C-R

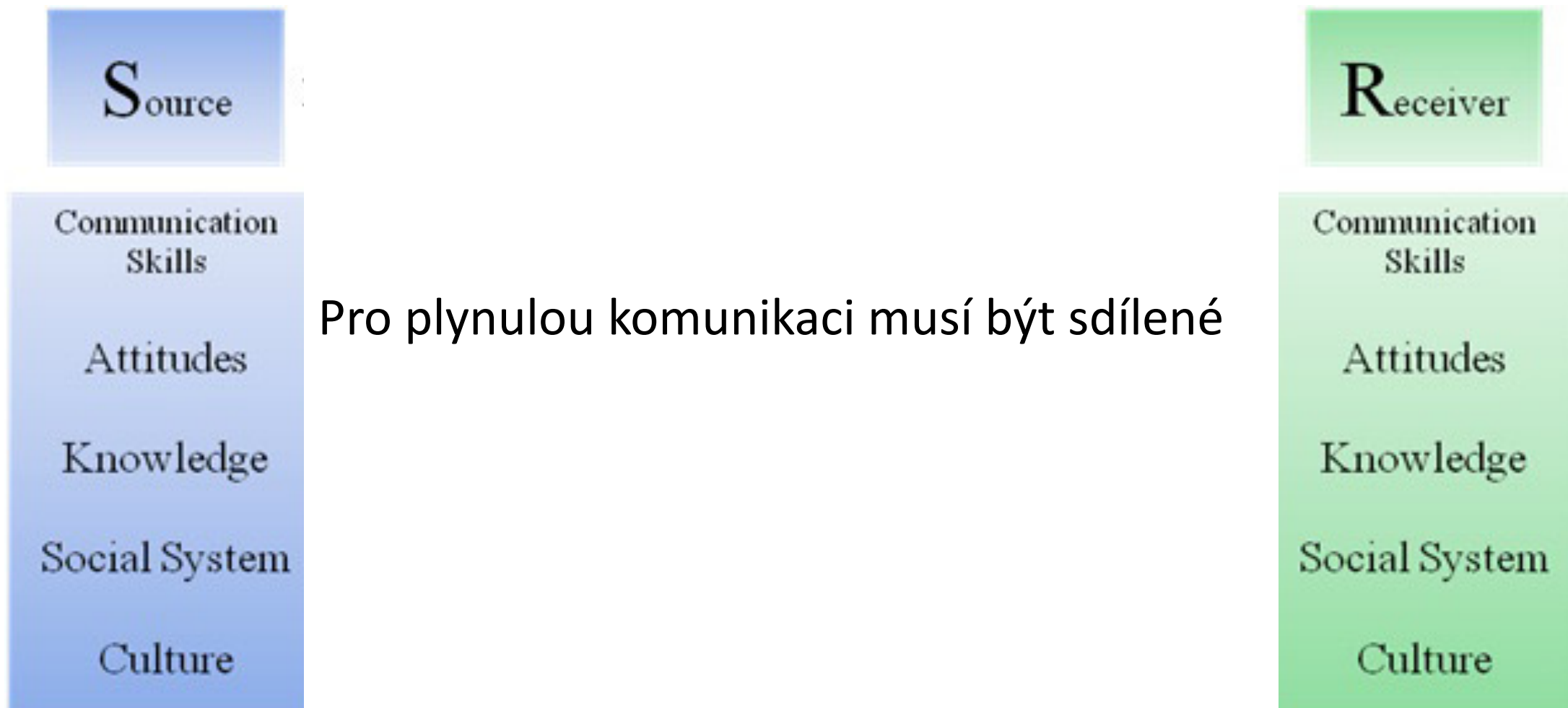

Berloův model S-M-C-R

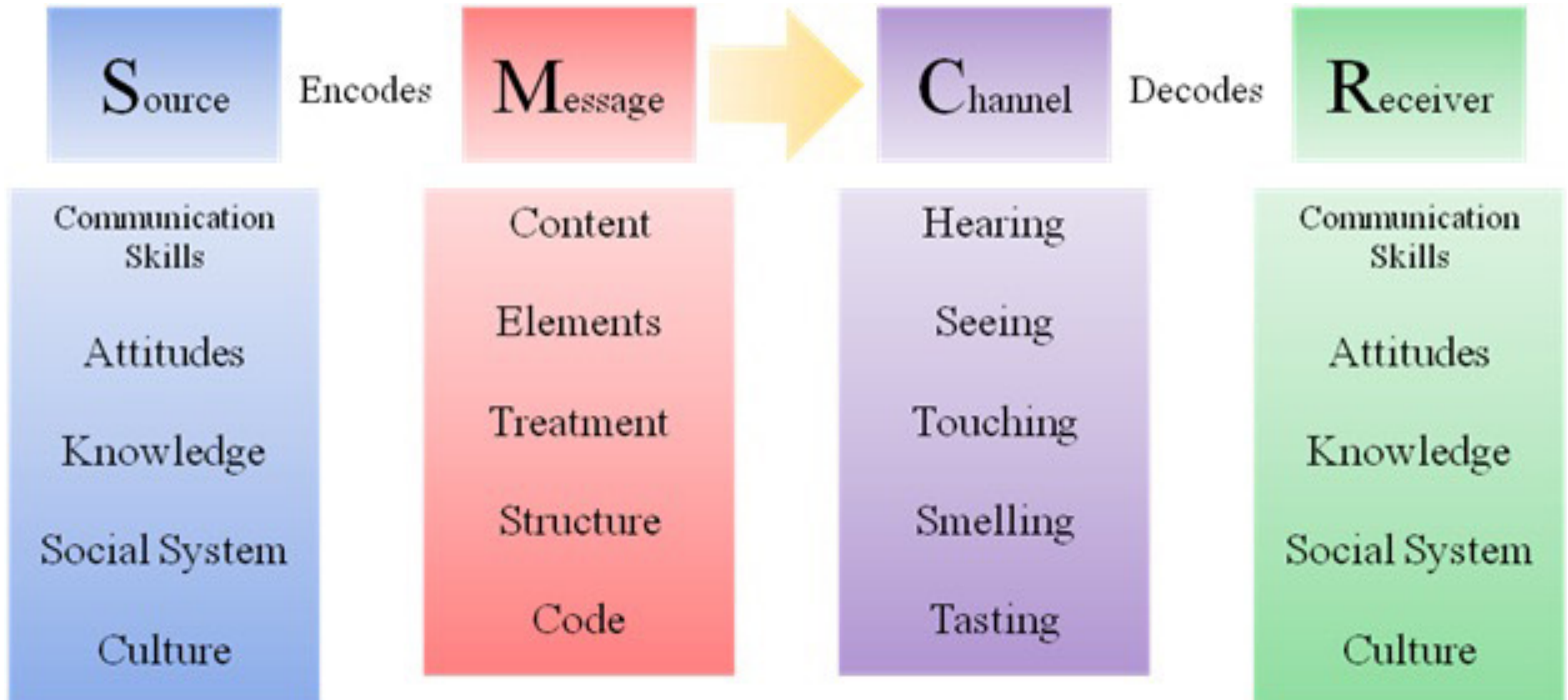

Osgood-Schramm kruhový model

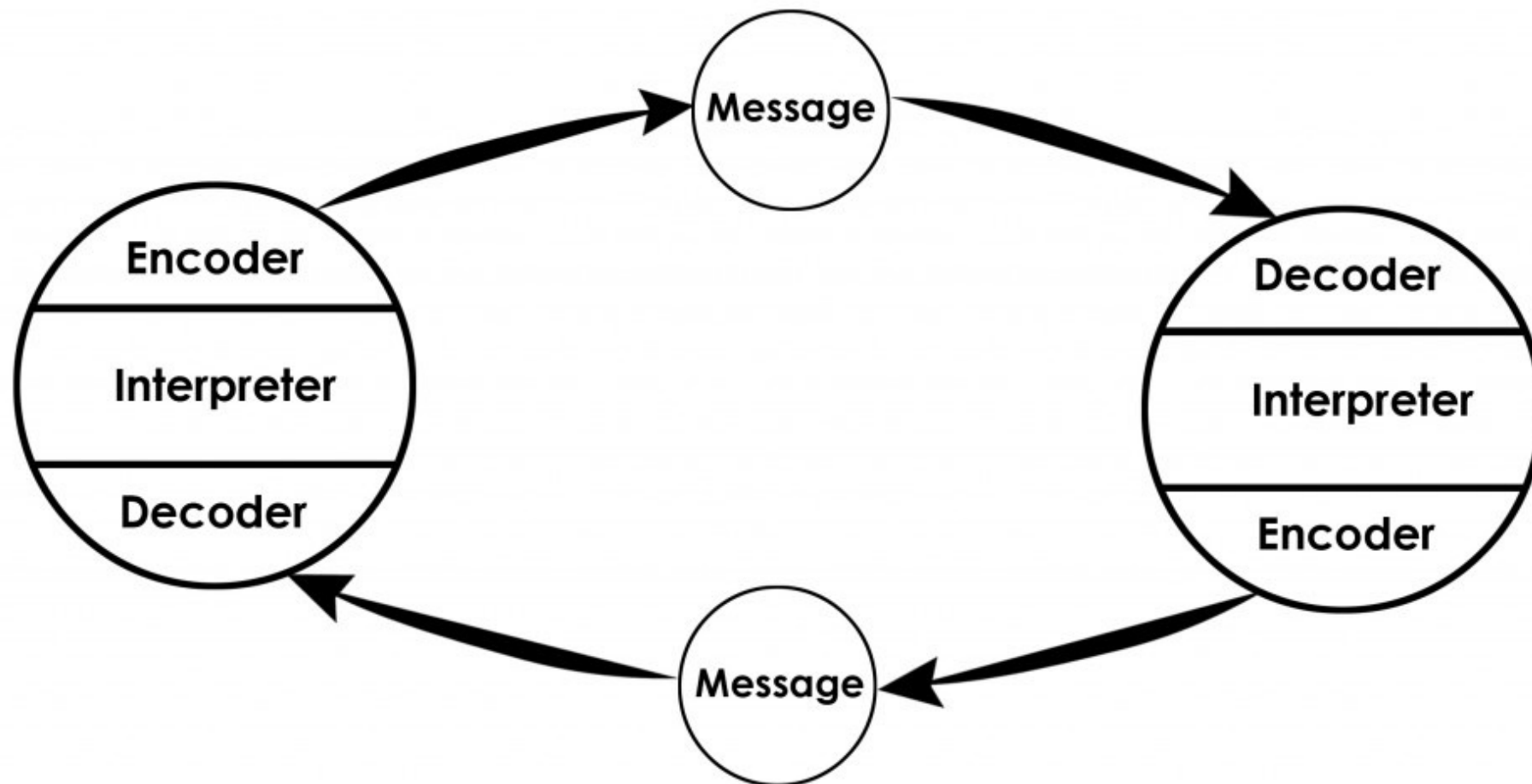

Osgood-Schramm kruhový model

„komunikace ale nezačíná a nekončí, probíhá neustále“

V průběhu komunikace reaguji na partnera

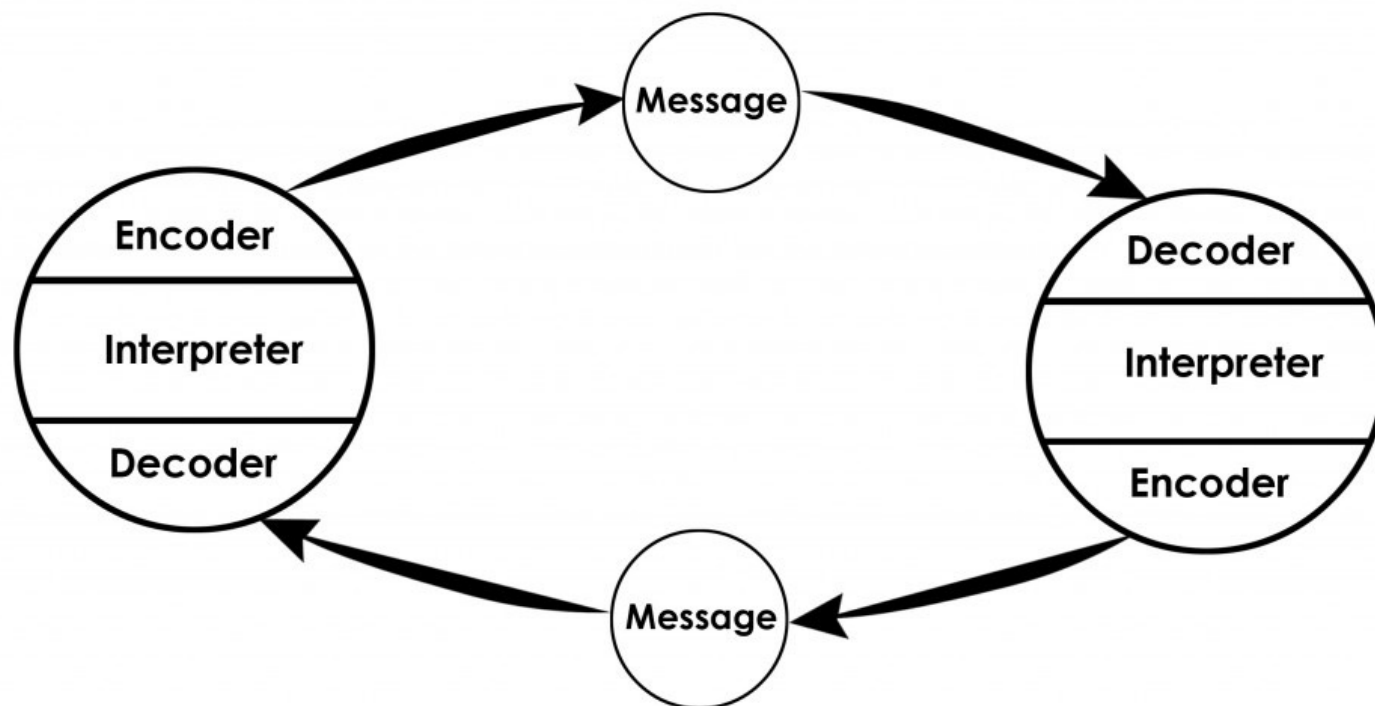

Schrammův model masové komunikace

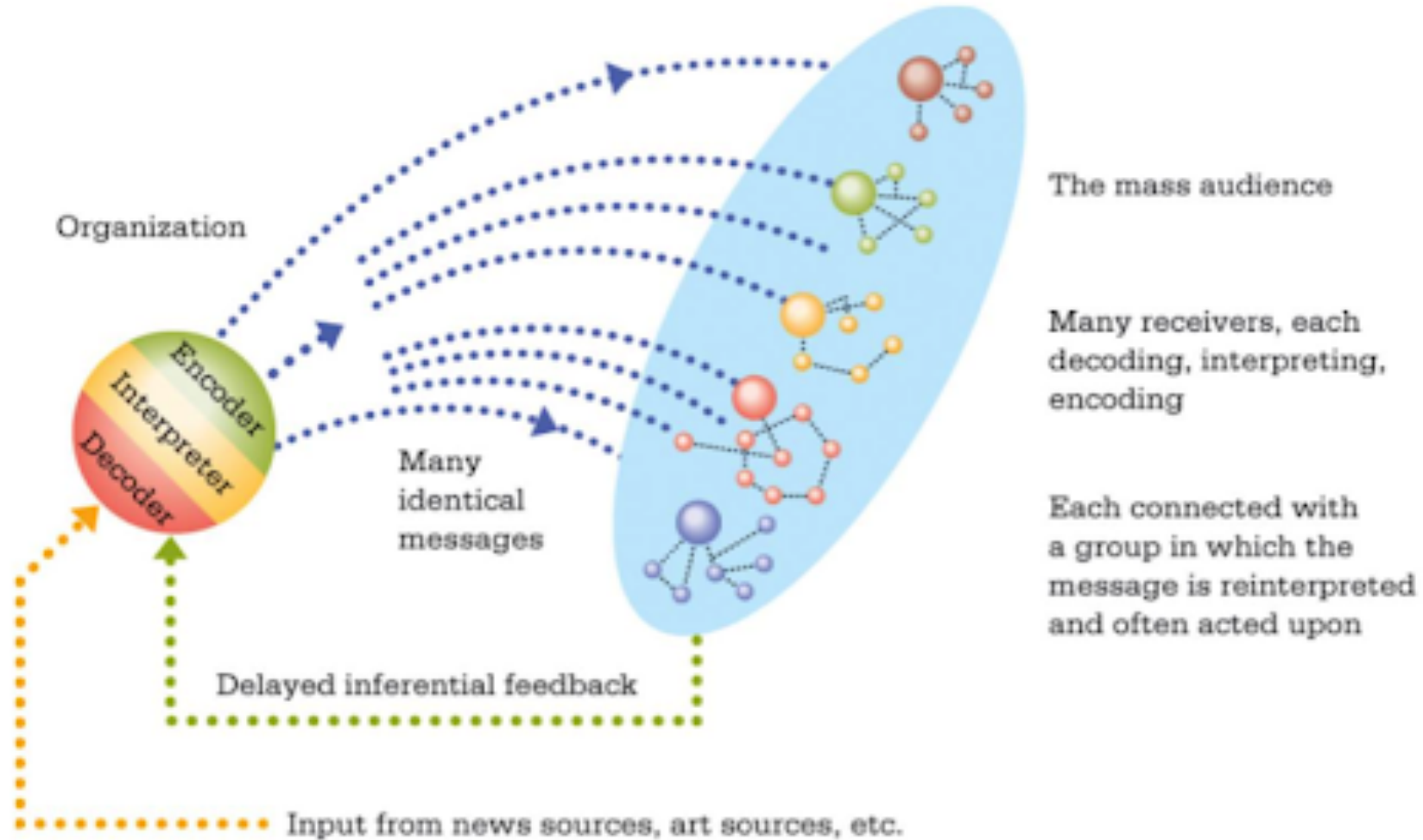

Schrammův model masové komunikace

Feedback často absentuje

Je potřeba jej pěstovat

Aktivizovat skupinu

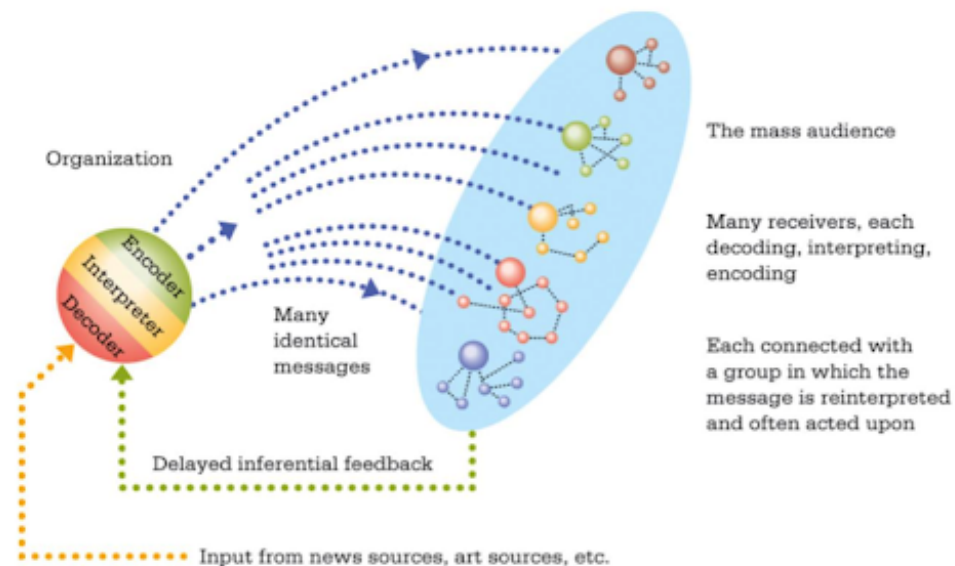

Magic Bullet Theory / Hypodermic Needle th.

- Vznikla v 1930's
- Lineární model založený na (vznikajících) masmédiích
- Přepokládá pasivní a homogenní publikum
- *„je to v rádiu, takže je to pravda“*
- (nemá silnou empirickou podporu)

Magic Bullet Theory / Hypodermic Needle th.

- Vznikla v 1930's
- Lineární model založený na (vznikajících) masmédiích
- Přepokládá pasivní a homogenní publikum
- *„je to v rádiu, takže je to pravda“*
- (nemá silnou empirickou podporu)

Full Business Wanted!

Advertise in Tomorrow's, Wednesday's, Thursday's and Friday's Globe. Read the ads in the Globe every day.

The Boston Daily Globe

Want Advertisements

To Buy, Sell, Hire or Rent anything, advertise in the Globe's Want Columns. Use the Daily Globe—Use the Sunday Globe.

BOSTON, MONDAY MORNING, OCTOBER 31, 1938—EIGHTEEN PAGES (2) TWO CENTS

RADIO PLAY TERRIFIES NATION

The Capital Parade

Lehman Expects Poletti Victory

By JOSEPH BLAND and ROBERT ROYSTER

WASHINGTON, Oct. 30.—In the excitement of the New York campaign, the hearing of Richard Lehman's plea for running again has escaped general attention.



It is public opinion with the winning New York Democrat called only for Charles Poletti's nomination as Lieutenant Governor. But the general opinion is that Poletti will also be his successor when the time comes. Two Demos may stand the great advantage, but, for the present,

READY FOR HALLOWEEN



BILLY BOWWELL AND LEE CRAWFORD
Watched past proud of their "pumpkin" lantern.

Police, Youth Groups Plan Safer and Saner Halloween

3 FIRES SET IN SO. END HOTEL

52 Guests, Employees Held in Darkness as Police Hunt Incendiary

Fifty-two guests and all employees were held virtual prisoners behind the locked doors of the South End Hotel, South End, for two hours last night while police hunted through the rooms and halls of the darkened building for a smoking.

Three fires were set in different floors of the hotel and the main electric light line into the building was cut out of commission between 7:30 and 8:15. At 11 o'clock the hotel was still in darkness, with guests and hotel employees holed up in groups in the lobby and first-floor reception rooms.

Electric light service was restored before midnight.

Feeling Best

Continued on Page 14

FAIL TO CLAIM BLUEBERRY CUP

PATROL WAGON, AUTO CRASH



TEN PERSONS WERE INJURED ON BRIDOCK ST., BRIGHTON.

POLICE, BRIDAL Mysterly Veils Fatal Injuries

T. W. ...

Mars Invasion Thought Real

Hysteria Grips Folk Listening In Late

Many Fear World Coming to End

NEW YORK, Oct. 30. (AP)—A fever among radio listeners throughout the nation and a wild panic throughout the nation of the alienation was caused by a broadcast of a radio play and a broadcast of a radio play and a broadcast of a radio play.

Excited and worried people all over the country crowded to the radio and police could hardly keep the streets clear.

Dvojstupňový model

- Lazarsfeld, Berelson, Gaudet

Two-step flow model

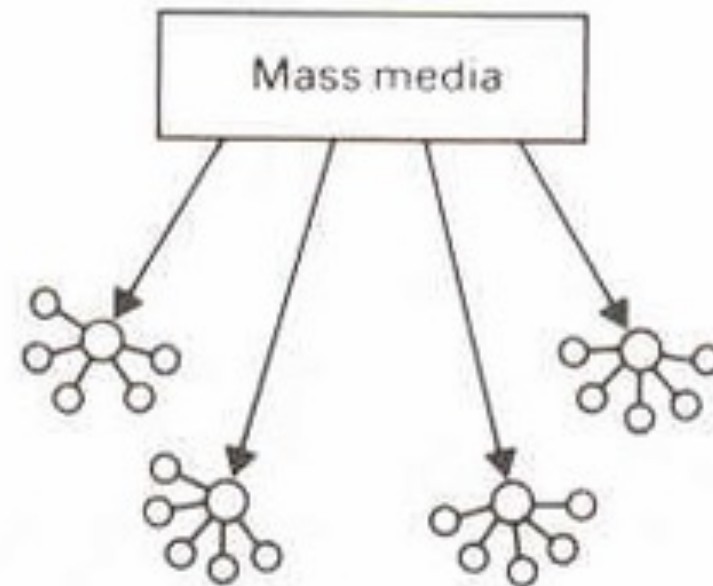

○ = Opinion leader

○ = Individuals in social contact with an opinion leader

Dvojstupňový model

- Lazarsfeld, Berelson, Gaudet
- Problém: kdo je názorový vůdce a jak jej jako firma najdu a oslovím?
- Problém: konzistence
- Problém: uvěřitelnost

Two-step flow model

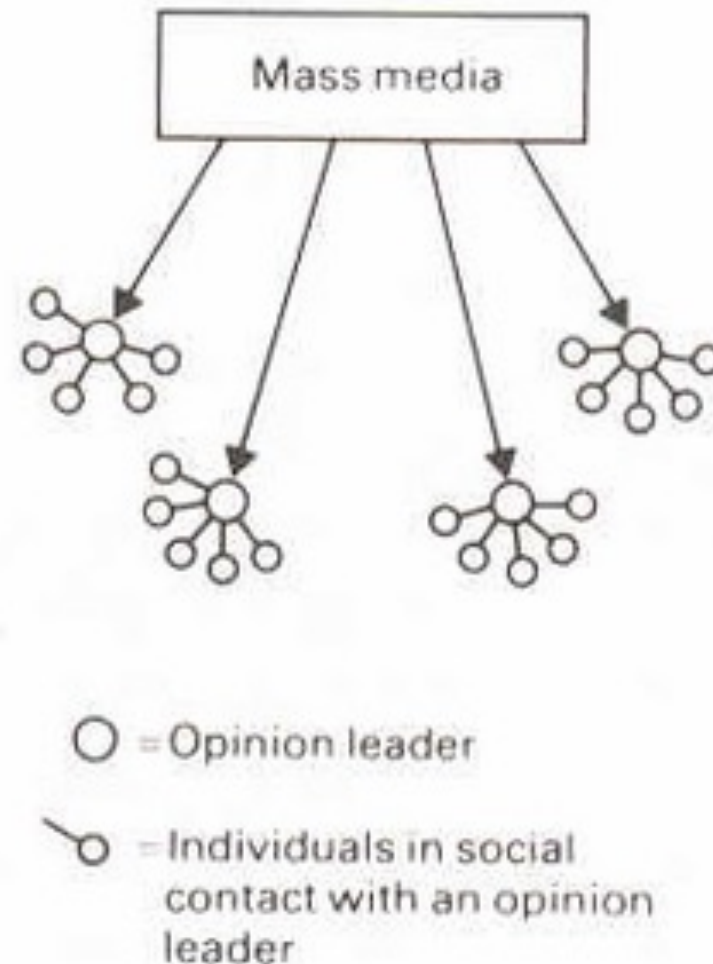

Dvojstupňový model

- Lazarsfeld, Berelson, Gaudet
- Náborový vůdce nemusí mít vzdělání, někde stačí aby hodně mluvil.

Two-step flow model

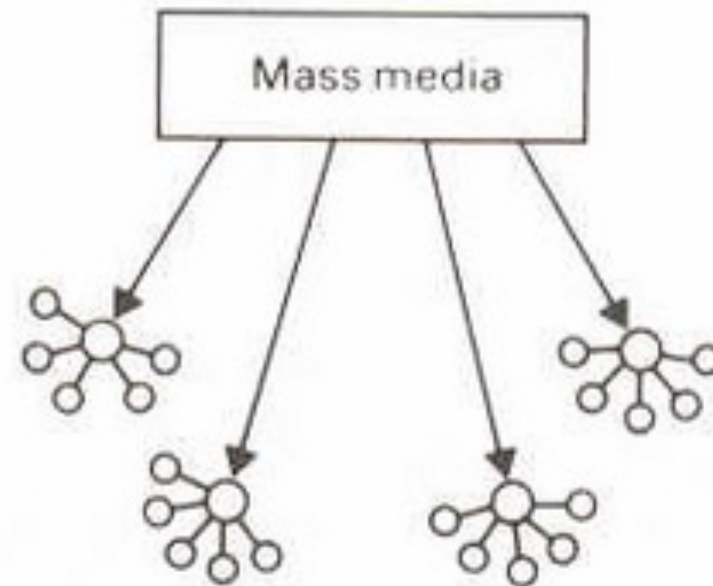

○ = Opinion leader

○ = Individuals in social contact with an opinion leader



Dvojstupňový model

- Lazarsfeld, Berelson, Gaudet
- Názorový vůdce nemusí mít vzdělání, někde stačí aby hodně kecal.
- Pomáhá s kognitivní disonancí

<https://www.youtube.com/watch?v=sR3f95BGIiA&>



Edited

Slovo Eco ve mně projevuje pocit, že něco dělám pro přírodu. Ačkoliv jsem si nezjišťovala v čem je vzorek ekologičtější než ostatní, věřím že titul nezískal výrobek jen tak.

Gerbnerův komunikační model (1956)

Gerbner's General Model

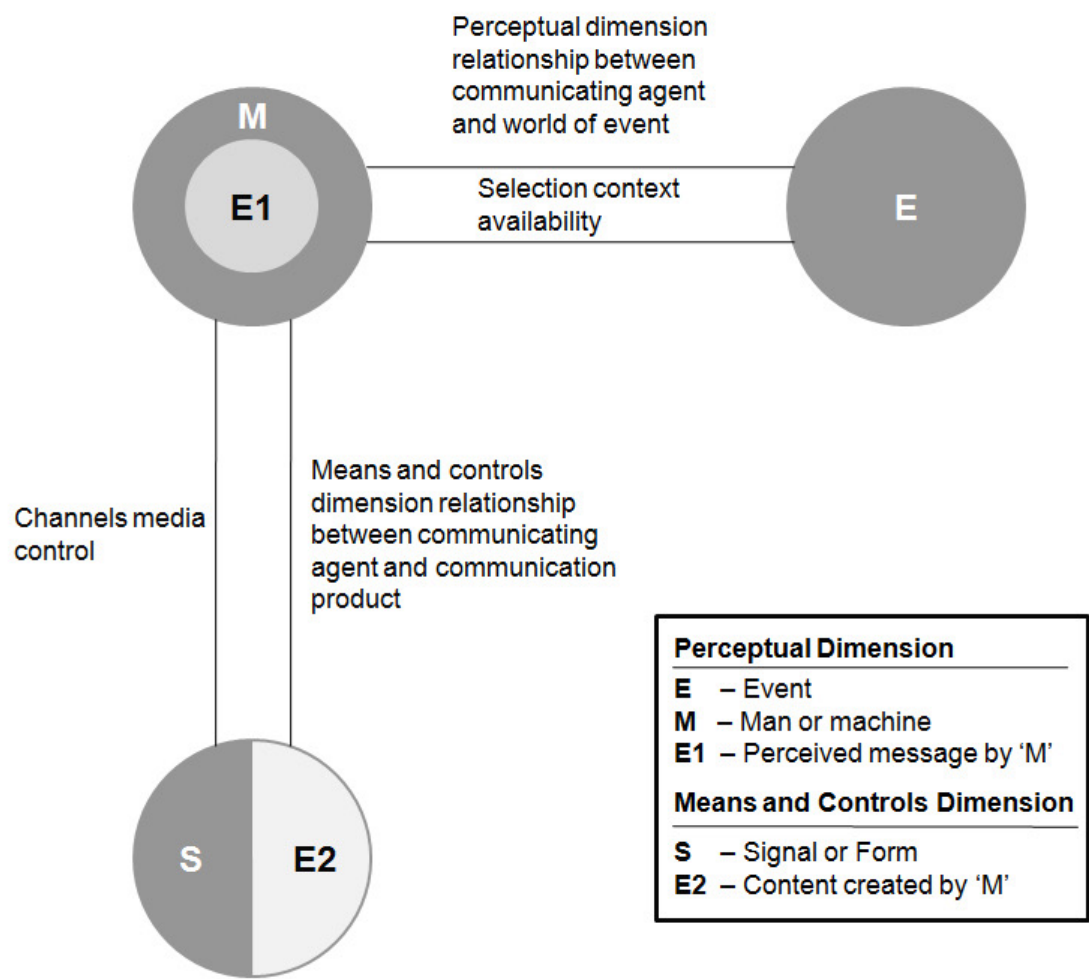

Gerbnerův komunikační model

Gerbner's General Model

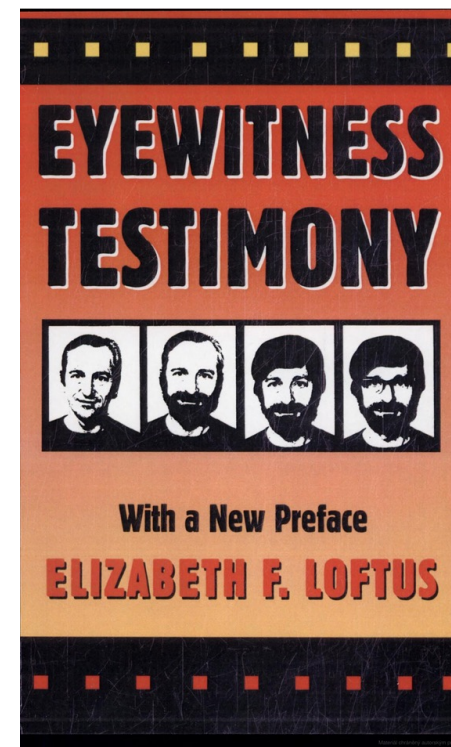
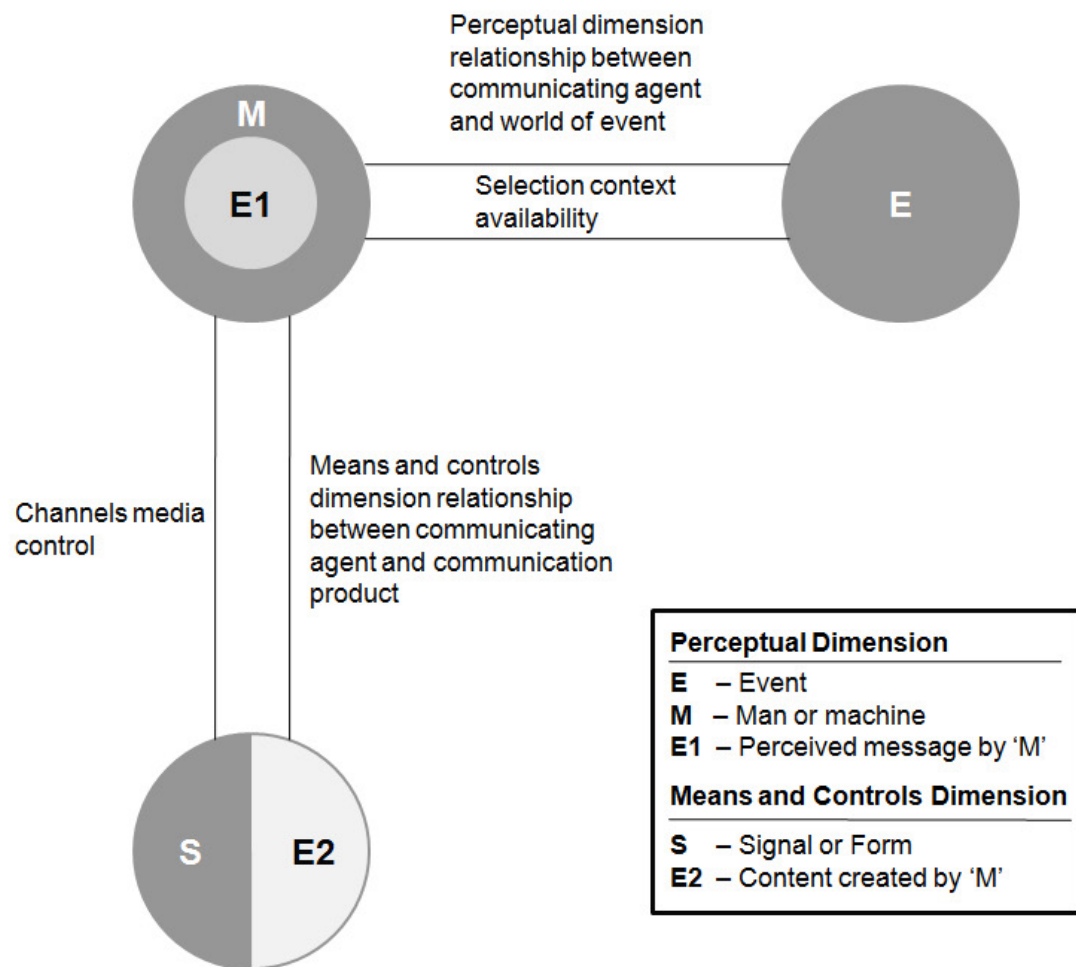

Maletzkeho model (1963)

- Gerhard Maletzke
- Psycholog
- Obsahuje prvky sociální psychologie



Maletzkeho model

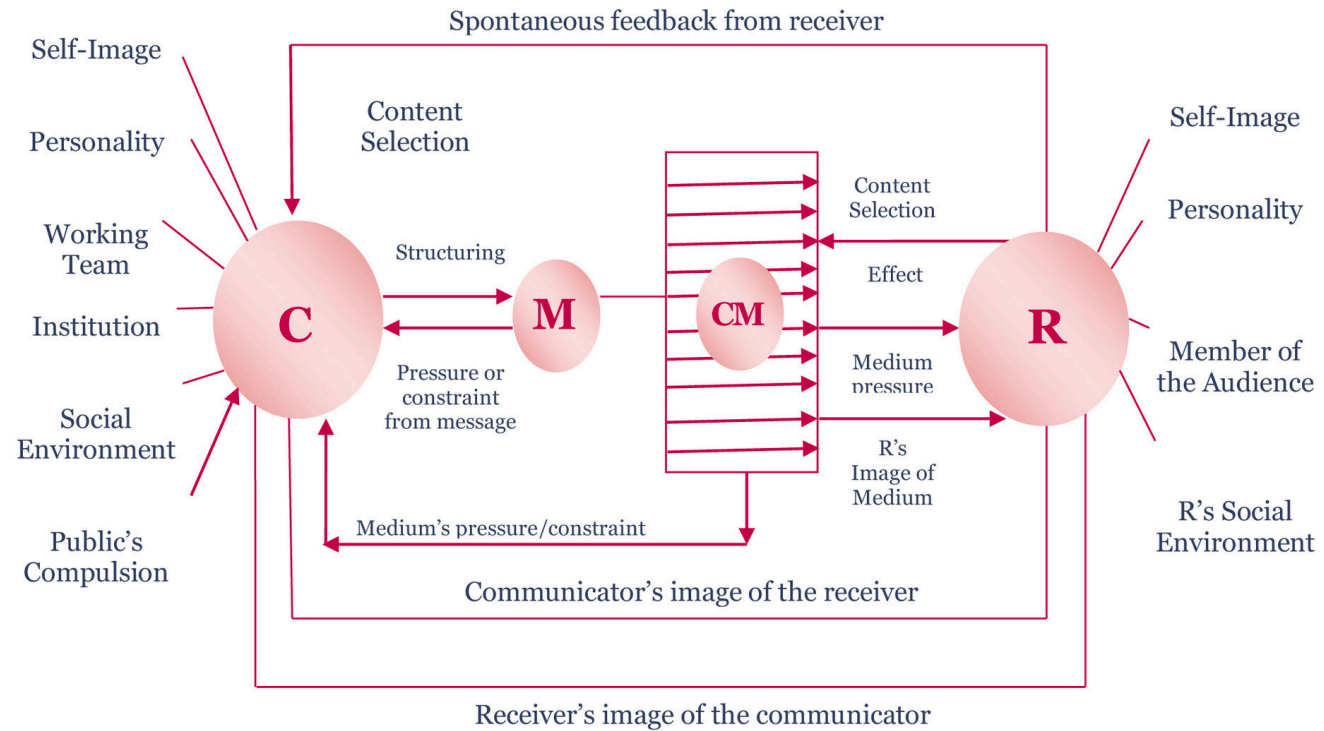

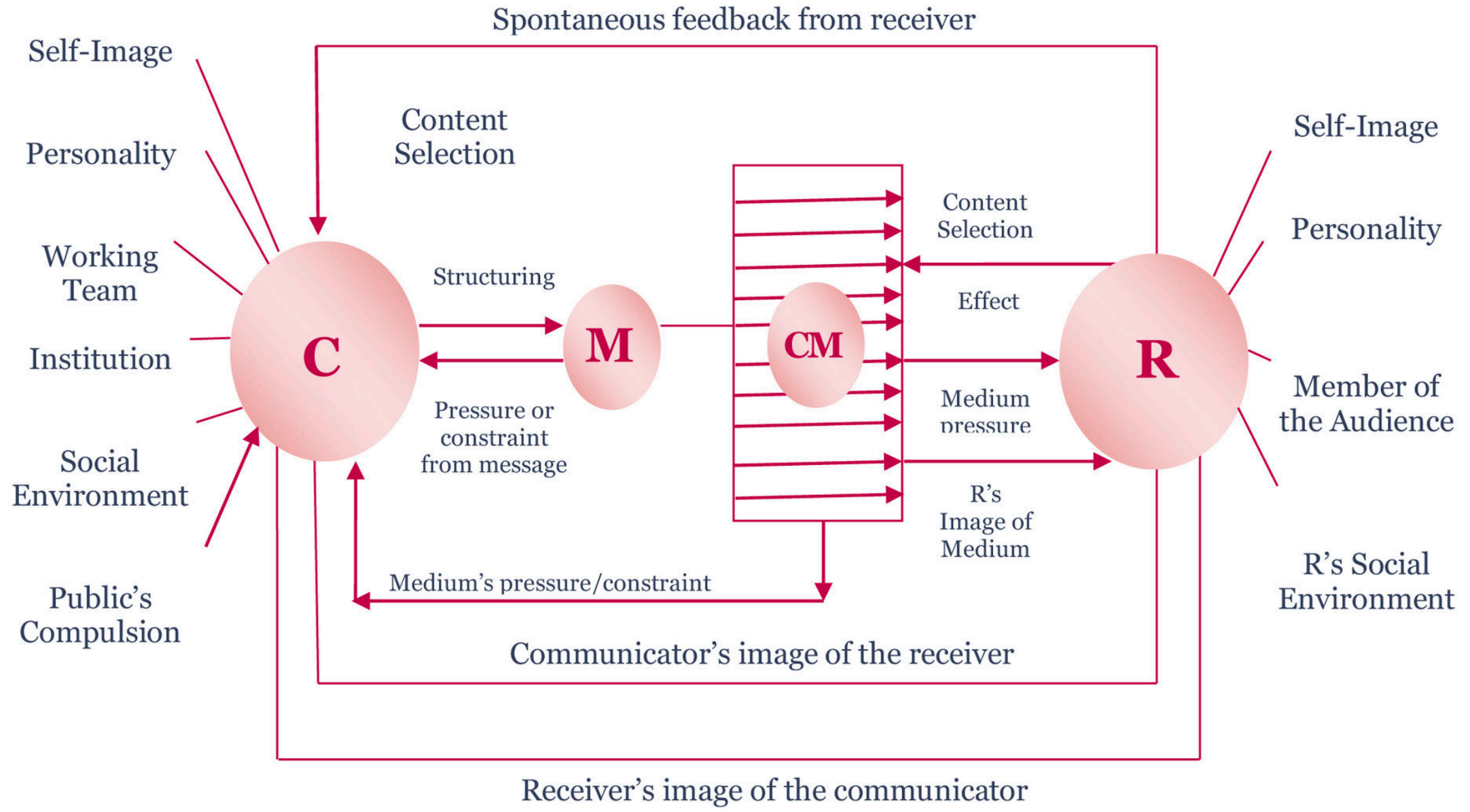





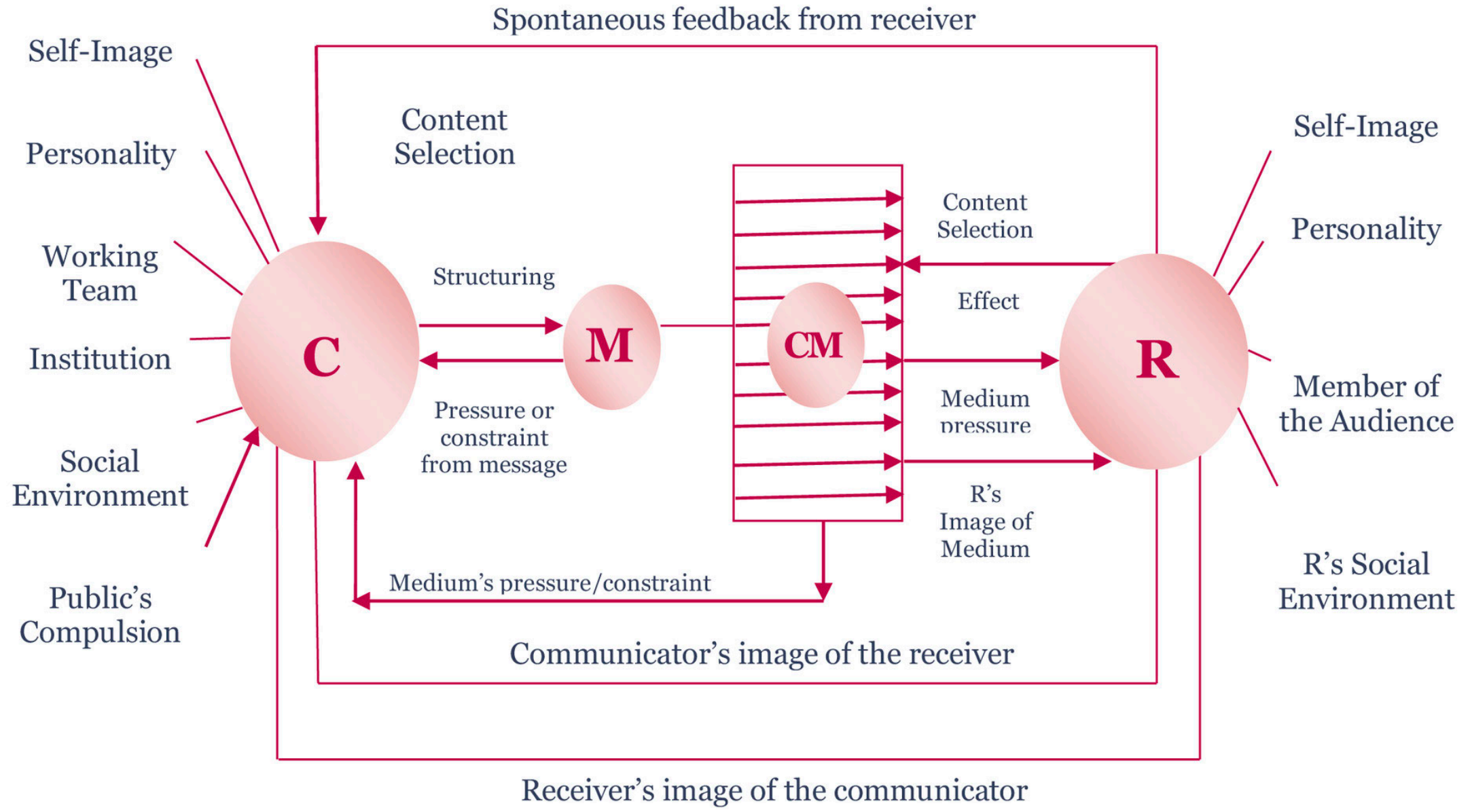

Cviko v pátek

- Výstavba plánu