

Digital Signal Processing

Finite Impulse Response Filters

Moslem Amiri, Václav Přenosil
Masaryk University

Understanding Digital Signal Processing, Third Edition, Richard Lyons
(0-13-261480-4) © Pearson Education, 2011.

Introduction

■ Filtering

- Filtering is the processing of a time-domain signal resulting in some change in that signal's original spectral content
 - The change is usually the reduction, or filtering out, of some unwanted input spectral components
 - That is, filters allow certain frequencies to pass while attenuating other frequencies

■ Digital filter in Fig. 5-1(b)

- Can be a software program in a computer, a programmable hardware processor, or a dedicated integrated circuit

Introduction

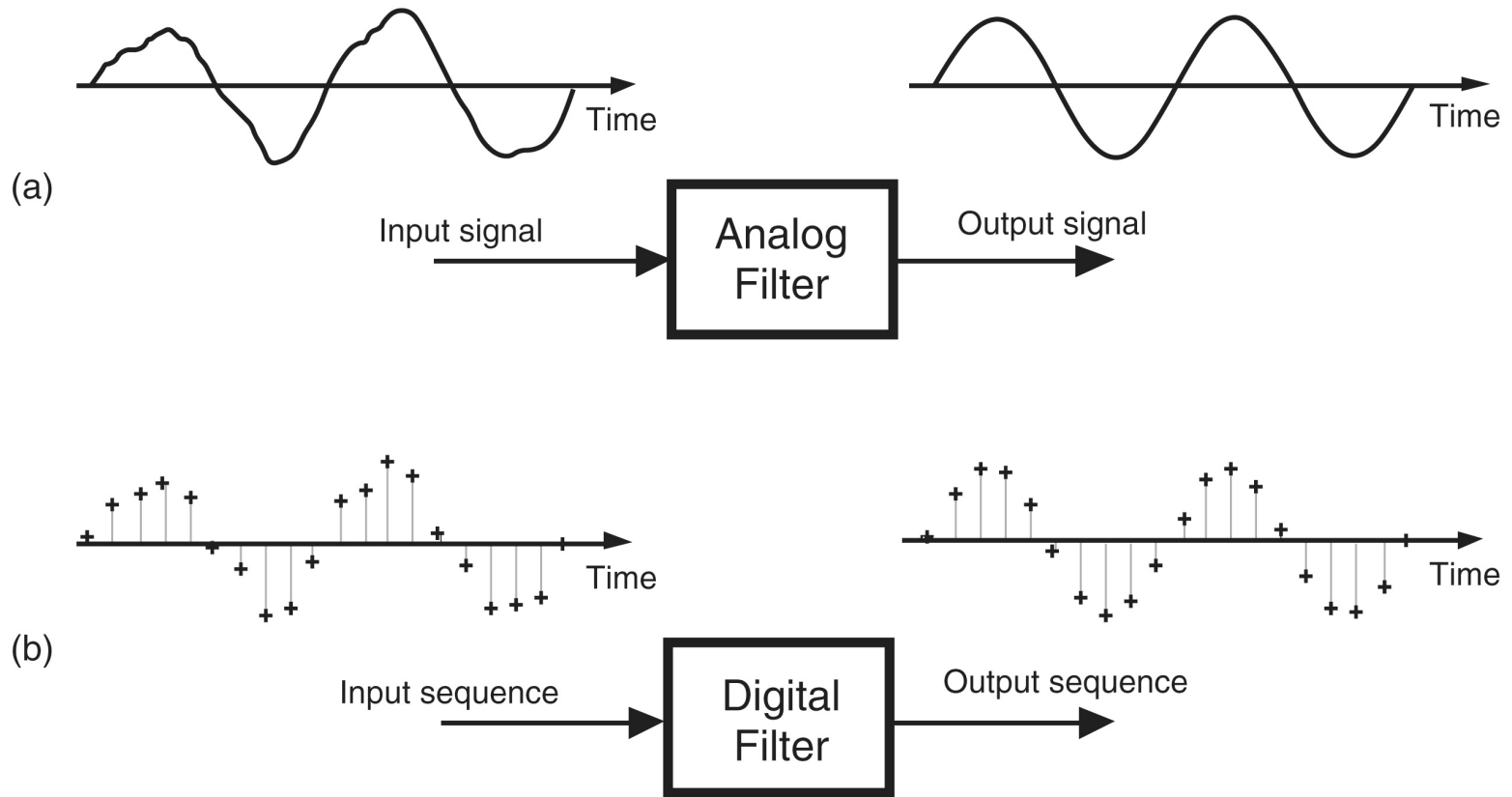

Figure 5-1 Filters: (a) an analog filter with a noisy tone input and a reduced-noise tone output; (b) the digital equivalent of the analog filter.

An Introduction to FIR Filters

- FIR filter
 - Given a finite duration of nonzero input values, an FIR filter will always have a finite duration of nonzero output values
 - If FIR filter's input is a sequence of all zeros, filter's output will be all zeros
 - FIR filters use addition to calculate their outputs
 - Averaging is a kind of FIR filter

An Introduction to FIR Filters

■ Averaging example

- We're counting the number of cars that pass over a bridge every minute, and every minute we'll calculate average number of cars/minute over the last five minutes

Minute index	No. of cars/minute over the last minute	No. of cars/minute averaged over the last five minutes
1	10	-
2	22	-
3	24	-
4	42	-
5	37	27
6	77	40.4
7	89	53.8
8	22	53.4
9	63	57.6
10	9	52

An Introduction to FIR Filters

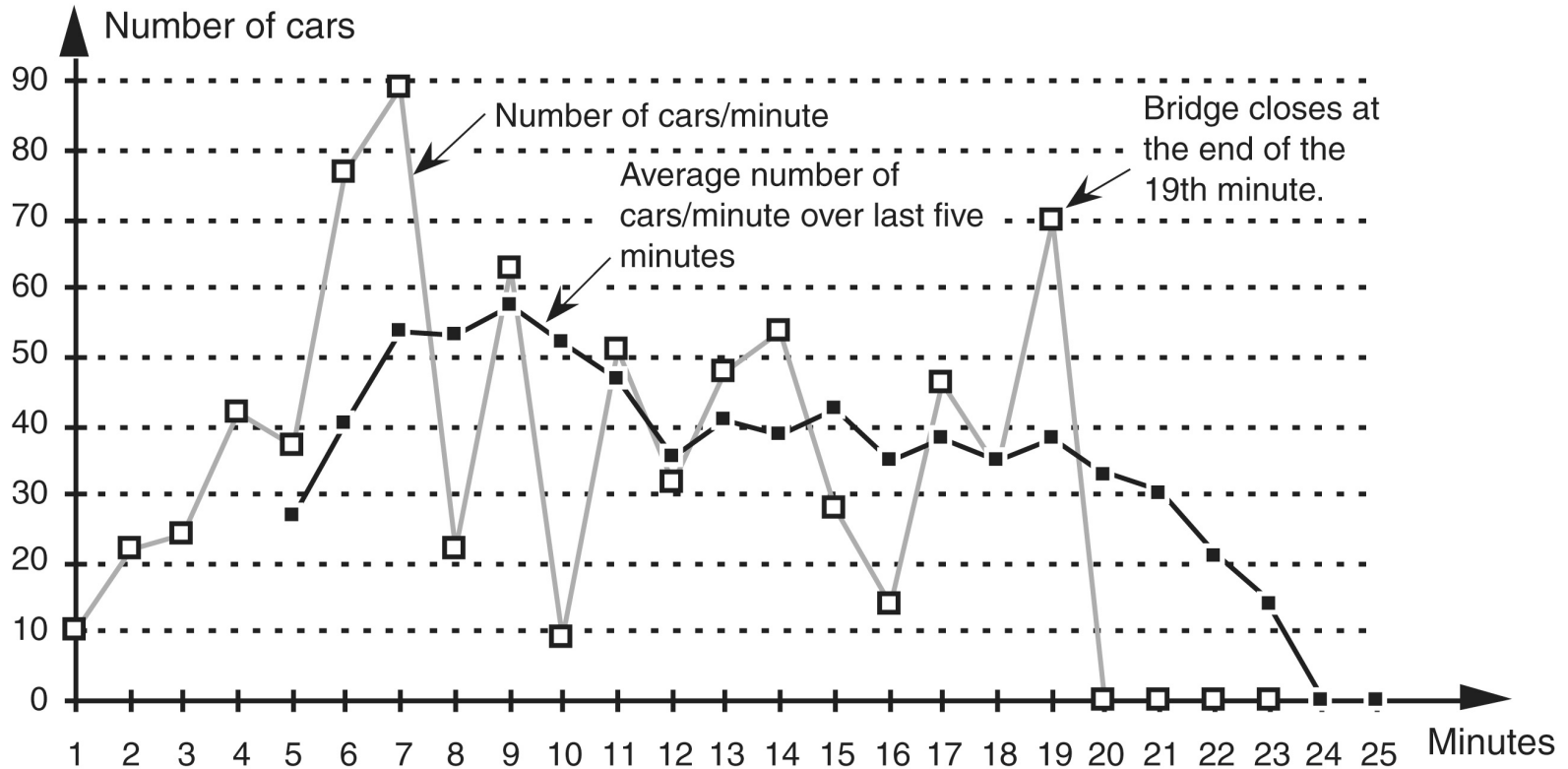

Figure 5-2 Averaging the number of cars/minute. The dashed line shows the individual cars/minute, and the solid line is the number of cars/minute averaged over the last five minutes.

An Introduction to FIR Filters

- Fig. 5-2
 - Sudden changes in input sequence of cars/minute are flattened out by averager
 - Since sudden transitions in a time sequence represent high-frequency components, averager is behaving like a lowpass filter
 - Averager is an FIR filter
 - No previous averager output value is used to determine a current output value; only input values are used to calculate output values
 - In addition, when input goes to zero, averager's output approaches and settles to a value of zero

An Introduction to FIR Filters

$$y_{ave}(5) = \frac{1}{5}[x(1) + x(2) + x(3) + x(4) + x(5)]$$

$$y_{ave}(n) = \frac{1}{5}[x(n-4) + x(n-3) + x(n-2) + x(n-1) + x(n)] = \frac{1}{5} \sum_{k=n-4}^n x(k)$$

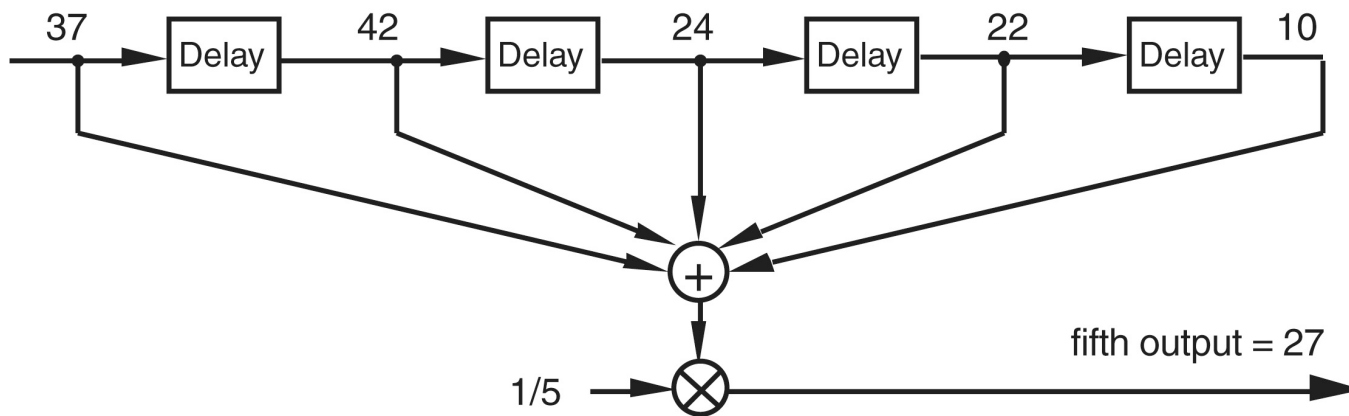

Figure 5-3 Averaging filter block diagram when the fifth input sample value, 37, is applied.

An Introduction to FIR Filters

- Fig. 5-3
 - Referred to as filter *structure*
 - Is a physical depiction of how to calculate averaging filter outputs with the input sequence of values shifted, in order, from left to right along the top of filter as new output calculations are performed
 - Delay elements, called *unit delays*, merely indicate a shift register arrangement where input sample values are temporarily stored during an output calculation

An Introduction to FIR Filters

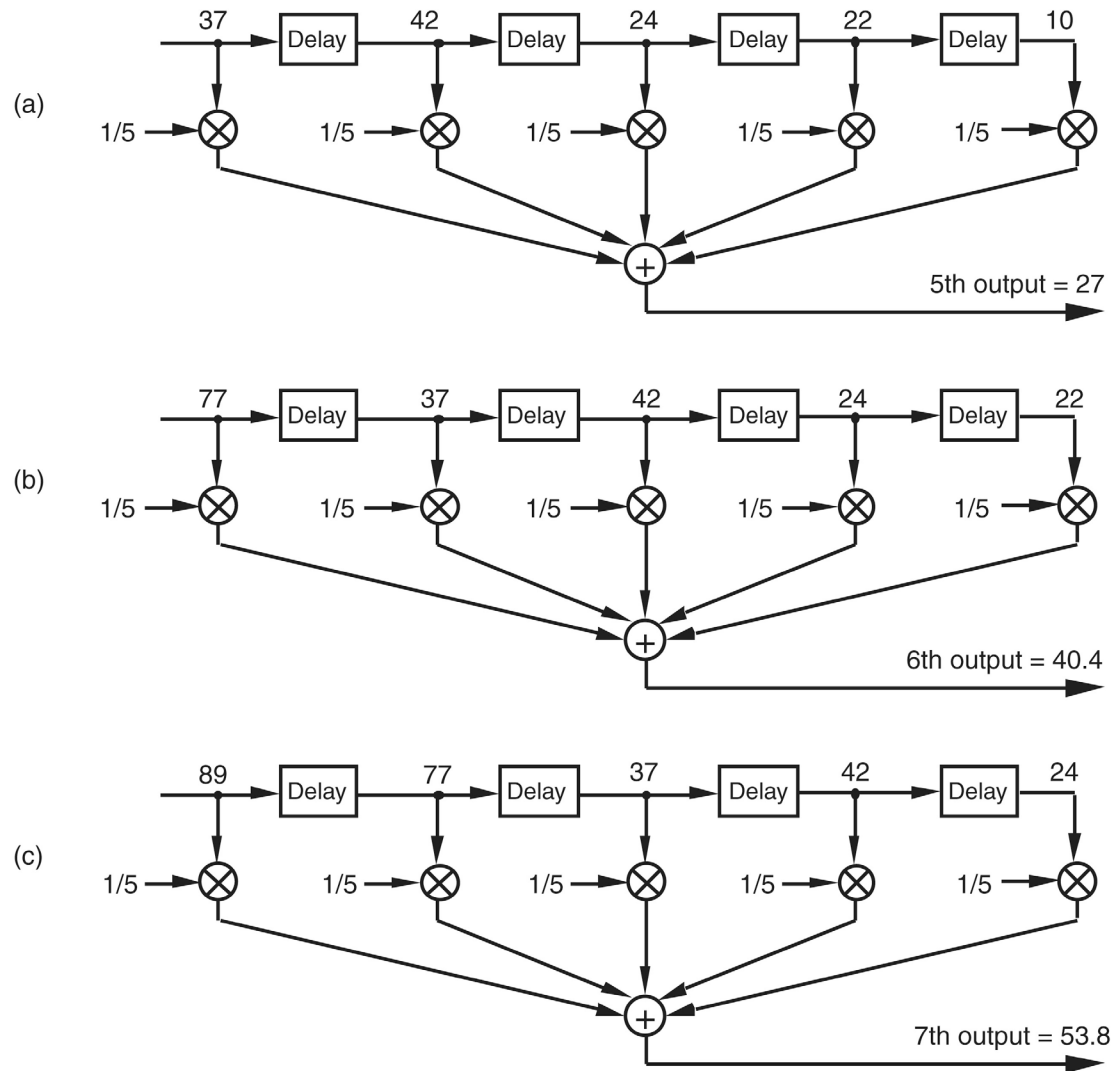

Figure 5-4 Alternate averaging filter structure: (a) input values used for the fifth output value; (b) input values used for the sixth output value; (c) input values used for the seventh output value.

An Introduction to FIR Filters

■ Fig. 5-4

$$y_{ave}(n) = \frac{1}{5}x(n-4) + \frac{1}{5}x(n-3) + \frac{1}{5}x(n-2) + \frac{1}{5}x(n-1) + \frac{1}{5}x(n) = \sum_{k=n-4}^n \frac{1}{5}x(k)$$

- In (a), each of the first five input values is multiplied by $1/5$, and the five products are summed to give the fifth filter output value
- To calculate sixth output value, input sequence is right-shifted, discarding the first input value of 10, and the sixth input value, 77, is accepted on left
- The filter's structure using this shifting process is called a *transversal filter*
- Because we *tap off* five separate input sample values to calculate an output value, the structure is called a 5-tap tapped-delay line FIR filter

Convolution in FIR Filters

- Averaging filter convolution
 - Convolution equation

$$y_{ave}(n) = \frac{1}{5}x(n-4) + \frac{1}{5}x(n-3) + \frac{1}{5}x(n-2) + \frac{1}{5}x(n-1) + \frac{1}{5}x(n) = \sum_{k=n-4}^n \frac{1}{5}x(k)$$

- We can graphically depict this equation's calculations as shown in Fig. 5-5
- Input samples: $x(0)$, $x(1)$, $x(2)$, ...
- Filter coefficients: $h(0)$ through $h(4)$
- In above equation, we use factor of $1/5$ as filter coefficients multiplied by averaging filter's input samples
- Time order of inputs in Fig. 5-5 is reversed

Convolution in FIR Filters

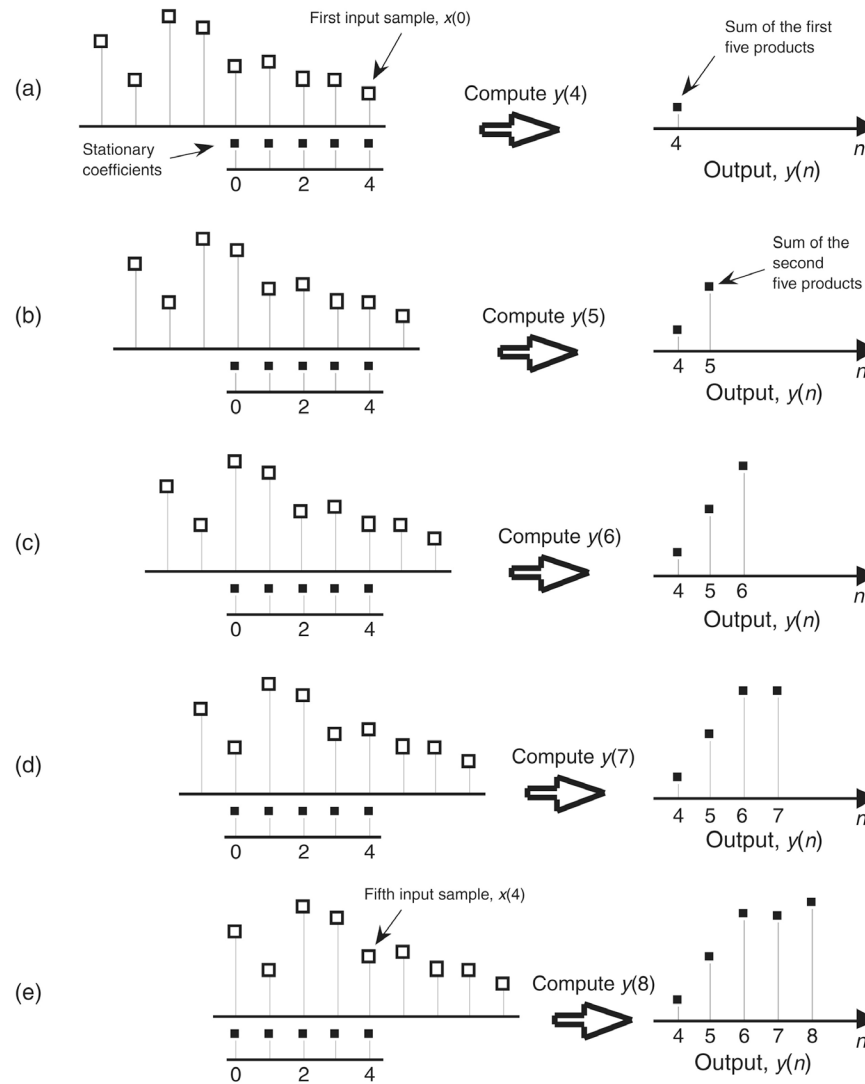

Figure 5-5 Averaging filter convolution: (a) first five input samples aligned with the stationary filter coefficients, index $n = 4$; (b) input samples shift to the right and index $n = 5$; (c) index $n = 6$; (d) index $n = 7$; (e) index $n = 8$.

Convolution in FIR Filters

- FIR filter's $y(n)$ th output

$$y(n) = \frac{1}{5}x(n-4) + \frac{1}{5}x(n-3) + \frac{1}{5}x(n-2) + \frac{1}{5}x(n-1) + \frac{1}{5}x(n)$$

filter coefficients
= $h(k)$

→ $y(n) = h(4)x(n-4) + h(3)x(n-3) + h(2)x(n-2) + h(1)x(n-1) + h(0)x(n)$

$$= \sum_{k=0}^4 h(k)x(n-k)$$

- For a general M -tap FIR filter, n th output is

$$y(n) = \sum_{k=0}^{M-1} h(k)x(n-k)$$

- This is convolution equation as it applies to digital FIR filters

Convolution in FIR Filters

- Impulse response of a filter
 - Filter's output time-domain sequence when input is a single unity-valued sample (impulse) preceded and followed by zero-valued samples
- Fig. 5-6
 - FIR filter's impulse response is identical to the five filter coefficient values
 - For this reason, the terms *FIR filter coefficients* and *impulse response* are synonymous
 - Because there are a finite number of coefficients, impulse response will be finite in time duration
 - Finite impulse response, FIR

Convolution in FIR Filters

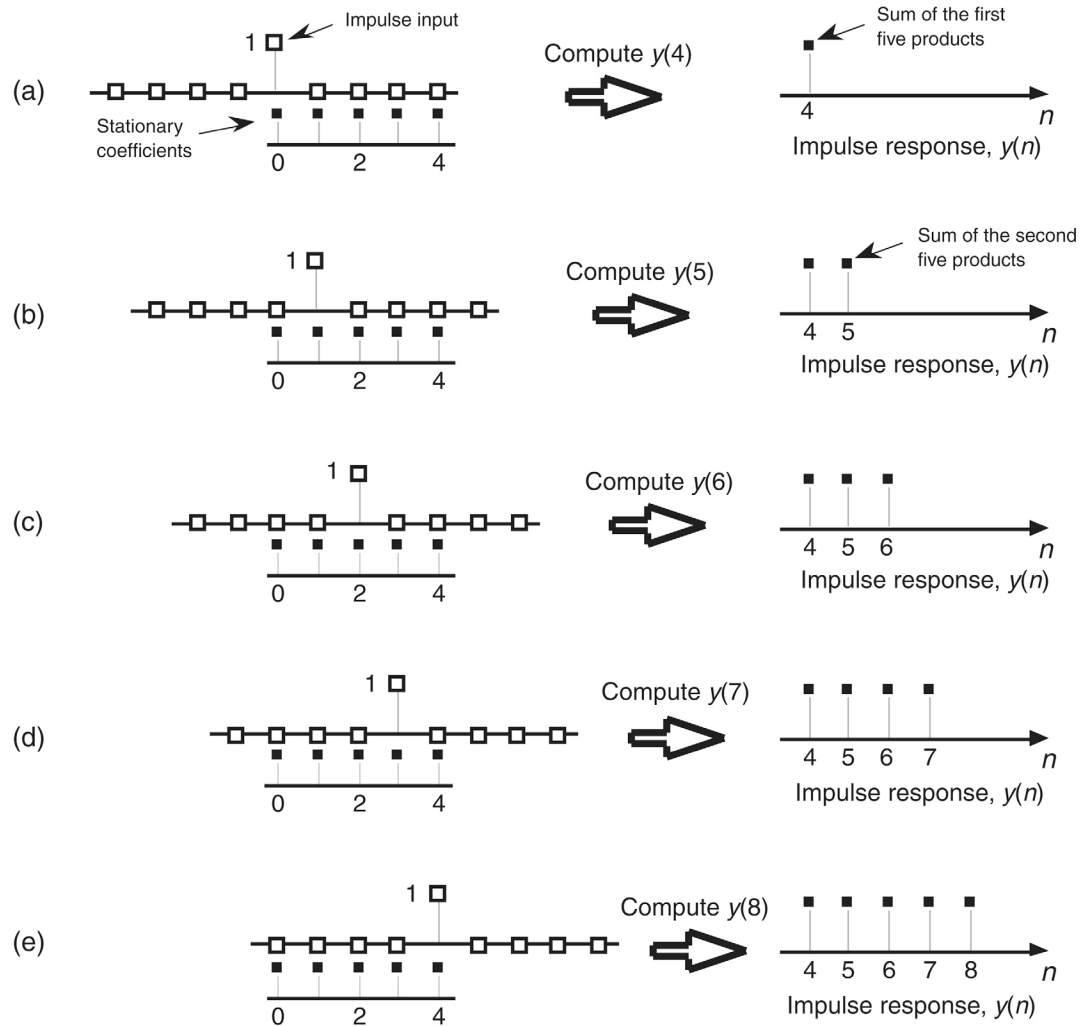

Figure 5-6 Convolution of filter coefficients and an input impulse to obtain the filter's output impulse response: (a) impulse sample aligned with the first filter coefficient, index $n = 4$; (b) impulse sample shifts to the right and index $n = 5$; (c) index $n = 6$; (d) index $n = 7$; (e) index $n = 8$.

Convolution in FIR Filters

- Process of convolution, as it applies to FIR filters

$$y(n) = h(k) * x(n) \begin{array}{c} \xrightarrow{\text{DFT}} \\ \xleftarrow{\text{IDFT}} \end{array} H(m) \cdot X(m)$$

- Two sequences resulting from $h(k) * x(n)$ and $H(m) \cdot X(m)$ are Fourier transform pairs
- Convolution in time domain is equivalent to multiplication in frequency domain

Convolution in FIR Filters

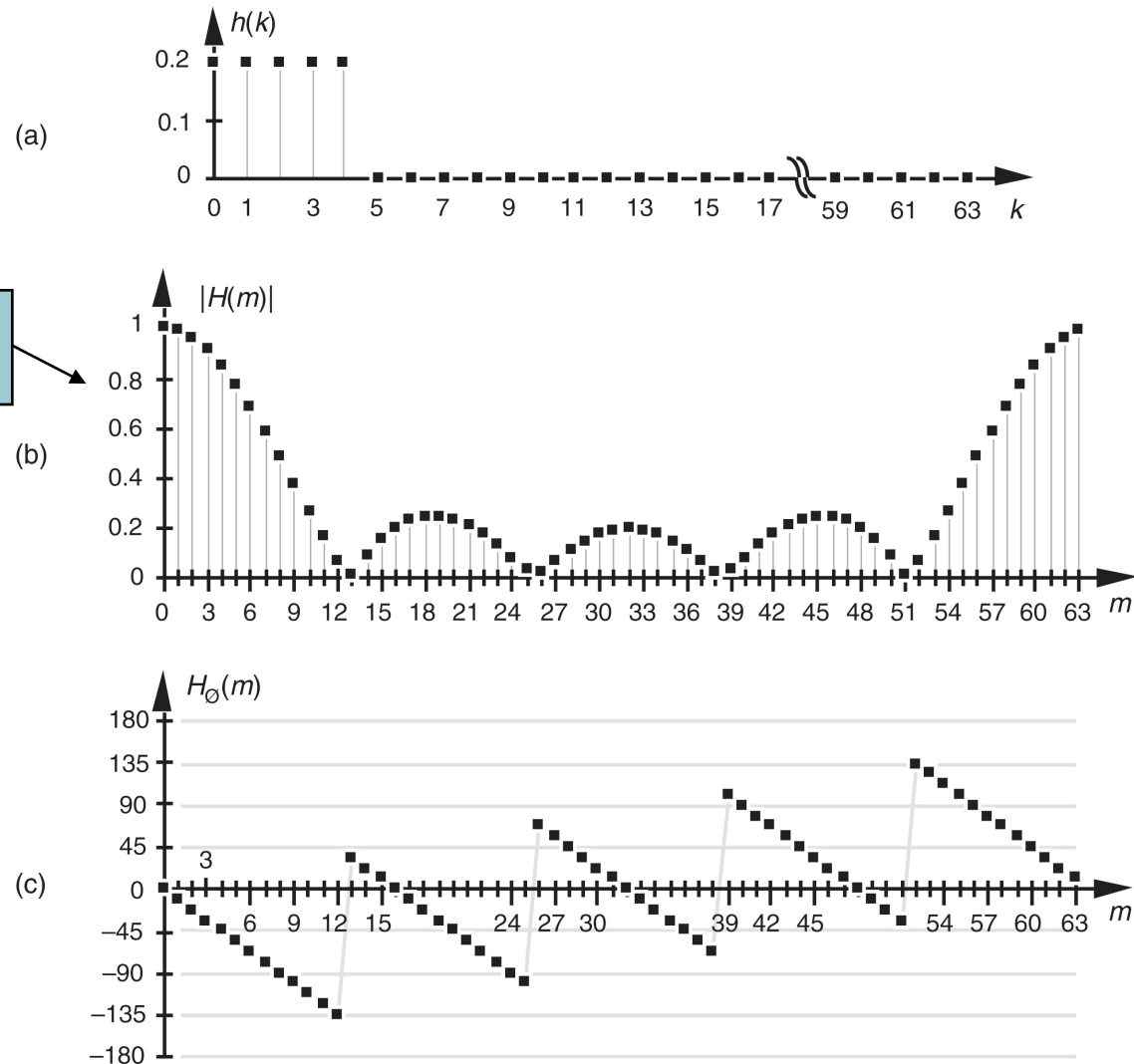

Figure 5-8 Averaging FIR filter: (a) filter coefficient sequence $h(k)$ with appended zeros; (b) normalized discrete frequency magnitude response $|H(m)|$ of the $h(k)$ filter coefficients; (c) phase-angle response of $H(m)$ in degrees.

Convolution in FIR Filters

Conversion of discrete frequency axis in Fig. 5-8 to continuous

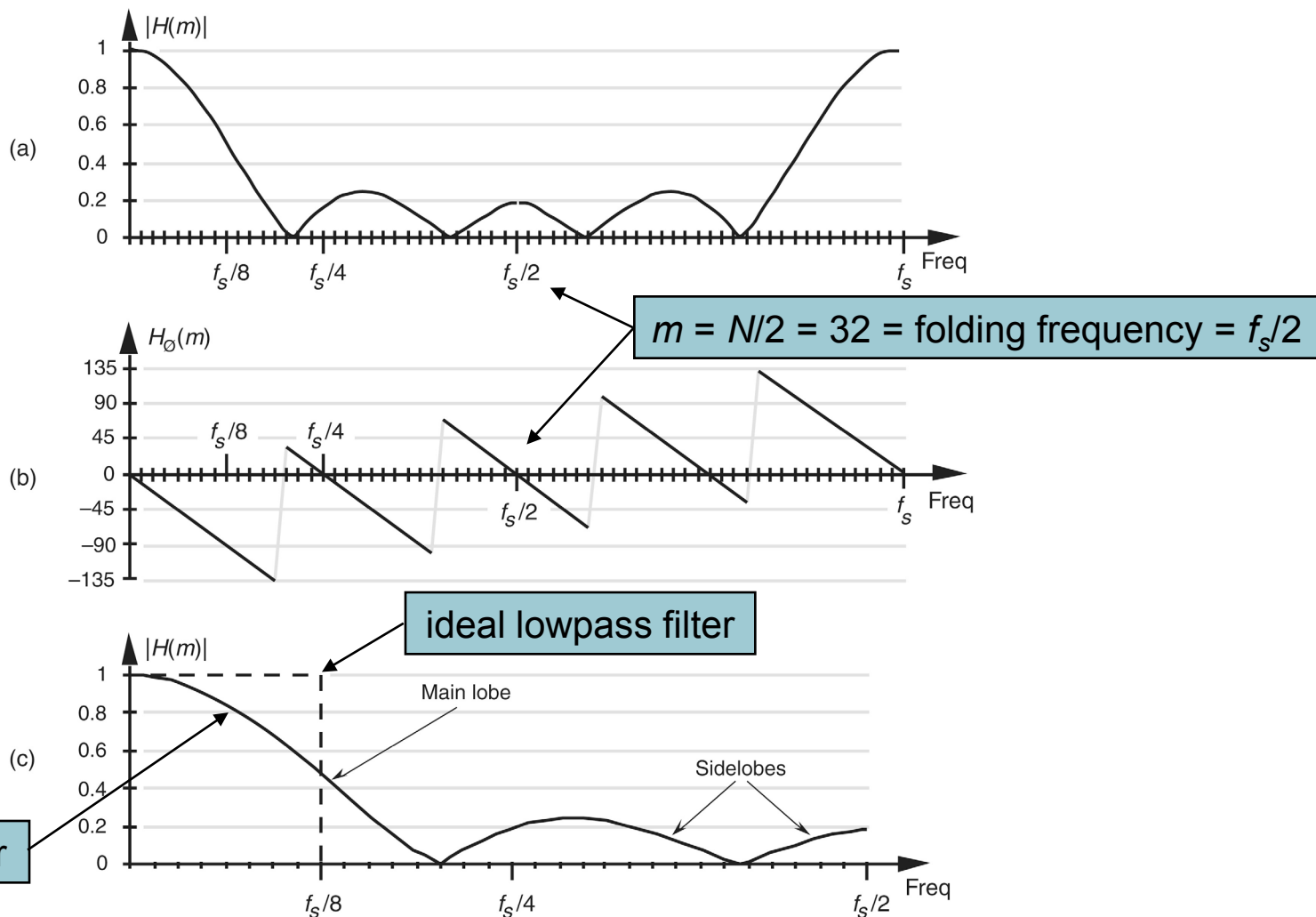
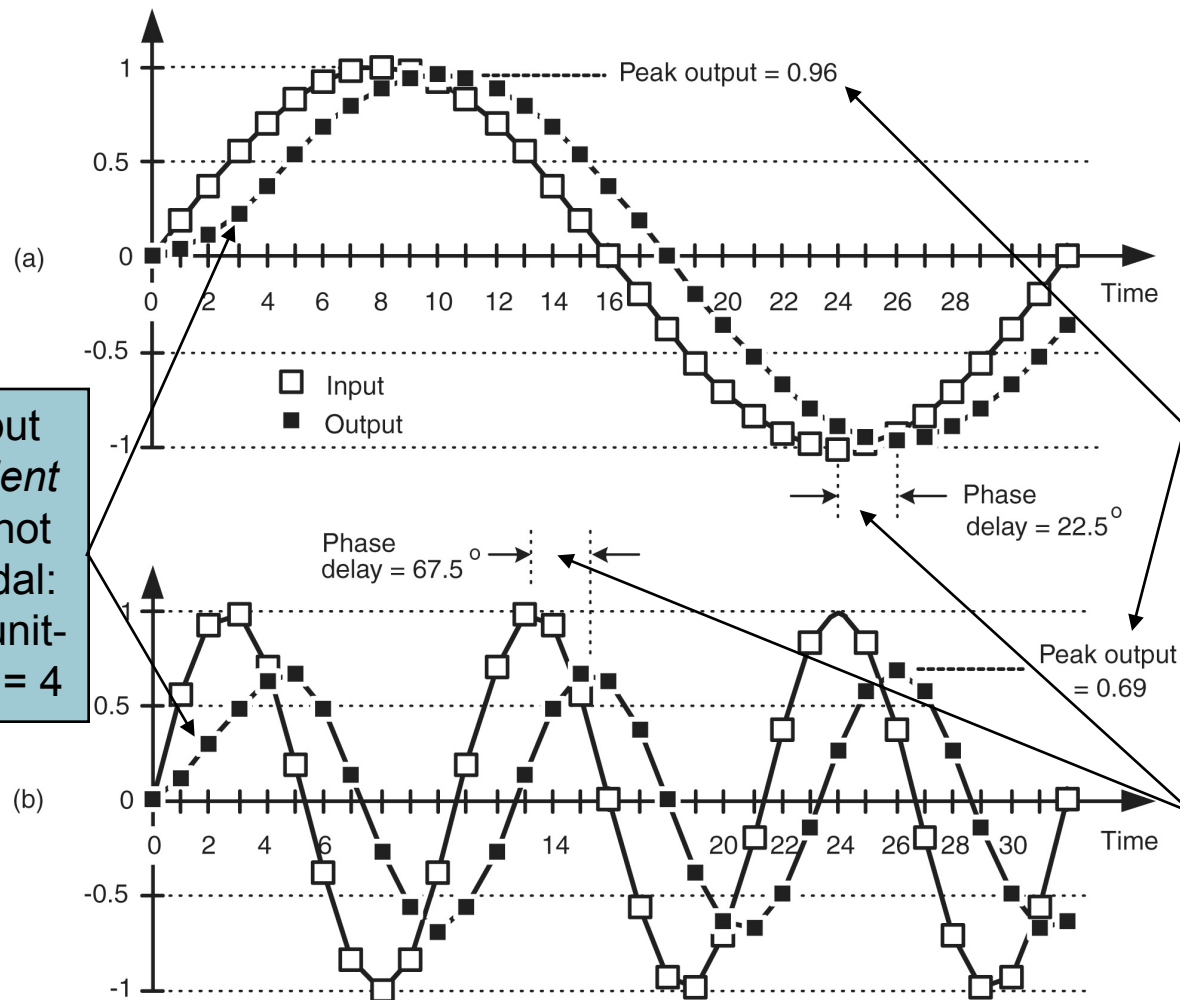

Figure 5-9 Averaging FIR filter frequency response shown as continuous curves: (a) normalized frequency magnitude response, $|H(m)|$; (b) phase-angle response of $H(m)$ in degrees; (c) the filter's magnitude response between zero Hz and half the sample rate, $f_s/2$ Hz.

Convolution in FIR Filters



output is a sinewave of same frequency as input

averaging filter attenuates higher-frequency inputs further

filter's coefficients are symmetrical → input/output delay = half the no. of unit-delay elements = 2 samples (no dependence on frequency)

initial four output samples (*transient response*) are not exactly sinusoidal: the no. of filter unit-delay elements = 4

Figure 5-10 Averaging FIR filter input and output responses: (a) with an input sinewave of frequency $f_s/32$; (b) with an input sinewave of frequency $3f_s/32$.

Convolution in FIR Filters

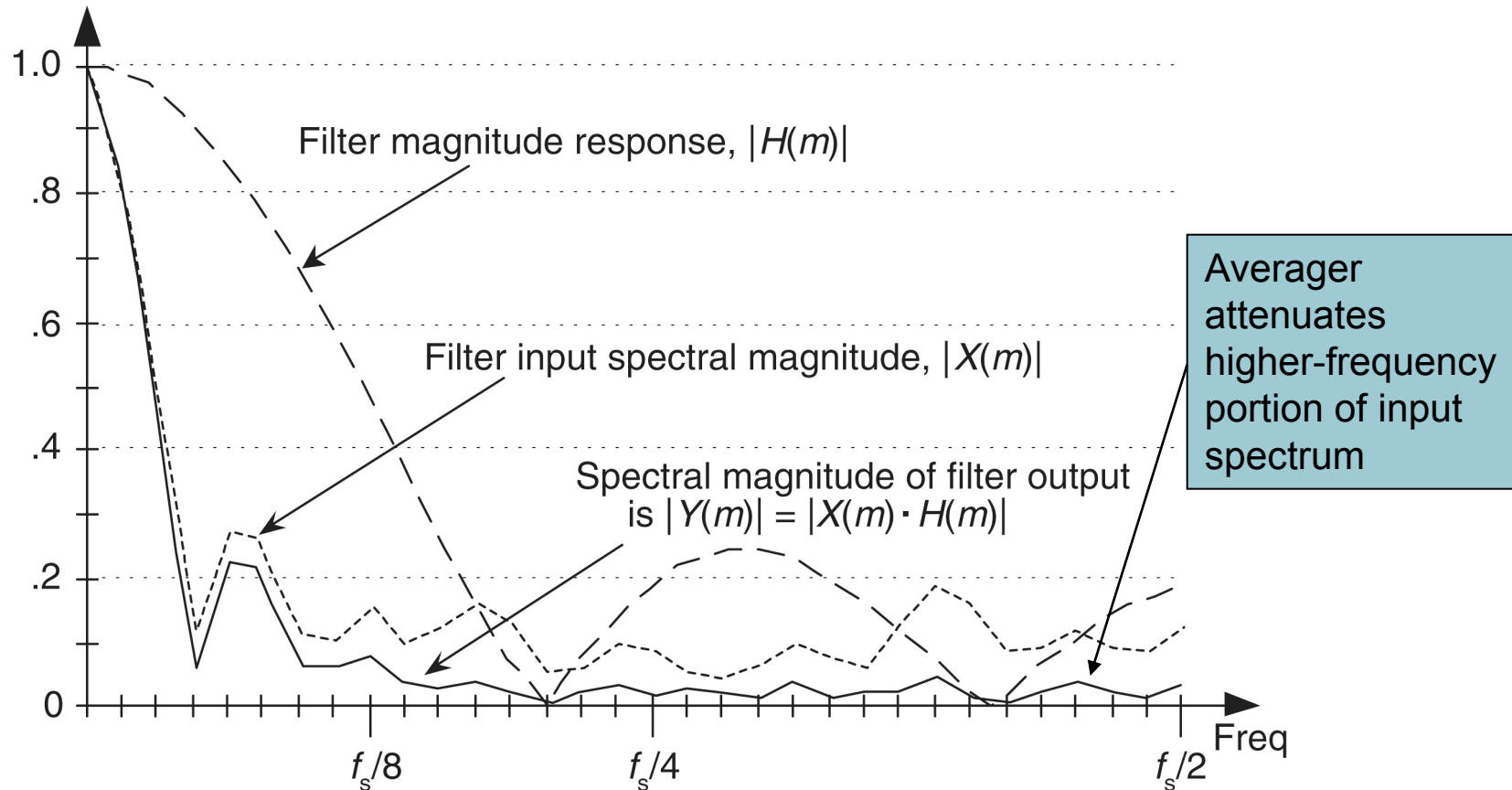

Figure 5-11 Averaging FIR filter input magnitude spectrum, frequency magnitude response, and output magnitude spectrum.

Convolution in FIR Filters

- Summary, so far
 - FIR filters perform time-domain convolution by summing the products of the shifted input samples and a sequence of filter coefficients
 - An FIR filter's output sequence is equal to convolution of input sequence and a filter's impulse response (coefficients)
 - An FIR filter's frequency response is DFT of filter's impulse response
 - An FIR filter's output spectrum is product of input spectrum and filter's frequency response
 - Convolution in time domain and multiplication in frequency domain are Fourier transform pairs

Convolution in FIR Filters

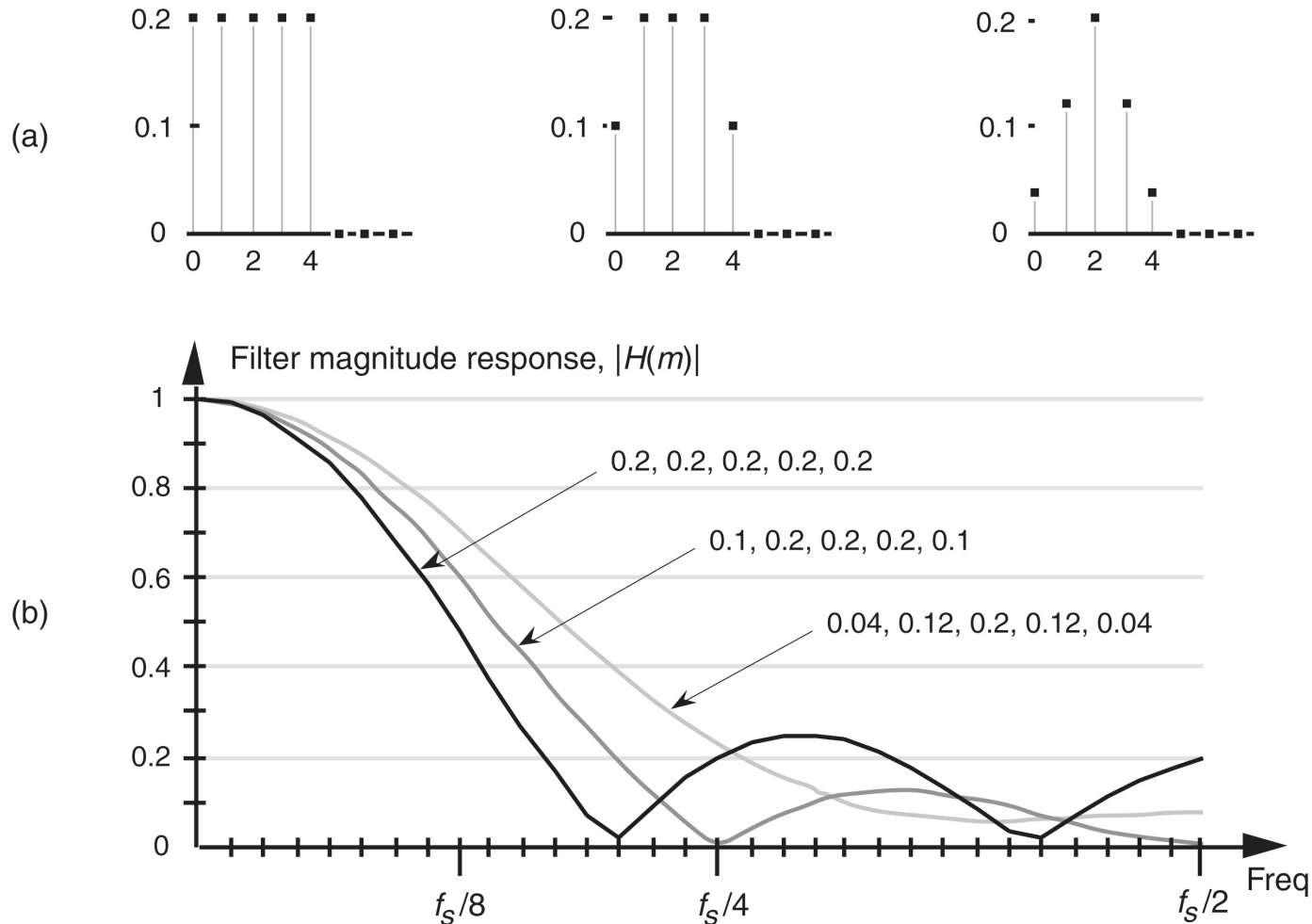

Figure 5-12 Three sets of 5-tap lowpass filter coefficients: (a) sets of coefficients: 0.2, 0.2, 0.2, 0.2, 0.2; 0.1, 0.2, 0.2, 0.2, 0.1; and 0.04, 0.12, 0.2, 0.12, 0.04; (b) frequency magnitude response of three lowpass FIR filters using those sets of coefficients.

Convolution in FIR Filters

■ Fig. 5-12

- Different sets of coefficients give us different frequency magnitude responses
- A sudden change in values of coefficient sequence, such as 0.2 to 0 transition in the first coefficient set, causes ripples, or sidelobes, in frequency response
- If we minimize suddenness of changes in coefficient values, such as the third set of coefficients in (a), we reduce sidelobe ripples in frequency response
 - However, reducing sidelobes results in increasing main lobe width of lowpass filter

Convolution in FIR Filters

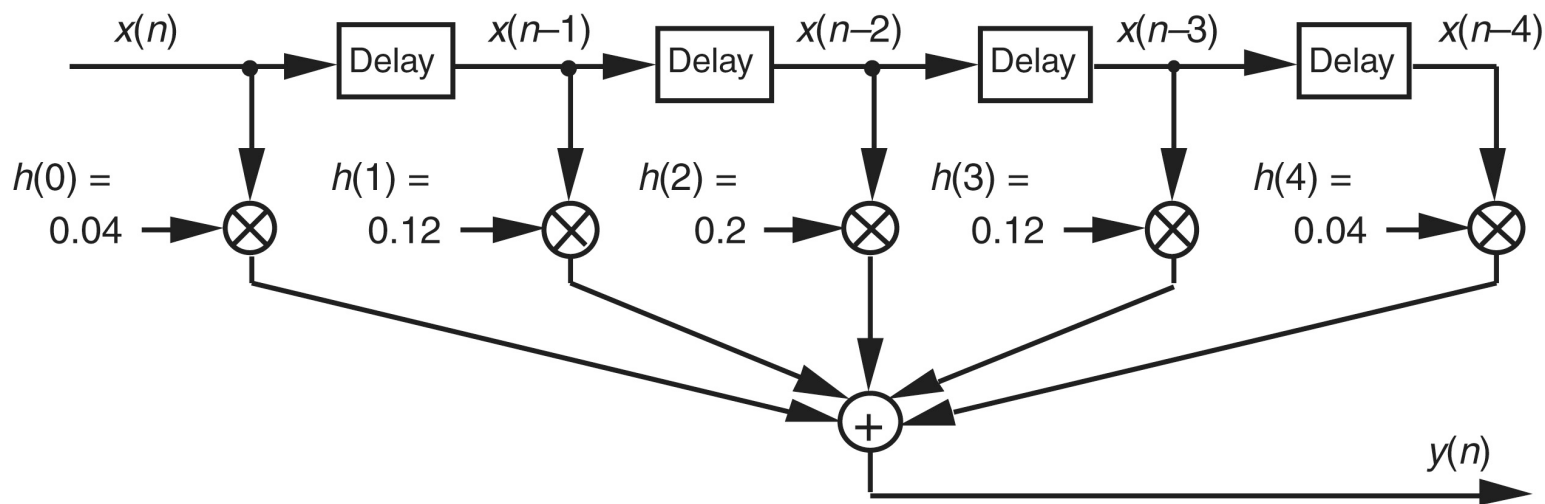

Figure 5-13 Five-tap lowpass FIR filter implementation using the coefficients 0.04, 0.12, 0.2, 0.12, and 0.04.

- We can have a filter with more than 5 taps
 - But input signal sample shifting, multiplications by constant coefficients, and summation are all there is to it

Lowpass FIR Filter Design

- Design of a lowpass FIR filter
 - Design procedure starts with determination of a *desired* frequency response followed by calculating filter coefficients that will give us that response
 - There are two predominant techniques used to design FIR filters
 - 1) window method
 - 2) optimum method

Lowpass FIR Filter Design

- Window design method
 - Begins with our deciding what frequency response we want for our lowpass filter
 - We can start by considering a continuous lowpass filter, and simulating that filter with a digital filter
 - We define the continuous frequency response $H(f)$ to be ideal, i.e., a lowpass filter with unity gain at low frequencies and zero gain (infinite attenuation) beyond some *cutoff frequency*, as shown in Fig. 5-14(a)
 - Representing this $H(f)$ response by a discrete frequency response is the same—with one difference: discrete frequency-domain representations are always periodic with the period being f_s

Lowpass FIR Filter Design

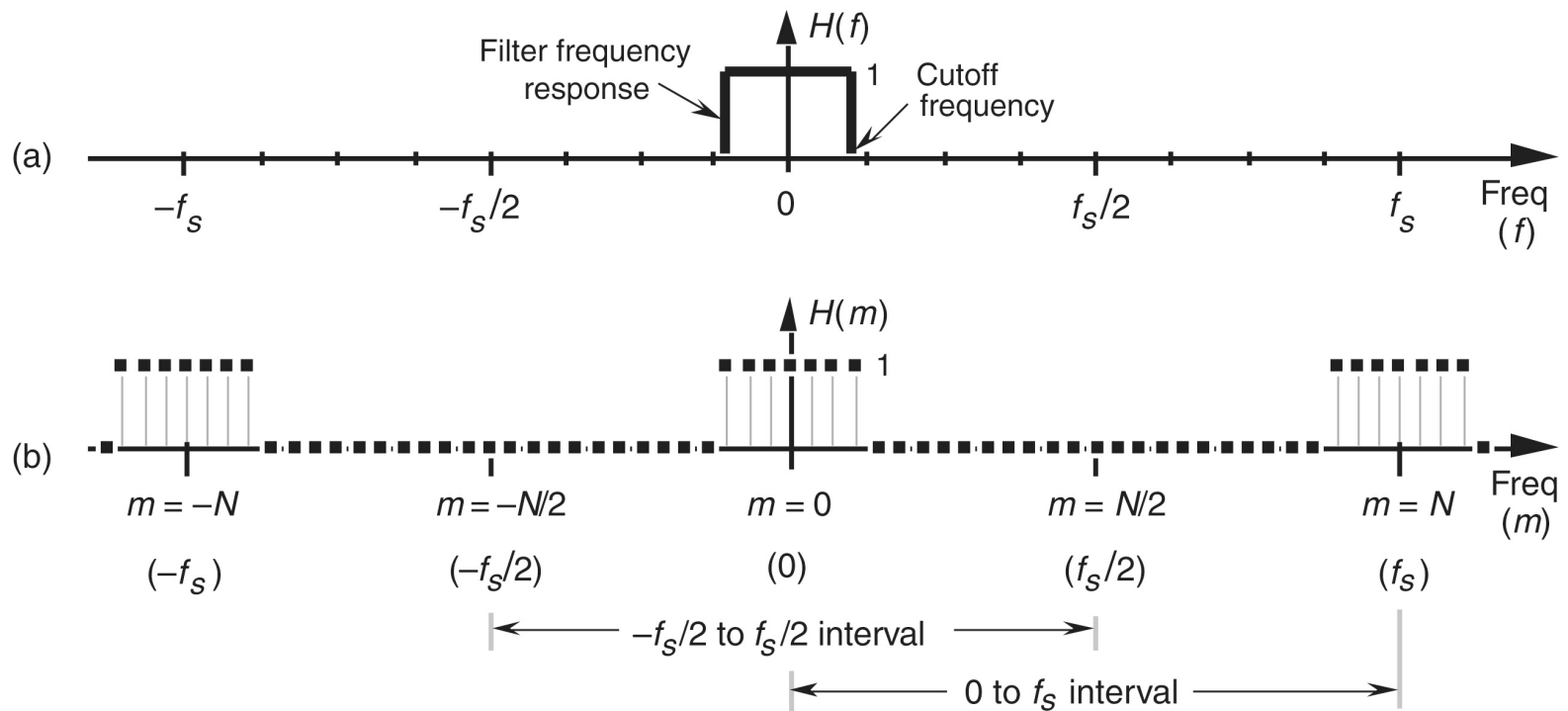

Figure 5-14 Lowpass filter frequency responses: (a) continuous frequency response $H(f)$; (b) periodic, discrete frequency response $H(m)$.

Lowpass FIR Filter Design

- Window design method
 - We have two ways to determine lowpass filter's time-domain coefficients
 - The first way is algebraic
 - 1. Develop an expression for discrete frequency response $H(m)$
 - 2. Apply that expression to inverse DFT equation to get time domain $h(k)$
 - 3. Evaluate that $h(k)$ expression as a function of time index k
 - The second method is to define individual frequency-domain samples representing $H(m)$ and then have a software routine perform inverse DFT of those samples, giving FIR filter coefficients

Lowpass FIR Filter Design

- Window design method
 - In either method, we need only define the periodic $H(m)$ over a single period of f_s Hz
 - Defining $H(m)$ in Fig. 5-14(b) over frequency span $-f_s/2$ to $f_s/2$ is the easiest form to analyze algebraically
 - Defining $H(m)$ over frequency span 0 to f_s is the best representation if we use inverse DFT to obtain filter's coefficients

Lowpass FIR Filter Design

- Algebraic method

- We can define an arbitrary discrete frequency response $H(m)$ using N samples to cover $-f_s/2$ to $f_s/2$ and establish K unity-valued samples for the passband of lowpass filter as shown in Fig. 5-15

$$h(k) = \frac{1}{N} \sum_{m=-(N/2)+1}^{N/2} H(m) e^{j2\pi mk/N}$$

$$h(k) = \frac{1}{N} \cdot \frac{\sin(\pi k K / N)}{\sin(\pi k / N)}$$

- A great deal of algebraic manipulation is required here that digital filter designers avoid performing IDFT algebraically

Lowpass FIR Filter Design

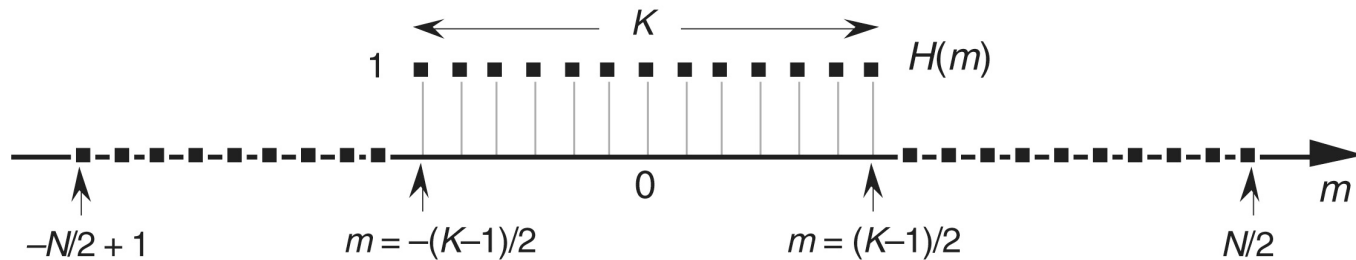

Figure 5-15 Arbitrary, discrete lowpass FIR filter frequency response defined over N frequency-domain samples covering the frequency range of f_s Hz.

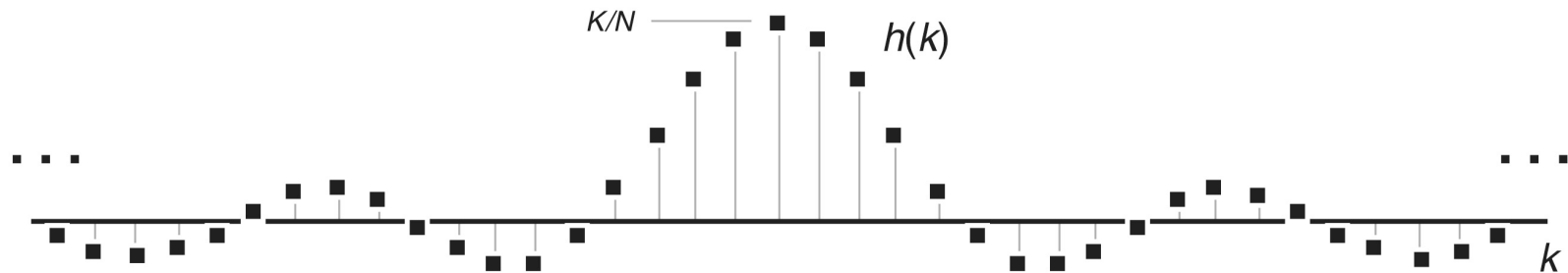

Figure 5-16 Time-domain $h(k)$ coefficients obtained by evaluating Eq. (5-10).

Lowpass FIR Filter Design

- Software IDFT method of FIR filter design

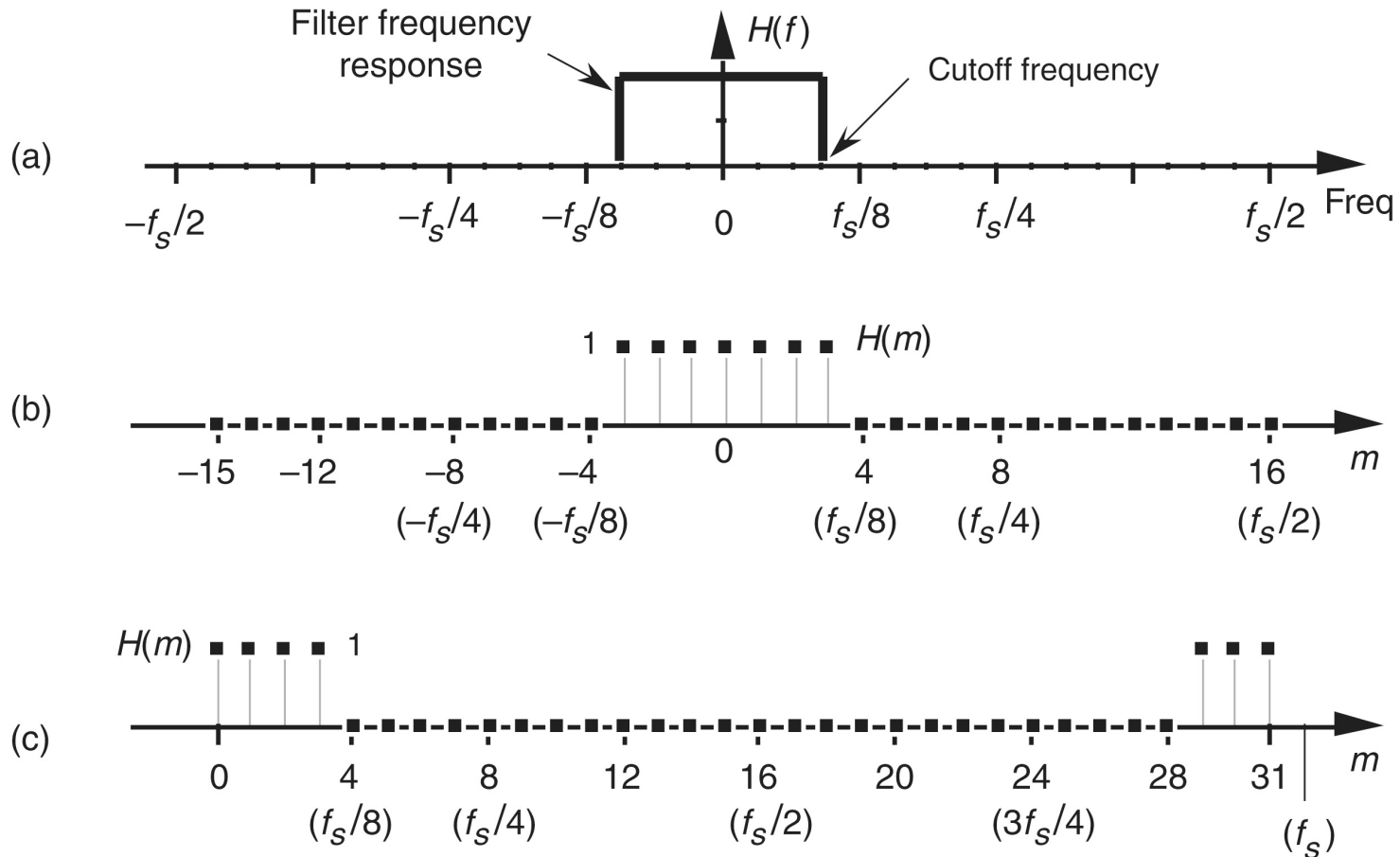

Figure 5-17 An ideal lowpass filter: (a) continuous frequency response $H(f)$; (b) discrete response $H(m)$ over the range $-f_s/2$ to $f_s/2$ Hz; (c) discrete response $H(m)$ over the range 0 to f_s Hz.

Lowpass FIR Filter Design

- Software IDFT method of FIR filter design
 - Using a 32-point inverse FFT to implement a 32-point inverse DFT of $H(m)$ sequence in Fig. 5-17(c), we get 32 $h(k)$ values from $k = -15$ to $k = 16$ in Fig. 5-18(a)
 - Because we want final 31-tap $h(k)$ filter coefficients to be symmetrical with their peak value in center of coefficient sample set, we drop $k = 16$ sample and shift k index to left from Fig. 5-18(a), giving us the desired $\sin(x)/x$ form of $h(k)$ as shown in Fig. 5-18(b)
 - This shift of index k will not change frequency magnitude response of FIR filter

Lowpass FIR Filter Design

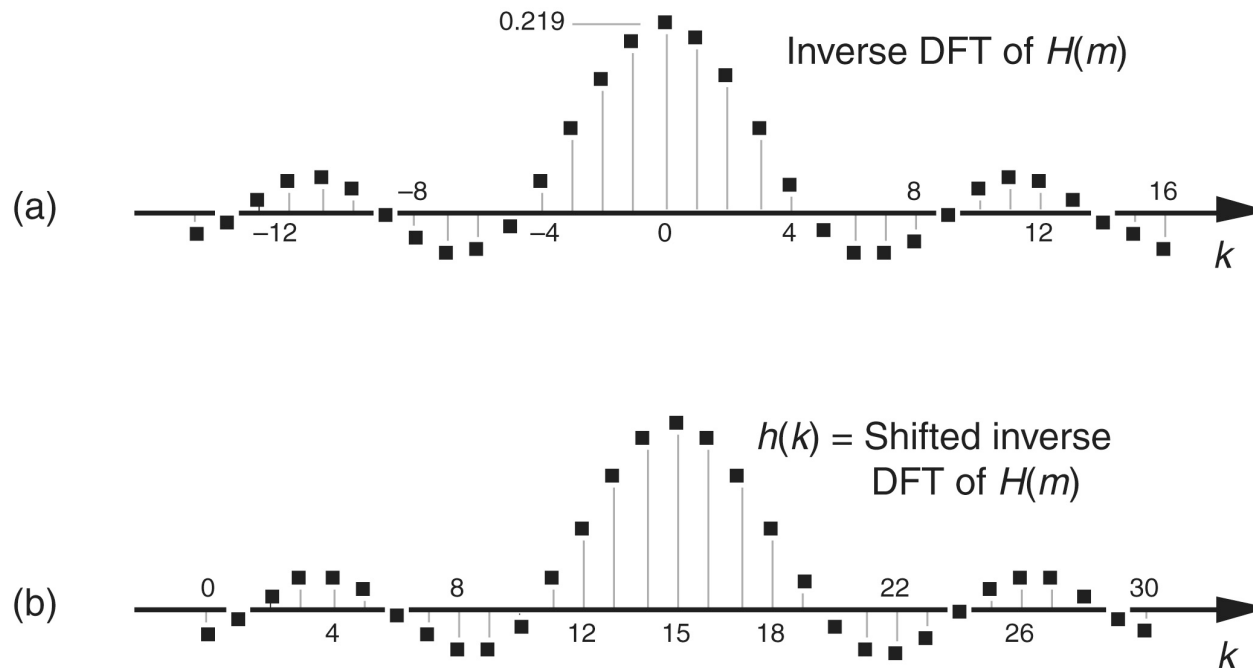

Figure 5-18 Inverse DFT of the discrete response in Figure 5-17(c): (a) normal inverse DFT indexing for k ; (b) symmetrical coefficients used for a 31-tap lowpass FIR filter.

Lowpass FIR Filter Design

the more $h(k)$ terms we use as filter coefficients, the closer we'll approximate our ideal lowpass filter response

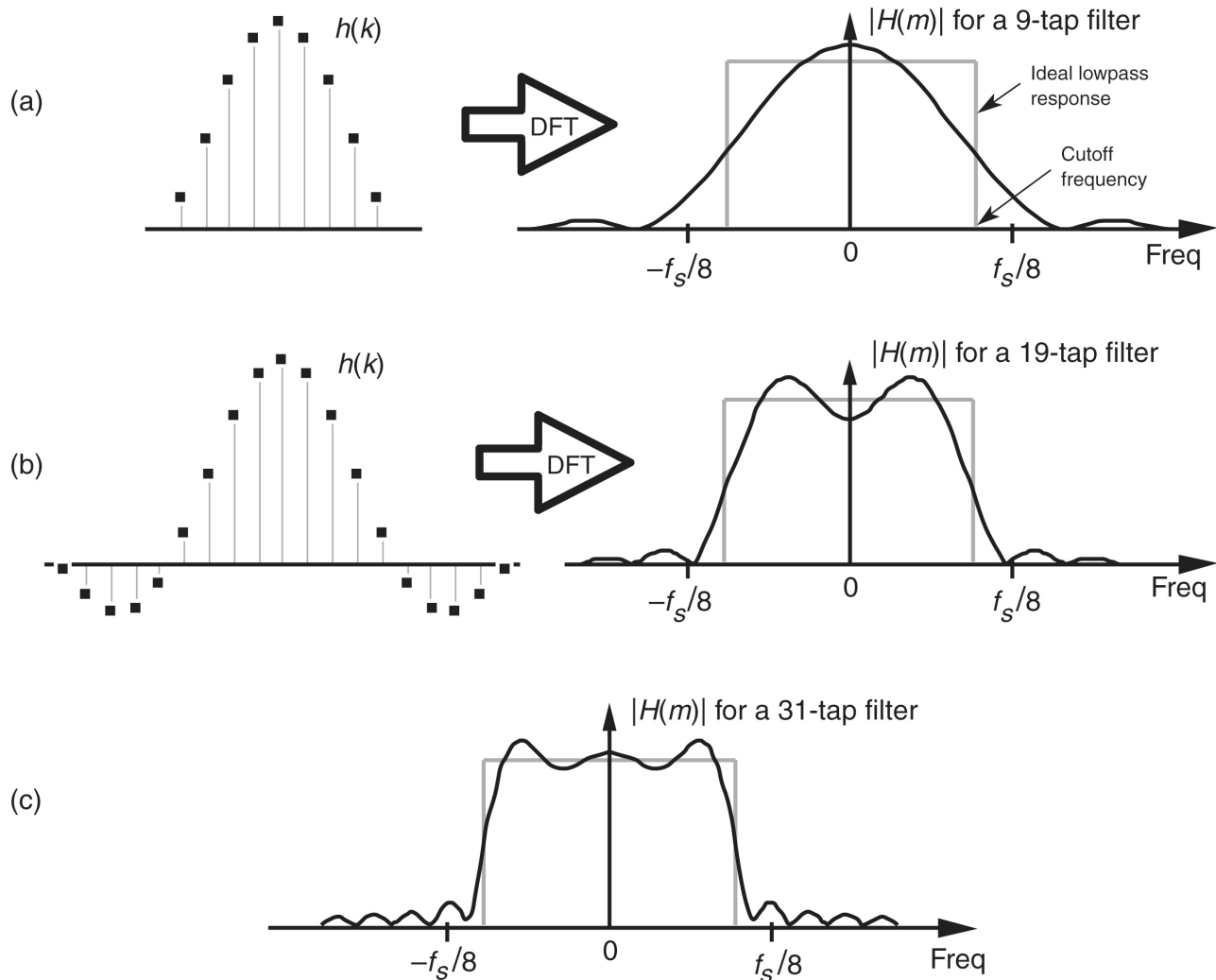

Figure 5-19 Coefficients and frequency responses of three lowpass filters: (a) 9-tap FIR filter; (b) 19-tap FIR filter; (c) frequency response of the full 31-tap FIR filter.

Lowpass FIR Filter Design

- Why are passband ripples in lowpass FIR filter response in Fig. 5-19

$$\begin{array}{ccc} h(k) * x(n) & \xrightarrow{\text{DFT}} & H(m) \cdot X(m) \\ & \xleftarrow{\text{IDFT}} & \\ h(k) \cdot x(n) & \xrightarrow{\text{DFT}} & H(m) * X(m) \\ & \xleftarrow{\text{IDFT}} & \end{array}$$

- Replacing $h(k)$ and $x(n)$ with $h^\infty(k)$ and $w(k)$

$$\begin{array}{ccc} h^\infty(k) \cdot w(k) & \xrightarrow{\text{DFT}} & H^\infty(m) * W(m) \\ & \xleftarrow{\text{IDFT}} & \end{array}$$

- $h^\infty(k)$ represents an infinitely long $\sin(x)/x$ sequence of ideal lowpass FIR filter coefficients
- $w(k)$ represents a window sequence that we use to truncate $\sin(x)/x$ terms

Lowpass FIR Filter Design

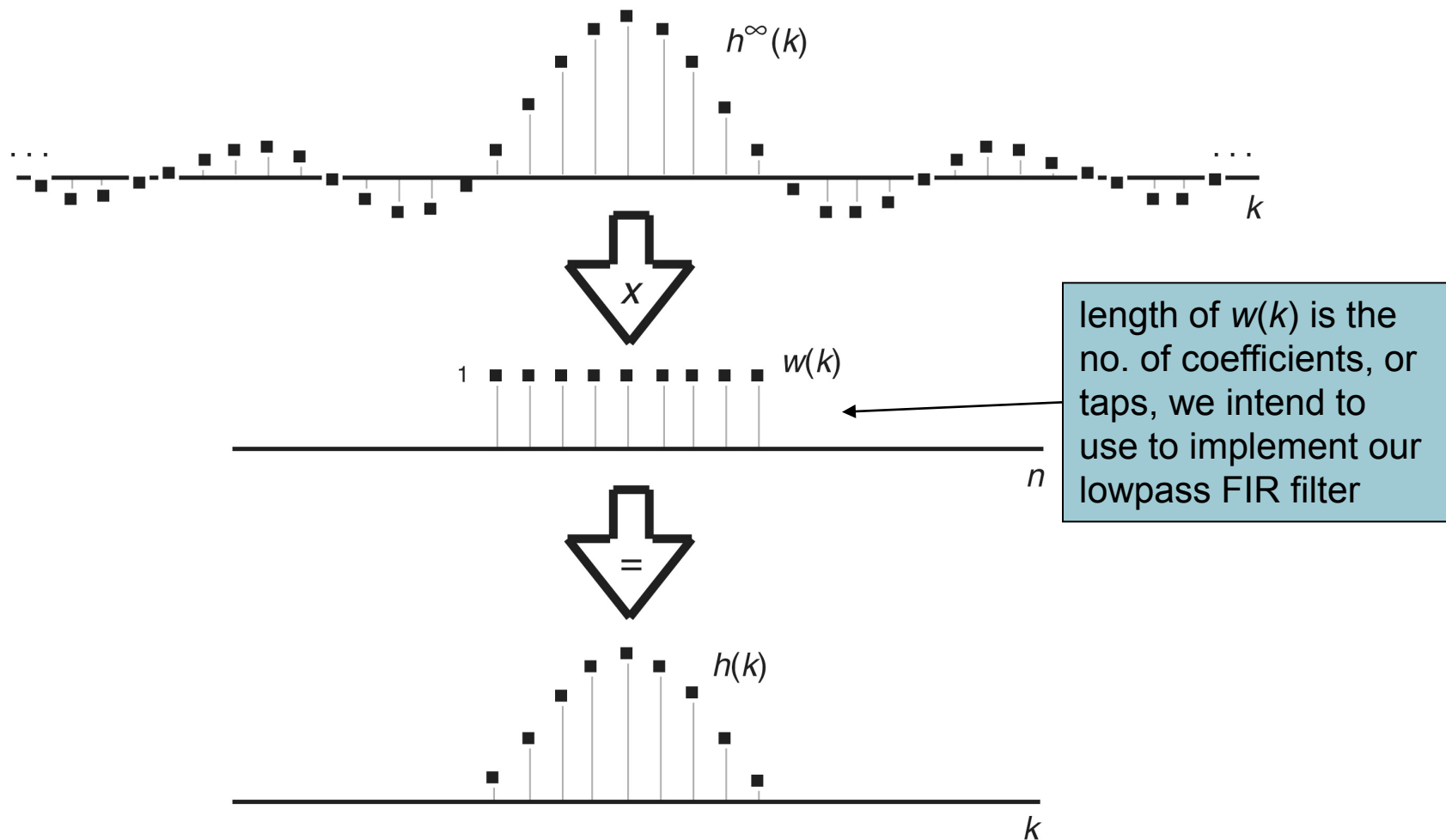

Figure 5-20 Infinite $h^\infty(k)$ sequence windowed by $w(k)$ to define the final filter coefficients $h(k)$.

Lowpass FIR Filter Design

with a $W(m)$ frequency shift of 0 Hz, sum of $W(m)$ samples that overlap $H^\infty(m)$ rectangle is the value of $H(m)$ at 0 Hz

sum of positive and negative $W(m)$ samples under $H^\infty(m)$ rectangle varies as $W(m)$ is shifted \rightarrow ripples in passband

peak of $W(m)$'s main lobe is outside $H^\infty(m)$ rectangle \rightarrow $H(m)$'s passband begins to roll off

as $W(m)$ shift continues, ripples in $H(m)$ beyond the positive cutoff frequency

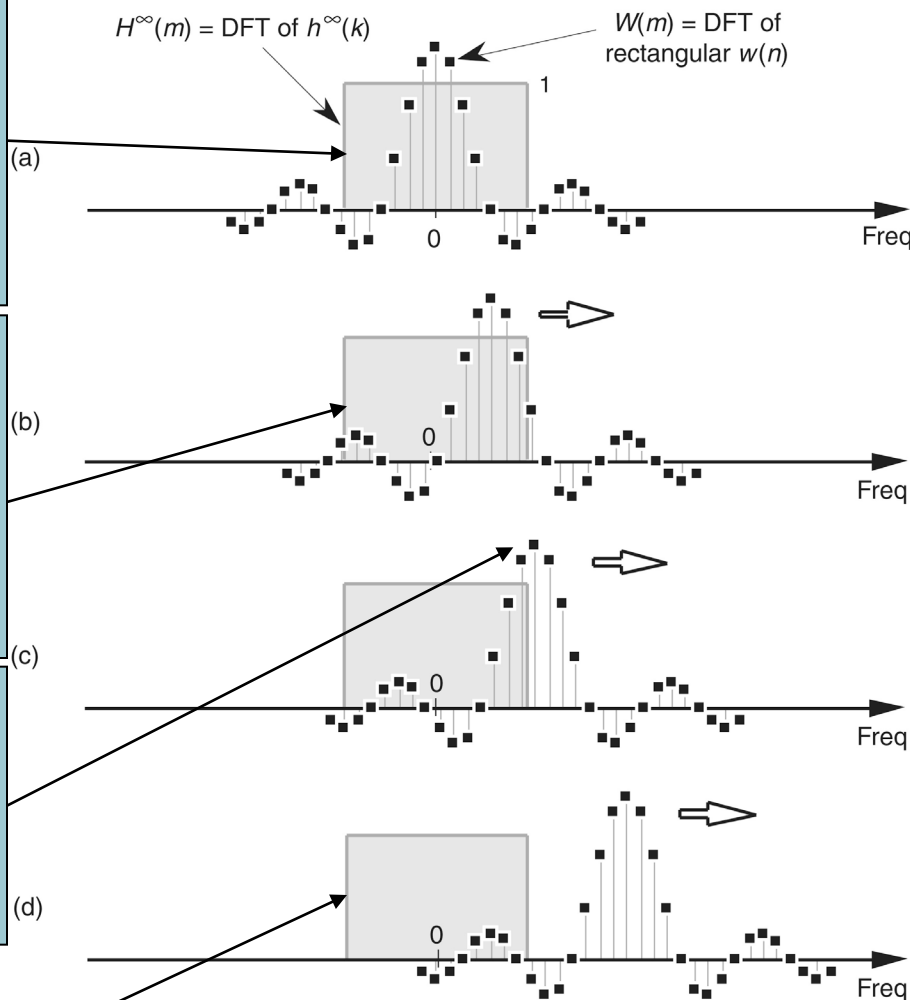

FIR filter's true frequency response is $H(m) = H^\infty(m) * W(m)$

we can view a particular sample value of $H(m) = H^\infty(m) * W(m)$ convolution as being sum of products of $H^\infty(m)$ and $W(m)$ for a particular frequency shift of $W(m)$

unity for all of $H^\infty(m) \rightarrow$ a particular $H(m)$ value is sum of $W(m)$ samples that overlap $H^\infty(m)$ rectangle

ripples in $H(m)$ are caused by sidelobes of $W(m)$

figure 5-21

Convolution $W(m) * H^\infty(m)$: (a) unshifted $W(m)$ and $H^\infty(m)$; (b) shift of $W(m)$ leading to ripples within $H(m)$'s positive-frequency passband; (c) shift of $W(m)$ causing response roll-off near $H(m)$'s positive cutoff frequency; (d) shift of $W(m)$ causing ripples beyond $H(m)$'s positive cutoff frequency.

Lowpass FIR Filter Design

- How many $\sin(x)/x$ coefficients do we have to use (or how wide must $w(k)$ be) to get nice sharp falling edges and no ripples in $H(m)$ passband?
 - As long as $w(k)$ is a finite number of unity values (i.e., a rectangular window of finite width), there will be sidelobe ripples in $W(m)$, and this will induce passband ripples in final $H(m)$ frequency response

Lowpass FIR Filter Design

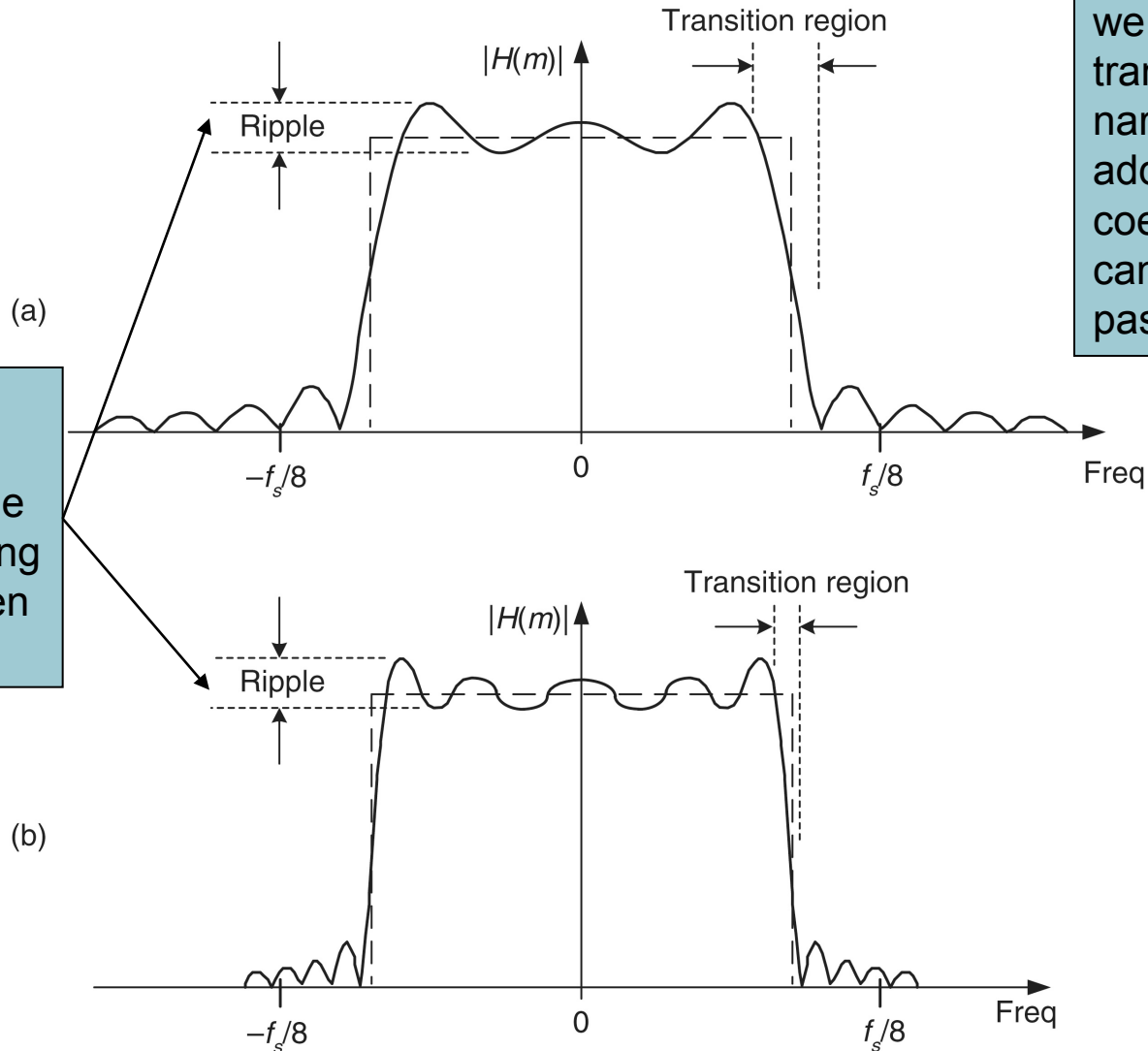

we can make filter's transition region narrower using additional $h(k)$ filter coefficients, but we cannot eliminate passband ripple

a wider $w(k)$ does not even reduce peak-to-peak ripple magnitudes, as long as $w(k)$ has sudden discontinuities

Figure 5-22 Passband ripple and transition regions: (a) for a 31-tap lowpass filter; (b) for a 63-tap lowpass filter.

Lowpass FIR Filter Design

- Gibbs's phenomenon
 - The ripple is known as Gibbs's phenomenon, which manifests itself anytime a function ($w(k)$ in this case) with an instantaneous discontinuity is represented by a Fourier series
 - No finite set of sinusoids will be able to change fast enough to be exactly equal to an instantaneous discontinuity
 - No matter how wide $w(k)$ window is, $W(m)$ will always have sidelobe ripples

Lowpass FIR Filter Design

- Windows used in FIR filter design
 - We can minimize FIR passband ripple with window functions the same way we minimized DFT leakage
 - Window FIR design method is the technique of reducing $w(k)$'s discontinuities by using window functions other than rectangular window

Lowpass FIR Filter Design

Blackman window function :

$$w(k) = 0.42 - 0.5 \cos\left(\frac{2\pi k}{N-1}\right) + 0.08 \cos\left(\frac{4\pi k}{N-1}\right)$$

for $k = 0, 1, 2, \dots, N-1$

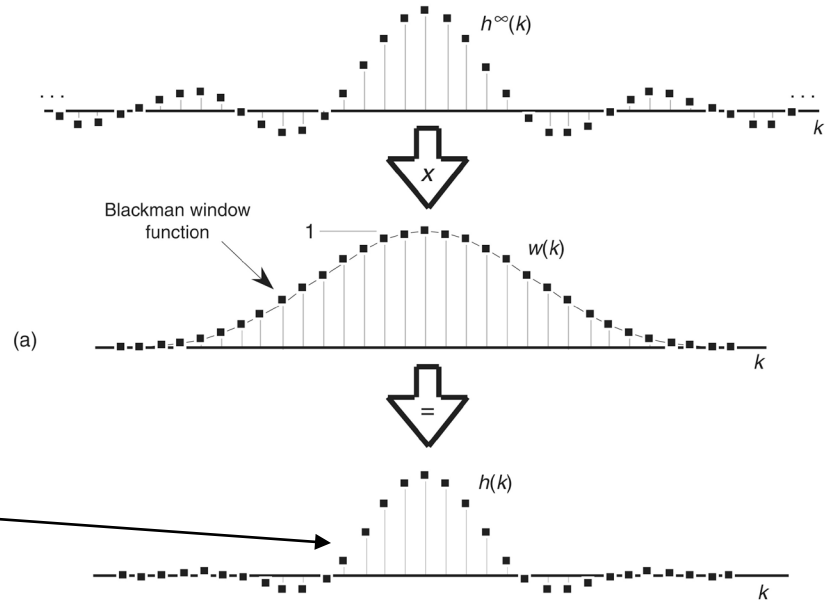

smoothly tapered $h(k)$ coefficients

passband ripples are greatly reduced

the price we paid for reduced passband ripple is a wider $H(m)$ transition region

we can get a steeper filter response roll-off by increasing the no. of taps in FIR filter (we should use a 63-coefficient Blackman window for a 63-tap FIR filter)

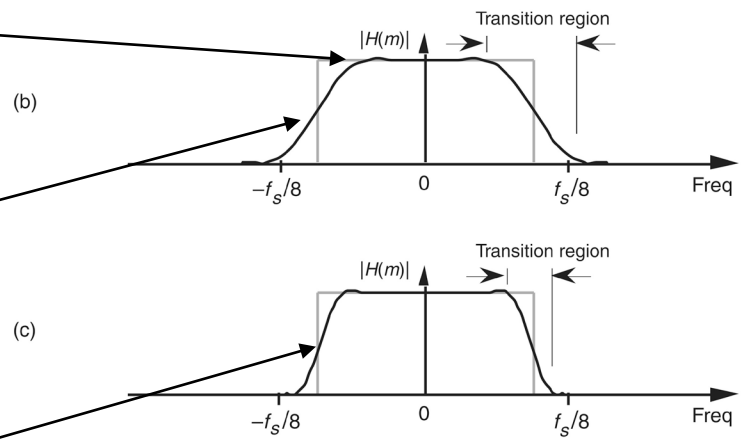
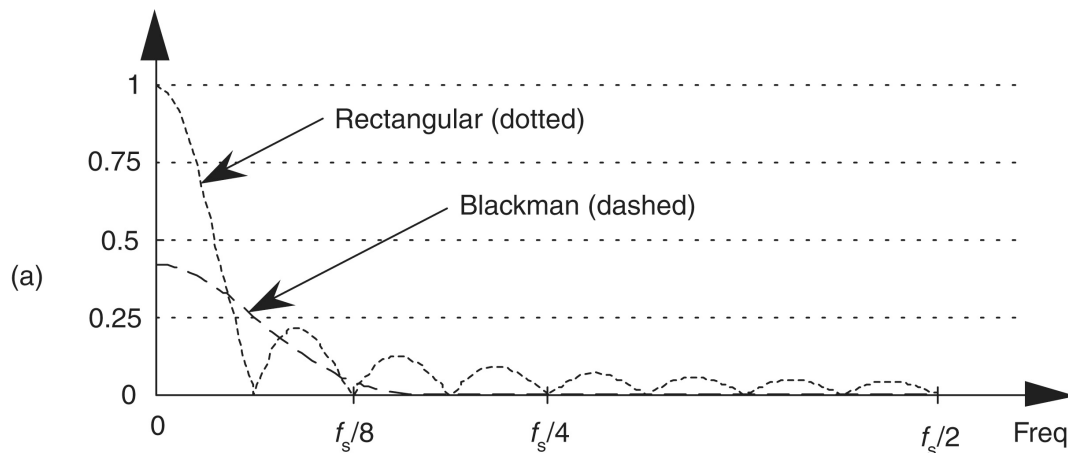
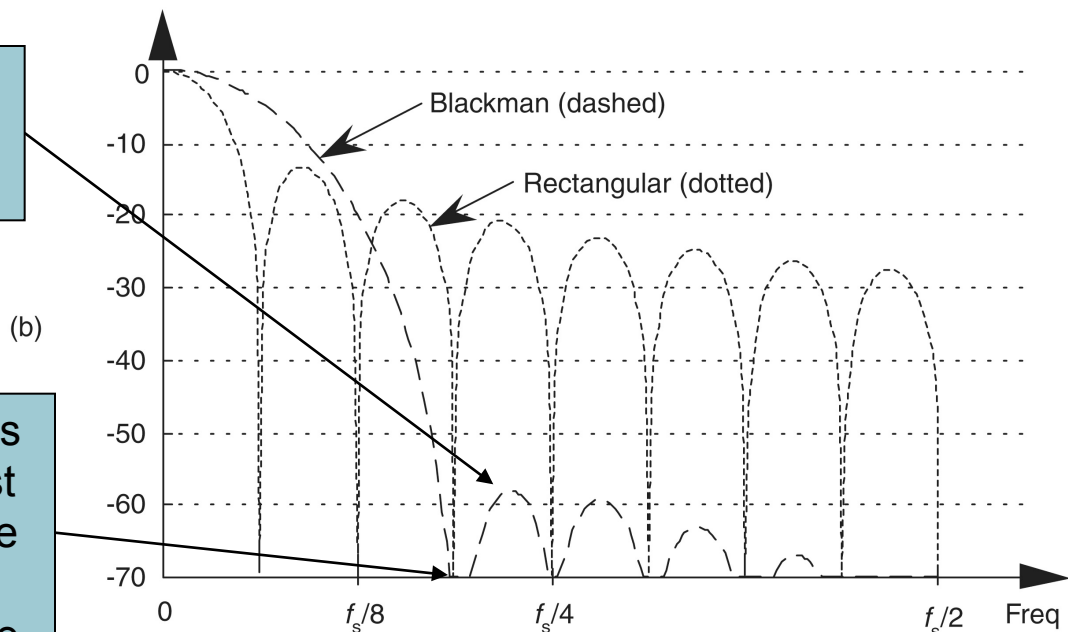

Figure 5-23 Coefficients and frequency response of a 31-tap Blackman-windowed FIR filter: (a) defining the windowed filter coefficients $h(k)$; (b) low-ripple 31-tap frequency response; (c) low-ripple 63-tap frequency response.

Lowpass FIR Filter Design



greatly reduced
sidelobe levels of
Blackman window



Blackman window's
main lobe is almost
three times as wide
as rectangular
window's main lobe

Figure 5-24 Rectangular versus Blackman window frequency magnitude responses: (a) $|W(m)|$ on a linear scale; (b) normalized logarithmic scale of $W_{dB}(m)$.

Lowpass FIR Filter Design

- Summary of window method of FIR filter design
 - We pick a window function and multiply it by $\sin(x)/x$ values from $h^\infty(k)$ to get our final $h(k)$ filter coefficients

Lowpass FIR Filter Design

- Window functions with more control over their frequency responses
 - There are two window functions with more flexibility in trading off the window's main lobe width and sidelobe levels
 - Chebyshev and Kaiser window functions

Lowpass FIR Filter Design

Chebyshev window :

$$w(k) = \text{the } N\text{-point inverse DFT of } \frac{\cos \left[N \cdot \cos^{-1} \left[\alpha \cdot \cos \left(\frac{\pi m}{N} \right) \right] \right]}{\cosh \left[N \cdot \cosh^{-1} (\alpha) \right]}$$

where $\alpha = \cosh \left(\frac{1}{N} \cosh^{-1} (10^{\gamma}) \right)$ and $m = 0, 1, 2, \dots, N$

Kaiser window :

$$w(k) = \frac{I_0 \left[\beta \sqrt{1 - \left(\frac{k-p}{p} \right)^2} \right]}{I_0(\beta)}$$

for $k = 0, 1, 2, \dots, N-1$ and $p = (N-1)/2$

where $I_0(x)$ zeroth - order Bessel function values can be approximated using

$$I_0(x) = \sum_{q=0}^{24} \frac{x^{2q}}{4^q \cdot (q!)^2}$$

γ and β control parameters give us control over Chebyshev and Kaiser windows' main lobe widths and sidelobe levels

Lowpass FIR Filter Design

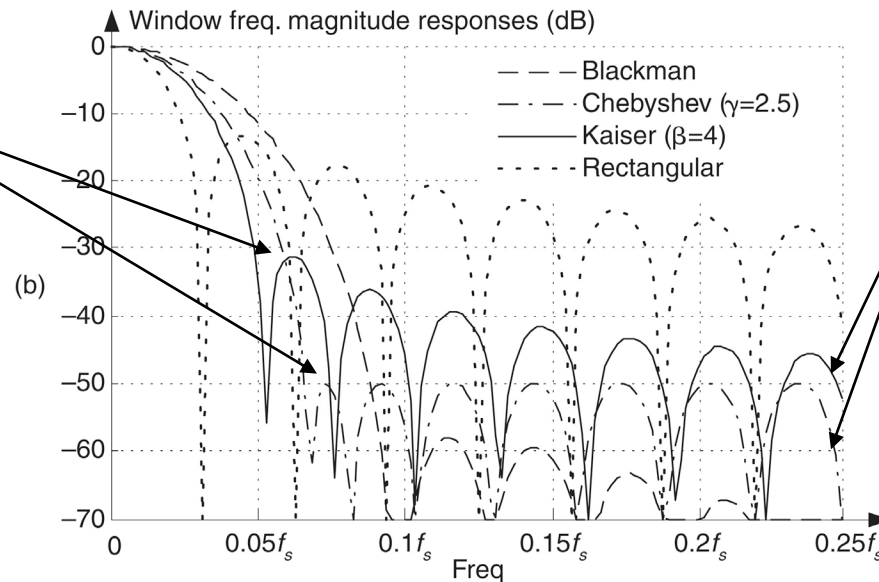
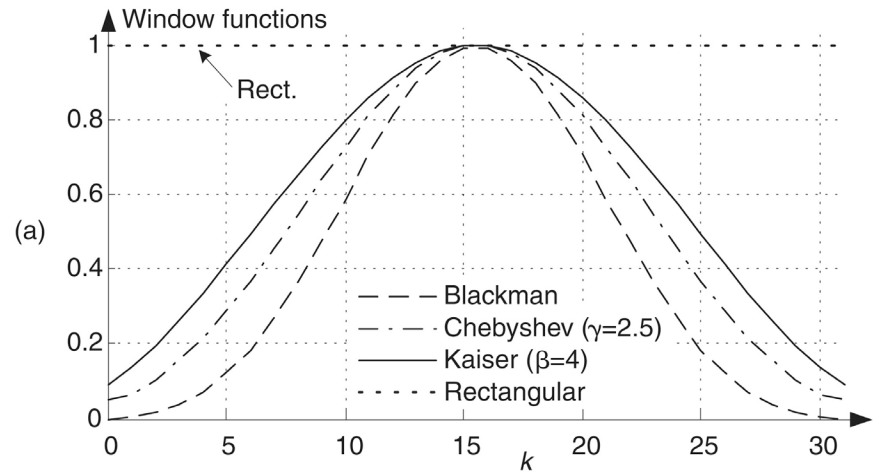

Kaiser sidelobes are higher than Chebyshev window's sidelobes near main lobe

unlike the constant sidelobe peak levels of Chebyshev window, Kaiser window's sidelobes decrease with increased frequency

Figure 5-25 Typical window functions used with digital filters: (a) window coefficients in the time domain; (b) frequency-domain magnitude responses in dB.

Lowpass FIR Filter Design

Selecting different values for γ enables us to adjust sidelobe levels and see what effect those values have on main lobe width

Chebyshev window function's stopband attenuation, in dB
 $Atten_{Cheb} = -20 \gamma$

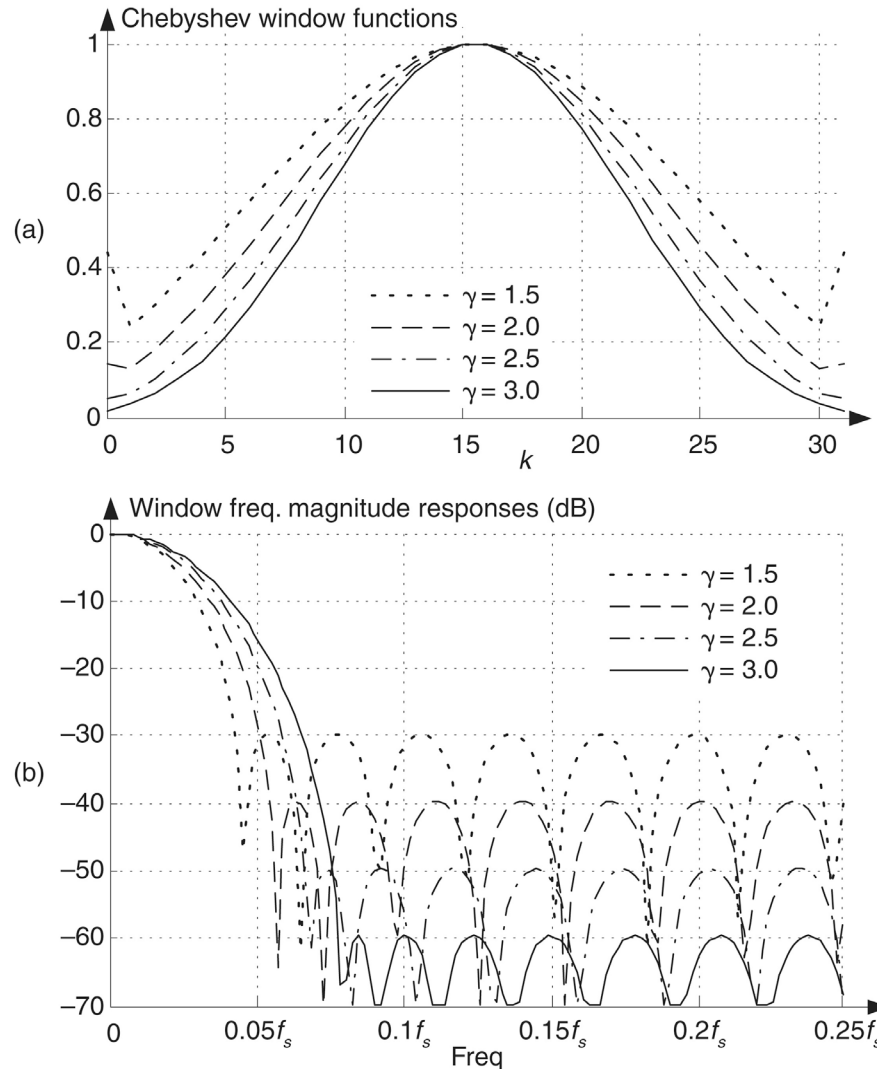

Figure 5-26 Chebyshev window functions for various γ values: (a) window coefficients in the time domain; (b) frequency-domain magnitude responses in dB.

Lowpass FIR Filter Design

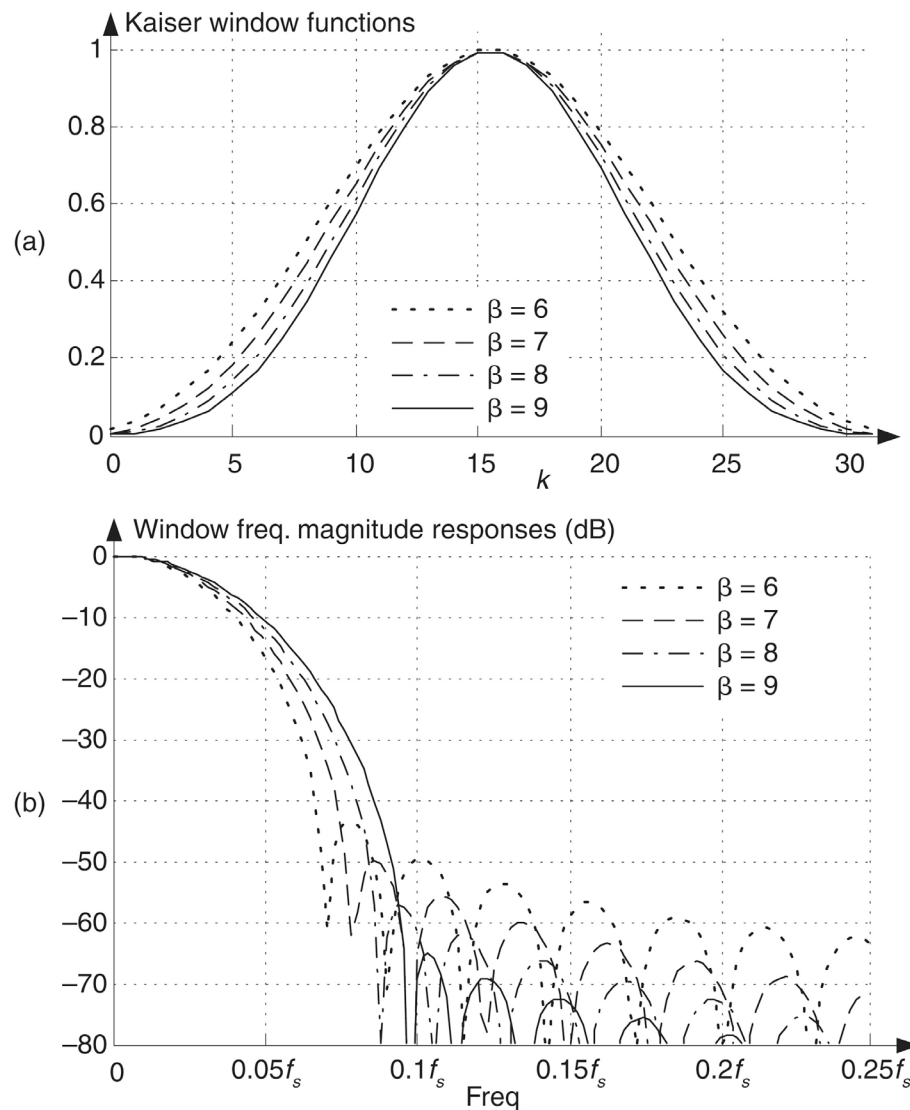

Figure 5-27 Kaiser window functions for various β values: (a) window coefficients in the time domain; (b) frequency-domain magnitude responses in dB.

Lowpass FIR Filter Design

- Chebyshev or Kaiser, which is the best?
 - Depends on the application
 - Digital filter designers typically experiment with various values of γ and β for Chebyshev and Kaiser windows to get the optimum $W_{\text{dB}}(m)$ for a particular application
 - Blackman window's very low sidelobe levels outweigh its wide main lobe in many applications

Bandpass FIR Filter Design

- Bandpass FIR filter design
 - Window method of lowpass FIR filter design can be used as the first step
 - Let's say we want a 31-tap FIR filter with the frequency response shown in Fig. 5-22(a), but instead of being centered about zero Hz, we want filter's passband to be centered about $f_s/4$ Hz
 - If we define a lowpass FIR filter's coefficients as $h_{lp}(k)$, to find $h_{bp}(k)$ coefficients of a bandpass FIR filter, we can shift $H_{lp}(m)$'s frequency response by multiplying $h_{lp}(k)$ lowpass coefficients by a sinusoid of $f_s/4$ Hz ($s_{\text{shift}}(k)$)

Bandpass FIR Filter Design

$h_{lp}(k)$ lowpass coefficients have not been multiplied by any window function. In practice, we'd use an $h_{lp}(k)$ that has been windowed to reduce passband ripple

If we wanted to center bandpass filter's response at some frequency other than $f_s/4$, we need to modify $s_{shift}(k)$ to represent sampled values of a sinusoid whose frequency is equal to the desired bandpass center frequency

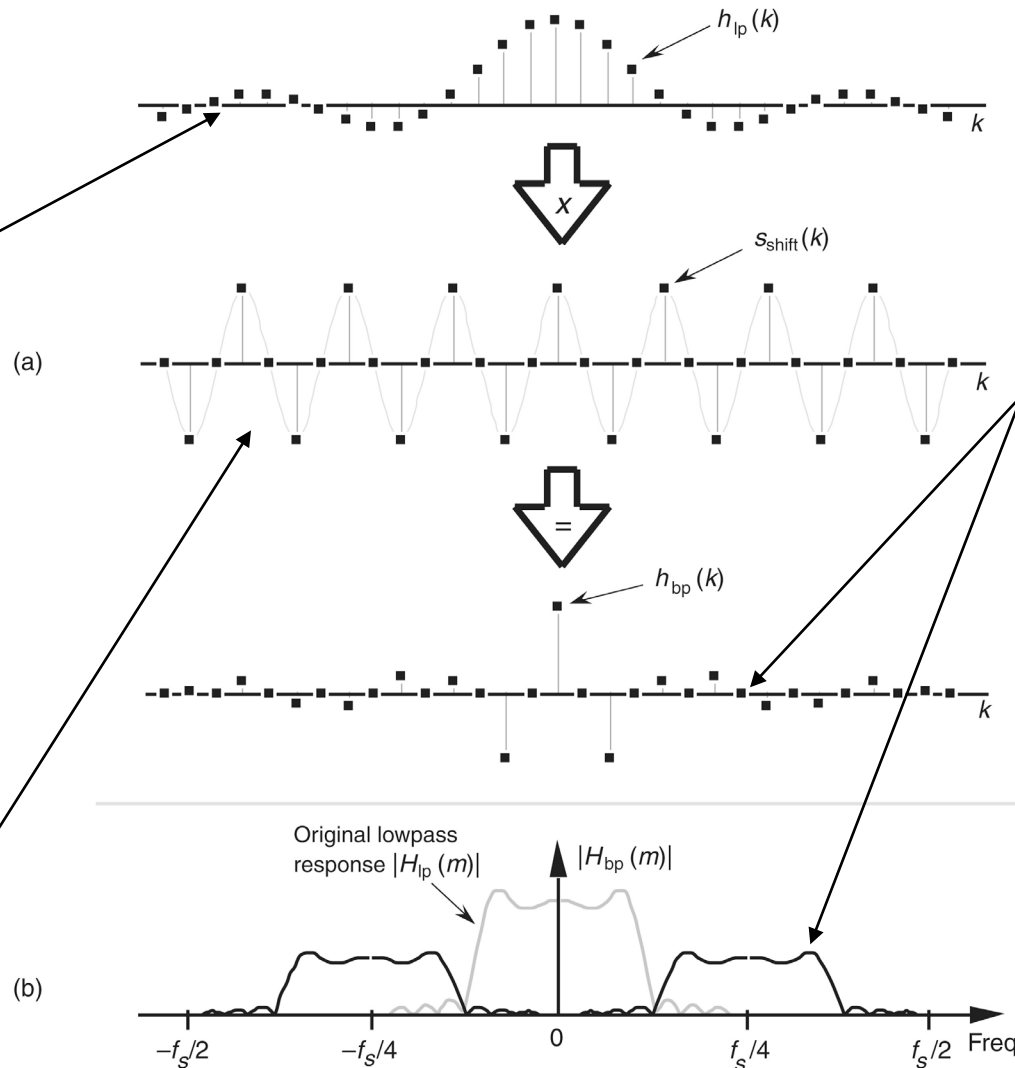

actual magnitude of $|H_{bp}(m)|$ is half that of the original $|H_{lp}(m)|$ because half the values in $h_{bp}(k)$ are zero when $s_{shift}(k)$ corresponds exactly to $f_s/4$

when we design an N -tap bandpass FIR filter centered at a frequency of $f_s/4$ Hz, we only need to perform $N/2$ multiplications for each filter output sample

Figure 5-28 Bandpass filter with frequency response centered at $f_s/4$: (a) generating 31-tap filter coefficients $h_{bp}(k)$; (b) frequency magnitude response $|H_{bp}(m)|$.

Highpass FIR Filter Design

- Highpass FIR filter design
 - We can use the bandpass FIR filter design technique to design a highpass FIR filter
 - To obtain coefficients for a highpass filter, we need only modify the shifting sequence $s_{\text{shift}}(k)$ to make it represent a sampled sinusoid whose frequency is $f_s/2$
 - $h_{\text{hp}}(k) = h_{\text{lp}}(k) \cdot s_{\text{shift}}(k) = h_{\text{lp}}(k) \cdot (1, -1, 1, -1, \text{etc.})$

Highpass FIR Filter Design

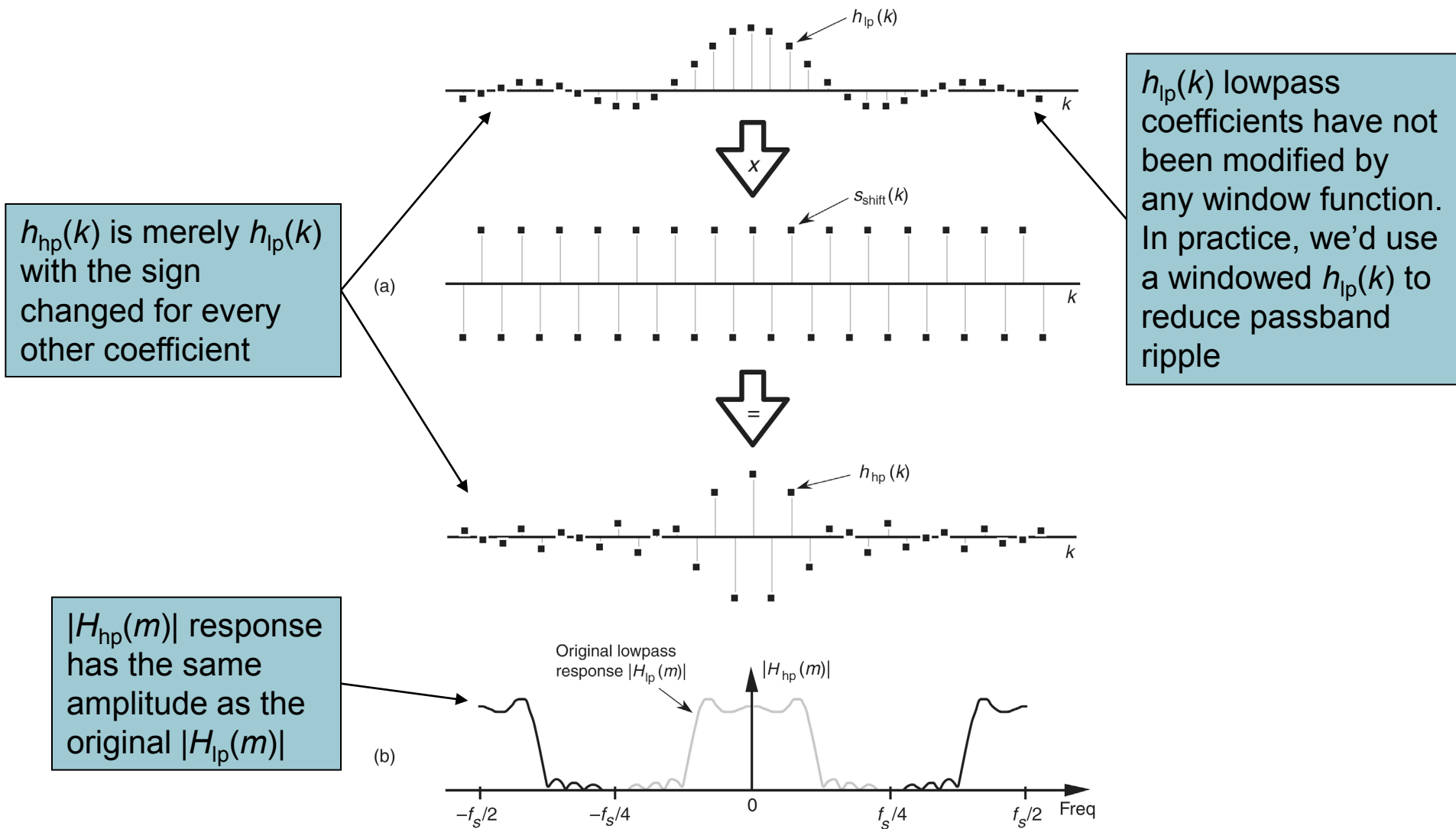
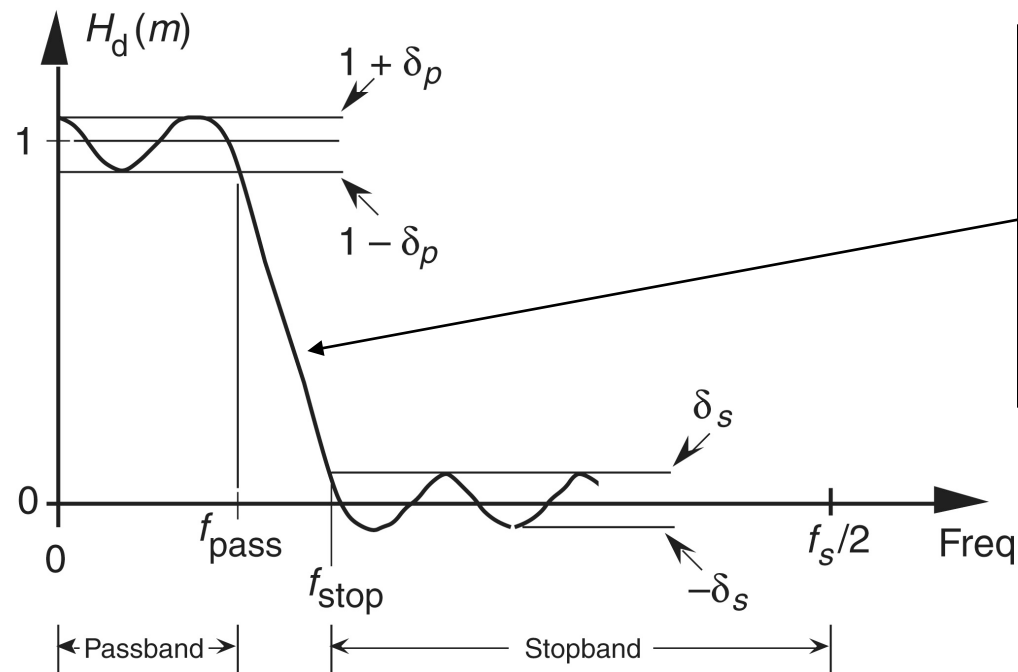

Figure 5-29 Highpass filter with frequency response centered at $f_s/2$: (a) generating 31-tap filter coefficients $h_{hp}(k)$; (b) frequency magnitude response $|H_{hp}(m)|$.

Parks-McClellan Exchange FIR Filter Design Method

- Parks-McClellan FIR filter design method
 - Also called Remez Exchange, or Optimal method
 - A popular technique used to design high-performance FIR filters



to use this method, we have to visualize a desired frequency response $H_d(m)$: we have to establish desired f_{pass} , f_{stop} , $\bar{\delta}_p$ and $\bar{\delta}_s$

Figure 5-30 Desired frequency response definition of a lowpass FIR filter using the Parks-McClellan Exchange design method.

Parks-McClellan Exchange FIR Filter Design Method

■ Parks-McClellan FIR filter design method

- Passband and stopband ripples, in decibels, are related to δ_p and δ_s by

$$\text{Passband ripple} = 20 \cdot \log_{10}(1 + \delta_p)$$

$$\text{Stopband ripple} = -20 \cdot \log_{10}(\delta_s)$$

- Next, we apply these parameters to a software routine that generates the filter's N time-domain $h(k)$ coefficients where N is the minimum number of filter taps to achieve the desired filter response

Parks-McClellan Exchange FIR Filter Design Method

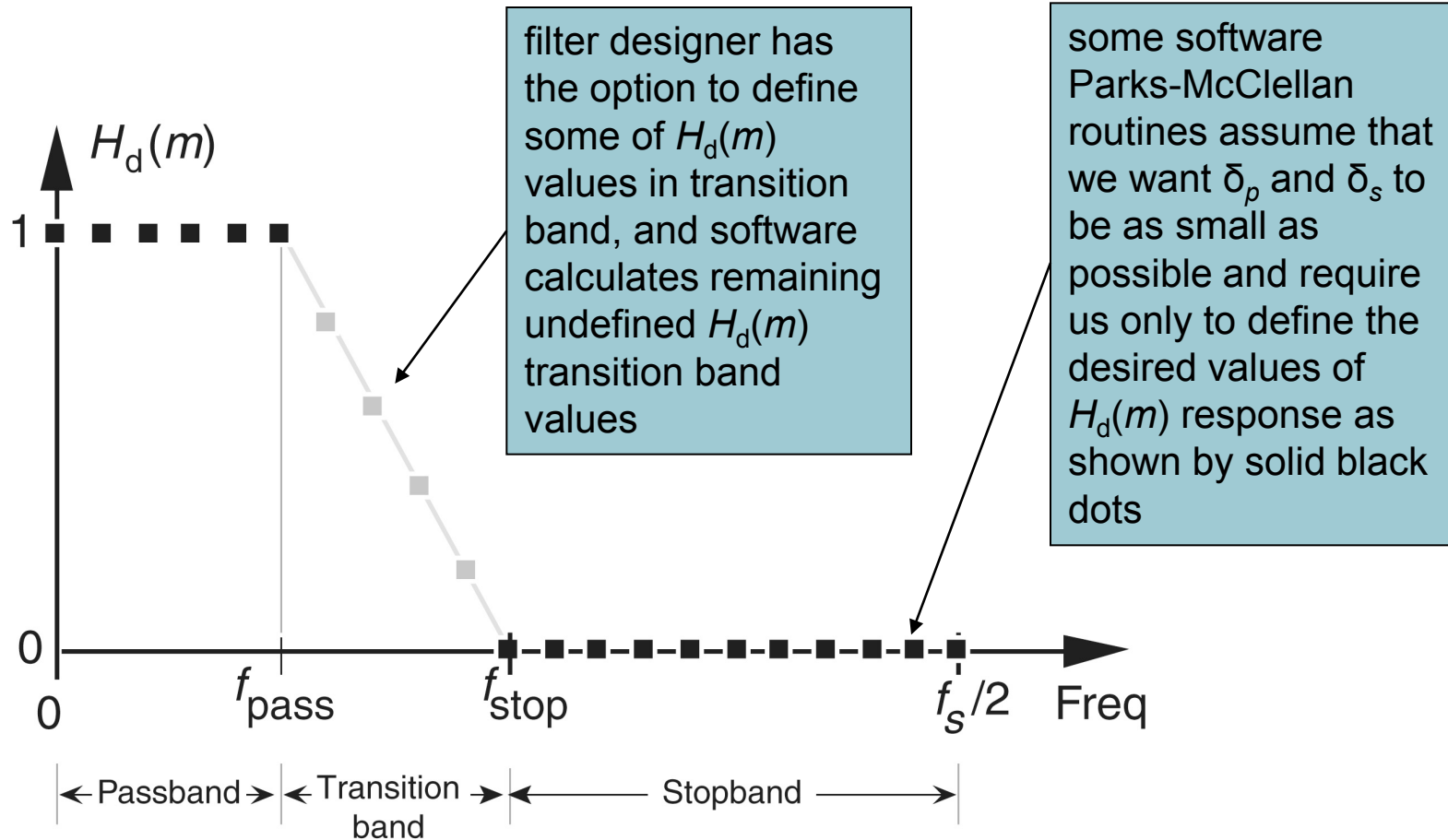

Figure 5-31 Alternate method for defining the desired frequency response of a lowpass FIR filter using the Parks-McClellan Exchange technique.

Parks-McClellan Exchange FIR Filter Design Method

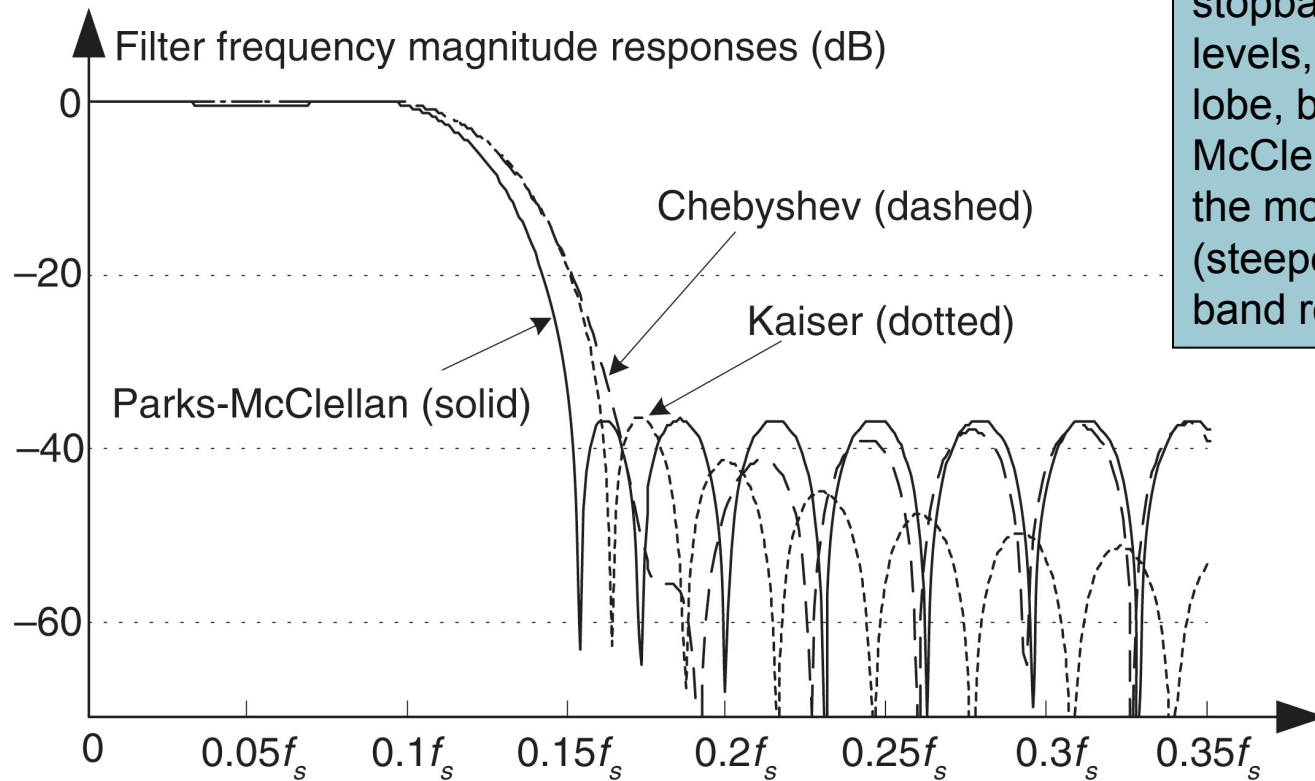

Figure 5-32 Frequency response comparison of three 31-tap FIR filters: Parks-McClellan, Chebyshev windowed, and Kaiser windowed.

Half-band FIR Filters

- Half-band FIR filter

- Very useful in signal decimation and interpolation applications
- Its frequency magnitude response is symmetrical about $f_s/4$ point
 - $f_{\text{pass}} + f_{\text{stop}} = f_s/2$
 - When filter has an odd number of taps, filter's time-domain impulse response has every other filter coefficient being zero, except center coefficient
 - This enables us to avoid approximately half the number of multiplications when implementing this filter
 - For an N -tap half-band FIR filter, we'll only need to perform $(N + 1)/2 + 1$ multiplications per output sample

Half-band FIR Filters

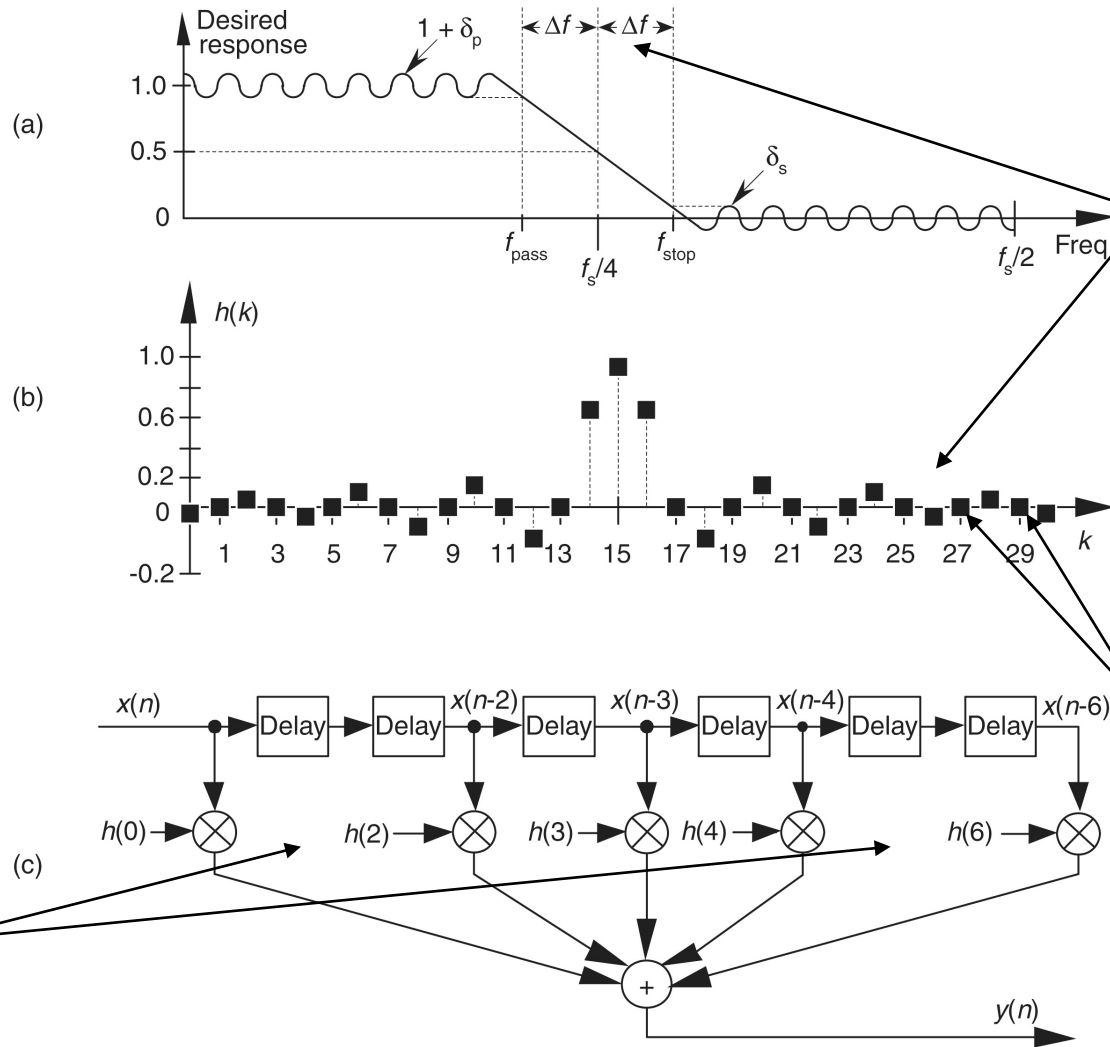

coefficients for a 31-tap half-band filter where Δf is defined to be approximately $f_s/32$ using Parks-McClellan FIR filter design method

alternating $h(k)$ coefficients are zero, so we perform 17 multiplications per output sample instead of the expected 31 multiplications

$h(1)$ and $h(5)$ multipliers are absent

Figure 5-33 Half-band FIR filter: (a) frequency magnitude response (transition region centered at $f_s/4$); (b) 31-tap filter coefficients; (c) 7-tap half-band filter structure.

Half-band FIR Filters

- Half-band FIR filter

- To build linear-phase N -tap half-band FIR filters, having alternating zero-valued coefficients, $N + 1$ *must* be an integer multiple of four
 - If this restriction is not met, e.g. when $N = 9$, the first and last coefficients will both be equal to zero and can be discarded, yielding a 7-tap half-band filter
- When designing a half-band filter, assuming that the modeled filter has a passband gain of unity, ensure that filter has a gain of 0.5 (−6 dB) at $f_s/4$
- Numerical computation errors yield alternate filter coefficients that are not exactly zero-valued → force those values to zero

Phase Response of FIR Filters

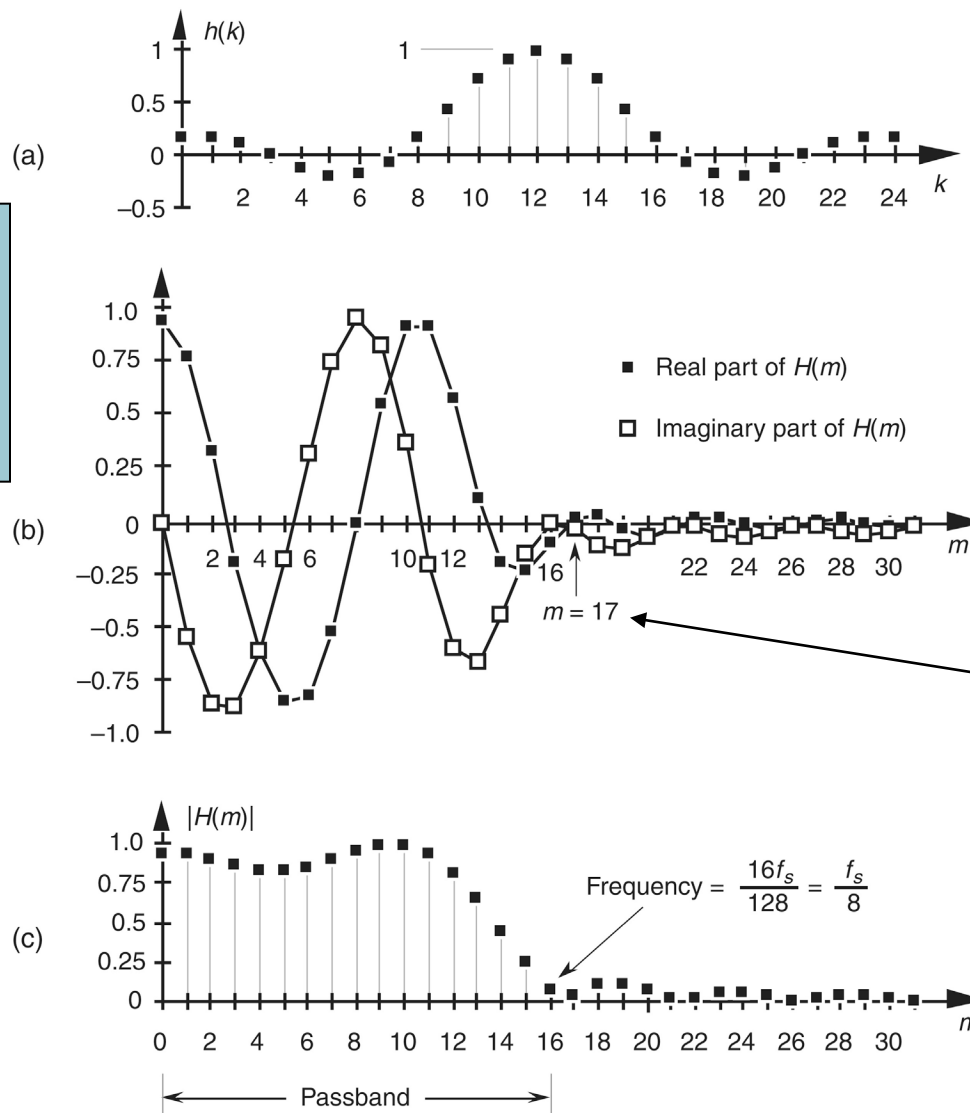

the 25 $h(k)$ sequence is padded with 103 zeros to take a 128-point DFT, resulting in $H(m)$ sample values

at $m = 17$, $H(m)$ experiences a polarity change of its real part while its imaginary part remains negative—this induces a true phase-angle discontinuity (in Fig. 5-35(c)) that really is a constituent of $H(m)$ at $m = 17$. Additional phase discontinuities occur each time the real part of $H(m)$ reverses polarity

Figure 5-34 FIR filter frequency response $H(m)$: (a) $h(k)$ filter coefficients; (b) real and imaginary parts of $H(m)$; (c) magnitude of $H(m)$.

Phase Response of FIR Filters

software adds 360° to any negative angles in the range of $-180^\circ > \phi \geq -360^\circ$

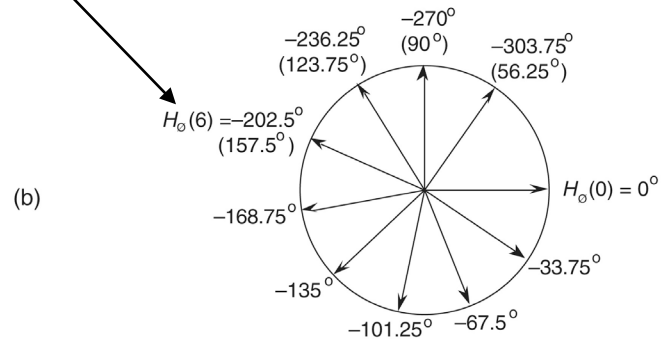
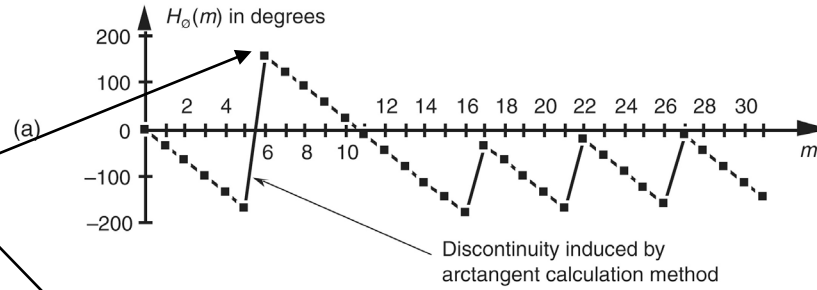

one of the dominant features of FIR filters is their linear phase response. $H_\phi(m)$ is linear over the passband of $H(m)$

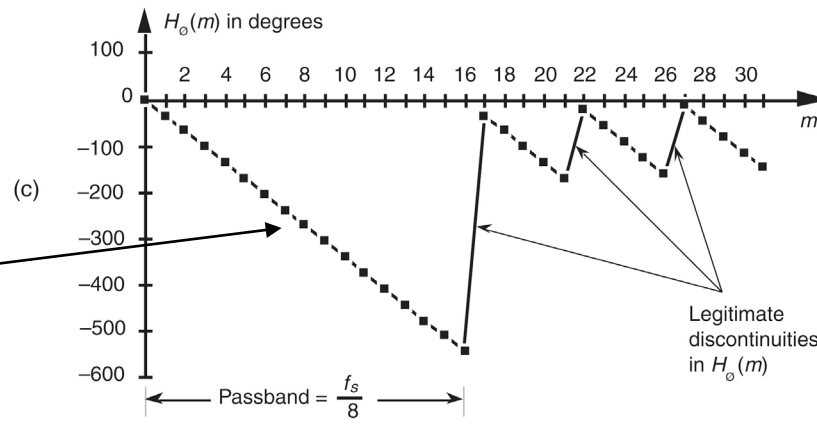

Figure 5-35 FIR filter phase response $H_\phi(m)$ in degrees: (a) calculated $H_\phi(m)$; (b) polar plot of $H_\phi(m)$'s first ten phase angles in degrees; (c) actual $H_\phi(m)$.

Phase Response of FIR Filters

- Group delay
 - $G = -d\phi/df$
 - For FIR filters, group delay is slope of $H_\phi(m)$ response curve
 - When group delay is constant, as it is over passband of all FIR filters having symmetrical coefficients, all frequency components of filter input signal are delayed by an equal amount of time G before they reach filter's output
 - Crucial in communications signals
 - For amplitude modulation (AM) signals, constant group delay preserves time waveform shape of signal's modulation envelope
 - Important because modulation portion of an AM signal contains signal's information

Phase Response of FIR Filters

■ Group delay

- Over passband frequency range for a linear-phase, S -tap FIR filter, group delay is

$$G = \frac{D \cdot t_s}{2} \text{ seconds}$$

- $D = S-1$ is the number of unit-delay elements
- t_s is sample period ($1/f_s$)
- Eliminating t_s factor changes its dimensions to samples

■ Passband phase-angle resolution

$$\Delta\phi = \frac{-G \cdot 360^\circ}{N}$$

- N = the number of points in DFT

Phase Response of FIR Filters

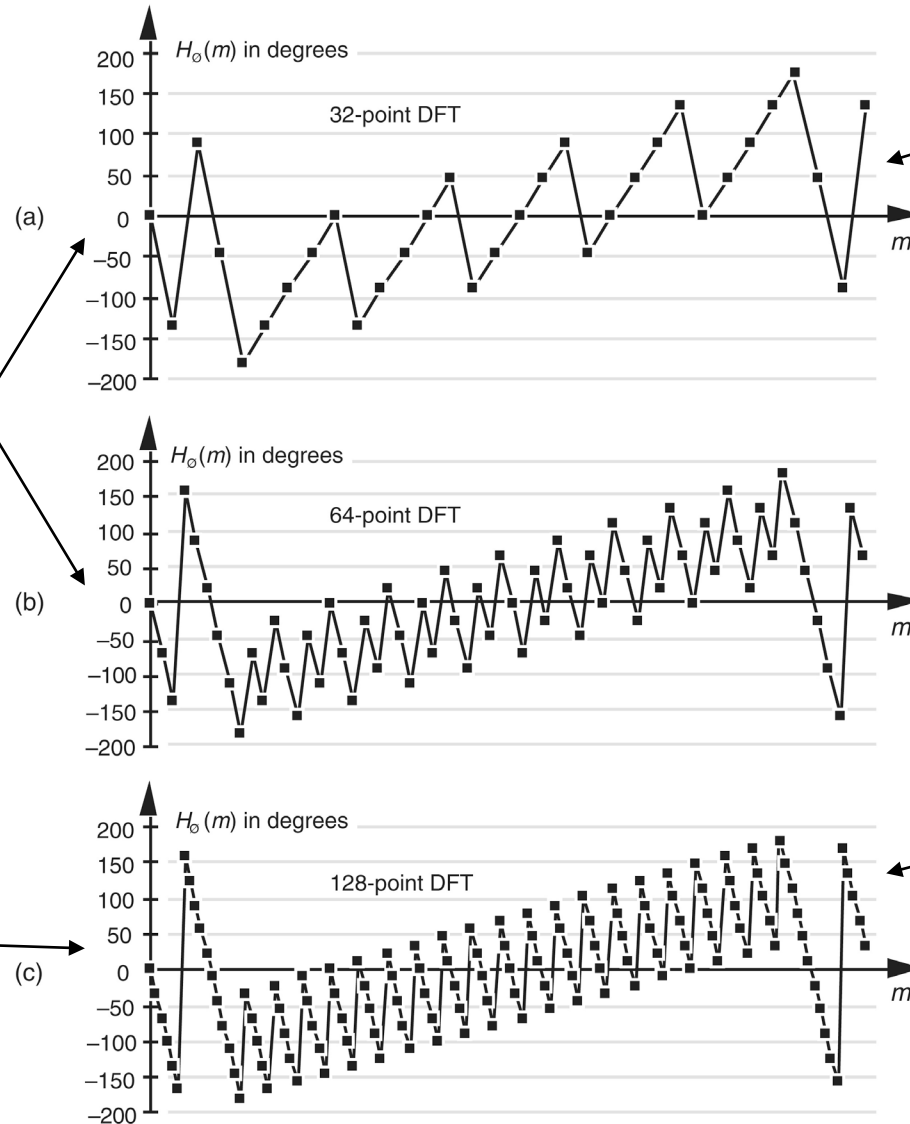

$S = 25$ -tap filter in Fig. 5-34(a) $\rightarrow G = 12 \rightarrow \Delta\theta = -12 \cdot 360^\circ/32 = -135^\circ$

$S = 25$ -tap filter in Fig. 5-34(a) $\rightarrow G = 12 \rightarrow \Delta\theta = -12 \cdot 360^\circ/128 = -33.75^\circ$

128-point DFT was used to obtain frequency responses in Figs. 5-34 and 5-35; we could use $N = 32$ -point or $N = 64$ -point DFTs

phase-angle resolution is much finer here

Figure 5-36 FIR filter phase response $H_0(m)$ in degrees: (a) calculated using a 32-point DFT; (b) using a 64-point DFT; (c) using a 128-point DFT.

Phase Response of FIR Filters

- For FIR filters, output phase shift (in degrees) for passband frequency $f = mf_s/N$, is

$$\text{phase delay} = H_{\phi}(mf_s / N) = m \cdot \Delta\phi = \frac{-m \cdot G \cdot 360^{\circ}}{N}$$

- Relationship between phase responses in Fig. 5-36 considering the phase delay associated with frequency of $f_s/32$

DFT size, N	Index m	$H_{\phi}(mf_s / N)$
32	1	-135°
64	2	-135°
128	4	-135°

Analyzing FIR Filters

- Analyzing tapped-delay line, nonrecursive FIR filters
 - Means determining FIR filter's frequency response based on known filter coefficients
 - Two ways to analyze
 - Using continuous-time Fourier algebra
 - Using discrete Fourier transform

Analyzing FIR Filters

- Algebraic analysis of FIR filters

- Uses DTFT equation

$$X(\omega) = \sum_{n=-\infty}^{\infty} x(n)e^{-jn\omega}$$

- DTFT of an FIR filter having N coefficients (impulse response) represented by $h(k)$, where $k = 0, 1, 2, \dots, N-1$

$$H(\omega) = \sum_{k=0}^{N-1} h(k)e^{-jk\omega}$$

$$= h(0)e^{-j0\omega} + h(1)e^{-j\omega} + h(2)e^{-j2\omega} + \dots + h(N-1)e^{-j(N-1)\omega}$$

- $H(\omega)$ is an $(N-1)$ th-order polynomial
- ω is continuous and ranges from 0 to 2π rad/samp, corresponding to a continuous-time frequency range of 0 to f_s Hz

Analyzing FIR Filters

■ Example

- A 4-tap FIR filter whose coefficients are $h(k) = [0.2, 0.4, 0.4, 0.2]$

$$H(\omega) = \sum_{k=0}^3 h(k)e^{-jk\omega} = h(0)e^{-j0\omega} + h(1)e^{-j\omega} + h(2)e^{-j2\omega} + h(3)e^{-j3\omega}$$

complex 3rd-order \rightarrow

$$\begin{aligned} &= 0.2 + 0.4e^{-j\omega} + 0.4e^{-j2\omega} + 0.2e^{-j3\omega} \\ &= 0.2 + 0.4\cos(\omega) + 0.4\cos(2\omega) + 0.2\cos(3\omega) \\ &\quad - j[0.4\sin(\omega) + 0.4\sin(2\omega) + 0.2\sin(3\omega)] \end{aligned}$$

- Magnitude and phase ($H_{\phi}(\omega) = \arctangent$ of ratio of imaginary part over real part of $H(\omega)$) are plotted in Fig. 5-46

Analyzing FIR Filters

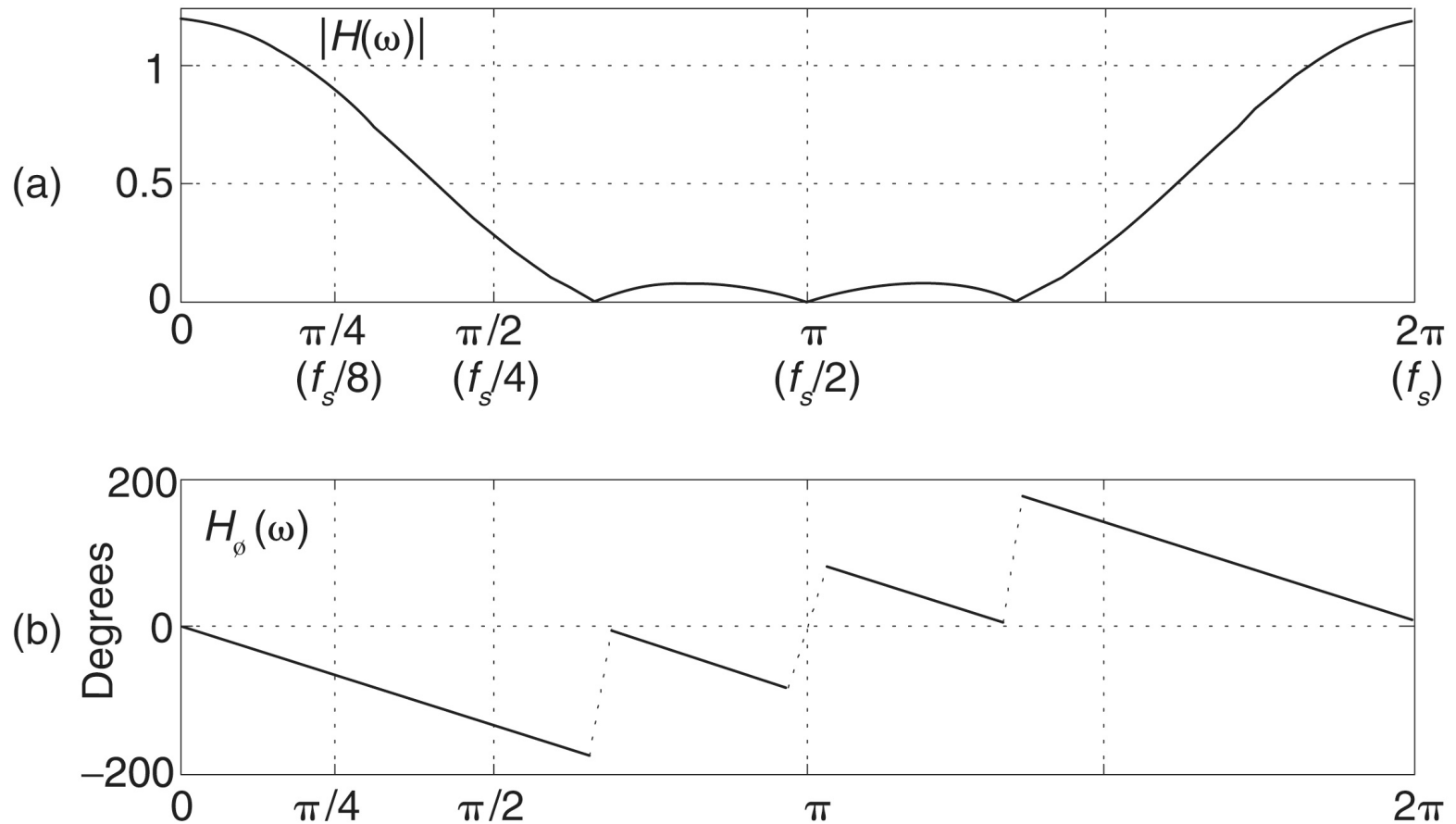

Figure 5-46 FIR filter frequency response: (a) magnitude; (b) phase.

Analyzing FIR Filters

- DFT analysis of FIR filters
 - The most convenient way to determine an FIR filter's frequency response is to perform DFT of filter's coefficients

$$H(m) = \sum_{k=0}^{N-1} h(k) e^{-j2\pi mk/N}$$

Analyzing FIR Filters

We need more $|H(m)|$ frequency-domain information. That is, we need improved frequency *resolution*.

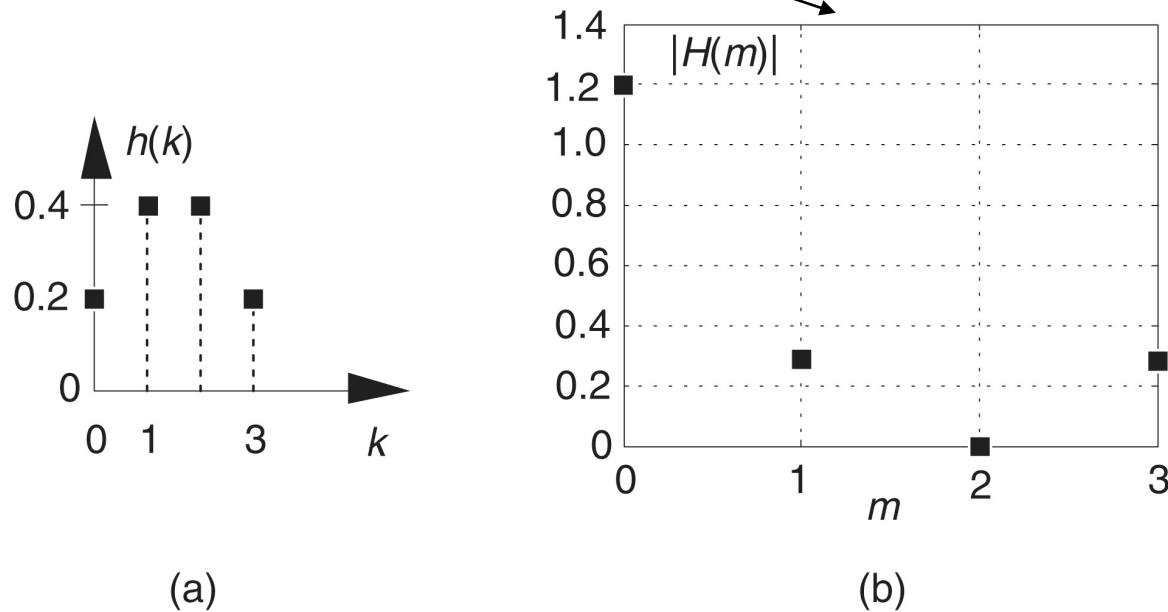
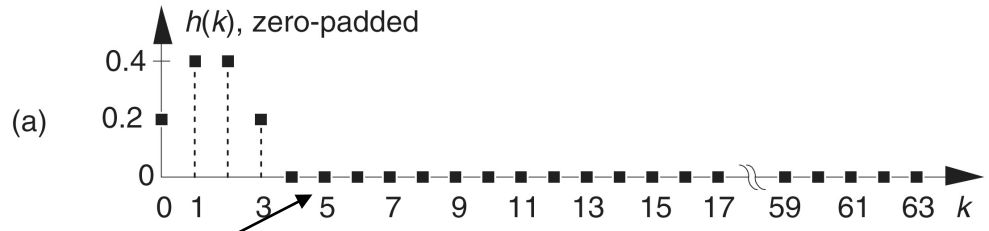
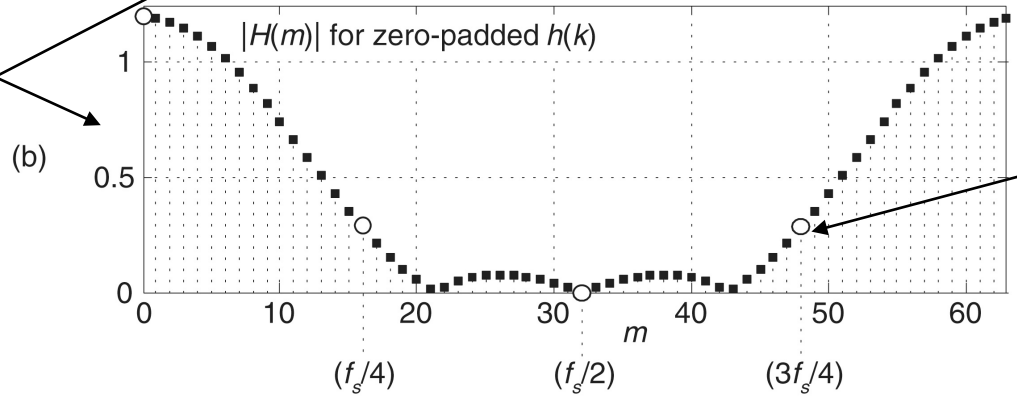

Figure 5-47 Four-tap FIR filter: (a) impulse response; (b) 4-point DFT frequency magnitude response.

Analyzing FIR Filters



a finer-granularity version of $H(m)$ obtained by zero padding $h(k)$ coefficients



circular white dots correspond to square dots in Fig. 5-47(b)

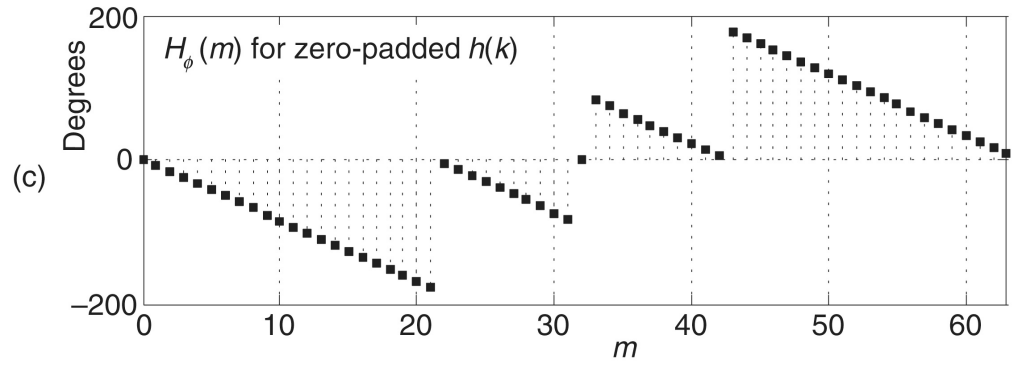

Figure 5-48 High-resolution FIR filter frequency response: (a) zero-padded $h(k)$; (b) discrete magnitude response; (c) phase response.

Analyzing FIR Filters

- A filter's complex $H(m)$ frequency response sequence

$$H(m) = |H(m)|e^{jH_{\phi}(m)}$$

$$H_{\phi}(m) = \tan^{-1}\left(\frac{H_{imag}(m)}{H_{real}(m)}\right)$$

Analyzing FIR Filters

- FIR filter (constant) group delay
 - A filter has a linear phase response over its passband and will induce no phase distortion in its output signals

$$H(\omega) = |H(\omega)|e^{jH_\phi(\omega)} \rightarrow G(\omega) = \frac{-dH_\phi(\omega)}{d(\omega)} \text{ samples}$$

- ω is continuous and ranges from $-\pi$ to π radians/sample, corresponding to a continuous-time frequency range of $-f_s/2$ to $f_s/2$ Hz
- $H_\phi(\omega)$ in radians
 ω in radians/sample
 $G(\omega)$ are time measured in samples

Analyzing FIR Filters

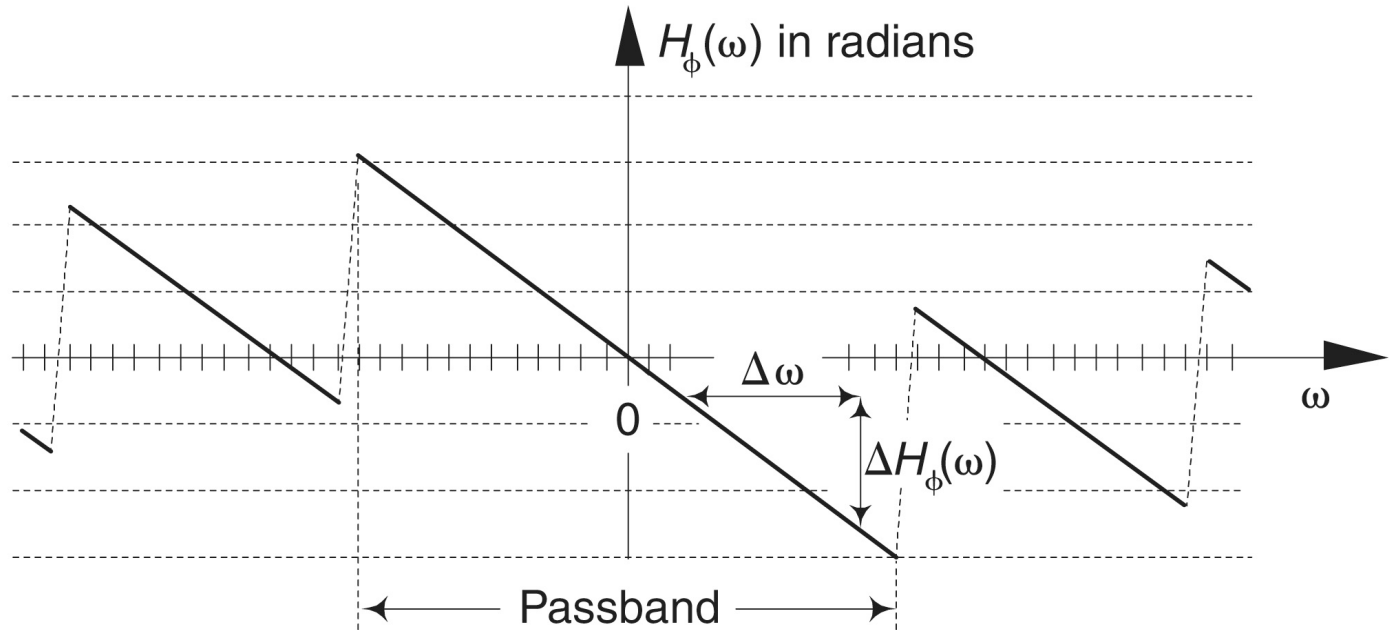

Figure 5-49 FIR filter group delay derived from a filter's phase response.

Analyzing FIR Filters

- FIR filter group delay
 - Example: complex-valued frequency response of a K -tap moving average filter is

$$H_{ma}(\omega) = e^{-j\omega(K-1)/2} \frac{\sin(\omega K / 2)}{\sin(\omega / 2)}$$

phase response of a
 $K = 5$ -tap moving average filter $\rightarrow H_{\phi, K=5}(\omega) = -\omega(5-1)/2 = -2\omega$

group delay of a
 $K = 5$ -tap moving average filter $\rightarrow G_{ma, K=5}(\omega) = \frac{-dH_{\phi, K=5}(\omega)}{d(\omega)} = \frac{-d(-2\omega)}{d(\omega)} = 2$ samples

- For symmetrical-coefficient FIR filters

D = the no. of unit-delay elements in filter's delay line

$$G_{\text{samples}} = \frac{D}{2} \text{ samples}$$

$$G_{\text{seconds}} = \frac{Dt_s}{2} = \frac{D}{2f_s} \text{ seconds}$$

Analyzing FIR Filters

- FIR filter group delay

- In general, group delay of a tapped-delay line FIR digital filter, whose impulse response is symmetric, is

$$G_{\text{samples}} = \frac{\text{impulse response length} - 1}{2} \text{ samples}$$

- If a tapped-delay line (FIR) network has an antisymmetrical impulse response, it also has a linear phase response and its group delay is also described by above equation
 - Antisymmetrical impulse response: $h(k) = -h(N-k-1)$ where $0 \leq k \leq (N-1)/2$ when N is odd and $0 \leq k \leq (N/2)-1$ when N is even

Analyzing FIR Filters

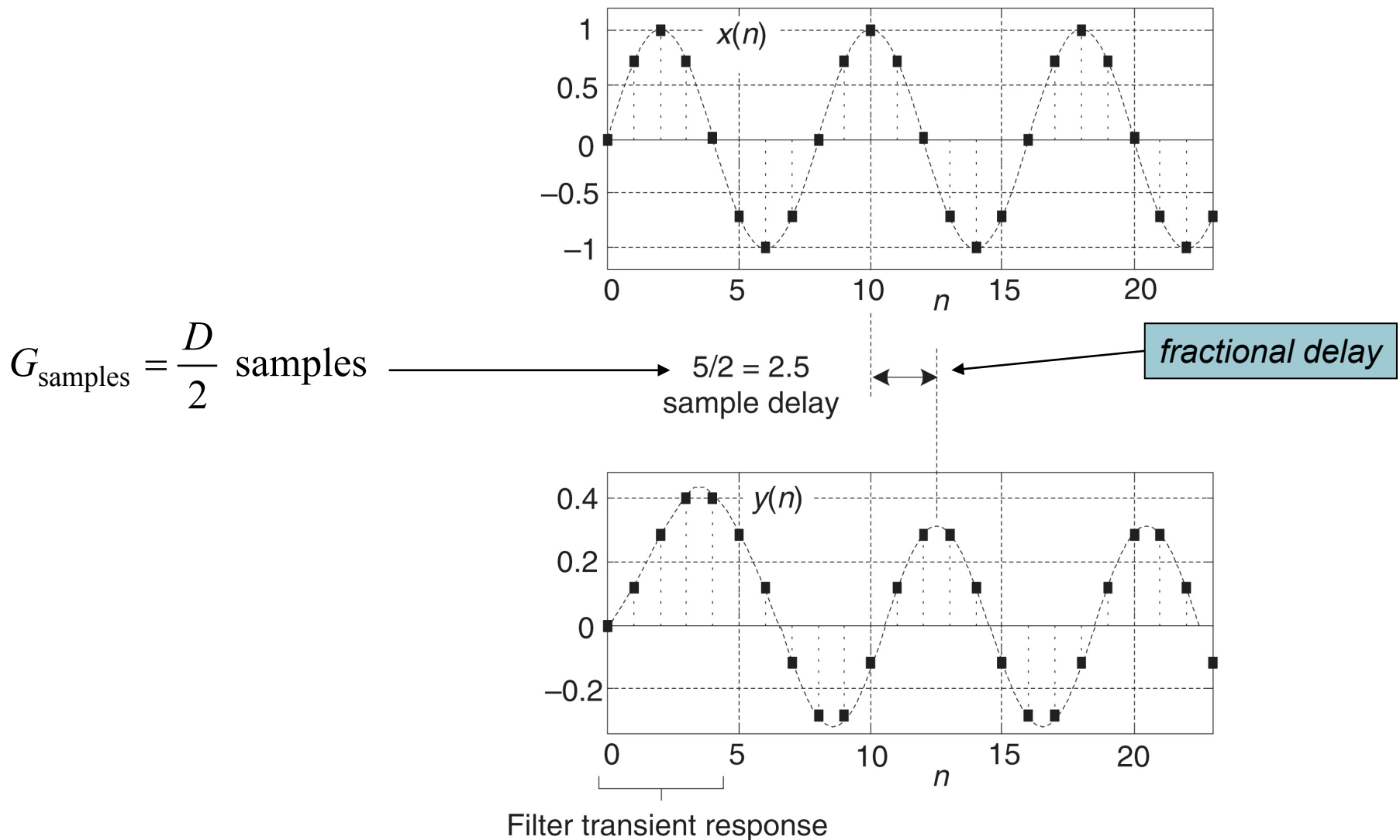

Figure 5-50 Group delay of a 6-tap (5 delay elements) FIR filter.

Analyzing FIR Filters

- FIR filter passband gain
 - Passband gain is filter's passband magnitude response level around which the passband ripple fluctuates
 - In practice we design filters to have very small passband ripple, so a lowpass filter's passband gain is roughly equal to its DC gain (gain at 0 Hz)
 - DC gain is sum of filter's impulse response sequence, i.e., sum of FIR filter's coefficients
 - Most commercial FIR filter design software packages compute filter coefficients such that their passband gain is unity

Analyzing FIR Filters

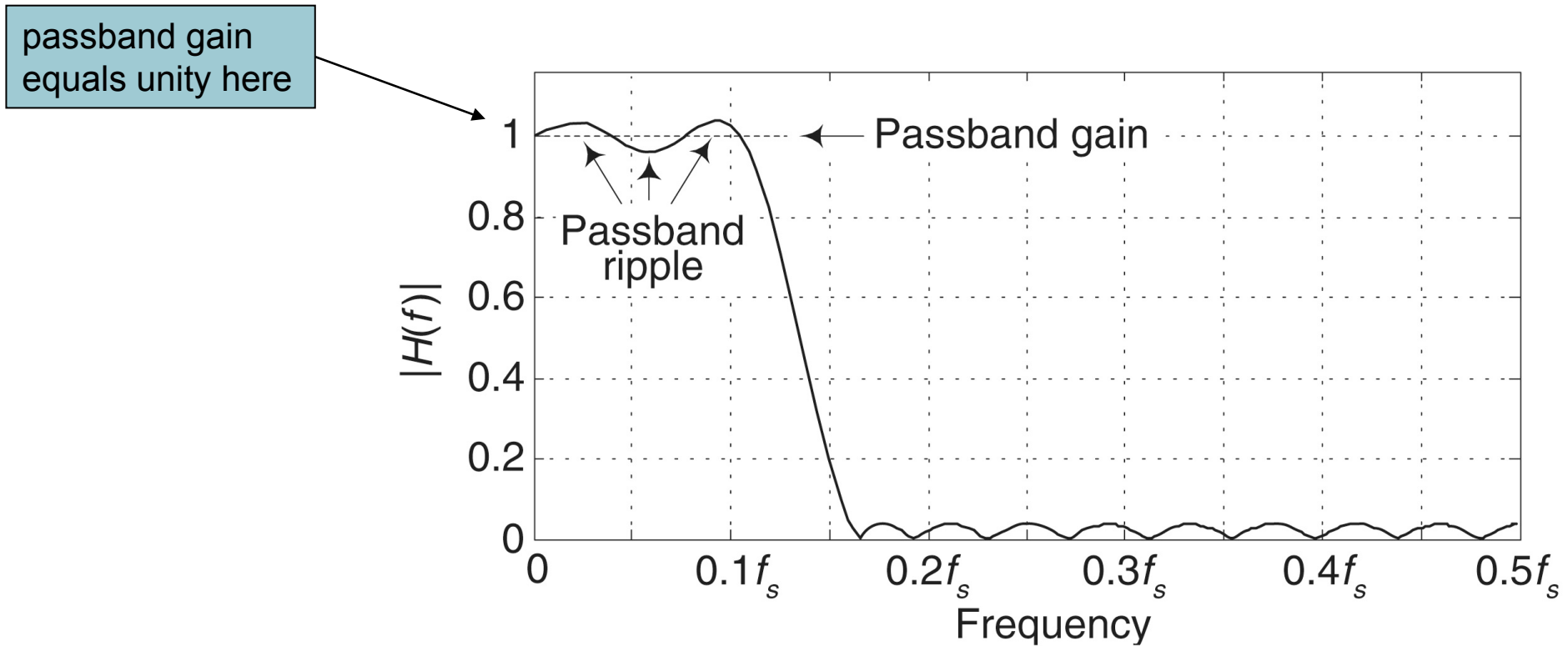

Figure 5-51 FIR filter passband gain definition.

Analyzing FIR Filters

- Estimating the number of FIR filter taps
 - How do we estimate the number of filter taps (coefficients), N , that can satisfy a given frequency magnitude response of an FIR filter?
 - A simple expression proposed by Prof. Fred Harris for N , for passband ripple values near 0.1 dB, is

$$N_{\text{FIR}} \approx \frac{\textit{Atten}}{22(f_{\text{stop}} - f_{\text{pass}})}$$

- *Atten* = desired stopband attenuation measured in dB
- f_{pass} and f_{stop} are frequencies normalized to f_s sample rate in Hz

E.g., $f_{\text{pass}} = 0.2$ means that continuous-time frequency of f_{pass} is $0.2f_s$ Hz

Analyzing FIR Filters

the lowpass filter can be built using a 22-tap FIR filter

Assuming
 $f_s = 1000$ Hz
 $f_{pass} = 250$ Hz
 $f_{stop} = 350$ Hz
 stopband atten = 48 dB

$$N_{FIR} \approx \frac{Atten}{22(f_{stop} - f_{pass})} \rightarrow N_{FIR} \approx \frac{48}{22(\underbrace{350/1000}_{0.35} - \underbrace{250/1000}_{0.25})} = 21.8$$

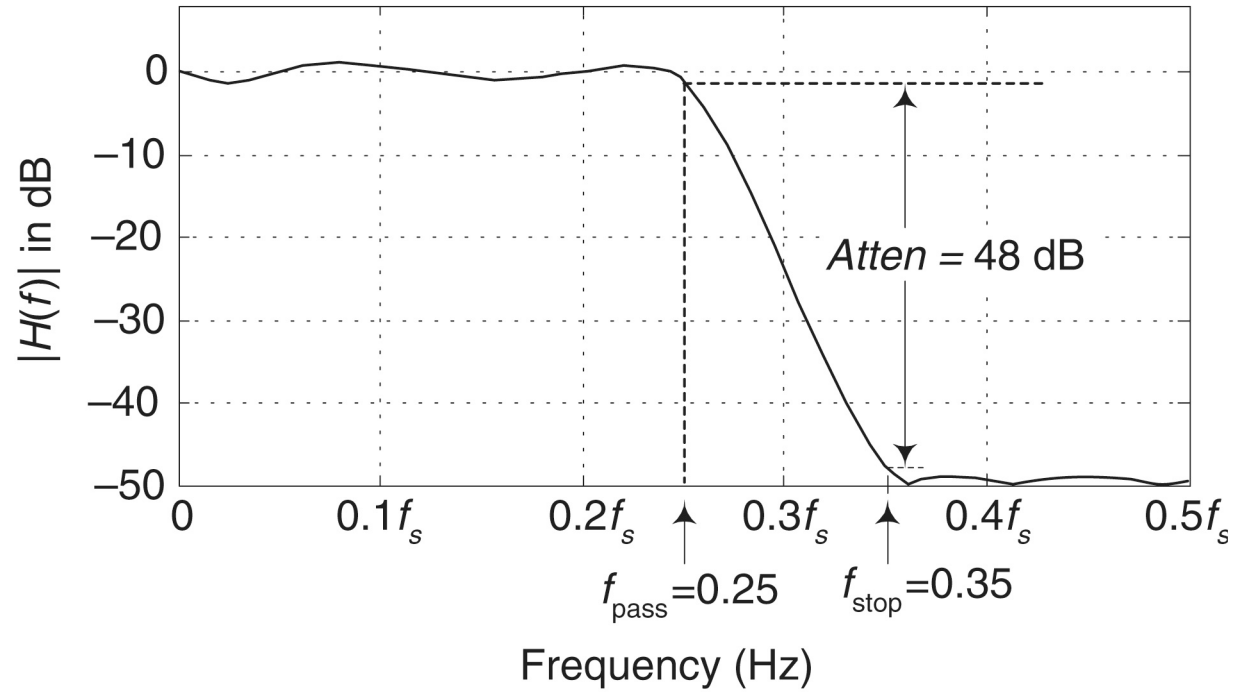

Figure 5-52 Example FIR filter frequency definitions.