

Analysis Patterns

PV167 Project in Object-oriented Design of Information Systems

Analysis Patterns

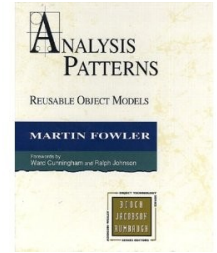

✧ **Analysis Patterns: Reusable Object Models** by Martin Fowler, 1997

- Accountability
- Observations and Measurements
- Observations for Corporate Finance
- Referring to Objects
- Inventory and Accounting
- Planning
- Trading
- Derivative Contracts
- Trading Packages

Case Study: Ollie's Order Center

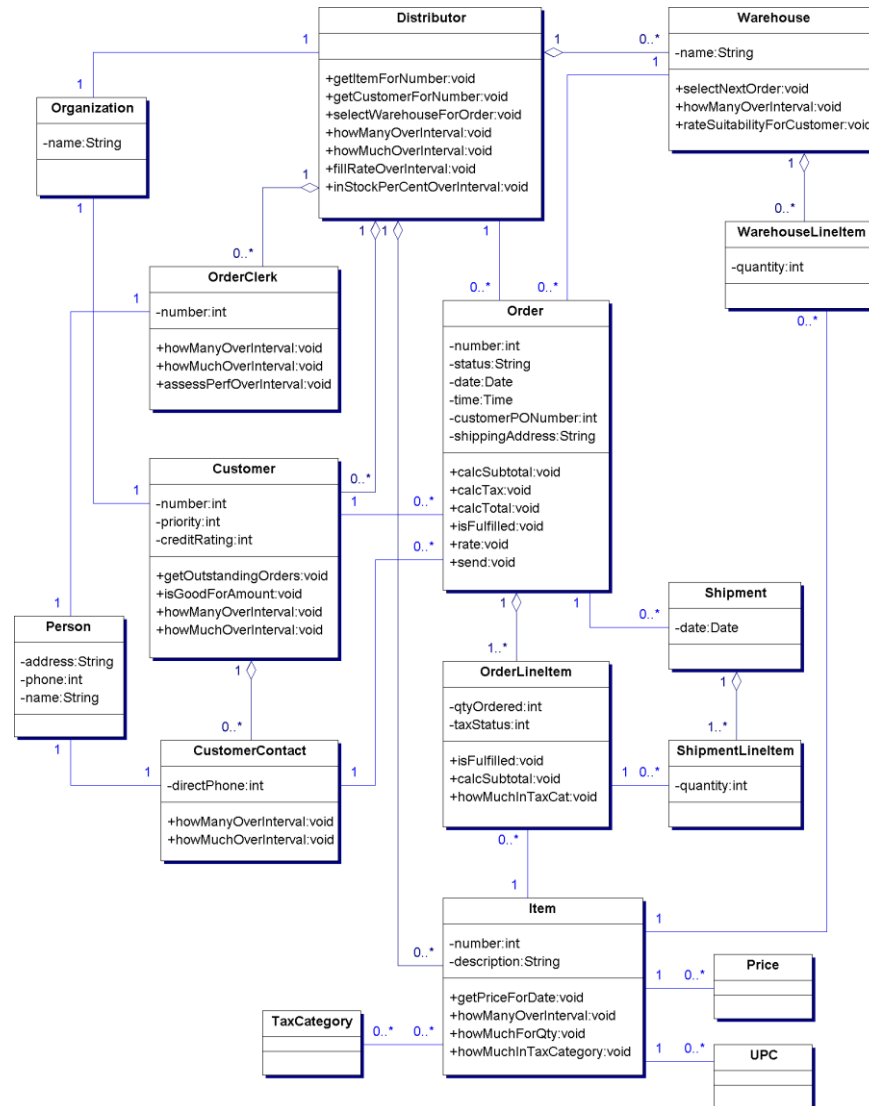
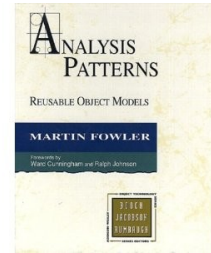

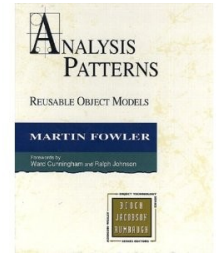

Analysis Patterns

Part 1/2

Studied patterns

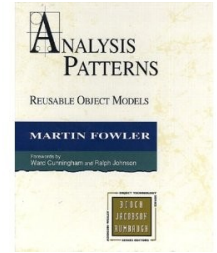

✧ Accountability

- Party pattern
- Accountability pattern

✧ Observations and Measurements

- Quantity pattern
- Conversion Ratio pattern

✧ Observations for Corporate Finance

- Enterprise Segment pattern

✧ Referring to Objects

- Name pattern
- Identification Scheme pattern

Accountability – Party pattern

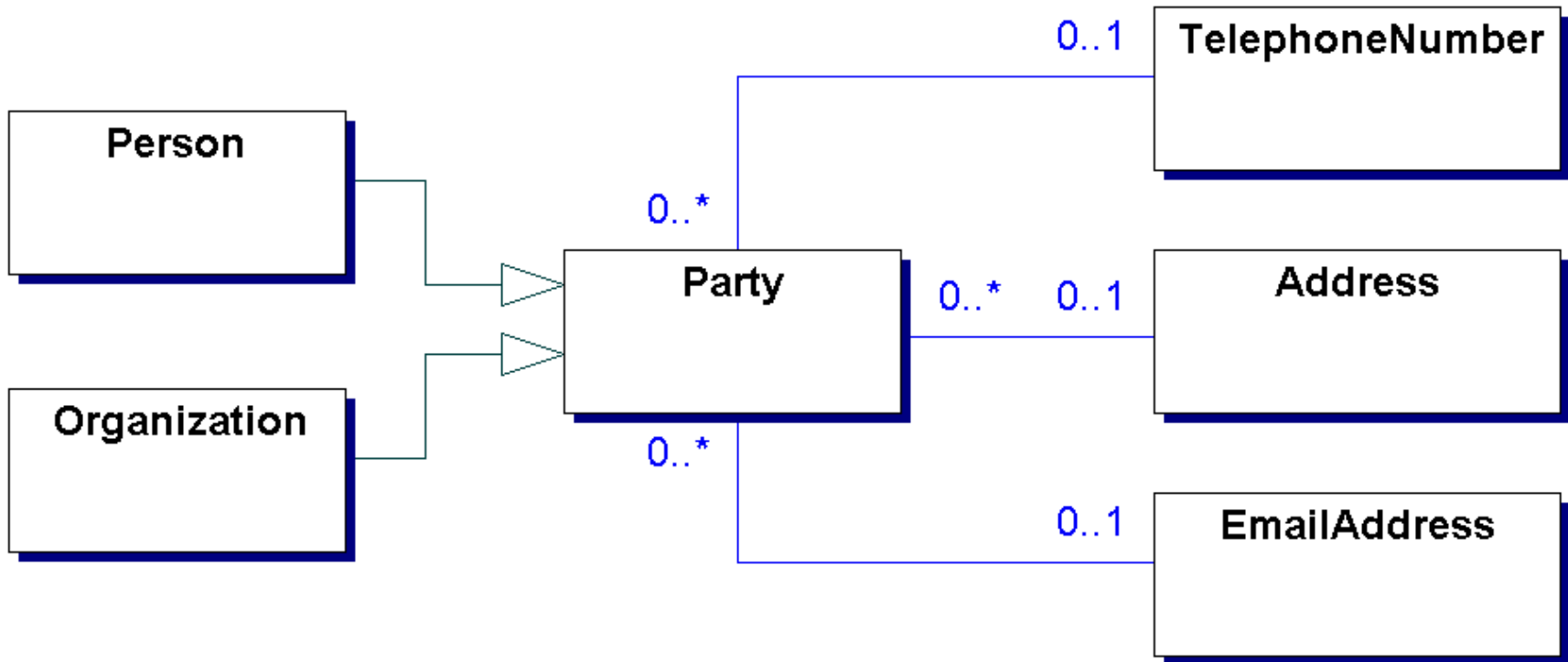
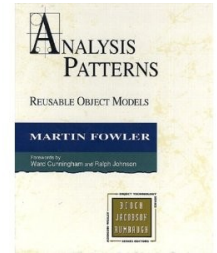

Ollie's Order Center: Party pattern

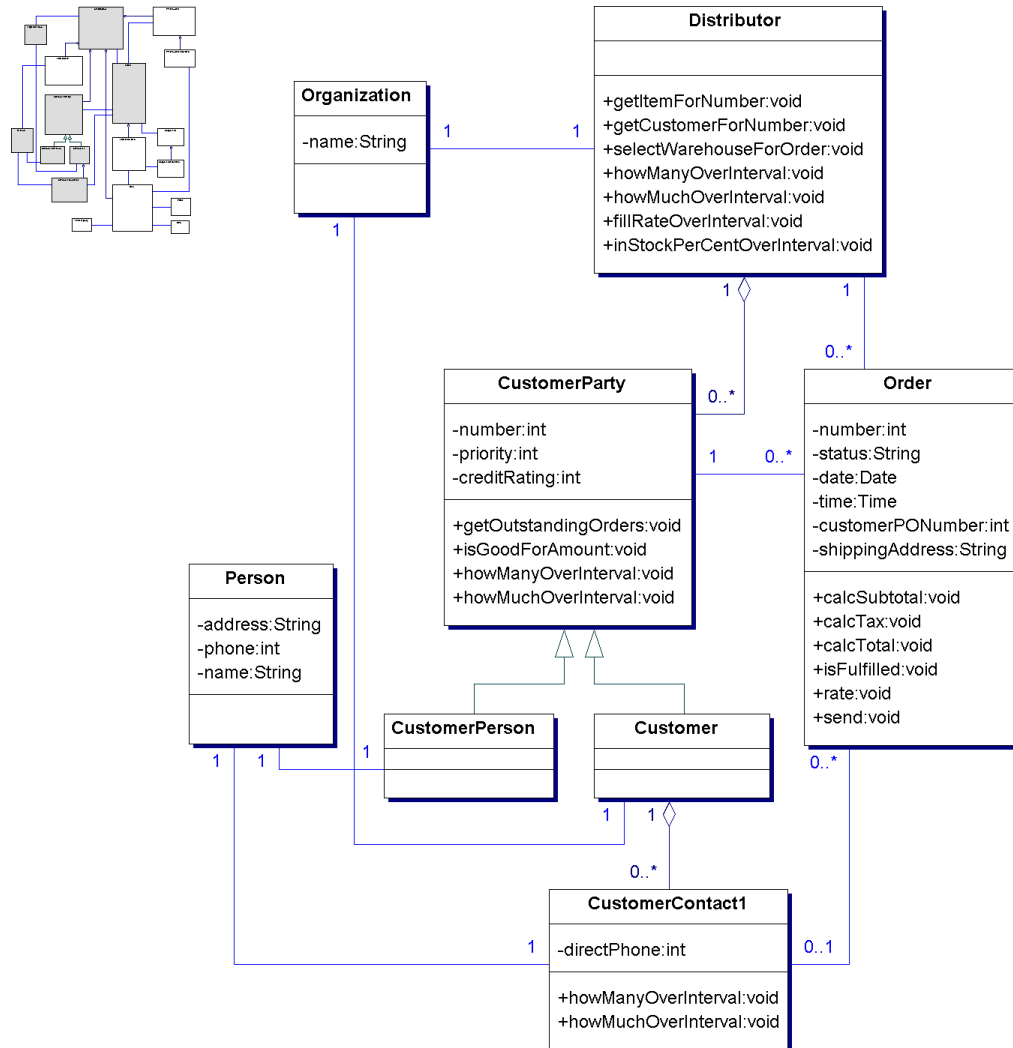
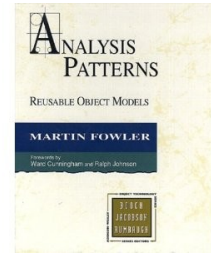

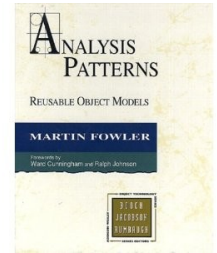

Accountability – Accountability pattern

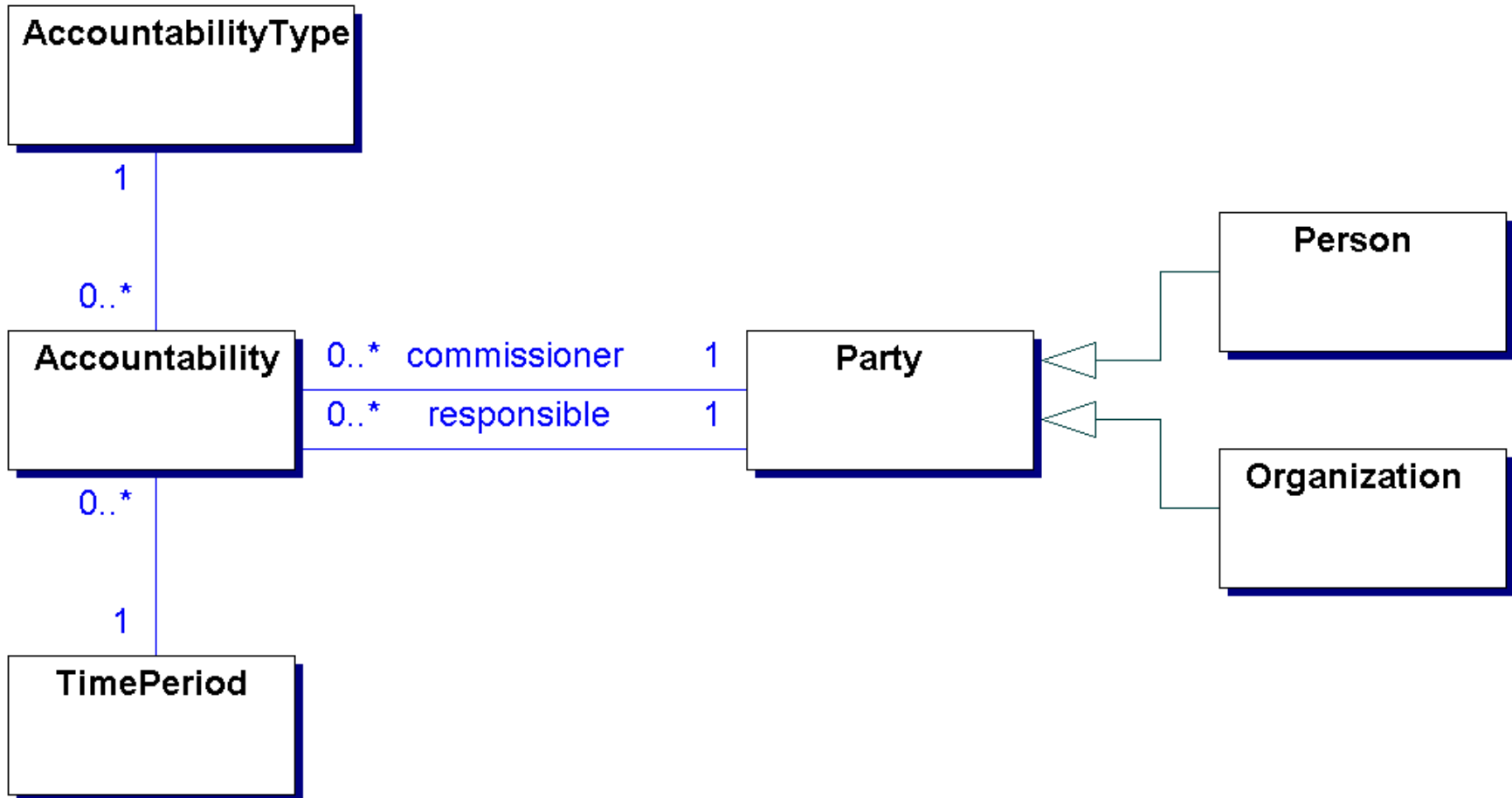

Observations and Measurements – Quantity pattern

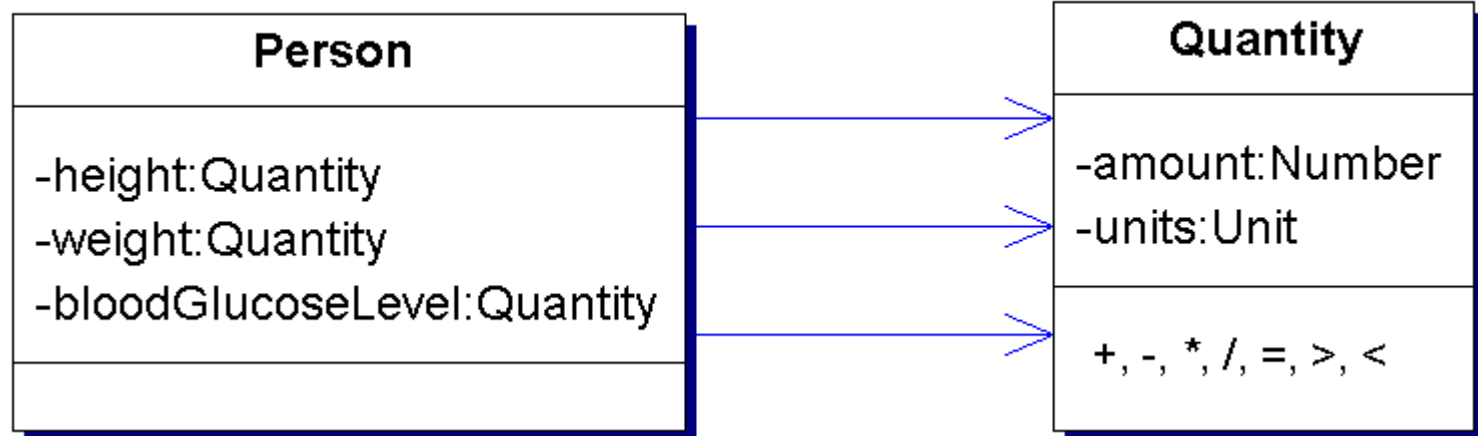
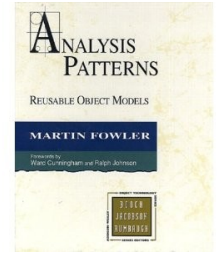

Ollie's Order Center: Quantity pattern

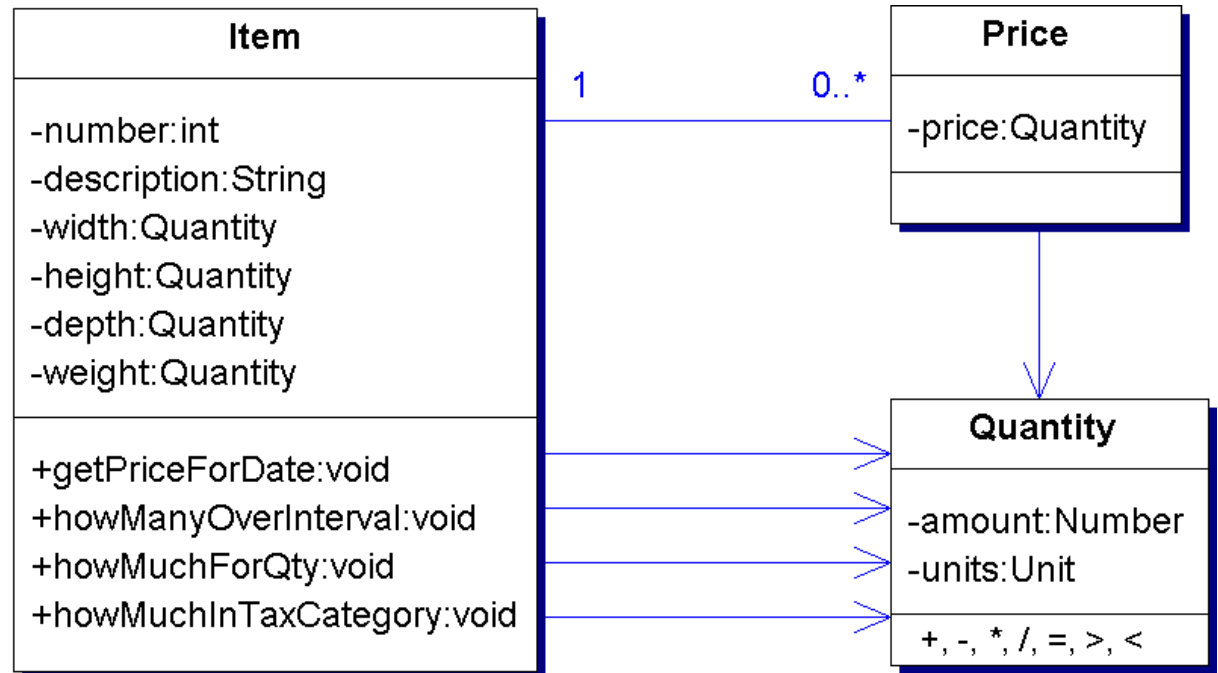
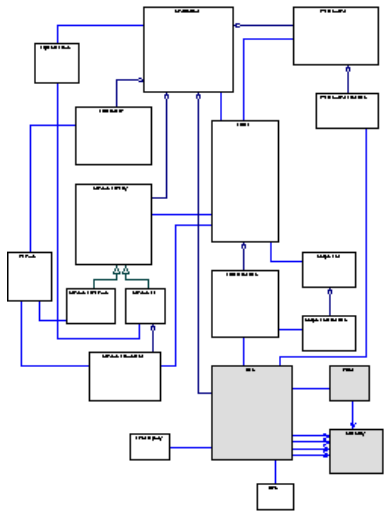
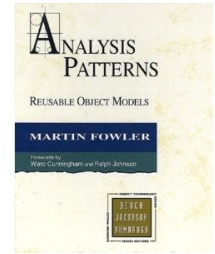

Observations and Measurements – Conversion Ratio pattern

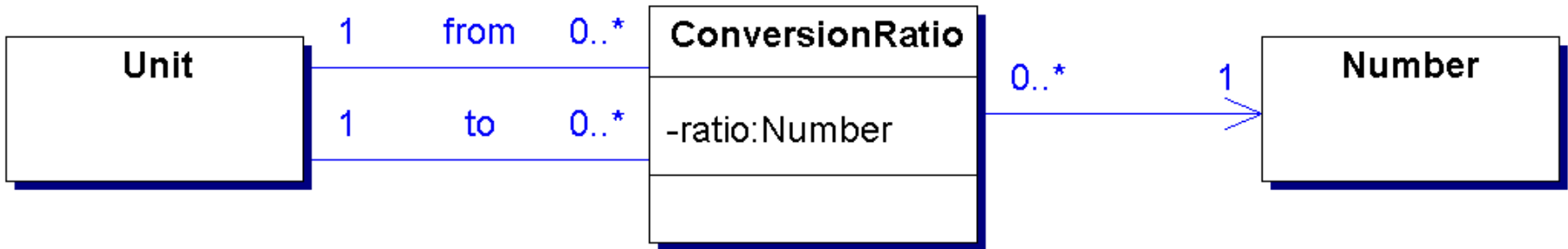
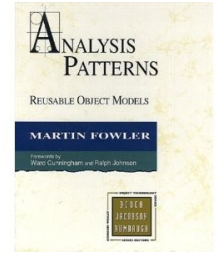

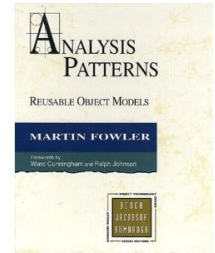

Ollie's Order Center: Conversion Ratio pattern

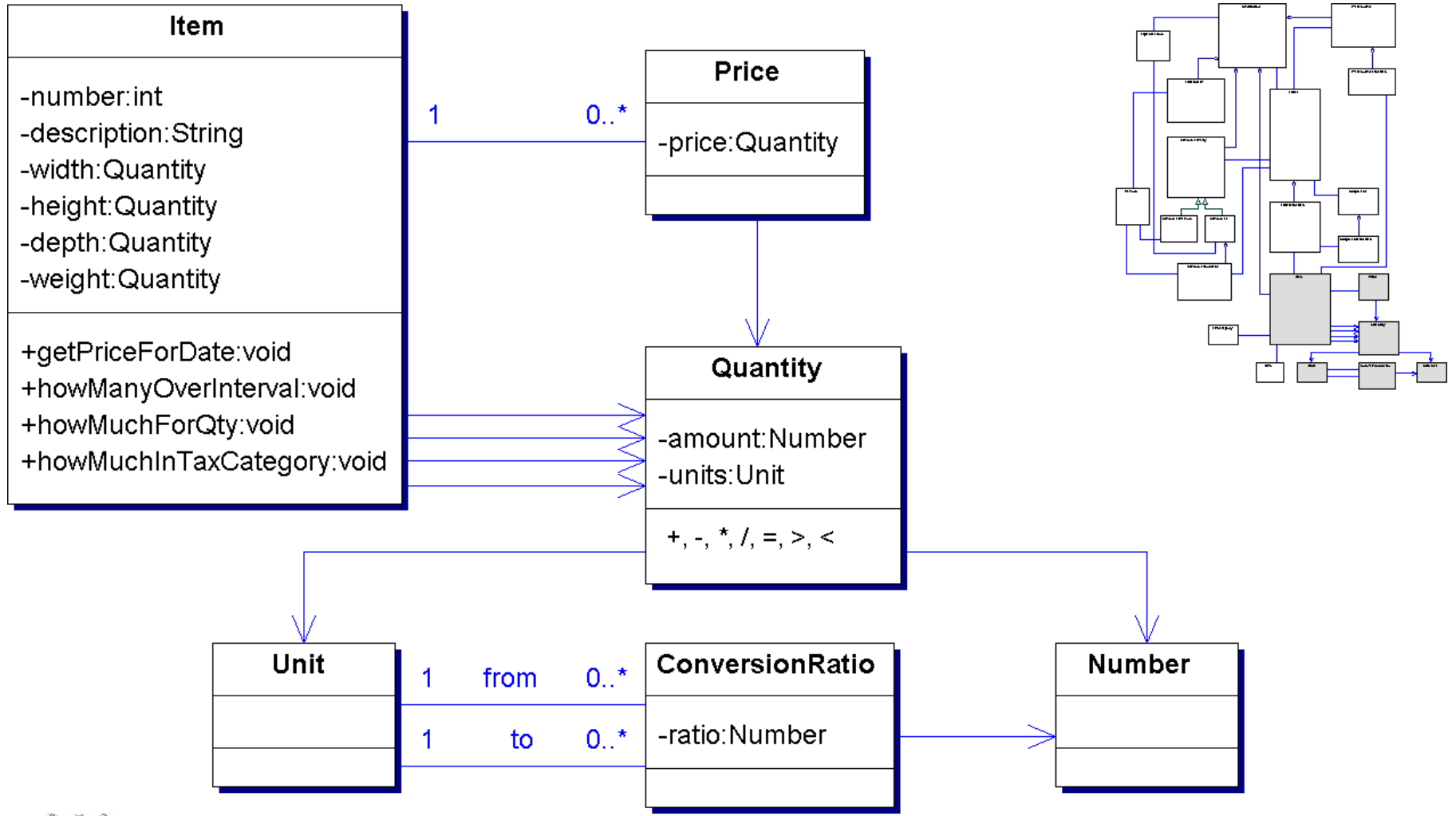

Observations for Corporate Finance – Enterprise Segment pattern

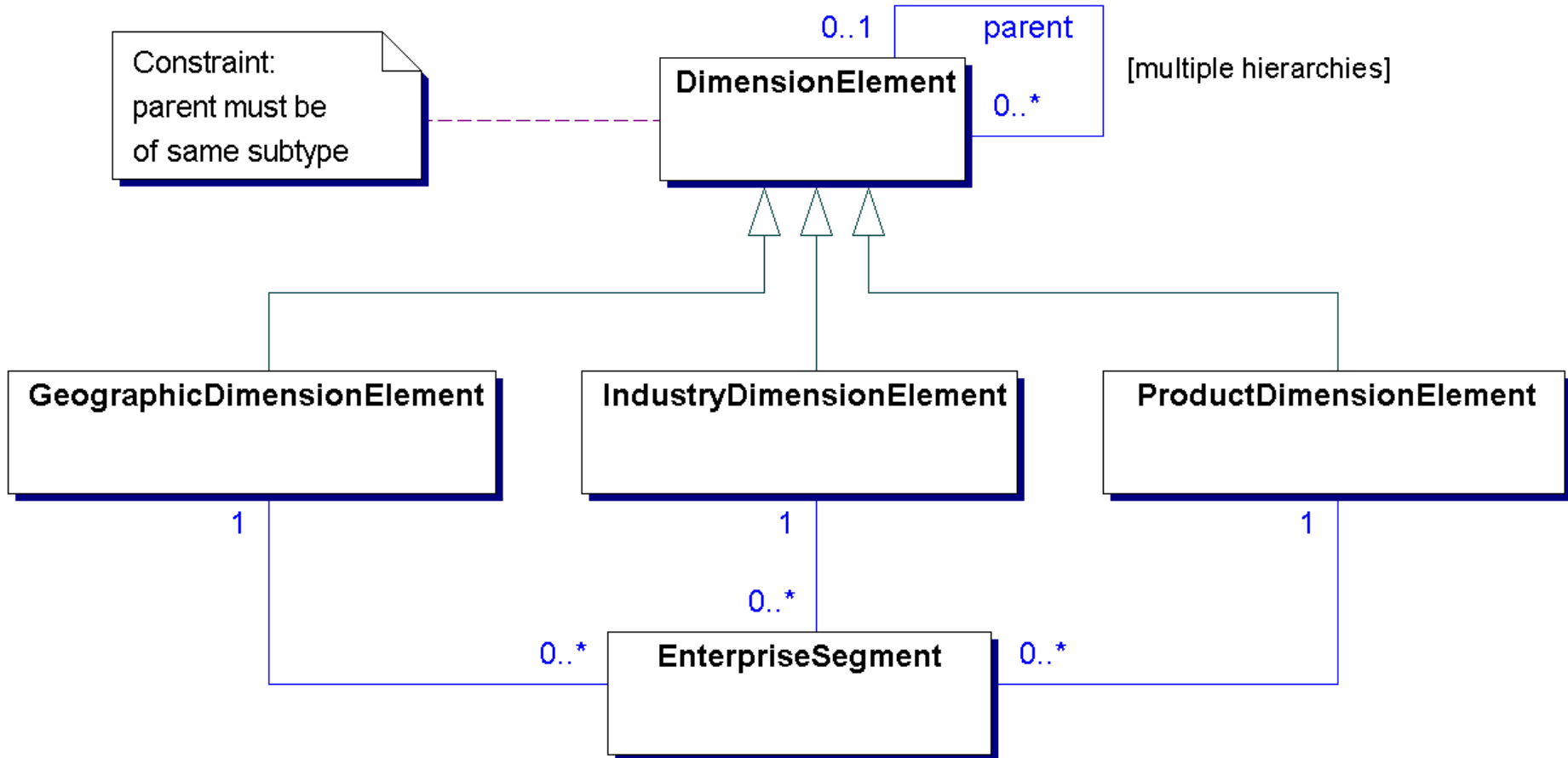
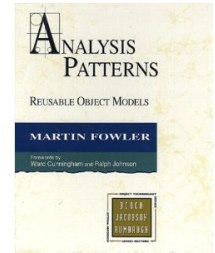

Referring to Objects – Name pattern

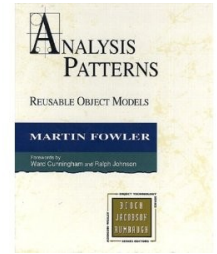

One name:

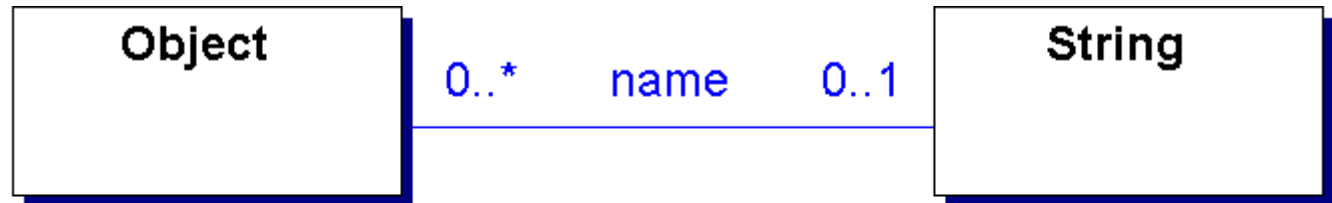

More names:



Identifier:



Referring to Objects – Identification Scheme pattern

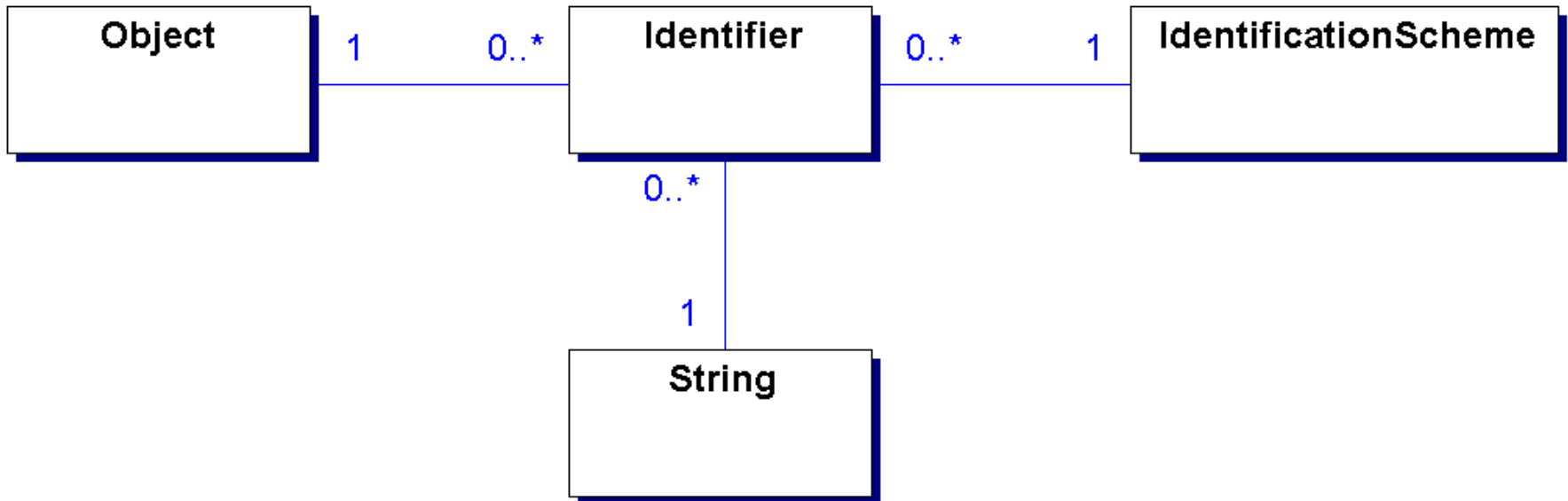
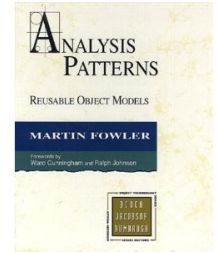

Ollie's Order Center: Identification Scheme pattern

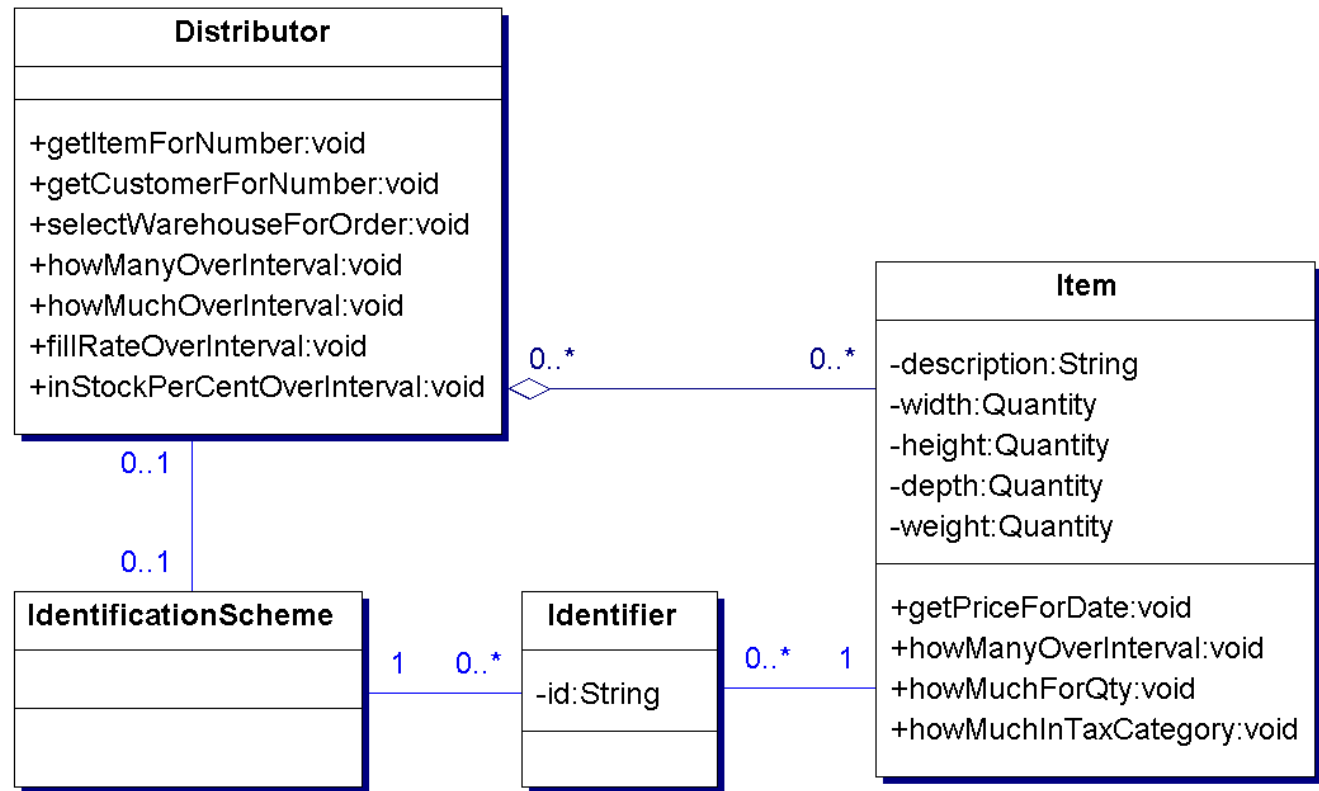
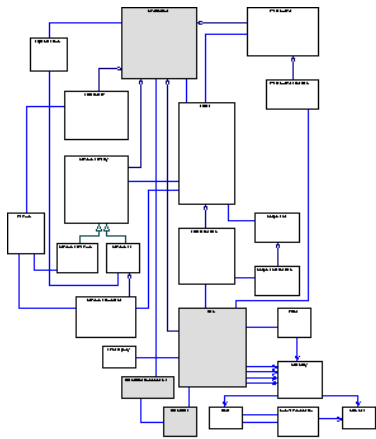
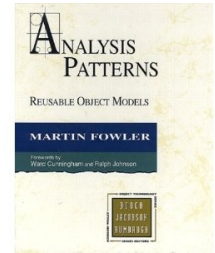

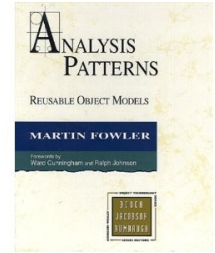

Analysis Patterns

Part 2/2

Studied patterns

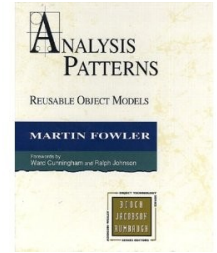

✧ Inventory and Accounting

- Account pattern
- Transactions pattern

✧ Planning

- Proposed and Implemented Action pattern
- Completed and Abandoned Actions pattern

✧ Trading

- Contract pattern
- Portfolio pattern

✧ Derivative Contracts

- Forward Contracts pattern

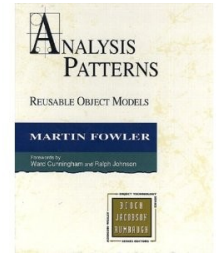

Inventory and Accounting – Account pattern

Constraint:
balance = sum(entries.amount)

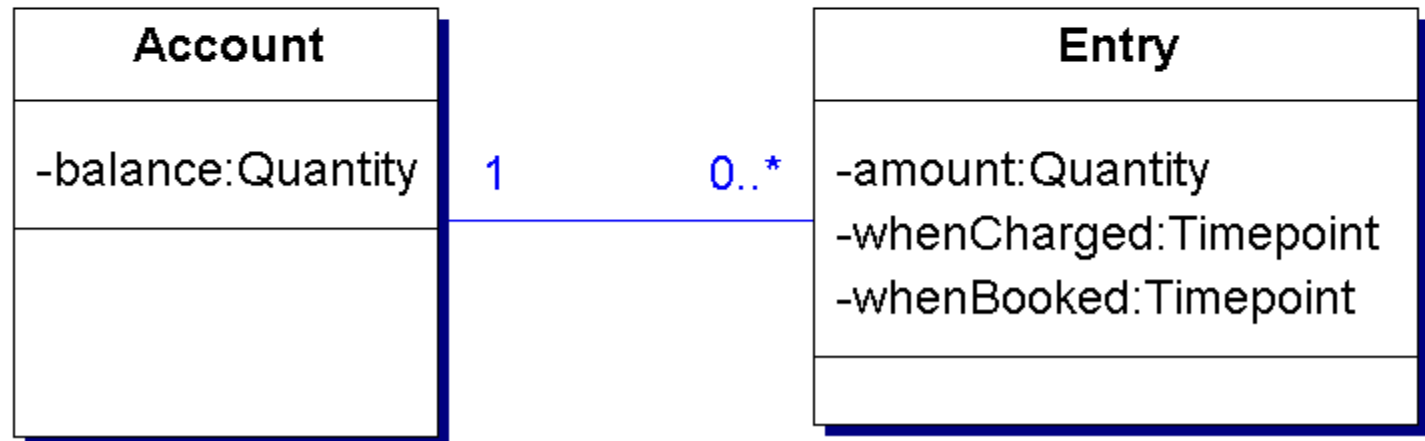

Ollie's Order Center: Account pattern

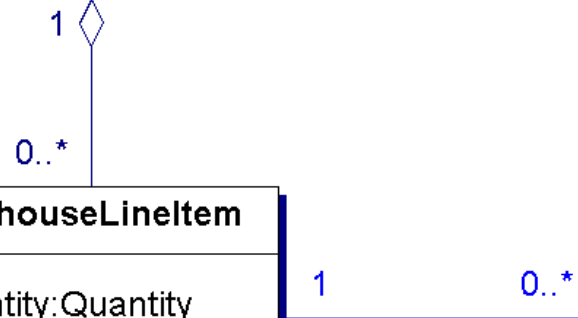
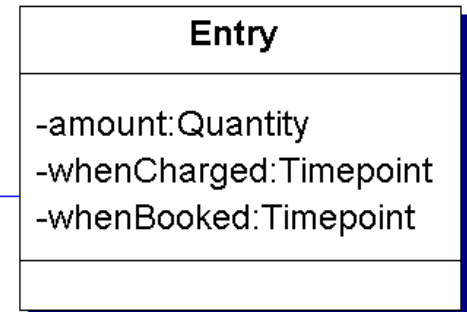
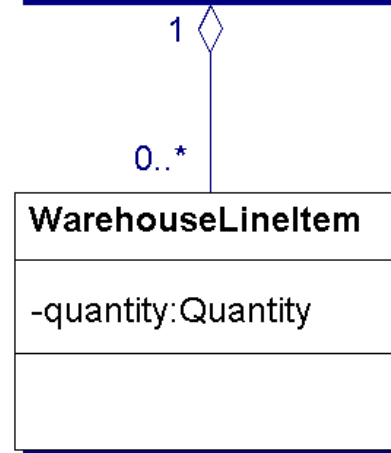
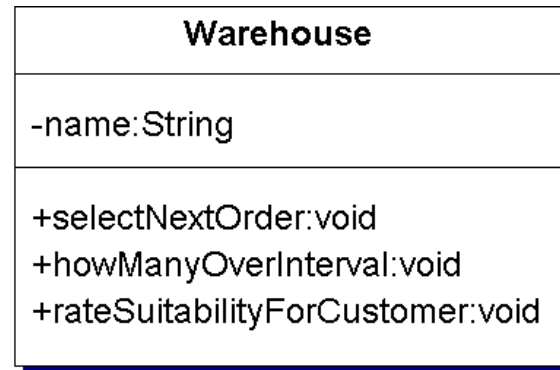
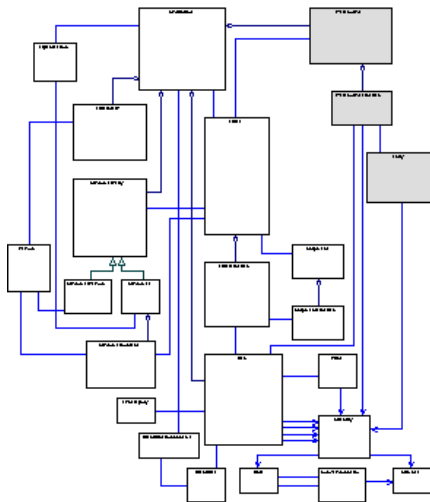
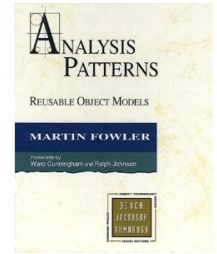

Inventory and Accounting – Transactions pattern

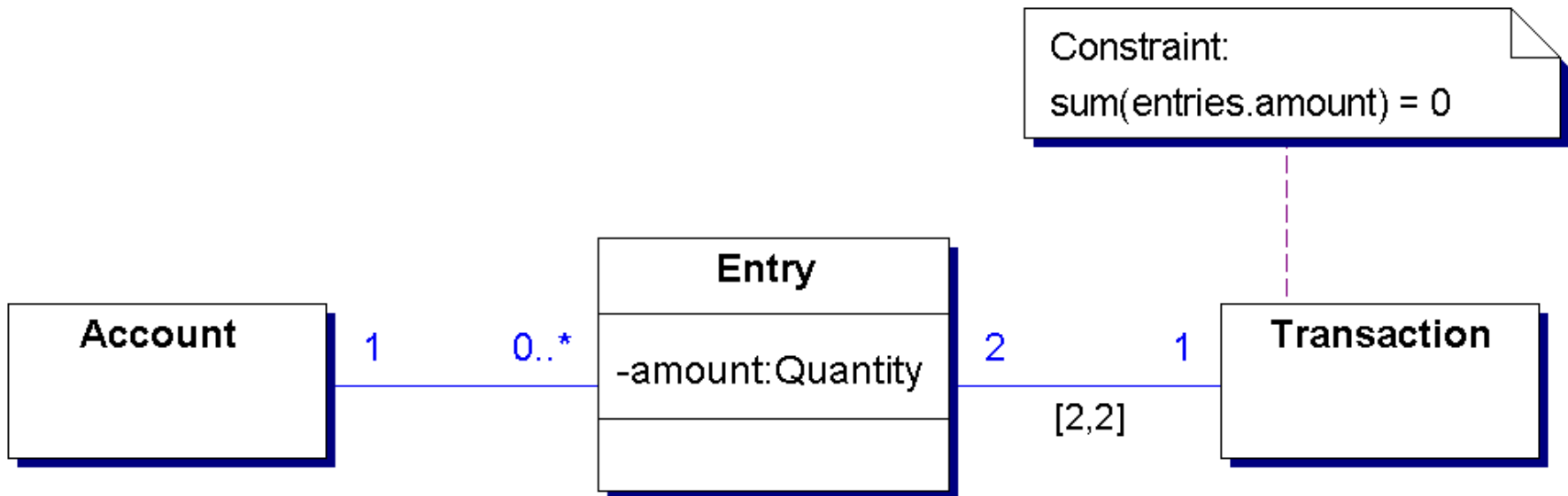
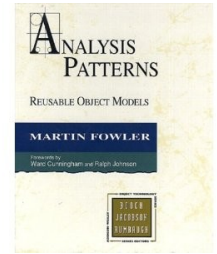

Planning – Proposed and Implemented Action pattern

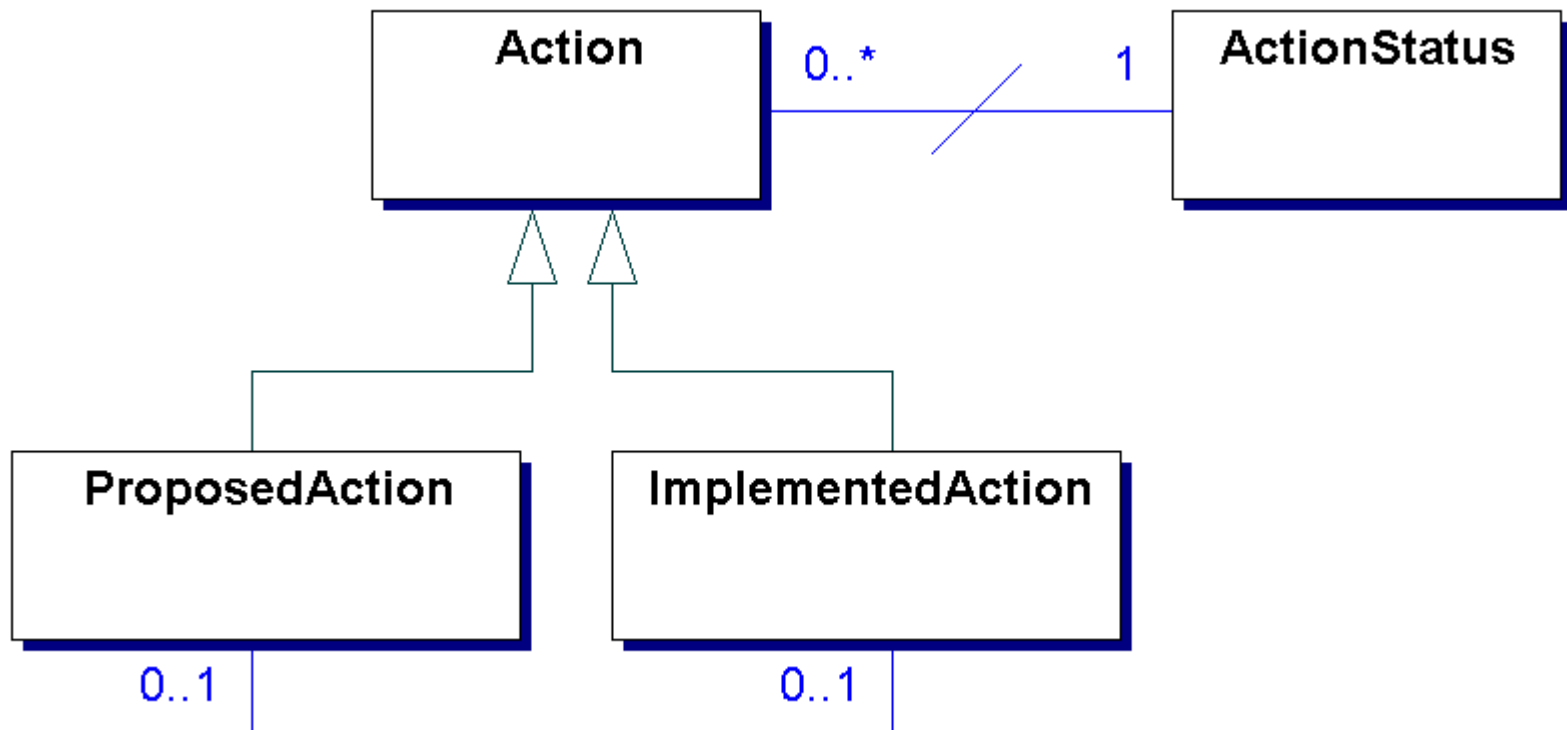
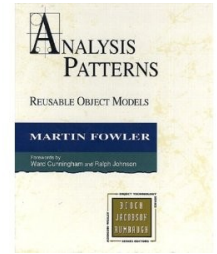

Ollie's Order Center: Proposed and Implemented Action pattern

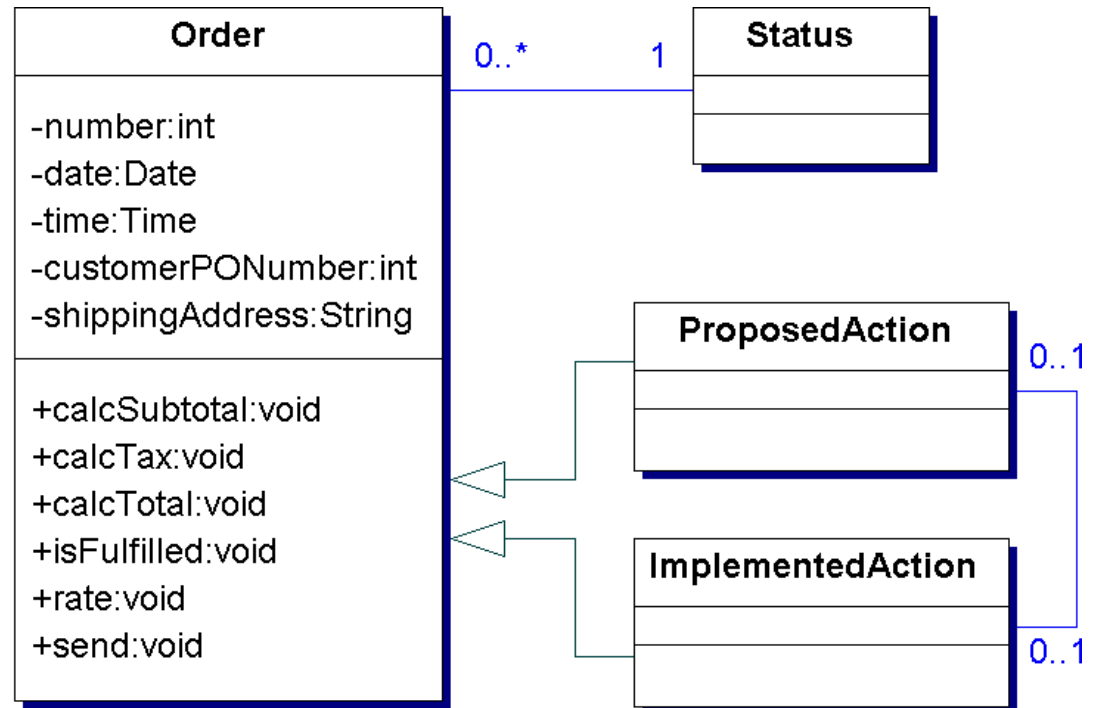
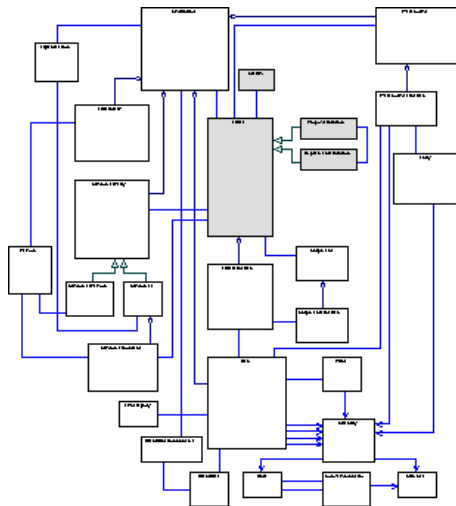
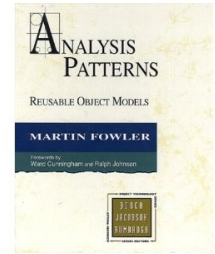

Planning – Completed and Abandoned Actions pattern

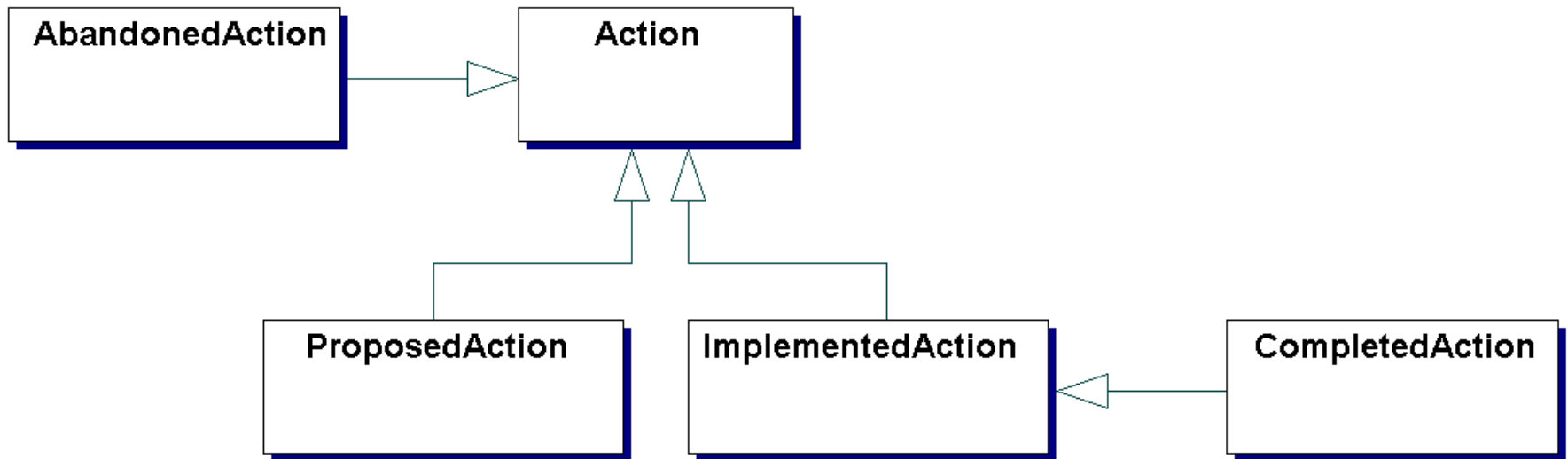
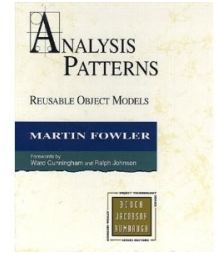

Ollie's Order Center: Completed and Abandoned Actions pattern

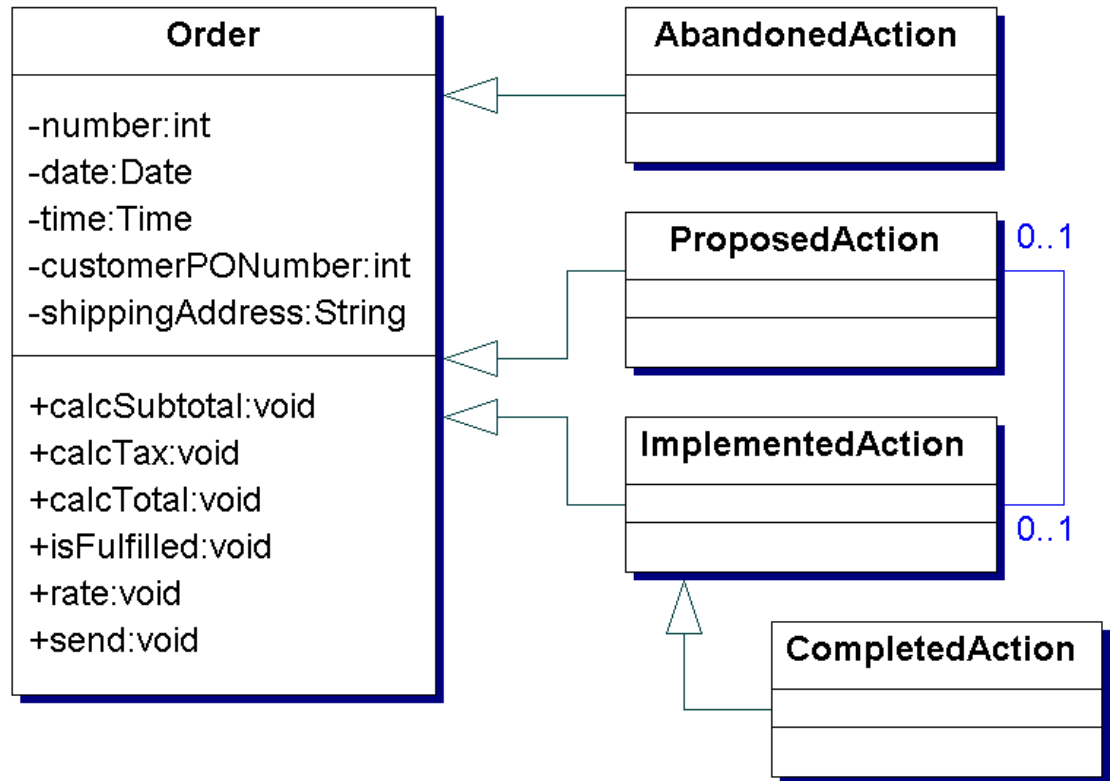
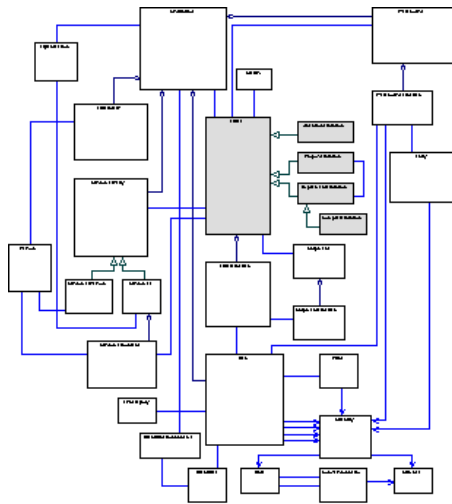
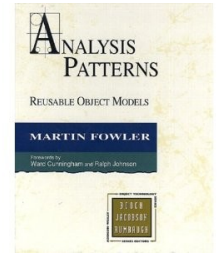

Trading – Contract pattern

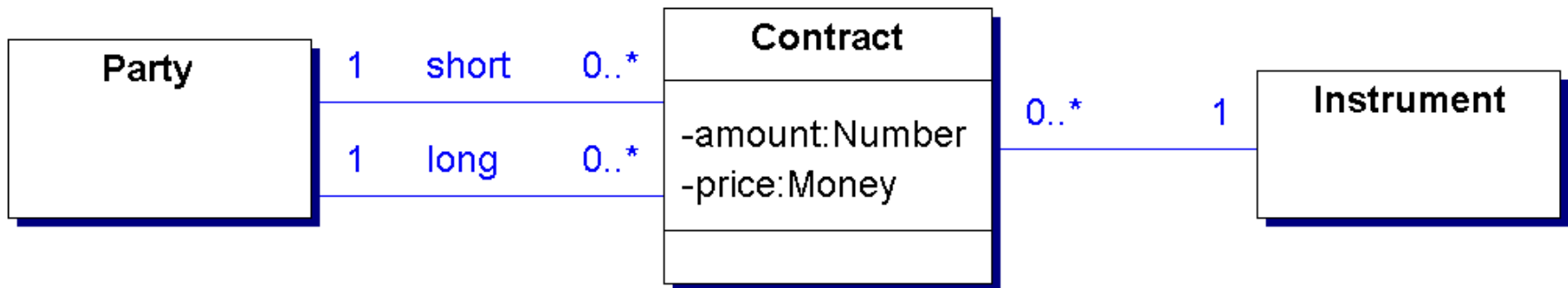
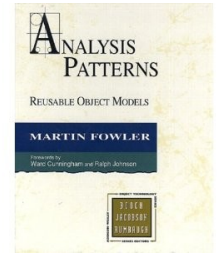

Ollie's Order Center: Contract pattern

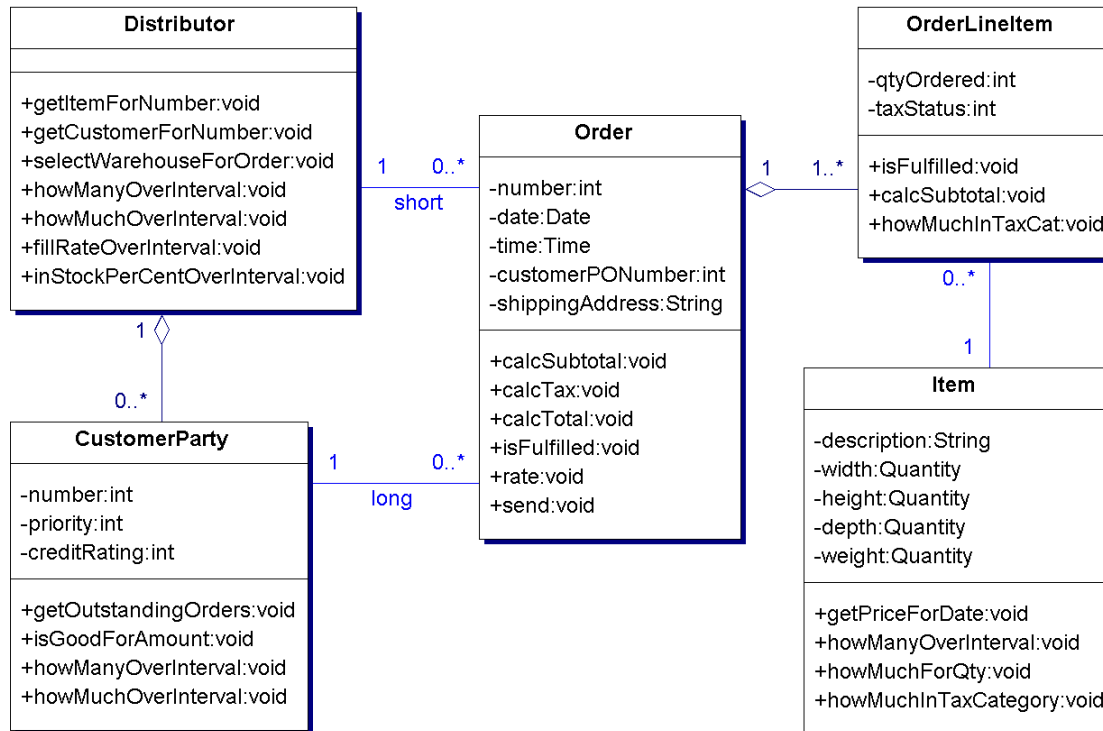
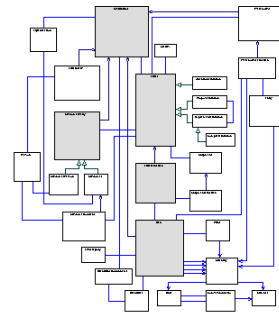
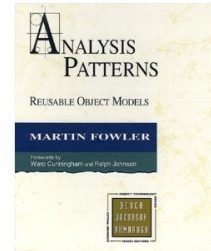

Trading – Portfolio pattern

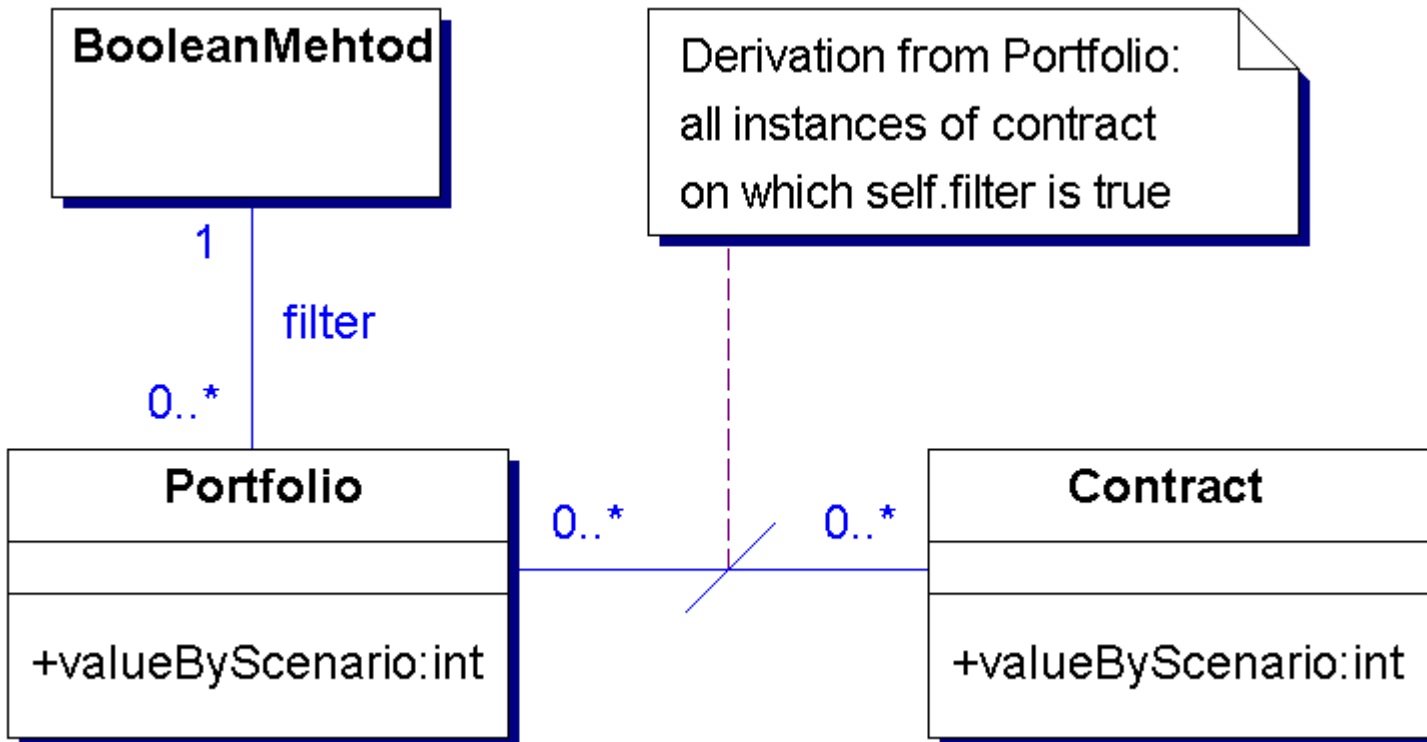
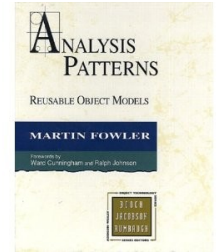

Ollie's Order Center: Portfolio pattern

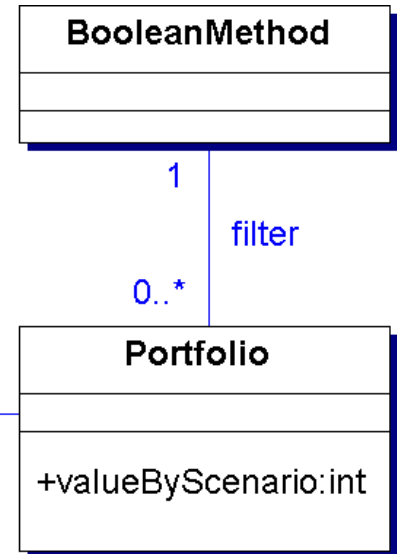
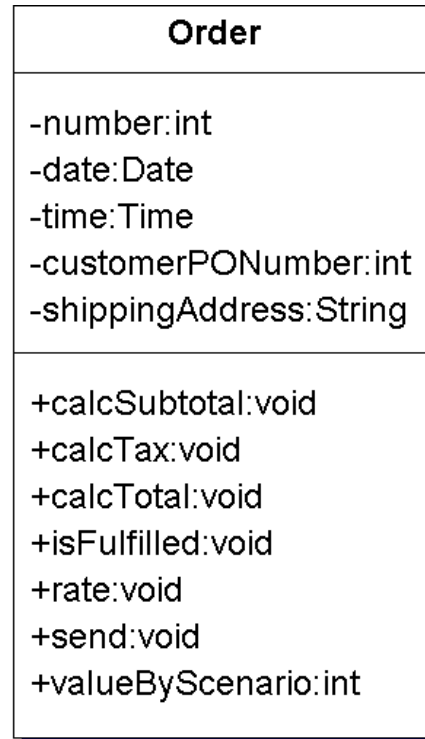
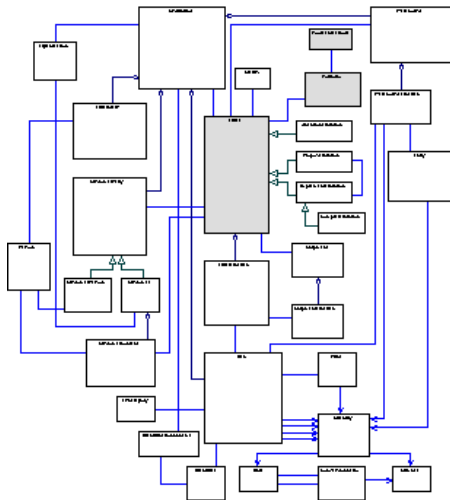
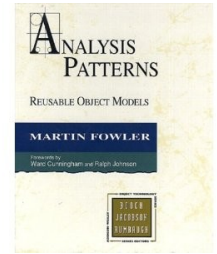

Derivative Contracts – Forward Contracts pattern

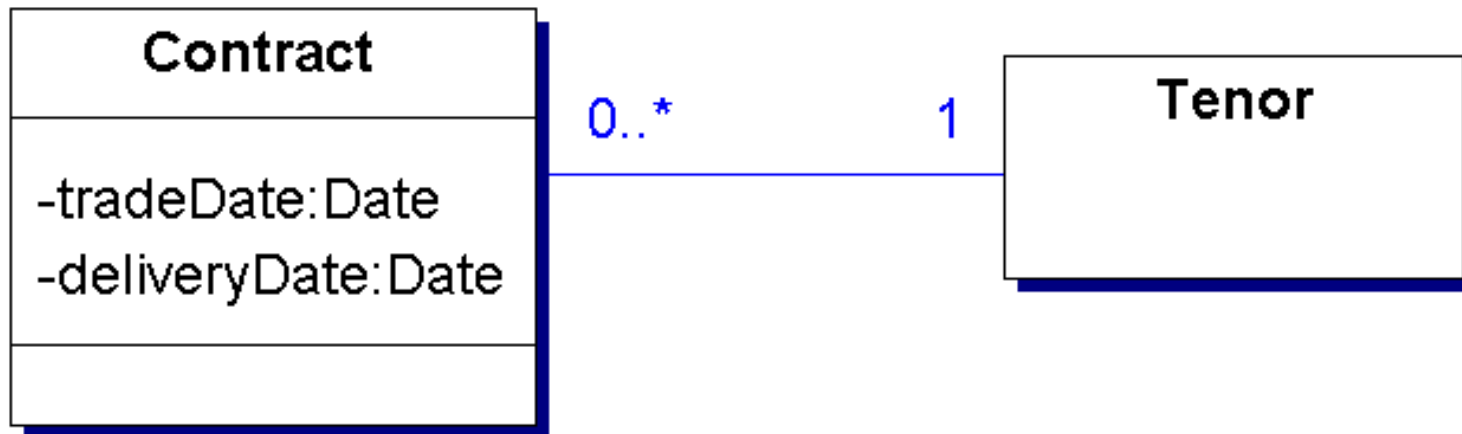
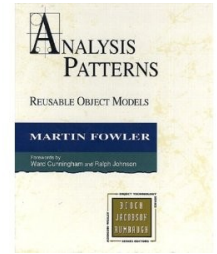

Ollie's Order Center: Forward Contracts pattern

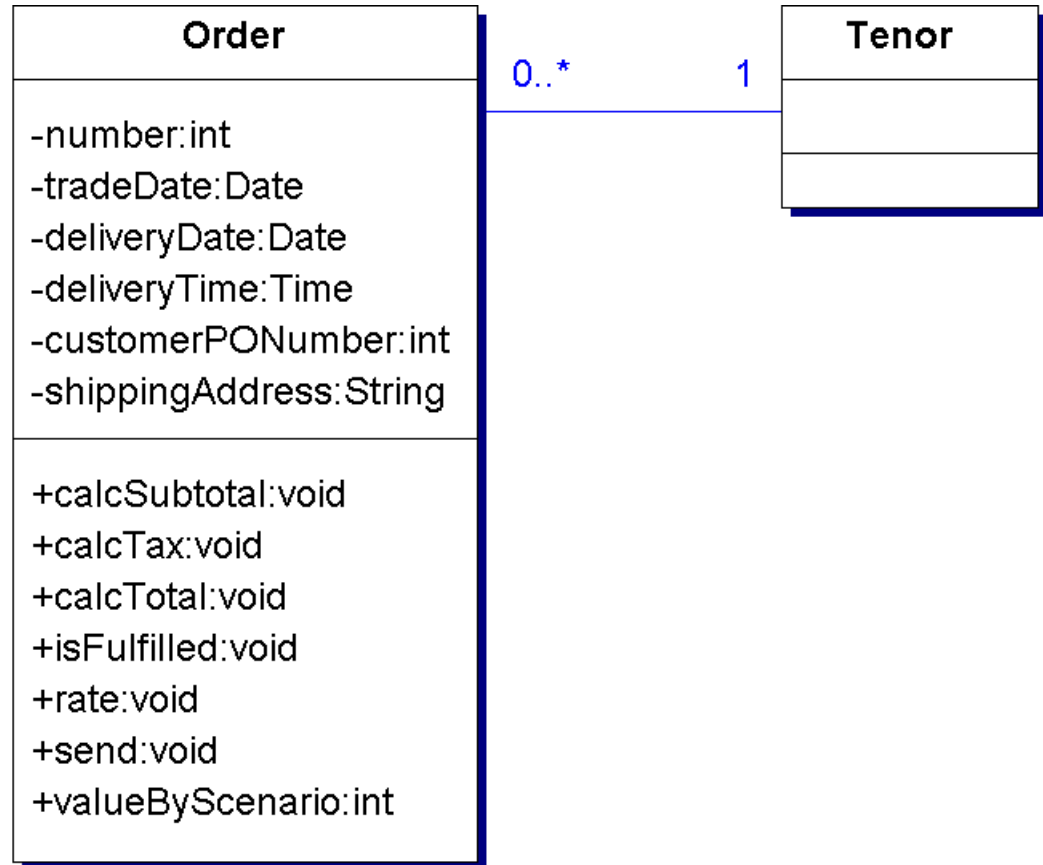
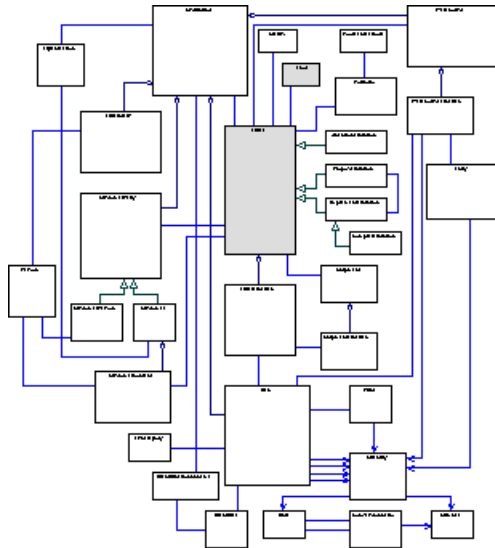
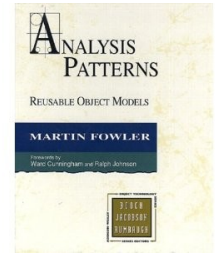

Ollie's Order Center after patterns inclusion

