

# Network topology & GNS3 LAB

- ▶ GNS 3 modeling tool
- ▶ build GNS3 simulation network
  - ▶ L2 switching
  - ▶ basic L3 routing
  - ▶ L2 & L3 redundancy
  - ▶ L2 convergence
  - ▶ L3 convergence
- ▶ Advanced network design
  - ▶ configuring VLANs, trunk ports

- ▶ Graphical Network Simulator 3
- ▶ <http://www.gns3.com/>
- ▶ network emulation tool
- ▶ can simulate complex computer networks
- ▶ can combine real and virtual devices
- ▶ mostly used for Cisco IOS devices

# Basic GNS3 usage

- ▶ add new virtual devices to network
- ▶ connect them using virtual cables
- ▶ configure new devices
- ▶ run emulated network

# GNS3: adding new device

Drag and drop new device from „Devices Toolbar“ to „workplace pane“

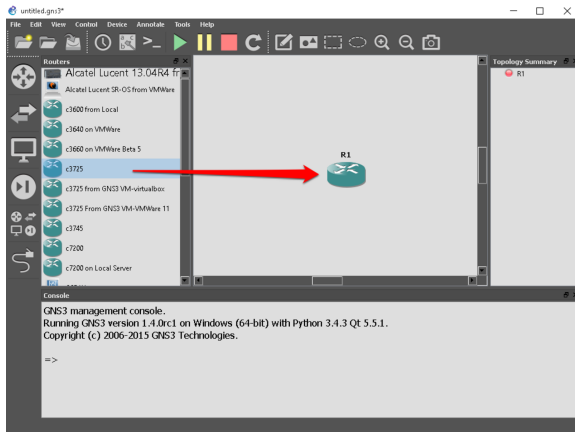

# Configure device

Hardware setup (number and type of interfaces, etc. . . ). Include switching card (NM-16ESW) in each of your routers.

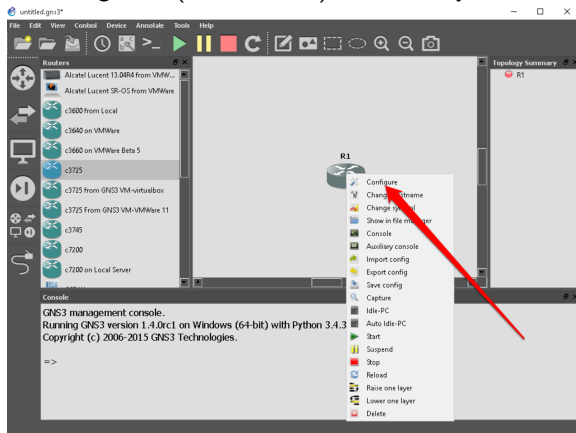

# Configure device

Hardware setup (number and type of interfaces, etc. . . ). Include switching card (NM-16ESW) in each of your routers.

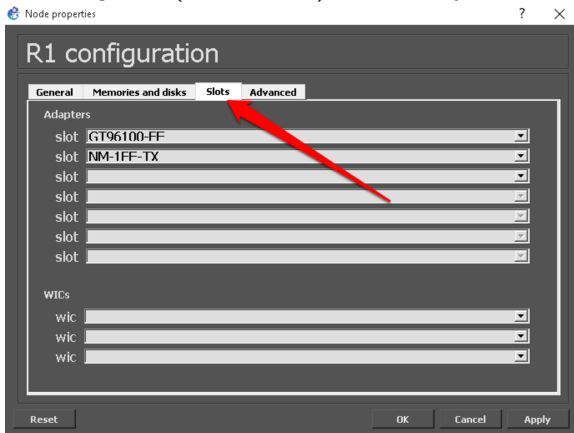

# Run and configure/setup devices

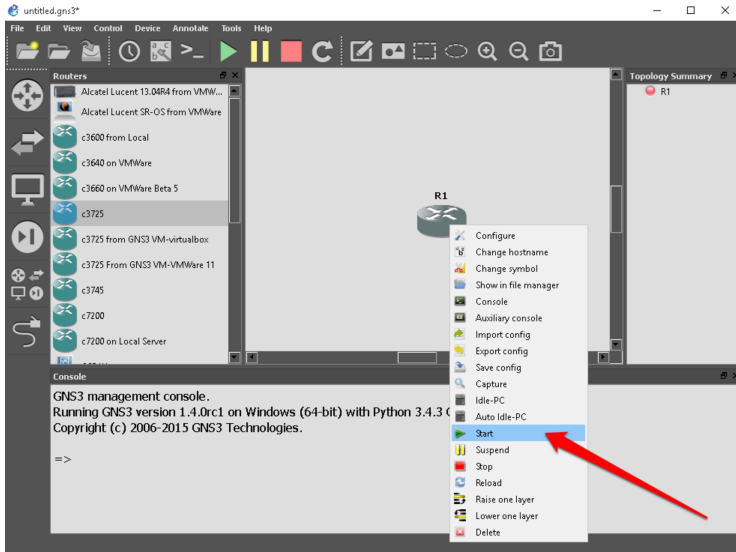

The screenshot displays the GNS3 software interface. On the left, a 'Routers' panel lists various devices, including 'Alcatel Lucent 13.04R4 from VMW...', 'Alcatel Lucent SR-OS from VMWare', and several 'c' series routers. The main workspace shows a topology with a single router labeled 'R1'. A context menu is open over 'R1', listing actions such as 'Configure', 'Change hostname', 'Change symbol', 'Show in file manager', 'Console', 'Auxiliary console', 'Import config', 'Export config', 'Save config', 'Capture', 'Idle-PC', 'Auto Idle-PC', 'Start', 'Suspend', 'Stop', 'Reload', 'Raise one layer', 'Lower one layer', and 'Delete'. The 'Start' option is highlighted in blue, and a red arrow points to it from the bottom right. At the bottom, a 'Console' window displays the following text:

```
GNS3 management console.  
Running GNS3 version 1.4.0rc1 on Windows (64-bit) with Python 3.4.3  
Copyright (c) 2006-2015 GNS3 Technologies.  
  
=>
```



# Run and configure/setup devices

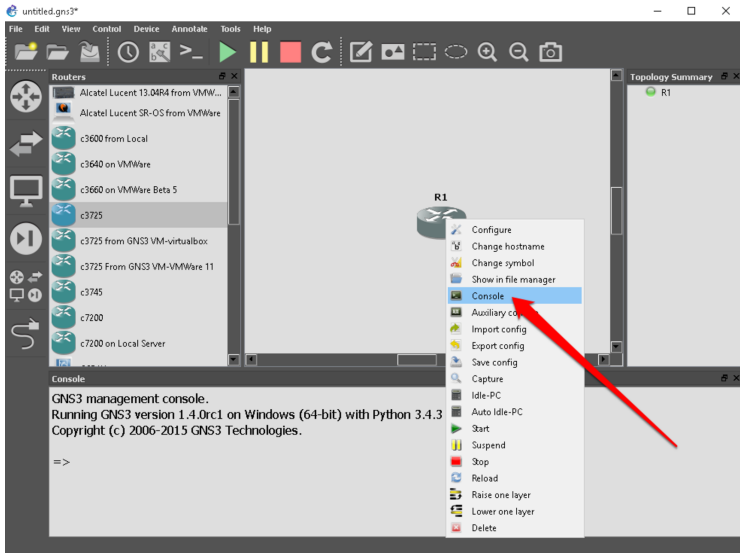

The screenshot displays the GNS3 software interface. On the left, a 'Routers' panel lists various devices, including 'Alcatel Lucent 13.04R4 from VMW...', 'Alcatel Lucent SR-OS from VMWare', and several 'c3600' models. The 'Console' option is highlighted in the context menu for router 'R1'. The main workspace shows a 3D model of router 'R1'. The bottom console window displays the text: 'GNS3 management console. Running GNS3 version 1.4.0rc1 on Windows (64-bit) with Python 3.4.3 Copyright (c) 2006-2015 GNS3 Technologies. =>'. A red arrow points to the 'Console' option in the context menu.

unbitled.gns3\*

File Edit View Control Device Annotate Tools Help

Routers

- Alcatel Lucent 13.04R4 from VMW...
- Alcatel Lucent SR-OS from VMWare
- c3600 from Local
- c3640 on VMWare
- c3660 on VMWare Beta 5
- c3725
- c3725 from GNS3 VM-virtualbox
- c3725 From GNS3 VM-VMWare 11
- c3745
- c7200
- c7200 on Local Server

Topology Summary

R1

R1

- Configure
- Change hostname
- Change symbol
- Show in file manager
- Console
- Auxiliary co
- Import config
- Export config
- Save config
- Capture
- Idle-PC
- Auto Idle-PC
- Start
- Suspend
- Stop
- Reload
- Raise one layer
- Lower one layer
- Delete

Console

GNS3 management console.  
Running GNS3 version 1.4.0rc1 on Windows (64-bit) with Python 3.4.3  
Copyright (c) 2006-2015 GNS3 Technologies.  
=>

# Run and configure/setup devices

```
R1
*Mar 1 00:00:03.903: %SYS-5-CONFIG_I: Configured from memory by console
*Mar 1 00:00:04.119: %LINK-5-CHANGED: Interface FastEthernet0/1, changed state
to administratively down
*Mar 1 00:00:04.119: %LINK-5-CHANGED: Interface FastEthernet1/0, changed state
to administratively down
*Mar 1 00:00:04.251: %SYS-5-RESTART: System restarted --
Cisco IOS Software, 3700 Software (C3725-ADVENTERPRISEK9-M), Version 12.4(15)T14
, RELEASE SOFTWARE (fc2)
Technical Support: http://www.cisco.com/techsupport
Copyright (c) 1986-2010 by Cisco Systems, Inc.
Compiled Tue 17-Aug-10 12:08 by prod_rel_team
*Mar 1 00:00:04.259: %SNMP-5-COLDSTART: SNMP agent on host R1 is undergoing a c
old start
*Mar 1 00:00:04.311: %LINK-5-CHANGED: Interface FastEthernet0/0, changed state
to administratively down
*Mar 1 00:00:04.327: %CRYPTO-6-ISAKMP_ON_OFF: ISAKMP is OFF
*Mar 1 00:00:04.327: %CRYPTO-6-GDOI_ON_OFF: GDOI is OFF
*Mar 1 00:00:05.119: %LINEPROTO-5-UPDOWN: Line protocol on Interface FastEthern
et0/1, changed state to down
*Mar 1 00:00:05.119: %LINEPROTO-5-UPDOWN: Line protocol on Interface FastEthern
et1/0, changed state to down
*Mar 1 00:00:05.311: %LINEPROTO-5-UPDOWN: Line protocol on Interface FastEthern
et0/0, changed state to down
R1#
```

GNS3 emulator may consume up to 100 % of your CPU emulating router processor. GNS 3 may find idle loops in emulated software and interrupt emulation to let other processes on host computer run their part.

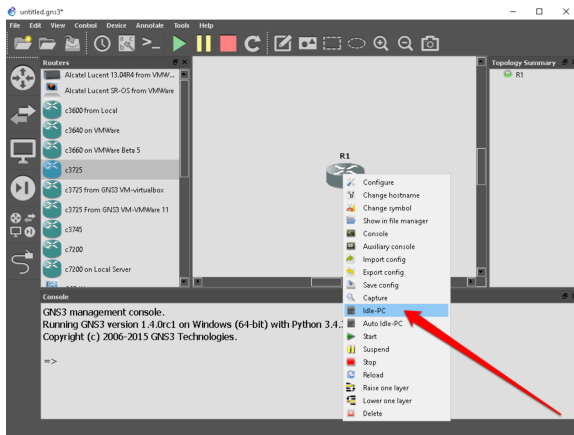

# Connecting devices

Connect devices by drawing connection between them – select appropriate interfaces (if you plan to do switching labs, you have to connect to switching interfaces (NM-16ESW))

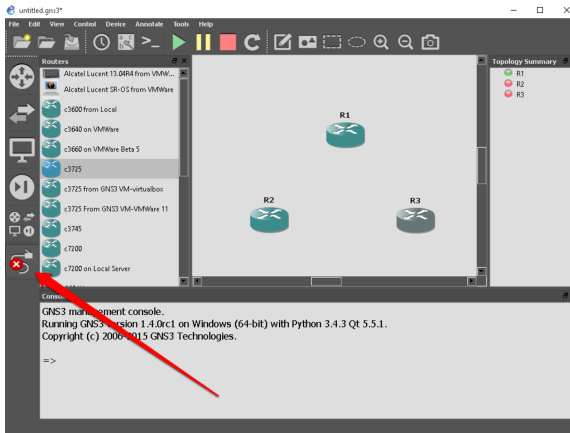

# Campus topology

- ▶ what is campus? Number of nearby buildings belonging to one organisation, usually connected by technology infrastructure.
- ▶ In computer network terms, campus usually connects:
  - ▶ clients – wired or wireless. These devices are not built to be highly available, no need to connect them HA.
  - ▶ servers – placed in the local datacenter are equipped with high availability components (at least two power supplies, network interfaces, iLO, etc.)
- ▶ campus network topology should be designed highly-available (prone to failure of X components – X should be larger than 0 – depending on ones needs) like servers. Network devices with multiple power supplies connected to multiple power distribution sources, connected to other network devices using multiple interfaces using separated physical path, etc. . . )

# Campus technology – hierarchical model

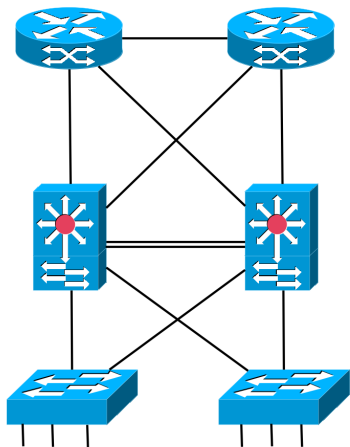

# Campus technology – hierarchical model

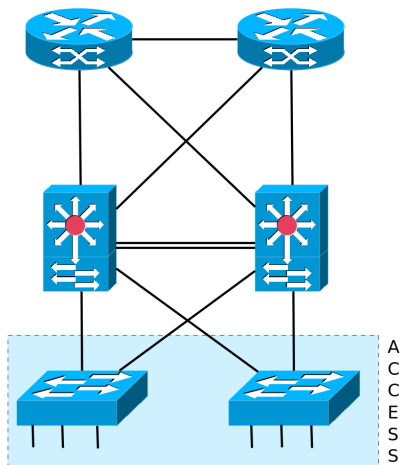

- ▶ **access layer** – connects network end devices to computer network (clients and servers). Access layer switches are placed on premises, where it meets physical topology constraints (100m distance from clients Cat 5E cables)

# Campus technology – hierarchical model

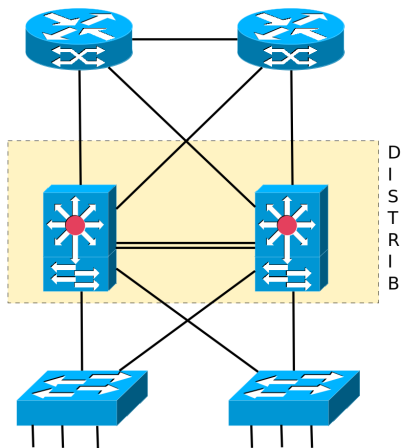

- ▶ **distribution layer** – aggregates links from access layer switches and connects them to core layer devices
- ▶ **access layer** – connects network end devices to computer network (clients and servers). Access layer switches are placed on premises, where it meets physical topology constraints (100m distance from clients Cat 5E cables)



# Campus technology – hierarchical model

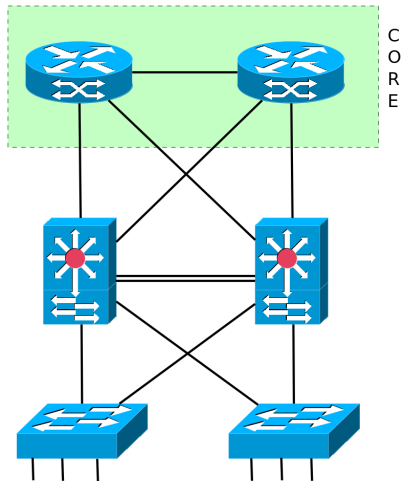

- ▶ **core layer** – backbone of campus computer network, usually located in the centre of campus, minimising needs for fully meshed network. Provides connection to the outside world, advanced network services (dynamic routing, firewalls, load balancers, VRRP, HSRP, etc. . . )
- ▶ **distribution layer** – aggregates links from access layer switches and connects them to core layer devices
- ▶ **access layer** – connects network end devices to computer network (clients and servers). Access layer switches are placed on premises, where it meets physical topology constraints (100m distance from clients Cat 5E cables)

# Campus technology – hierarchical model

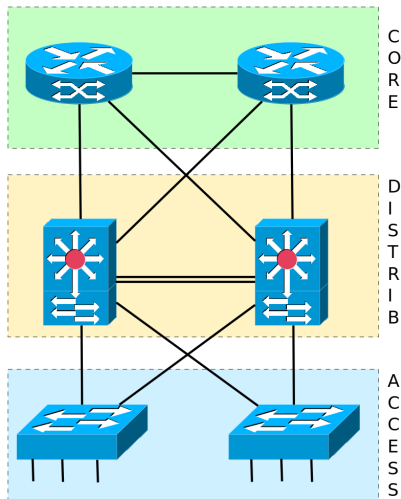

- ▶ **core layer** – backbone of campus computer network, usually located in the centre of campus, minimising needs for fully meshed network. Provides connection to the outside world, advanced network services (dynamic routing, firewalls, load balancers, VRRP, HSRP, etc. . . )
- ▶ **distribution layer** – aggregates links from access layer switches and connects them to core layer devices
- ▶ **access layer** – connects network end devices to computer network (clients and servers). Access layer switches are placed on premises, where it meets physical topology constraints (100m distance from clients Cat 5E cables)

## Pros:

- ▶ doesn't matter, where is end device located. It may be part of every VLAN in campus.
- ▶ simplifies moving of personel in campus. No need to change firewall rules, because IP address may stay the same.

## Cons:

- ▶ broadcast and unknown unicast frames spread across whole campus
- ▶ STP creates tree topology, limiting use of additional communication lines
- ▶ running STP on big number of switches may lead to network problems (theoretically no, but. . . „In theory there is no difference between theory and practice. In practice there is.“)

# L3 campus topology

## Pros:

- ▶ broadcast and unknown unicast frames are limited to smaller part of campus.
- ▶ L3 topology can use more bandwidth/lines, because advanced routing protocol don't create tree topology
- ▶ STP creates smaller topology

## Cons:

- ▶ transfer of IP address between buildings is limited (almost impossible)
- ▶ frequent moving may lead to frequent changes of firewall rules (very impractical)

# LAB 1: simple L2 topology

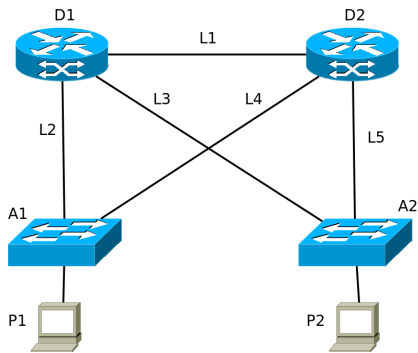

Host	IP
P1	192.168.1.11/24
P2	192.168.1.12/24

1. make D1 root bridge in spanning tree topology
2. make D2 secondary root bridge in spanning tree topology (becomes root bridge in case of D1 failure)
3. ping from P1 to P2
4. find out path of PING and PING REPLY packets
5. disconnect line L2 (shut down line L2 on switch A1), observe how long does it take to converge
6. find out path of PING and PING REPLY packets

# LAB 1: commands to use

```
Router>en
Router#conf t
Router(config)#hostname D1
D1(config)#spanning-tree vlan 1 root primary    <-- sets D1 switch as primary root
D1(config)#exit
D1#show spanning-tree brief                    <-- find out where root port is
D1#show mac-address-table address <PC Px MAC address>

D2(config)#spanning-tree vlan 1 root secondary <-- sets D2 switch as secondary root
D2(config)#exit
D2#show spanning-tree brief                    <-- find out where root port is
D2#show mac-address-table address <PC Px MAC address>

A1(config)#interface FastEthernet 1/0
A1(config-if)#shutdown                        <-- disable ethernet port (causes STP recalculation)
```

# LAB 2: L3 topology & OSPFv2

Topology: routed campus (routing between core and distribution layer, switching between distribution layer)

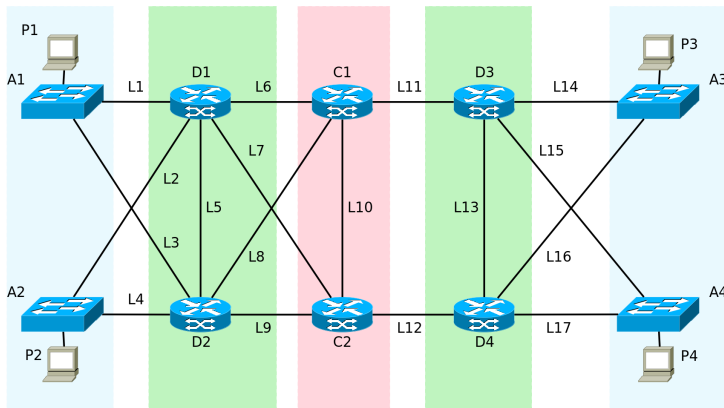

# LAB 2: description

device	description
A1, A2, A3, A4	access-switch
D1, D4	primary STP root
D2, D3	secondary STP root
C1, C2	core routers
P1	VLAN 10, 192.168.10.10/24
P2	VLAN 20, 192.168.20.20/24
P3	VLAN 30, 192.168.30.30/24
P4	VLAN 40, 192.168.40.40/24

VLAN	description
10 (HQ)	HSRP: D1 primary, D2 secondary, default GW: 192.168.10.1
20 (ENG)	HSRP: D2 primary, D1 secondary, default GW: 192.168.20.1
30 (PR)	HSRP: D3 primary, D4 secondary, default GW: 192.168.30.1
40 (HR)	HSRP: D4 primary, D3 secondary, default GW: 192.168.40.1



## LAB 2: description

line	description
L1, L2, L3, L4, L5, L14, L15, L16, L17	switched, 802.1Q trunk
L6	routed, 192.168.0.0/30, cost 50
L7	routed, 192.168.0.4/30, cost 1
L8	routed, 192.168.0.8/30, cost 10
L9	routed, 192.168.0.12/30, cost 50
L10	routed, 192.168.0.16/30, cost 1
L11	routed, 192.168.0.20/30, cost 1
L12	routed, 192.168.0.24/30, cost 20
L13	routed, 192.168.0.28/30, cost 1

All links and IP networks are in OSPF area 0 (backbone), including all VLANs (advanced: VLANs as OSPF passive interfaces).

## LAB 2, task 1: topology and packet path

1. run traceroute command between hosts P1 and P4
2. find out L3 path of packets between P1 and P4
3. find out L2 path of packets between P1 and P4

## LAB 2: commands to use

```
D1#vlan database                                create VLANs
D1(vlan)#vlan 10 name HQ
D1(vlan)#vlan 20 name ENG
D1(vlan)#apply
D1(vlan)#exit

D1#conf t
D1(config)#int Vlan 10                          configure VLAN interface
D1(config-if)#ip address 192.168.10.2 255.255.255.0
D1(config-if)#standby 10 ip 192.168.10.1       default GW address
D1(config-if)#standby 10 priority 100         HSRP priority, higher is better
D1(config-if)#no shut

D1(config)#int FastEthernet 0/0
D1(config-if)#ip address 192.168.0.5 255.255.255.252
D1(config-if)#no shut
D1(config-if)#ip ospf cost 50

D1(config)#router ospf 1                       run OSPF process
D1(config-router)#network 192.168.0.0 0.0.0.3 area 0 networks where OSPF runs
D1(config-router)#network 192.168.0.4 0.0.0.3 area 0
D1(config-router)#passive-interface Vlan10    OSPF process doesn't listen on this interface

D1#show ip route <Px IP address>
```

## LAB 2, task 2: L3 convergence

1. run ping command between hosts P1 and P4,
2. disconnect line L7 and observe how many ping packets are lost.
3. Connect line L7 and observe packet loss, if any.
4. Try to minimize convergence time by lowering OSPF hello and dead timers on interfaces (advanced: OSPF point-to-point link definition on point to point links)
5. Rerun this test again.

- ▶ GNS3, <http://www.gns3.com/>
- ▶ Cisco validated design, Campus Zone <http://www.cisco.com/c/en/us/solutions/enterprise/design-zone-campus/index.html>
- ▶ Campus Network for High Availability Design Guide , [http://www.cisco.com/c/en/us/td/docs/solutions/Enterprise/Campus/HA\\_campus\\_DG/hacampusdg.html](http://www.cisco.com/c/en/us/td/docs/solutions/Enterprise/Campus/HA_campus_DG/hacampusdg.html)
- ▶ IP Routing: OSPF Configuration Guide, [http://www.cisco.com/c/en/us/td/docs/ios-xml/ios/iproute\\_ospf/configuration/12-4/iro-12-4-book.html](http://www.cisco.com/c/en/us/td/docs/ios-xml/ios/iproute_ospf/configuration/12-4/iro-12-4-book.html)
- ▶ Configuring HSRP, [http://www.cisco.com/c/en/us/td/docs/ios-xml/ios/ipapp\\_fhrp/configuration/12-4/fhp-12-4-book/fhp-hsrp.html](http://www.cisco.com/c/en/us/td/docs/ios-xml/ios/ipapp_fhrp/configuration/12-4/fhp-12-4-book/fhp-hsrp.html)