



# PA160: Net-Centric Computing II.

## Specification and Verification of Network Protocols

**Vojtěch Řehák**

Spring 2019





## Theory Definition and Usage

# Theory

# Theory Definition and Usage

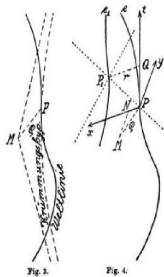

$$\mathcal{L} = m \sqrt{g_{\mu\nu} \frac{dx^\mu}{d\tau} \frac{dx^\nu}{d\tau}}$$

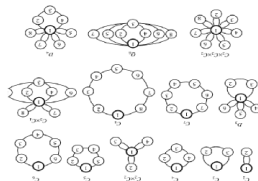

# Theory

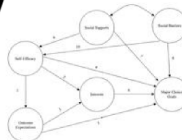
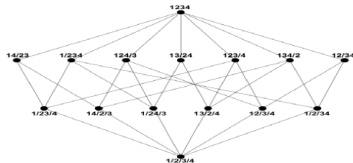

$$\int_a^b f(x) dx = F(b) - F(a)$$



# Theory Definition and Usage

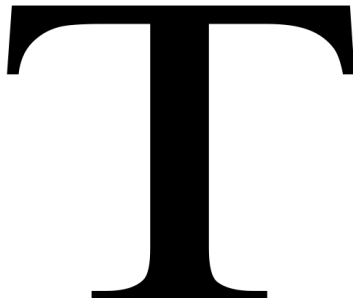



# Theory Definition and Usage

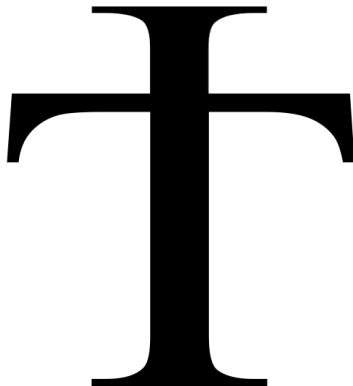

# Theory Definition and Usage

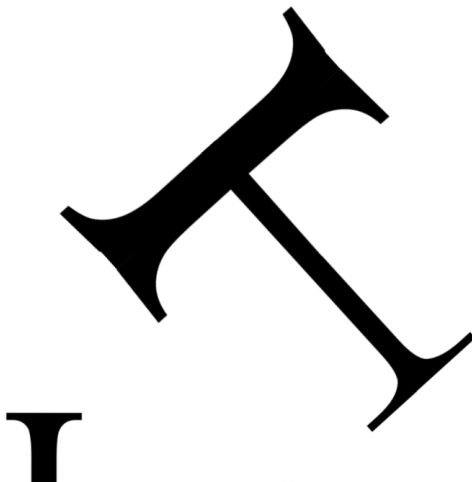

# Theory Definition and Usage

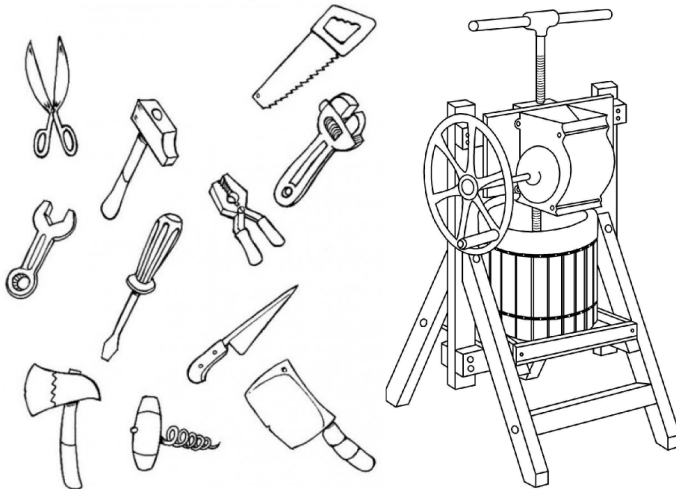



## Theoretical Results as Tools for Users



## Formal Models - what are they good for

The basic concept is a *model* of system (i.e. the object we work with).

### thought handling

- individual approach (intra-brain) - to grasp it
- documentation (inter-brain) - to pass it on

### automatic/computer processing (comparing model to specification)

- testing
- simulation
- symbolic execution
- static analysis
- model checking
- equivalence checking
- theorem proving

## Formal Models in Specification

natural language **vs.** formal language

freedom in writing 

 restrictions in writing

human resources 

 automatic methods

## Formal Models in Specification

natural language **vs.** formal language

freedom in writing 

 restrictions in writing

human resources 

 automatic methods

nothing  $\leq$  text  $\leq$  structured text  $\leq$  text with formal “pictures”  $\leq$   
 formal description with informal comments  $\leq$  complete formal  
 description

## Formal Models in Specification

natural language **vs.** formal language

freedom in writing 

 restrictions in writing

human resources 

 automatic methods

nothing  $\leq$  text  $\leq$  structured text  $\leq$  text with formal “pictures”  $\leq$   
 formal description with informal comments  $\leq$  complete formal  
 description

**Goal:** Find an appropriate level of abstraction and keep it.

## Formal Models in Specification

natural language **vs.** formal language

freedom in writing 

 restrictions in writing

human resources 

 automatic methods

nothing  $\leq$  text  $\leq$  structured text  $\leq$  text with formal “pictures”  $\leq$   
 formal description with informal comments  $\leq$  complete formal  
 description

**Goal:** Find an appropriate level of abstraction and keep it.

“What will be the model used for?”

## Map - Abstraction Example



Find Pardubice or directions from Brno to Liberec.

source: [www.mapy.cz](http://www.mapy.cz)

## Map - Abstraction Example



Find Pardubice or directions from Brno to Liberec.

source: [www.mapy.cz](http://www.mapy.cz)

## Map - Abstraction Example

“Model has to suit its **purpose!**”

Only relevant information are presented; no more, no less.



## Outline

Models we will talk about:

- Message Sequence Charts (MSC)
- Specification and Description Language (SDL)
- Petri nets
- Queueing theory

What they can be used for?

- modelling
- specification
- analysis
- simulation
- testing
- partial implementation



# Distributed Systems

“What is the problem of distributed systems?”

# Distributed Systems

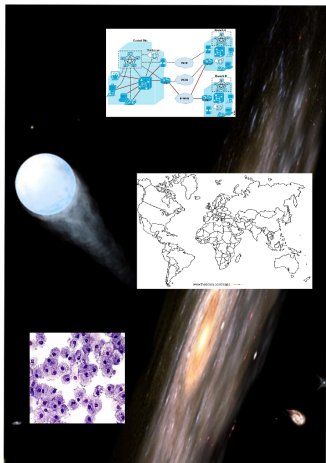

World is distributed

# Distributed Systems

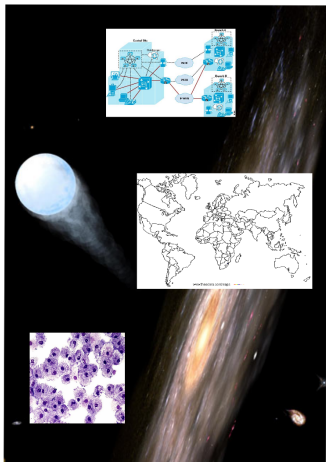

World is distributed



Human way of thinking is sequential

## Distributed vs. Local

# SDL

Specification Description  
Language

ITU-T Z.100

# MSC

Message Sequence  
Chart

ITU-T Z.120

## Distributed vs. Local

### SDL

Specification Description  
Language

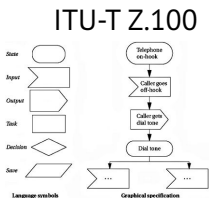

models of components

### MSC

Message Sequence  
Chart

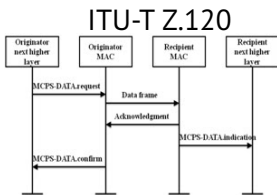

communication model



# Message Sequence Chart (MSC)

Message Sequence Chart (MSC)

# Message Sequence Chart (MSC)

international standard of ITU-T, Z.120

- 1993 - first version of Z.120 recommendation
- ...
- 2011 - current version of Z.120 recommendation
- all documents of the current version:
  - Z.120 - Message Sequence Chart (MSC)
  - Z.120 Annex B - Formal semantics of message sequence charts
  - Z.121 - Specification and Description Language (SDL) data binding to Message Sequence Charts (MSC)



## Message Sequence Chart (MSC)

international standard of ITU-T, Z.120

- 1993 - first version of Z.120 recommendation
- ...
- 2011 - current version of Z.120 recommendation
- all documents of the current version:
  - Z.120 - Message Sequence Chart (MSC)
  - Z.120 Annex B - Formal semantics of message sequence charts
  - Z.121 - Specification and Description Language (SDL) data binding to Message Sequence Charts (MSC)

It formally defines both textual and graphical form.

MSC is a similar concept to UML Sequence Charts.

## Message Sequence Chart (MSC)

A **trace language** for the specification and description of the **communication behaviour** by means of **message exchange**.

Describes

- communicating processes,
- communication traces,
- message order,
- time information (timeouts, constraints),
- high-level form for set of traces.

# Message Sequence Chart (MSC)

msc diagram

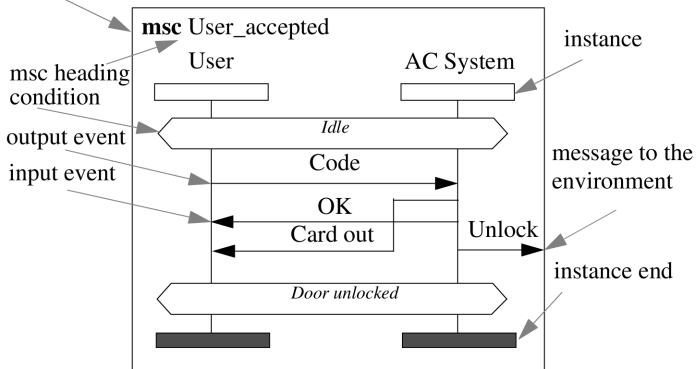

## Message Sequence Chart (MSC) - semantics

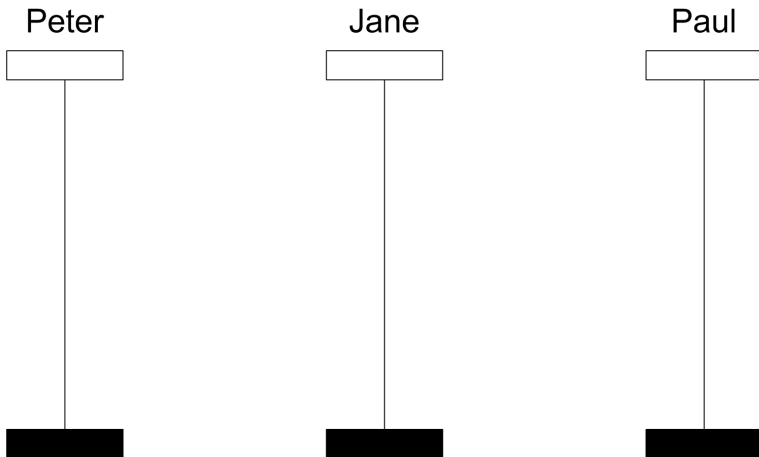

## Message Sequence Chart (MSC) - semantics

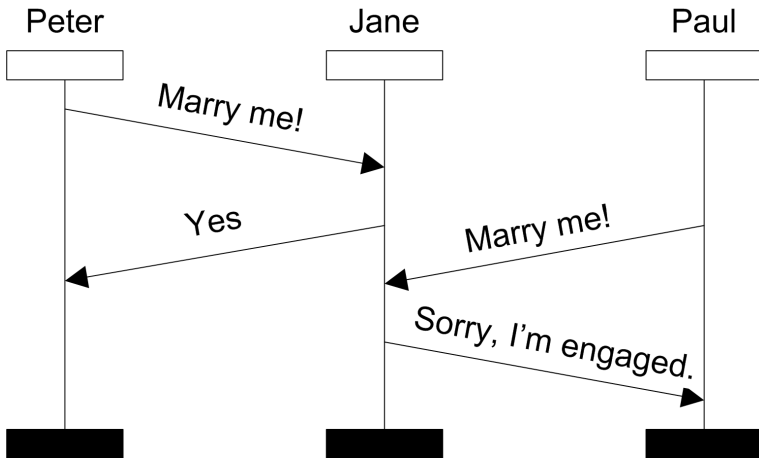

## Message Sequence Chart (MSC) - semantics

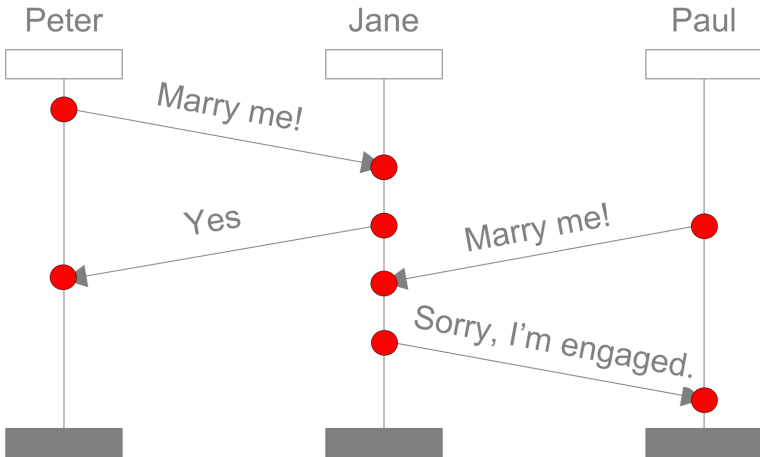

## Message Sequence Chart (MSC) - semantics

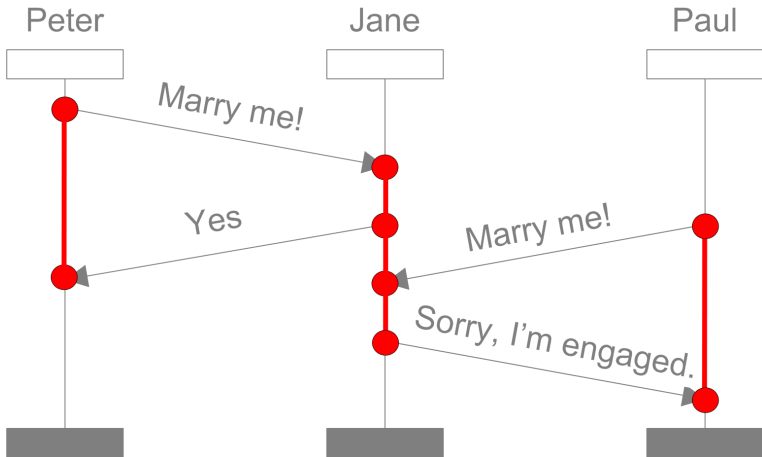

# MSC - Visual Order

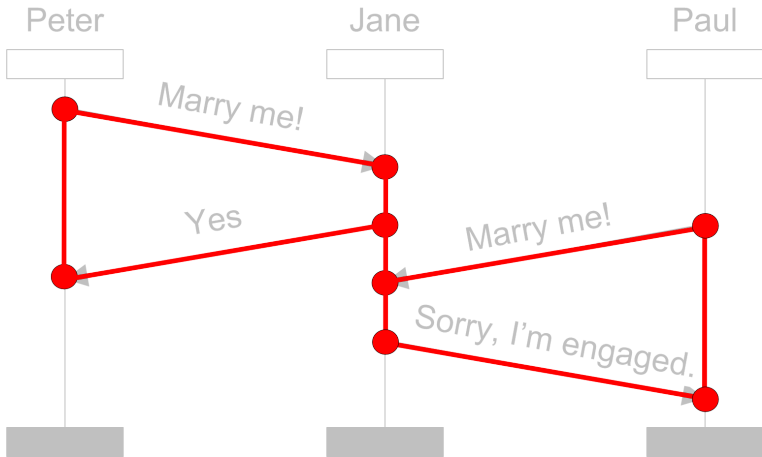



# MSC - Visual Order - Hasse Diagram

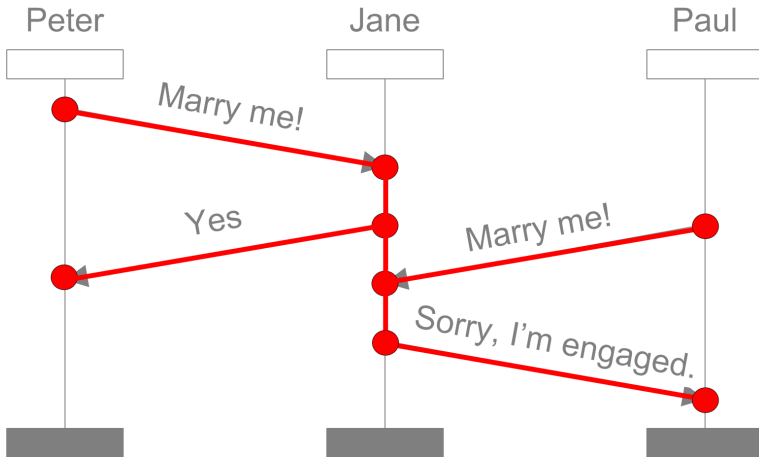



# MSC Properties

**What is an unwanted behaviour/property?**

# MSC Properties

## What is an unwanted behaviour/property?

Fundamental problems in the specified model, e.g. an implementation of the model does not exist in the given environment.

## Acyclic/Cyclic property

cyclic dependency among events

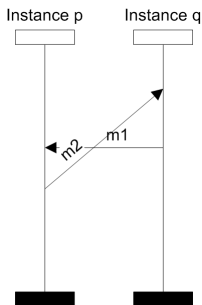

unrealizable in any environment

# Acyclic/Cyclic property

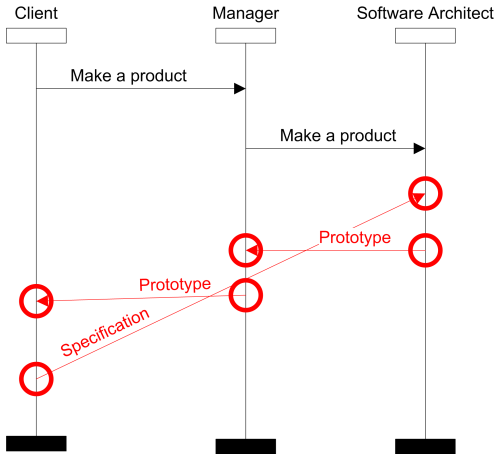

# FIFO/non-FIFO property

overleaping messages

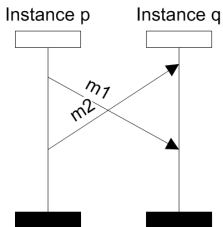

# FIFO/non-FIFO property

overleaping messages

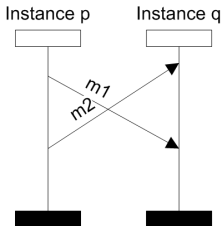

unrealizable in an environment preserving message order

# FIFO/non-FIFO property

## overleaping messages

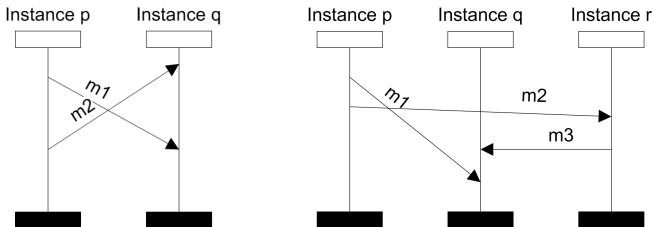

unrealizable in an environment preserving message order



## FIFO/non-FIFO property

### overleaping messages

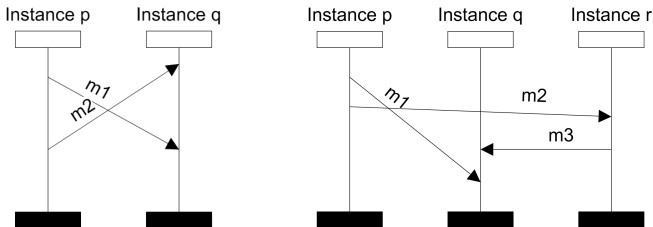

unrealizable in an environment preserving message order

realizable in an environment with P2P channels but unrealizable in case of one global channel

# Race Condition

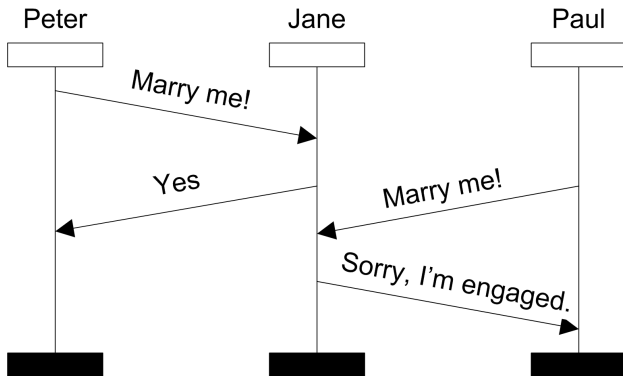

## Race Condition

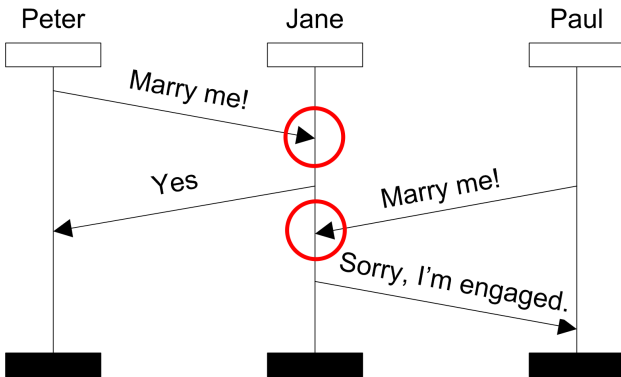

## Race Condition

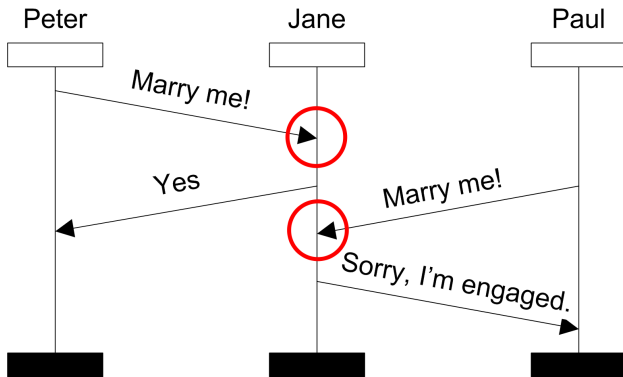

Informally, **race** is when some receive event can come earlier.



## Solution #1 - Coregion Construction

Let us demonstrate that some events are not ordered.

## Solution #1 - Coregion Construction

Let us demonstrate that some events are not ordered.

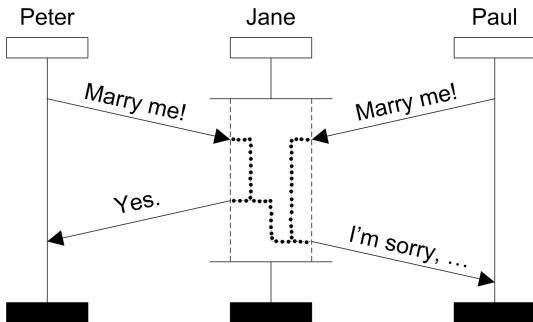

## Solution #1 - Coregion Construction

Let us demonstrate that some events are not ordered.

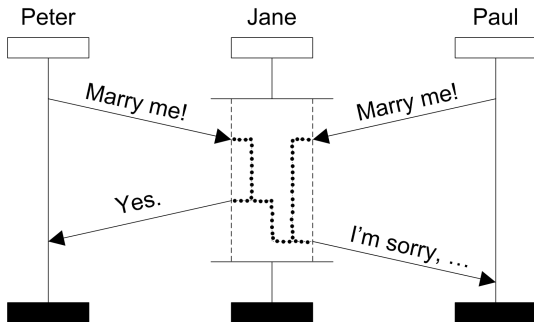

Events in a *coregion* are not ordered;  
except for the event related by *general ordering*.

## Solution #2 - List/set of all possibilities

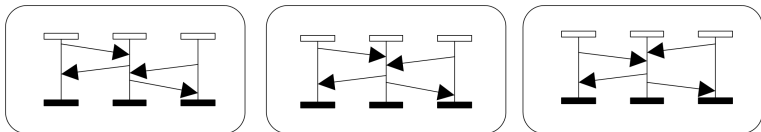



# High-Level MSC (HMSC)

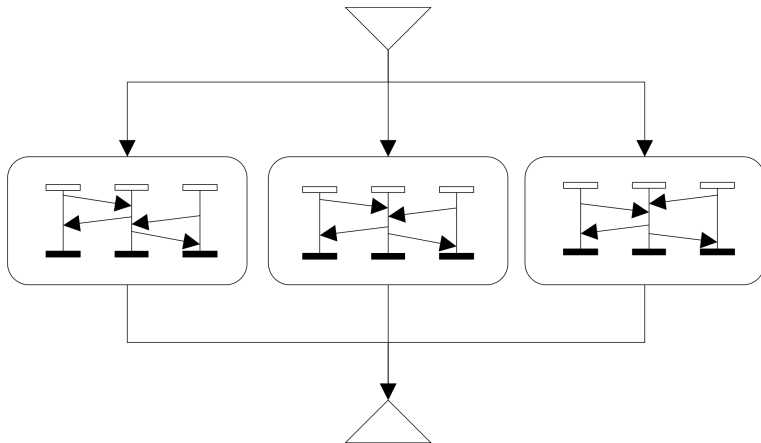

# High-Level MSC (HMSC) - ITU-T Z.120

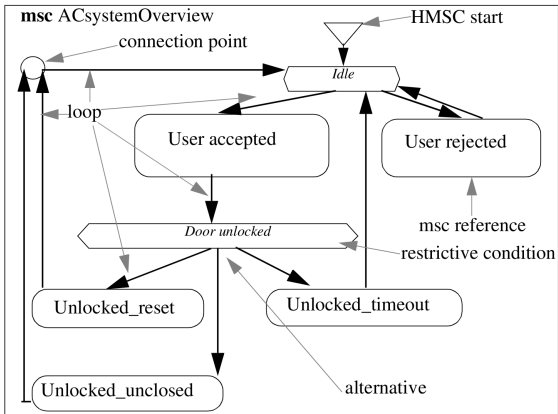

## High-Level MSC (HMSC) - ITU-T Z.120

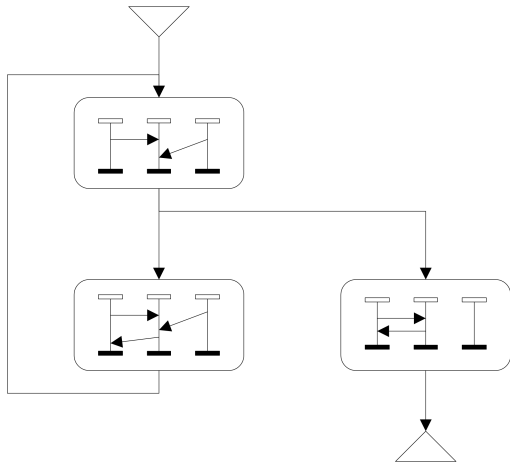

# High-Level MSC (HMSC) - ITU-T Z.120

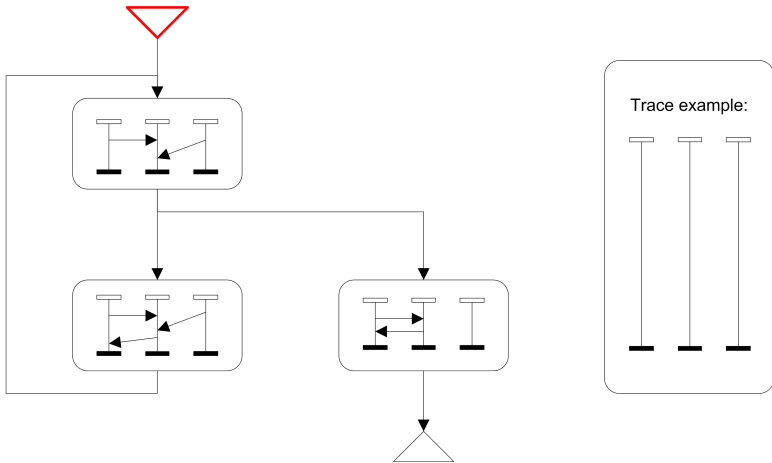

# High-Level MSC (HMSC) - ITU-T Z.120

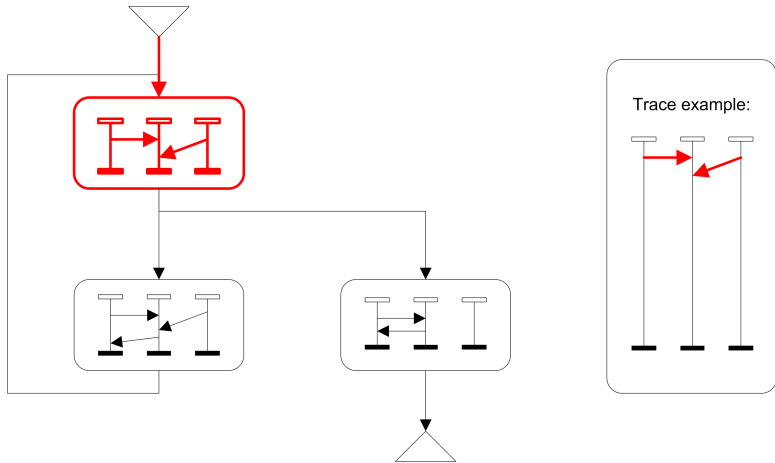

# High-Level MSC (HMSC) - ITU-T Z.120

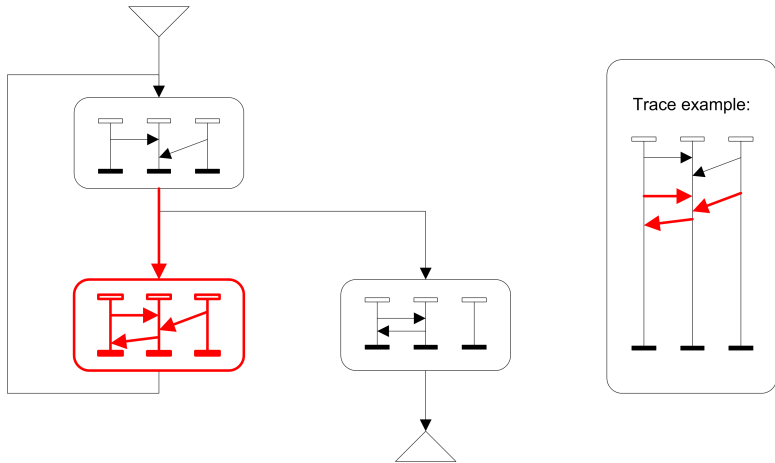

## High-Level MSC (HMSC) - ITU-T Z.120

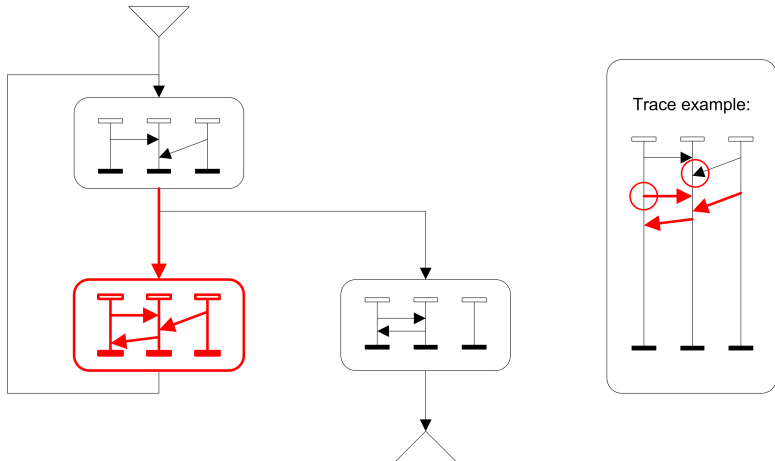

Trace example:

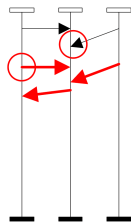

these events are not ordered!

# High-Level MSC (HMSC) - ITU-T Z.120

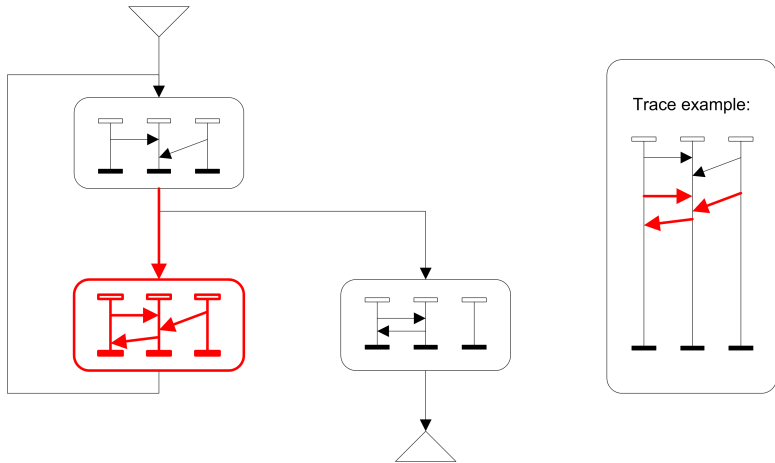



# High-Level MSC (HMSC) - ITU-T Z.120

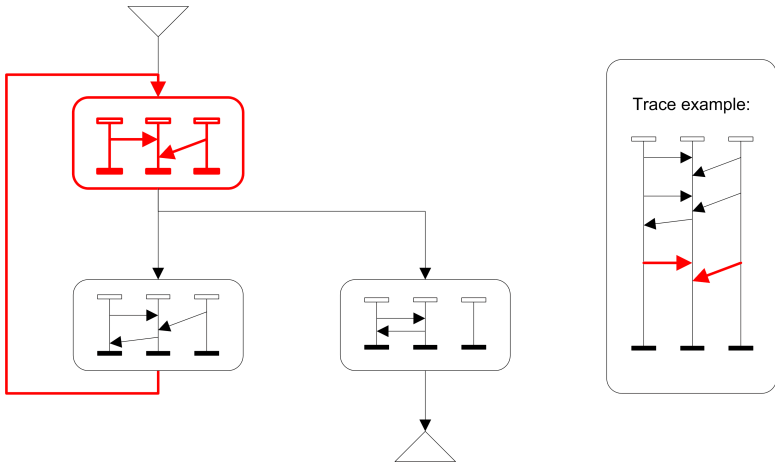

## High-Level MSC (HMSC) - ITU-T Z.120

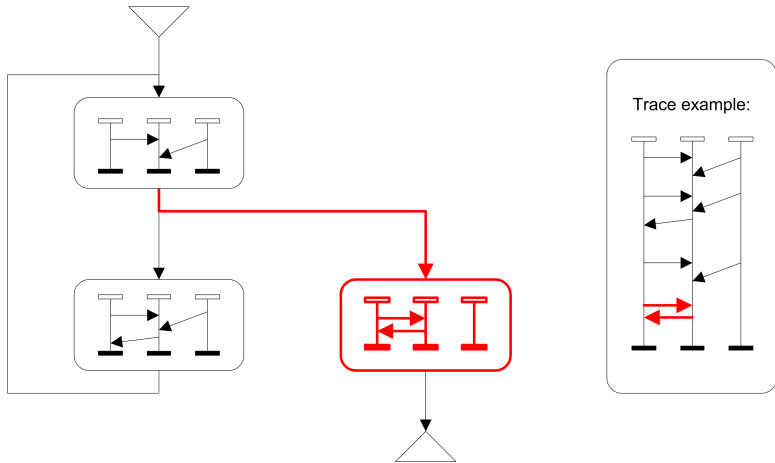

# High-Level MSC (HMSC) - ITU-T Z.120

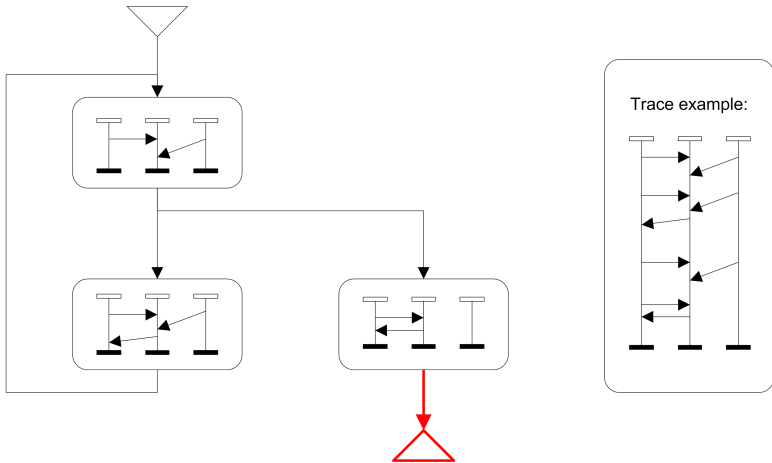

# High-Level MSC (HMSC) - ITU-T Z.120

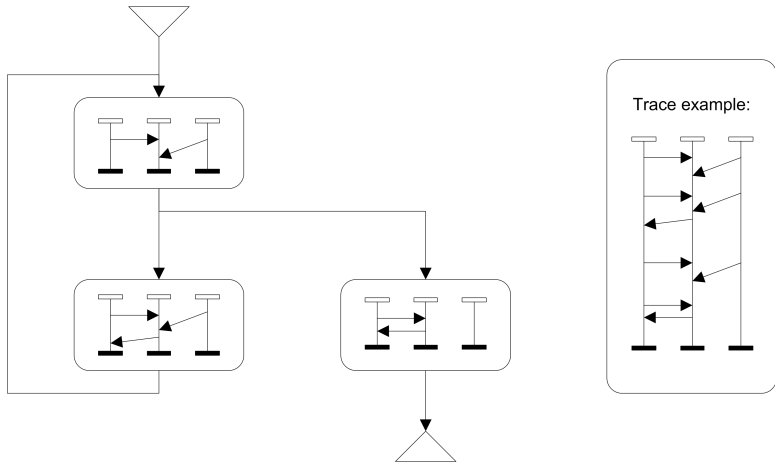

# Deadlock Property

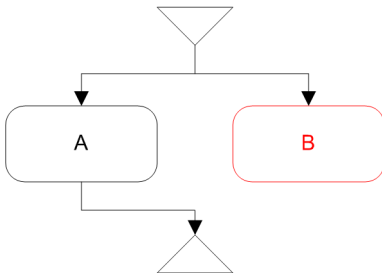

# Livelock Property

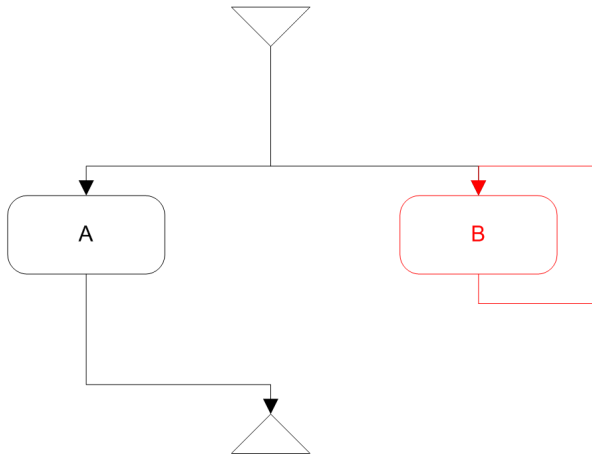



# Membership

Is a given MSC included in a given HMSC?

# Membership

Is a given MSC included in a given HMSC?

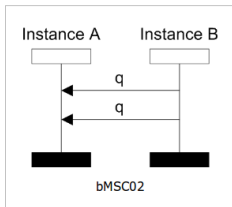
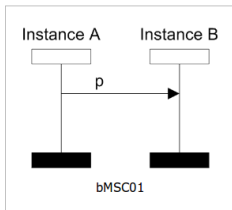
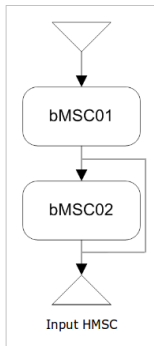
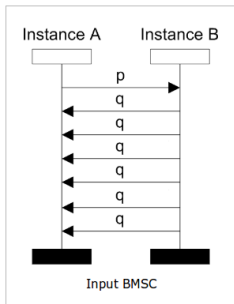



# Inline Expressions

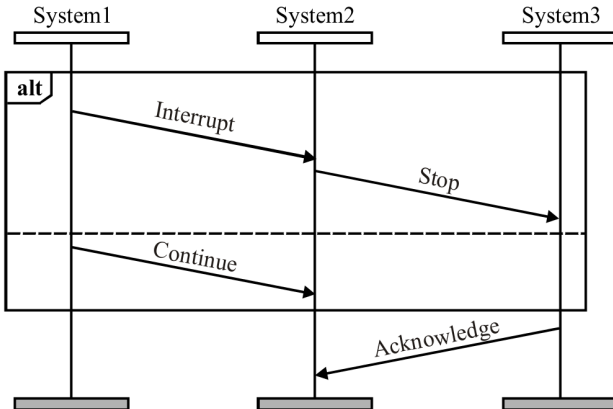

# Inline Expressions

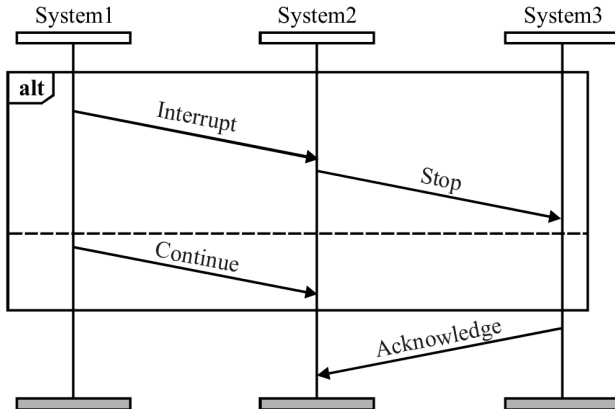

Other inline expression types: **opt**, **loop** $\langle m, n \rangle$ , **exc**, **seq**, **par**.

# Non-local Choice

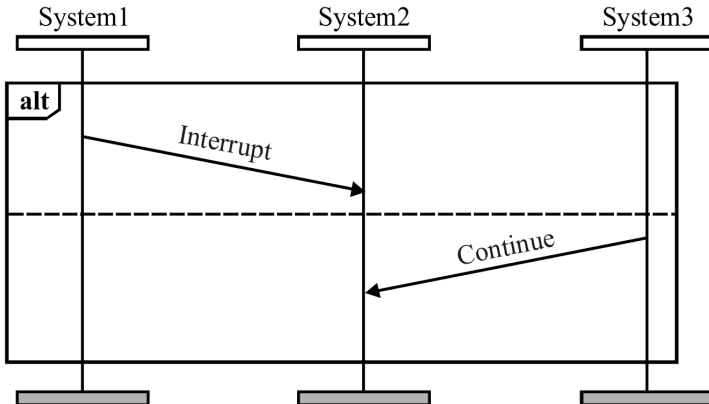

## Non-local Choice

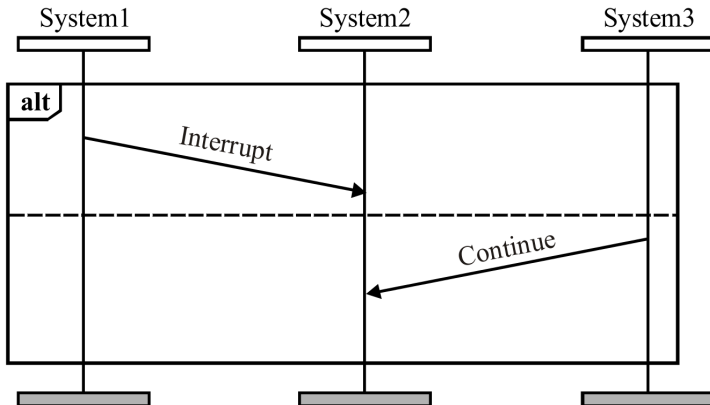

System3 does not know which alternative has been chosen.

# Non-local Choice

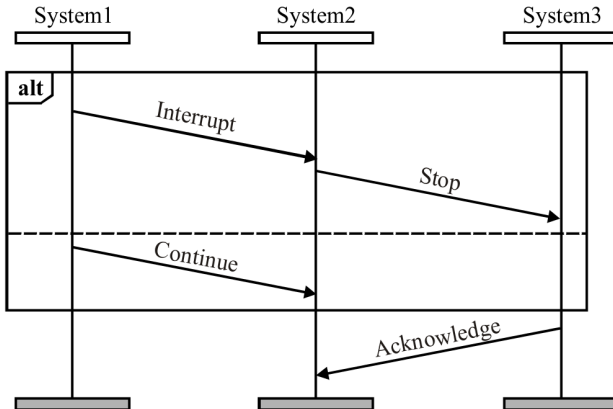

## Non-local Choice

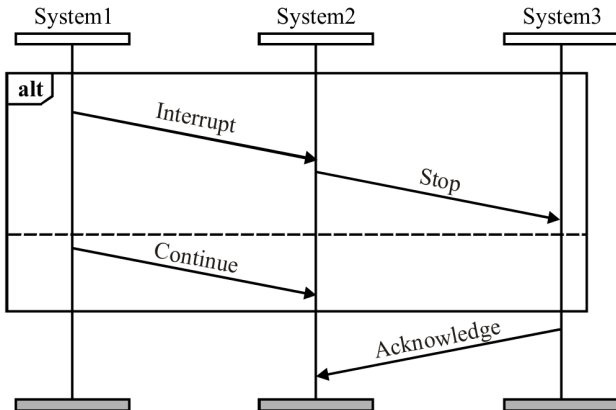

System3 does not know which alternative has been chosen.

## Universal Boundedness

What is the size of input buffer of  $Y$  that will never overflow?

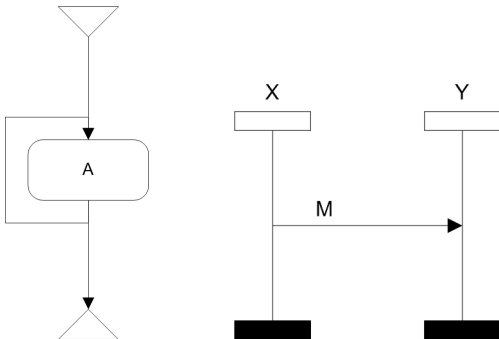

## Universal Boundedness

What is the size of input buffer of  $Y$  that will never overflow?

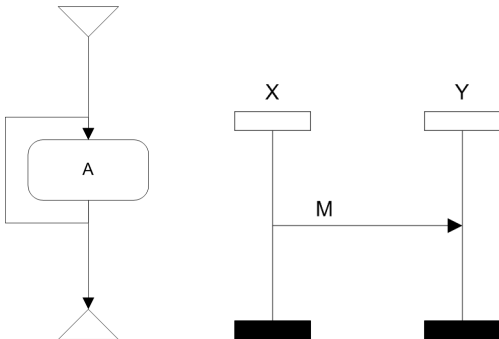

Every finite input buffer of  $Y$  can overflow.



## Universal Boundedness

What is the size of input buffer of  $Y$  that will never overflow?

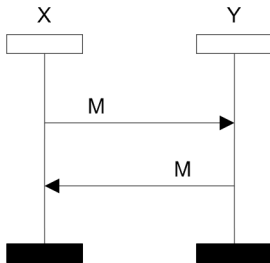
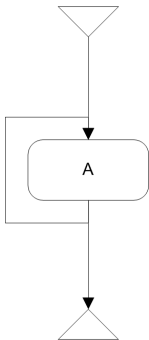

## Universal Boundedness

What is the size of input buffer of  $Y$  that will never overflow?

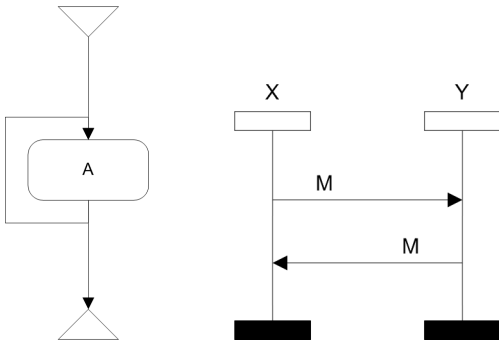

Buffers of size 1 will never overflow.

## Existential Boundedness

The system deadlocks in case of FIFO channels (and FIFO buffers).  
What is the size of non-FIFO buffer needed to avoid deadlock (in case of FIFO channels)?

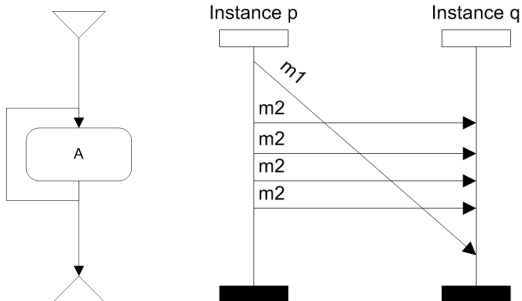

## Existential Boundedness

The system deadlocks in case of FIFO channels (and FIFO buffers).  
What is the size of non-FIFO buffer needed to avoid deadlock (in case of FIFO channels)?

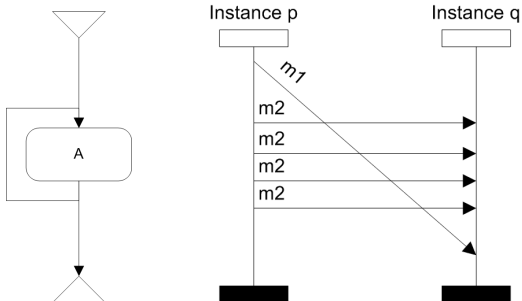

Buffer of size 2 suffices to avoid deadlock.  
Or one buffer for each message label (type).

# Race Condition - Solution #3 - Time Constraints

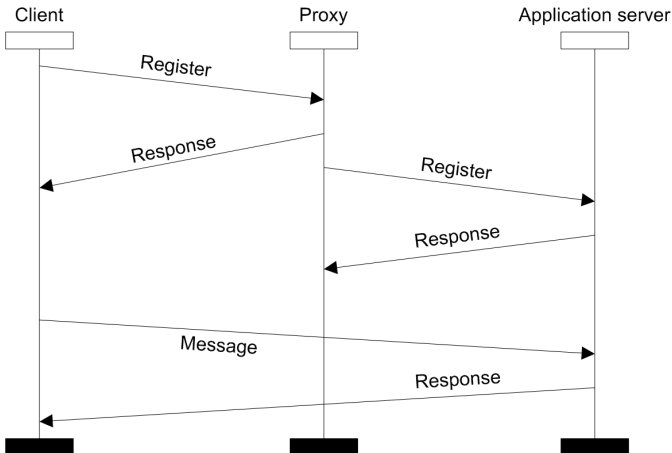

# Race Condition - Solution #3 - Time Constraints

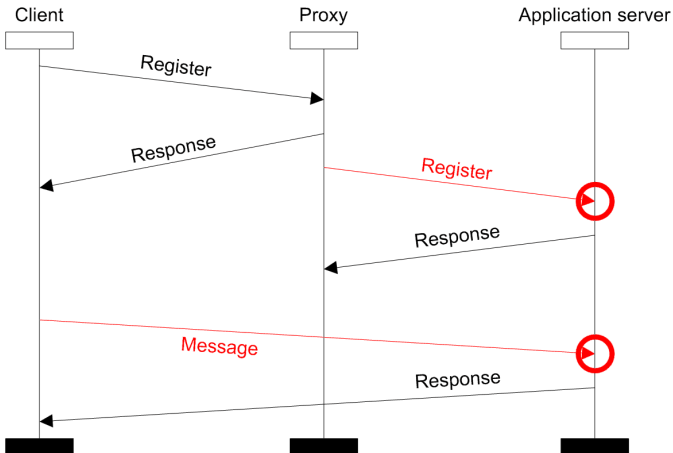

## Race Condition - Solution #3 - Time Constraints

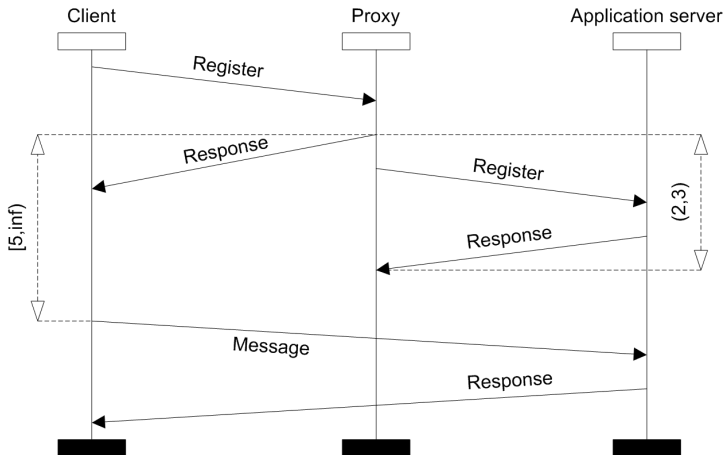

## Time Consistency

Are the given time conditions consistent?

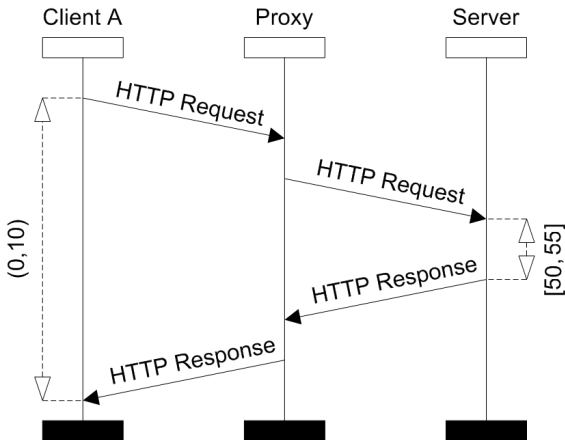



## Time Tightening

Some time conditions can be tightened.

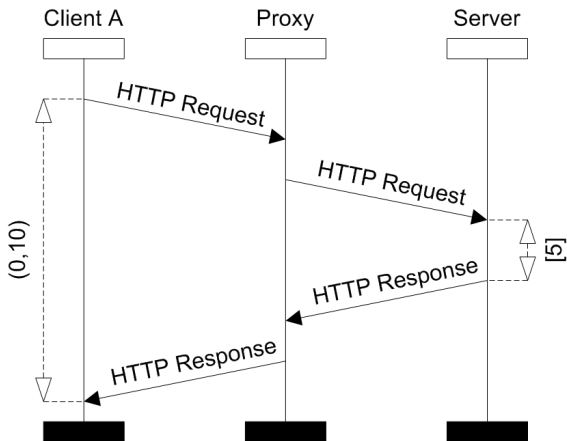

## Time Tightening

Some time conditions can be tightened.

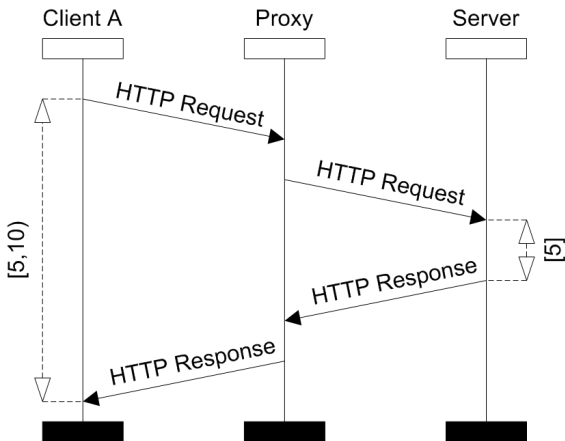

# Timers

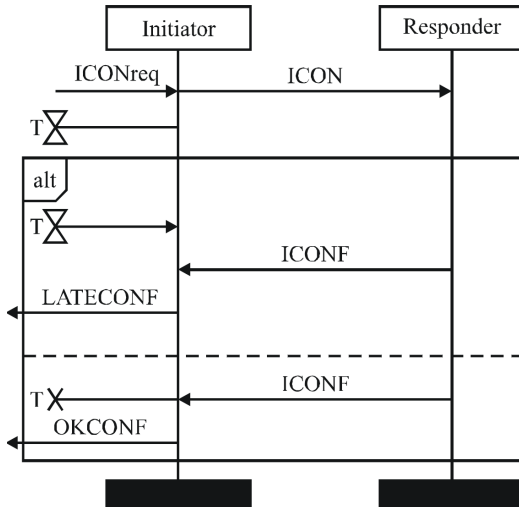

# MSC - Summary

## Basic MSC

- instances
- messages
- send events
- receive events
- conditions
- coregions
- general ordering
- inline expressions
- time constraints
- timers

## High-level MSC (HMSC)

- start node
- end node
- reference nodes
- connection points
- lines
- conditions
- time constraints

## MSC - Properties

- Acyclic property
- FIFO property
- Race Condition
  
- Deadlock
- Livelock
- Membership
- Nonlocal Choice
- Universal Boundedness
- Existential Boundedness
  
- Time Race Condition
- Time Consistency
- Tighten Time

# MSC - Goals

## What MSC is good for?

Both **human** and computer readable formalizm for:

- basic behaviour demonstration (use cases),
- high level system behaviour description,
- test case specification, and
- (test) log visualization.

## MSC - Goals

### What MSC is good for?

Both **human** and computer readable formalism for:

- basic behaviour demonstration (use cases),
- high level system behaviour description,
- test case specification, and
- (test) log visualization.

### What MSC is NOT good for?

detailed specification (before implementation), hierarchical structure of communicating entities, implementation details (primitives for communication, detailed data manipulation), etc.

## MSC - Tools

### Mesa

- academic tool
- local choice and time checkers

### MSCan

- academic tool
- only textual input
- some checkers

### IBM Rational, SanDriLa SDL, Cinderella SDL

### Sequence Chart Studio (SCStudio)

- MS Visio addon
- drawing, import, export
- checkers for all the mentioned properties



# Sequence Chart Studio

MSC drawing and verification tool developed at FI MU.

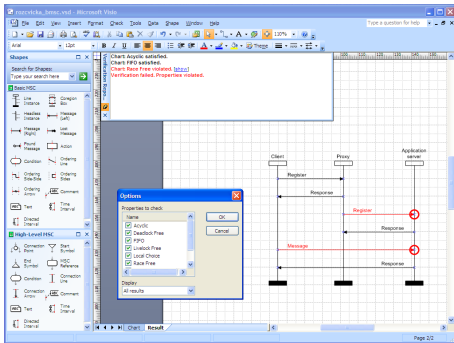

<http://scstudio.sourceforge.net>

## Distributed vs. Local

### SDL

Specification Description  
Language

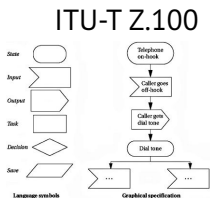

models of components

### MSC

Message Sequence  
Chart

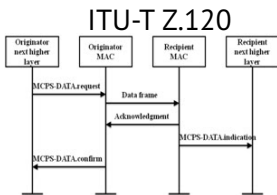

communication model



# Specification Description Language (SDL)

## Specification Description Language (SDL)

# Specification Description Language (SDL)

international standard of ITU-T, Z.100

- 1972 - Establishment of a working group for SDL
- 1976 - first version of Z.100 recommendation
- ...
- 04/2016 - current version of Z.100 recommendation
- all documents of the current version:
  - Z.100 - Specification and Description Language (SDL)
  - Z.100 Supplement 1 - SDL+ methodology: Use of MSC and SDL
  - Z.Imp100 - SDL implementer's guide
  - Z.101 - SDL - Basic SDL-2010
  - Z.102 - SDL - Comprehensive SDL-2010
  - Z.103 - SDL - Shorthand notation and annotation in SDL-2010
  - Z.104 - SDL - Data and action language in SDL-2010
  - ...

## SDL - Specification Description Language

An **object oriented** languages for specification of applications that are

- heterogeneous,
- distributed (concurrent),
- interactive (event-driven, discrete signals), and
- real-time dependent (with delays, timeouts).

Describes

- structure (distributed components of the system),
- behaviour (instructions within the components), and
- data

of distributed systems in **real-time** environments.

## SDL - representations

Three representations:

**SDL/GR** graphical representation (human readable)

**SDL/PR** textual phrase representation (machine readable)

**SDL/CIF** common interchange format (SDL/PR with graphical information)

## SDL - representations

Three representations:

**SDL/GR** graphical representation (human readable)

**SDL/PR** textual phrase representation (machine readable)

**SDL/CIF** common interchange format (SDL/PR with graphical information)

In what follows, we focus on the graphical representation (SDL-GR).

Basic SDL components

- system and blocks (structure)
- processes and procedures (behaviour)

# SDL/GR - Process

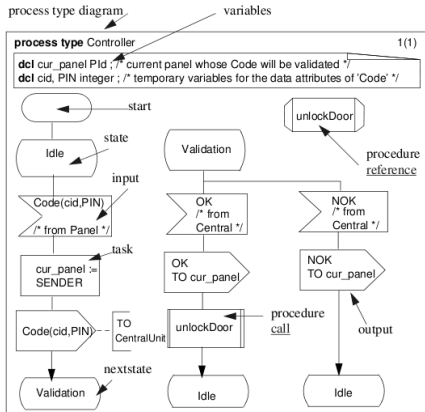

source: TImE Electronic Textbook v4.0



# SDL/GR - Procedure

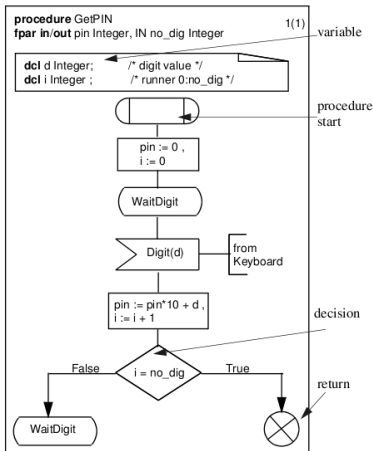

source: TIME Electronic Textbook v4.0

# SDL/GR - Block

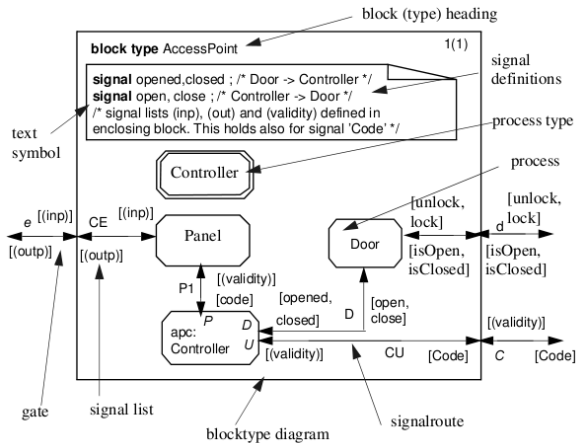

source: TImE Electronic Textbook v4.0

## SDL/GR - Block with block structure

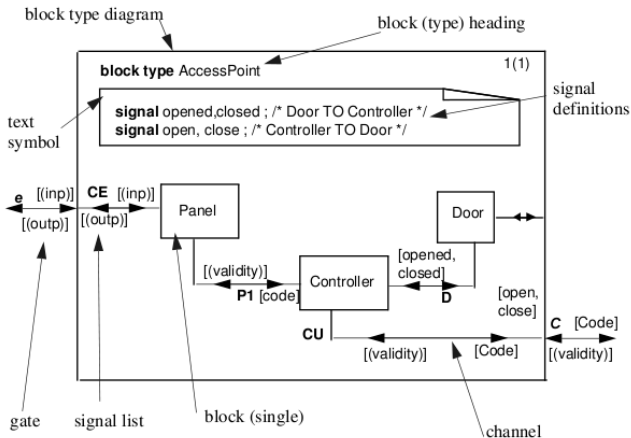

source: TIME Electronic Textbook v4.0

## SDL/GR - System (the top most block)

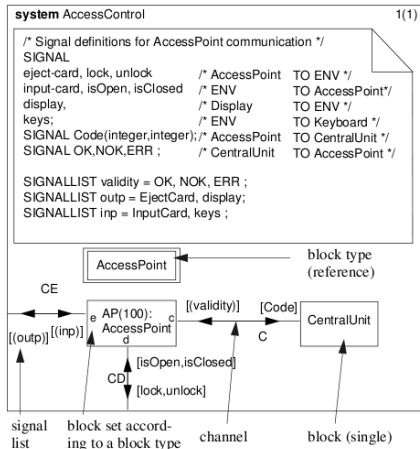

source: TImE Electronic Textbook v4.0

## SDL/GR - Channels

**Nondelaying channels** for “immediate” message delivery (e.g., between processes within a computer).



**Delaying channels** for “time consuming” message delivery (e.g., between dislocated blocks).

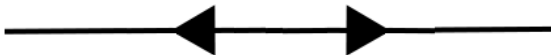

Channels can also be one-directional.

## Summary of SDL Basics

**System** - is the top most block surrounded by environment.

**Block** - consists of blocks or processes that are connected by channels.

- expresses the hierarchical structure of the system.
- its names are references to other objects.

**Process** - sends and receives messages.

- stays in states.
- can call procedures.

**Procedure** - is a subroutine that can finish.

- does not return any value (only in variables or sent messages).

## Message Exchange - Operational Semantics

- one input buffer for a process
- FIFO behaviour
- no priority queues
- signal which is unspecified in the current state is **discarded**

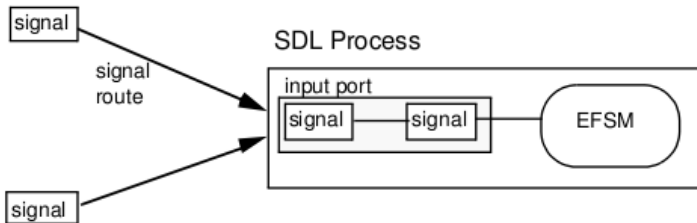

source: TImE Electronic Textbook v4.0

# Asterisk Save, Asterisk State, and Dash State

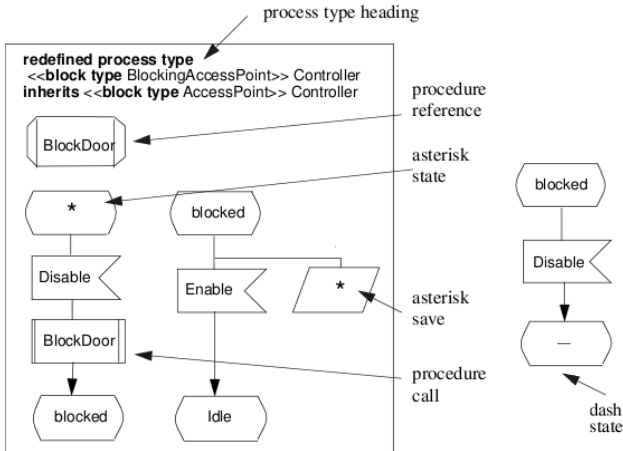

source: TImE Electronic Textbook v4.0



# Timer Construction

TIMER door\_timeout ;

**set**  
(now +10,  
door\_timeout)

door\_timeout

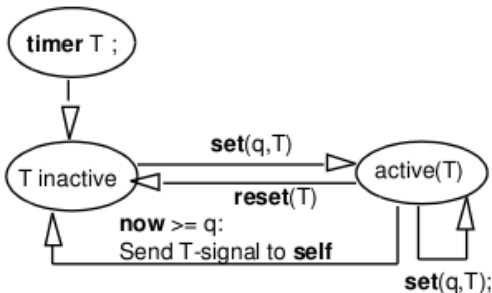

source: TImE Electronic Textbook v4.0

## Multiple Instances of a Block

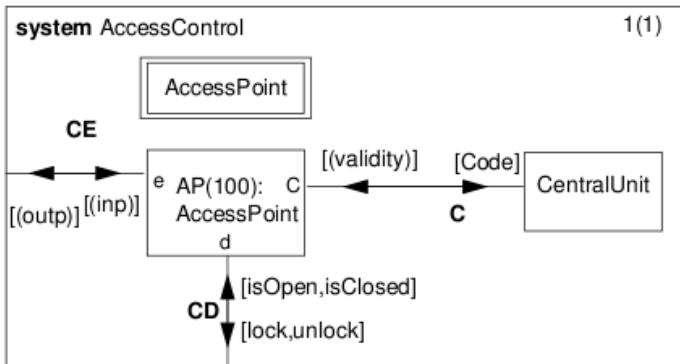

source: TIme Electronic Textbook v4.0

# Multiple Instances of a Process

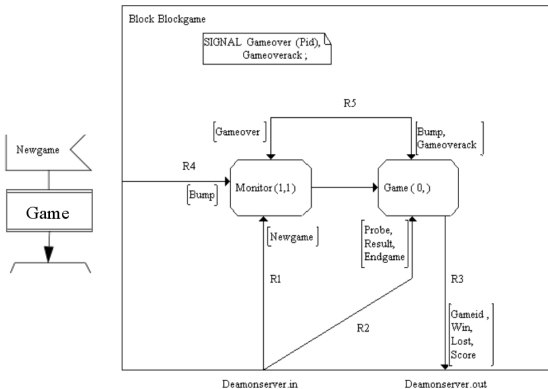

## Additional SDL Constructs

- **Asterisk save, asterisk state, and dash state**
- **Timer** construction
- **Multiple block instances** (no dynamic creation)
- **Multiple process instances** (with dynamic creation and limit)
  
- **Packages** collections of related types and definitions (library)
- **Subtypes**
- **Virtual processes**
- **Process type redefinition** and **finalization**
- **Inherited blocks**

# SDL - Overview

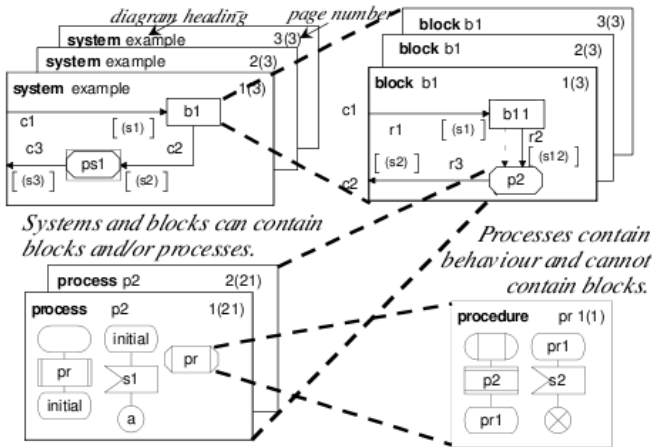

## SDL - Goals

### What SDL is good for?

SDL is designed for unambiguous **specification** of requirements and **description** of implementation of the normative requirements of **telecommunication protocol** standards.

For computer based tools to improve the process of

- specification (create, maintain, and analyze), and
- implementation (automatic code generation).

## SDL - Goals

### What SDL is good for?

SDL is designed for unambiguous **specification** of requirements and **description** of implementation of the normative requirements of **telecommunication protocol** standards.

For computer based tools to improve the process of

- specification (create, maintain, and analyze), and
- implementation (automatic code generation).

### What SDL is NOT good for?

high level system description (what the system serves for), demonstration of good or wrong behaviour, test trace specification, implementation details (primitives for communication, detailed data manipulation), etc.

## MSC and SDL in Workflow

- typical/optimal communication sequences (MSC)
- error sequences (MSC)
- optionally - full specification in (HMSC)
- distributed specification (SDL)



## MSC and SDL in Workflow

- typical/optimal communication sequences (MSC)
- error sequences (MSC)
- optionally - full specification in (HMSC)
- distributed specification (SDL)

### Formal model benefits

- (H)MSC to SDL transformation (realization)
- SDL to source code transformation (implementation)
- MSC to test case transformation
- simulation to MSC transformation (membership checking)
- ...

## SDL - Tools

### IBM Rational

- from tools of Telelogic (SDT, Geode, Tau)
- drawing, import, export
- automatic implementation in C++
- simulation support

### SanDriLa SDL

- MS Visio stencil
- drawing, import, export
- analyses of states in process diagrams
- open for addons

### Cinderella SDL

- modelling, import, export
- analyses and simulation



# Petri Nets

## Petri Nets

# Petri Nets

C. A. Petri: Kommunikation mit automaten, 1962

## Basic components:

- places
- transitions
- tokens
- arcs

**Marking** = configuration  
= distribution of tokens  
= vector of token #s in places

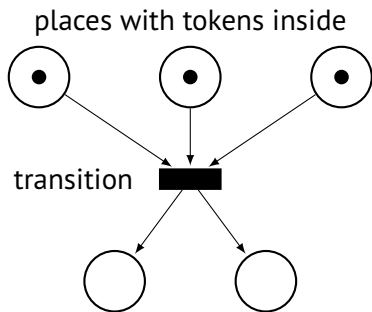

A transition can be fired if there is a token in each of its input places.

# Petri Nets

C. A. Petri: Kommunikation mit automaten, 1962

## Basic components:

- places
- transitions
- tokens
- arcs

**Marking** = configuration  
 = distribution of tokens  
 = vector of token #s in places

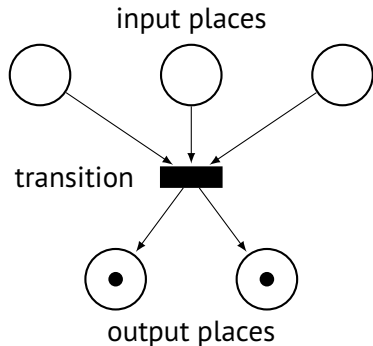

Tokens from input places are removed and new tokens are added into the output places of the fired transition.

## Demonstration Example #1

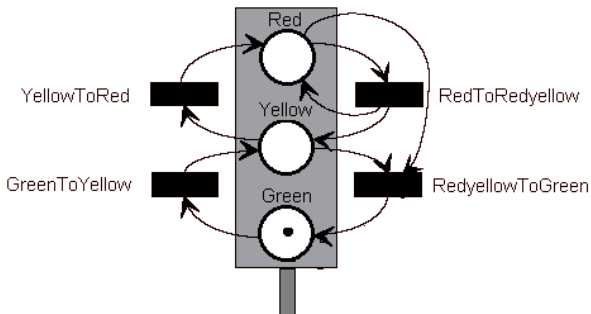

## Demonstration Example #1

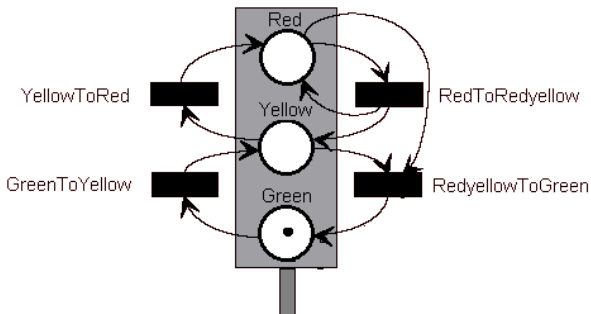

What is wrong in this example?

## Demonstration Example #2

Better and a bit more complicated example.

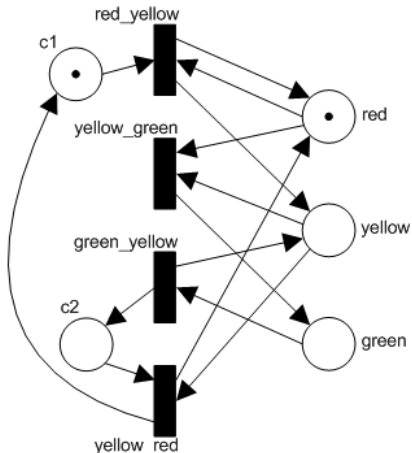



# Basic Constructions

Sequential  
execution

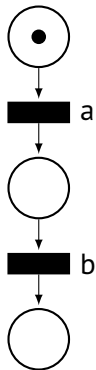

Iteration

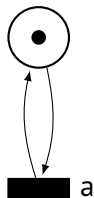

Alternative

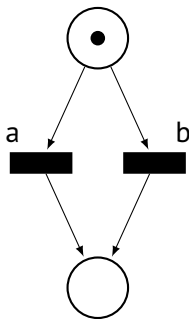

Parallel  
execution

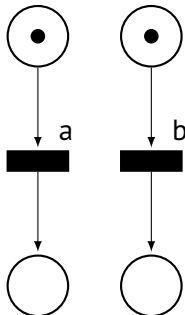

# Basic Constructions

## Semaphore

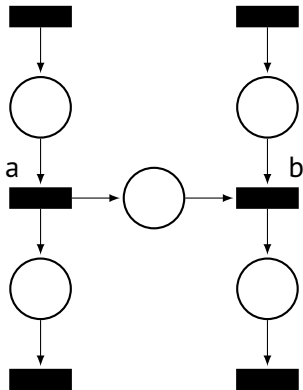

## Rende-vous

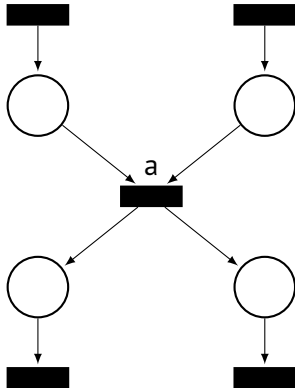

# Basic Constructions

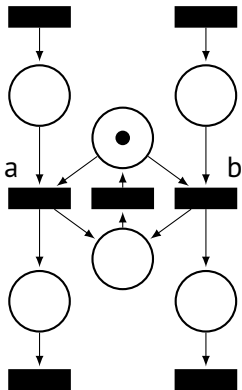

## Basic Constructions

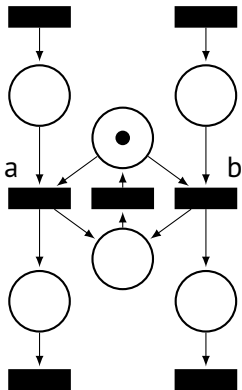

Critical section

## Basic Constructions

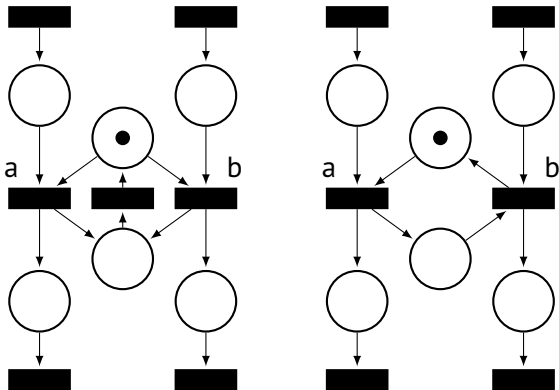

Critical section

## Basic Constructions

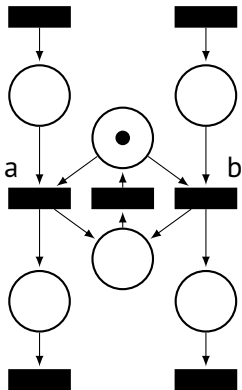

Critical section

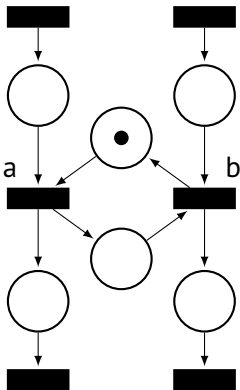

Alternation

## Basic Constructions

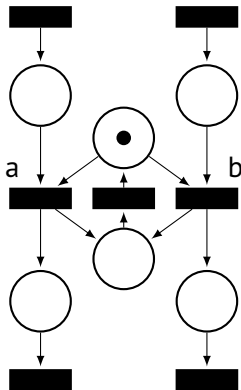

Critical section

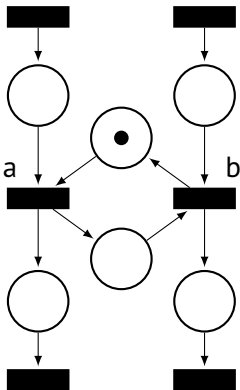

Alternation

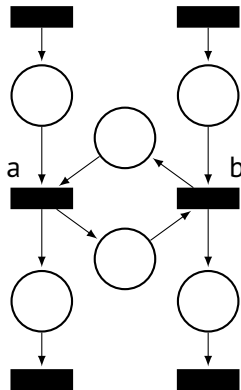

## Basic Constructions

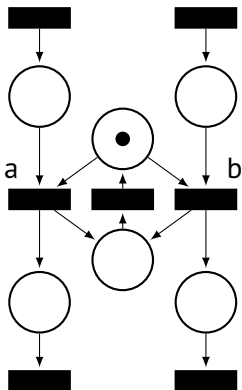

Critical section

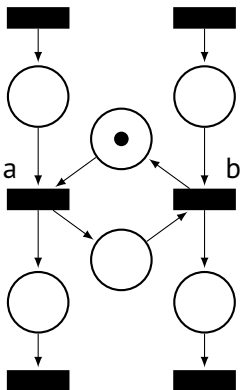

Alternation

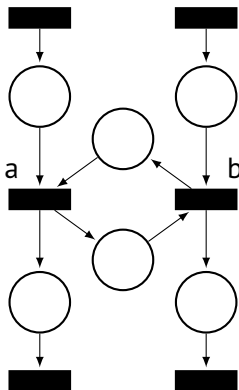

Deadlock



## Different Modifications/Extensions of Petri Nets

- Condition-Event Petri nets (C-E PN)
- Place-Transition Petri nets (P-T PN)
- Coloured Petri nets
- Hierarchical Petri nets
- Timed Petri nets
- Time Petri nets
- Stochastic Petri nets

## Condition-Event Petri Nets

In this case:

- places = conditions
- transitions = event

An event/transition is *enabled* if and only if

- all its pre-conditions are true and
- all its post-conditions are false.

I.e., an event occurrence negates its pre- and post-conditions.

Therefore, there is one or none token in each place.

## Transition-Place Petri Nets

An arbitrary number of tokens in each place.

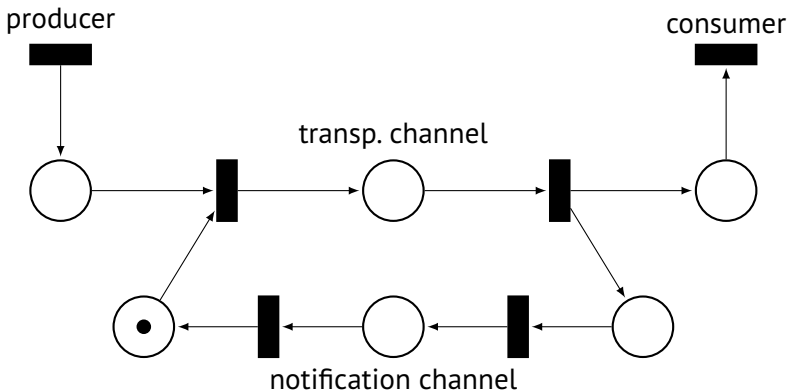

Producer-consumer model for bounded transport channel.

## Additional Constructs - Arc Multiplicity

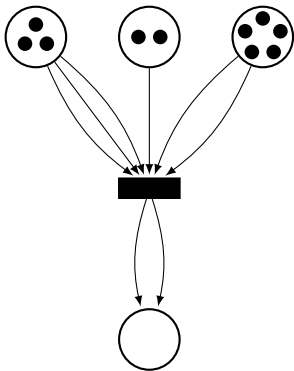

## Additional Constructs - Arc Multiplicity

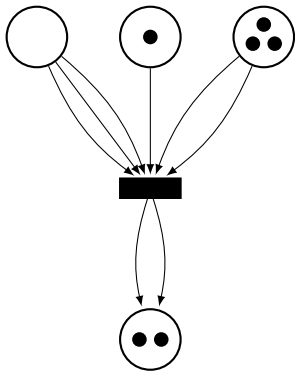

## Additional Constructs - Arc Multiplicity

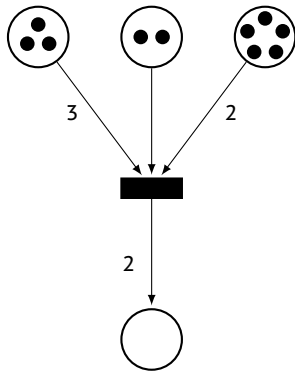
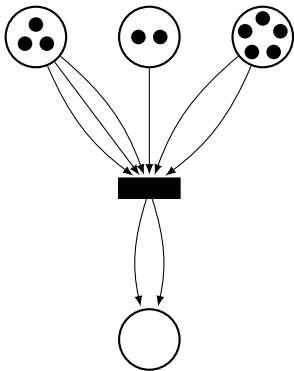

## Additional Constructs - Arc Multiplicity

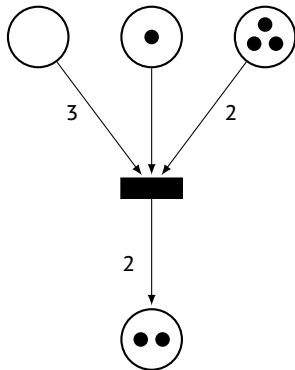
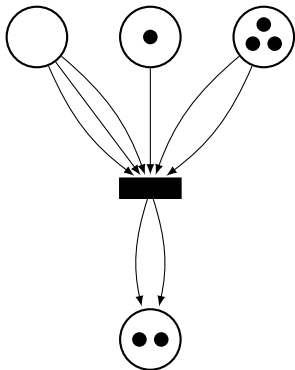

## Additional Constructs - Inhibitor and Reset Arcs

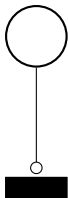

An **inhibitor arc** imposes the precondition that the transition may only fire when the place is empty.



## Additional Constructs - Inhibitor and Reset Arcs

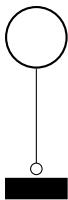

An **inhibitor arc** imposes the precondition that the transition may only fire when the place is empty.

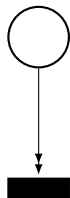

A **reset arc** does not impose a precondition on firing, and empties the place when the transition fires.

## Properties of Petri nets

- **reachability** - reachability tree or coverability tree
- **bounded (safe) places**
  - a place with a **bound** on the number of its tokens in all reachable markings
  - a place is **safe** if the number of its tokens  $\leq 1$  in all reachable markings
- **liveness**
  - a transition is **live** if, from every marking, one can reach a marking where the transition is enabled
  - a net is **live** if all its transitions are live

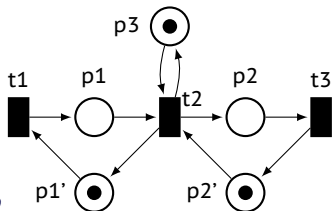
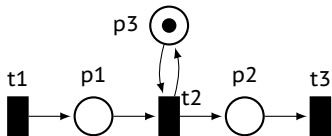

## Properties of Petri nets

### ■ p-invariant

- an invariant vector on places, i.e. a multiset of places representing weighting such that any such weighted marking remains invariant by any firing, e.g.  $3 * p_1 + p_2 + p_3 + p_4 + p_5 + 3 * p_6$ .

### ■ t-invariant

- an invariant vector on transitions, i.e. a multiset of transitions whose firing leave invariant any marking, e.g.  $t_1 + 2 * t_2 + t_3 + t_4 + t_5$ .

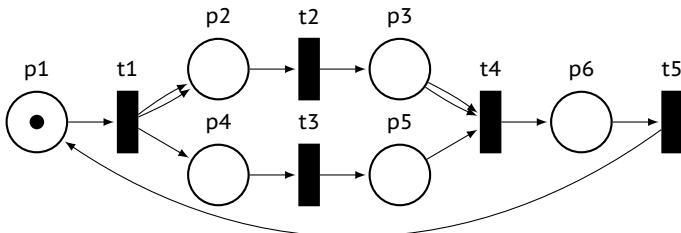

## Coloured Petri Nets

Different colours (classes) of tokens.

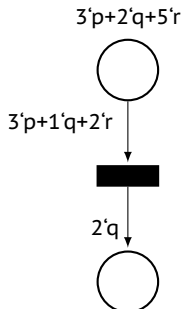
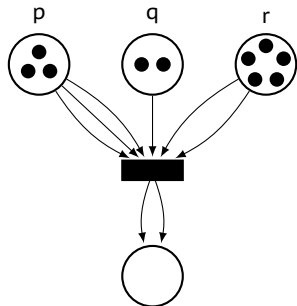

marking expression, arc expression, transition guard (next slide)

Colours usually serves for data type representation.

# Coloured Petri Net Example

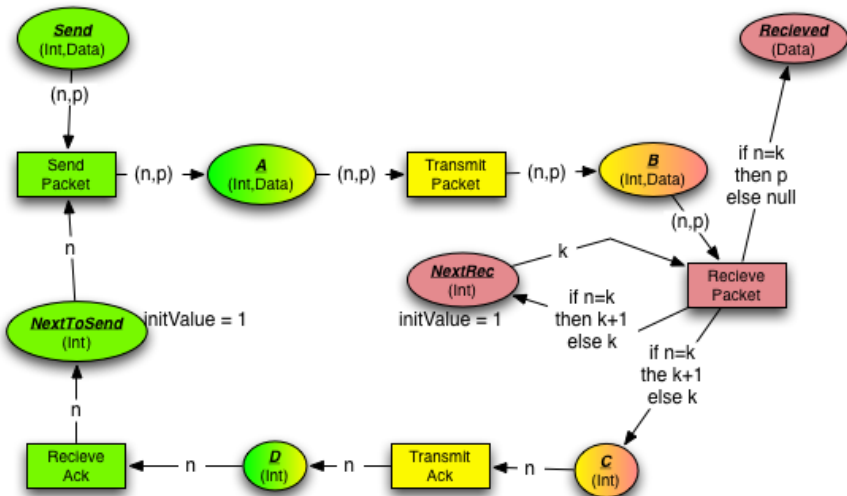

# Hierarchical Petri Nets

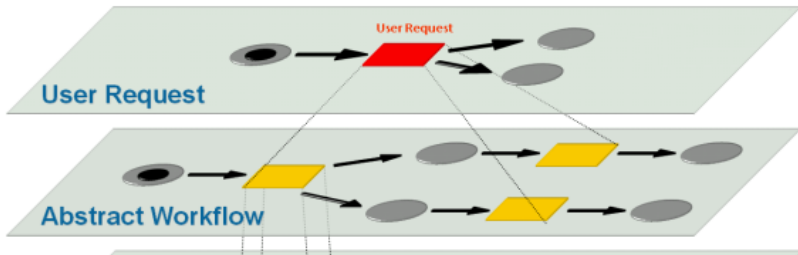

## Time PN, Timed PN, Stochastic PN, ...

### priority nets

- priorities of concurrent transitions

### time (or timed-arc) nets

- tokens has its lifetime, arcs to transitions are labeled by time intervals of required ages of tokens

### timed nets

- firing starts when a transition is enabled but it takes some specified time to produce output

### stochastic nets

- probability distribution on time to fire (exponential, deterministic, or general distributions)

## PN Tools

### CPN Tools

- Coloured Petri Nets (prioritized transitions and real time support)
- editor, simulation, analyses

### Tapall

- Timed-Arc Petri Nets (with real time support)
- editor, simulation, compositional models, TCTL logic checker

### TimeNET

- Coloured and Stochastic PN with non-exponential distributions
- editor, simulation, analyses (p-invariant, performance analyses)

### SNOOPY, TINA - Time petri Net Analyzer, Roméo, ...

<http://www.informatik.uni-hamburg.de/TGI/PetriNets/tools/quick.html>  
<http://cs.au.dk/cpnets/industrial-use/>





# Queueing theory

## Queueing theory

## Queueing Theory

In 1909 A.K. Erlang, a danish telephone engineer, was asked:

“What the queue capacity should be  
of the central telephone switch in Copenhagen?”

## Queueing Theory

In 1909 A.K. Erlang, a danish telephone engineer, was asked:

“What the queue capacity should be of the central telephone switch in Copenhagen?”

**Our motivation example:**

### Example

30 customers will visit the cash machine in an hour.  
Each customer uses the machine for 1.5 minute on average.

How busy is the cash machine?

For how long time does a customer wait (on average)?

## Queues and Their Parameters

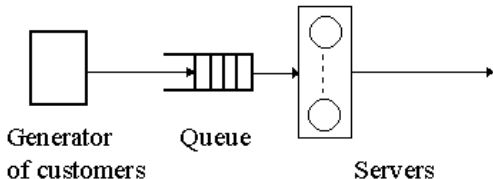

- inter-arrival time distribution (type of the distribution, rate  $\lambda$ , or mean inter-arrival time  $1/\lambda$ , other moments ...)
- service time distribution (type of the distribution, rate  $\mu$ , or mean service time  $1/\mu$ , other moments ...)
- number of servers
- maximal queue length
- ...

## Queue Parameters - Kendall Notation

$A/S/n/B/K/SD$

**A** - inter-arrival time distribution

**G** - general, **M** - exponential, **D** - deterministic...

**S** - service time distribution

**G** - general, **M** - exponential, **D** - deterministic...

**n** - number of servers

**1, 2, ...,  $\infty$**

**B** - buffer size (the max. number of waiting and served requests)

**1, 2, ...,  $\infty$**

**K** - population size

**1, 2, ...,  $\infty$**

**SD** - service discipline

**FIFO, LIFO, Random, RR** - Round Robin

E.g.,  $M/G/1/\infty$

# Queueing Networks

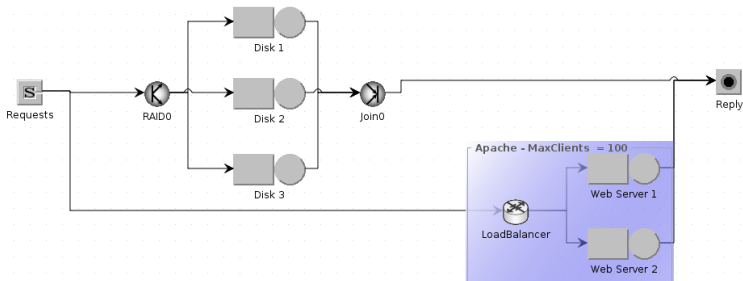

- open and closed networks
- system dependences
- traffic intensity
- occupancy (on different servers), bottleneck detection, ...
- very similar to Stochastic Petri Nets

## Questions about Queues

- What is the utilization factor  $\rho$ , probability of being not empty?
- What is the mean number  $N$  of waiting (or being served) requests?
- What is the mean waiting and service time, i.e. the time  $T$  the requests spend in the system?
- And so, how many servers do I need to ...

## Questions about Queues

- What is the utilization factor  $\rho$ , probability of being not empty?
- What is the mean number  $N$  of waiting (or being served) requests?
- What is the mean waiting and service time, i.e. the time  $T$  the requests spend in the system?
- And so, how many servers do I need to ...

### General solution:

- simulation

### For specific types of queues:

- analytical results



## Analytical Solutions for M/M/1 Queues

For M/M/1/ $\infty$  queue with arrival rate  $\lambda$  and service time rate  $\mu$ :

- The mean inter-arrival time is  $1/\lambda$ .
- The mean service time is  $1/\mu$ .
- The utilization factor  $\rho = \lambda/\mu$ .
- The queue is stable if  $\rho < 1$ , i.e.  $\lambda < \mu$ .
- The (stable) queue is empty with probability  $P_0 = 1 - \rho$ .
- The mean number of requests (waiting or being served) in a stable system  $N = \rho/(1 - \rho)$ . It is also usually denoted by  $L$  as it is the length of the queue.
- The average time spend in a stable system  

$$T = 1/(\mu - \lambda) = 1/(\mu(1 - \rho)).$$
- The rate of the traffic carried out by the queue is  $\mu\rho = \mu(1 - P_0)$ .

## Our Motivation Example Solved as $M/M/1/\infty$

### Example

30 customers will visit our cash machine in an hour.  
Each customer uses the machine for 1.5 minute on average.  
How busy is the cash machine? What is the average waiting time?

## Our Motivation Example Solved as $M/M/1/\infty$

### Example

30 customers will visit our cash machine in an hour.  
Each customer uses the machine for 1.5 minute on average.  
How busy is the cash machine? What is the average waiting time?

- The mean inter-arrival time is 2 minutes.
- The rate of the inter-arrival time  $\lambda$  is  $1/2 = 0.5$ .
- The mean service time is 1.5 minute.
- The rate of the service time  $\mu$  is  $2/3 \approx 0.666667$ .
- The queue is stable and the utilization factor  $\rho = 3/4 = 0.75$ .
- The mean number of requests (waiting or being served)  $N$  is 3.
- The average time spend in the system  $T$  is 6 minutes.

I.e., on average: It serves 45 minutes per hour. There are 3 customers in the queue and each spends 4.5 minutes for waiting + 1.5 min for service.

## Little's Law

### Theorem

Let  $L$  be the long-term **average number of customers** in a stable system,  $\lambda$  be the long-term average effective **arrival rate**, and  $W$  be **the average time a customer spends** in the system. Then it holds that

$$L = \lambda \cdot W$$

*for a queue of any type.*

Although it looks intuitively reasonable, it is quite a remarkable result, as the relationship is “not influenced by the arrival process distribution, the service distribution, the service order, or practically anything else.”

# Tools for Queueing Systems

## G/M/c-like queue

- online steady-state solution of a G/M/c-like queue
- <http://queueing-systems.ens-lyon.fr/formGMC.php>

## JMT - Java Modelling Tools

- framework for model simulation and workload analysis
- <http://jmt.sourceforge.net/>

## SimEvents

- simulation engine and component library for Simulink (MATLAB)
- <http://www.mathworks.com/products/simevents/>

## Up-to-date List of relevant Queueing theory based tools:

<http://web2.uwindsor.ca/math/hlynka/qsoft.html>

## Relevant Lectures

IV113 Úvod do validace a verifikace (Barnat)

IA169 System Verification and Assurance (Barnat, Řehák, Matyáš)

IV109 Modelování a simulace (Pelánek)

IA159 Formal verification methods (Strejček)

IA158 Real Time Systems (Brázdil)

## References

- ITU-T recommendation Z.120: Message Sequence Charts (MSC). 2011.
- ITU-T recommendation Z.100: Specification Description Language (SDL). 2016.
- S. Mullender. Distributed Systems. ACM, 1993.
- D. Peled. Software Reliability Methods. Springer, 2001.
- R. Bræk et al. TIME: The Integrated Method. SINTEF, 1999.
- L. Doldi. Validation of Communications Systems with SDL. Wiley, 2003.
- M. Broy and K. Stølen. Specification and Development of Interactive Systems: Focus on Streams, Interfaces, and Refinement. Springer, 2001.
- W. Jia and W. Zhou. Distributed Network Systems: From Concepts to Implementation. Springer, 2005.
- M. Češka. Petriho sítě. Akademické nakladatelství CERM Brno, 1994.
- J. Markl. Petriho sítě. VŠB - Technická univerzita Ostrava, 1996.
- G. Giambene. Queuing Theory and Communications - Networks and Applications. Springer, 2005.
- D. Gross et al. Fundamentals of Queuing Theory. Wiley, 2008.