

# Process modeling II

PV207 – Business Process Management  
Spring 2019

Jiří Kolář, Lubomír Dočkal, Lubomír Hruban

# Last lecture recap

- Why process modeling?

# Last lecture recap

- Why process modeling?
- BPMN L1, L2, L3

# Last lecture recap

- Why process modeling?
- BPMN L1, L2, L3
- Quality aspects of process model

# Last lecture recap

- Why process modeling?
- BPMN L1, L2, L3
- Quality aspects of process model
- Process interactions
  - Private process
  - Abstract process (Black box/Collapsed Pool)
  - Collaboration (Global) process

# Last lecture recap

- Pool and Lane
- Task (User, Service, Abstract/None)
- Subprocess (Collapsed, Expanded)
- Start Event (None, Message, Timer)
- End Event (None, Message, Terminate)
- Gateway (Parallel, Exclusive)
- Sequence Flow
- Message Flow
- Data Object (Data store, Message)
- Text Annotation
- Link Event Pair

# Lecture overview

- Information sources
- From L1 to L2
- L2: timing precision
- BPMN 2.0 Level 2:
  - Subprocess
  - Activity call
  - **Events**
    - Messages
    - Signals
    - Errors
    - Escalations
  - Gateways
  - BPMN 2.0  
summary

# Information sources

- **BOOK: BPMN method and style / Bruce Silver**
  - ISBN:9780982368107, Library FI, Amazon 33\$
- **BPMN 2.0 poster**
  - [http://www.bpmb.de/images/BPMN2\\_0\\_Poster\\_EN.pdf](http://www.bpmb.de/images/BPMN2_0_Poster_EN.pdf)
- **Signavio modeler – academic licence**
  - <http://academic.signavio.com/p/login>
- **BPMN official OMG website**
  - <http://www.bpmn.org>



# BPMN 2.0: from L1 to L2

- Level 1
  - Flowcharting
  - Business experts  $\Leftrightarrow$  analysts/developers
  - The goal is to express simple activity sequences
  - Minimum of nesting and interprocess interactions
  - Simple events only
- Level 2
  - Analytical BPMN model
  - Process analysts  $\Leftrightarrow$  Process developers
  - Precise activity execution timing
  - Subprocess nesting and interprocess interactions
  - Events and signals, exception handling

# Level 2: timing precision

- Each activity has exact start and completion
- Service task
  - Starts immediately when reached
  - Being performed immediately and completed
- User task
  - Starts immediately when reached
  - Being performed once user open it in a "worklist" = task "claim"

# Activity states

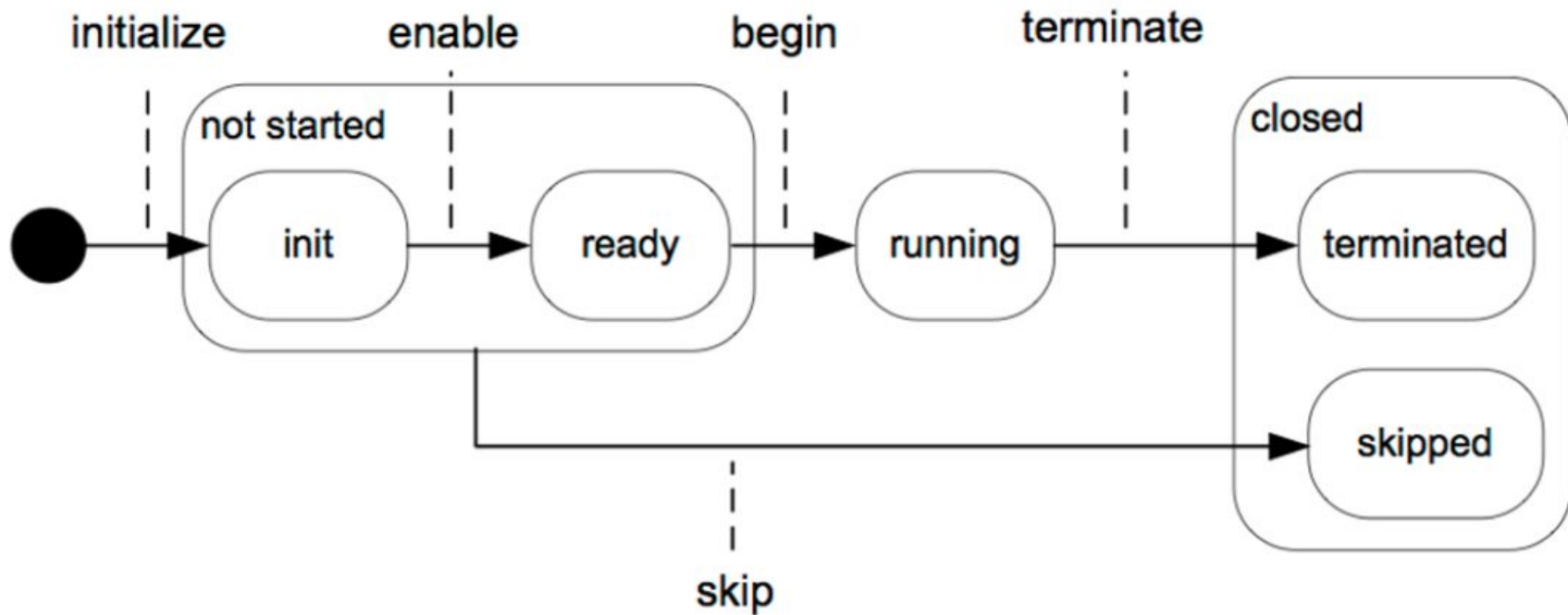

**Fig. 3.9.** State transition diagram for activity instances

# Level 2: timing precision example

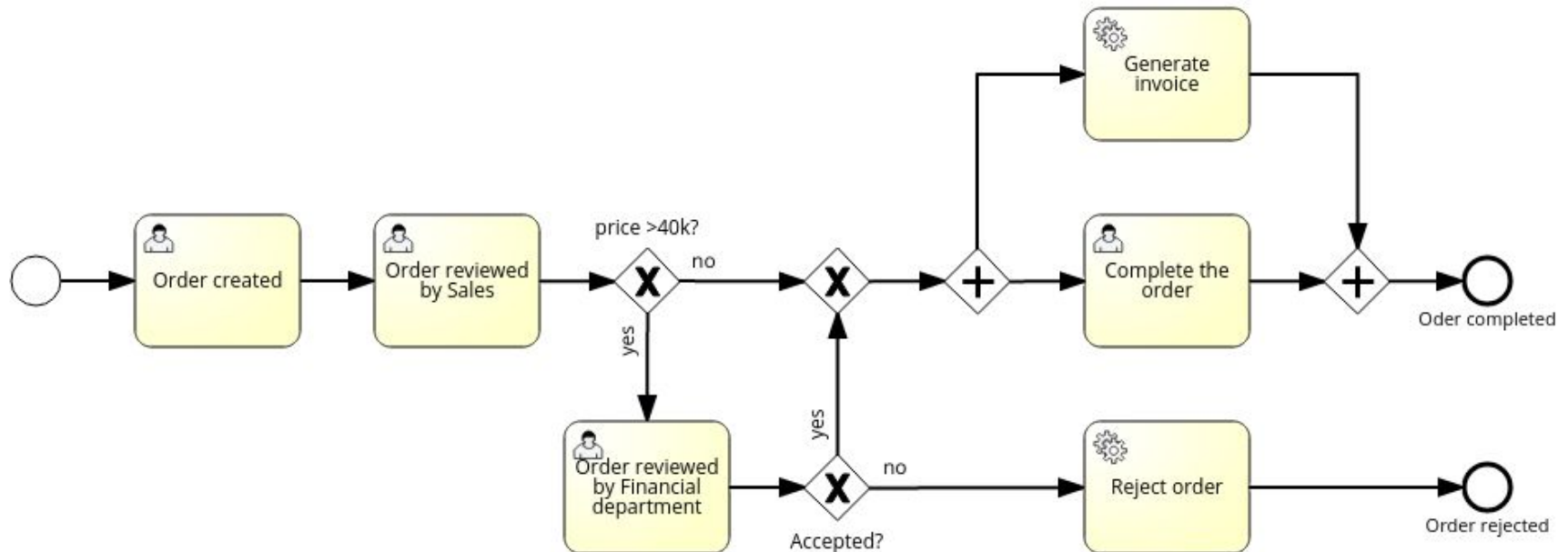

# Subprocess vs Call activity

- Subprocess

- Expandable (nested) part of the process
- Defined inside process
- Nested for better readability

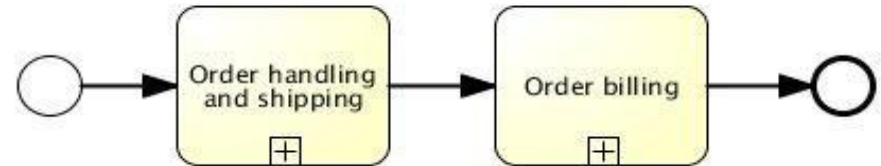

- Activity call

- Call of global task or process
- Defined as a separate process, then imported
- Reusable in other processes

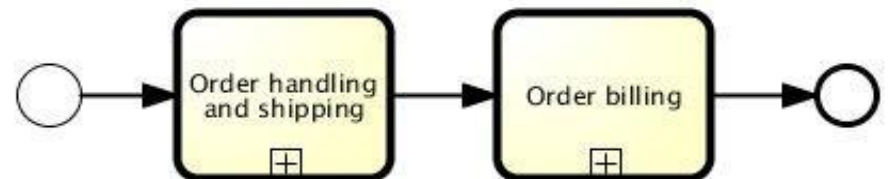

# Event types: Basic types

- **Start events**
  - Event initiate process/subprocess
  - One (or more in special cases)
  - Always catching
- **Intermediate events**
  - Occur during process
  - Can be throwing or catching
- **End events**
  - Occur at the end of process flow
  - Always throwing
  - End affect only one branch (except Terminate)

# Event types - Examples

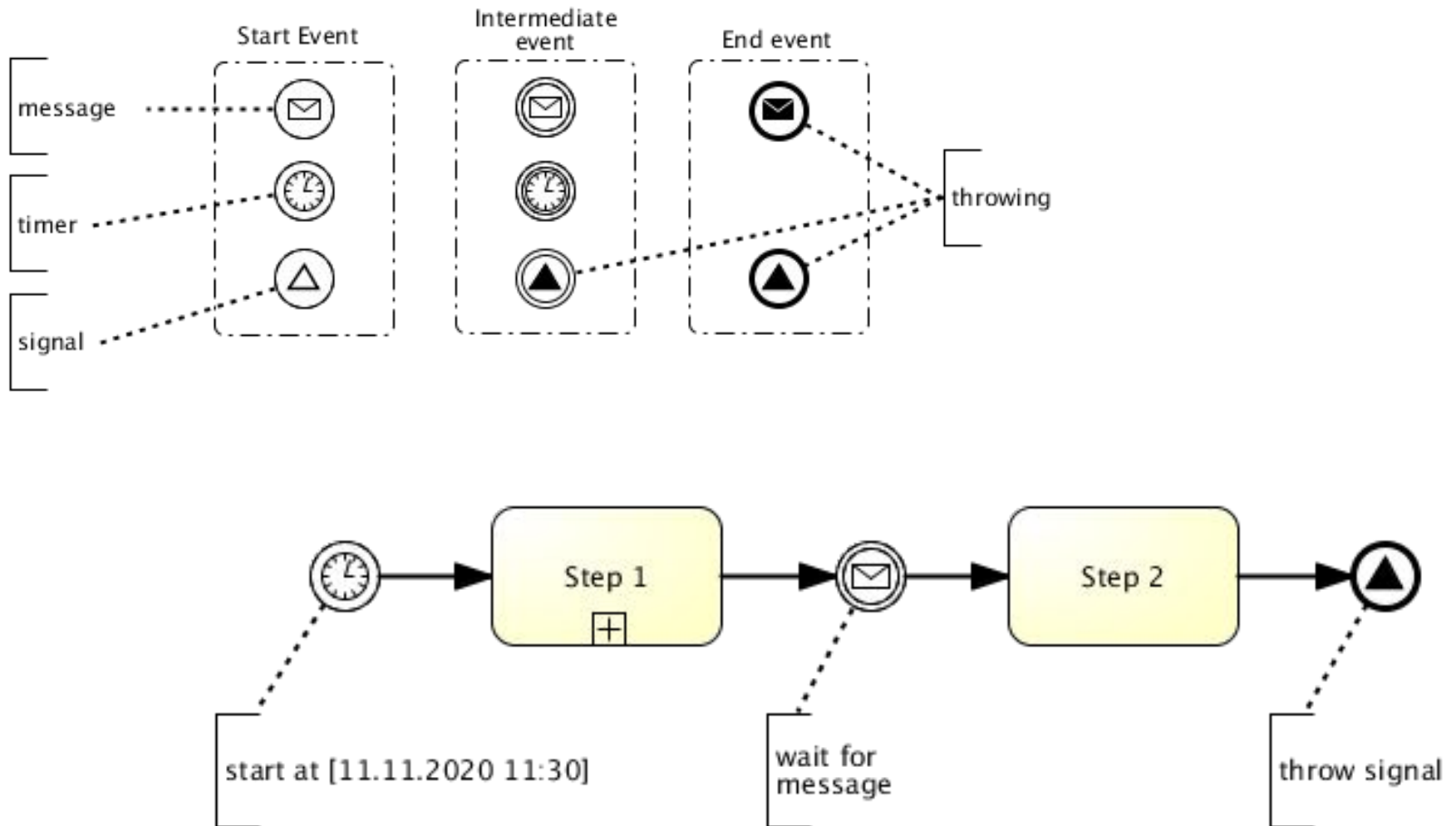

# Events

Downloaded from:

<http://frapu.de/blog/index.php?m=07&y=09&d=01&entry=entry090701-211320>

## Events

	Start			Intermediate			End
	Top-Level	Event Sub-Process Interrupting	Event Sub-Process Non-Interrupting	Catching	Boundary Interrupting	Boundary Non-Interrupting	Throwing
<b>None:</b> Untyped events, indicate start point, state changes or final states.							
<b>Message:</b> Receiving and sending messages.							
<b>Timer:</b> Cyclic timer events, points in time, time spans or timeouts.							
<b>Escalation:</b> Escalating to an higher level of responsibility.							
<b>Conditional:</b> Reacting to changed business conditions or integrating business rules.							
<b>Link:</b> Off-page connectors. Two corresponding link events equal a sequence flow.							
<b>Error:</b> Catching or throwing named errors.							
<b>Cancel:</b> Reacting to cancelled transactions or triggering cancellation.							
<b>Compensation:</b> Handling or triggering compensation.							
<b>Signal:</b> Signalling across different processes. A signal thrown can be caught multiple times.							
<b>Multiple:</b> Catching one out of a set of events. Throwing all events defined							
<b>Parallel Multiple:</b> Catching all out of a set of parallel events.							
<b>Terminate:</b> Triggering the immediate termination of a process.							



# Event types: Catching vs. Throwing

- Throwing
  - Emits the event
  - Flow continues immediately
- Catching
  - Catch the event
  - Flow waits for the event

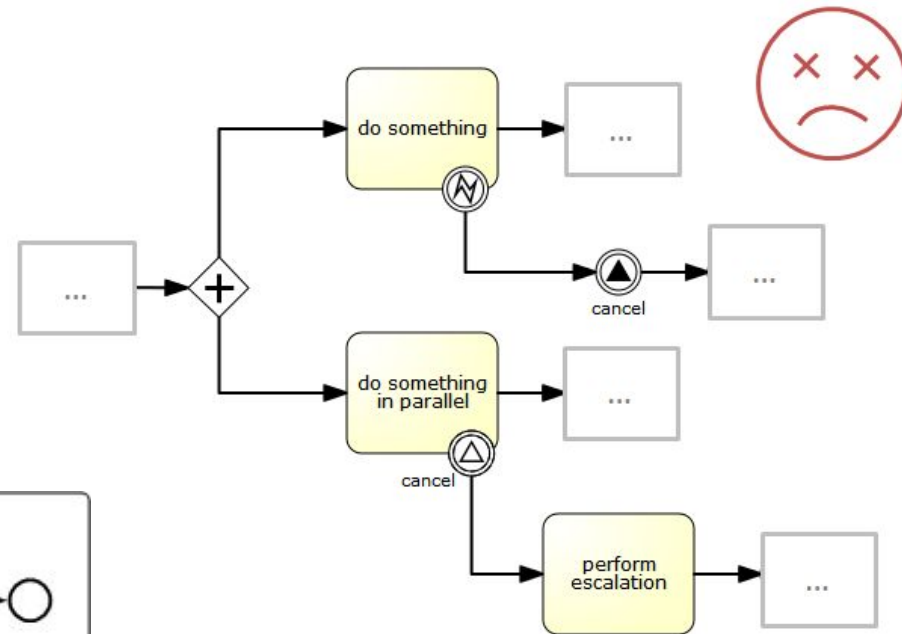
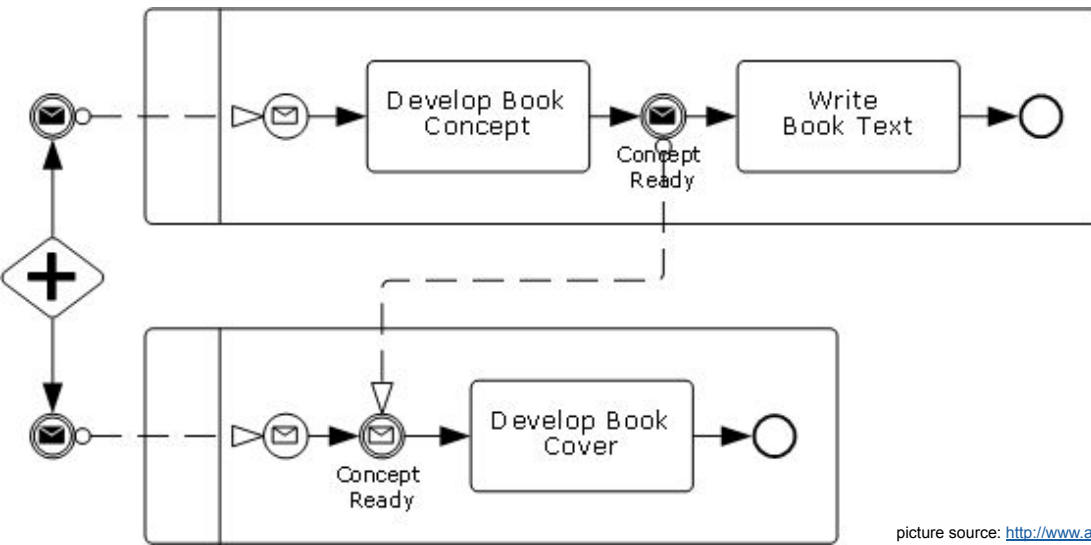

# Event types: Interrupting vs non-interrupting

- **Interrupting**

- Standard process flow is interrupted
- Flow is directed through the event

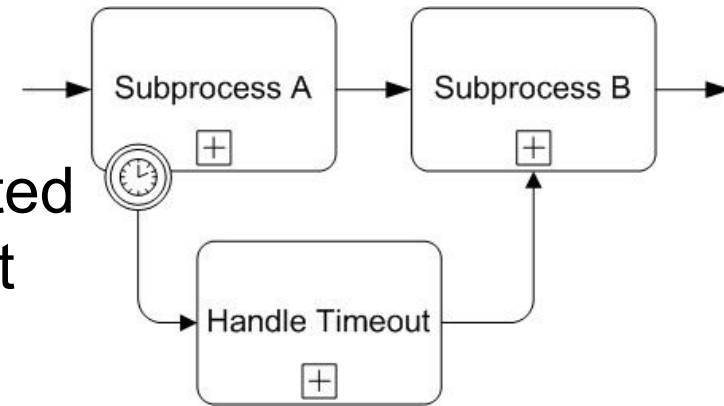

- **Non-interrupting**

- Standard flow continues normally
- Parallel flow is directed through the event

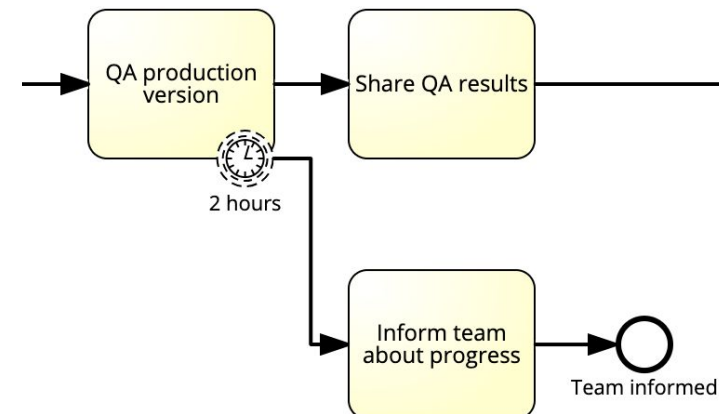

# Event types: Interrupting vs non-interrupting

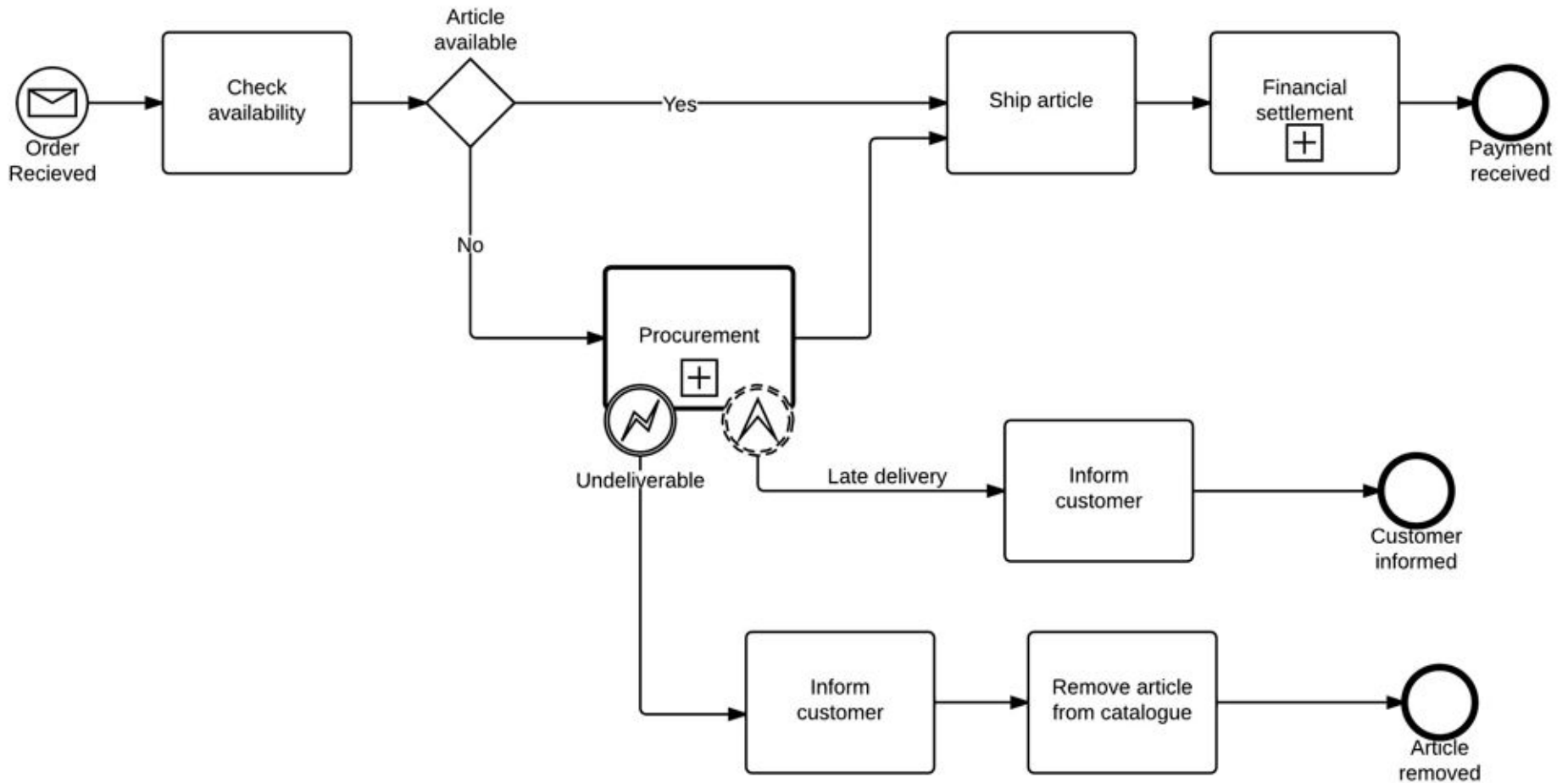

# Break 10mins

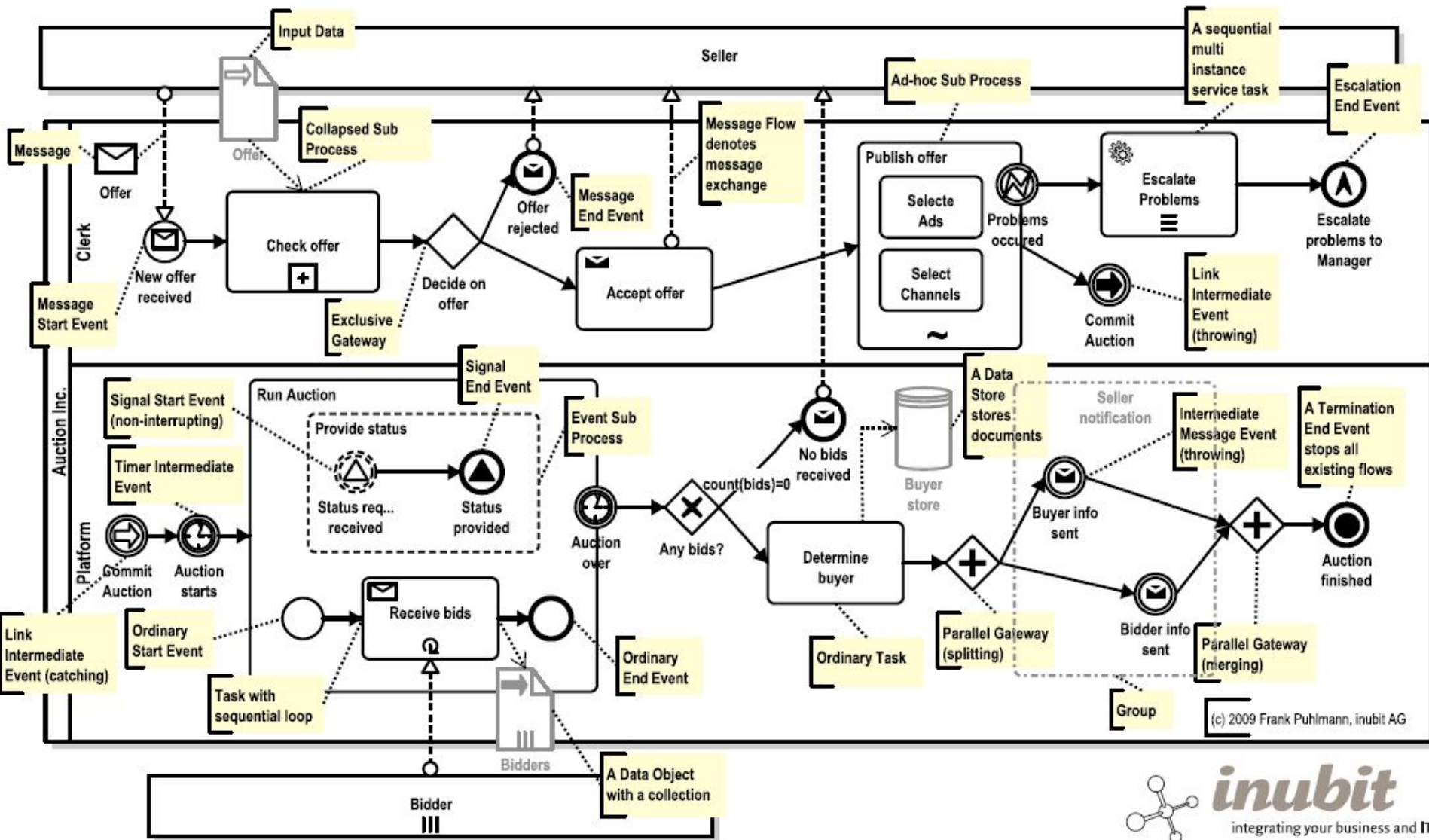

# Events

Downloaded from:

<http://frapu.de/blog/index.php?m=07&y=09&d=01&entry=entry090701-211320>

## Events

	Start			Intermediate			End
	Top-Level	Event Sub-Process Interrupting	Event Sub-Process Non-Interrupting	Catching	Boundary Interrupting	Boundary Non-Interrupting	Throwing
<b>None:</b> Untyped events, indicate start point, state changes or final states.							
<b>Message:</b> Receiving and sending messages.							
<b>Timer:</b> Cyclic timer events, points in time, time spans or timeouts.							
<b>Escalation:</b> Escalating to an higher level of responsibility.							
<b>Conditional:</b> Reacting to changed business conditions or integrating business rules.							
<b>Link:</b> Off-page connectors. Two corresponding link events equal a sequence flow.							
<b>Error:</b> Catching or throwing named errors.							
<b>Cancel:</b> Reacting to cancelled transactions or triggering cancellation.							
<b>Compensation:</b> Handling or triggering compensation.							
<b>Signal:</b> Signalling across different processes. A signal thrown can be caught multiple times.							
<b>Multiple:</b> Catching one out of a set of events. Throwing all events defined							
<b>Parallel Multiple:</b> Catching all out of a set of parallel events.							
<b>Terminate:</b> Triggering the immediate termination of a process.							

# Event types: Boundary vs. in-flow (event subprocess)

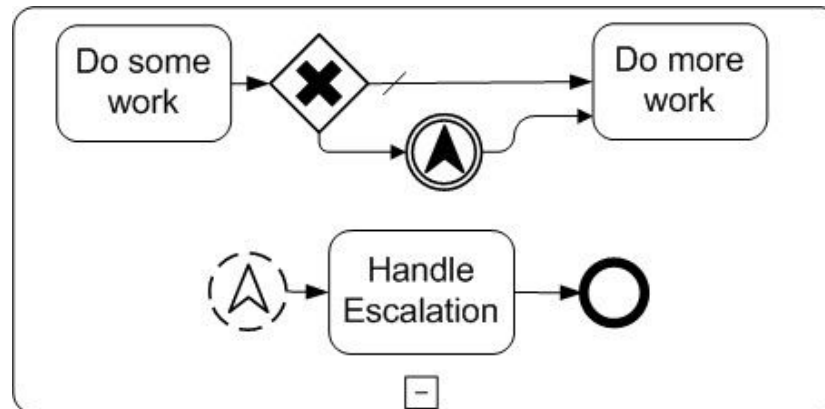
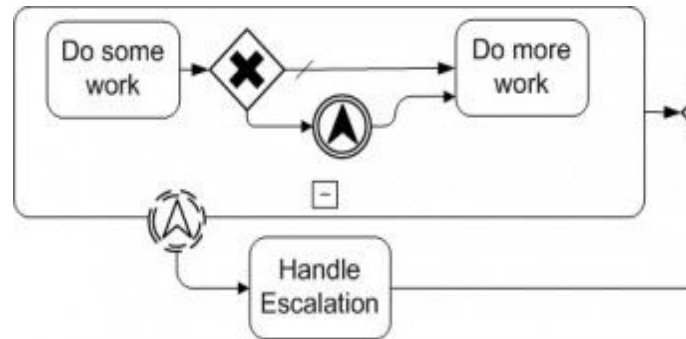

# Events

Downloaded from:

<http://frapu.de/blog/index.php?m=07&y=09&d=01&entry=entry090701-211320>

## Events

	Start			Intermediate			End
	Top-Level	Event Sub-Process Interrupting	Event Sub-Process Non-Interrupting	Catching	Boundary Interrupting	Boundary Non-Interrupting	Throwing
<b>None:</b> Untyped events, indicate start point, state changes or final states.							
<b>Message:</b> Receiving and sending messages.							
<b>Timer:</b> Cyclic timer events, points in time, time spans or timeouts.							
<b>Escalation:</b> Escalating to an higher level of responsibility.							
<b>Conditional:</b> Reacting to changed business conditions or integrating business rules.							
<b>Link:</b> Off-page connectors. Two corresponding link events equal a sequence flow.							
<b>Error:</b> Catching or throwing named errors.							
<b>Cancel:</b> Reacting to cancelled transactions or triggering cancellation.							
<b>Compensation:</b> Handling or triggering compensation.							
<b>Signal:</b> Signalling across different processes. A signal thrown can be caught multiple times.							
<b>Multiple:</b> Catching one out of a set of events. Throwing all events defined							
<b>Parallel Multiple:</b> Catching all out of a set of parallel events.							
<b>Terminate:</b> Triggering the immediate termination of a process.							

# Event semantics: Messages

- Message represents a message send by external entity ~ Pool
  - Messaging is for interprocess communication
  - Inside the process use sequence flow instead
- Message does not have to be JMS, SOAP etc. but it can be fax, mail, SMS etc.
- A Message can be received and start process
- A message can occur as intermediate event
- A message can be sent at the end of process



# Event semantics: Message - examples

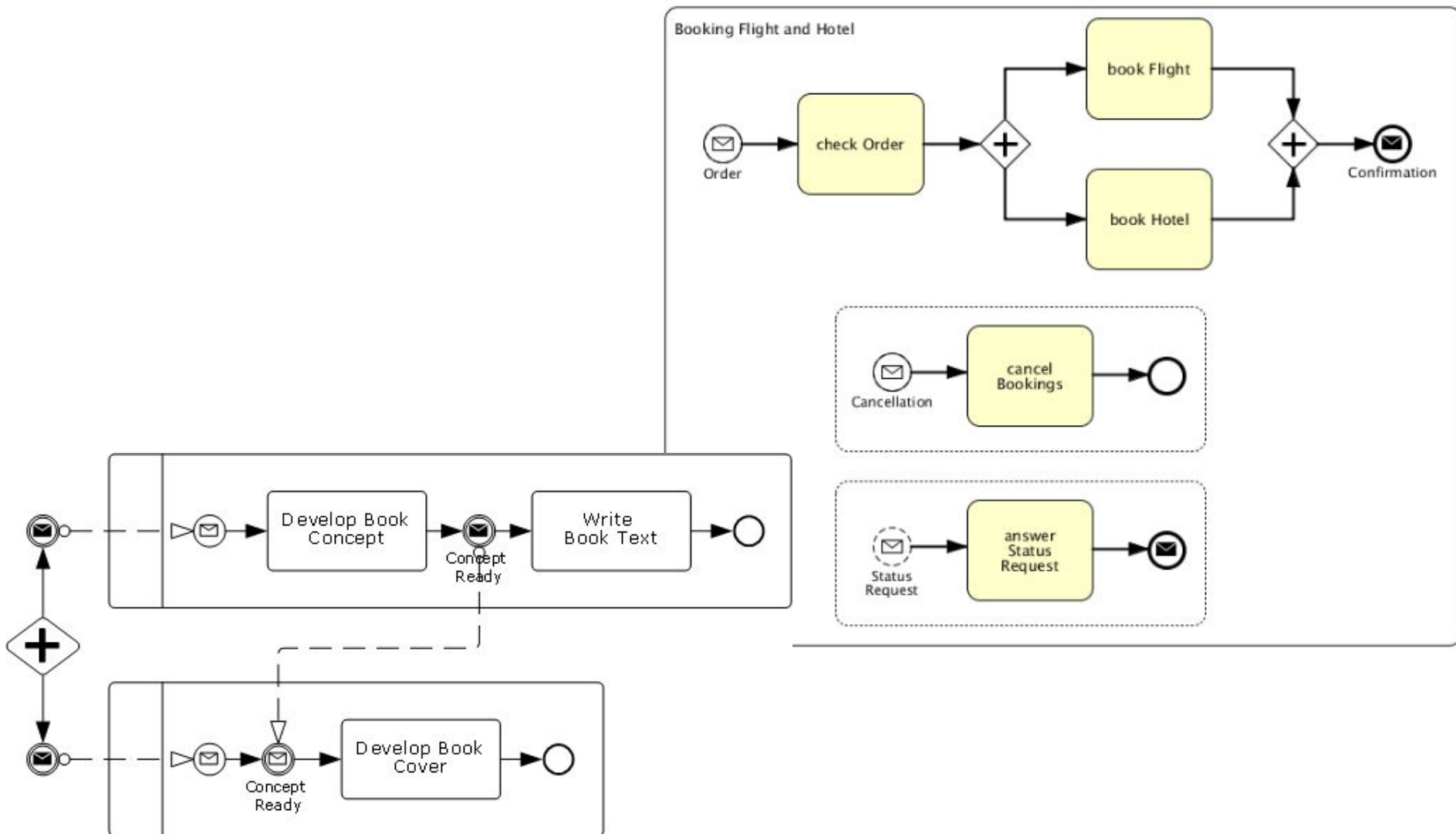

# Event semantics: Signals

- Signal is similar to message, except
  - **Is not** addressed to any particular consumer
  - Entity producing signal does not “care” who is listening
  - Many instances of the same process can consume it
  - Good for loosely coupled communication
  - Signals are used often inside one process, messages not

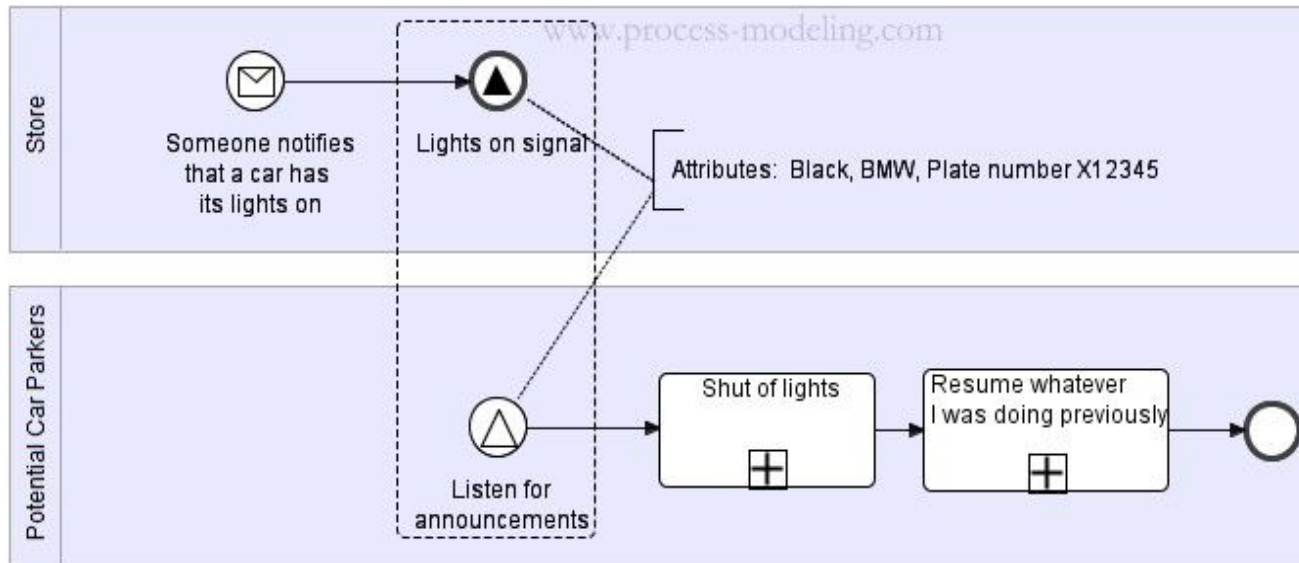

# Event semantics: Timer

- Cyclic events
- Points in time
- Timeouts

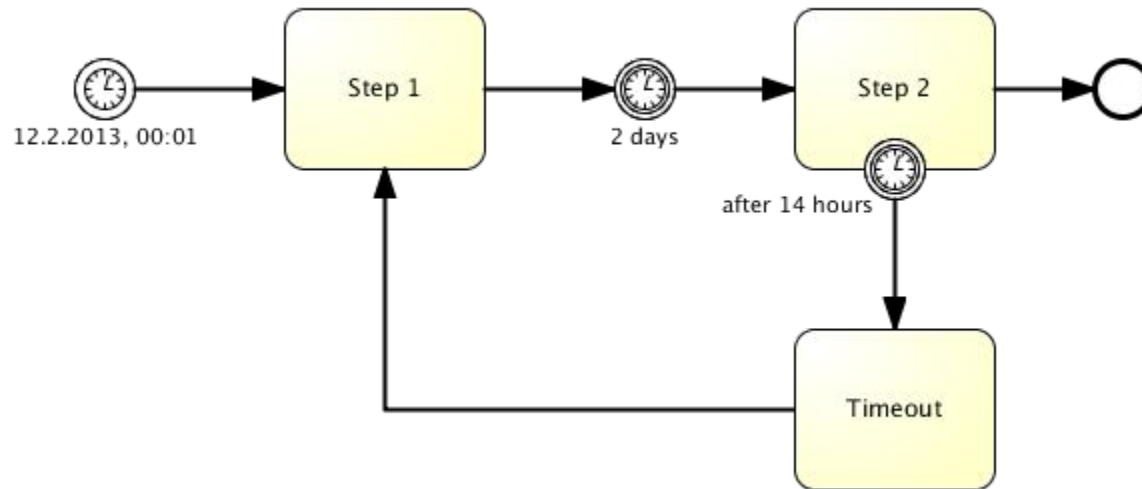

# Event semantics: Escalations



- Handling unusual but **expected** behaviour
  - Corrective actions (interrupting)
  - Additional steps to be done in parallel (non-interrupting)

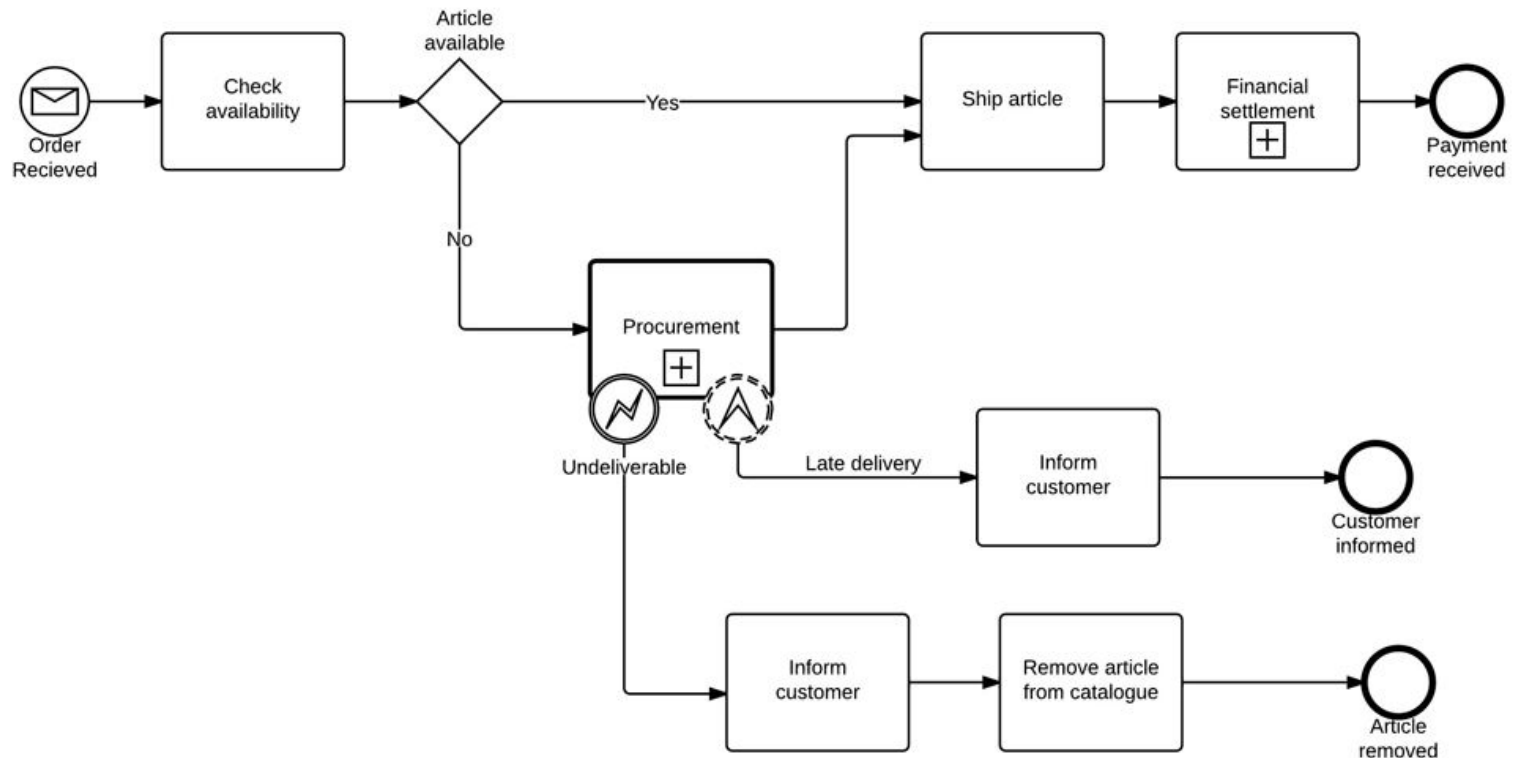

# Event semantics: Errors

- Used for **serious** problem in process
- Throw - catch mechanism
  - Always interrupting
  - Always boundary event
- There should be some **error handling actions**

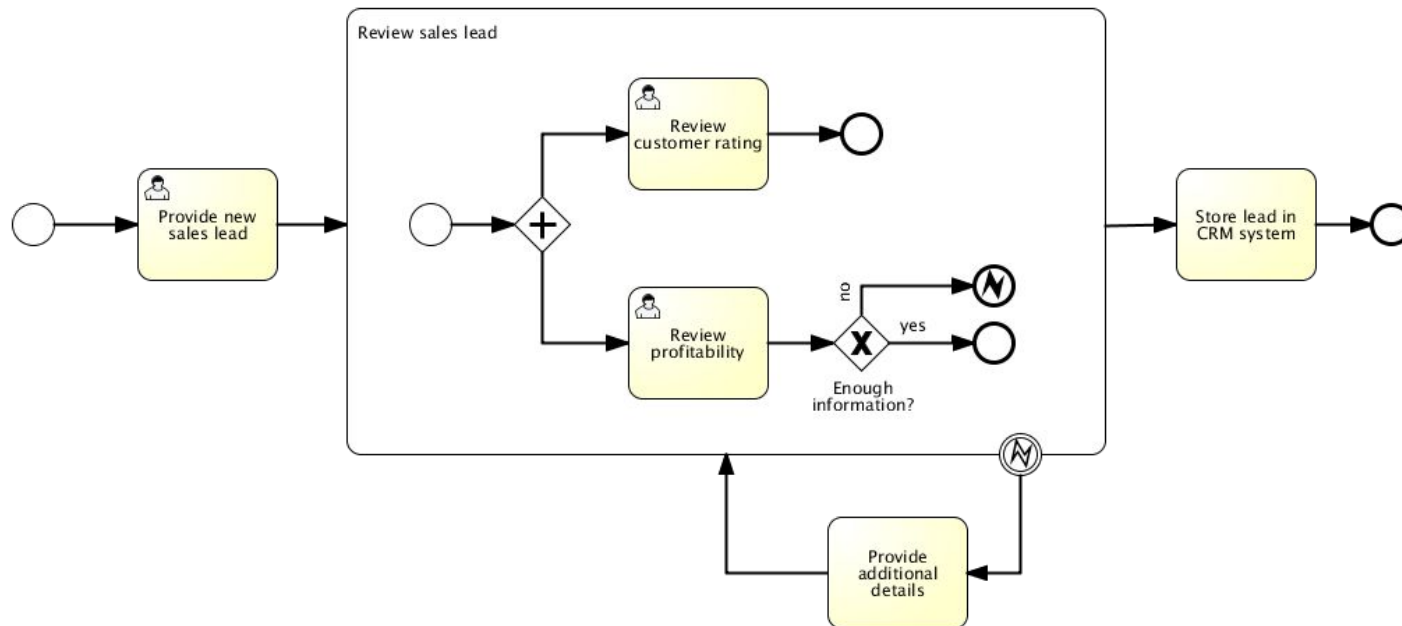

# Event-based gateway

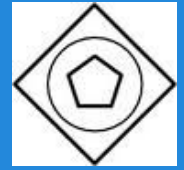

- Event-based gateway
  - Branching based on event, only one triggered
  - Different semantics – branched according to event that is placed after the gateway

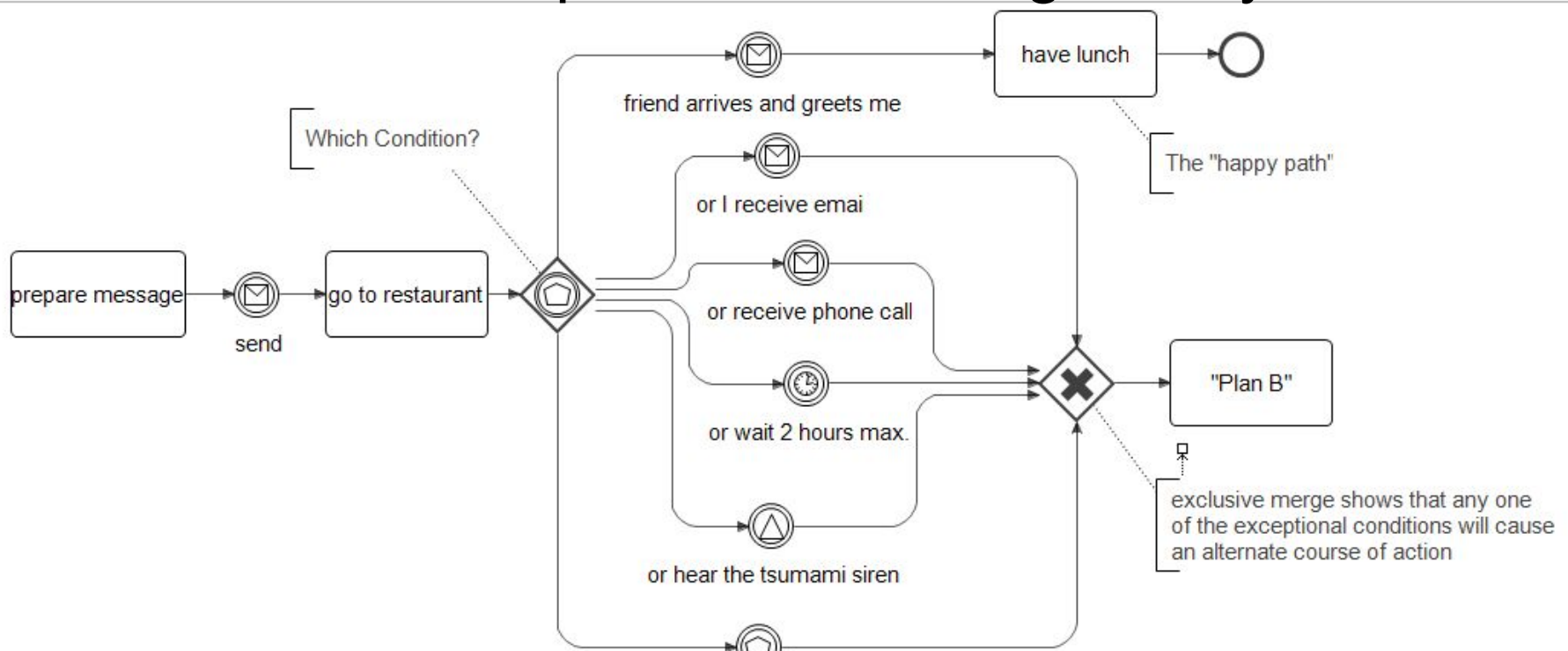

# Multi-instance and Loop activity

- Multi-instance

- Shortcut for a number (dynamically defined) of the same activities that run in parallel or in series.



- Loop

- Shortcut for a repeating one activity until a condition is met.

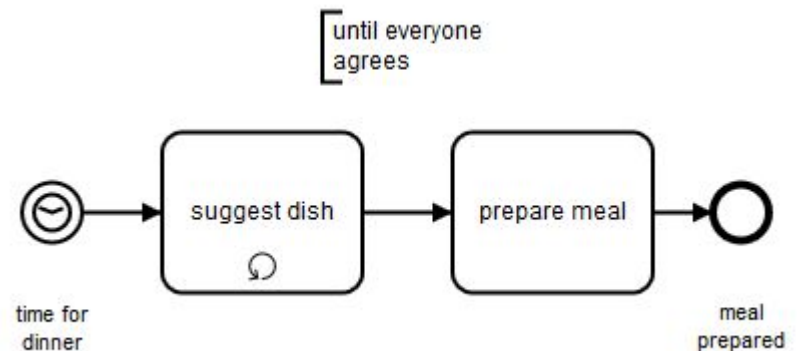

# Recap: Inclusive OR-gateway

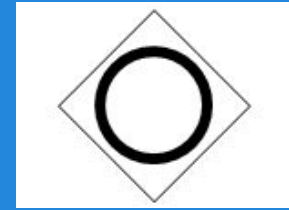

- One or more branches can be performed
- Depends on conditions
- Branches performed in parallel
- Waiting for all **activated** branches

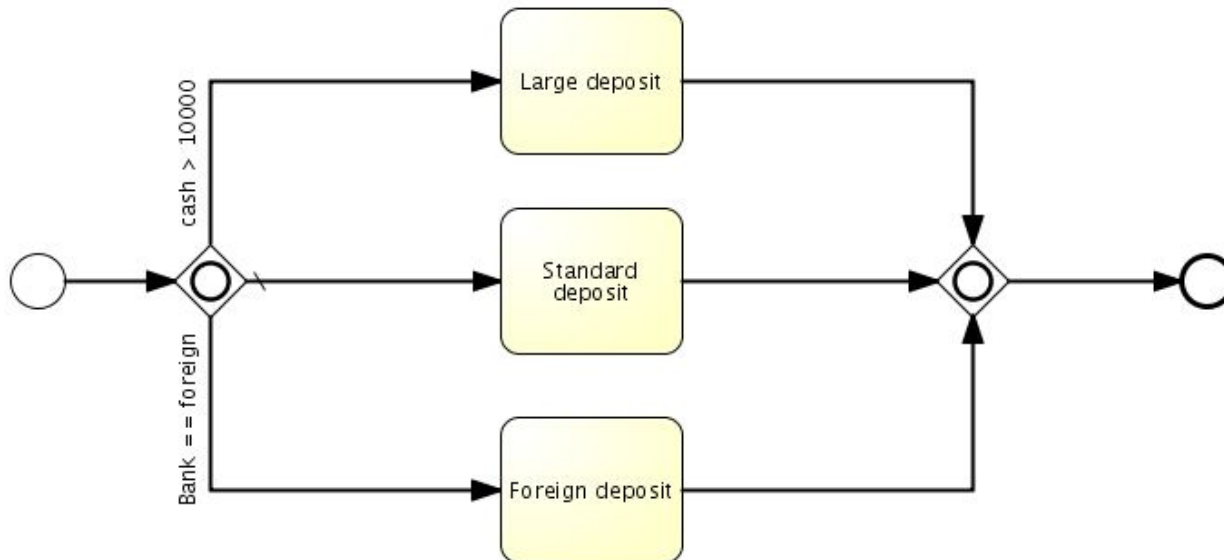



# What is in not covered here

- Transactional events
  - Compensations
  - Cancellations events
  - Rollbacks
- Other diagrams covered in BPMN 2.0 specs
  - Choreography diagrams
  - Conversation diagrams



# FIN

## Questions?

PV207 – Business Process Management

Spring 2019

Jiří Kolář, Lubomír Dočkal