



Chapter 6: Static Routing



Routing and Switching Essentials

Cisco | Networking Academy®
Mind Wide Open™



Chapter 6

6.1 Static Routing Implementation

6.2 Configure Static and Default Routes

6.3 Review of CIDR and VLSM

6.4 Configure Summary and Floating Static Routes

6.5 Troubleshoot Static and Default Route Issues

6.6 Summary



Chapter 6: Objectives

- Explain the advantages and disadvantages of static routing.
- Explain the purpose of different types of static routes.
- Configure IPv4 and IPv6 static routes by specifying a next-hop address.
- Configure an IPv4 and IPv6 default routes.
- Explain the use of legacy classful addressing in network implementation.
- Explain the purpose of CIDR in replacing classful addressing.



Chapter 6: Objectives (cont.)

- Design and implement a hierarchical addressing scheme.
- Configure an IPv4 and IPv6 summary network address to reduce the number of routing table updates.
- Configure a floating static route to provide a backup connection.
- Explain how a router processes packets when a static route is configured.
- Troubleshoot common static and default route configuration issues.



Static Routing

Reach Remote Networks

A router can learn about remote networks in one of two ways:

- **Manually** - Remote networks are manually entered into the route table using static routes.
- **Dynamically** - Remote routes are automatically learned using a dynamic routing protocol.



Static Routing

Why Use Static Routing?

Static routing provides some advantages over dynamic routing, including:

- Static routes are not advertised over the network, resulting in better security.
- Static routes use less bandwidth than dynamic routing protocols, no CPU cycles are used to calculate and communicate routes.
- The path a static route uses to send data is known.



Static Routing

Why Use Static Routing? (cont.)

Static routing has the following disadvantages:

- Initial configuration and maintenance is time-consuming.
- Configuration is error-prone, especially in large networks.
- Administrator intervention is required to maintain changing route information.
- Does not scale well with growing networks; maintenance becomes cumbersome.
- Requires complete knowledge of the whole network for proper implementation.



Static Routing

When to Use Static Routes

Static routing has three primary uses:

- Providing ease of routing table maintenance in smaller networks that are not expected to grow significantly.
- Routing to and from stub networks. A stub network is a network accessed by a single route, and the router has no other neighbors.
- Using a single default route to represent a path to any network that does not have a more specific match with another route in the routing table. Default routes are used to send traffic to any destination beyond the next upstream router.



Types of Static Routes

Static Route Applications

Static Routes are often used to:

- Connect to a specific network.
- Provide a Gateway of Last Resort for a stub network.
- Reduce the number of routes advertised by summarizing several contiguous networks as one static route.
- Create a backup route in case a primary route link fails.



Types of Static Routes

Standard Static Route

Connecting to a Stub Network

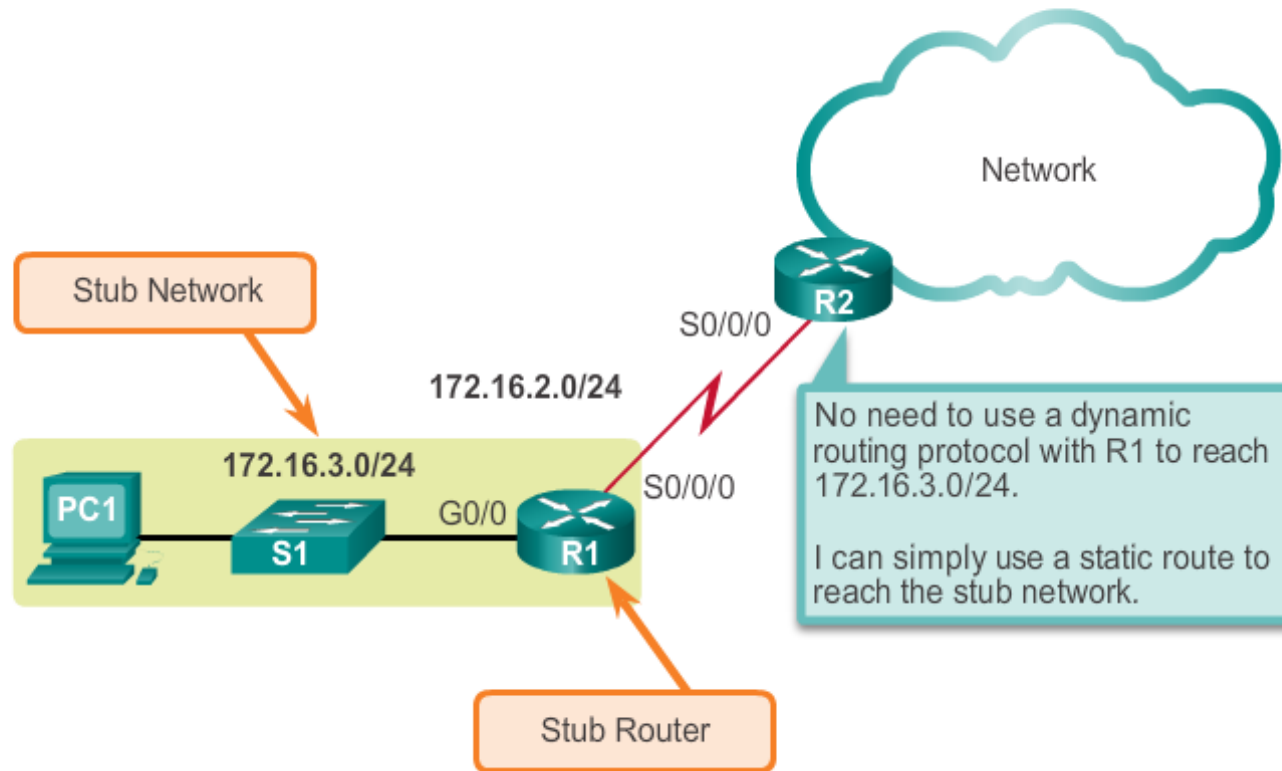



Types of Static Routes

Default Static Route

- A default static route is a route that matches all packets.
- A default route identifies the gateway IP address to which the router sends all IP packets that it does not have a learned or static route.
- A default static route is simply a static route with 0.0.0.0/0 as the destination IPv4 address.



Types of Static Routes

Summary Static Route

Using One Summary Static Route

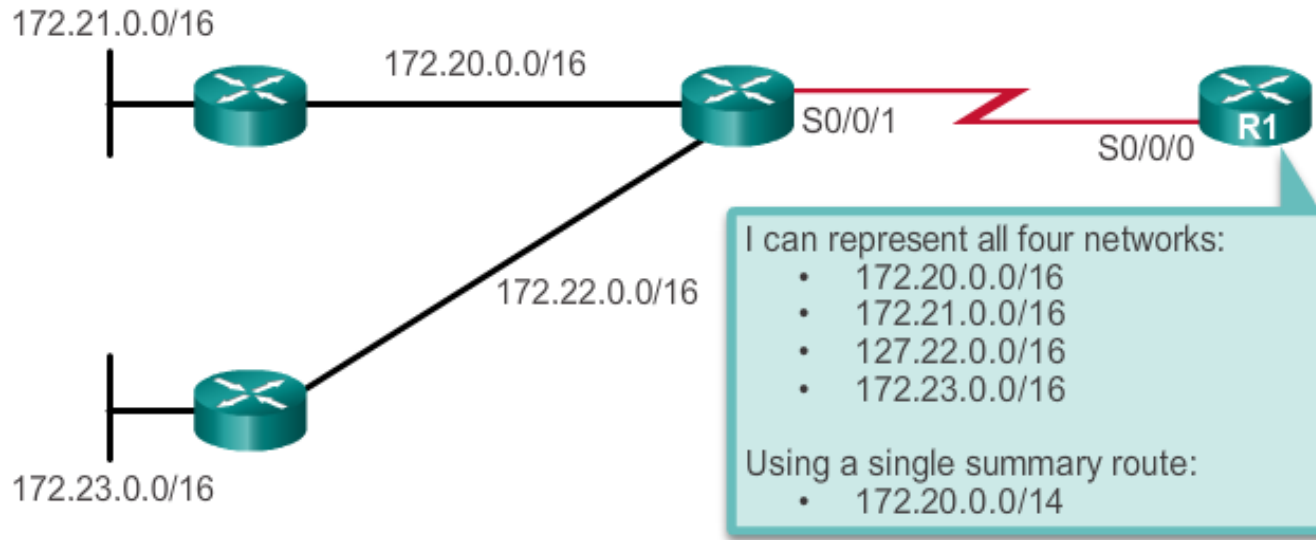



Types of Static Routes

Floating Static Route

- Floating static routes are static routes that are used to provide a backup path to a primary static or dynamic route, in the event of a link failure.
- The floating static route is only used when the primary route is not available.
- To accomplish this, the floating static route is configured with a higher administrative distance than the primary route.

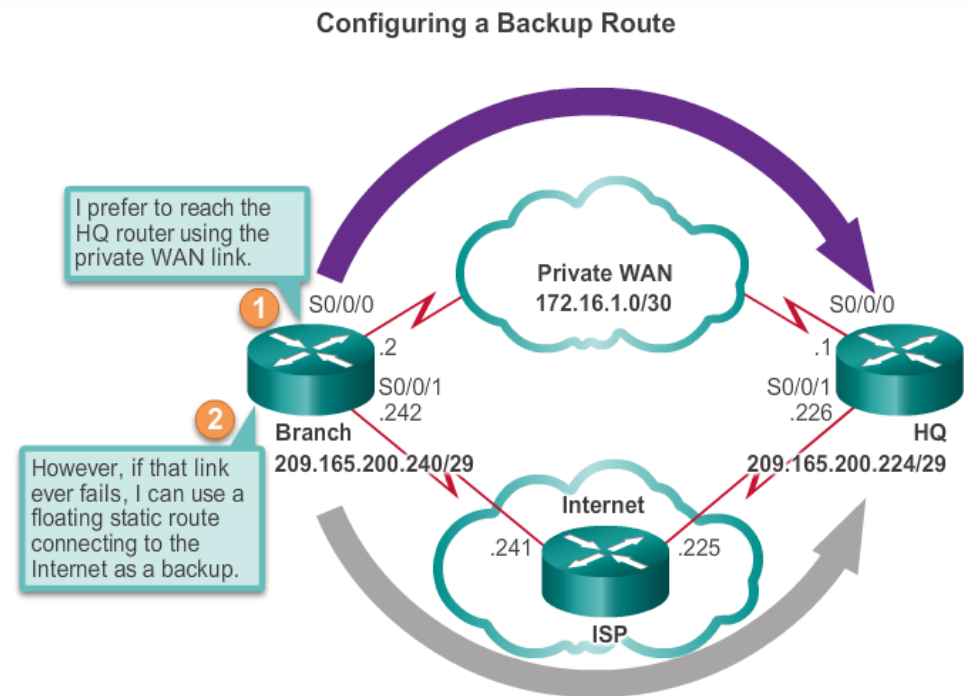



Configure IPv4 Static Routes

ip route Command

ip route Command Syntax

```
Router(config)#ip route network-address subnet-mask
{ip-address | exit-intf}
```

Parameter	Description
network-address	Destination network address of the remote network to be added to the routing table.
subnet-mask	<ul style="list-style-type: none"> Subnet mask of the remote network to be added to the routing table. The subnet mask can be modified to summarize a group of networks.
ip-address	<ul style="list-style-type: none"> Commonly referred to as the next-hop router's IP address. Typically used when connecting to a broadcast media (i.e., Ethernet). Commonly creates a recursive lookup.
exit-intf	<ul style="list-style-type: none"> Use the outgoing interface to forward packets to the destination network. Also referred to as a directly attached static route. Typically used when connecting in a point-to-point configuration.



Configure IPv4 Static Routes

Next-Hop Options

The next hop can be identified by an IP address, exit interface, or both. How the destination is specified creates one of the three following route types:

- **Next-hop route** - Only the next-hop IP address is specified.
- **Directly connected static route** - Only the router exit interface is specified.
- **Fully specified static route** - The next-hop IP address and exit interface are specified.



Configure IPv4 Static Routes

Configure a Next-Hop Static Route

When a packet is destined for the 192.168.2.0/24 network, R1:

1. Looks for a match in the routing table and finds that it has to forward the packets to the next-hop IPv4 address 172.16.2.2.

2. R1 must now determine how to reach 172.16.2.2; therefore, it searches a second time for a 172.16.2.2 match.

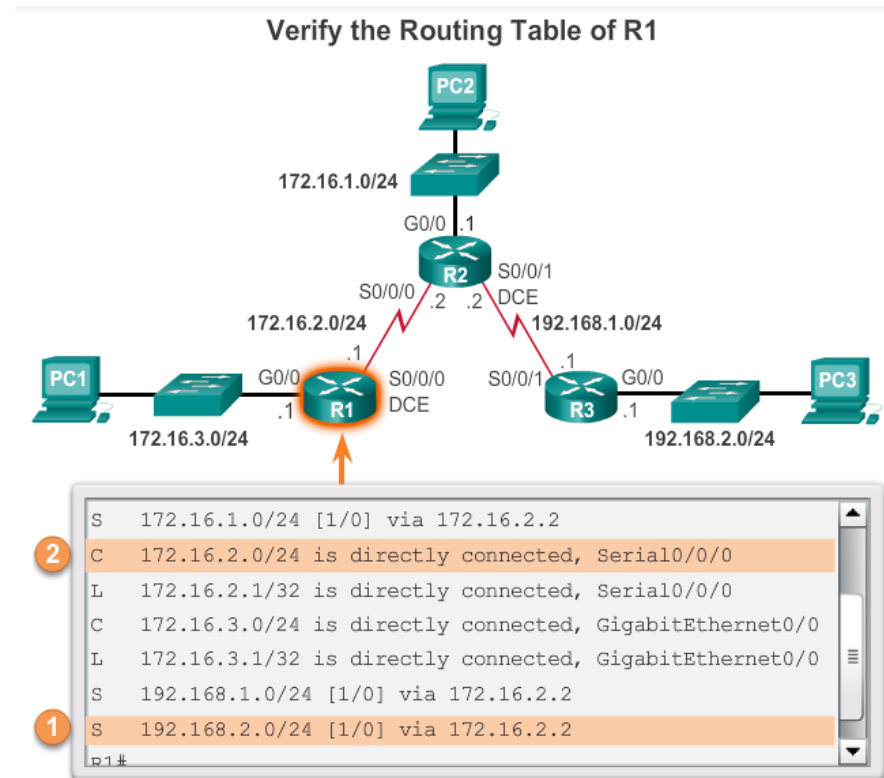



Configure IPv4 Static Routes

Configure Directly Connected Static Route

Configure Directly Attached Static Routes on R1

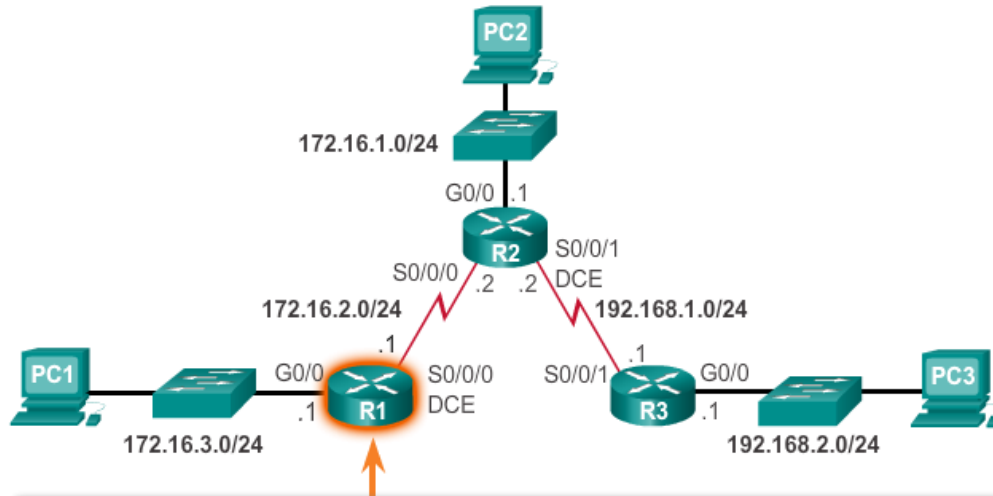

```
R1 (config) #ip route 172.16.1.0 255.255.255.0 s0/0/0
R1 (config) #ip route 192.168.1.0 255.255.255.0 s0/0/0
R1 (config) #ip route 192.168.2.0 255.255.255.0 s0/0/0
R1 (config) #
```

```
S    172.16.1.0/24 is directly connected, Serial0/0/0
C    172.16.2.0/24 is directly connected, Serial0/0/0
L    172.16.2.1/32 is directly connected, Serial0/0/0
C    172.16.3.0/24 is directly connected, GigabitEthernet0/0
L    172.16.3.1/32 is directly connected, GigabitEthernet0/0
S    192.168.1.0/24 is directly connected, Serial0/0/0
S    192.168.2.0/24 is directly connected, Serial0/0/0
R1#
```



Configure IPv4 Static Routes

Configure a Fully Specified Static Route

In a fully specified static route:

- Both the output interface and the next-hop IP address are specified.
- This is another type of static route that is used in older IOSs, prior to CEF.
- This form of static route is used when the output interface is a multi-access interface and it is necessary to explicitly identify the next hop.
- The next hop must be directly connected to the specified exit interface.



Configure IPv4 Static Routes

Verify a Static Route

Along with `ping` and `tracert`, useful commands to verify static routes include:

- `show ip route`
- `show ip route static`
- `show ip route network`



Configure IPv4 Default Routes

Default Static Route

Default Static Route Syntax

```
Router (config) # ip route 0.0.0.0 0.0.0.0 {ip-address | exit-intf}
```

Parameter	Description
0.0.0.0	Matches any network address.
0.0.0.0	Matches any subnet mask.
ip-address	<ul style="list-style-type: none"> Commonly referred to as the next-hop router's IP address. Typically used when connecting to a broadcast media (i.e., Ethernet). Commonly creates a recursive lookup.
exit-intf	<ul style="list-style-type: none"> Use the outgoing interface to forward packets to the destination network. Also referred to as a directly attached static route. Typically used when connecting in a point-to-point configuration.



Configure IPv4 Default Routes

Configure a Default Static Route

Configuring a Default Static Route

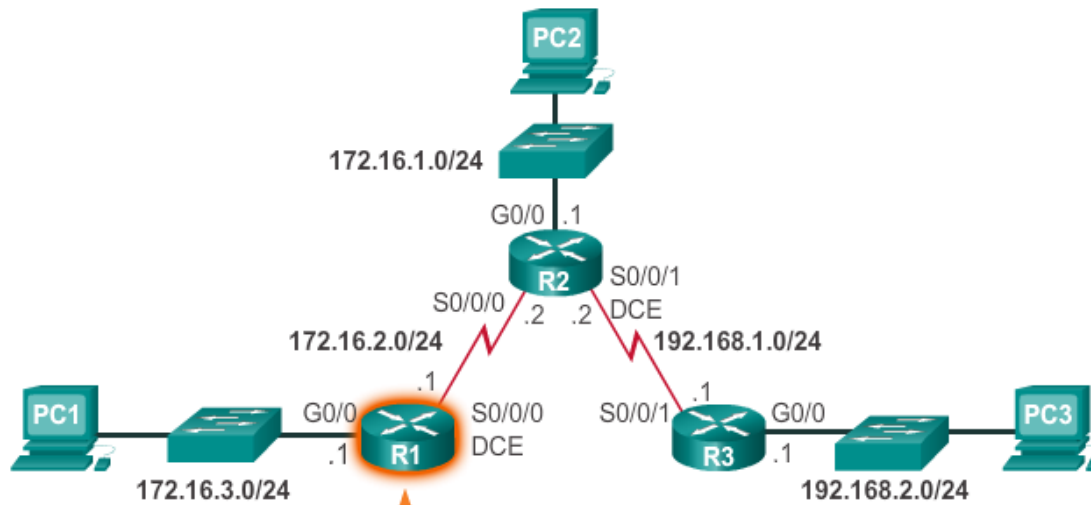

```
R1 (config) # ip route 0.0.0.0 0.0.0.0 172.16.2.2
R1 (config) #
```



Configure IPv4 Default Routes

Verify a Default Static Route

Verifying the Routing Table of R1

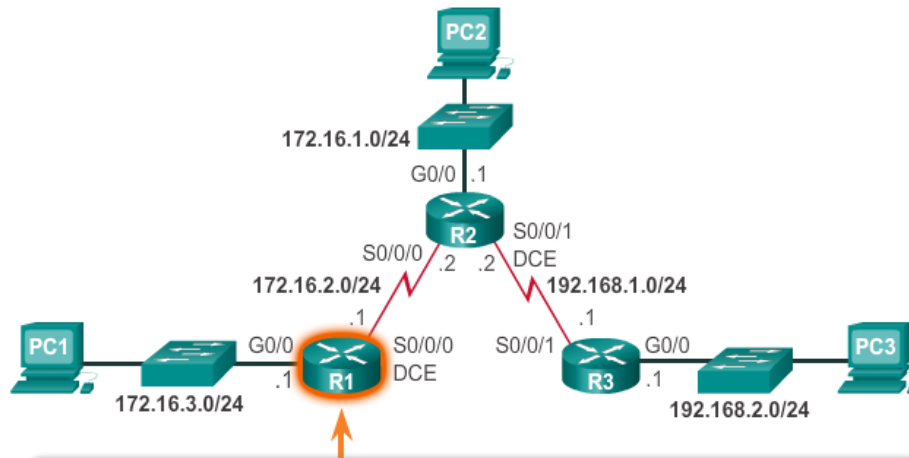

```
R1#show ip route static
Codes: L - local, C - connected, S - static, R - RIP,
M - mobile, B - BGP, D - EIGRP,
EX - EIGRP external, O - OSPF, IA - OSPF inter area
N1 - OSPF NSSA extern
N2 - OSPF NSSA extern
E1 - OSPF external ty
E2 - OSPF external ty
su - IS-IS summarv. L
```

```
* - candidate default, U - per-user static route
o - ODR, P - periodic downloaded static route,
H - NHRP, l - LISP, + - replicated route,
% - next hop override

2 Gateway of last resort is 172.16.2.2 to network 0.0.0.0
1 S* 0.0.0.0/0 [1/0] via 172.16.2.2
R1#
```



Configure IPv6 Static Routes

The `ipv6 route` Command

Most of parameters are identical to the IPv4 version of the command. IPv6 static routes can also be implemented as:

- Standard IPv6 static route
- Default IPv6 static route
- Summary IPv6 static route
- Floating IPv6 static route

```
Router(config)#ipv6 route ipv6-prefix/ipv6-mask
{ipv6-address | exit-intf}
```



Configure IPv6 Static Routes

Next-Hop Options

The next hop can be identified by an IPv6 address, exit interface, or both. How the destination is specified creates one of three route types:

- **Next-hop IPv6 route** - Only the next-hop IPv6 address is specified.
- **Directly connected static IPv6 route** - Only the router exit interface is specified.
- **Fully specified static IPv6 route** - The next-hop IPv6 address and exit interface are specified.



Configure IPv6 Static Routes

Configure a Next-Hop Static IPv6 Route

Configure Next-hop Static IPv6 Routes

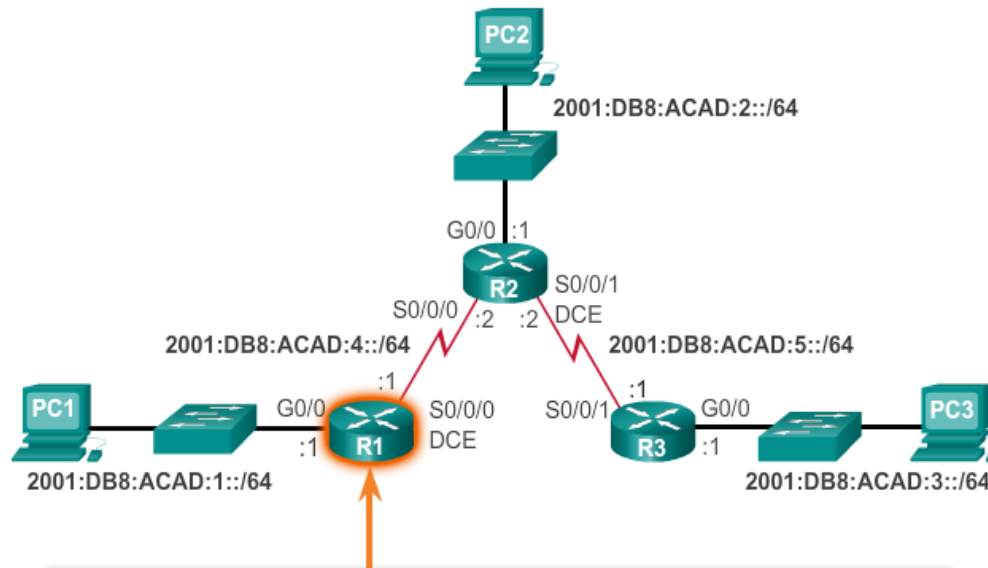

```

R1 (config) #ipv6 route 2001:DB8:ACAD:2::/64 2001:DB8:ACAD:4::2
R1 (config) #ipv6 route 2001:DB8:ACAD:5::/64 2001:DB8:ACAD:4::2
R1 (config) #ipv6 route 2001:DB8:ACAD:3::/64 2001:DB8:ACAD:4::2
R1 (config) #
    
```



Configure IPv6 Static Routes

Configure Directly Connected Static IPv6 Route

Configure Directly Connected Static IPv6 Routes on R1

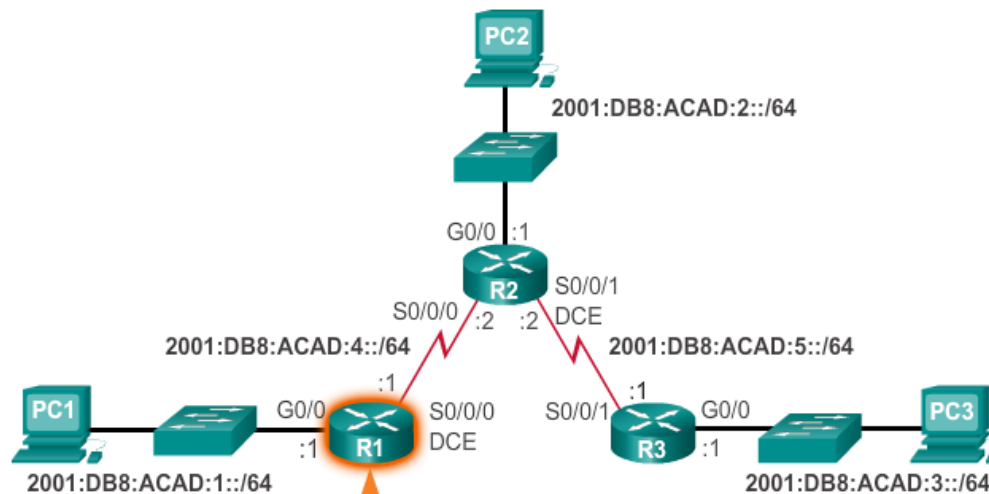

```

R1 (config) #ipv6 route 2001:DB8:ACAD:2::/64 s0/0/0
R1 (config) #ipv6 route 2001:DB8:ACAD:5::/64 s0/0/0
R1 (config) #ipv6 route 2001:DB8:ACAD:3::/64 s0/0/0
R1 (config) #
R1#
    
```



Configure IPv6 Static Routes

Configure Fully Specified Static IPv6 Route

Configure Fully Specified Static IPv6 Routes on R1



```
R1(config)# ipv6 route 2001:db8:acad:2::/64 fe80::2
% Interface has to be specified for a link-local nexthop
R1(config)# ipv6 route 2001:db8:acad:2::/64 s0/0/0 fe80::2
R1(config)#
```



Configure IPv6 Static Routes

Verify IPv6 Static Routes

Along with `ping` and `tracert`, useful commands to verify static routes include:

- `show ipv6 route`
- `show ipv6 route static`
- `show ipv6 route network`



Configure IPv6 Default Routes

Default Static IPv6 Route

Default Static IPv6 Route Syntax

```
Router(config)#ipv6 route ::/0 {ipv6-address | exit-intf}
```

Parameter	Description
::/0	Matches any IPv6 prefix regardless of IPv6 mask.
ip-address	<ul style="list-style-type: none"> Commonly referred to as the next-hop router's IPv6 address. Typically used when connecting to a broadcast media (i.e., Ethernet). Commonly creates a recursive lookup.
exit-intf	<ul style="list-style-type: none"> Use the outgoing interface to forward packets to the destination network. Also referred to as a directly attached static route. Typically used when connecting in a point-to-point configuration.



Configure IPv6 Default Routes

Configure a Default Static IPv6 Route

Configuring a Default Static IPv6 Route

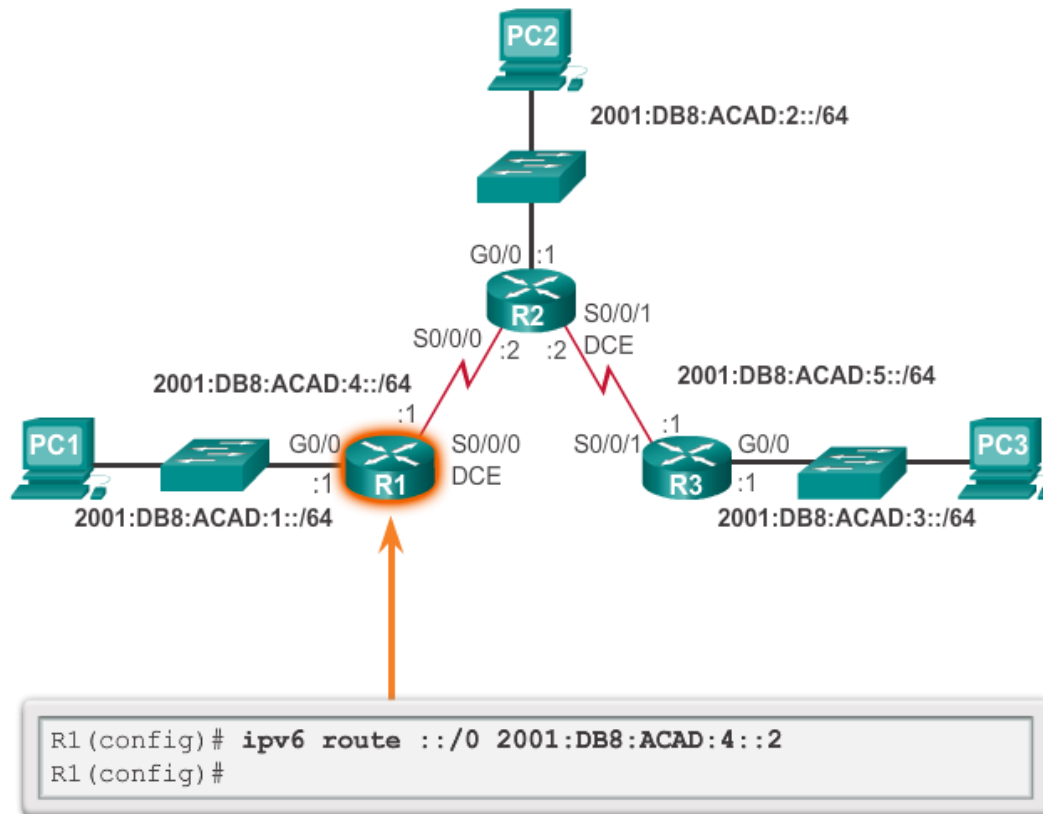



Configure IPv6 Default Routes

Verify a Default Static Route

Verifying the Routing Table of R1

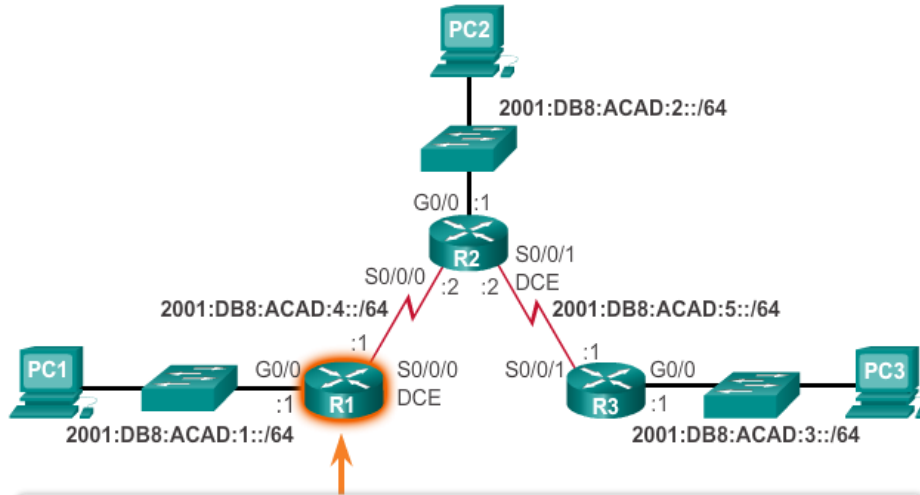

```
R1#show ipv6 route static
IPv6 Routing Table - default - 6 entries
Codes: C - Connected, L - Local, S - Static,
U - Per-user Static route
B - BGP, R - RIP, I1 - ISIS L1
IA - ISIS interarea, IS - ISIS
D - EIGRP, EX - EIGRP external
ND - ND Default, NDp - ND Pref
DCE - Destination, NDr - Redir
```

```
D - EIGRP, EX - EIGRP external
ND - ND Default, NDp - ND Prefix,
DCE - Destination, NDr - Redirect
O - OSPF Intra, OI - OSPF Inter, OE1 - OSPF ext 1,
OE2 - OSPF ext 2
ON1 - OSPF NSSA ext 1, ON2 - OSPF NSSA ext 2
S ::/0 [1/0]
via 2001:DB8:ACAD:4::2
R1#
```



Classful Addressing

Classful Network Addressing

Class	High Order Bits	Start	End
Class A	0xxxxxxx	0.0.0.0	127.255.255.255
Class B	10xxxxxx	128.0.0.0	191.255.255.255
Class C	110xxxxx	192.0.0.0	223.255.255.255
Multicast	1110xxxx	224.0.0.0	239.255.255.255
Reserved	1111xxxx	240.0.0.0	255.255.255.255



Classful Addressing

Classful Subnet Masks

Class A

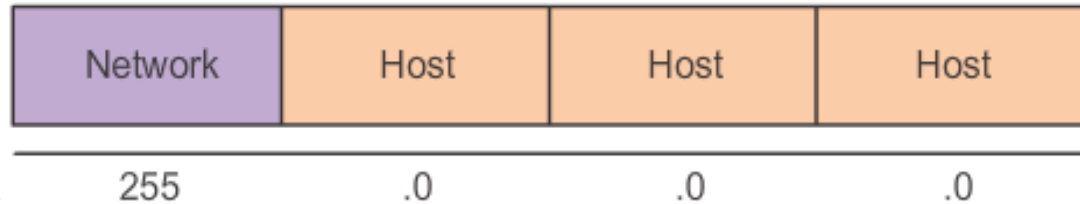

Class B

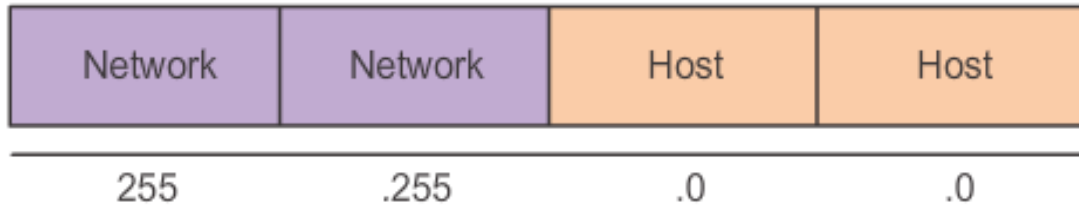

Class C

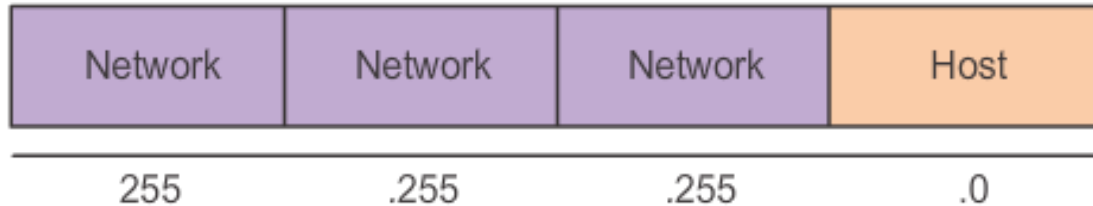



Classful Addressing Classful Routing Protocol Example

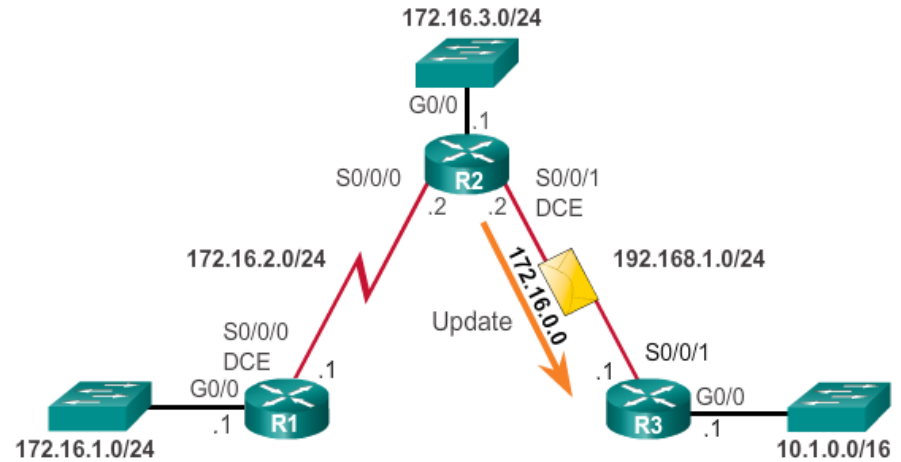
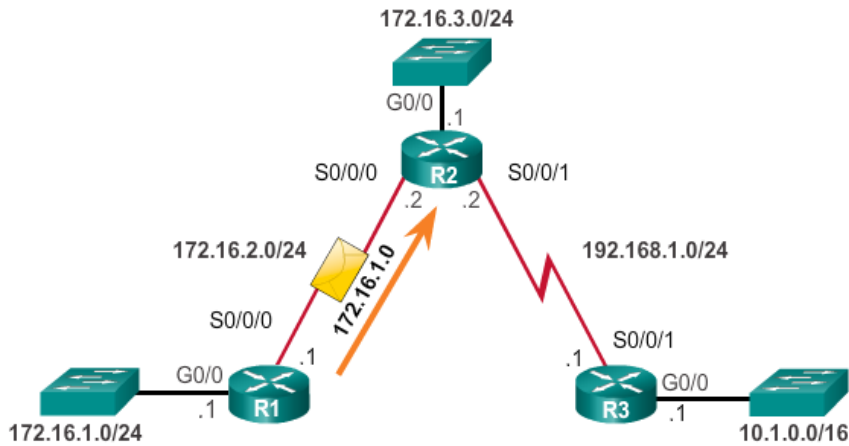



Classful Addressing

Classful Addressing Waste

Classful IP Address Allocation = Inefficient

Class A (1 - 126)
 # of possible networks: 126
 # of Hosts/Net: 16,777,214
 Max. # Hosts: 2,113,928,964

Class B (128 - 191)
 # of possible networks: 16,384
 # of Hosts/Net: 65,534
 Max. # Hosts: 1,073,709,056

Class C (192 - 223)
 # of possible networks: 2,097,152
 # of Hosts/Net: 254
 Max. # Hosts: 532,676,608

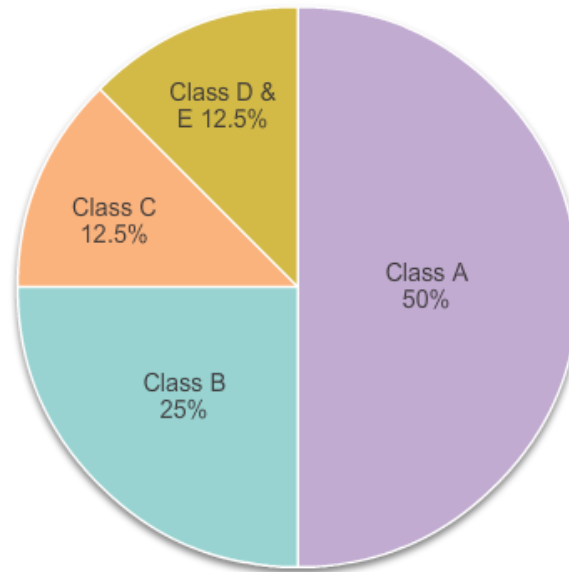



CIDR Classless Inter-Domain Routing

CIDR = Efficient

Class A (1 - 126)
 # of possible networks: 126
 # of Hosts/Net: 16,777,214
 Max. # Hosts: 16,777,214

Class B (128 - 191)
 # of possible networks: 16,384
 # of Hosts/Net: 65,534
 Max. # Hosts: 1,073,709,056

Class C (192 - 223)
 # of possible networks: 2,097,152
 # of Hosts/Net: 254
 Max. # Hosts: 522,676,608

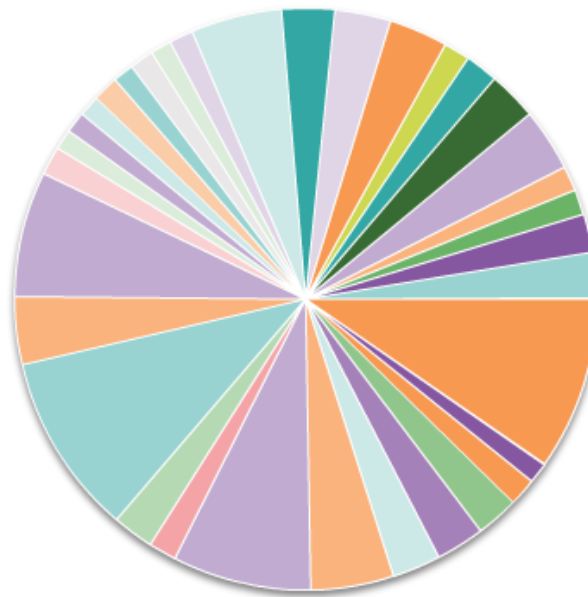



CIDR

CIDR and Route Summarization

Summarizing Supernet Routes

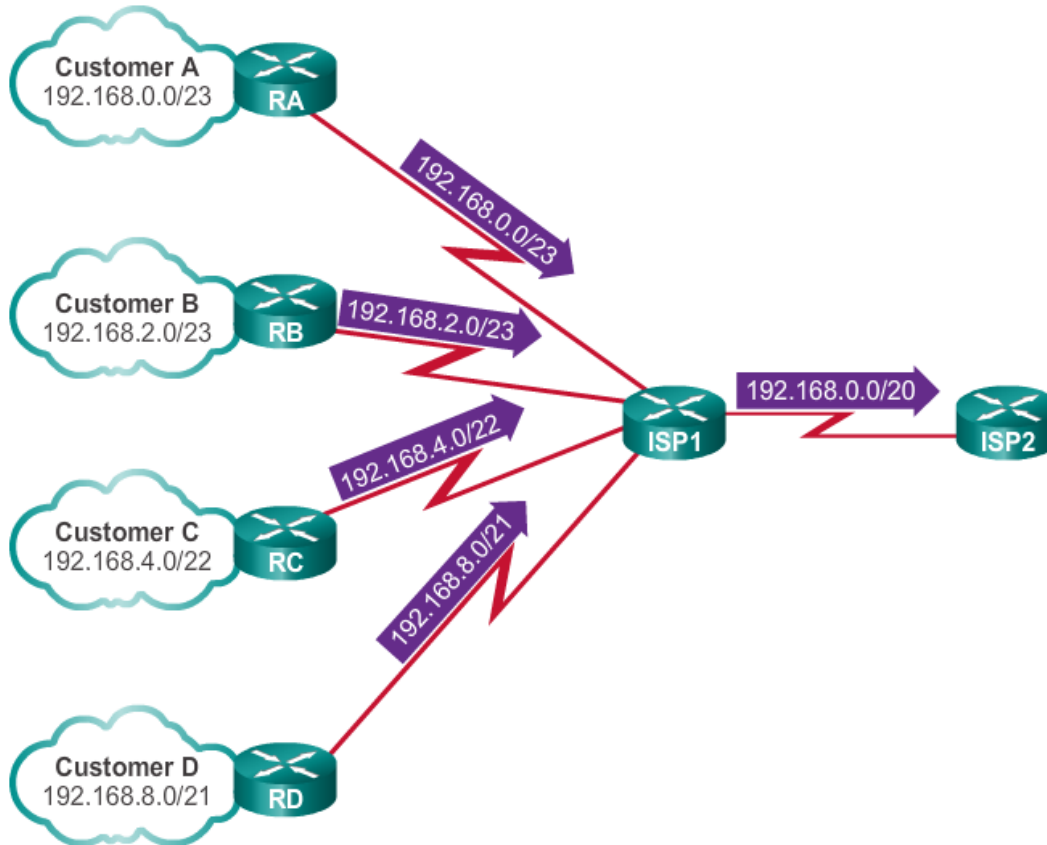



CIDR

Static Routing CIDR Example

One Summary Static Route

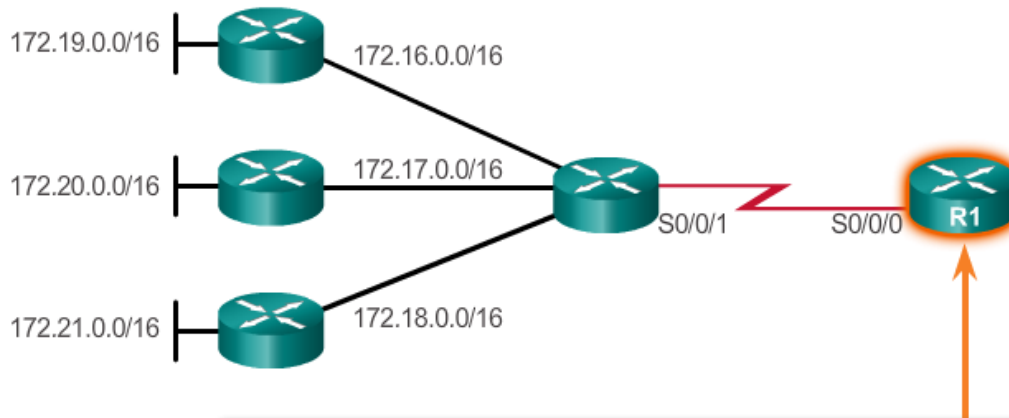

```

R1 (config) #no ip route 172.16.0.0 255.255.0.0 s0/0/0
R1 (config) #no ip route 172.17.0.0 255.255.0.0 s0/0/0
R1 (config) #no ip route 172.18.0.0 255.255.0.0 s0/0/0
R1 (config) #no ip route 172.19.0.0 255.255.0.0 s0/0/0
R1 (config) #no ip route 172.20.0.0 255.255.0.0 s0/0/0
R1 (config) #no ip route 172.21.0.0 255.255.0.0 s0/0/0
R1 (config) #
R1 (config) #ip route 172.16.0.0 255.248.0.0 s0/0/0
R1 (config) #
  
```



CIDR Classless Routing Protocol Example

Classless Routing Update

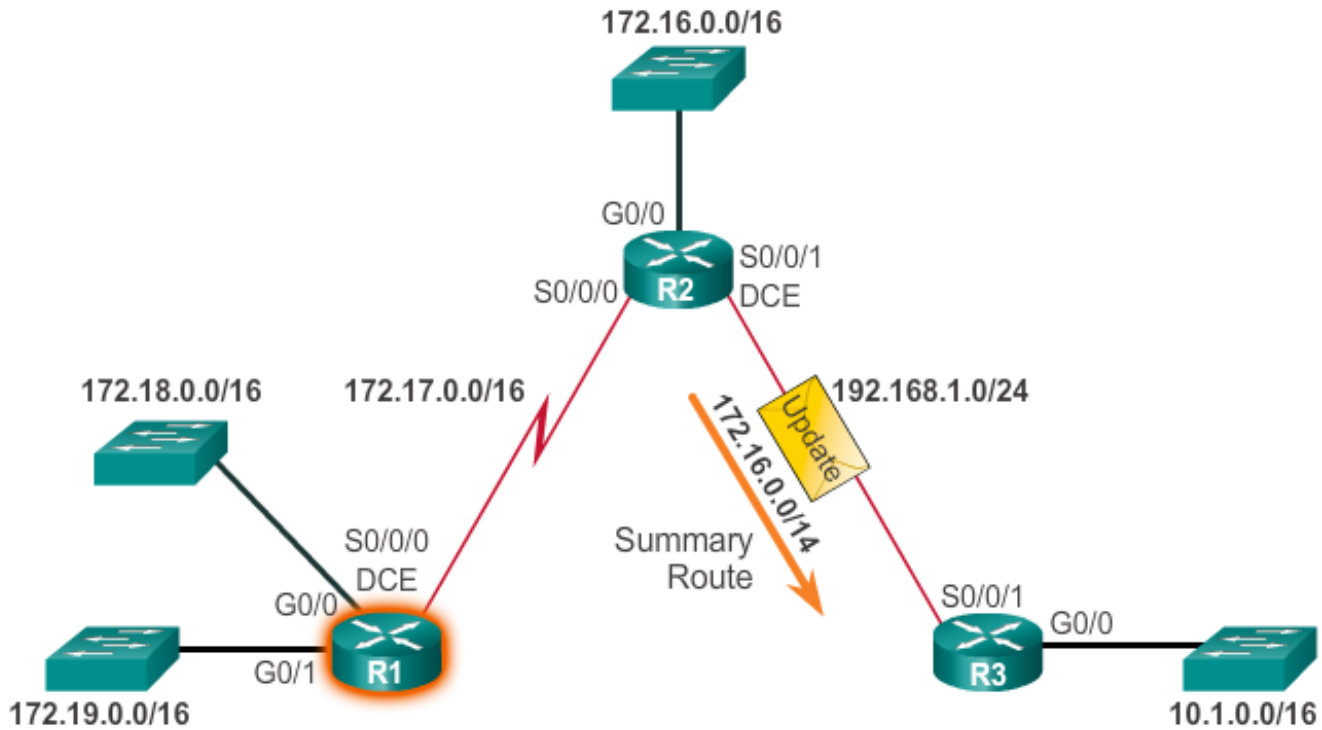



VLSM

Fixed Length Subnet Masking

Basic Subnet Scheme

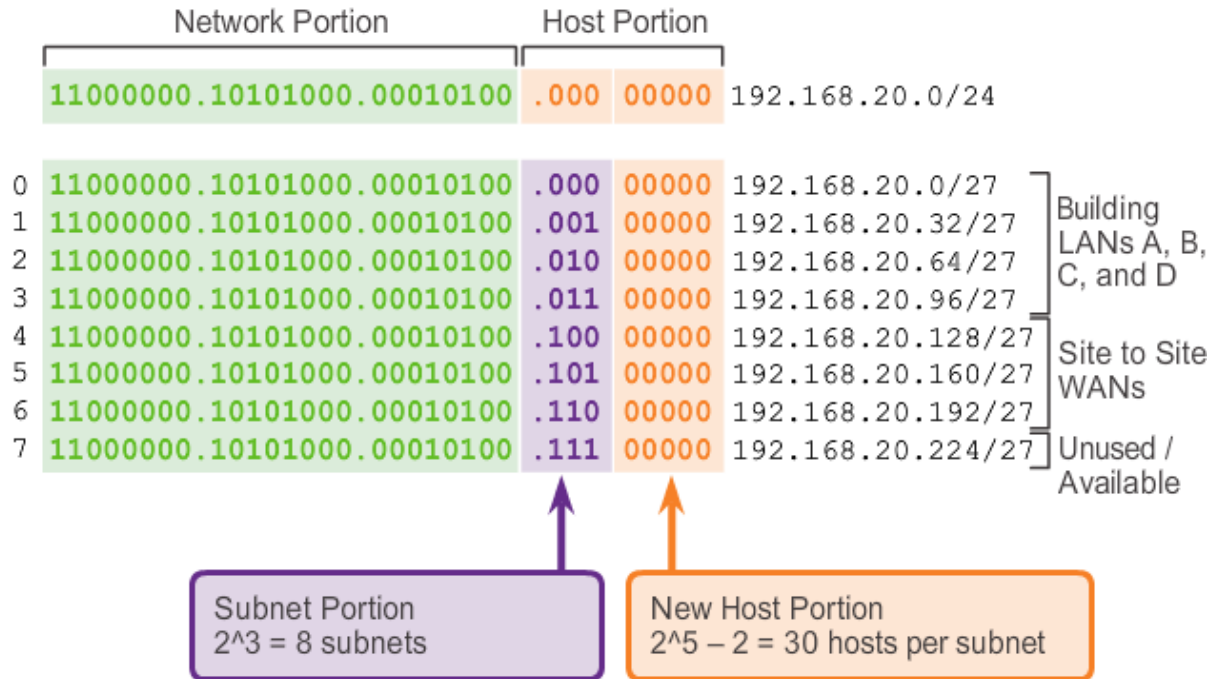



VLSM Variable Length Subnet Masking

Subnets of Varying Sizes

One subnet was further divided to create 8 smaller subnets of 2 hosts each.

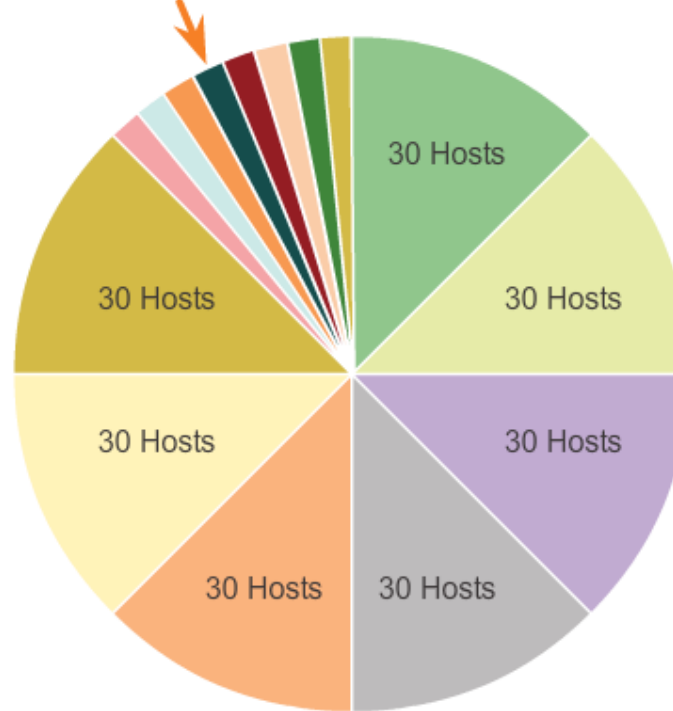



VLSM

VLSM in Action

VLSM allows the use of different masks for each subnet:

- After a network address is subnetted, those subnets can be further subnetted.
- VLSM is simply subnetting a subnet. VLSM can be thought of as sub-subnetting.
- Individual host addresses are assigned from the addresses of "sub-subnets".



VLSM

Subnetting Subnets

Subnetting the Subnet 10.2.0.0/16 to 10.2.0.0/24

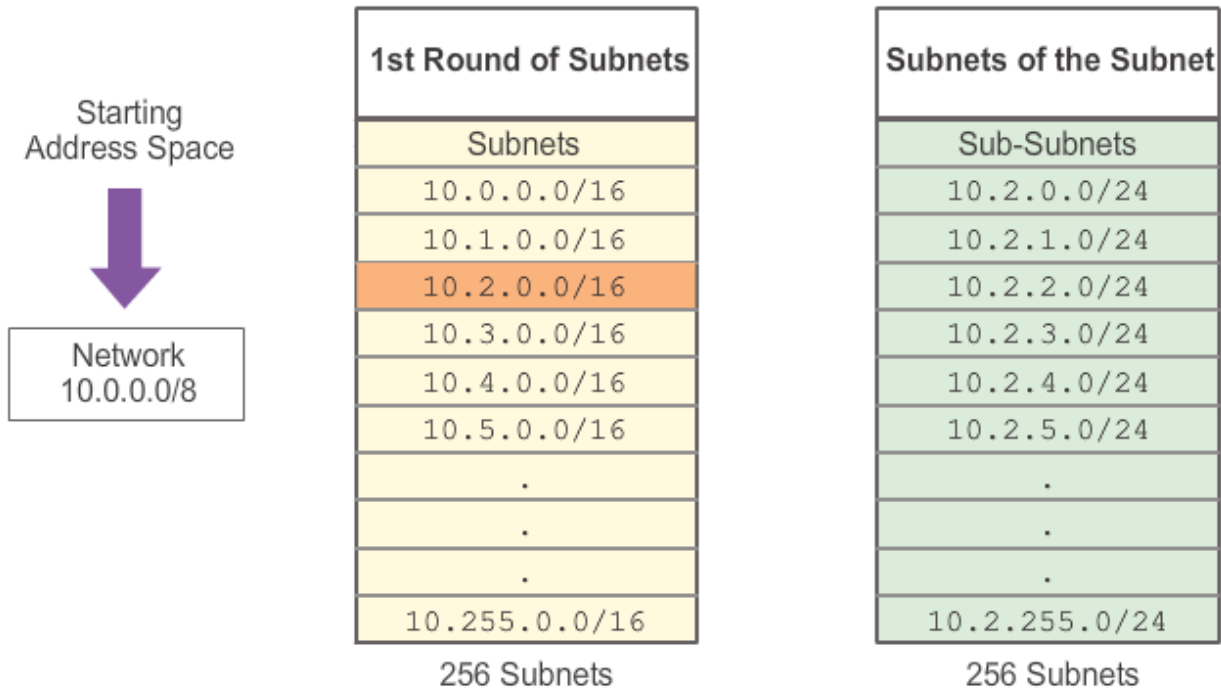



VLSM

VLSM Example

Subnetting Subnet 192.168.20.224/27 to 192.168.20.224/30

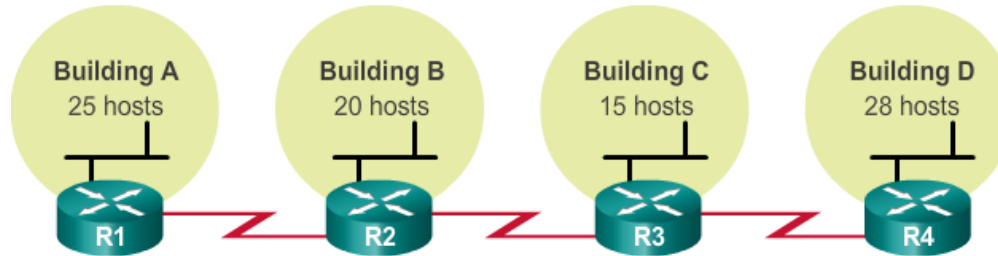

	/27 Network	Hosts
Bldg A	.0	.1 - .30
Bldg B	.32	.33 - .62
Bldg C	.64	.65 - .94
Bldg D	.96	.97 - .126
Unused	.128	.129 - .158
Unused	.160	.161 - .190
Unused	.192	.193 - .222
	.224	.225 - .254



	/30 Network	Hosts
WAN R1-R2	.224	.225 - .226
WAN R2-R3	.228	.229 - .230
WAN R3-R4	.232	.233 - .234



Configure IPv4 Summary Routes

Route Summarization

Route summarization, also known as route aggregation, is the process of advertising a contiguous set of addresses as a single address with a less-specific, shorter subnet mask:

- CIDR is a form of route summarization and is synonymous with the term supernetting.
- CIDR ignores the limitation of classful boundaries, and allows summarization with masks that are smaller than that of the default classful mask.
- This type of summarization helps reduce the number of entries in routing updates and lowers the number of entries in local routing tables.



Configure IPv4 Summary Routes

Calculate a Summary Route

Calculating a Route Summary

Step 1: List networks in binary format.

172.20.0.0	10101100 . 00010100	00 . 00000000 . 00000000
172.21.0.0	10101100 . 00010101	01 . 00000000 . 00000000
172.22.0.0	10101100 . 00010110	10 . 00000000 . 00000000
172.23.0.0	10101100 . 00010111	11 . 00000000 . 00000000

Step 2: Count the number of far-left matching bits to determine the mask.

Answer: 14 matching bits = /14 or 255.252.0.0

Step 3: Copy the matching bits and add zero bits to determine the network address.

10101100 . 00010100	00 . 00000000 . 00000000
└── Copy ──┘	└── Add zero bits ──┘

Answer: 172.20.0.0



Configure IPv4 Summary Routes

Summary Static Route Example

Verify the Routing Table

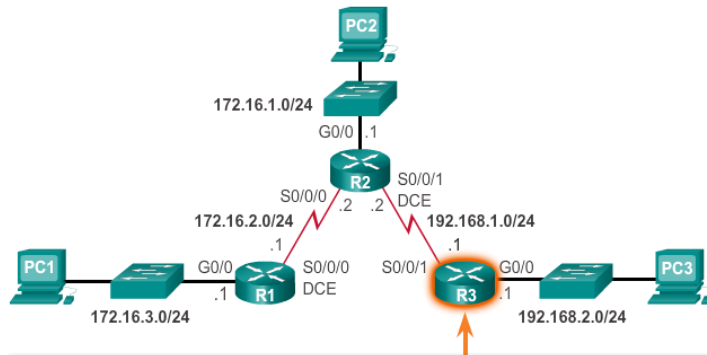

```
R3# show ip route static | begin Gateway
Gateway of last resort is not set

172.16.0.0/24 is subnetted, 3 subnets
S    172.16.1.0 [1/0] via 192.168.1.2
S    172.16.2.0 [1/0] via 192.168.1.2
S    172.16.3.0 [1/0] via 192.168.1.2
```

Summary Boundary

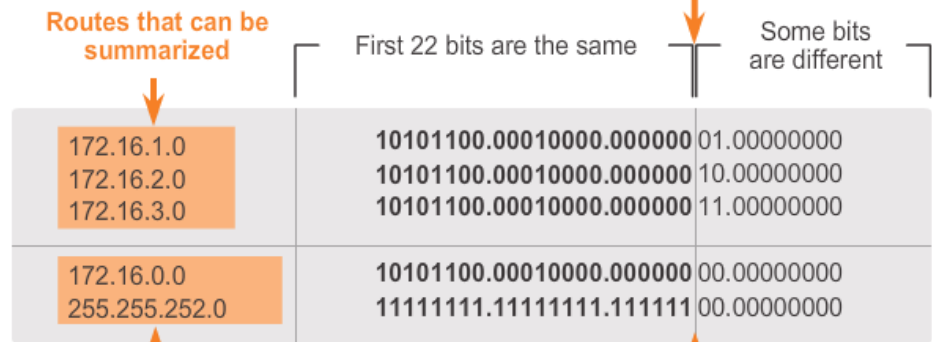

172.16.0.0 255.255.252.0



Configure IPv6 Summary Routes

Summarize IPv6 Network Addresses

- Aside from the fact that IPv6 addresses are 128 bits long and written in hexadecimal, summarizing IPv6 addresses is actually similar to the summarization of IPv4 addresses. It just requires a few extra steps due to the abbreviated IPv6 addresses and hex conversion.
- Multiple static IPv6 routes can be summarized into a single static IPv6 route if:
 - The destination networks are contiguous and can be summarized into a single network address.
 - The multiple static routes all use the same exit interface or next-hop IPv6 address.



Configure IPv6 Summary Routes

Calculate IPv6 Network Addresses

There are seven steps to summarize IPv6 networks into a single IPv6 prefix:

Step 1. List the network addresses (prefixes) and identify the part where the addresses differ.

Step 2. Expand the IPv6 if it is abbreviated.

Step 3. Convert the differing section from hex to binary.

Step 4. Count the number of far left matching bits to determine the prefix-length for the summary route.

Step 5. Copy the matching bits and then add zero bits to determine the summarized network address (prefix).

Step 6. Convert the binary section back to hex.

Step 7. Append the prefix of the summary route (result of Step 4).



Configure IPv6 Summary Routes

Configure an IPv6 Summary Address

Remove Static Routes and Configure Summary IPv6 Route

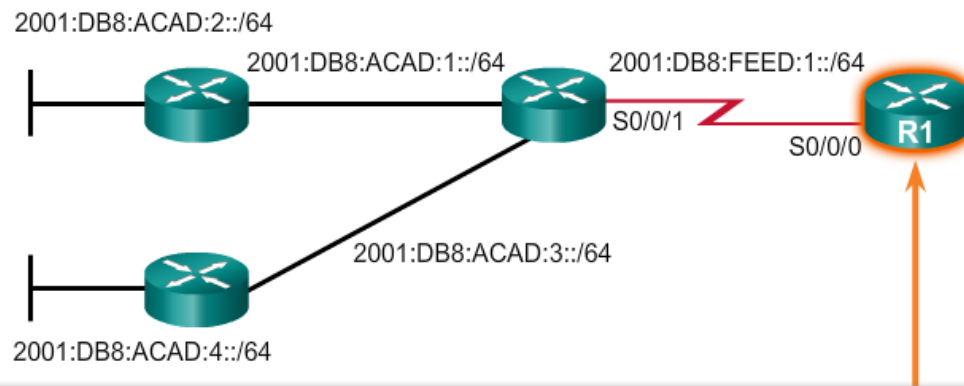

```

R1 (config) # no ipv6 route 2001:DB8:ACAD:1::/64 2001:db8:feed:1::2
R1 (config) # no ipv6 route 2001:DB8:ACAD:2::/64 2001:db8:feed:1::2
R1 (config) # no ipv6 route 2001:DB8:ACAD:3::/64 2001:db8:feed:1::2
R1 (config) # no ipv6 route 2001:DB8:ACAD:4::/64 2001:db8:feed:1::2
R1 (config) #
R1 (config) #
R1 (config) # ipv6 route 2001:DB8:ACAD::/45 2001:db8:feed:1::2
R1 (config) #
    
```



Configure Floating Static Routes

Floating Static Routes

Floating static routes are static routes that have an administrative distance greater than the administrative distance of another static route or dynamic routes:

- The administrative distance of a static route can be increased to make the route less desirable than that of another static route or a route learned through a dynamic routing protocol.
- In this way, the static route “floats” and is not used when the route with the better administrative distance is active.
- However, if the preferred route is lost, the floating static route can take over, and traffic can be sent through this alternate route.



Configure Floating Static Routes

Configure a Floating Static Route

Configuring a Floating Static Route to R3

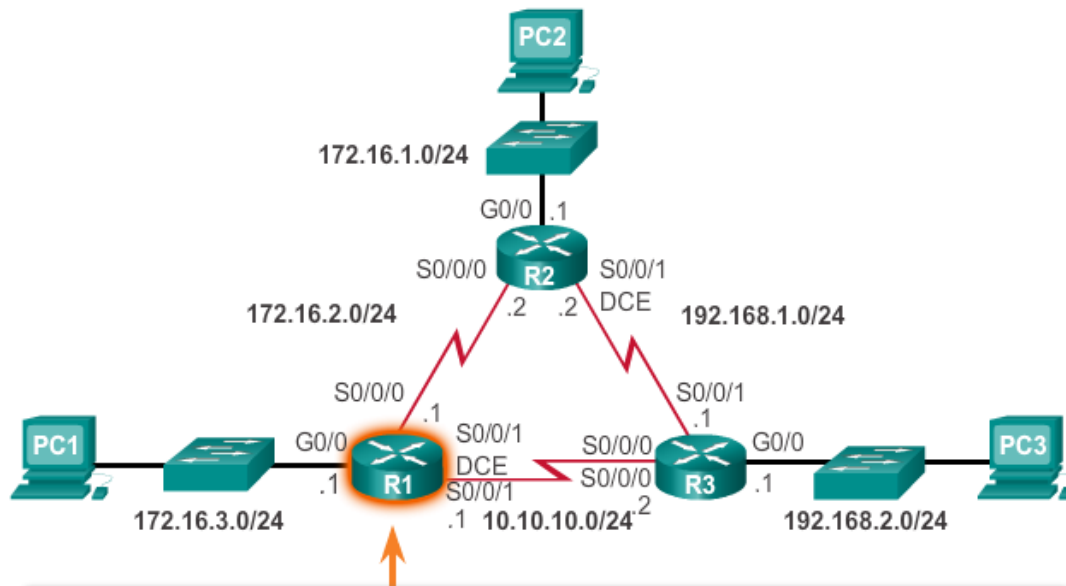

```

R1 (config) # ip route 0.0.0.0 0.0.0.0 172.16.2.2
R1 (config) # ip route 0.0.0.0 0.0.0.0 10.10.10.2 5
R1 (config) #
    
```



Configure Floating Static Routes

Test the Floating Static Route

To test a floating static route:

- Use a **show ip route** command to verify that the routing table is using the default static route.
- Use a **traceroute** command to follow the traffic flow out the primary route.
- Disconnect the primary link or shutdown the primary exit interface.
- Use a **show ip route** command to verify that the routing table is using the floating static route.
- Use a **traceroute** command to follow the traffic flow out the backup route.



Troubleshoot Static and Default Route Issues

Static Routes and Packet Forwarding

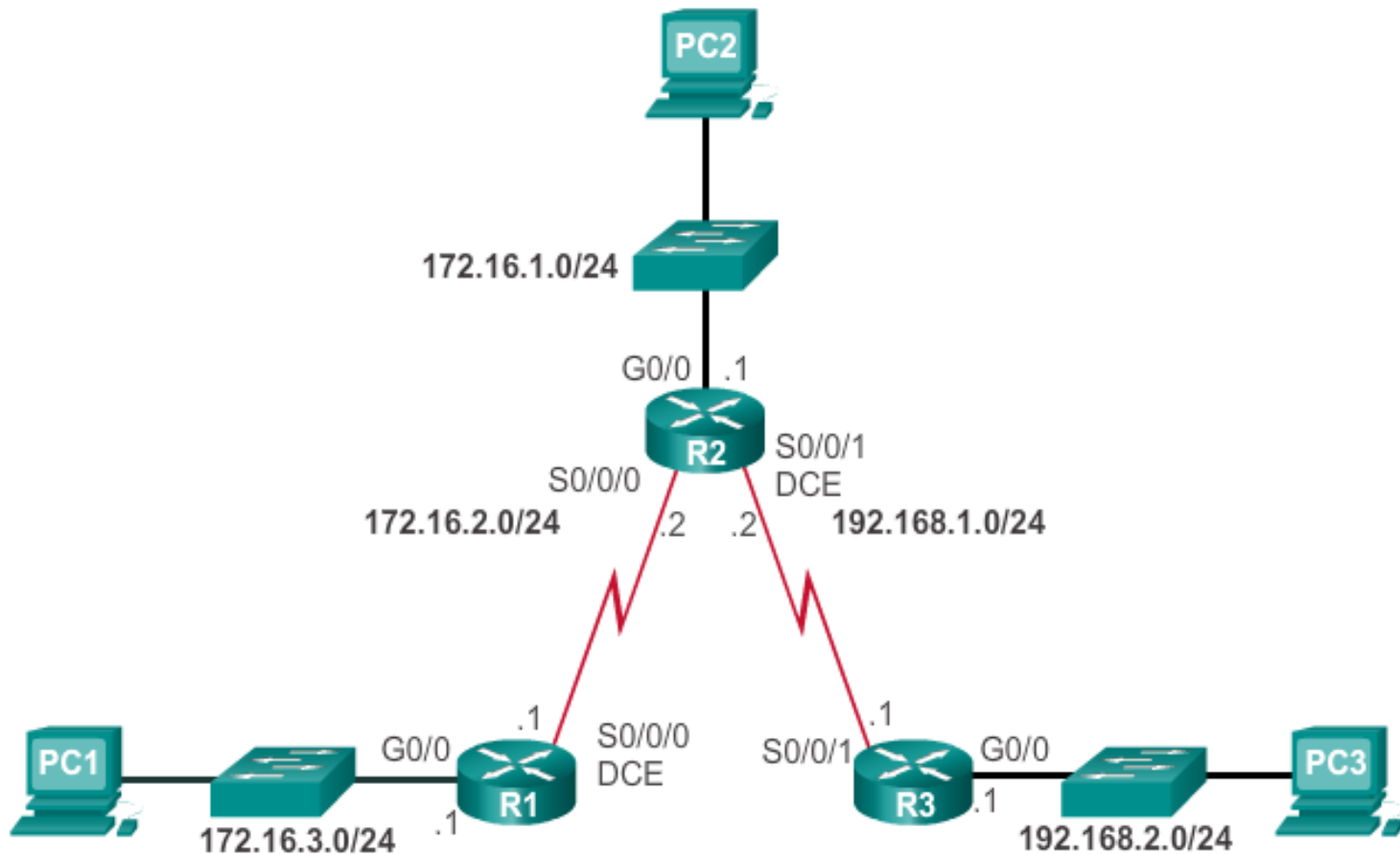



Troubleshoot IPv4 Static and Default Route Configuration

Troubleshoot a Missing Route

Common IOS troubleshooting commands include:

- `ping`
- `traceroute`
- `show ip route`
- `show ip interface brief`
- `show cdp neighbors detail`



Troubleshoot IPv4 Static and Default Route Configuration

Solve a Connectivity Problem

- Finding a missing (or misconfigured) route is a relatively straightforward process, if the right tools are used in a methodical manner.
- Use the **ping** command to confirm the destination can't be reached.
- A **tracert** would also reveal what is the closest router (or hop) that fails to respond as expected. In this case, the router would then send an Internet Control Message Protocol (ICMP) destination unreachable message back to the source.
- The next step is to investigate the routing table. Look for missing or misconfigured routes.
- Incorrect static routes are a common cause of routing problems.



Troubleshoot IPv4 Static and Default Route Configuration

Solve a Connectivity Problem (cont.)

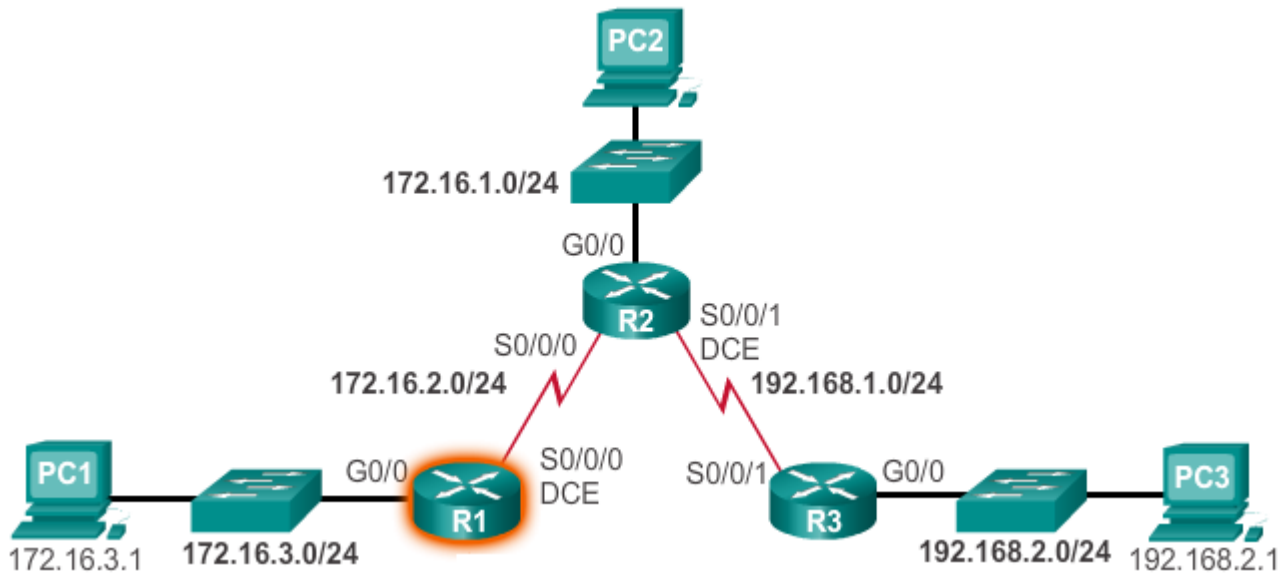

```

R1# ping 192.168.2.1 source g0/0
Type escape sequence to abort.
Sending 5, 100-byte ICMP Echos to 192.168.2.1, timeout is 2 seconds:
Packet sent with a source address of 172.16.3.1
.....
Success rate is 0 percent (0/5)
R1#
    
```



Troubleshoot IPv4 Static and Default Route Configuration

Solve a Connectivity Problem (cont.)

- Refer to the topology shown in the previous slide.
- The user at PC1 reports that he cannot access resources on the R3 LAN.
- This can be confirmed by pinging the LAN interface of R3 using the LAN interface of R1 as the source (see Figure 1). The results show that there is no connectivity between these LANs.
- A traceroute would reveal that R2 is not responding as expected.
- For some reason, R2 forwards the traceroute back to R1. R1 returns it to R2.
- This loop would continue until the time to live (TTL) value decrements to zero, in which case, the router would then send an Internet Control Message Protocol (ICMP) destination unreachable message to R1.



Troubleshoot IPv4 Static and Default Route Configuration

Solve a Connectivity Problem (cont.)

- The next step is to investigate the routing table of R2, because it is the router displaying a strange forwarding pattern.
- The routing table would reveal that the 192.168.2.0/24 network is configured incorrectly.
- A static route to the 192.168.2.0/24 network has been configured using the next-hop address 172.16.2.1.
- Using the configured next-hop address, packets destined for the 192.168.2.0/24 network are sent back to R1.
- Based on the topology, the 192.168.2.0/24 network is connected to R3, not R1. Therefore, the static route to the 192.168.2.0/24 network on R2 must use next-hop 192.168.1.1, not 172.16.2.1.



Chapter 6: Summary

- Static routes can be configured with a next-hop IP address, which is commonly the IP address of the next-hop router.
- When a next-hop IP address is used, the routing table process must resolve this address to an exit interface.
- On point-to-point serial links, it is usually more efficient to configure the static route with an exit interface.
- On multi-access networks, such as Ethernet, both a next-hop IP address and an exit interface can be configured on the static route.
- Static routes have a default administrative distance of "1".



Chapter 6: Summary (cont.)

- A static route is only entered in the routing table if the next-hop IP address can be resolved through an exit interface.
- Whether the static route is configured with a next-hop IP address or exit interface, if the exit interface that is used to forward that packet is not in the routing table, the static route is not included in the routing table.
- In many cases, several static routes can be configured as a single summary route.



Chapter 6: Summary (cont.)

- The ultimate summary route is a default route, configured with a 0.0.0.0 network address and a 0.0.0.0 subnet mask.
- If there is not a more specific match in the routing table, the routing table uses the default route to forward the packet to another router.
- A floating static route can be configured to back up a main link by manipulating its administrative value.

Cisco | Networking Academy[®]

Mind Wide Open[™]