



Chapter 11: Network Address Translation for IPv4



Routing & Switching

Cisco | Networking Academy®
Mind Wide Open™



Chapter 11

11.1 NAT Operation

11.2 Configuring NAT

11.3 Troubleshooting NAT

11.4 Summary



Chapter 11: Objectives

- Describe NAT characteristics.
- Describe the benefits and drawbacks of NAT.
- Configure static NAT using the CLI.
- Configure dynamic NAT using the CLI.
- Configure PAT using the CLI.
- Configure port forwarding using the CLI.
- Configure NAT64.
- Use **show** commands to verify NAT operation.



11.1 NAT Operation



Cisco | Networking Academy®
Mind Wide Open™



NAT Characteristics

IPv4 Private Address Space

- IPv4 address space is not big enough to uniquely address all the devices that must be connected to the Internet.
- Network private addresses are described in RFC 1918 and are designed to be used within an organization or site only.
- Private addresses are not routed by Internet routers while public addresses are.
- Private addresses can alleviate IPv4 scarcity, but because they aren't routed by Internet devices, they first need to be translated.
- NAT is process used to perform such translation.



NAT Characteristics

IPv4 Private Address Space

Private Internet addresses are defined in RFC 1918:

Class	RFC 1918 Internal Address Range	CIDR Prefix
A	10.0.0.0 - 10.255.255.255	10.0.0.0/8
B	172.16.0.0 - 172.31.255.255	172.16.0.0/12
C	192.168.0.0 - 192.168.255.255	192.168.0.0/16

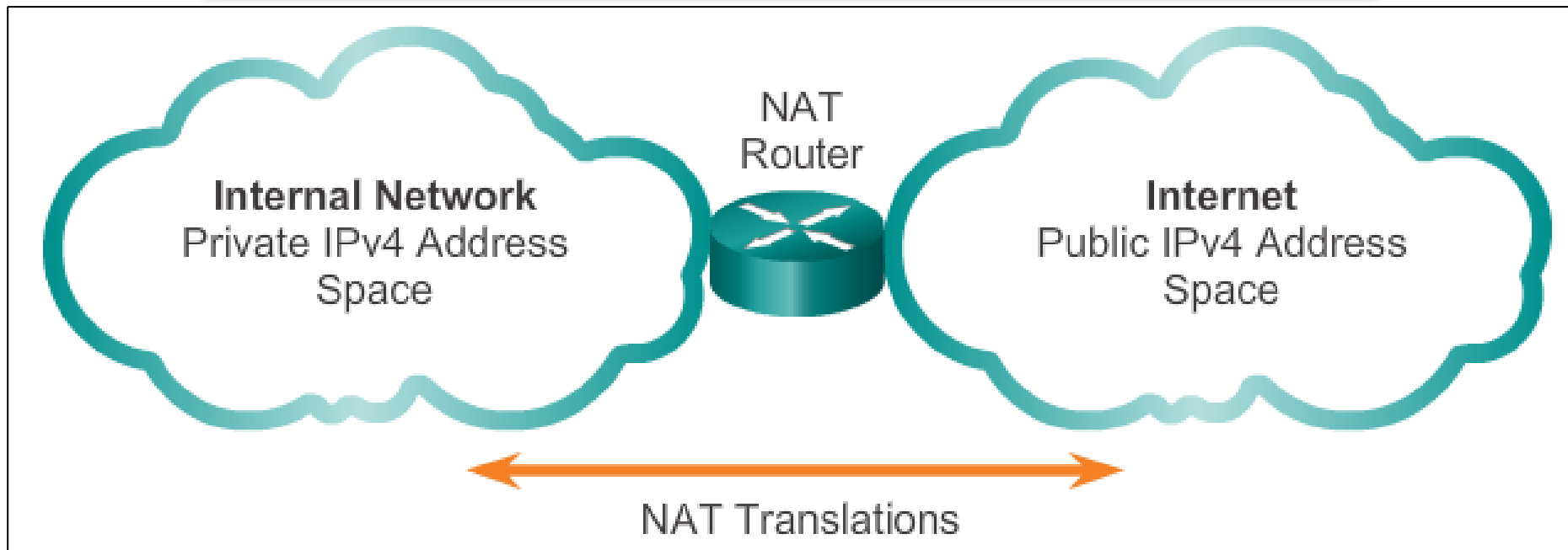



NAT Characteristics

What is NAT?

- NAT is a process used to translate network addresses.
- NAT's primary use is to conserve public IPv4 addresses.
- NAT is usually implemented at border network devices, such as firewalls or routers.
- NAT allows the networks to use private addresses internally, only translating to public addresses when needed.
- Devices within the organization can be assigned private addresses and operate with locally unique addresses.
- When traffic must be sent or received to or from other organizations or the Internet, the border router translates the addresses to a public and globally unique address.



NAT Characteristics

What is NAT? (cont.)

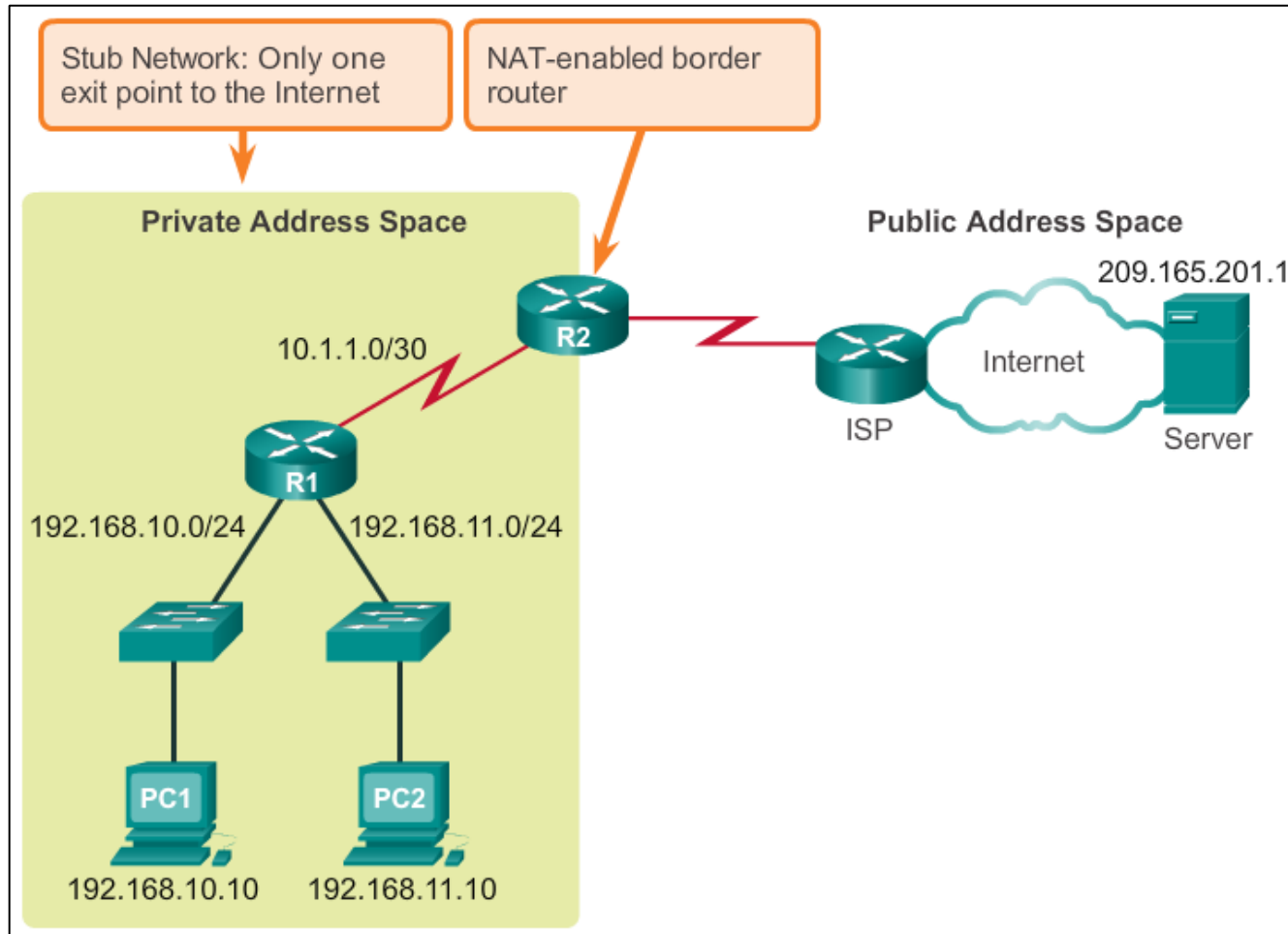



NAT Characteristics

NAT Terminology

- Inside network is the set of devices using private addresses
- Outside network refers to all other networks
- NAT includes four types of addresses:
 - Inside local address
 - Inside global address
 - Outside local address
 - Outside global address

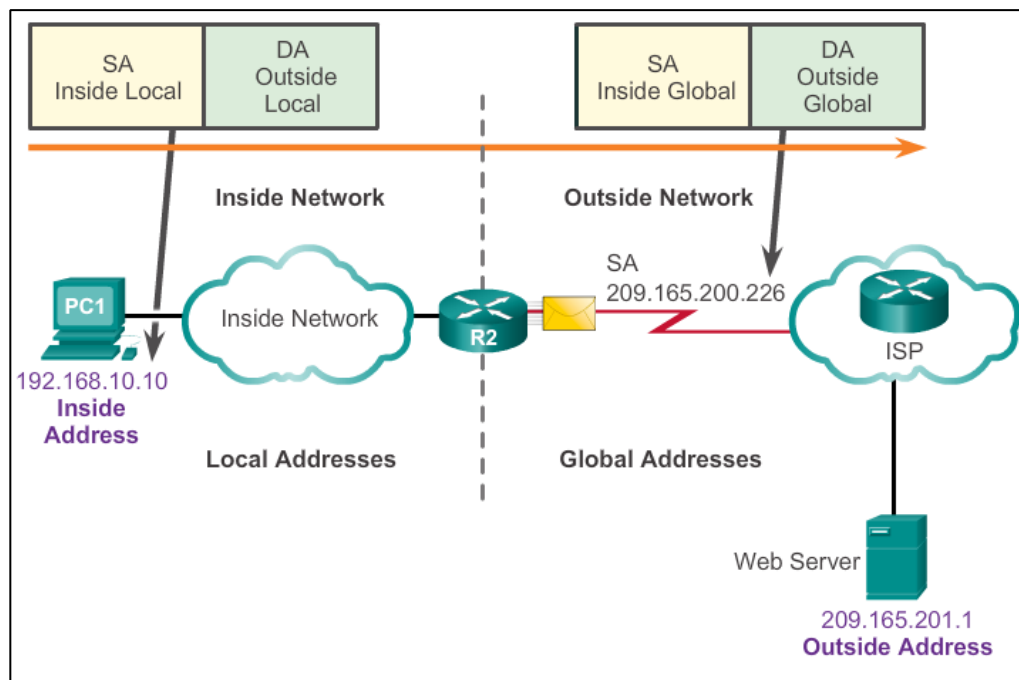



NAT Characteristics

NAT Terminology (cont.)

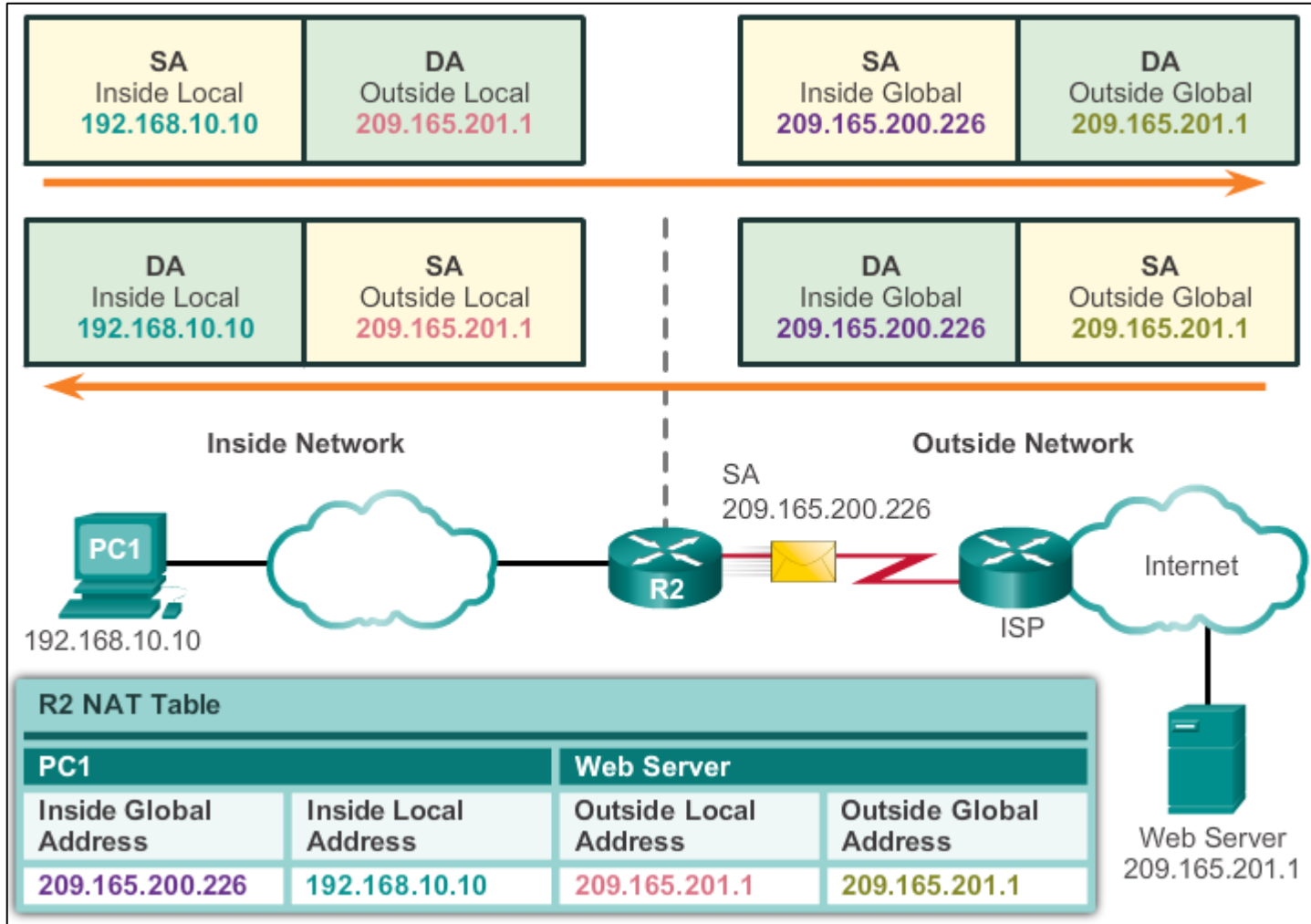



Types of NAT

Static NAT

- Static NAT uses a one-to-one mapping of local and global addresses.
- These mappings are configured by the network administrator and remain constant.
- Static NAT is particularly useful when servers hosted in the inside network must be accessible from the outside network.
- A network administrator can SSH to a server in the inside network by pointing the SSH client to the proper inside global address.



Types of NAT

Static NAT (cont.)

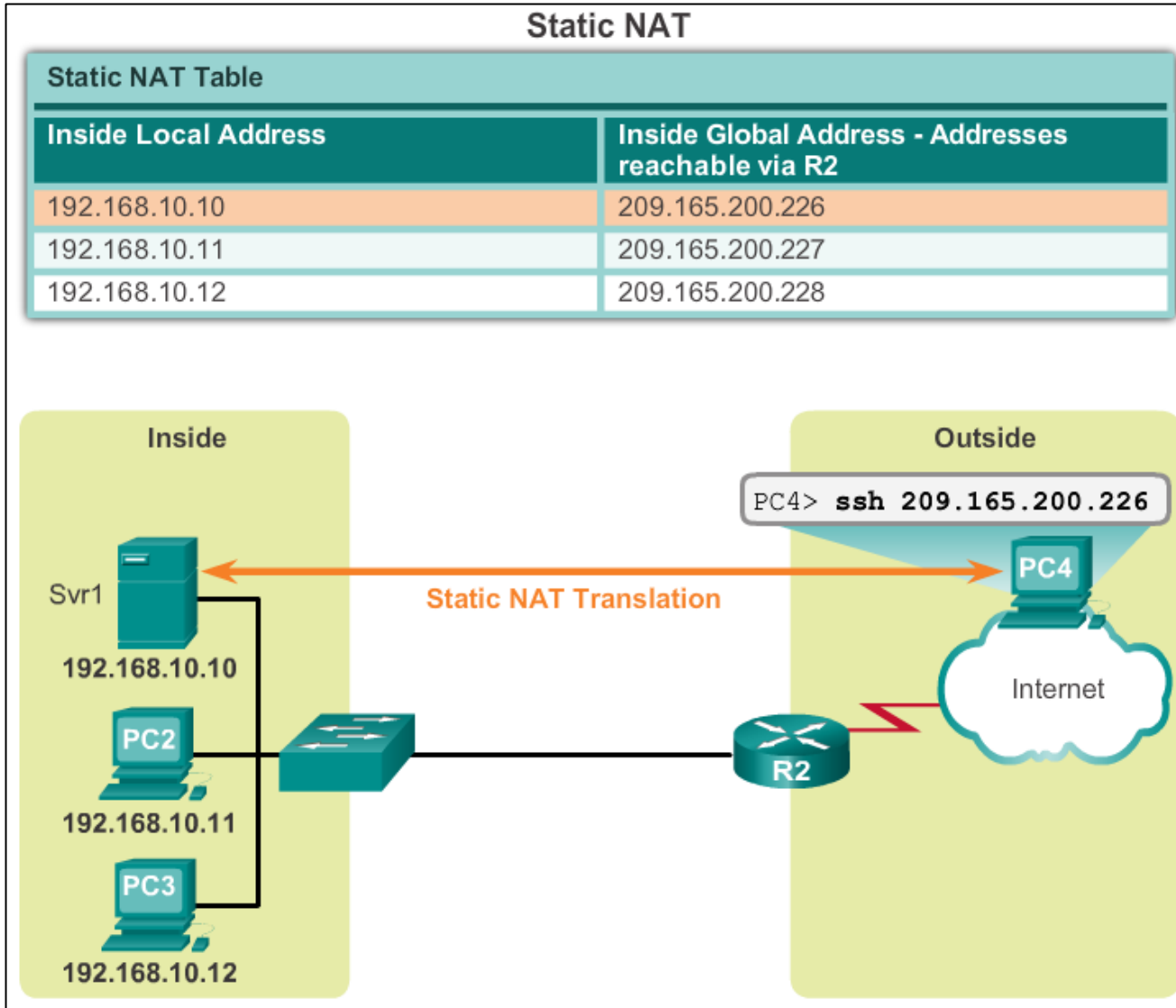



Types of NAT

Dynamic NAT

- Dynamic NAT uses a pool of public addresses and assigns them on a first-come, first-served basis.
- When an inside device requests access to an outside network, dynamic NAT assigns an available public IPv4 address from the pool.
- Dynamic NAT requires that enough public addresses are available to satisfy the total number of simultaneous user sessions.



Types of NAT

Dynamic NAT (cont.)

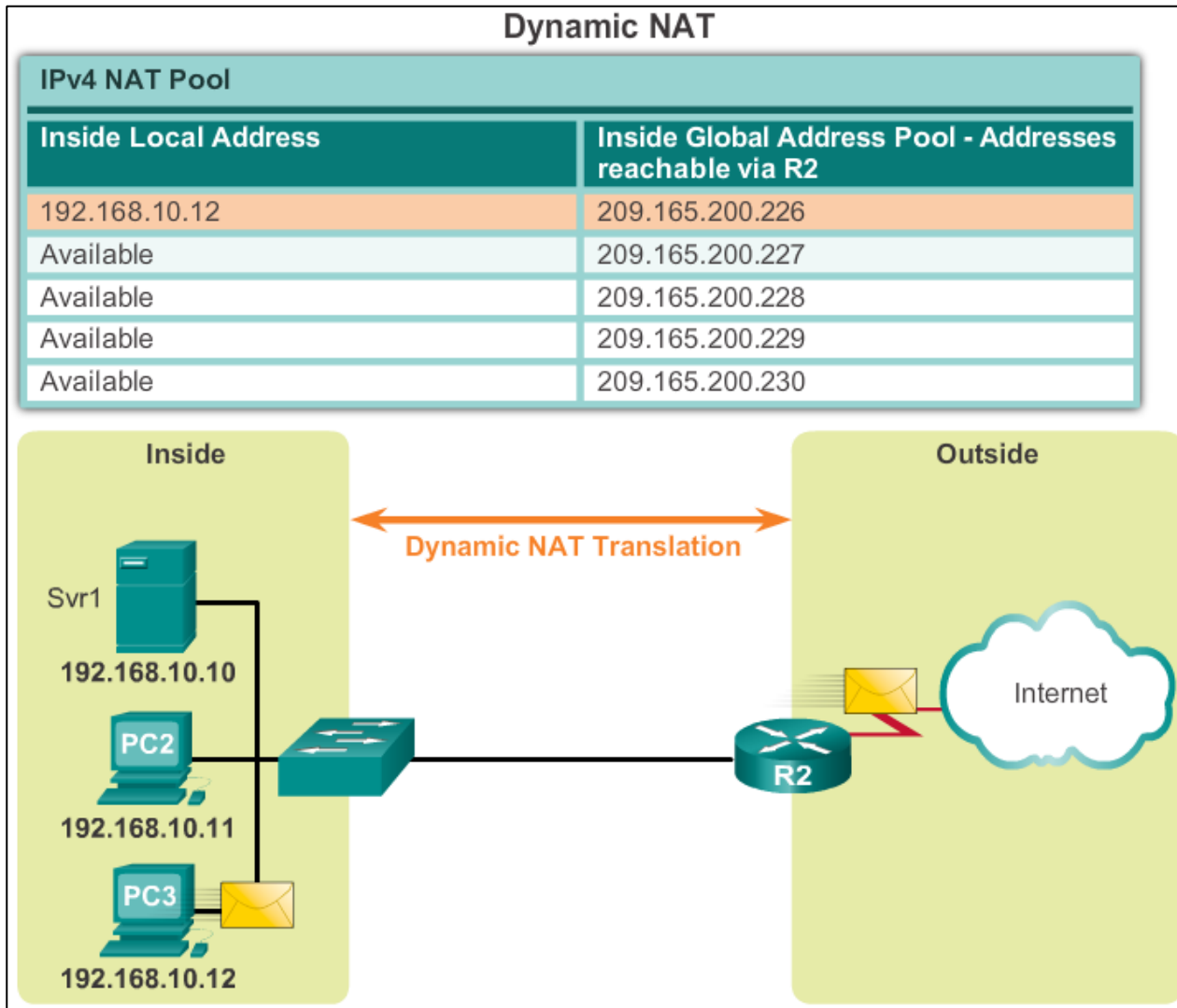



Types of NAT

Port Address Translation

- Port Address Translation (PAT) maps multiple private IPv4 addresses to a single public IPv4 address or a few addresses.
- PAT uses the pair source port and source IP address to keep track of what traffic belongs to what internal client.
- PAT is also known as NAT overload.
- By also using the port number, PAT forwards the response packets to the correct internal device.
- The PAT process also validates that the incoming packets were requested, thus adding a degree of security to the session.



Types of NAT

Comparing NAT and PAT

- NAT translates IPv4 addresses on a 1:1 basis between private IPv4 addresses and public IPv4 addresses.
- PAT modifies both the address and the port number.
- NAT forwards incoming packets to their inside destination by referring to the incoming source IPv4 address provided by the host on the public network.
- With PAT, there is generally only one or a very few publicly exposed IPv4 addresses.
- PAT is able to translate protocols that do not use port numbers, such as ICMP; each one of these protocols is supported differently by PAT.



Benefits of NAT

Benefits of NAT

- Conserves the legally registered addressing scheme
- Increases the flexibility of connections to the public network
- Provides consistency for internal network addressing schemes
- Provides network security



Benefits of NAT

Disadvantages of NAT

- Performance is degraded
- End-to-end functionality is degraded
- End-to-end IP traceability is lost
- Tunneling is more complicated
- Initiating TCP connections can be disrupted



11.2 Configuring NAT



Cisco | Networking Academy®
Mind Wide Open™



Configuring Static NAT

Configuring Static NAT

There are two basic tasks to perform when configuring static NAT translations:

- Create the mapping between the inside local and outside local addresses.
- Define which interfaces belong to the inside network and which belong to the outside network.



Configuring Static NAT

Configuring Static NAT

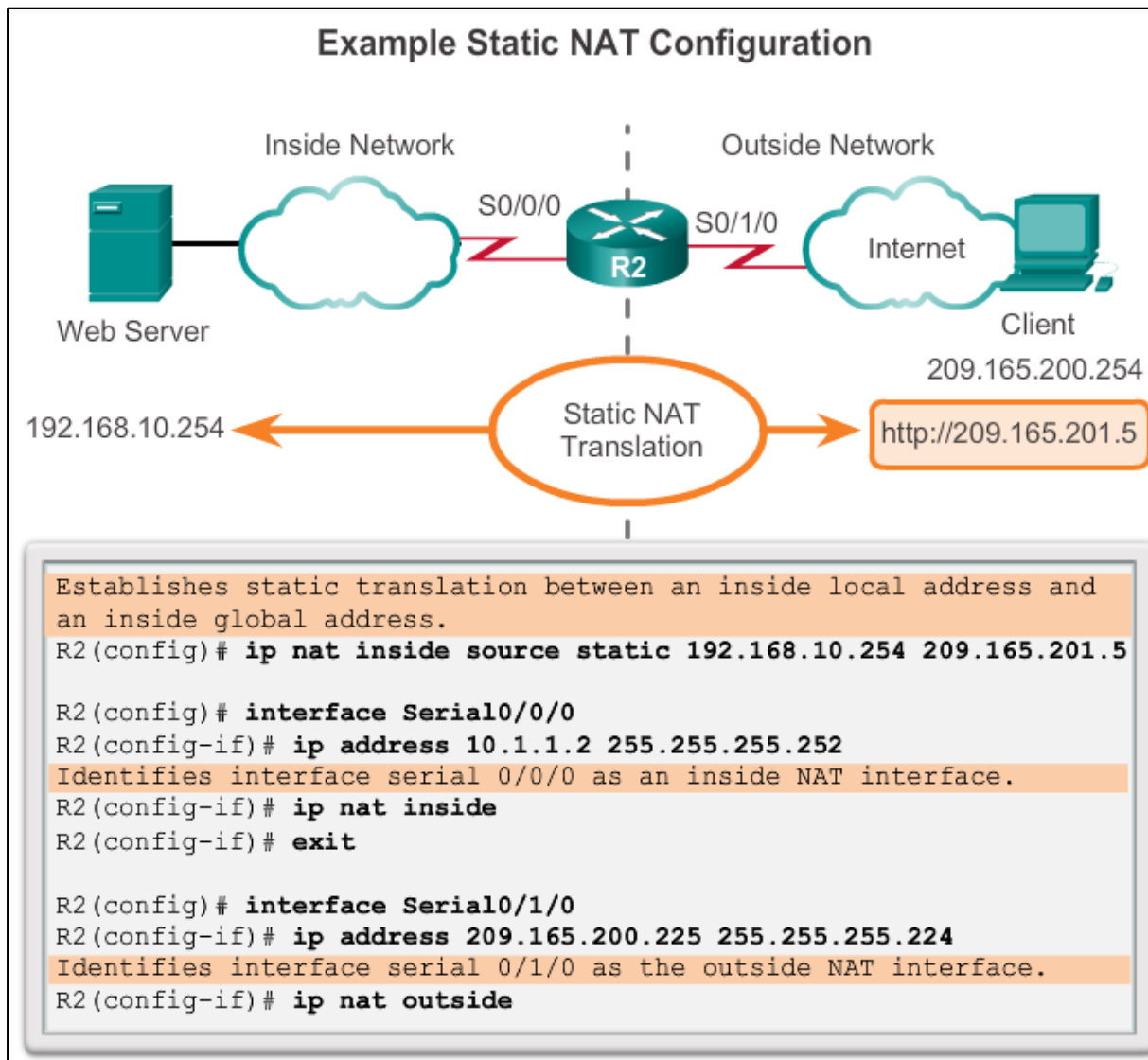



Configuring Static NAT

Analyzing Static NAT

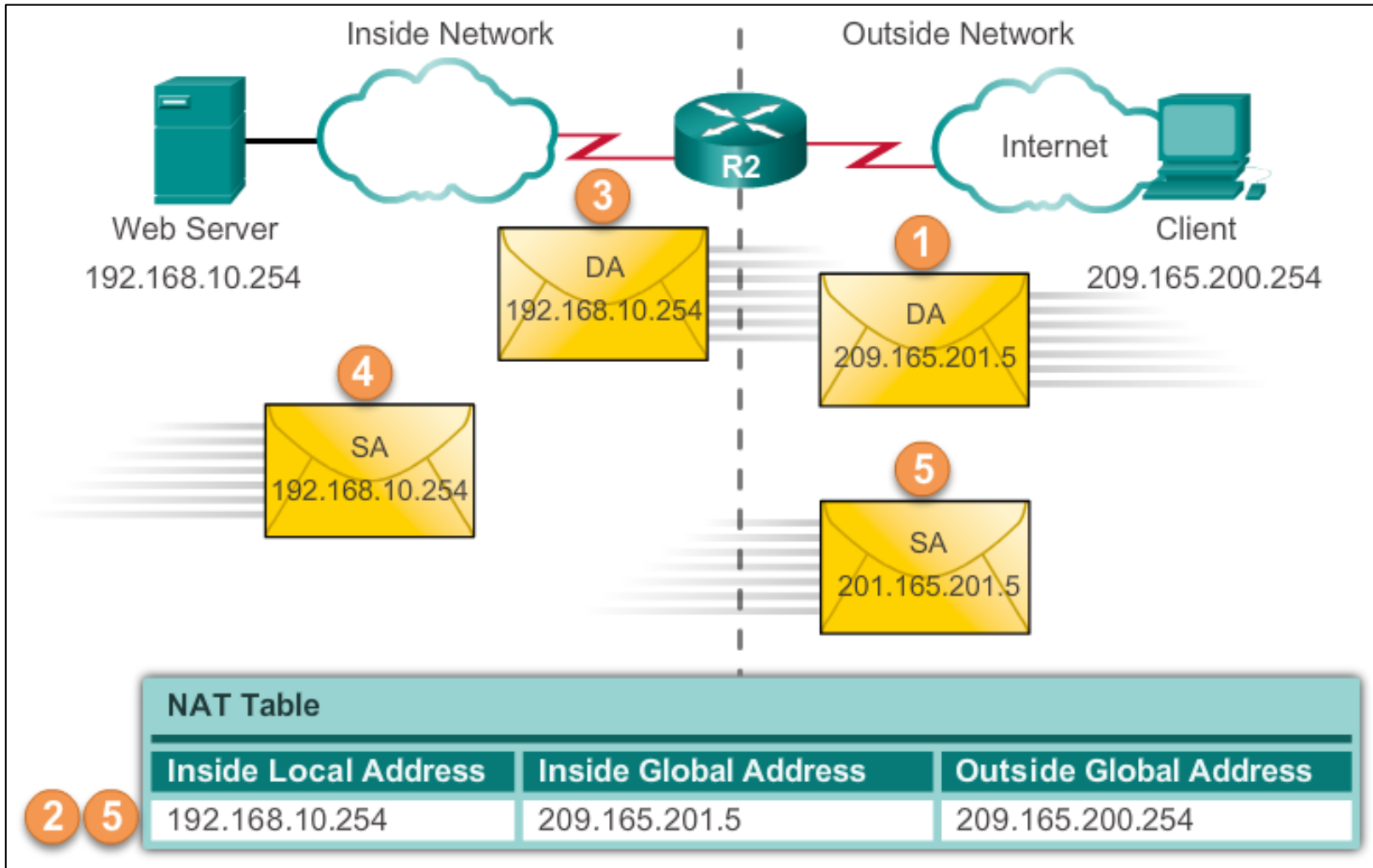



Configuring Static NAT

Verifying Static NAT

The static translation is always present in the NAT table.

```
R2# show ip nat translations
Pro Inside global   Inside local   Outside local   Outside global
--- 209.165.201.5    192.168.10.254 ---              ---
R2#
```

The static translation during an active session.

```
R2# show ip nat translations
Pro Inside global   Inside local   Outside local   Outside global
--- 209.165.201.5    192.168.10.254 209.165.200.254 209.165.200.254
R2#
```



Configuring Static NAT

Verifying Static NAT (cont.)

```
R2# clear ip nat statistics
```

```
R2# show ip nat statistics
```

```
Total active translations: 1 (1 static, 0 dynamic; 0 extended)
Peak translations: 0
Outside interfaces:
  Serial0/0/1
Inside interfaces:
  Serial0/0/0
Hits: 0 Misses: 0
<output omitted>
```

Client PC establishes a session with the web server

```
R2# show ip nat statistics
```

```
Total active translations: 1 (1 static, 0 dynamic; 0 extended)
Peak translations: 2, occurred 00:00:14 ago
Outside interfaces:
  Serial0/1/0
Inside interfaces:
  Serial0/0/0
Hits: 5 Misses: 0
<output omitted>
```



Configuring Dynamic NAT

Dynamic NAT Operation

- The pool of public IPv4 addresses (inside global address pool) is available to any device on the inside network on a first-come, first-served basis.
- With dynamic NAT, a single inside address is translated to a single outside address.
- The pool must be large enough to accommodate all inside devices.
- A device is unable to communicate to any external networks if no addresses are available in the pool.



Configuring Dynamic NAT

Configuring Dynamic NAT

Dynamic NAT Configuration Steps	
Step 1	<p>Define a pool of global addresses to be used for translation.</p> <pre>ip nat pool name start-ip end-ip {netmask netmask prefix-length prefix-length}</pre>
Step 2	<p>Configure a standard access list permitting the addresses that should be translated.</p> <pre>access-list access-list-number permit source[source-wildcard]</pre>
Step 3	<p>Establish dynamic source translation, specifying the access list and pool defined in prior steps.</p> <pre>ip nat inside source list access-list-number pool name</pre>
Step 4	<p>Identify the inside interface.</p> <pre>interface type number ip nat inside</pre>
Step 5	<p>Identify the outside interface.</p> <pre>interface type number ip nat outside</pre>



Configuring Dynamic NAT

Analyzing Dynamic NAT

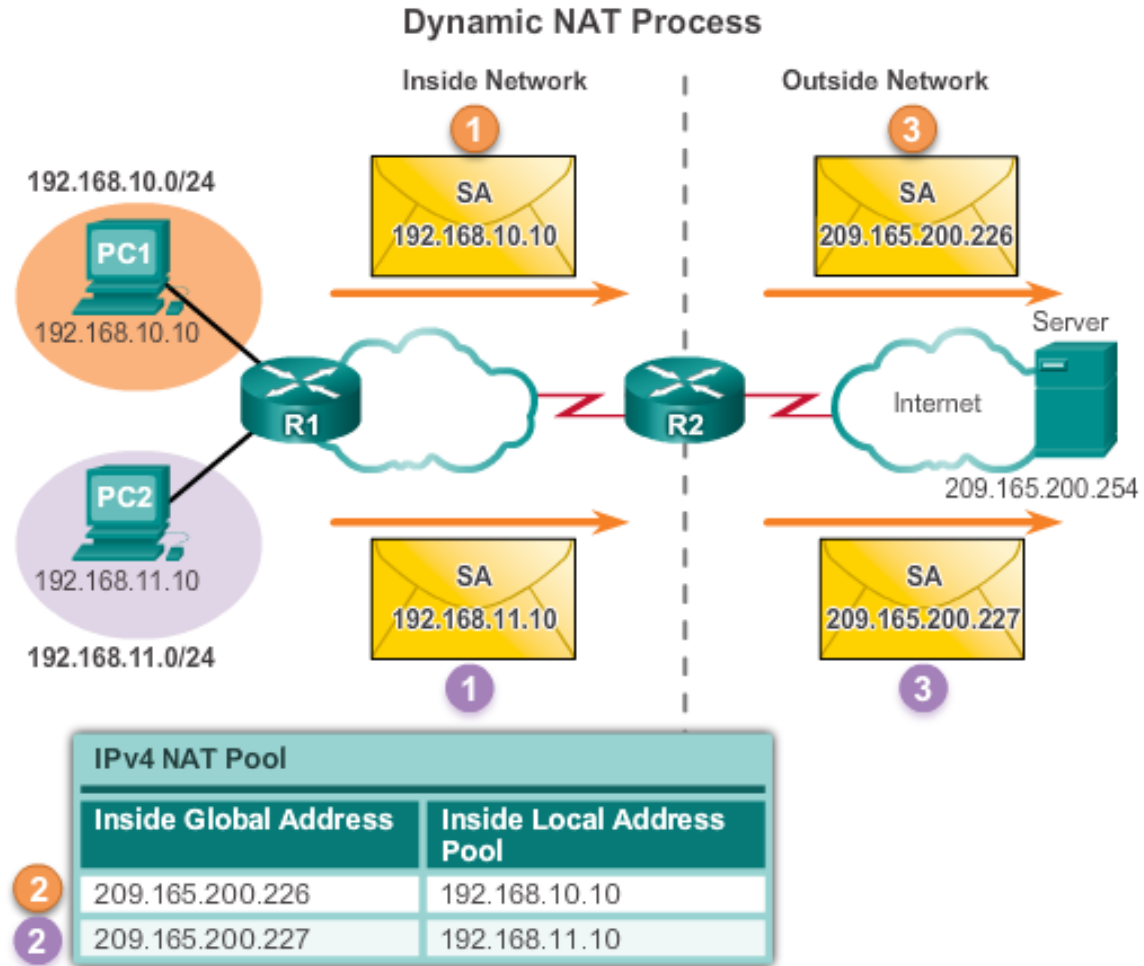



Configuring Dynamic NAT

Analyzing Dynamic NAT

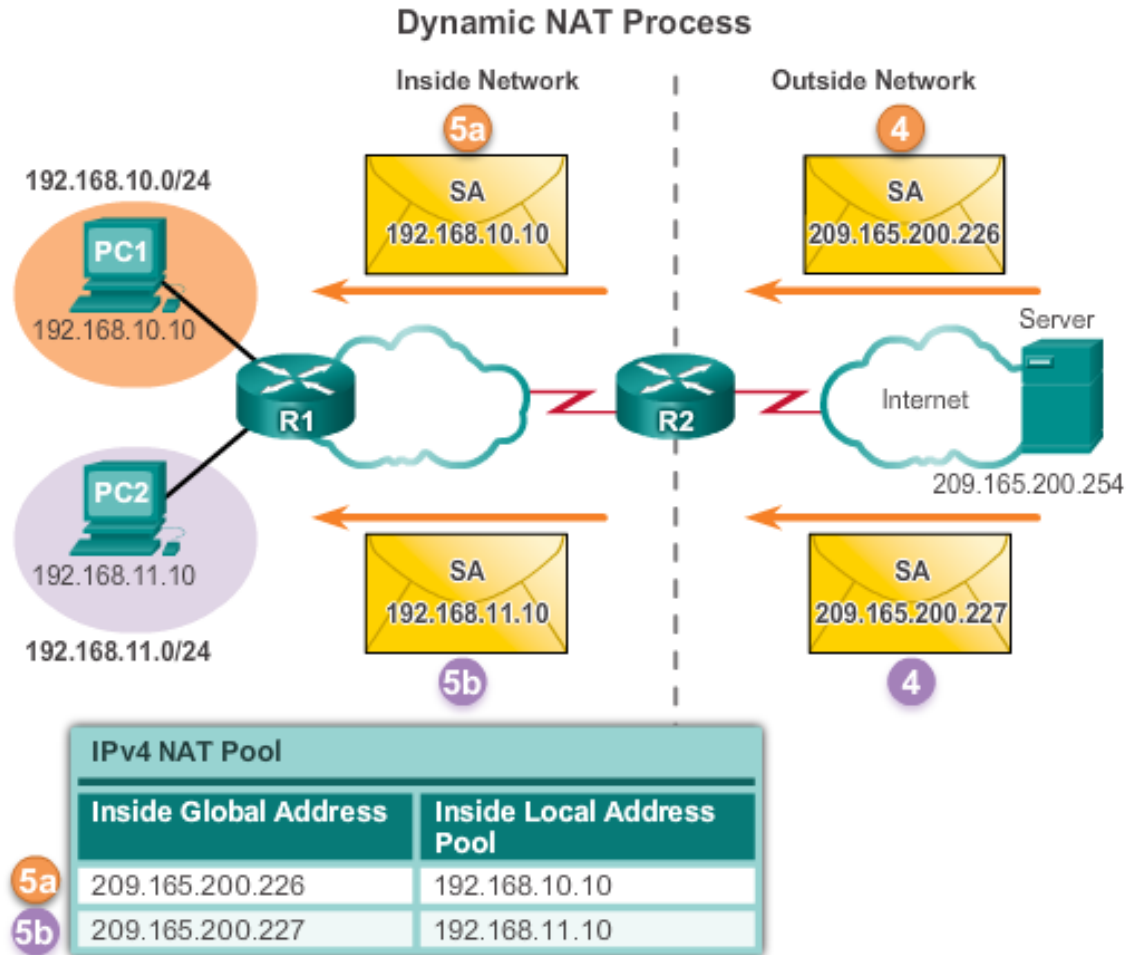



Configuring Dynamic NAT

Verifying Dynamic NAT

Verifying Dynamic NAT with show ip nat translations

```

R2# show ip nat translations
Pro Inside global      Inside local  Outside local  Outside global
--- 209.165.200.226    192.168.10.10 ---             ---
--- 209.165.200.227    192.168.11.10 ---             ---
R2#
R2# show ip nat translations verbose
Pro Inside global      Inside local  Outside local  Outside global
--- 209.165.200.226    192.168.10.10 ---             ---
      create 00:17:25, use 00:01:54 timeout:86400000, left
23:58:05, Map-Id(In): 1,
      flags:
none, use_count: 0, entry-id: 32, lc_entries: 0
--- 209.165.200.227    192.168.11.10 ---             ---
      create 00:17:22, use 00:01:51 timeout:86400000, left
23:58:08, Map-Id(In): 1,
      flags:
none, use_count: 0, entry-id: 34, lc_entries: 0
R2#

```



Configuring Dynamic NAT

Verifying Dynamic NAT

Verifying Dynamic NAT with show ip nat statistics

```

R2# clear ip nat statistics

PC1 and PC2 establish sessions with the server

R2# show ip nat statistics
Total active translations: 2 (0 static, 2 dynamic; 0 extended)
Peak translations: 6, occurred 00:27:07 ago
Outside interfaces:
  Serial0/0/1
Inside interfaces:
  Serial0/1/0
Hits: 24 Misses: 0
CEF Translated packets: 24, CEF Punted packets: 0
Expired translations: 4
Dynamic mappings:
-- Inside Source
[Id: 1] access-list 1 pool NAT-POOL1 refcount 2
  pool NAT-POOL1: netmask 255.255.255.224
  start 209.165.200.226 end 209.165.200.240
  type generic, total addresses 15, allocated 2 (13%), misses 0

Total doors: 0
Appl doors: 0
Normal doors: 0
Queued Packets: 0
R2#

```



Configuring PAT

Configuring PAT: Address Pool

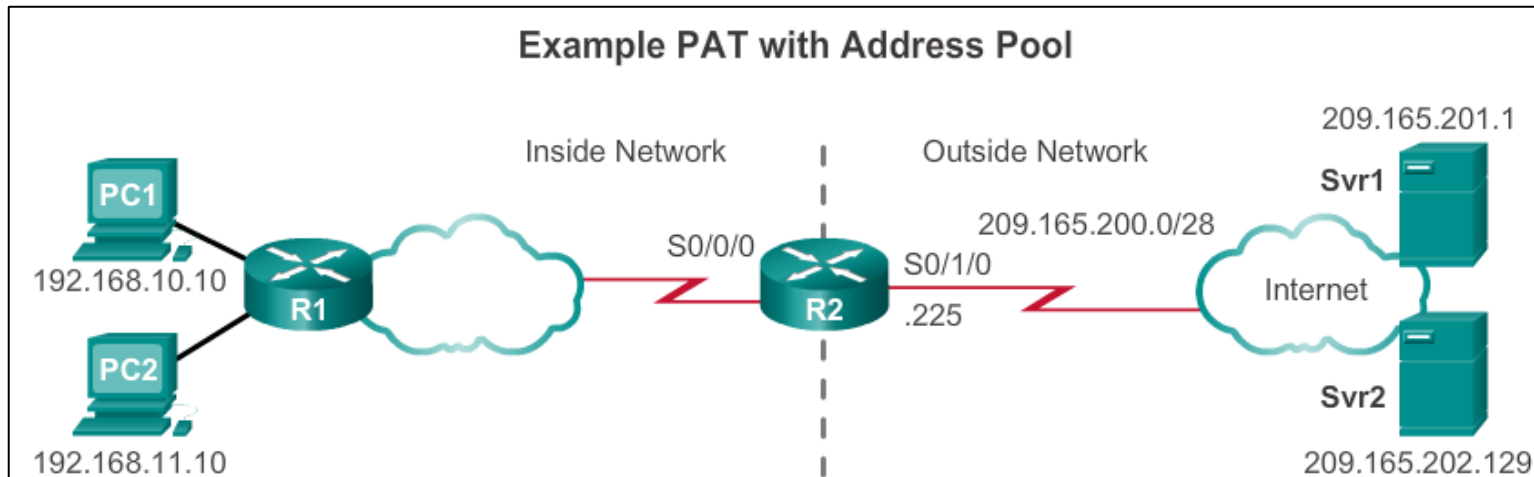

Define a pool of public IPv4 addresses under the pool name NAT-POOL2.

```
R2(config)# ip nat pool NAT-POOL2 209.165.200.226
209.165.200.240 netmask 255.255.255.224
```

Define which addresses are eligible to be translated.

```
R2(config)# access-list 1 permit 192.168.0.0 0.0.255.255
```

Bind NAT-POOL2 with ACL 1.

```
R2(config)# ip nat inside source list 1 pool NAT-POOL2
overload
```

Identify interface serial 0/0/0 as an inside NAT interface.

```
R2(config)# interface Serial0/0/0
```

```
R2(config-if)# ip nat inside
```

Identify interface serial 0/1/0 as the outside NAT interface.

```
R2(config)# interface Serial0/1/0
```

```
R2(config-if)# ip nat outside
```



Configuring PAT

Configuring PAT: Single Address

Step 1	<p>Define a standard access list permitting the addresses that should be translated.</p> <pre>access-list access-list-number permit source [source-wildcard]</pre>
Step 2	<p>Establish dynamic source translation, specifying the ACL, exit interface and overload options.</p> <pre>ip nat inside source list access-list-number interface type number overload</pre>
Step 3	<p>Identify the inside interface.</p> <pre>interface type number ip nat inside</pre>
Step 4	<p>Identify the outside interface.</p> <pre>interface type number ip nat outside</pre>



Configuring PAT

Analyzing PAT

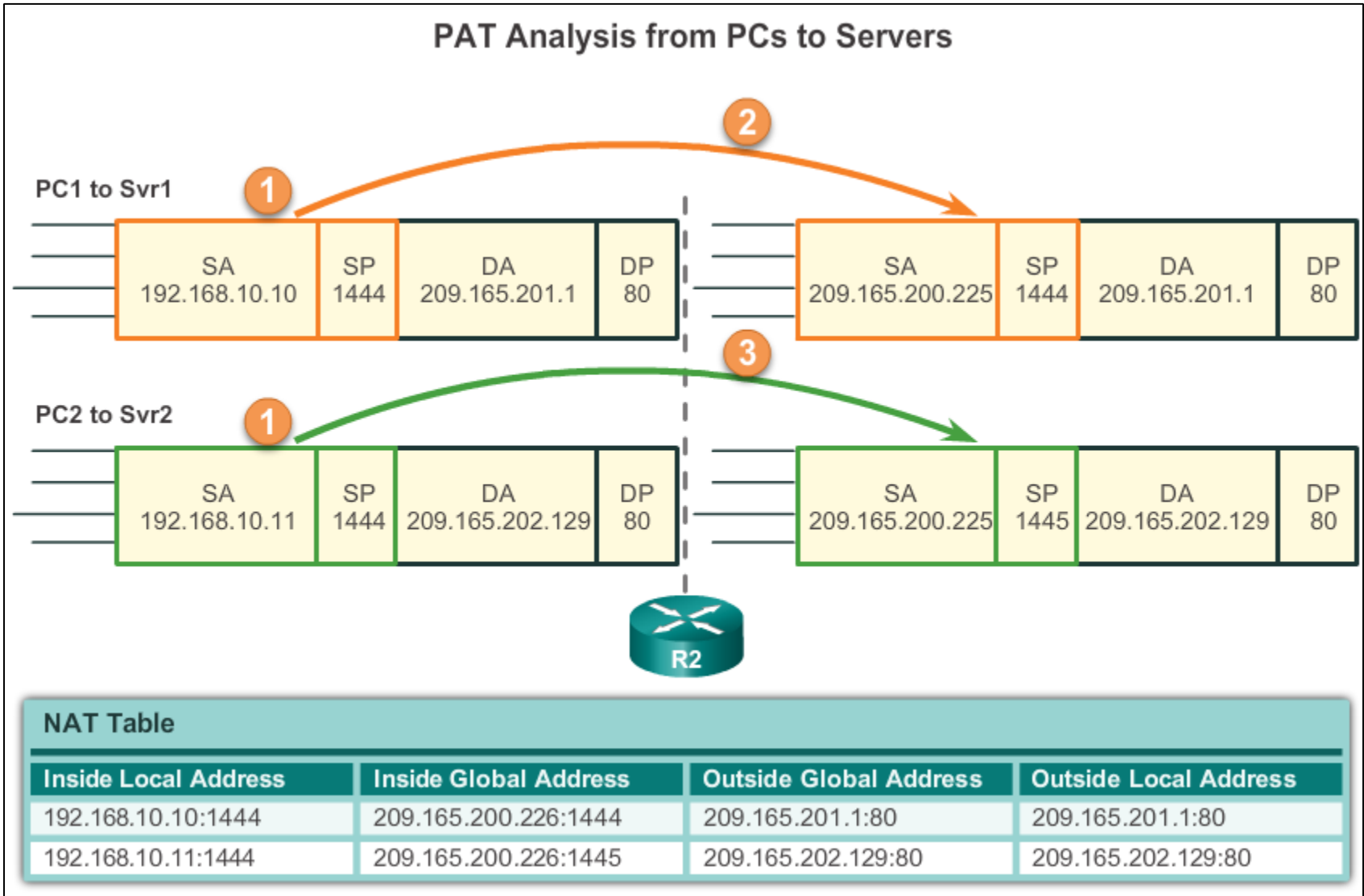



Configuring PAT

Analyzing PAT

PAT Analysis from Servers to PCs

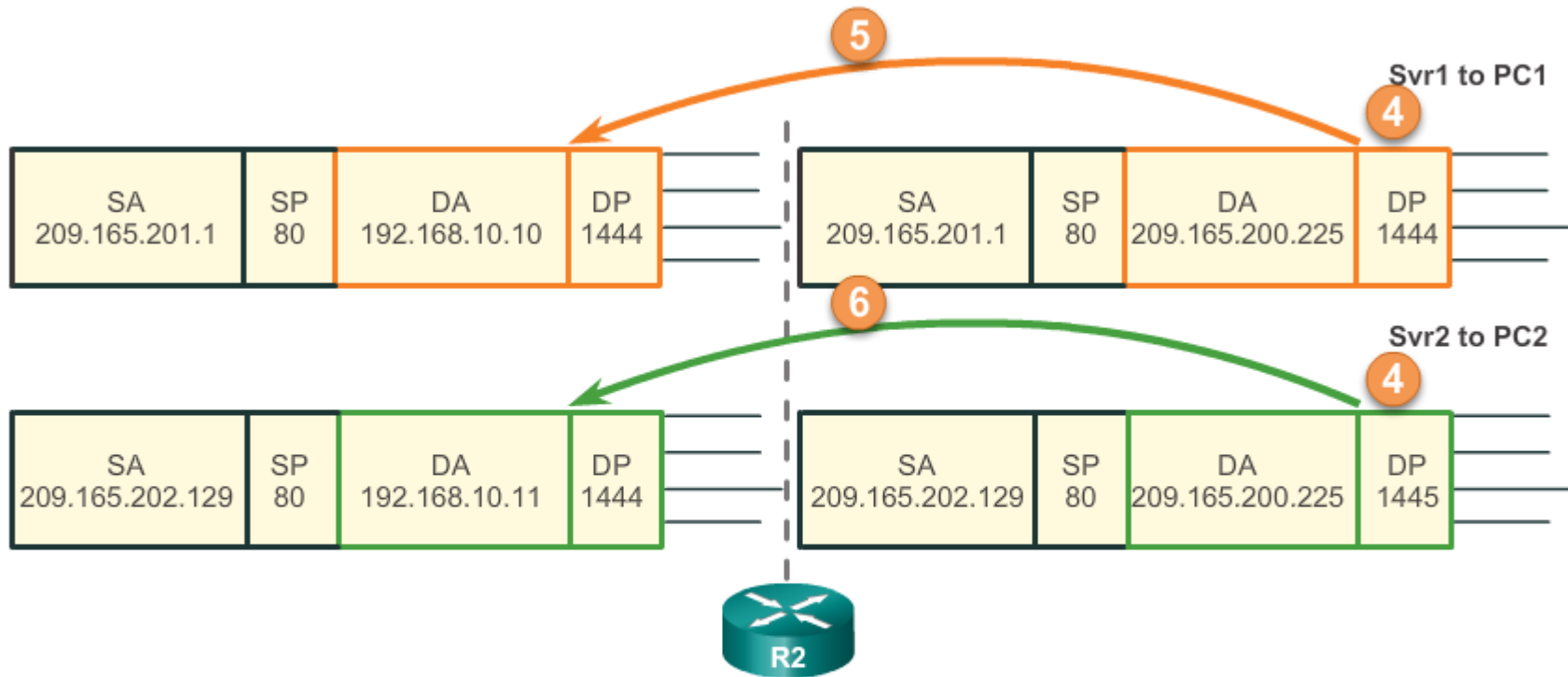

NAT Table

Inside Local Address	Inside Global Address	Outside Global Address	Outside Local Address
192.168.10.10:1444	209.165.200.226:1444	209.165.201.1:80	209.165.201.1:80
192.168.10.11:1444	209.165.200.226:1445	209.165.202.129:80	209.165.202.129:80



Configuring PAT

Verifying PAT Translations

Verifying PAT Translations

```

R2# show ip nat translations
Pro Inside global      Inside local      Outside local      Outside global
tcp 209.165.200.226:51839 192.168.10.10:51839 209.165.201.1:80 209.165.201.1:80
tcp 209.165.200.226:42558 192.168.11.10:42558 209.165.202.129:80 209.165.202.129:80
R2#
  
```



Port Forwarding

- Port forwarding is the act of forwarding a network port from one network node to another.
- A packet sent to the public IP address and port of a router can be forwarded to a private IP address and port in inside network.
- Port forwarding is helpful in situations where servers have private addresses, not reachable from the outside networks.

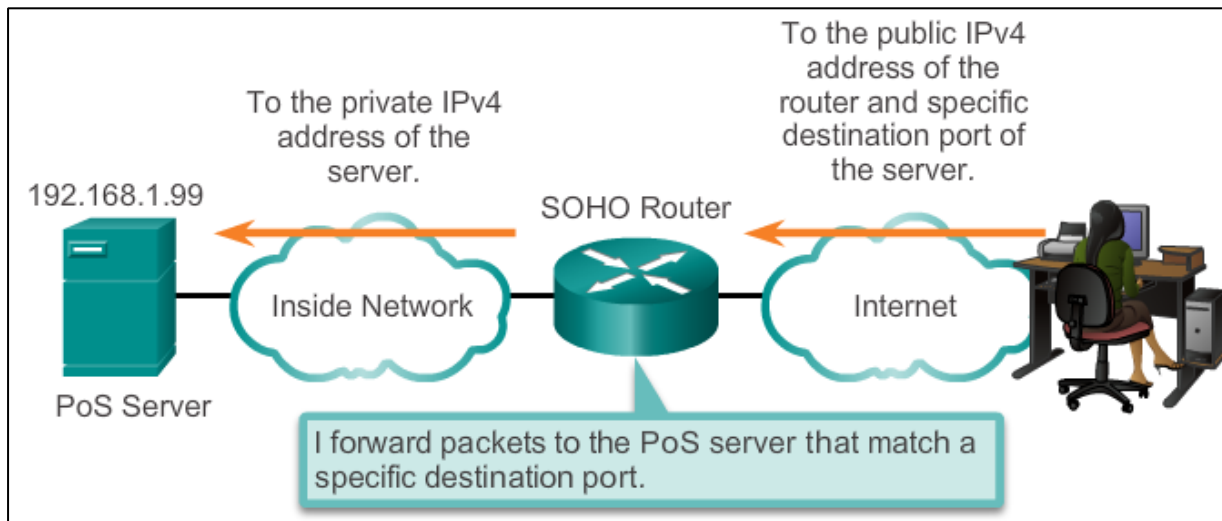



Port Forwarding SOHO Example

Port Forwarding on a SOHO Router

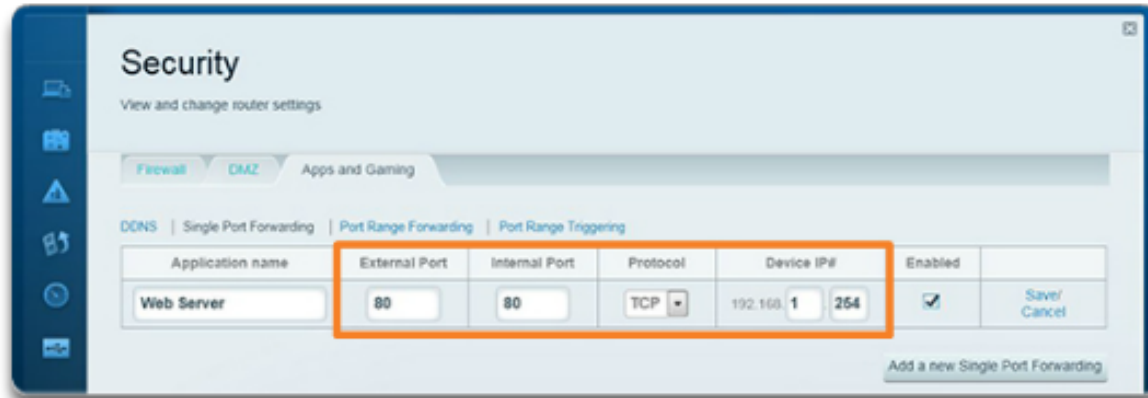
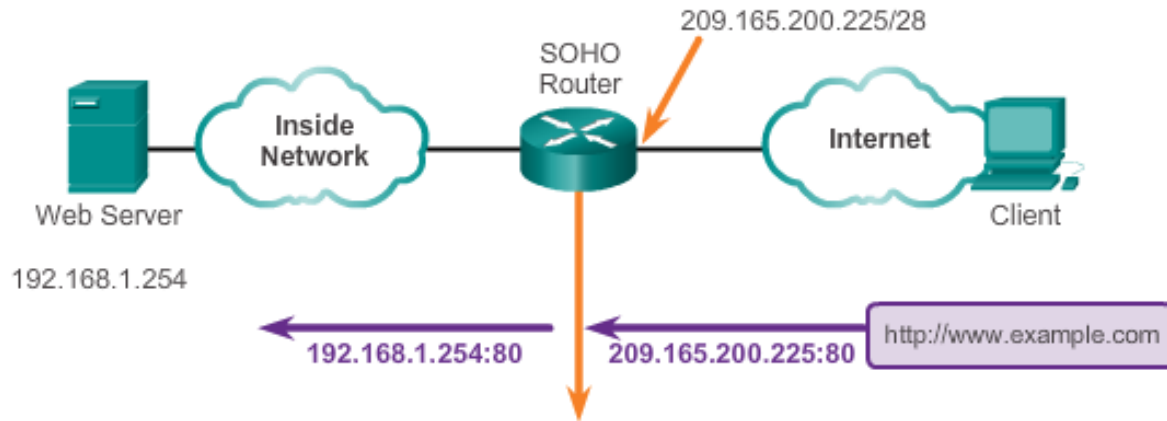



Port Forwarding

Configuring Port Forwarding with IOS

In IOS, Port forwarding is essentially a static NAT translation with a specified TCP or UDP port number.

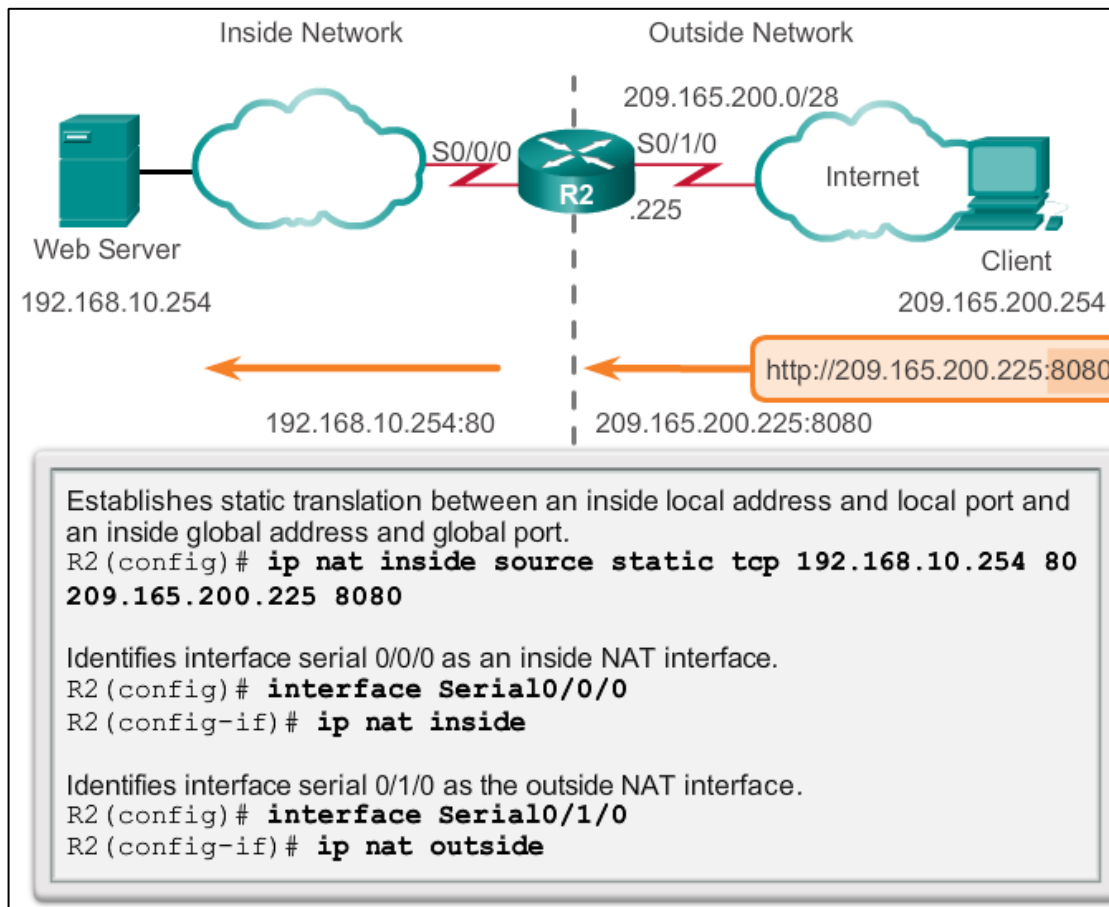



Configuring NAT and IPv6

NAT for IPv6?

- NAT is a workaround for IPv4 address scarcity.
- IPv6 with a 128-bit address provides 340 undecillion addresses.
- Address space is not an issue for IPv6.
- IPv6 makes IPv4 public-private NAT unnecessary by design; however, IPv6 does implement a form of private addresses, and it is implemented differently than they are for IPv4.



Configuring NAT and IPv6

IPv6 Unique Local Addresses

- IPv6 unique local addresses (ULAs) are designed to allow IPv6 communications within a local site.
- ULAs are not meant to provide additional IPv6 address space.
- ULAs have the prefix FC00::/7, which results in a first hextet range of FC00 to FDFF.
- ULAs are also known as local IPv6 addresses (not to be confused with IPv6 link-local addresses).

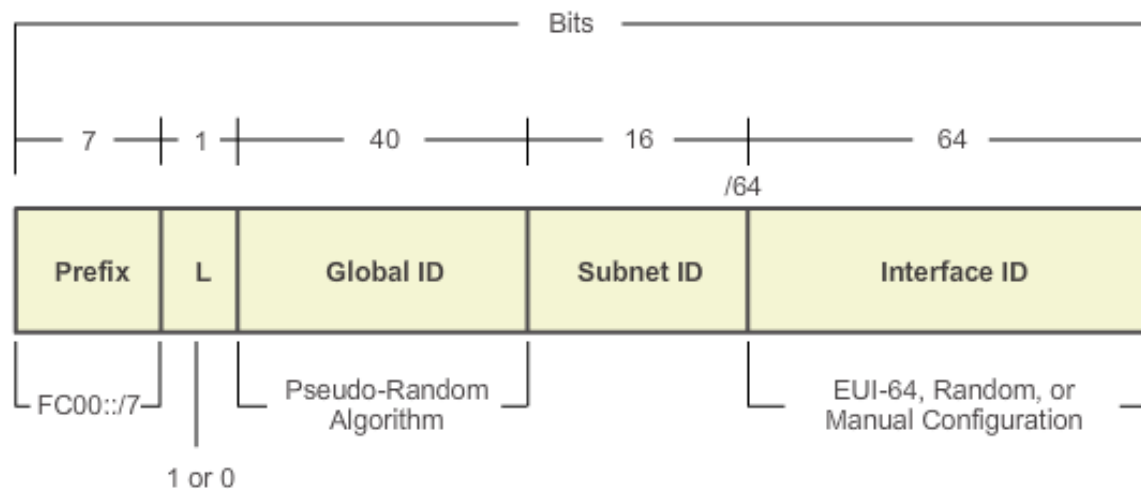



Configuring NAT and IPv6

NAT for IPv6

- IPv6 also uses NAT, but in a much different context.
- In IPv6, NAT is used to provide transparent communication between IPv6 and IPv4.
- NAT64 is not intended to be a permanent solution; it is meant to be a transition mechanism.
- Network Address Translation-Protocol Translation (NAT-PT) was another NAT-based transition mechanism for IPv6, but is now deprecated by IETF.
- NAT64 is now recommended.



Configuring NAT and IPv6

NAT for IPv6

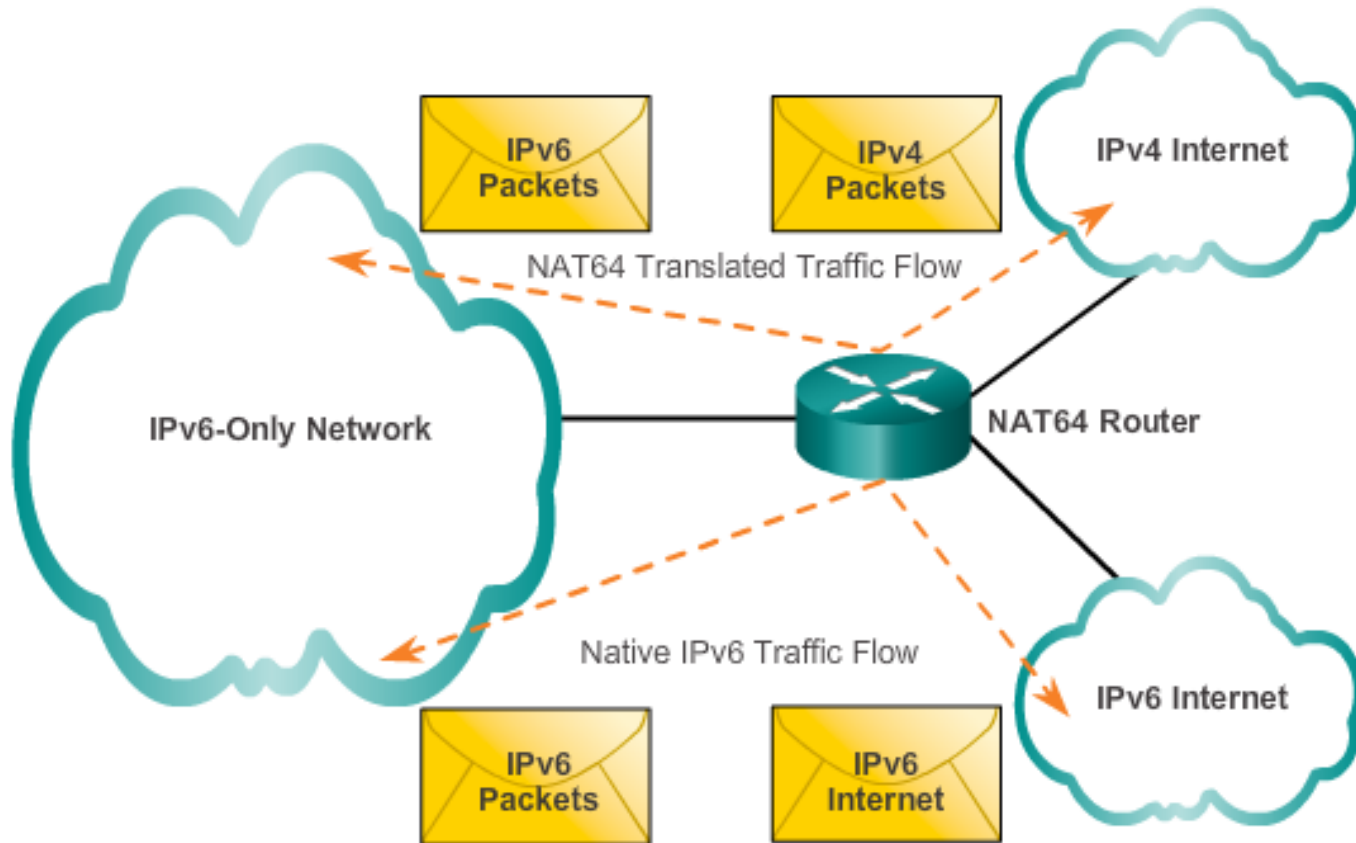



11.3 Troubleshooting NAT



Cisco | Networking Academy®
Mind Wide Open™



Configuring NAT and IPv6

Troubleshooting NAT: show commands

```

R2# clear ip nat statistics
R2# clear ip nat translation *
R2#
Host 192.168.10.10 telnets to server at 209.165.201.1
R2# show ip nat statistics
Total active translations: 1 (0 static, 1 dynamic; 1 extended)
Peak translations: 1, occurred 00:00:09 ago
Outside interfaces:
  Serial0/0/1
Inside interfaces:
  Serial0/0/0
Hits: 31 Misses: 0
CEF Translated packets: 31, CEF Punted packets: 0
Expired translations: 0
Dynamic mappings:
-- Inside Source
[Id: 5] access-list 1 pool NAT-POOL2 refcount 1
  pool NAT-POOL2: netmask 255.255.255.224
  start 209.165.200.226 end 209.165.200.240
  type generic, total addresses 15, allocated 1 (6%), misses 0
<output omitted>
R2# show ip nat translations
Pro Inside global      Inside local      Outside local      Out.
tcp 209.165.200.226:19005 192.168.10.10:19005 209.165.201.1:23 209
R2#

```



Configuring NAT and IPv6

Troubleshooting NAT: debug command

```

R2# debug ip nat
IP NAT debugging is on
R2#
*Feb 15 20:01:311.670: NAT*: s=192.168.10.10->209.165.200.226, d=209.165.201.1 [2817]
*Feb 15 20:01:311.682: NAT*: s=209.165.201.1, d=209.165.200.226->192.168.10.10 [4180]
*Feb 15 20:01:311.698: NAT*: s=192.168.10.10->209.165.200.226, d=209.165.201.1 [2818]
*Feb 15 20:01:311.702: NAT*: s=192.168.10.10->209.165.200.226, d=209.165.201.1 [2819]
*Feb 15 20:01:311.710: NAT*: s=192.168.10.10->209.165.200.226, d=209.165.201.1 [2820]
*Feb 15 20:01:311.710: NAT*: s=209.165.201.1, d=209.165.200.226->192.168.10.10 [4181]
*Feb 15 20:01:311.722: NAT*: s=209.165.201.1, d=209.165.200.226->192.168.10.10 [4182]
*Feb 15 20:01:311.726: NAT*: s=192.168.10.10->209.165.200.226, d=209.165.201.1 [2821]
*Feb 15 20:01:311.730: NAT*: s=209.165.201.1, d=209.165.200.226->192.168.10.10 [4183]
*Feb 15 20:01:311.734: NAT*: s=192.168.10.10->209.165.200.226, d=209.165.201.1 [2822]
*Feb 15 20:01:311.734: NAT*: s=209.165.201.1, d=209.165.200.226->192.168.10.10 [4184]
output omitted

```



Chapter 11: Summary

This chapter has outlined:

- How NAT is used to help alleviate the depletion of the IPv4 address space.
- NAT conserves public address space and saves considerable administrative overhead in managing adds, moves, and changes.
- NAT for IPv4, including:
 - NAT characteristics, terminology, and general operations
 - Different types of NAT, including static NAT, dynamic NAT, and NAT with overloading
 - Benefits and disadvantages of NAT
- The configuration, verification, and analysis of static NAT, dynamic NAT, and NAT with overloading.



Chapter 11: Summary (cont.)

- How port forwarding can be used to access an internal devices from the Internet.
- Troubleshooting NAT using **show** and **debug** commands.
- How NAT for IPv6 is used to translate between IPv6 addresses and IPv4 addresses.

Cisco | Networking Academy[®]

Mind Wide Open[™]