

Animation
The Art of
LAYOUT

And
Storyboarding

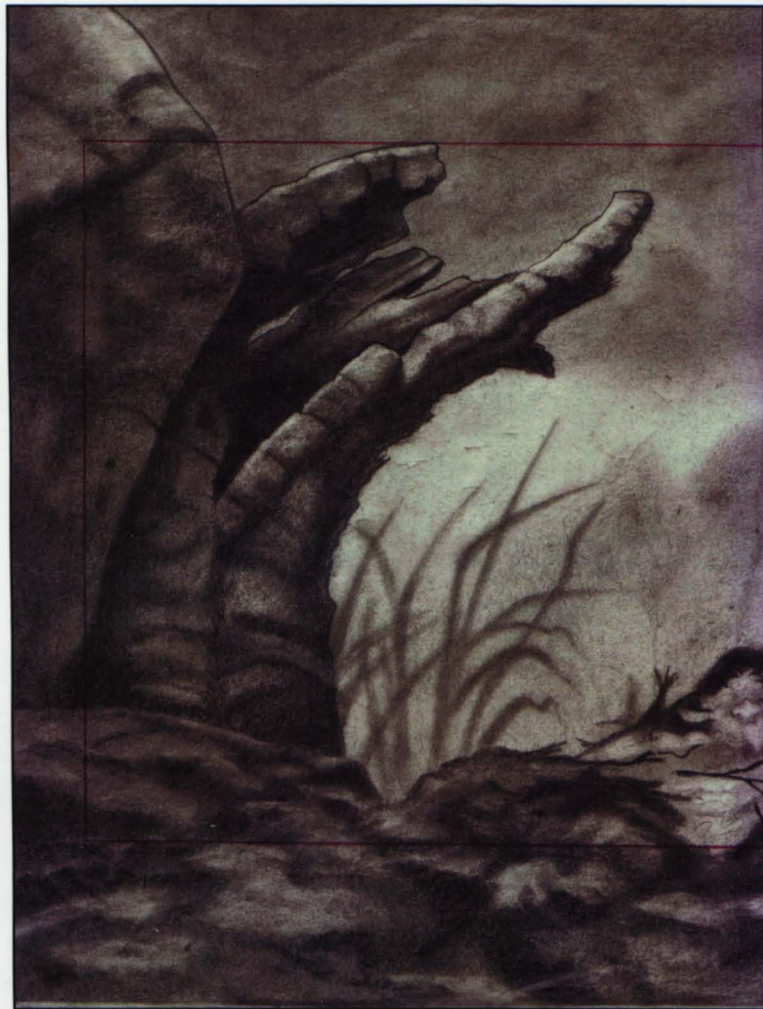

Complete step-by-step techniques in drawing layout and storyboards for classical, TV and computer game animation

MARK T. BYRNE



Mark T. Byrne worked as a layout artist in the Don Bluth Animation Studios in Ireland. He has extensive experience in the field of animation, having worked on several feature lengthmovies in addition to TV series and computer games, in many different capacities.

Mark now lectures in the Ballyfermot College of Further Education Ireland, where he heads the Computer Animation Department. His skills and knowledge are constantly in demand by the animation industry.

He lives in Leixlip, Ireland with his wife and children.

e-mail: art_of_layout@hotmail.com

Animation
The Art of
LAYOUT

And
Storyboarding



Mark T. Byrne



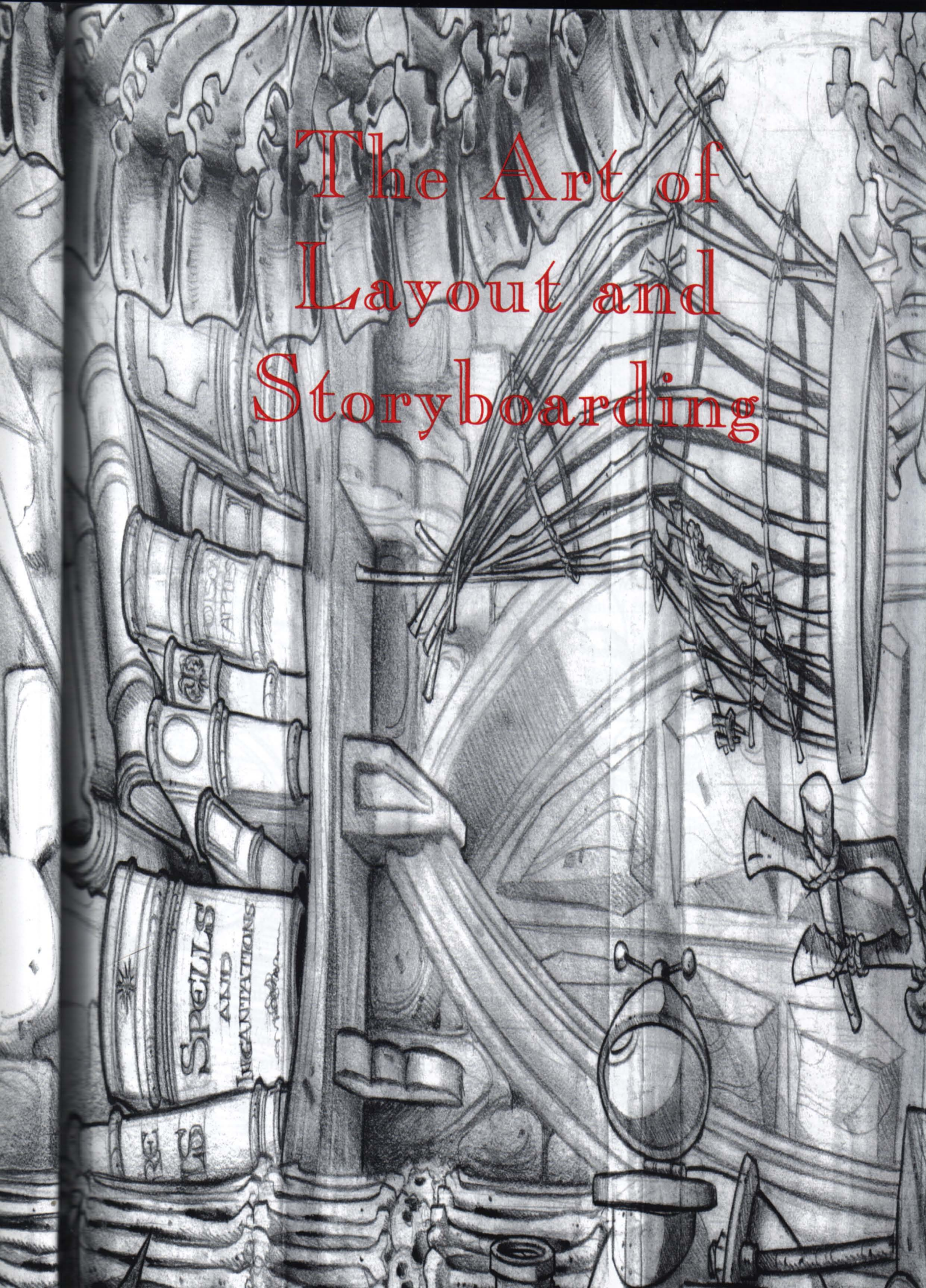

The Art of
Layout and
Storyboarding

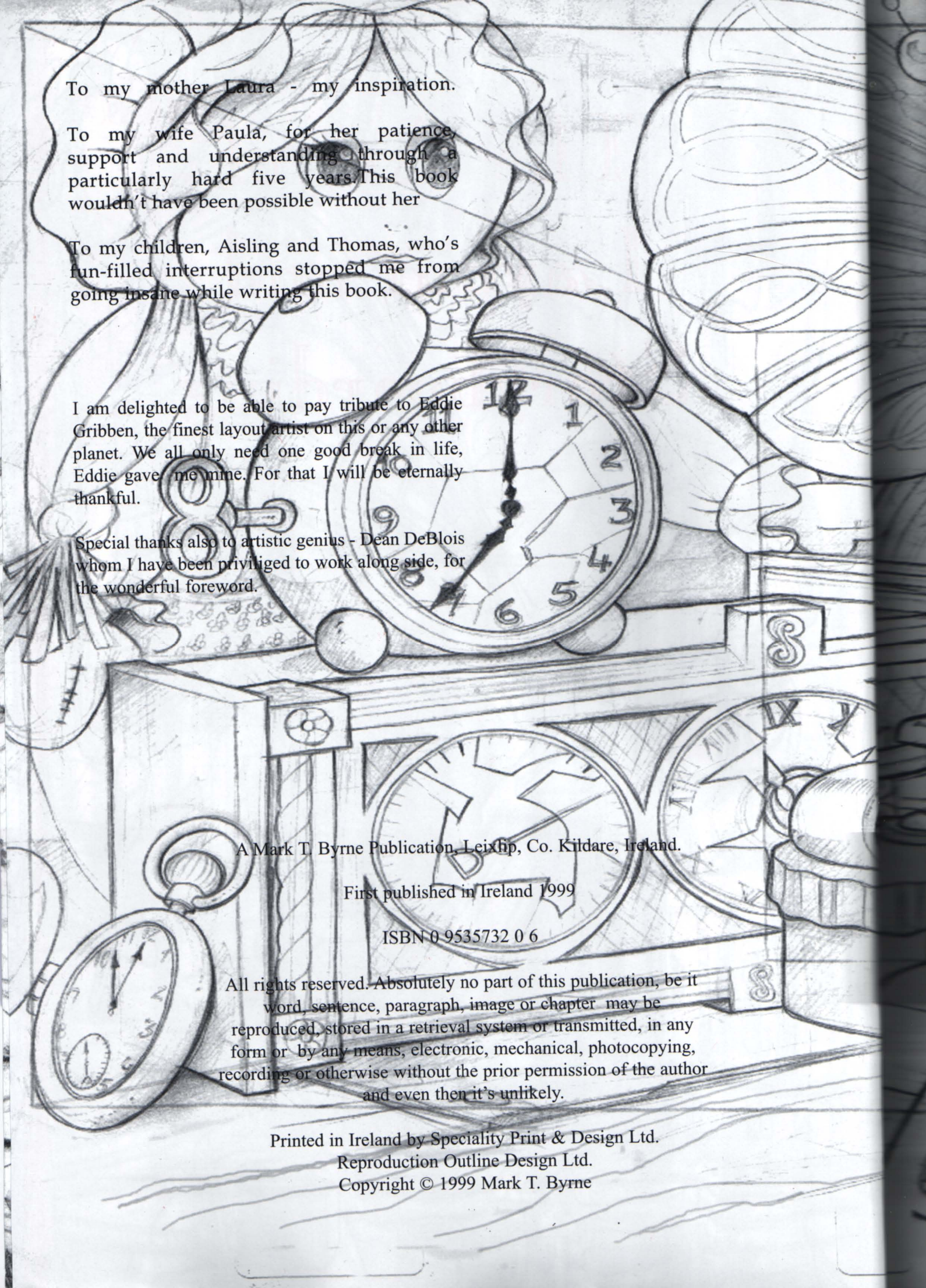

To my mother Laura - my inspiration.

To my wife Paula, for her patience, support and understanding through a particularly hard five years. This book wouldn't have been possible without her

To my children, Aisling and Thomas, who's fun-filled interruptions stopped me from going insane while writing this book.

I am delighted to be able to pay tribute to Eddie Gribben, the finest layout artist on this or any other planet. We all only need one good break in life, Eddie gave me mine. For that I will be eternally thankful.

Special thanks also to artistic genius - Dean DeBlois whom I have been privileged to work along side, for the wonderful foreword.

A Mark T. Byrne Publication, Leixlip, Co. Kildare, Ireland.

First published in Ireland 1999

ISBN 0 9535732 0 6

All rights reserved. Absolutely no part of this publication, be it word, sentence, paragraph, image or chapter may be reproduced, stored in a retrieval system or transmitted, in any form or by any means, electronic, mechanical, photocopying, recording or otherwise without the prior permission of the author and even then it's unlikely.

Printed in Ireland by Speciality Print & Design Ltd.
Reproduction Outline Design Ltd.
Copyright © 1999 Mark T. Byrne



Acknowledgements

Although I had often thought about writing this book, it finally materialised as part of an honours degree course which I undertook in Media Production and Management. I would therefore like to take this opportunity to thank the following people, who, although they may not have helped directly with the book, have helped me out in various ways.

Very special thanks to Anna Brett for her continuous help, guidance and encouragement over the past few years.

Thanks also to Rita Clifford, Denis Murray and the BA MPM team, Thelma Chambers and Ann Gunne Kelly.

Big thanks to Dave, Aidan, Jane, Eamonn, Fionnuala and Aideen.

Thanks to Suzie Hama of Norwich College of Art and Design.

Grateful thanks to Russell Boland, Gerry Shirren, Cathal Gaffney, Keith Foran and Helen Keelan for availing of their valuable time.

Thanks also to Stewart Shephard for the computer graphics on pages 154/5,6 and 158.

To those I worked with in the Don Bluth Studios Layout Department - cheers!

| |
|-------|
| SC 02 |
| BG 02 |
| OL |
| UL |





Contents

- 5** Acknowledgements
- 8** Foreword
- 11** Introduction
- 17** Perspective
- 51** Pans
- 69** Composition
- 87** Lighting and Rendering
- 99** Staging
- 119** Techniques and Motifs
- 135** Scene Planning
- 155** Computers and Layout
- 161** Storyboarding

Foreword

I've often heard it said, that creativity without craft, is like fuel without an engine. One can never replace the other, but rather, they must co-exist in balance so as to achieve success in any artistic pursuit. The techniques of an artform become the language with which it is expressed. Talent is, of course, a pre-requisite, but the level of an artist's proficiency seems directly related to the mastery of the medium in which he communicates. There is no better example of this delicate partnership than in the art of animation.

I attended college with the intent of learning all that there was to know about commercial animation. I read books, talked to industry professionals, and did my best to absorb all I could from the classes, but it wasn't until I landed my first job in animation that I realised how impractical my training had actually been. The 'real world' of animation can be vastly different from what you've read in books or studied in school.

Professional animation artists carry with them an arsenal of specialised techniques and time-saving tools that they have gathered and learned through experience in the industry. The average newcomer can't help but feel baffled, disoriented, and overwhelmed by this very daunting disadvantage. "The Art of Layout and Storyboarding" is a book that finally bridges this gap.

Mark Byrne and I first met at the then Sullivan Bluth Studios in Dublin, Ireland. As Layout Artists, we worked side by side for nearly four years before my move to California, where I took up a story artist position with the Walt Disney Feature Animation team. My experiences thus far have allowed me the opportunity to learn from the very best the world has to offer. All the while, I had to rely on observation, trial, and error to harness the skills I use on a daily basis. Now, in my current role as a feature animation film director, I see many portfolios coming through the studio - and much of the work seems entirely inapplicable and misdirected. It's clear that the need for practical, professional, and easy-to-grasp instruction is more important than ever.

Mark Byrne's "The Art of Layout and Storyboarding" is a detailed and comprehensive guide to the rewarding craft of animation layout and storyboarding. It covers every creative aspect from concept to final execution in simple terms and entertaining examples. Mark's extensive experience and industry-respected talent have blessed this book with an authoritative voice of unmatched competence. Like many of us, he felt the time was overdue for a book like this, and fortunately, he did something about it. "The Art of Layout and Storyboarding" is destined to not only become an authoritative guide for animation students worldwide, but also an invaluable reference for animation professionals alike. The universal concepts discussed in these pages extend far beyond the scope of our medium, giving this book a much wider breadth and appeal than simply that of the animation industry. It is an essential glimpse into the ways of professionals - and proper application of the techniques described here could shave years off of any rookie's learning curve. Fair play! It's about time someone had the sense to write this book!

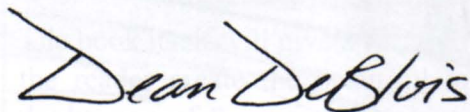

Dean DeBlois
Director
Walt Disney Feature Animation

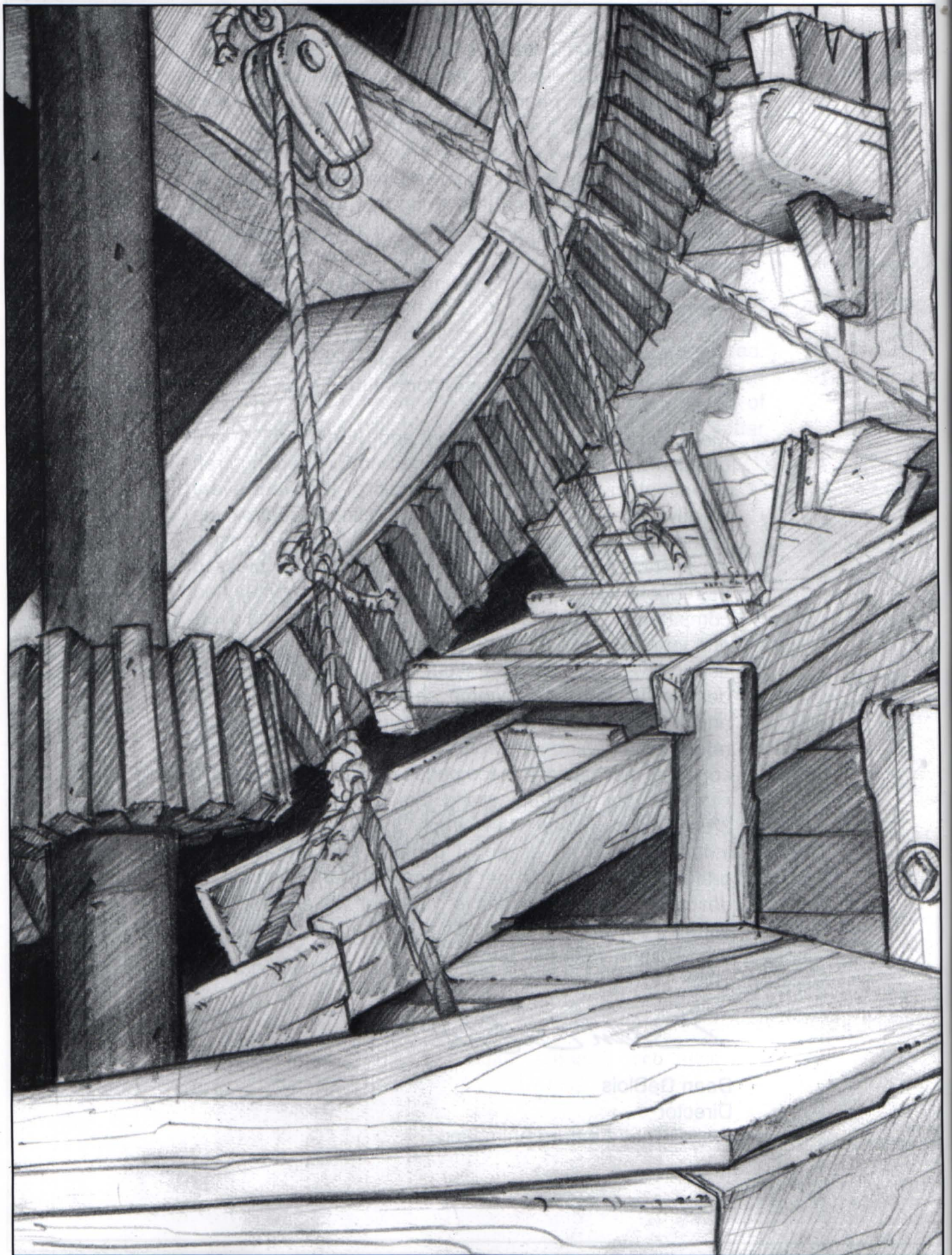



Introduction

Animation has long been a favoured form of entertainment and advertisement. The striking images with vivid colour and sound have enraptured and enthralled audiences of all ages for decades. From two minute shorts to feature length movies, animation can transport the viewer into fantastical make-believe worlds like no live action movie can.

Each and every piece of animation ever done starts off in the exact same way - an idea in somebody's head. This idea is then put down on paper as a script, which is turned into beautiful images by the storyboard artist. After the storyboard artist comes the layout artist. The layout artist creates the background design from which the animator will derive her stage for the characters to act upon. This book will guide the reader through the process of how to create these storyboards and layouts.

You will notice in this book that the layout section comes before the storyboarding section. This may seem ironic when you consider that the storyboard is always done before the layout in the animation industry. The reason for this is that anybody learning storyboarding needs to know the principles of perspective, composition etc. which are covered in layout, before they can embark on producing a storyboard.

The book itself will give a firm grounding which will help the reader create the beautiful imagery that is without doubt, one of the most important parts of the animation process.

One of the aims of producing animation, be it in a feature length movie, TV series, computer game or advertisement, is to give an impression that it was done by the hand of a single artist. This is not the case however, as it can take upwards of three hundred and fifty staff (including production) to make a feature length movie, and upwards of fifty to make a TV series. A TV studio may by-pass a few of these departments. For example, a layout artist in a TV studio will not only produce the background artwork, but also the character layout and the scene planning. In a feature studio, there would be a separate scene planning department, and almost certainly an artist who would do the character layout.

A feature studio would also have the luxury of having visual-development artists, art directors, production designers and possibly a separate team of animators for every character in the movie. A TV studio on the other hand may only have a handful of artists who have to do character / background design, layout and storyboard or animation and clean-up etc.

For economic reasons, more and more studios around the world are operating with a small core team of up to five artists plus one or two production staff. Having then successfully pitched for a project, or having received funds to make their own project, they will hire a larger team of freelance artists on a contract basis. These artists would stay for the duration of their department's involvement in the project. Many animation artists prefer to freelance, as it means that they can vary their style and not become stagnant working under the same director year after year, possibly cramping their talents.

Computers are now playing a bigger part in animation production, although they have actually been used for the best part of thirty years. Their use has expanded into digital ink and paint, thus replacing the laborious task of cel-painting. It is now possible to have hundreds of levels of animation, unlike the mere seven levels that the industry was stuck with for so long. Computers have also replaced the rostrum camera. The artwork is now scanned in to the computer, the result of which saves the studio time and money. More exciting camera moves can also be added, and more complex models can be built using 3D computer animation, thereby replacing the costly and time consuming art of model-making and creating 'stats'.

The role of the layout artist is to design and draw the 'stage' on which the character and special effects animation takes place, in addition to staging every scene and camera set-up. The layouts are drawn from the storyboard panels which the layout artist develops into detailed backdrops, ready for the background department to paint. The layout artist needs to have excellent drawing skills and he needs to master such things as perspective and composition. He needs to be able to draw any object, building or landscape from any angle. The layout artist must always think three-dimensionally and he must be able to embellish the storyboard without changing it drastically.

The storyboard artist works directly from the script and creates the first visual images of the project. She turns the script into a series of comic book like images that narrates the tale. Like the layout artist, the storyboard artist will also have excellent drawing skills with an ability to draw humans and animals as proficiently as props or landscapes. She will also have a comprehensive understanding of layout, background and animation, in addition to a knowledge of acting and dance. The storyboard artist will provide the blue-print from which the entire project is built.

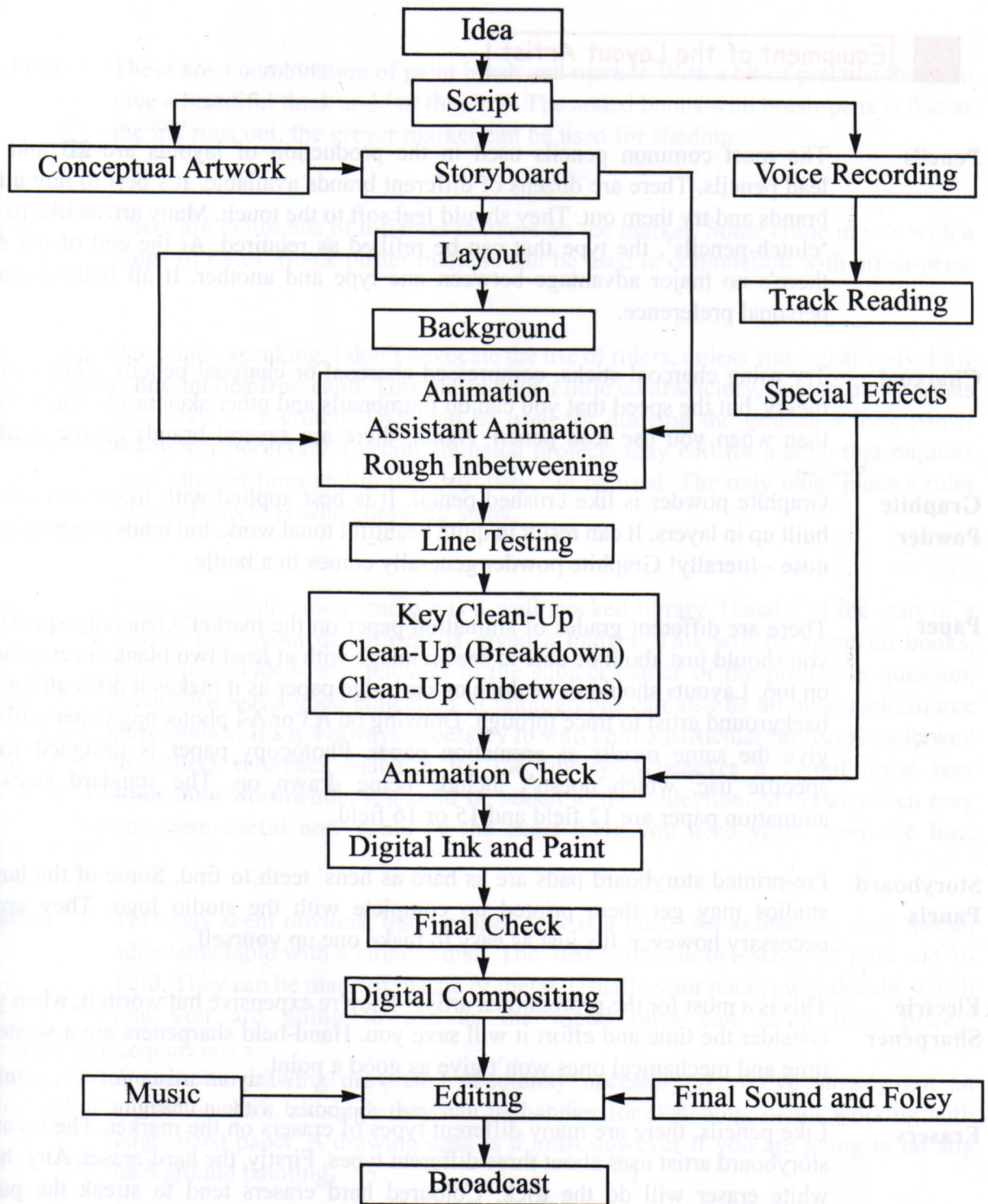

This is a very basic flow chart. There would of course be other departments, e.g. computer-animation, continuity etc. who would work in tandem with those above. Nowadays because of the enormous cost of running a studio, it is becoming more common for work to be contracted by larger studios to smaller studios and subsequently to individual freelance artists. Whilst this may be advantageous in running costs, it's much harder to keep check on exactly where each scene from the project is, and the chances of losing artwork are greatly increased. It's not uncommon for a movie or TV series to be worked on in several countries by several studios at the same time.

Equipment of the Layout Artist

- Pencils** The most common pencils used in the production of layouts are 2B and 6B lead pencils. There are dozens of different brands available. It's best to buy a few brands and try them out. They should feel soft to the touch. Many artists like to use 'clutch-pencils', the type that can be refilled as required. At the end of the day, there's no major advantage between one type and another. It all boils down to personal preference.
- Charcoal** Try using charcoal sticks, compressed charcoal or charcoal pencils. They can be messy, but the speed that you can do thumbnails and other sketches is much faster than when you use lead pencil. Again, there are several brands on the market.
- Graphite Powder** Graphite powder is like crushed pencil. It is best applied with tissue and can be built up in layers. It can result in quite beautiful tonal work, but tends to get up your nose - literally! Graphite powder generally comes in a bottle.
- Paper** There are different grades of animation paper on the market. Generally speaking, you should just about be able to see an image with at least two blank sheets placed on top. Layouts shouldn't be done on cartridge paper as it makes it difficult for the background artist to trace through. Drawing on A3 or A4 photocopy paper will not give the same results as animation paper. Photocopy paper is designed for a specific use, which doesn't include being drawn on. The standard sizes of animation paper are 12 field and 15 or 16 field.
- Storyboard Panels** Pre-printed storyboard pads are as hard as hens' teeth to find. Some of the larger studios may get them printed up complete with the studio logo. They aren't necessary however. It's just as easy to make one up yourself.
- Electric Sharpener** This is a must for the professional artist. They're expensive but worth it, when you consider the time and effort it will save you. Hand-held sharpeners are a waste of time and mechanical ones won't give as good a point.
- Erasers** Like pencils, there are many different types of erasers on the market. The layout / storyboard artist uses about three different types. Firstly, the hard-eraser. Any hard white eraser will do the trick. Coloured hard erasers tend to streak the page. Secondly, a 'kneadable' or putty rubber is a must. As the name implies they are like a lump of putty and should be *soft* in the hand. These erasers are really excellent as they can completely erase or merely rub-down a line, thereby leaving a ghost image which can be worked over. The third type is the electric eraser. Most electric erasers are in fact battery powered. They can be difficult to get hold of as they are not a commonly used artist's tool. Once you start using one however, you'll wonder how you ever did without it!

- Brush Pens** These are a combination of paint brush and marker. With a bit of practice they can give a beautiful thick and / or thin line. The added bonus with brush-pens is that as the ink runs out, the greyer marker can be used for shading.
- Markers** There are thousands of different markers on the market. Some come in sets with a range of tones. Black poster-markers can be used in conjunction with brush-pens.
- Rulers** Personally speaking, I don't advocate the use of rulers, unless you can already draw a straight line free-hand. This may sound a little contradictory, but too many artists use rulers as a crutch. They can be used for drawing the grid on a long pan if absolutely necessary. Certain animated projects may call for a style that requires dead-straight lines and in this case they can be used. The only other place a ruler should be used is when drawing stairs.
- Library** Every good animation studio has a well stocked library. Usually at the start of a project the layout department is given a budget. This will be spent on books, magazines, videos etc. relevant to the subject matter of the project in question. Field trips and a good collection of photographs can also be an invaluable source of reference. It's not always necessary to wait until a particular project is underway to collect reference material for the library. Whenever a layout artist sees something worthwhile, it should be added to the collection. Material which may not seem useful now could be the exact thing you need years down the line.
- Animation Desk** This may seem obvious, but a proper desk is a must. An animator's desk has an adjustable table with a circular disk. The disks come in two sizes, 12 field and 16 field. They can be made of plastic or metal. Usually your pocket will decide which one you are going to use as the metal ones can be a little pricey.
- Drawing Desk** A separate drawing desk isn't absolutely necessary if you've already got an animation desk, although they can be handier for sketching, or for working with large sized paper. A drawing desk is a must however if you are going to do any background painting.
- Noticeboard** A noticeboard or preferably an entire wall should be used for displaying artwork. The director usually likes to see the artwork when it's mounted and not as several bits of paper scattered across a table.

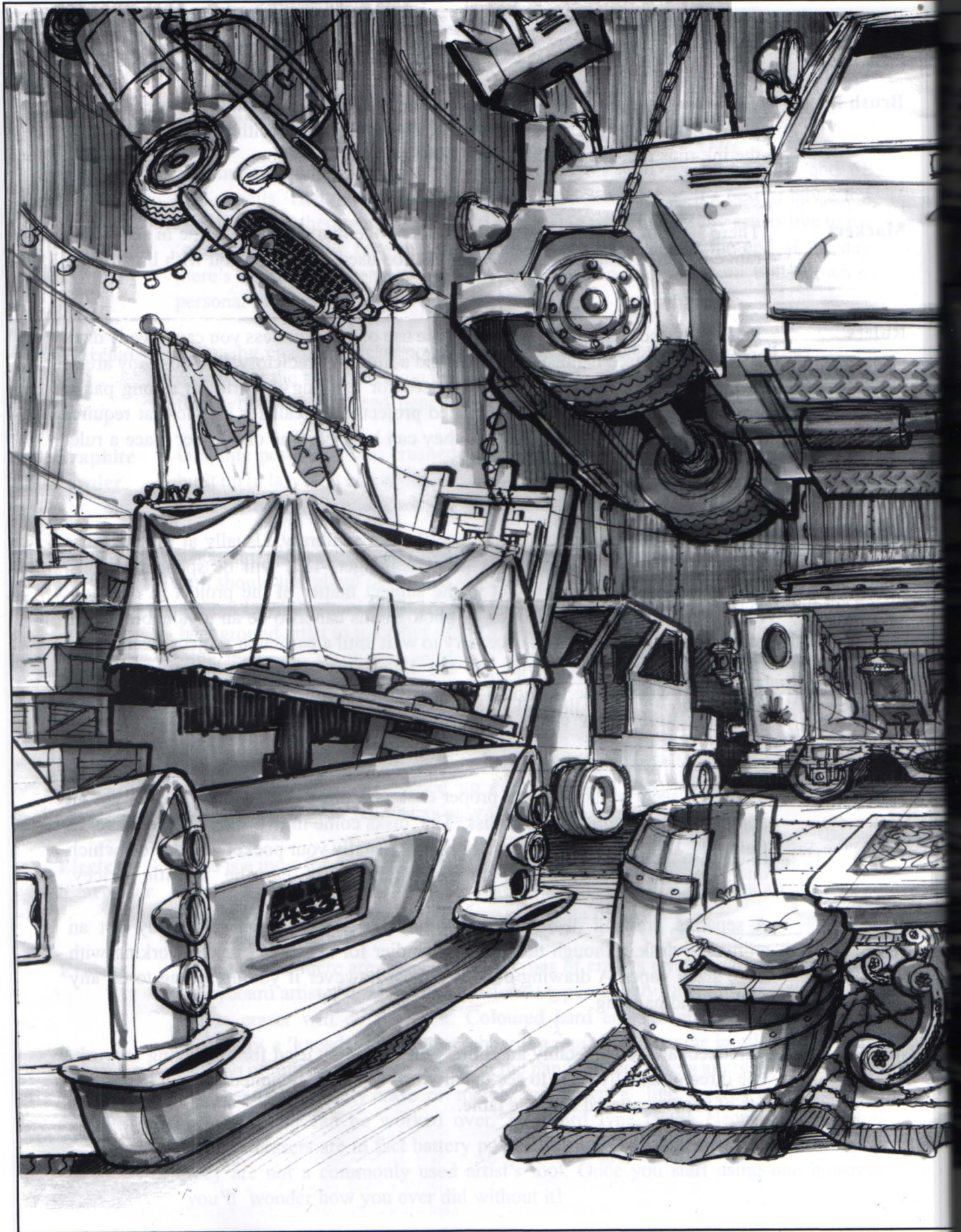



Perspective

The most important part of any layout is the perspective. The layout artist must create the illusion of space and make the audience believe that they can climb right into the screen and walk around this make-believe world, whilst interacting with the objects within it. It is necessary therefore for the layout artist to *master* all forms of perspective.

While we sit and watch animation, it is easy to forget that the images we see before us are only two-dimensional. With the exception of 3D model animation, we are only ever working with a two-dimensional format. The background paintings, the paper on which we draw our layouts and animation, and our computer screens, all only have *height* and *width*. The dimension they are missing is of course *depth*. To achieve this feeling of depth we must create an illusion. This illusion is called, the "*Illusion of Space*".

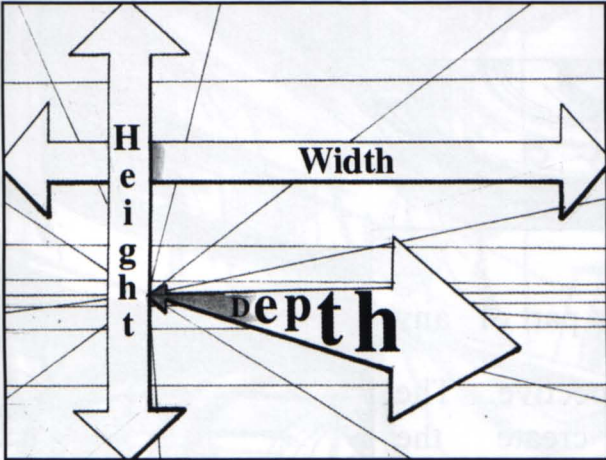

We must give the audience the illusion that the characters are moving about in a three-dimensional world.



Because of the two-dimensional format, characters are flat. However, to help give the illusion of movement on screen...

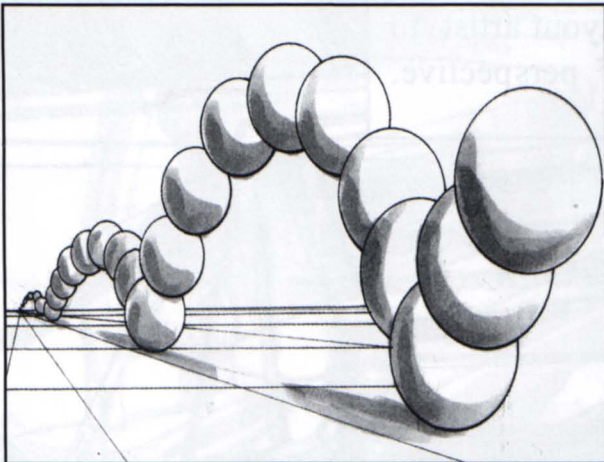

...the characters need backgrounds that appear to have space.

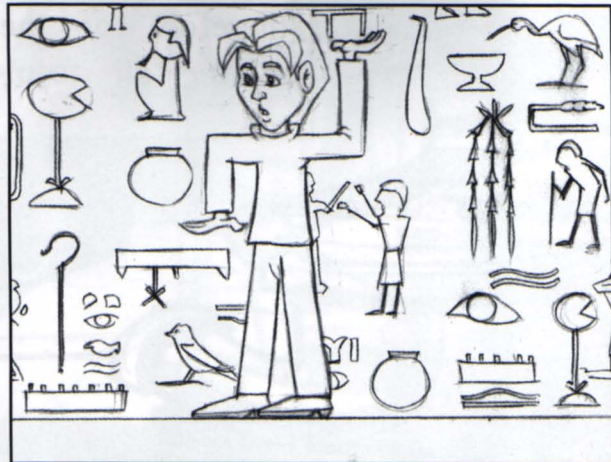

Otherwise, they'd all be walking Egyptian.

So how do we create this illusion?

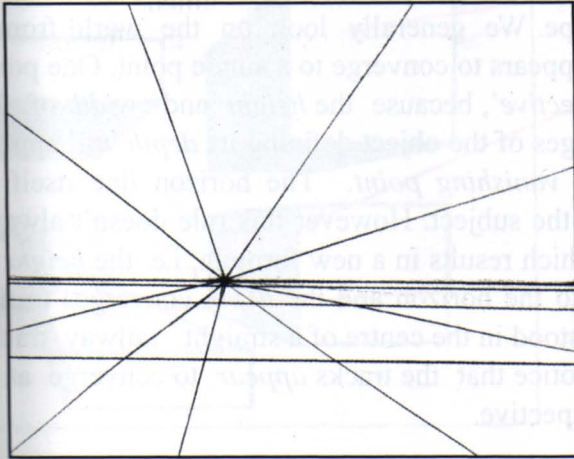

We can use perspective...

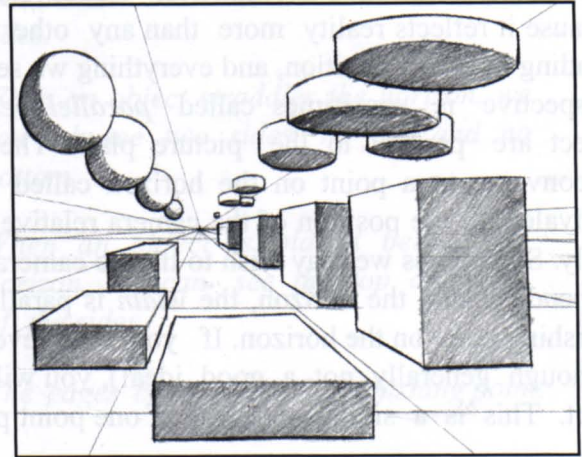

....by decreasing the size of objects as they get closer to the horizon.



What's vitally important to remember, is that the perspective used in the background must also be used for the characters.

Essentially, perspective can be broken down into five basic elements :

- * One point.
- * Two point.
- * Three point.
- * Forced or warped.
- * Aerial or pictorial.

One Point Perspective

One point perspective is the most widely used type of perspective when doing layout. This is because it reflects reality more than any other type. We generally look on the world from a standing or sitting position, and everything we see appears to converge to a single point. One point perspective is sometimes called '*parallel perspective*', because the *height* and *width* of the object are parallel to the picture plane. The edges of the object defining its *depth* will appear to converge to a point on the horizon called the *vanishing point*. The horizon line itself is equivalent to the position of the camera relative to the subject. However this rule doesn't always apply. Sometimes we may wish to tilt the camera which results in a new formula, i.e. the *height* is perpendicular to the horizon, the *width* is parallel to the horizon and the *depth* converges to the vanishing point on the horizon. If you have ever stood in the centre of a straight railway track, (although generally not a good idea!), you will notice that the tracks *appear* to converge at a point. This is a simple example of one point perspective.

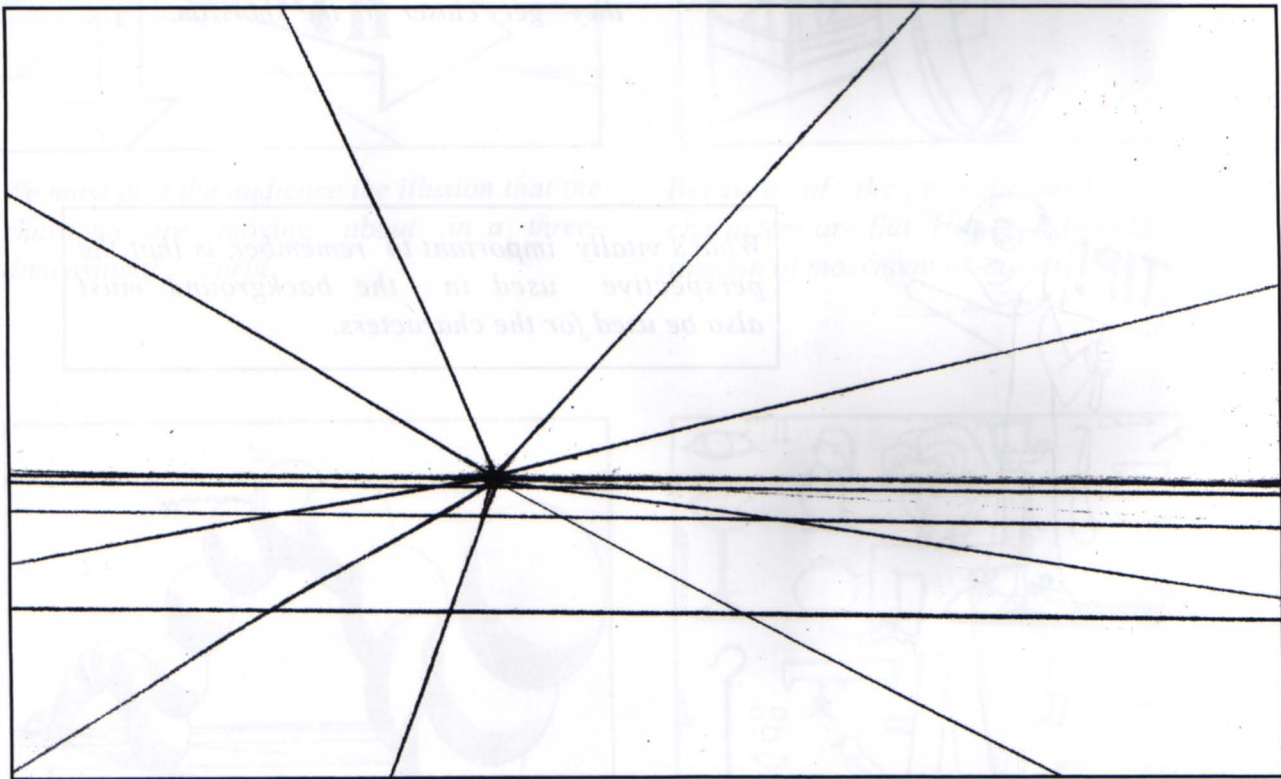

Layouts always start with a grid (after the cut-off has been lightly drawn in, which we'll look at later). This is going to give us a plane where the animator will place the action. The grid is drawn lightly on the page, but should remain visible while the layout is being drawn, and more importantly, it should be evident when the layout is finished. The vanishing point should always be visible on the drawing so that it can be constantly referred to. Don't, however, make it look like a spider was squashed into the page, by having the start of dozens on grid lines emanating from it. Keep your grid light at all times.

'Parallel Rule'

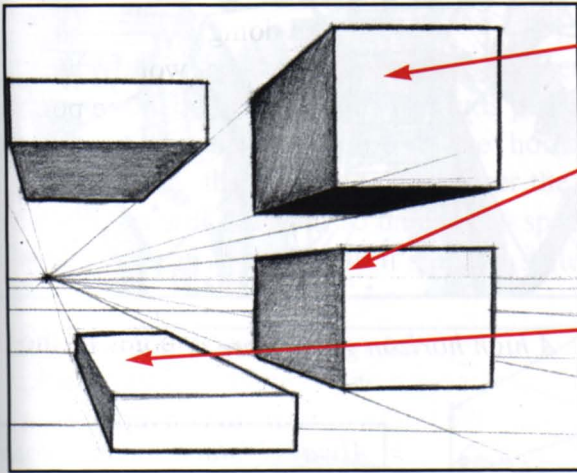

When an object is placed over the horizon, we can see the underside and two of the sides.

When an object straddles the horizon, we can only see two sides, no top and no bottom.

When an object is placed below the horizon, we can see the top and two of the sides.

The edges converge to the vanishing point.

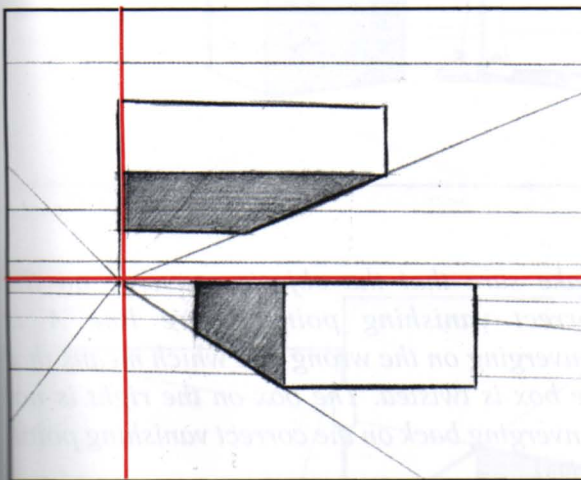

Try not to draw too close to the vanishing point or the horizon line.

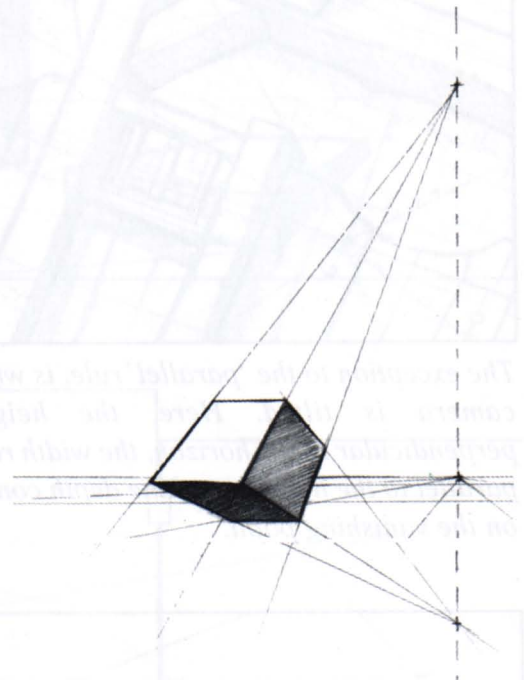

An object resting on one edge will follow a different set of vanishing points. These are generally in line with the main vanishing points.



With one point perspective, you can have as many vanishing points as you wish on the horizon, but you should only have one horizon on your drawing. An object 'turned' will have a different set of points. These will follow the rules of two point perspective which we will cover later.

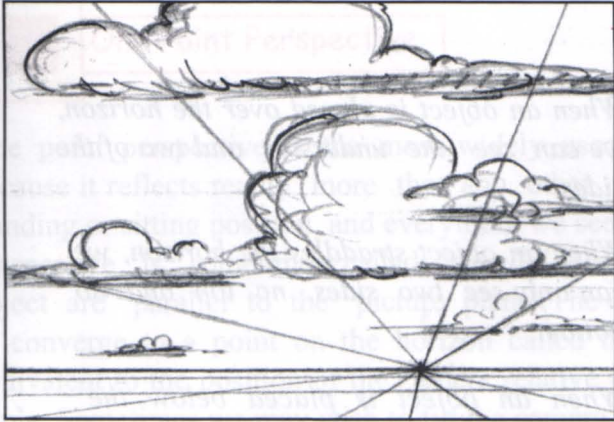

A low horizon gives more of an up-shot.

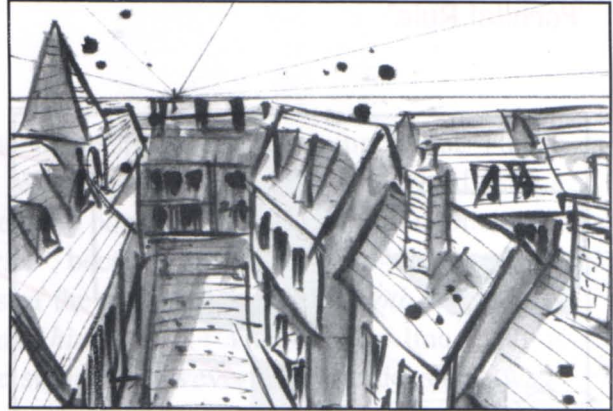

A high horizon gives more of a down-shot.

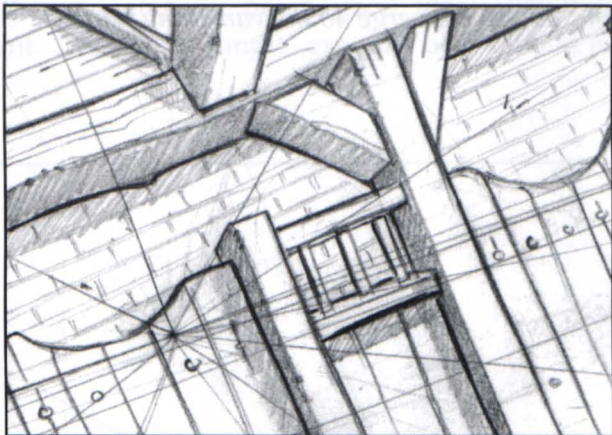

The exception to the 'parallel' rule, is when the camera is tilted. Here, the height is perpendicular to the horizon, the width remains parallel to the horizon and the depth converges on the vanishing point.



Always start with your pencil tip on the vanishing point and draw away from it.

Make sure that the objects converge on the correct vanishing points. Here line A is converging on the wrong V.P. which means that the box is twisted. The box on the right is not converging back on the correct vanishing point. (Below)

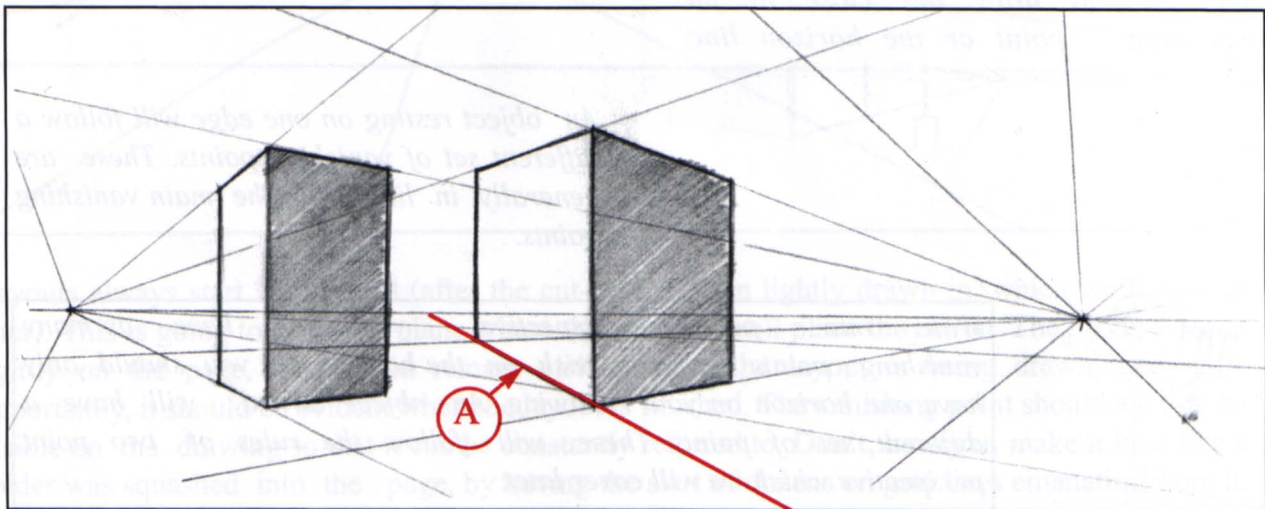

Two Point Perspective



Two point perspective follows the same general rules as one point perspective, with some slight differences. In two point, the *height* is perpendicular to the horizon line and the *width* and *depth* converge on vanishing points on the horizon line. Where you place the vanishing points will greatly affect the drawing. The closer the points are together, the more distorted and squashed the objects will become. So unless you specifically want your layout to look odd, don't use two-point perspective on a still. It's more suited to panning shots.

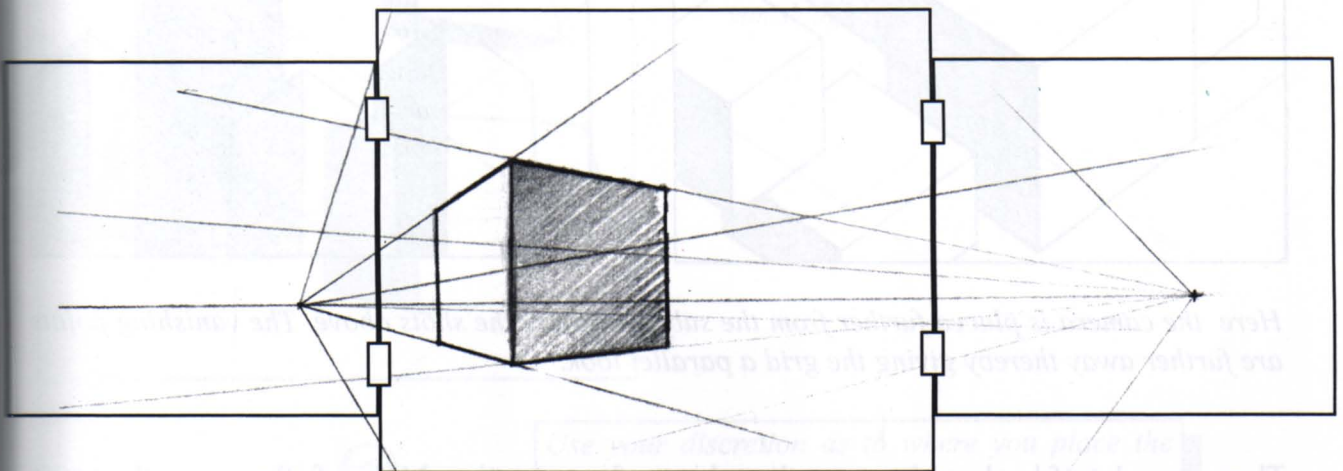
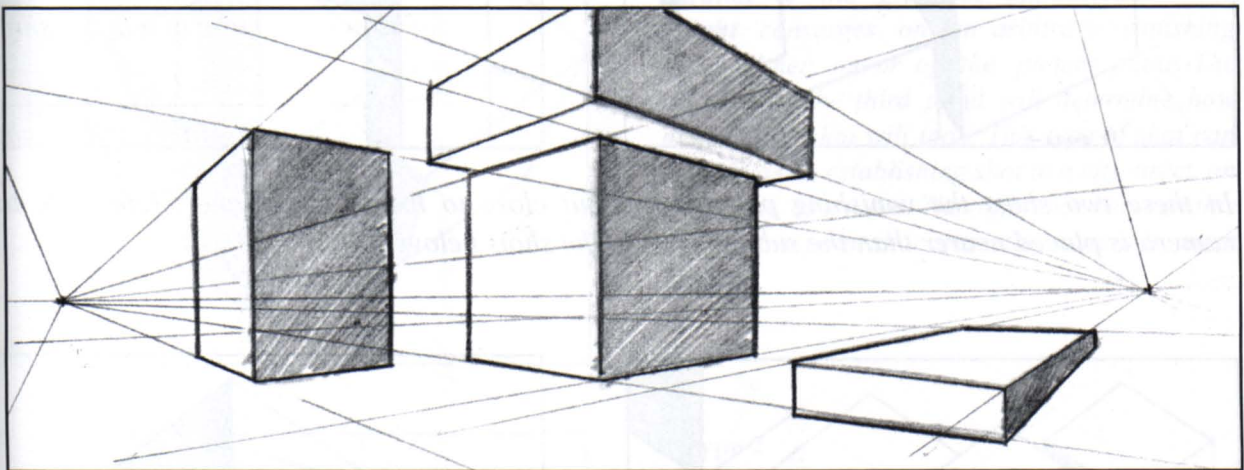

In two point perspective, the vanishing points may not always be on the page. When this occurs, it's a good idea to stick extra lengths of paper to the original (with removable tape) as a constant source of reference. Once the layout is complete, the extra pages can be removed. The vanishing points don't always have to be equidistant apart. One can be placed quite close to the picture plane, the other can be across the street!.

A completely different type of two point perspective may be used, if and when the horizon is not in the picture plane. This shot can be used as either an extreme upshot or extreme downshot.

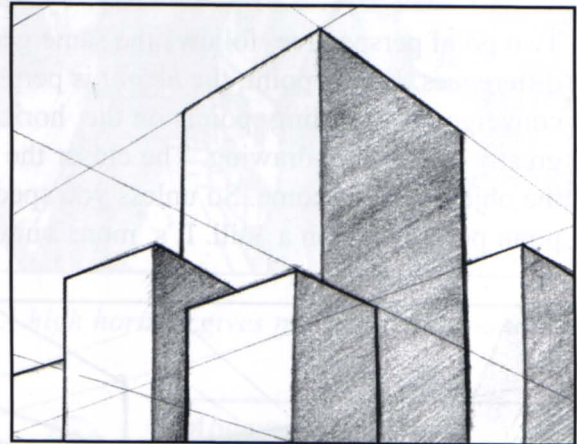
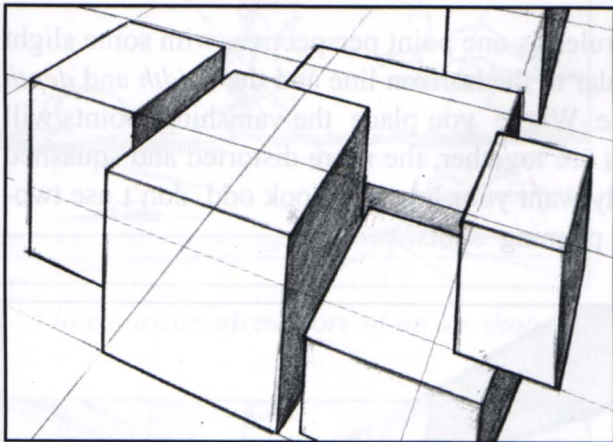

In these two shots the vanishing point is off, but close to the picture plane. Here also, the camera is placed nearer than the subject than in the shots below.

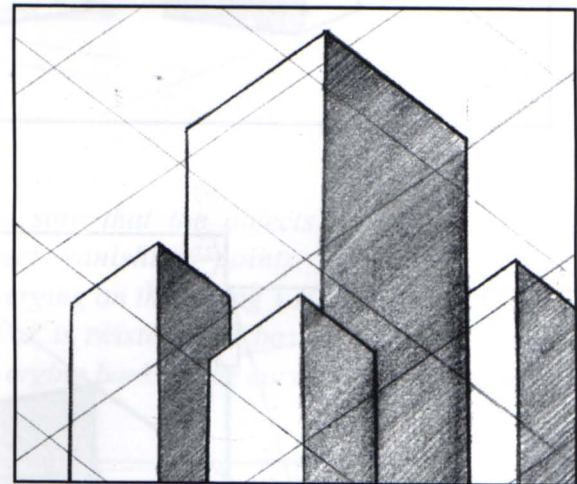
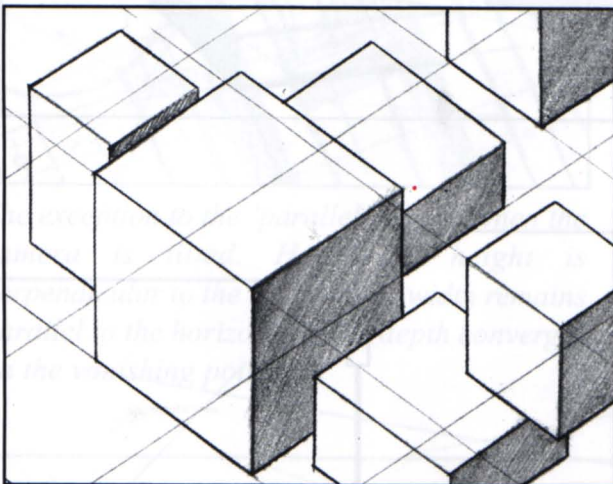

Here the camera is placed further from the subject than in the shots above. The vanishing points are further away thereby giving the grid a parallel look.

There are a lot of books written on the subject of perspective. Many of these use the terms *isometric* and *oblique*. These are set angles of $30^\circ / 60^\circ$ and 45° respectively. As artists, we are not stuck to specific angles. When we draw, we may end up with a grid that looks better at $32^\circ / 68^\circ$ or 43° etc. Let's leave the set angles for architects and engineers and use our 'artist's eye' for better results!

Three Point Perspective



Three point perspective uses a combination of the rules that we have already applied to one and two point perspective. Essentially though, it gives us a more extreme point of view.

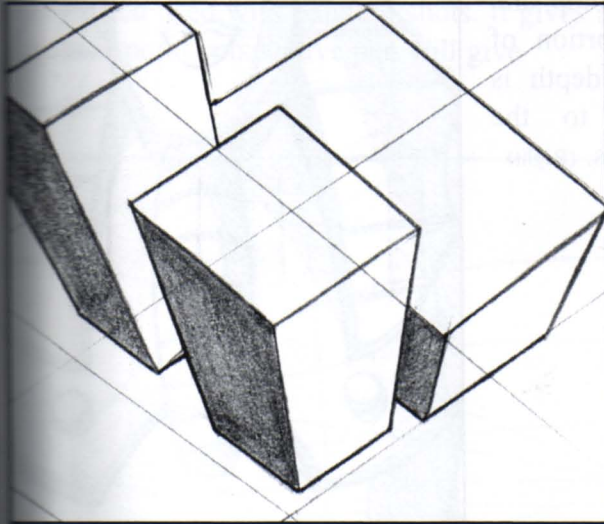

Type 1

The grid we use here is the same type as the one we used in two point perspective. The **width** and **depth** of the objects are parallel to the grid, but this time the **height** converges on an arbitrary vanishing point either on or off the picture plane. The position of the third point will determine how extreme the shot will look. This type of shot can be used as an establishing shot in a city street, an entire city, or a room. The difference between this and the two point shot is that the camera is much higher.

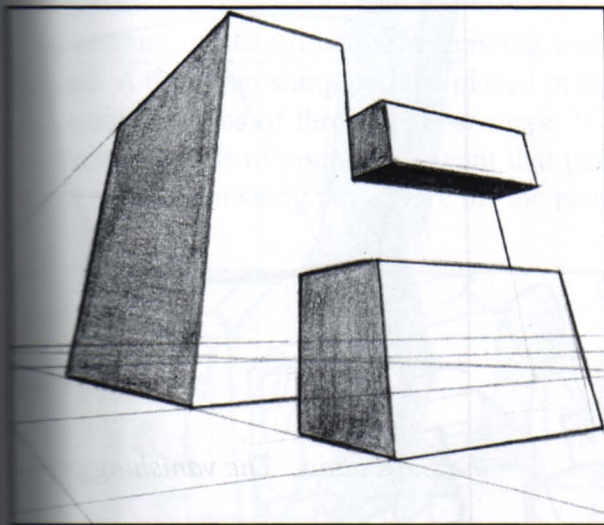

Type 2

Here the **depth** and **width** of the object converges on a vanishing point on the horizon. The **height** converges on an arbitrary vanishing point.



Use your discretion as to where you place the third vanishing point, so as to give the most effective shot. However, these type of shots are more suited to **pans**.

Type 3

This shot gives us the impression that we are looking through a fish eye lens. It is sometimes called a 'Balloon shot'. Here we are in the centre of a large statue. We can begin by looking up and then down, or vice versa. The horizon is in the centre of the picture plane. The height of the statue converges on vanishing points at the top and bottom of the picture plane. The amount of distortion of the statue is arbitrary. The vanishing point for depth is on the horizon line and the width is parallel to the horizon. This type of shot is best suited to long pans. (Right)

Type 4

The width and depth of the objects converge on vanishing points on the horizon. The height of the objects converges on an arbitrary vanishing point. (Below)

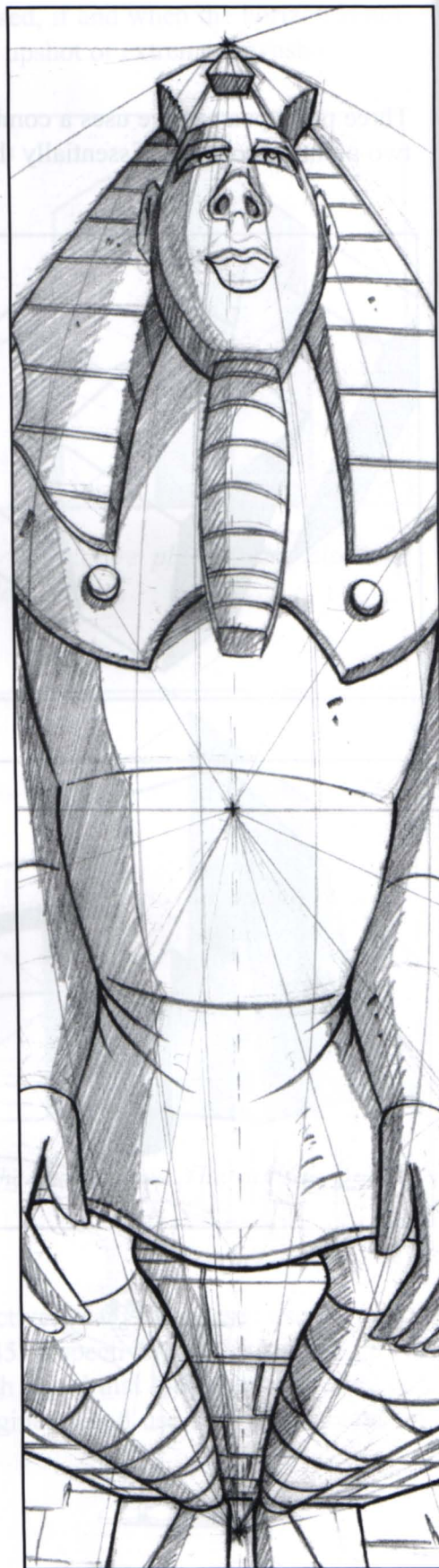
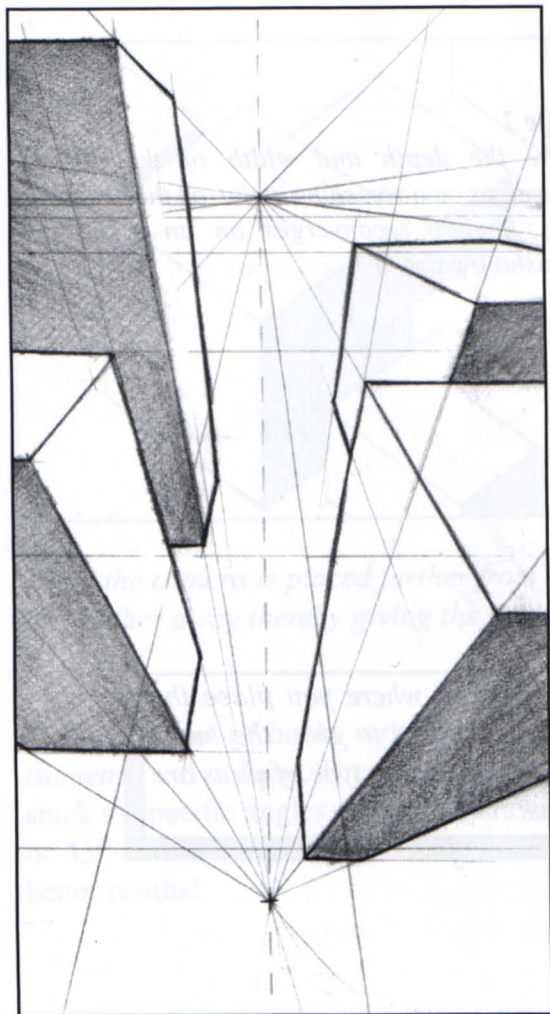

Forced Perspective



In conventional perspective i.e. one, two and three point, we use regular horizons and vanishing points. When we force the perspective we still use the same rules (objects converging to vanishing points) but now we can twist and turn the grid to suit our needs. Forced perspective is very often used with panning shots. It gives a far more panoramic view than a conventional two or three point perspective pan will give.

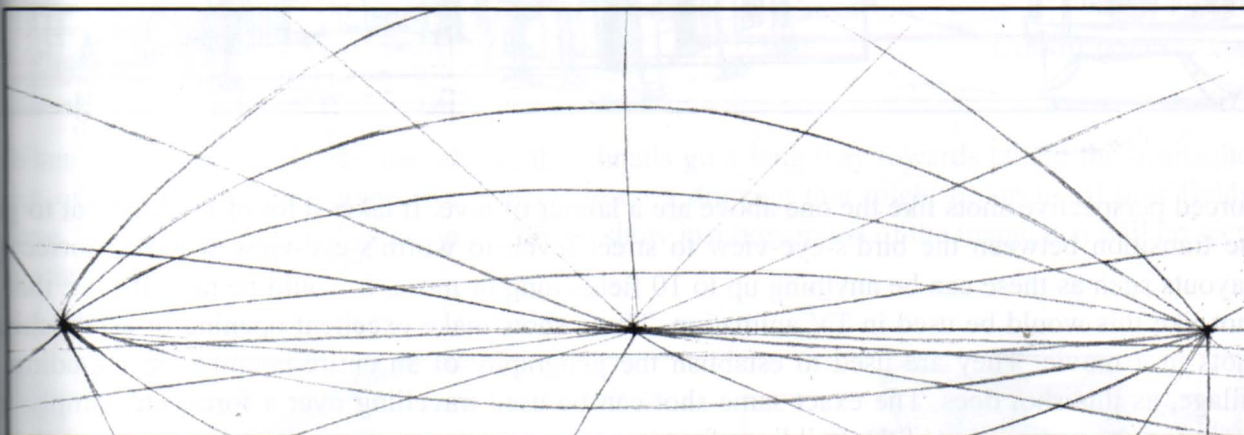

The amount of distortion on the drawing will depend on where the extreme vanishing points are placed. A third vanishing point is placed in the centre of the two extremes. These type of layouts are suited to pans of three fields or more. If they are any smaller, the perspective will look too squashed (unless of course you want that particular look). You can use a shorter pan, but make sure that the vanishing points are off the picture plane.



A scene like this looks like it was shot with a fish-eye lens, and it is not the same as using perspective like the shot above. It is commonly caused by placing the vanishing points too close together on too short a pan. If however, you want a "fish-eye" type shot, then it's fine!

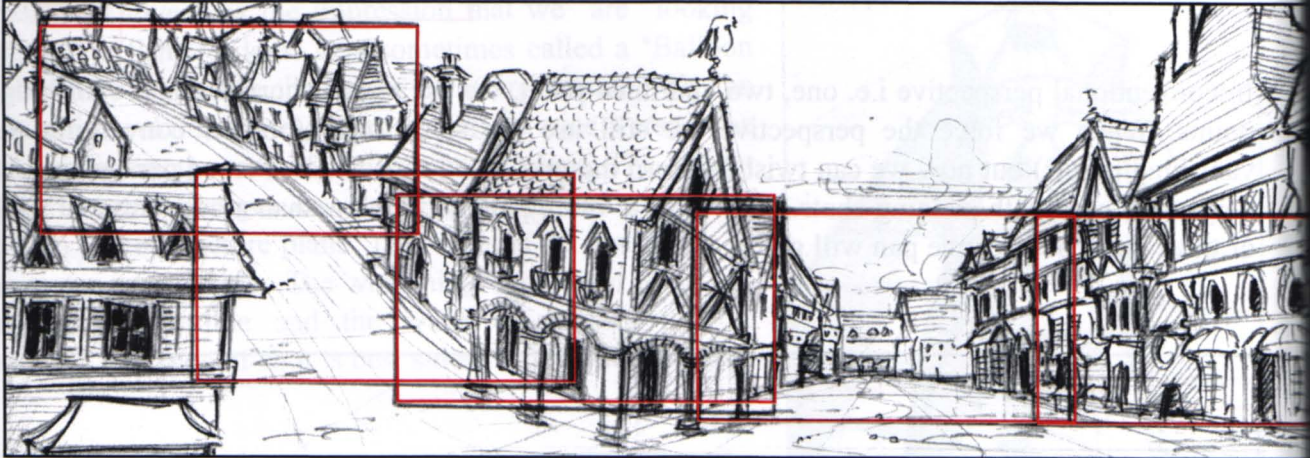

Forced perspective shots like the one above are a labour of love. It takes a lot of working out to get the transition between the bird's-eye-view to street level, to worm's-eye-view working correctly. Layouts such as these can be anything up to 10 fields long or more. It would be rare, if ever, that a shot like this would be used in TV animation. These shots make excellent opening or establishing shots in a movie. They are used to establish the geography of an entire countryside including a village, as this shot does. The exact same shot can be used travelling over a forest etc. simply by swapping the perspective of the buildings for trees.

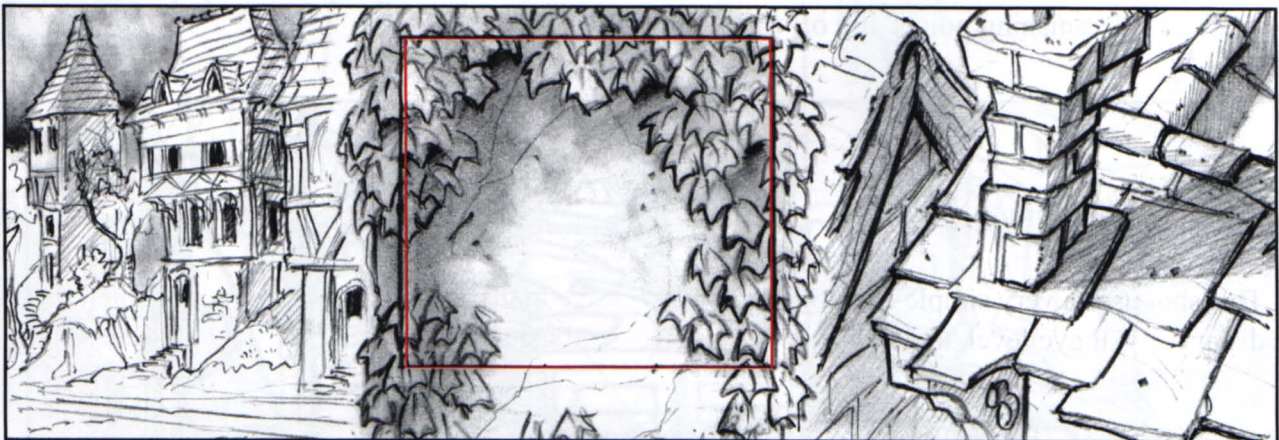

An easy way out of the type of layout above where we're trying to work out transitions, is to put in an object (often an overlay) that takes up a full field. The camera can go into the frame looking at an extreme downshot and come out the other side at an extreme up shot or eye level shot, or whatever. This type of shot can make the layout artist's job a lot easier, but is not quite as nice as the one above. The pan would be much longer than indicated here.

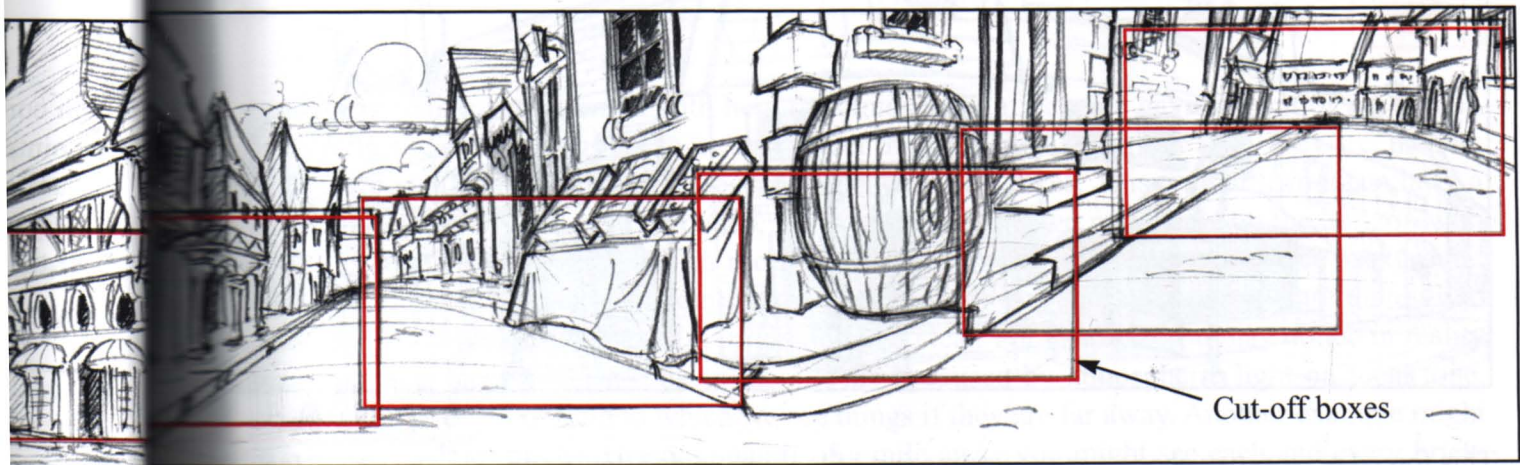

When doing layouts like the one above, thumbnails go a long way towards taking the heartache out of working out the perspective, especially on a drawing that might be up to 10 plus fields long. The cut-off boxes indicated on the layout show just how much of the image that will be seen on the screen.



This shot uses a very simple form of forced perspective to give the impression of looking at the distant city at eye level, and then rotating to the island using an extreme down shot.



Cut-off boxes are always drawn in red pencil.

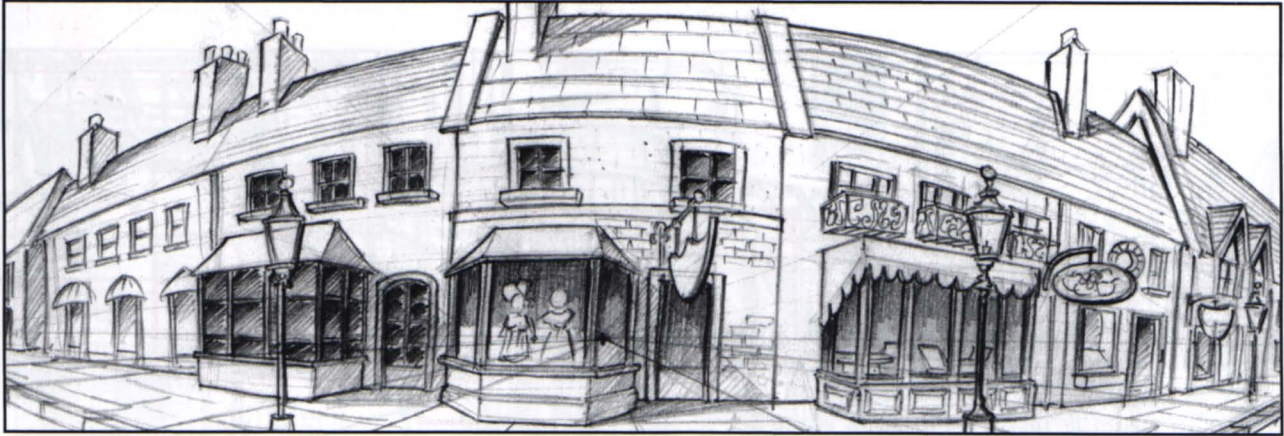

This forced perspective shot gives the impression of looking up and down one side of a street. It suits pans over three fields long.

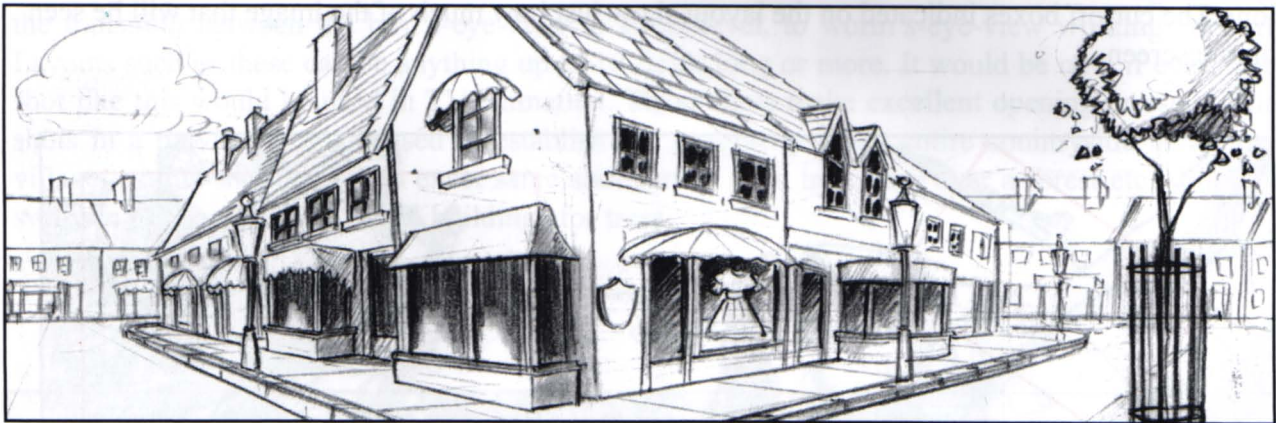

This two-point perspective shot is at a corner looking down two streets and shouldn't be mistaken for the shot above.

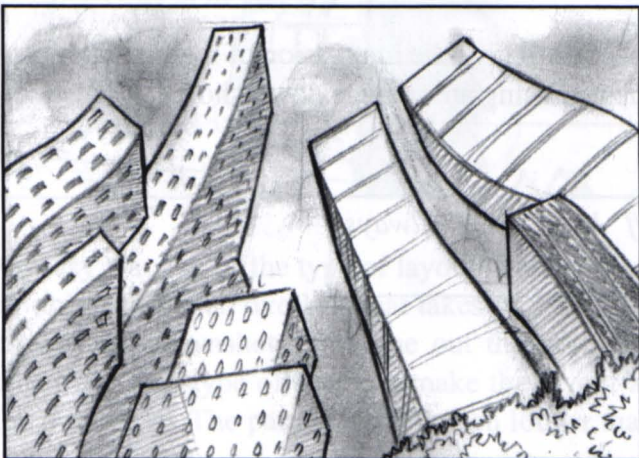

This shot gives the impression of viewing buildings through water, or through tired \ unbelieving eyes coming into focus. It would be used in conjunction with camera effects.

Aerial or Pictorial Perspective



Aerial perspective is concerned with how the atmosphere affects the environment of the layout. Essentially, the closer things are to us, the clearer they will be. The further away they are, the less detail there will be and they will have a more delicate, soft focus. This type of layout can have a mixture of calmness in the backgrounds, for example, pine laden mountains on the horizon with a more dramatic foreground such as rocks, a hedgerow or a field of flowers. The background painter will take the layout and paint it accordingly, so objects in the foreground are more vivid and those in the background are less bright and less clear. For example you may notice in reality that mountains have a bluish look to them. This is caused by atmospheric light on local tone, mixed with the depth of field in which we see things if they are far away. Another example might be a house made of bricks. Up to a quarter of a mile away you might see each and every brick. Any more and you will not be able to see the individual bricks, but the colour of the house would indicate what the house is made of. Aerial perspective is completely different to all other forms of perspective, in that it is using soft tones and not hard, dark lines to create depth.



Soft focus elements are used to form the basis of Aerial Perspective



Scale in Layout

One of the biggest problems in learning layout, is trying to understand and master scale. When a layout is complete, the artist should be able to say exactly what size each prop is and how far it is away from the camera. Consider natural law when you're doing your layout i.e., that when an object is far away from us it will appear smaller and less detailed, and when an object is closer to us it will be larger and more detailed. In the following drawing, the levels are not painted separately. They are numbered only for clarity.

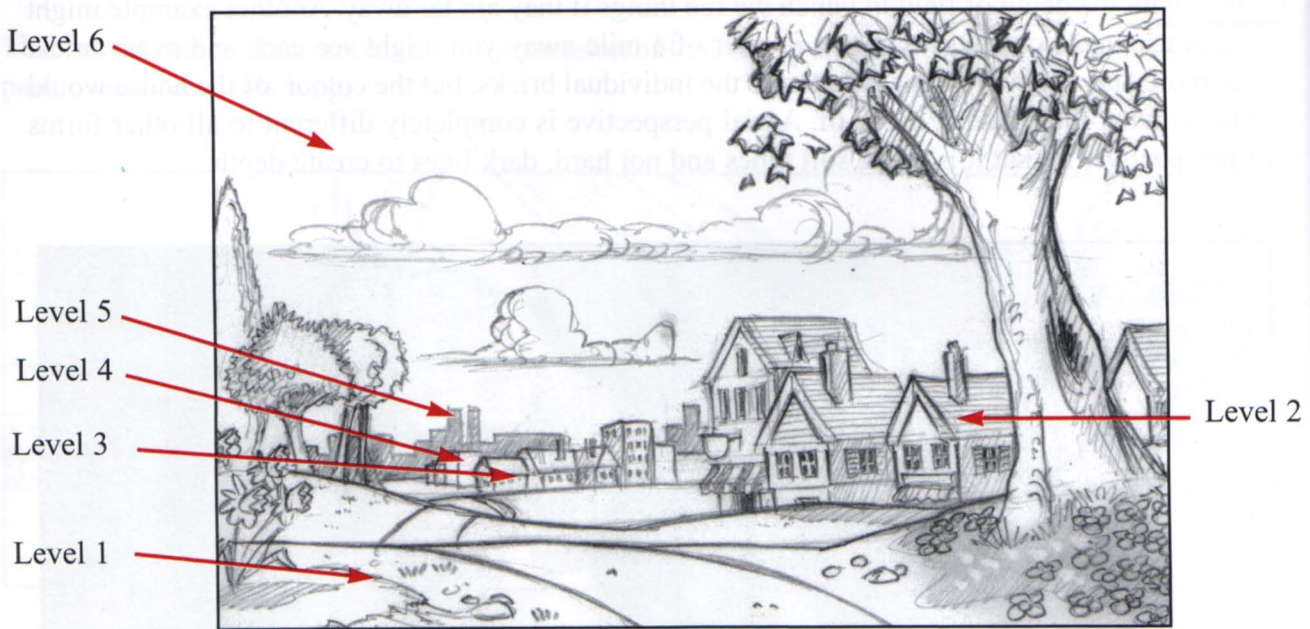

Level 1. Foreground has lots of detail, leaves on flowers, pebbles on the ground, bark on trees etc.

Level 2. Quarter mile away. Layers of foliage on trees, details on windows, signs (but not the writing).

Level 3. About a mile away. Windows and doors but no detail, no signs, silhouette of trees.

Level 4. Two and a half miles away. Outline of buildings with perspective. Few extras (windows etc.)

Level 5. Horizon. Only outline and in silhouette. No detail at all.

Level 6. Sky.

As with most things, these are approximate distances and guides and shouldn't be taken as complete and absolute.

e. When a
w far it is
an object
us it will
They are

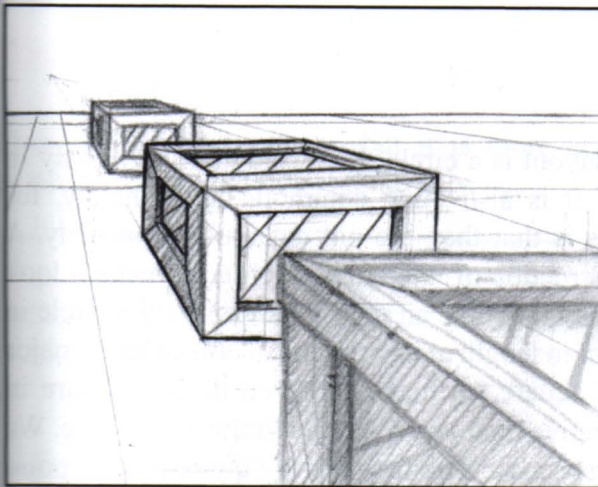

Objects very close to, and far away from the camera are often drawn and painted as soft focus. The rule of thumb with regard to focus, is that it belongs near the action. If there is a character standing beside the box in the foreground, the box would have to be in focus. The eye sees soft contrast and light lines as being far away.

level 2

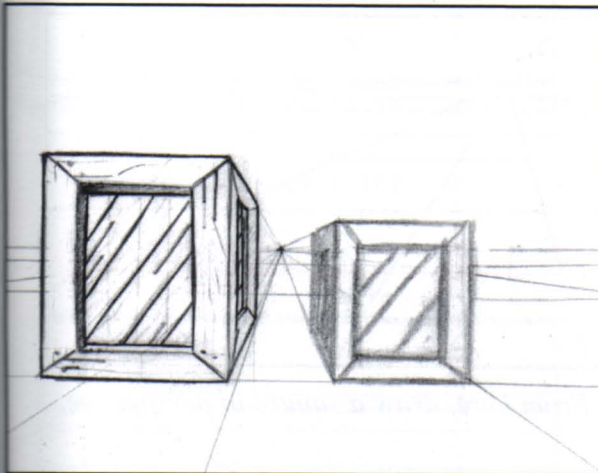

Here we see a trick of the light. The box on the left looks to be closer to the camera because the lines are darker and the detail is more clear. If you look closely, you will notice however that the two boxes are, in fact, on the same grid line. In a TV studio where layouts are usually done as line drawings, a simple note on the layout will let the background artist know that the background has to be painted soft focus. A layout artist in a feature studio will probably be lucky enough to render the layout as a monochrome version of the final background.

s etc.

writing).

ws etc.)

complete

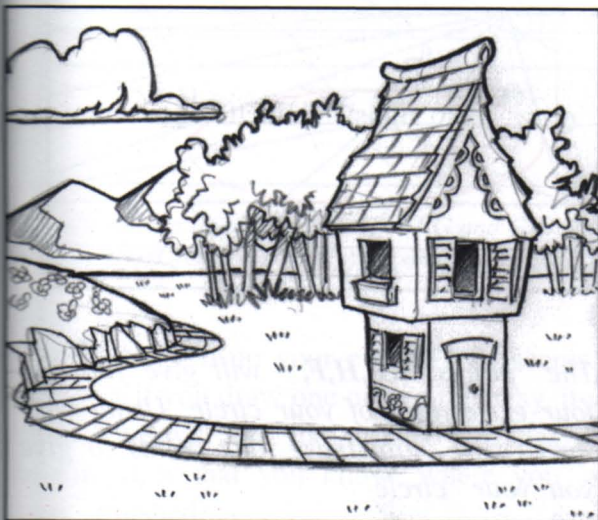

Outlining everything in black will destroy the perspective. The eye sees hard, sharp, black lines as being near. Here, the eye would read the mountain as being as near as the house.



Circles in Perspective

One of the most common shapes to be found in a layout is a circle. It is used quite obviously in anything cylindrical; barrels, lampposts, pots etc. It is also quite common, unfortunately, for circles to be drawn incorrectly. The reason for this is that they are not constructed properly. A certain amount of time needs to be put into the construction of the circle in order to make it look like a circle *in perspective*. A circle in perspective may look like an ellipse, but it is still a circle in perspective. A circle has a diameter which is identical in length at any point. An ellipse has a major and minor axis. A circle can fit perfectly inside a square, so make sure you draw a square in perspective. If you want to draw an ellipse in perspective then you must first draw a rectangle. We will look at two methods of drawing circles in perspective. The first is the "quickie" four point method, the second is a more accurate eight point method.

4 point method.

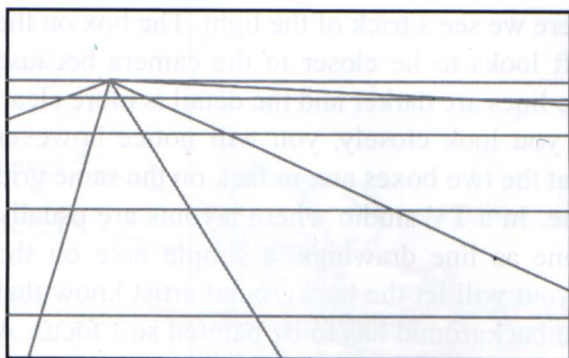

Begin by drawing your grid. The same rules apply irrespective of which type of perspective you use.

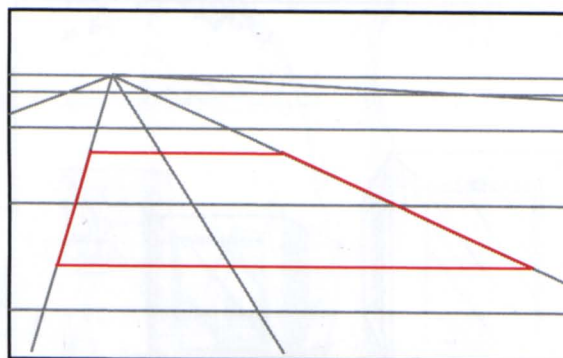

From here, draw a square in perspective.

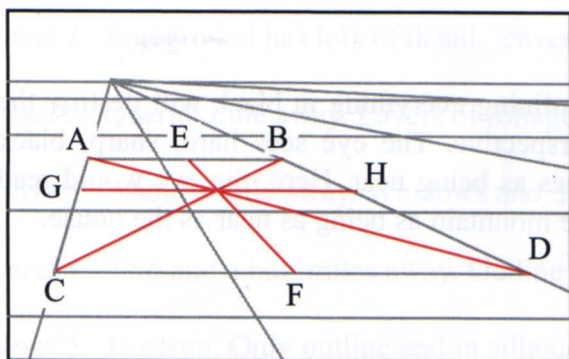

Join corners **A-D**, **B-C** to get the centre-point, then bring a line from the vanishing point through the centre to give you **E,F** and finally a line through this centre parallel to the horizon to give you **G,H**.

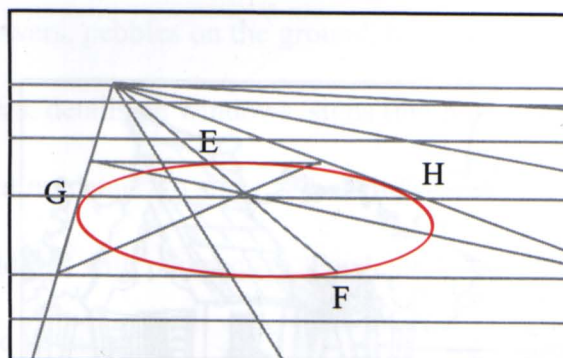

The points **G,E,H,F**, will give you the four extremities of your circle. Using your 'artist's eye', join these four points to give you your circle

Eight Point Method



This method takes longer, but it is more accurate! Begin as before by drawing a square in perspective and dividing it up evenly.

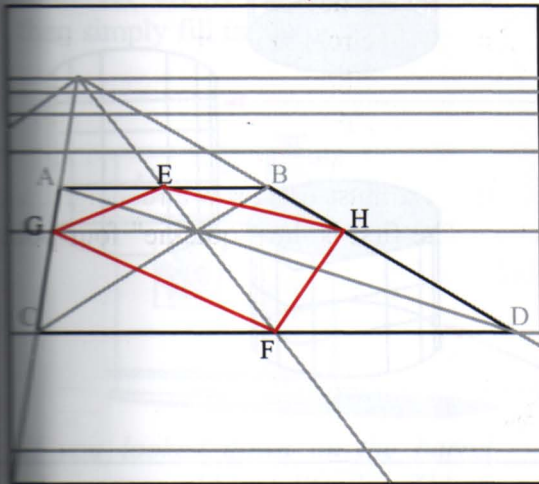

Join H-F, H-E, G-E, G-F.

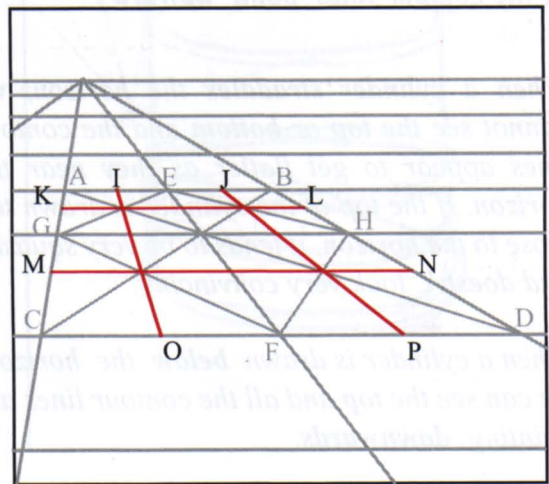

Where these lines cross, you need to bring a new line from the vanishing point and a line parallel to the horizon line so you end up with the following diagram. Call these I-O and J-P, K-L, M-N.

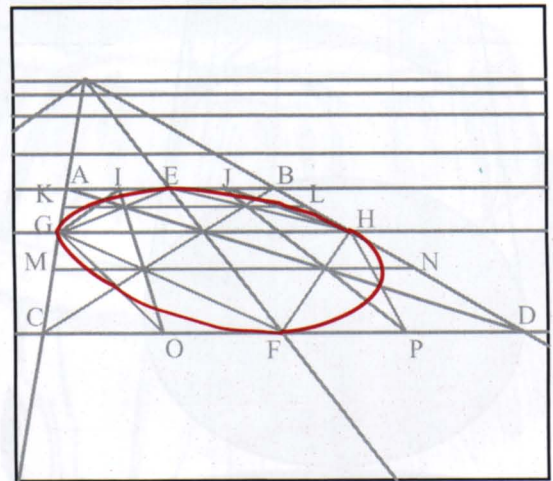
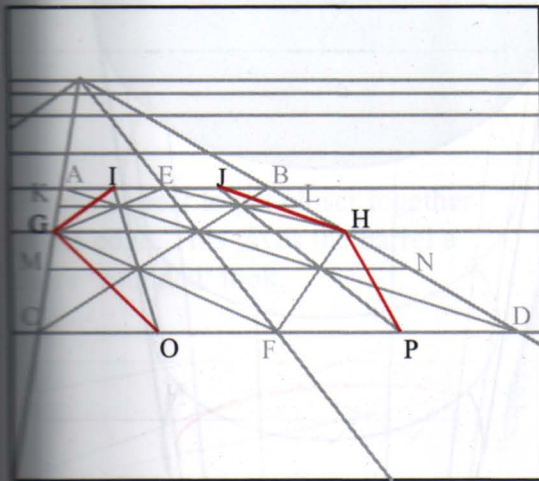

Finally, draw a line from J-H, H-P, I-G and G-O. Your points are: E,F,G,H. and where the lines intersect at (H-P, A-D), (G-O, B-C), (G-I, A-D) and finally (J-H, B-C).

From here, join up your circle! This seems to be a very convoluted way of drawing a circle. However if you draw one or two this way, it will become second nature to you and your circles in perspective will look like circles. You may if you wish mark your circle A,B,C,D etc. as you are drawing it, so that you know where you are. You can then erase these letters when you have finished.



Cylinders

When a cylindrical object is placed **above** the horizon, we can see the underside. All of the contour lines point **'upward'**.

When a cylinder **straddles** the horizon, we cannot see the **top** or **bottom** and the contour lines appear to get flatter as they near the horizon. If the top of the cylinder is drawn too close to the horizon, it tends to be very squashy and doesn't look very convincing.

When a cylinder is drawn **below** the horizon, we can see the **top** and all the contour lines are pointing **downwards**.

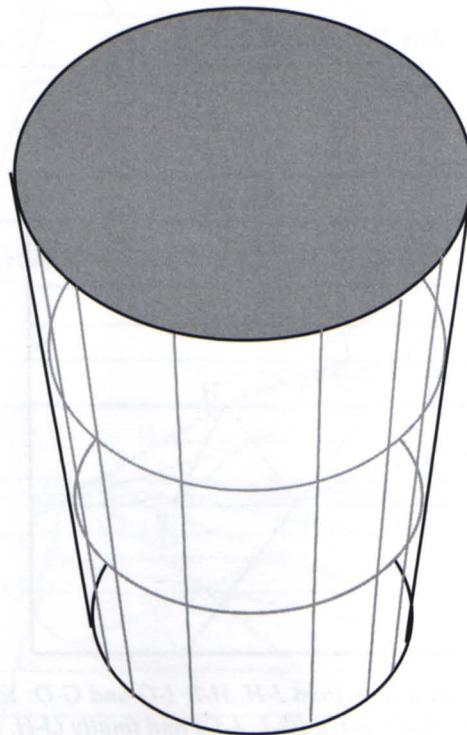
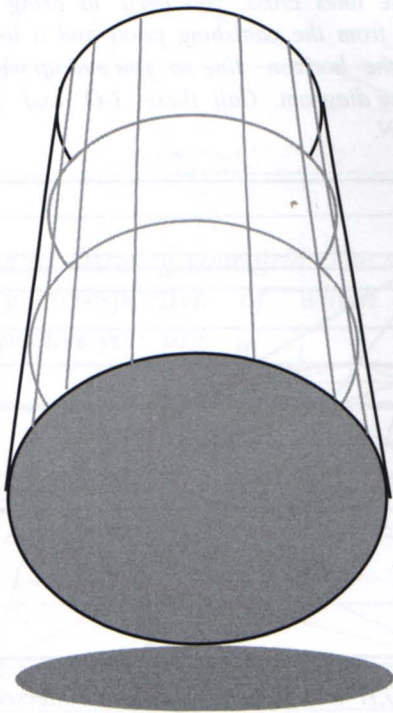
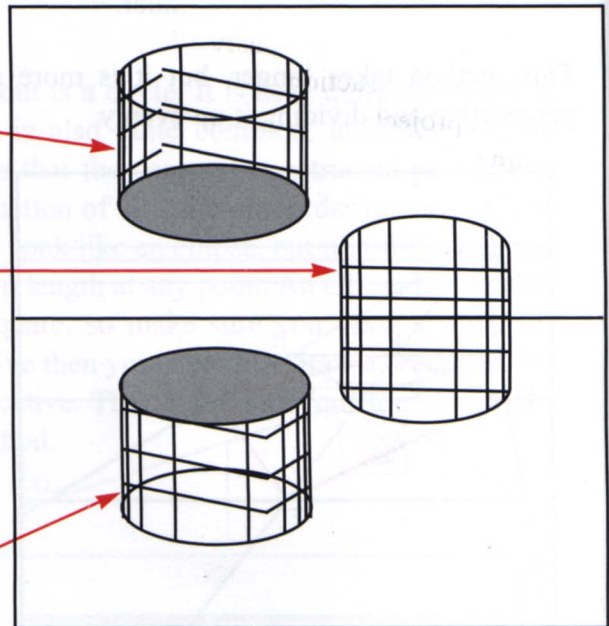

When a cylinder is resting on its edge, the contour lines will follow the shape of the top or the bottom of the cylinder depending on which way it's lying.

To draw an accurate cylinder, use the methods previously described in the construction of a circle. From there, project the lines up and do the same for the circle at the top, and then simply fill in the lines.

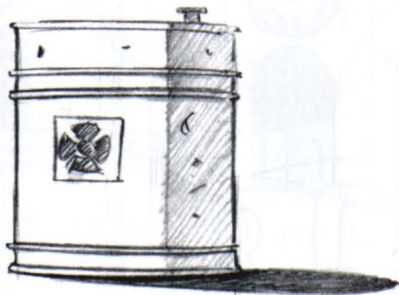

If you looked down on the barrel above, it would look like this. This is the result of poor construction.



Planks appear to get closer together at the edge. This gives the barrel a more 'rounded' look.

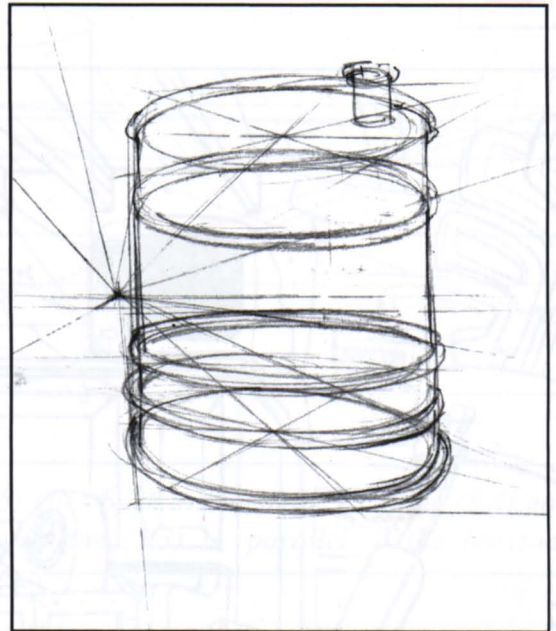
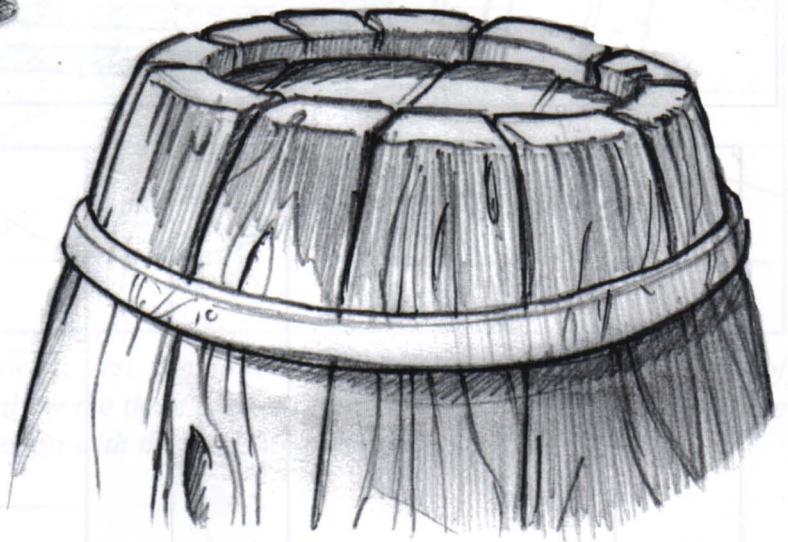

Lightly sketch all construction lines.

All of this cylinder drawing looks very complicated, and indeed it can be. A seasoned layout artist however won't have to go to the bother of dividing up squares etc. He will be able to construct a circle in perspective by eye. For the beginner though, I recommend using the proper form of construction until you are quite proficient, even if its only the four point method. It won't be long before you get a feel for drawing circles in perspective and it will soon become 'old hat' to you. Be warned though, that a badly drawn cylinder can look truly awful.

Spiral Stairs

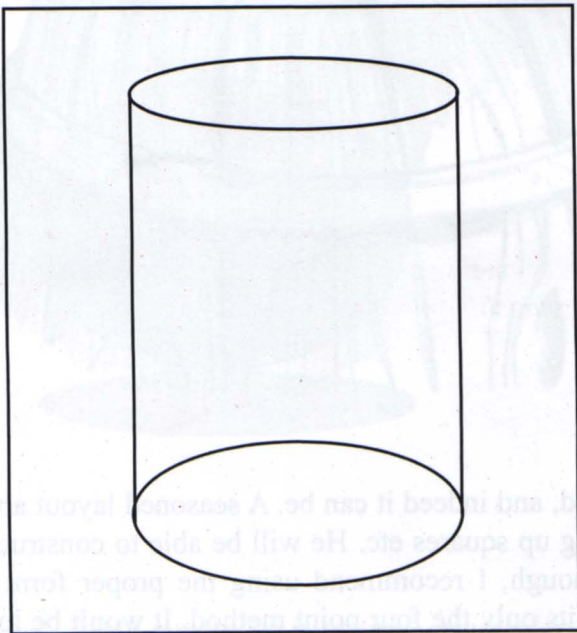
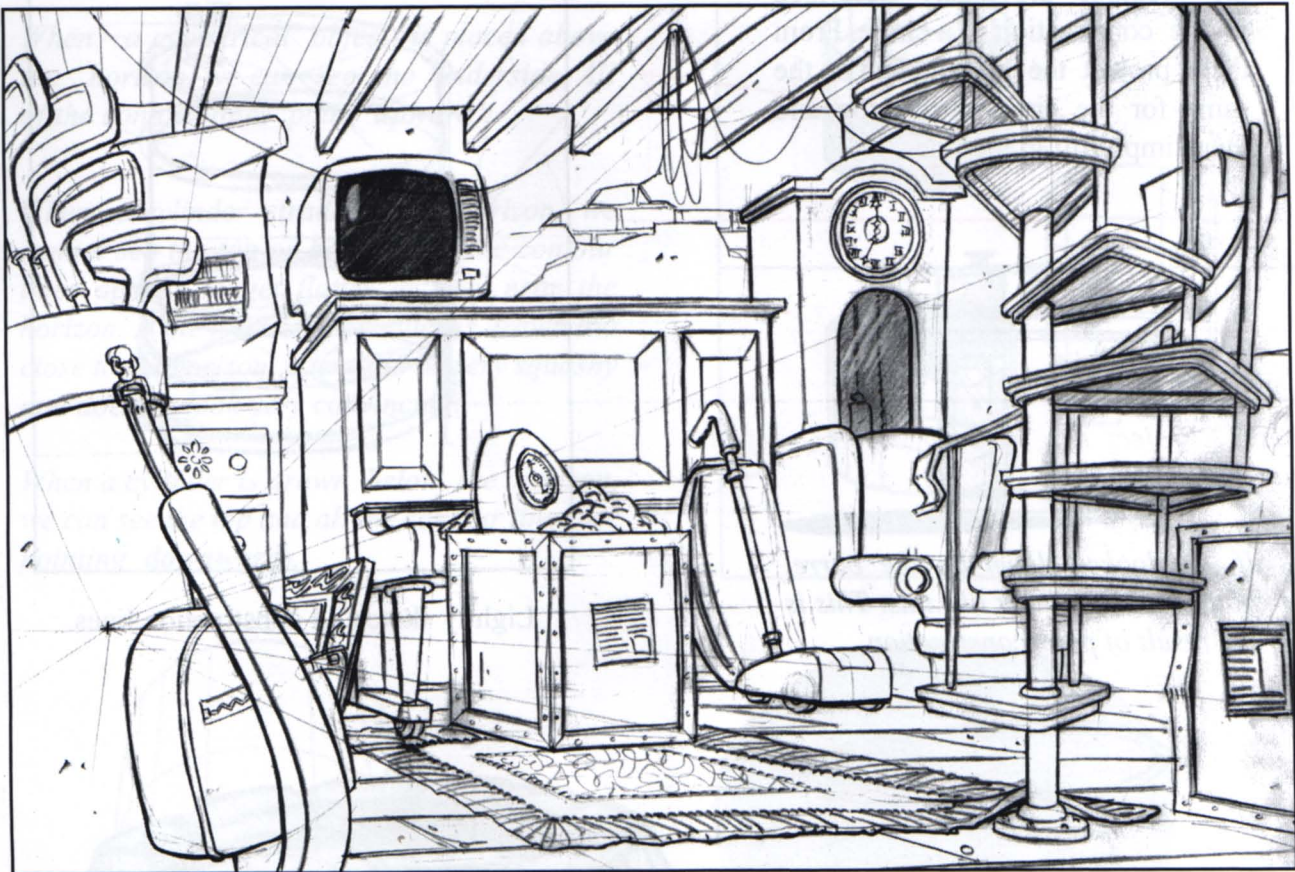

Step 1. Construct a cylinder that your stairs will fit in to.

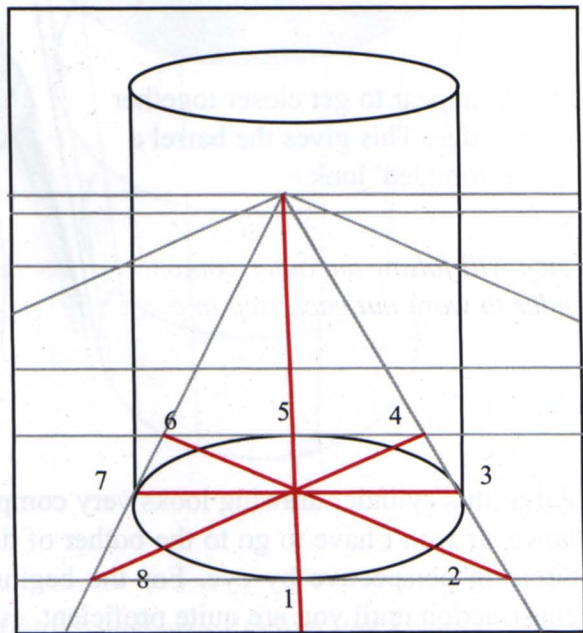

Step 2. Divide up the base into eight equal segments and number the segments.

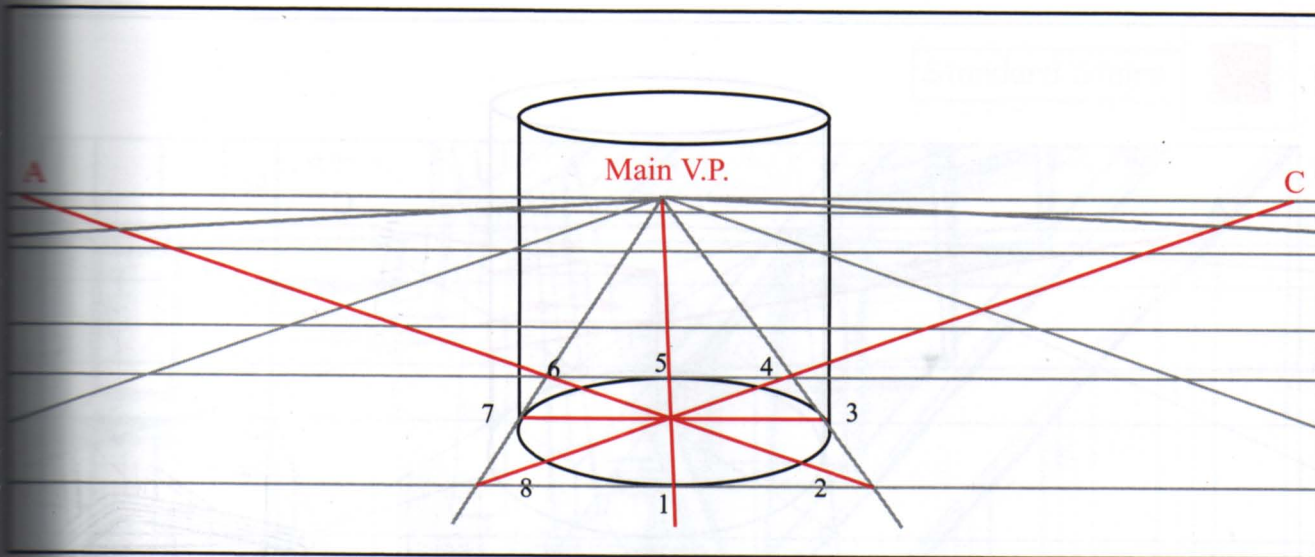

Step 3. Project the lines back to the horizon. Line (1,5) goes back to the main V.P., line (8,4) goes back to V.P. (C), line (2,6) goes back to V.P. (A) and line (7,3) is parallel to the horizon.

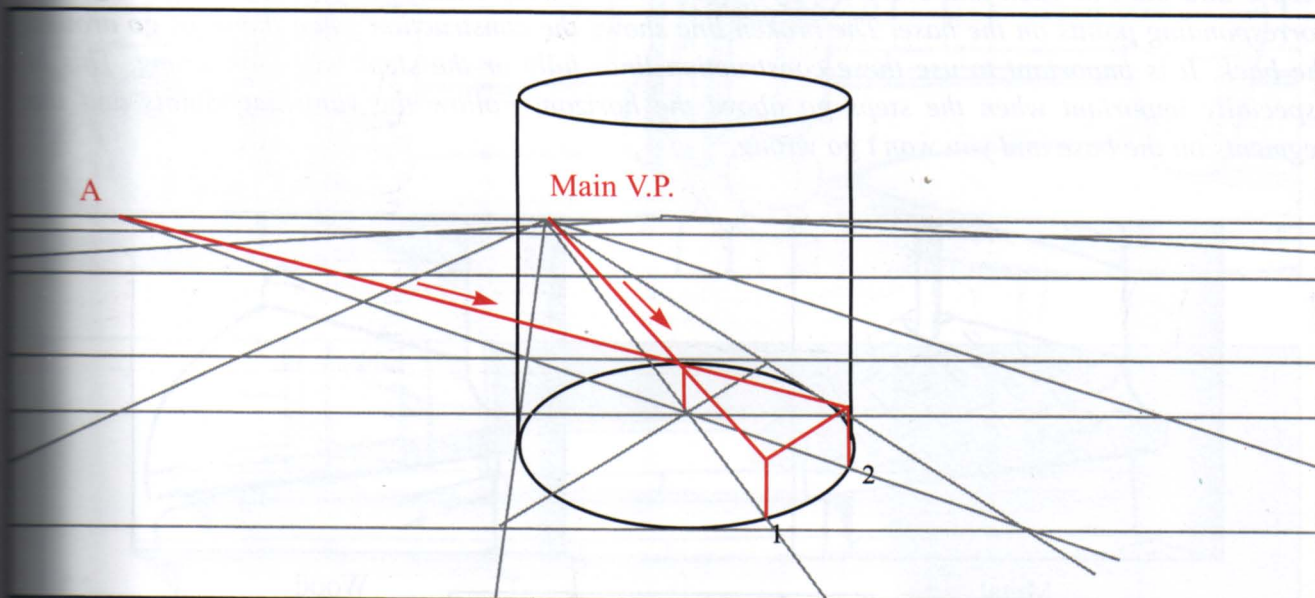

Step 4. Starting with segment (1,2), draw the first step to whatever height you require. The curve of the step will follow the outer contour. Follow the three segment lines for each step on the base of the cylinder to work out each step in conjunction with the vanishing points.

Always follow the baselines and the V.P.'s that they go back to. From the second step on you will have to project the lines for the height of each step up from their point at the base. Drawing spiral stairs can be quite frustrating, but if you follow these steps and diagrams, then with a bit of practice you will be able to do them in your sleep. The above is a general example of how to draw spiral steps. Once you have the basic construction done, you can make them look like they're made of stone, wood, metal or whatever.

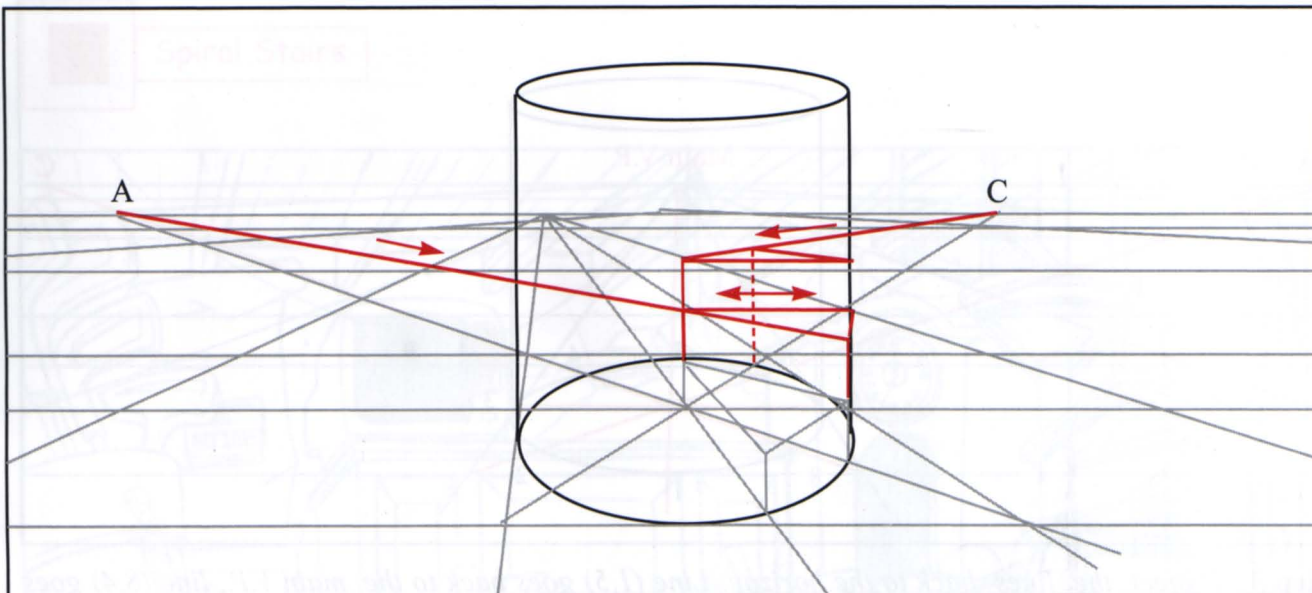

Step 5 and on. For each and every step, you must take a line from the vanishing point through the corresponding points on the base. The broken line shows the construction when the steps go around the back. It is important to use these construction lines fully or the steps will look wrong. This is especially important when the steps go above the horizon. Follow the vanishing points and the segments on the base and you won't go wrong.

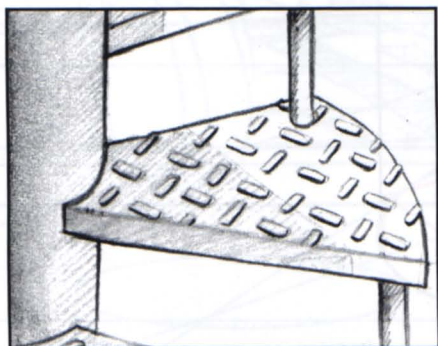

Metal



Wood

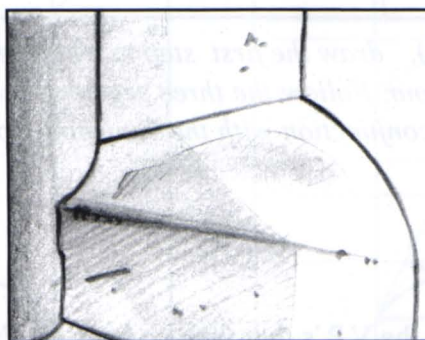

Stone

Finish the steps by adding a second cylinder inside the original one to whatever diameter you require. The inside contour of the steps will follow the contour of the new cylinder. The steps themselves can be made out of wood, metal or stone.

Standard Stairs

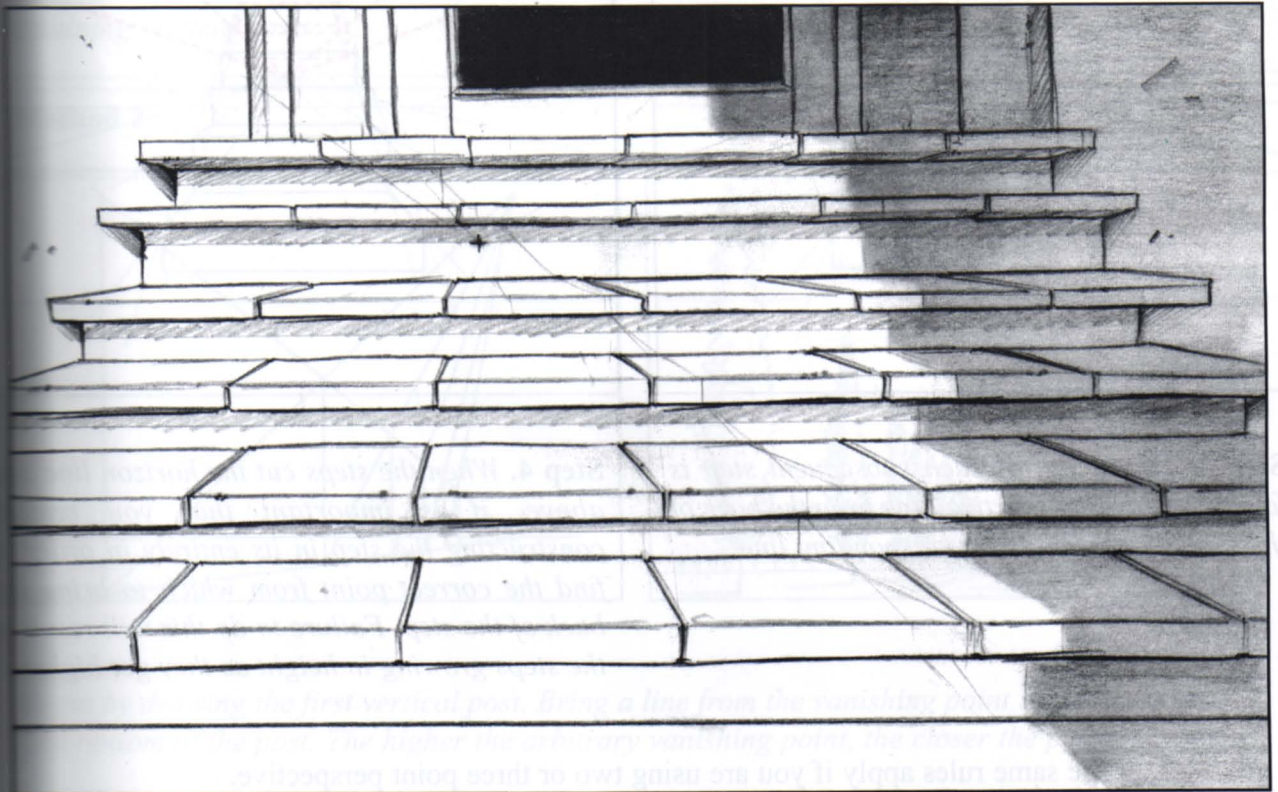

gh the
around
This is
nd the

quire.
es can

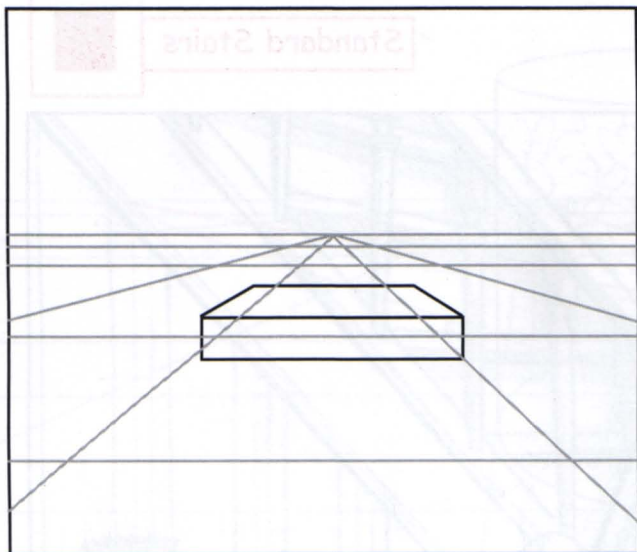

Step 1. Draw your first step to the height and depth that you'd like it. Make sure it fits with the animation poses if any.

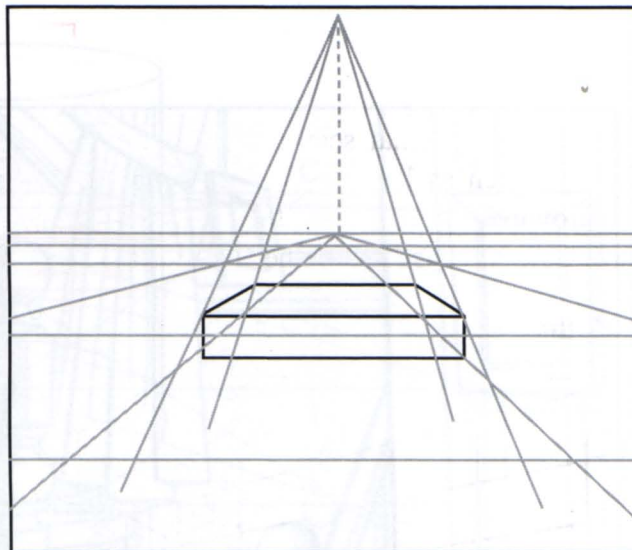

Step 2. Draw a line from an arbitrary vanishing point above the horizon, through each point at the top of the step. I'd strongly advocate the use of a ruler for this.

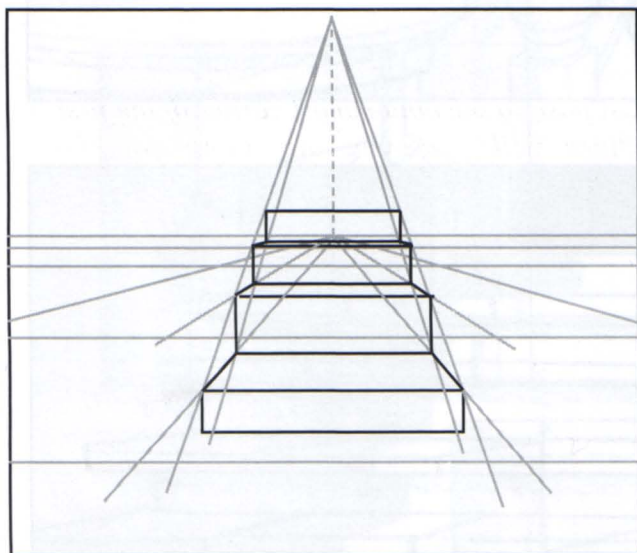

Step 3. The height of each subsequent step is found by drawing a vertical line from the back of the step, up to meet the corresponding line.

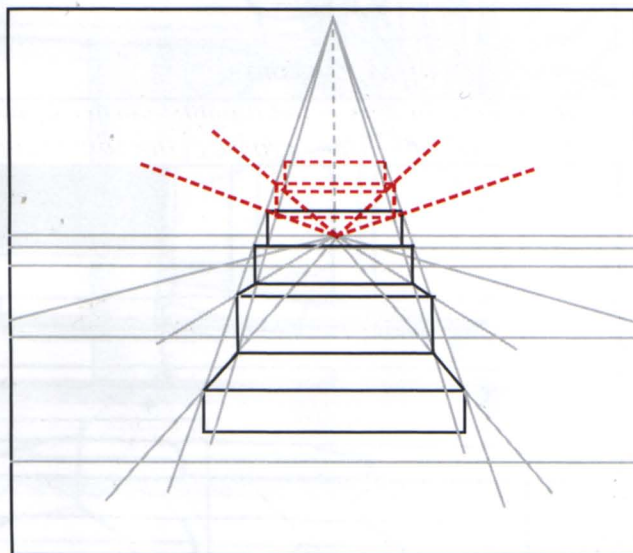

Step 4. When the steps cut the horizon line and above, it is important that you remain constructing the step in its entirety in order to find the correct point from which to bring the back of the step. Failure to do this will result in the steps growing in height as they get higher.

The same rules apply if you are using two or three point perspective.

Drawing Parallel Objects in Perspective



Layouts of external scenes are commonplace. Quite often they are going to contain man-made objects such as lampposts, fences etc. Failure to work out the correct perspective for these can destroy the overall look of the picture. To draw a fence, first decide how many vertical elements you want, then choose where the first and last ones will go.

Method 1

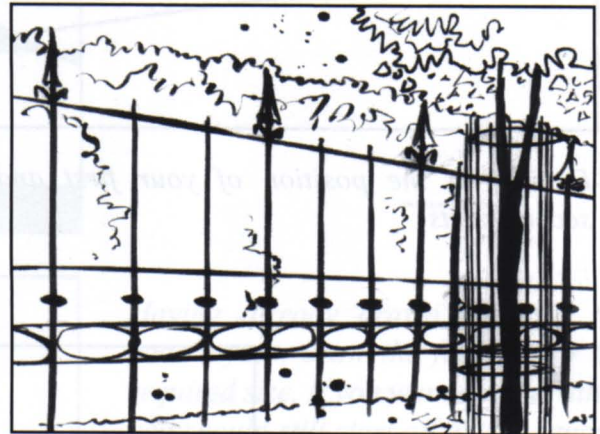
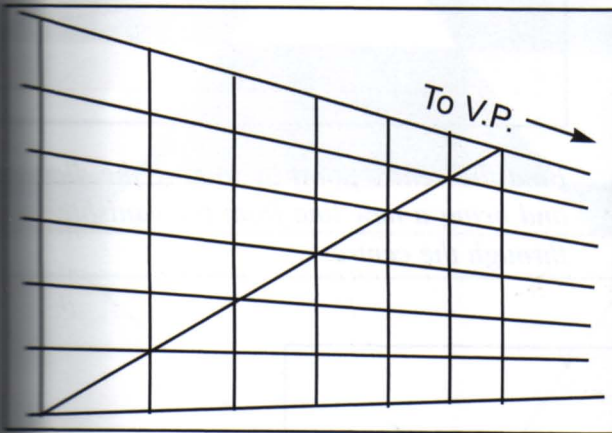

Mark off five equal divisions on the first post, then project these points back to the vanishing point. Draw a line from the topmost corner of the last post, to the bottommost corner of the first post. Where the line crosses the divisional lines will give you the points for the remaining vertical posts.

Method 2

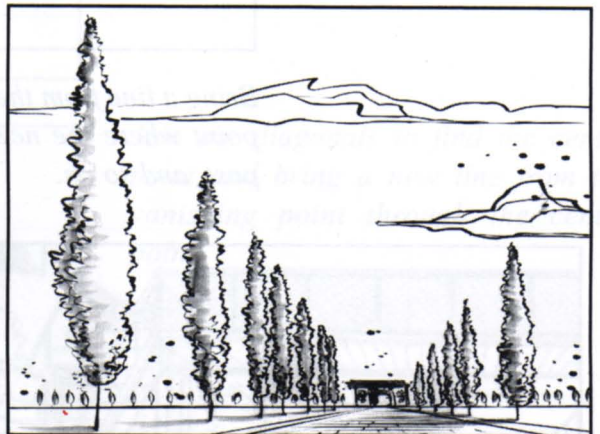
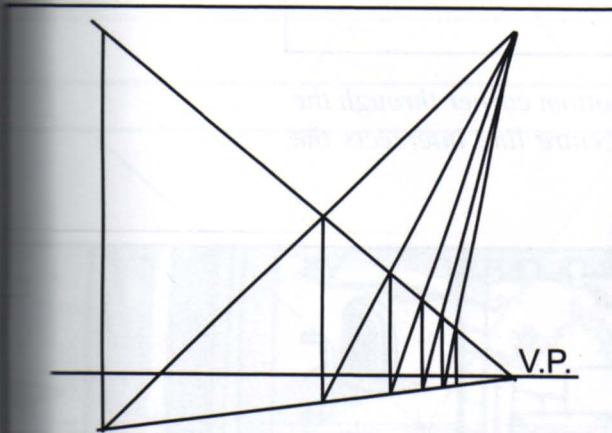

Begin by drawing the first vertical post. Bring a line from the vanishing point through the top and bottom of the post. The higher the arbitrary vanishing point, the closer the posts will be.

Here's another method.

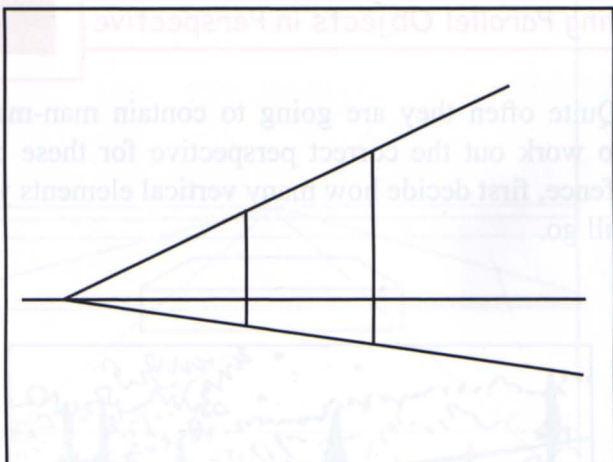

Decide on the position of your first and second posts

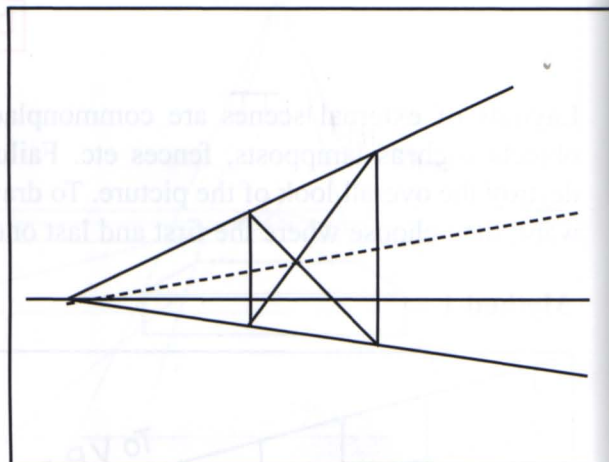

Find the centre point by joining the diagonals and bring a new line from the vanishing point through the centre.

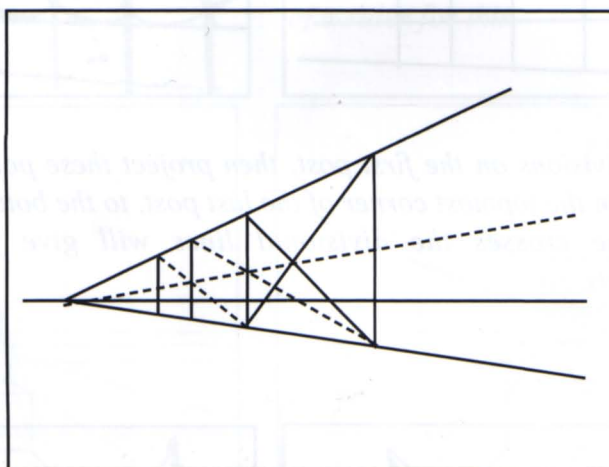

Bring a line from the bottom corner through the point where the new centre line intersects the post, and so on.

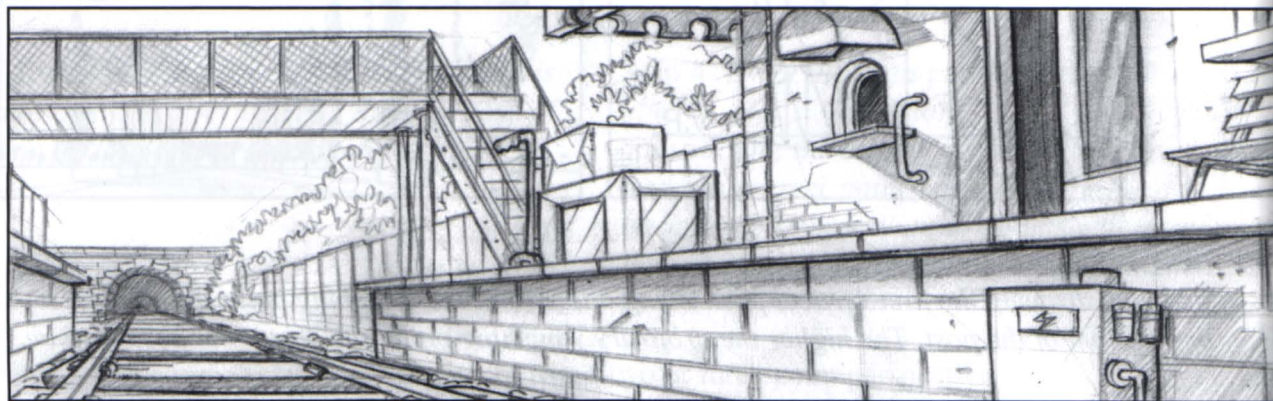

Tiled and Patterned Floors

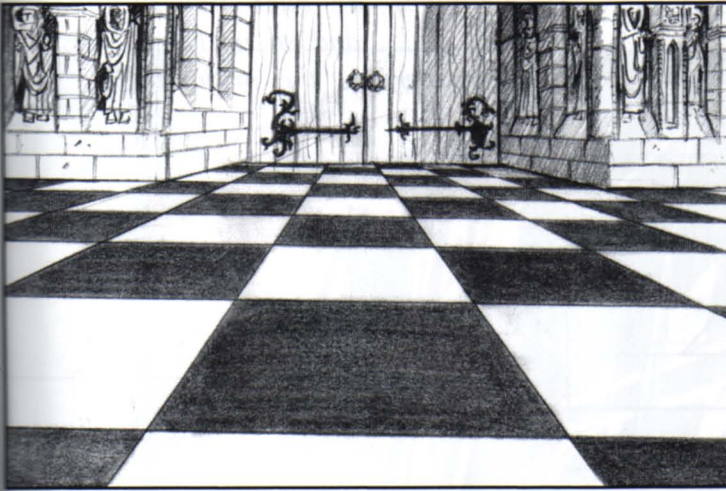

Tiled floors don't always have to have square tiles, they can be oblong or even circular. The technique for drawing them however remains the same.

diagonals
ing point

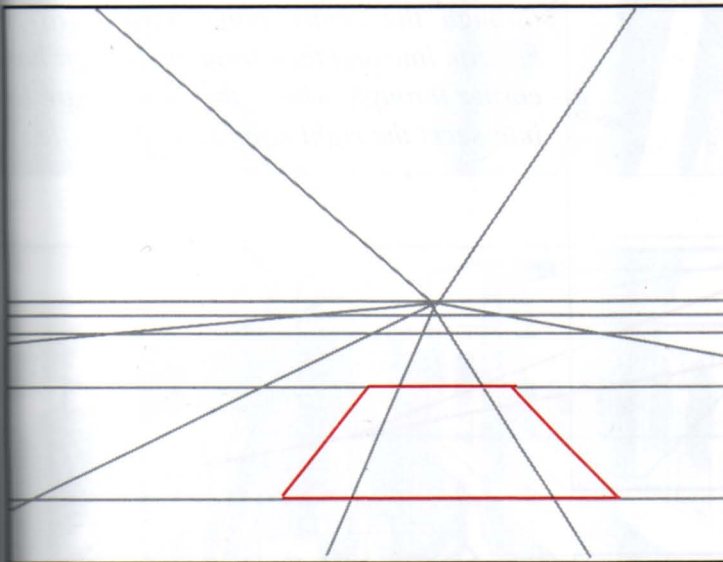

Having already drawn the grid for your layout, draw the first tile to the required size. If you want circular tiles, you should still start off with a square.

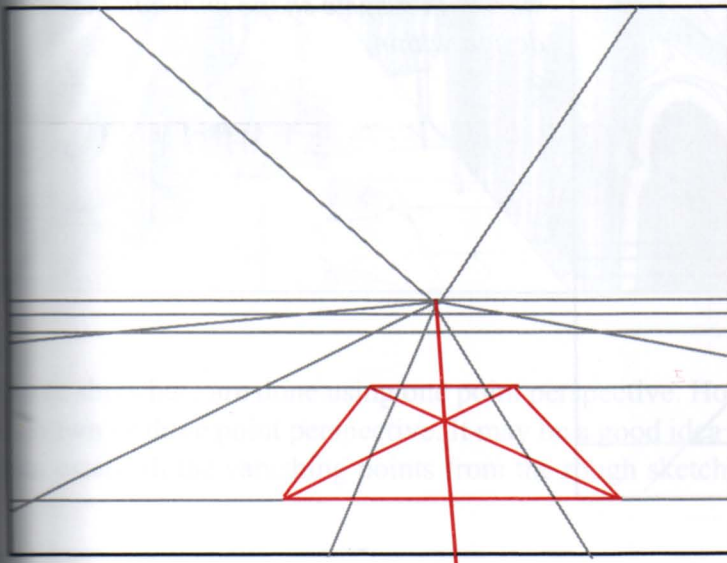

Join the diagonals to find the centre point and bring a new line from the vanishing point through the centre point.

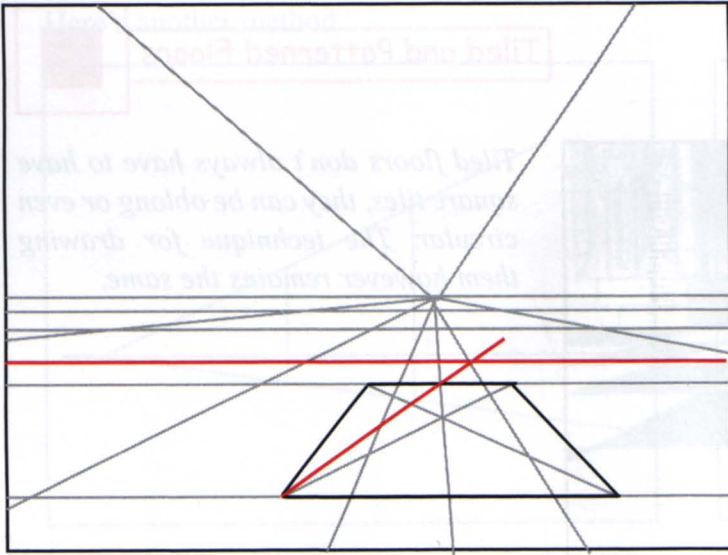

Draw a line from the bottom left hand corner through the point where the new centre line intersects at the top of the tile. This gives the back line of the next tile.....and so on. These lines will then supersede the original grid lines.

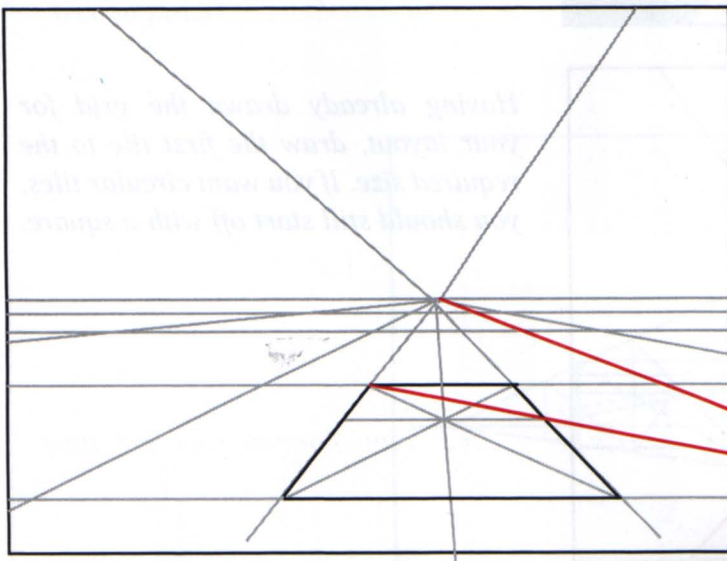

To get the tiles on either side, bring a line through the centre point parallel to the horizon line and then from the top left hand corner through where the new centre line intersects the right hand side of the tile.

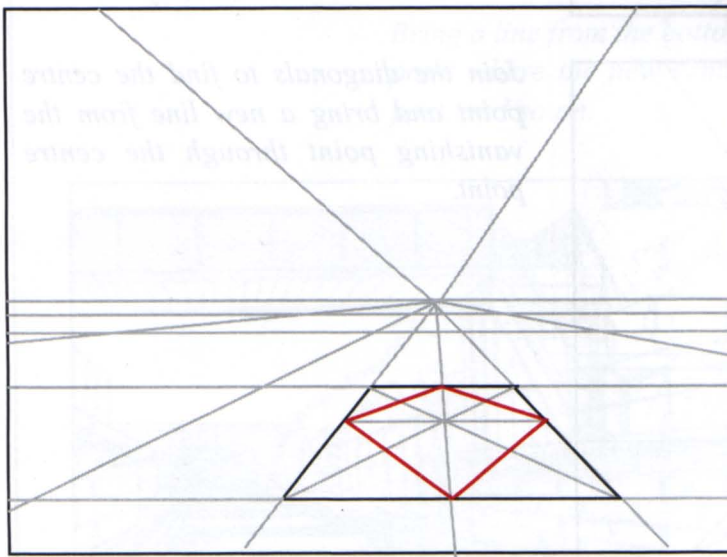

When you are doing a different design, start with a basic shape and add the new design within.

Hills

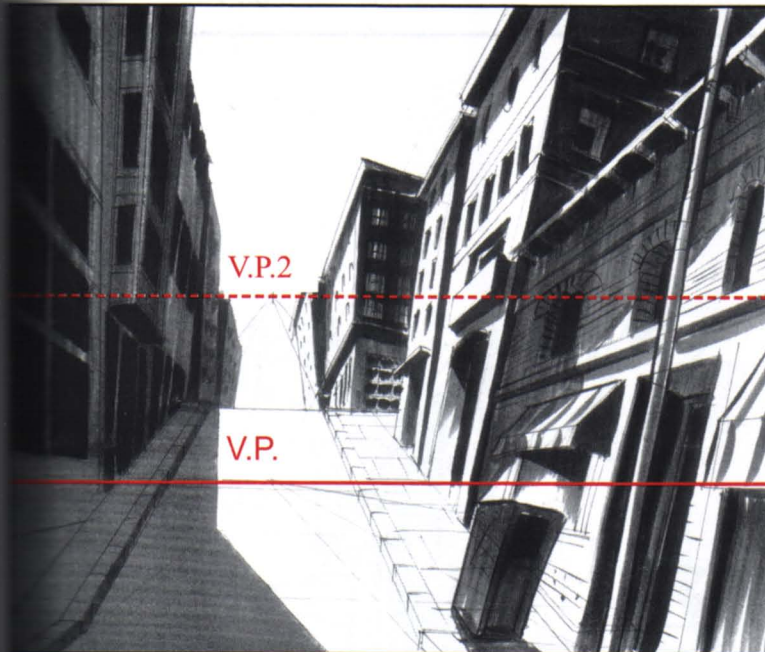

Uphill

Although we have two vanishing points here, this shot is still one point perspective. The main vanishing point (V.P.) is located on the 'real' horizon line (full red line). V.P.2 is used to get the angle of the hill only, and is located on the artificial horizon line (broken red line). If you have a second hill going off in a different direction then it will have a different vanishing point (V.P.3) and so on. The higher you place the vanishing point above the horizon, the steeper the hill will be.

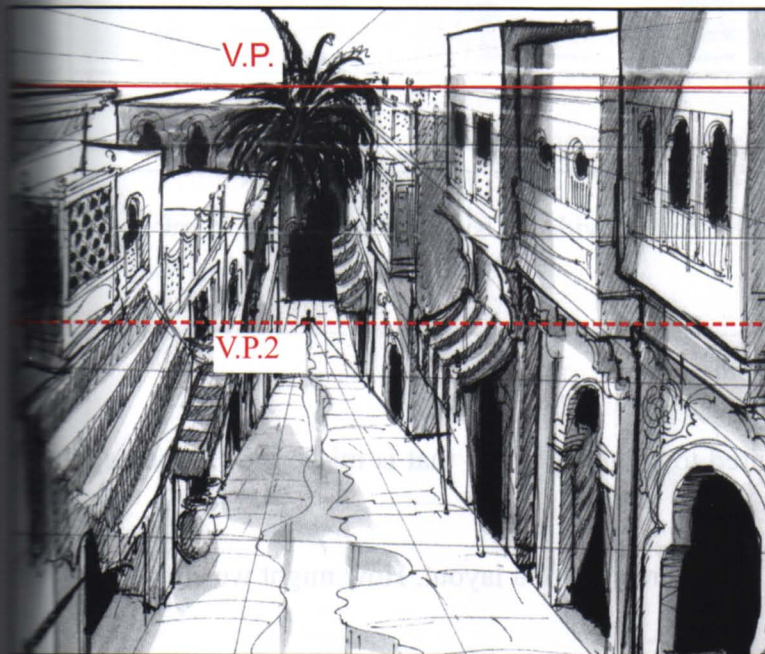

Downhill

Similarly for a downhill shot, the main vanishing point is located on the 'real' horizon (full red line). The second vanishing point is located on the artificial horizon line. This is arbitrary, and its location depends on the angle required on the hill.

These shots here are done using one point perspective. However, the same rules apply to scenes done with two or three point perspective. It may be a good idea to sketch out the hill at the angle you want, then establish the vanishing points from the rough sketch.



Assignment

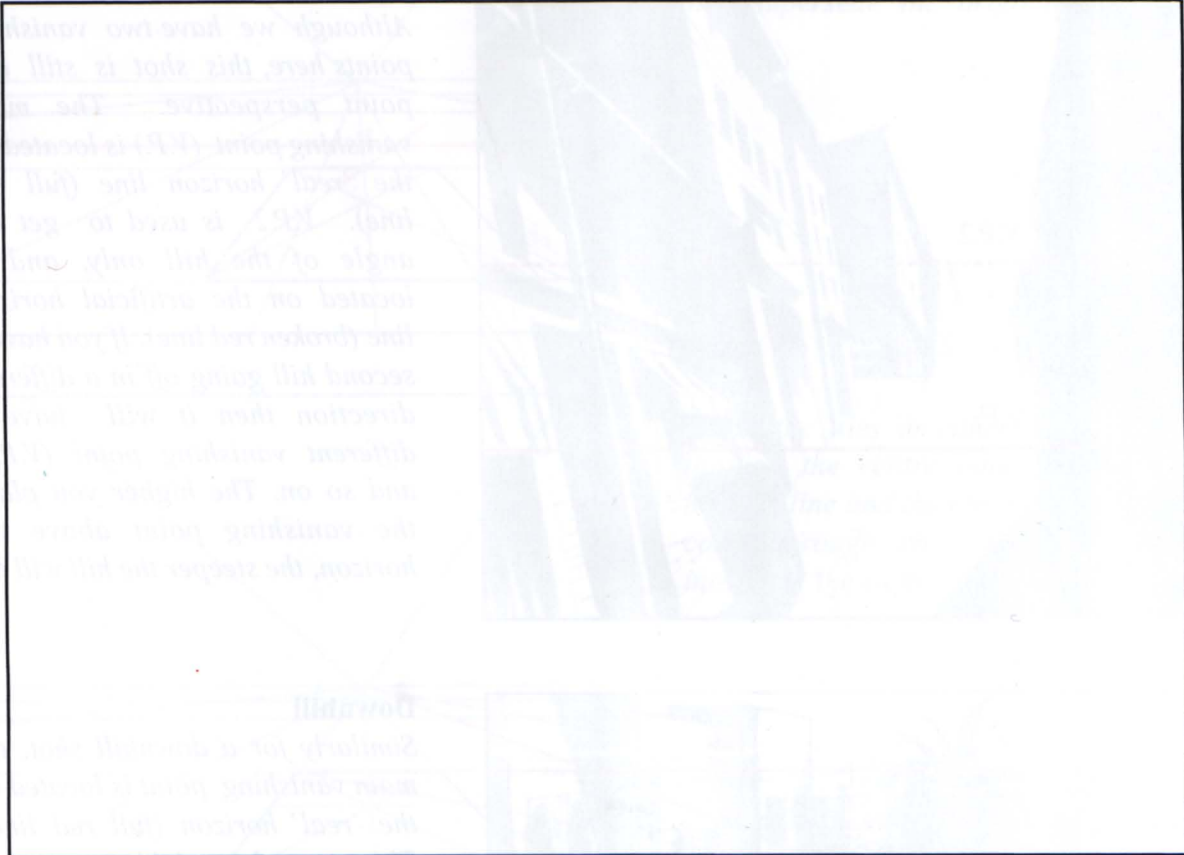

Draw a one point perspective grid in the box provided. Using the same grid, draw a box turned at an angle of your choice.

Answer the following questions orally.

1. What is the essential element required to create a layout, that is missing from the page that we draw our layout on?
2. The "illusion of space" is essential in the creation of a layout. How might we create this illusion?
3. What is the essential difference between Aerial perspective and the other forms of perspective?
4. What problems might be caused by placing both vanishing points on the picture plane, on a two point perspective layout?



Complete the layout above by adding in props of your choice. Begin by establishing the vanishing point. Then complete the remainder of the layout. Try to match the line-work and rendering shown. Use the boxes below for thumbnails.

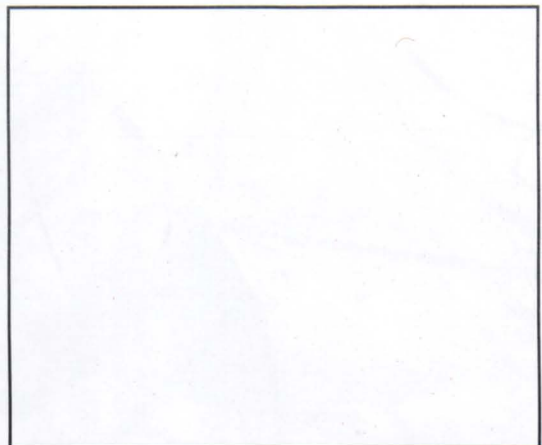

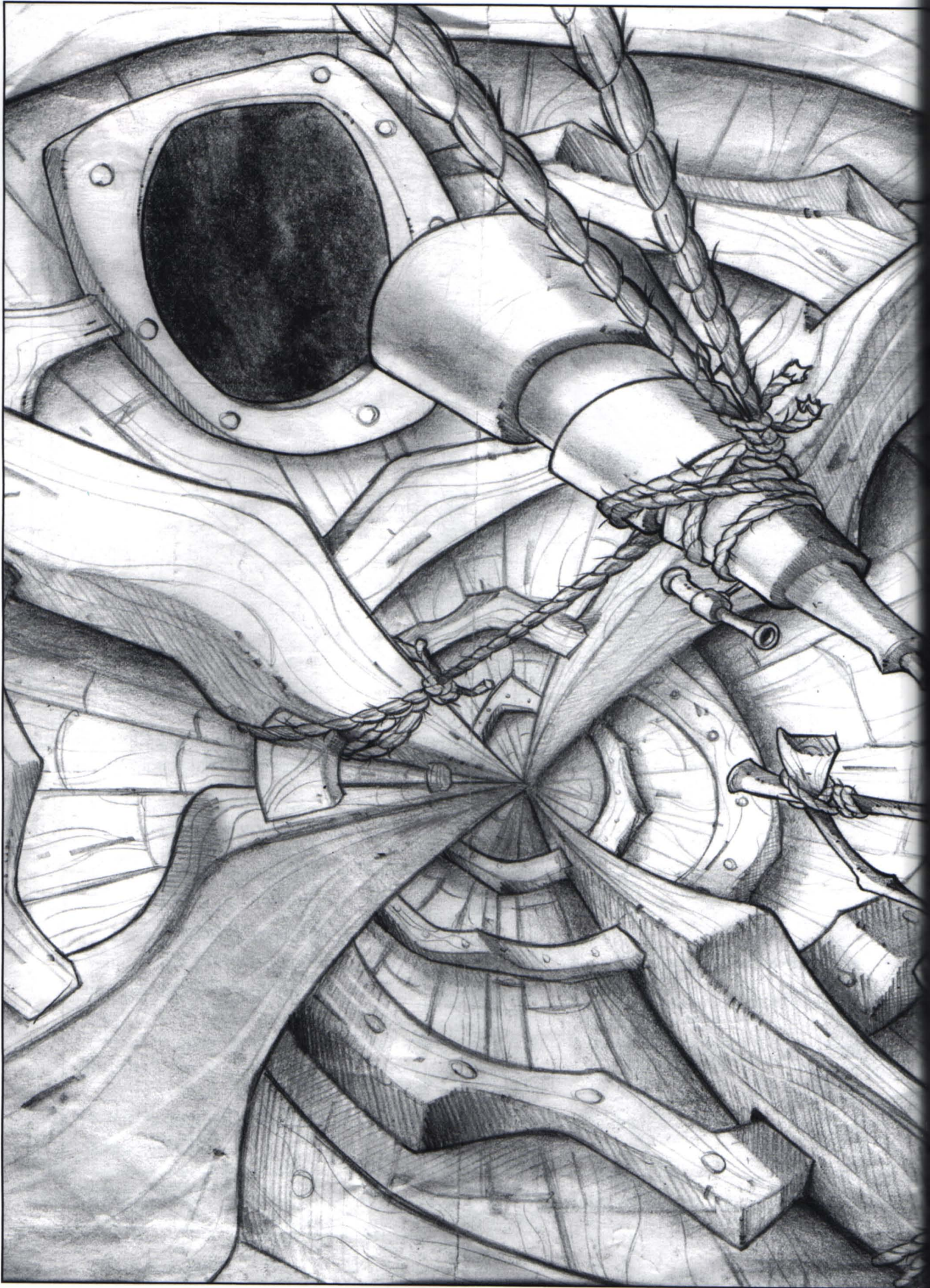



Pans

Panning shots give the illusion that a character or object is moving on a background. They can be used to give a more panoramic view of the setting and are often used as opening scenes. Whether it's a three field cycling pan on TV, or a fifty field long pan in feature animation, a pan will always breathe life into any project and break the monotony of constant stills.

Pan Paper Field Sizes

The camera can pan as little as one inch across the artwork. This would be an extremely short pan, but can be used none the less to give the audience the impression for example, that there is something happening off-screen, or perhaps to bring a prop or character into the picture. Pans are generally longer however and can be anything from one and a half fields to fifty fields or more. A pan of this length might be used for a very fast run for example, where we don't want to be running past the same backdrop time after time. A pan such as this would *never* be used in T.V. animation and only occasionally in classical.

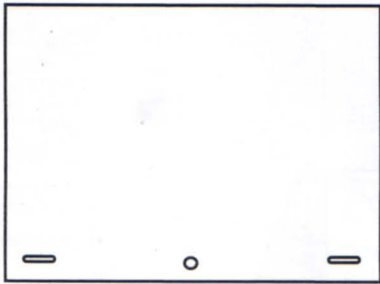

Single field or 'still'

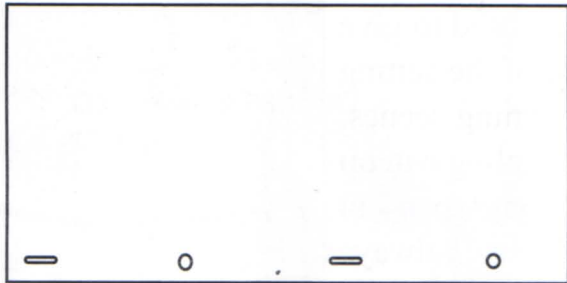

A B
1 1/2 fields or 'A to B' horizontal pan.

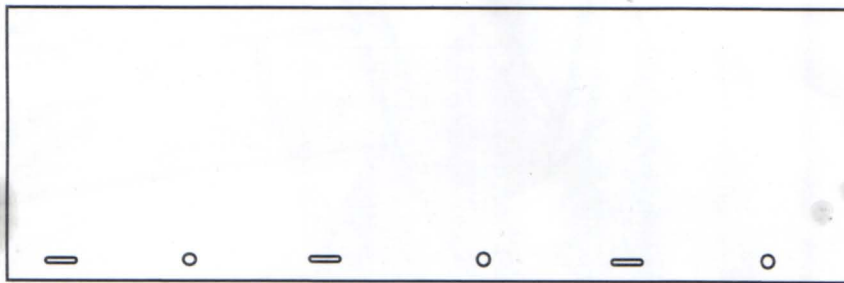

A B C
2 fields or 'A to C' pan.

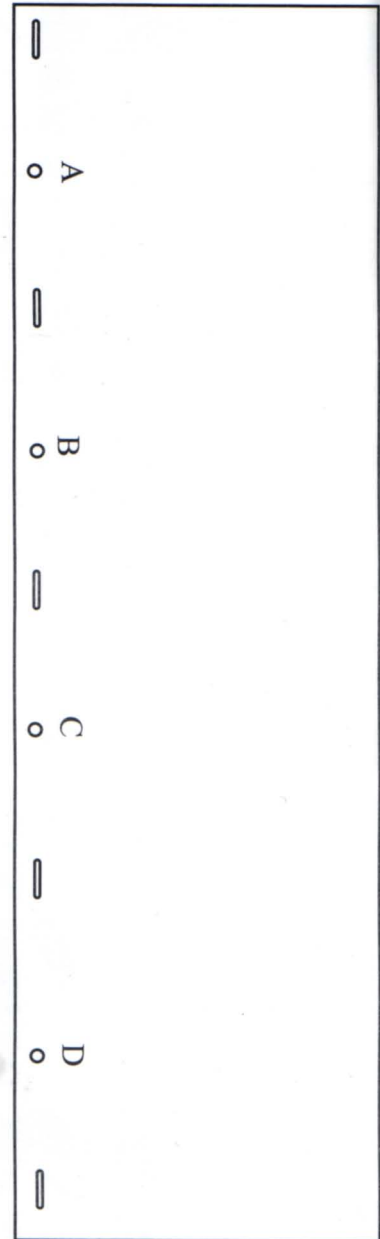

Vertical pan

Vertical Pans



Vertical pans are used to emphasise the length or height of anything from a tall building to a tree and are commonly used for scenes where characters are climbing or falling. With vertical pans, the artwork is turned on its side and the scene is drawn accordingly. The camera is turned 90° counter clockwise. On a 16 field set-up, the maximum size is 11 fi field (approx.) and on a 12 field set-up the maximum size is 8 fi field (approx.)



Here we get the illusion that the camera starts on the ground and then looks up along the building.

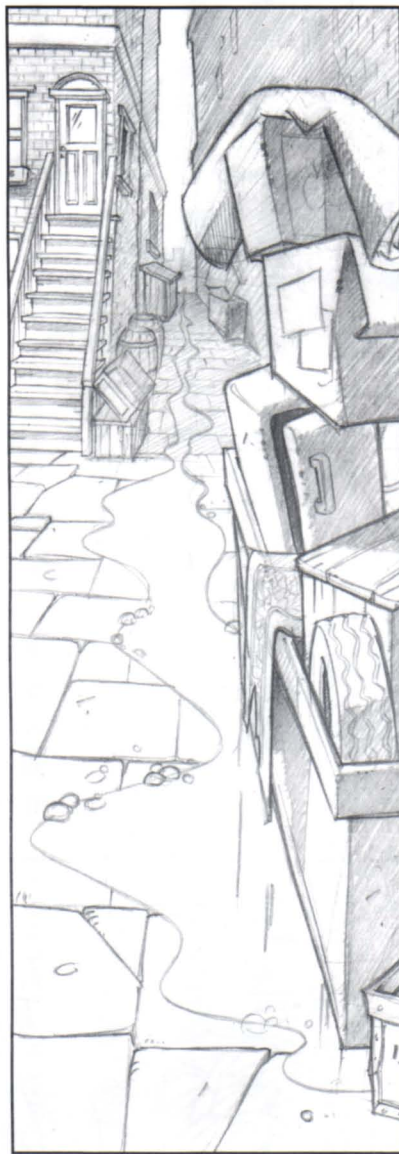

Here we get the illusion that the camera is elevated. It then looks down towards the ground.

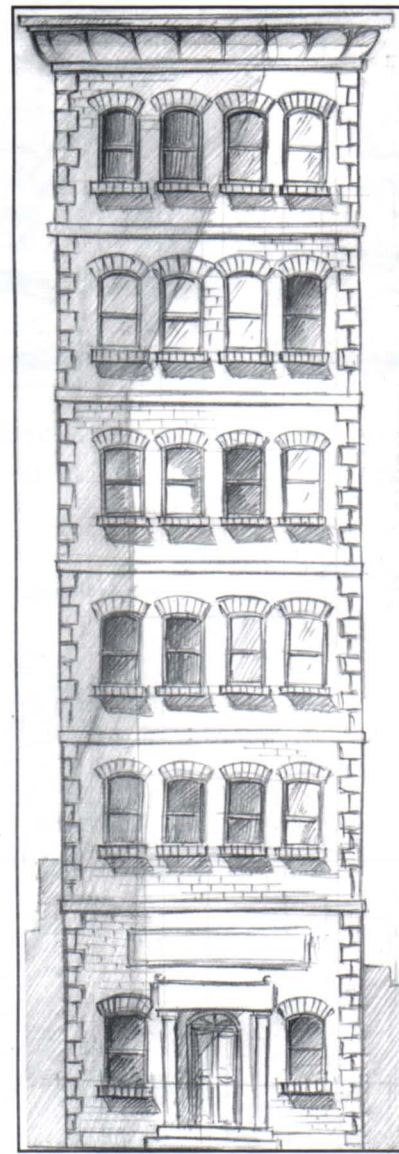

This type of shot gives the illusion that we start on the ground, then travels up along the building.

The layouts shown here are A - C. They can, of course, be much longer. The pans would be bottom pegged, i.e., the peg holes would be on the left hand side as we look at the artwork.

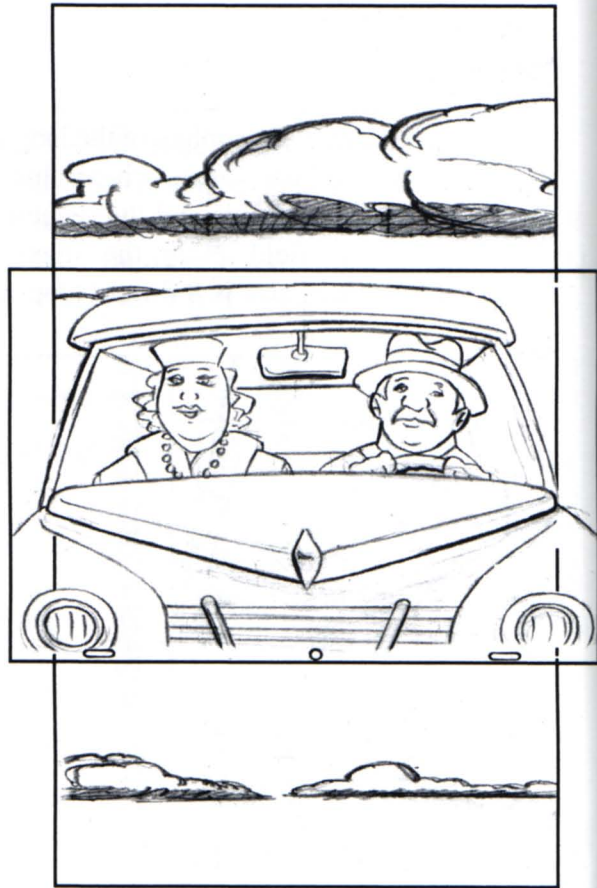
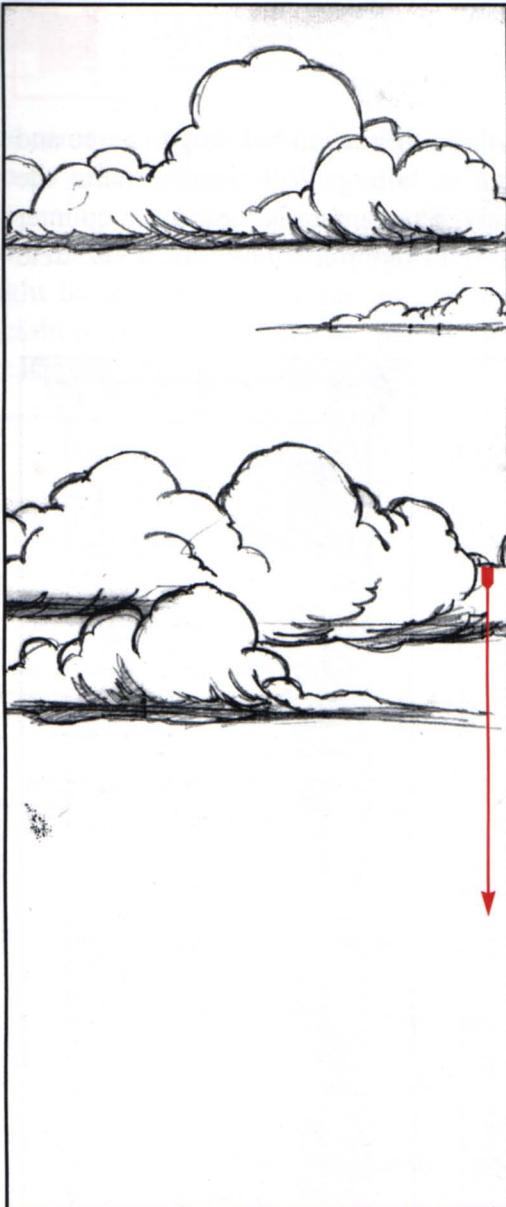

Type 1 (Above)

A slow moving vertical pan will give the impression of a fast moving vehicle when the scene is shot from the front of the vehicle. Here the car stays still and the background pans up, thereby giving the impression that the car is travelling.

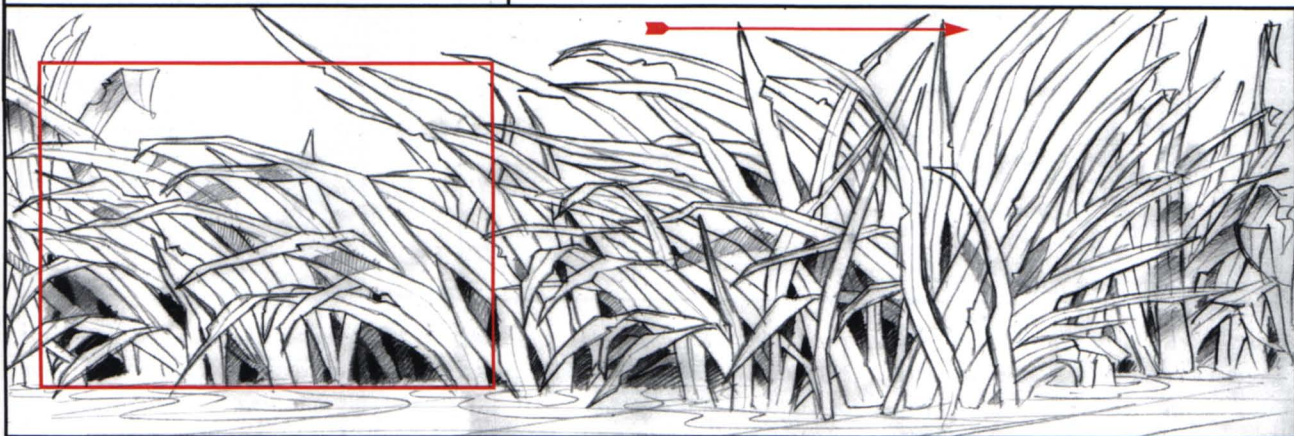

Type 2.

Here's an example of a horizontal / vertical pan combination. The secret here is to draw and paint the last field of the vertical pan and the first field of the horizontal pan *identically*. (Indicated in red)

Horizontal Pans

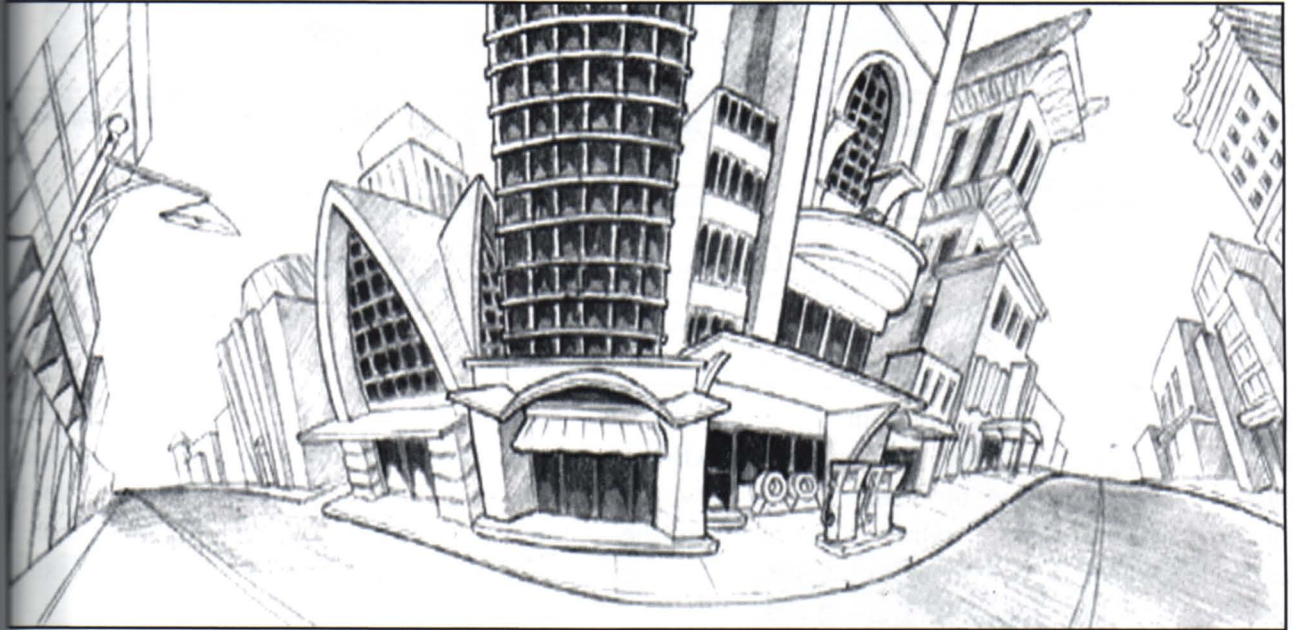

In this shot, the camera remains still and we follow the action in a direct horizontal path. This shot gives the impression that we are standing in the middle of a long street. We first look down one end, then turn our head and look down the other end.

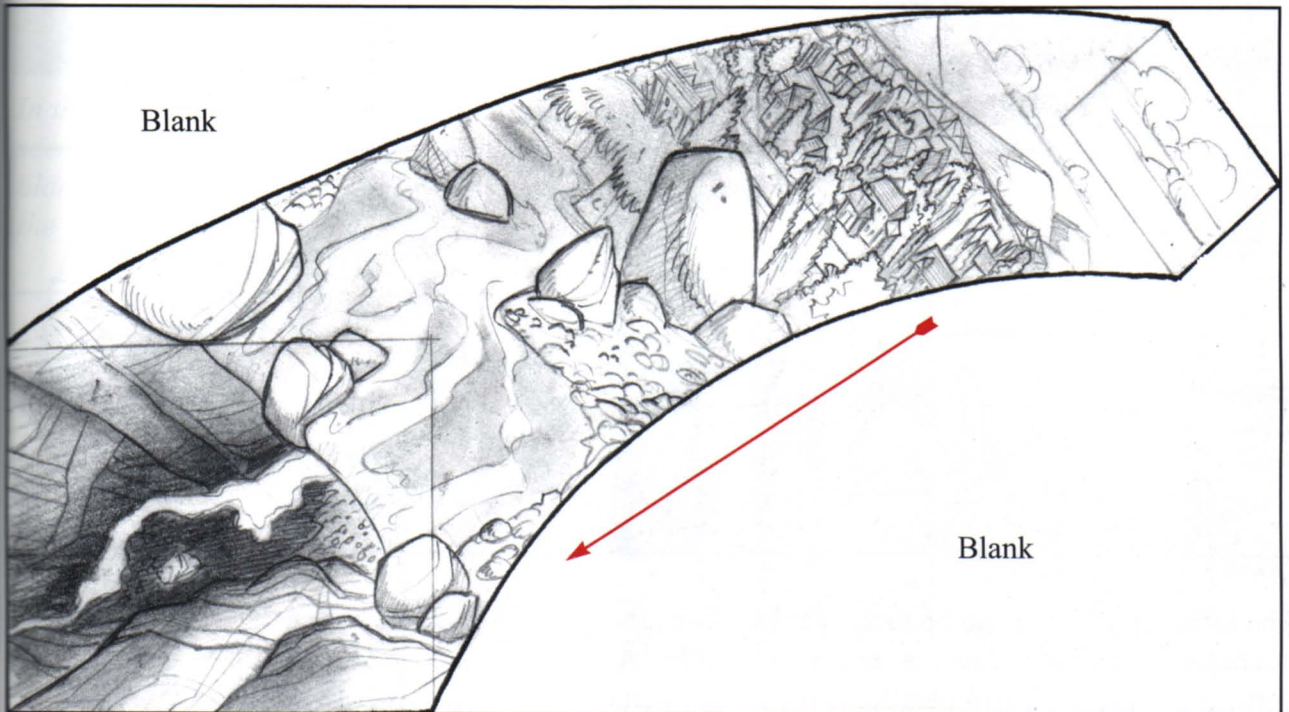

In this shot, the camera rotates throughout the scene, giving the impression that we are travelling over vast space. This is an excellent shot for opening a movie etc., as it introduces the audience to the geography of the location.



Tilt Field Pans

To get the impression of a car travelling down a long road we can use a *cycling tilt field pan*.

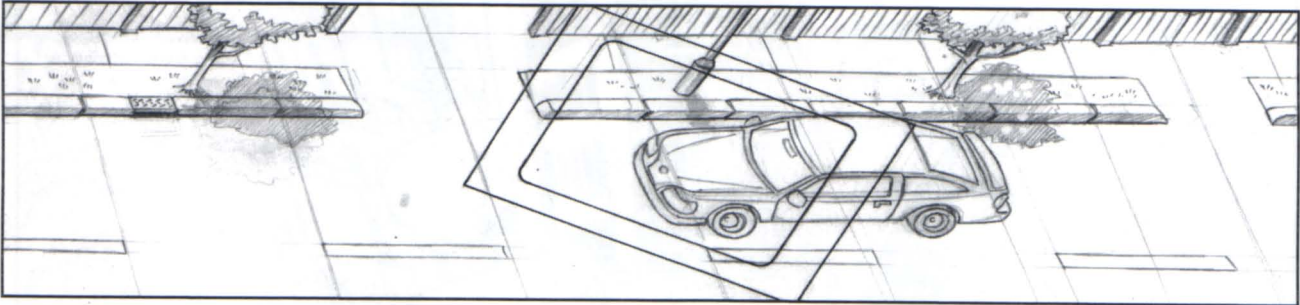

The artwork is drawn horizontally. Note that all vertical objects are drawn parallel to the angle of the camera tilt. Remember that whilst these layouts look crooked on the drawing, they will appear straight on the screen. The car would probably be held, although a north / south movement would give extra dimension to the animation. The wheels would animate on a separate level. The artwork moves from left to right on the camera bed giving the impression that the car is moving from right to left.

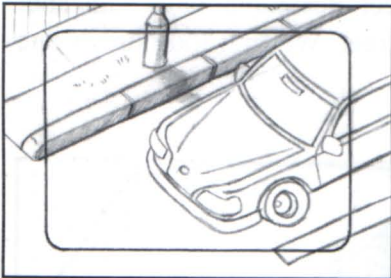

Screen image



The same type of shot can be used to get a nice upshot of a character walking down a street or corridor. Again vertical objects are drawn parallel to the picture plane.



Screen image



The same type of shot is used for a character walking, running or skiing up or down a hill.



Screen image

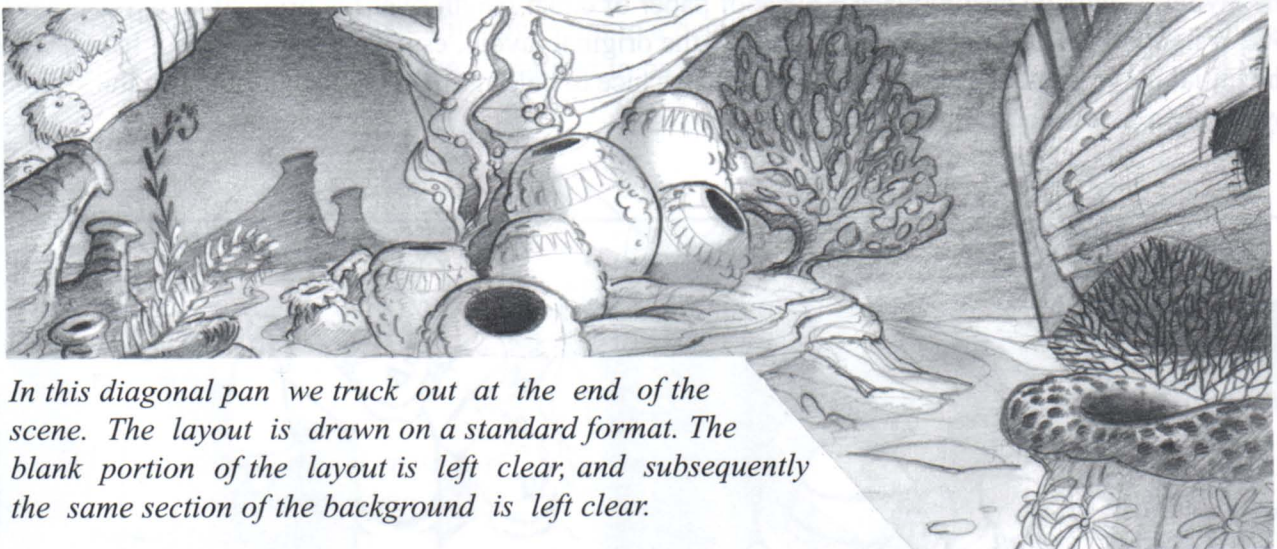

In this diagonal pan we truck out at the end of the scene. The layout is drawn on a standard format. The blank portion of the layout is left clear, and subsequently the same section of the background is left clear.



Here, a 6 field shot of a sky can be used later in a completely different scene.

In TV animation, the layout artist will be looking to reuse the artwork as much as possible, but he must be careful not to overuse it and run the risk of lessening the production value of the project.

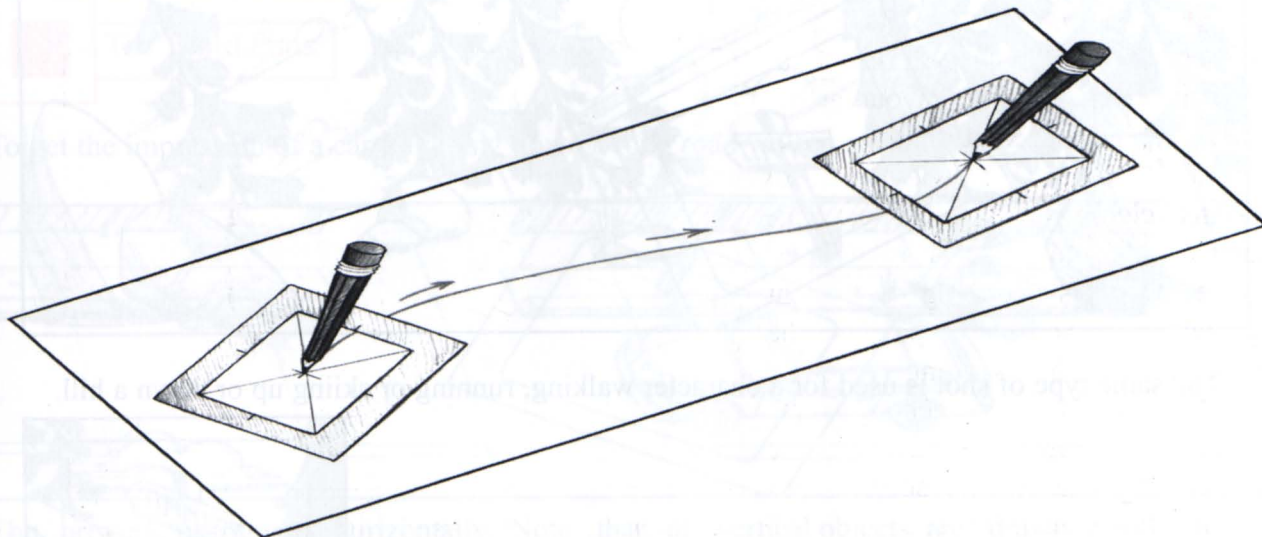

The best way to work out the curve in a curved pan, is to take your field cut-off guide and bore a hole in the centre cross-hair with a compass. Place a sharpened red pencil in the hole and drag both across the layout. It may be best to place a piece of paper of equal length over the original layout and work over a light box. That way you won't destroy the original layout, especially if you're not happy with the initial movement. This method reduces the chance of calling for pans that will 'jar' on the screen by giving a nice smooth line.



stop

Pan

start

"Sure, but who's going to do it?"

"We've got to hang a bell on the cat"

The direction of the pan doesn't always go from left to right. Here, we start with the character on the right (for example, to hook to a previous scene) and then pan to the left. Another use for small field sizes, e.g. 6 field in TV animation, is that small areas of artwork can be reused in unrelated scenes later in the episode or indeed in other episodes. It is standard practice to draw an arrow and write 'pan' on the layout in the direction that the pan will appear to move on screen. Remember that the camera has to move from left to right to give a right to left movement on screen.

Rotation Graticule

If there is a rotation or a tilt in a particular shot, then the layout artist must call up what angle and direction, be it clockwise (CW) or counter clock-wise (CCW), that the camera has to rotate. A rotation is where there is a turning movement throughout the scene, or part of the scene and can be anything from 1° to 360° . A tilt on the other hand, is where the camera is rotated at the start of the scene and the scene is shot without movement, but at an angle.

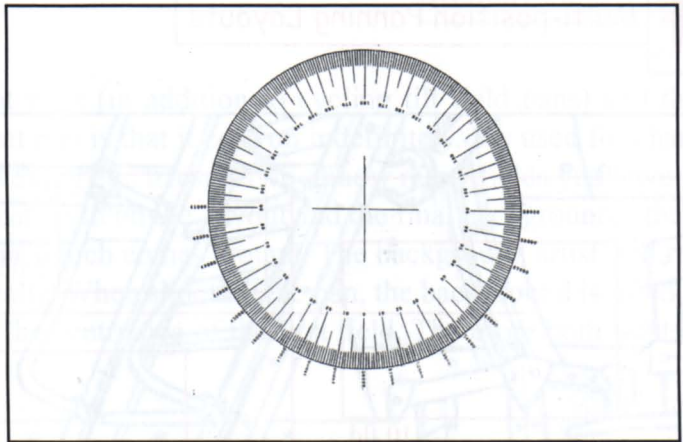

The rotation graticule is used with the field-guide and cut-off guides to find the exact angle the camera must turn. They are used by placing the field guide on top of the layout. The rotation graticule is then placed on top of the field-guide at whatever centre point the camera will be at. The cut-off guide is then placed on top of the rotation graticule. The vertical line of the cross hair will now point to a degree marked along the circumference of the circle. This mark will refer to the degree required to turn the camera.

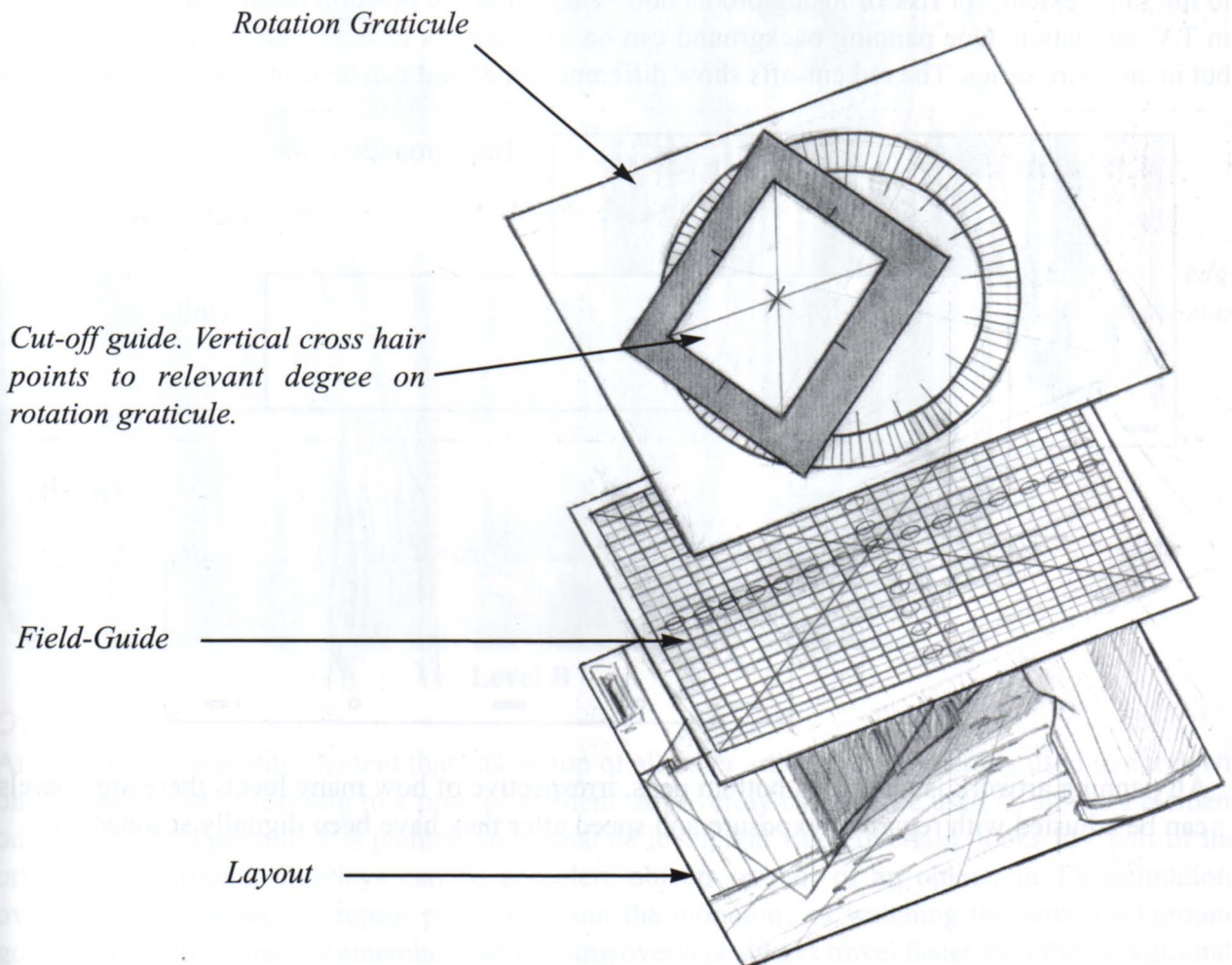

Multi-position Panning Layouts

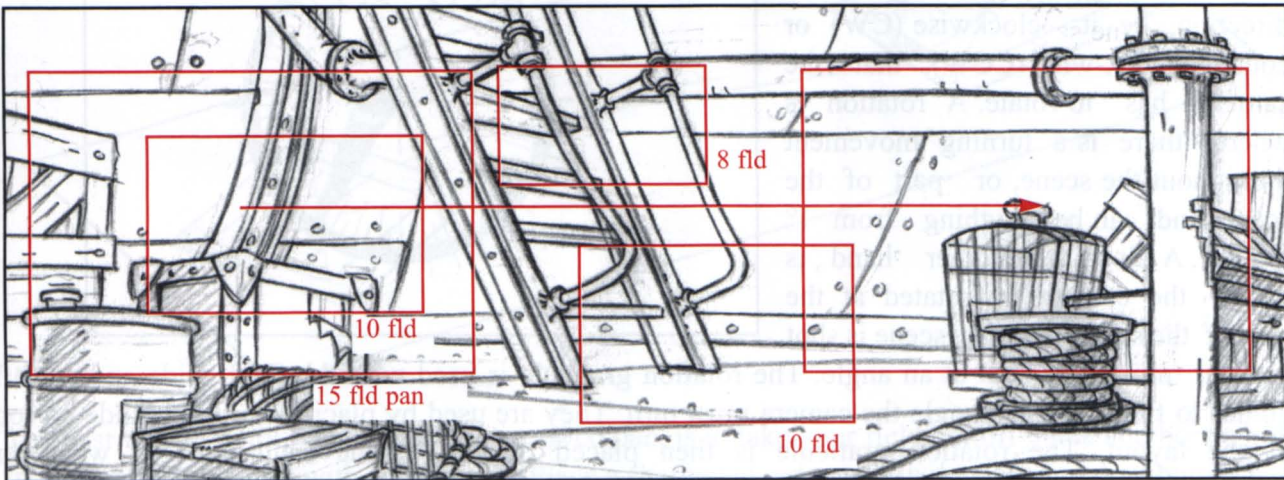

In T.V. animation, the backgrounds, character animation, effects animation etc. are reused quite often. This is done to save time and money. In classical animation, artwork is reused but not quite to the same extent, for risk of losing production value. Multiple position backgrounds are common in T.V. animation. One panning background can be used dozens of times, not only in one episode, but in an entire series. The red cut-offs show different scenes that can be shot from one background.

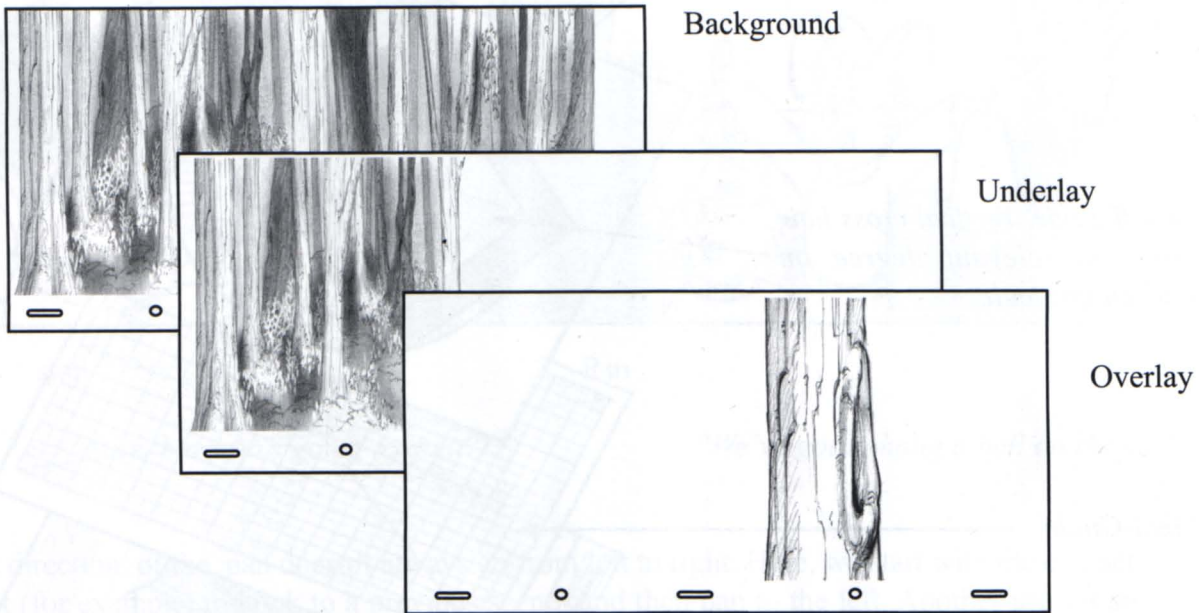

All panning artwork is placed on bottom pegs, irrespective of how many levels there are. Levels can be adjusted with regard to exposure and speed after they have been digitally scanned.

Repeat Pans



There are essentially two types of repeat pans (in addition to cycling tilt field pans) and they're pretty much the same. The idea of a repeat pan is that it can run indefinitely. It's used for character run / walk cycles or perhaps a vehicle travelling etc. Irrespective of how many fields you have in the pan, the first and last field must be *identical*, both on the layout and the final background, otherwise the pan will appear to jump every time the switch comes around. The background artist will retrace the first field and paint both fields identically. When shooting the pan, the background is lifted at the centre peg of the last field and returns to the centre peg of the first field. Therefore both fields must be centre pegged.

Type 1



This edge overlaps the start of Level B.

Level A



This edge overlaps the start of Level A.

Level B

Overlays

An overlay is a separate element that sits on top of all other artwork. It's generally used to cut down on the amount of registering to a prop or element. An overlay can also be used as an extra element on a reused background. It is painted on a separate level, and when overlaid, looks like part of the original background. Overlays can be complete objects or part of an object. In TV animation, overlays can be added to repeat pans to cut out the monotony of watching the same background going by countless times. Remember that panning overlays always travel faster than the background.

Here's how the previous scene appears on screen.



Level A

Level B

When level A is off screen, it is removed and rejoins at the end of level B.



Level B

Level A

If the scene is long and needs to be reused to the point of death, then a third section may be added or an overlay (as previously described) may be added in on every other pass. The important thing to remember in this pan, is that an object is needed to go from the top to the bottom of the background, otherwise the join will be seen. A join through a sky for example would be very obvious.



The overlay moves at a faster speed and is used to add depth to the scene. If the scene is scanned into a computer this wouldn't cause a problem. A repeat overlay will be made up in the same way as the background. Don't add in the sun or moon, signposts or held characters. In an internal shot, avoid a table and chairs or any piece of furniture that will become too obvious if a few passes have to be made. Another trick is to use a non-repeating, slow-moving background with a repeating overlay.

Type 2

This type of pan is used when we are following a character walking down a street. It's a kind of cheat. The vanishing point is 'floating' so it never really converges on a particular point. The camera is slightly in front of the character. The character itself will be animated 'in place'. This means that it won't actually move around the screen, even though it looks like it is. This type of pan is usually cycling, although larger studios may well have a long pan in order to keep the backdrop changing throughout the scene. The grid follows the cracks on the pavement.

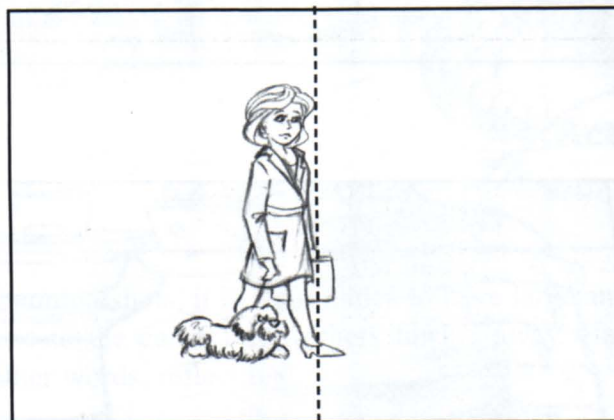
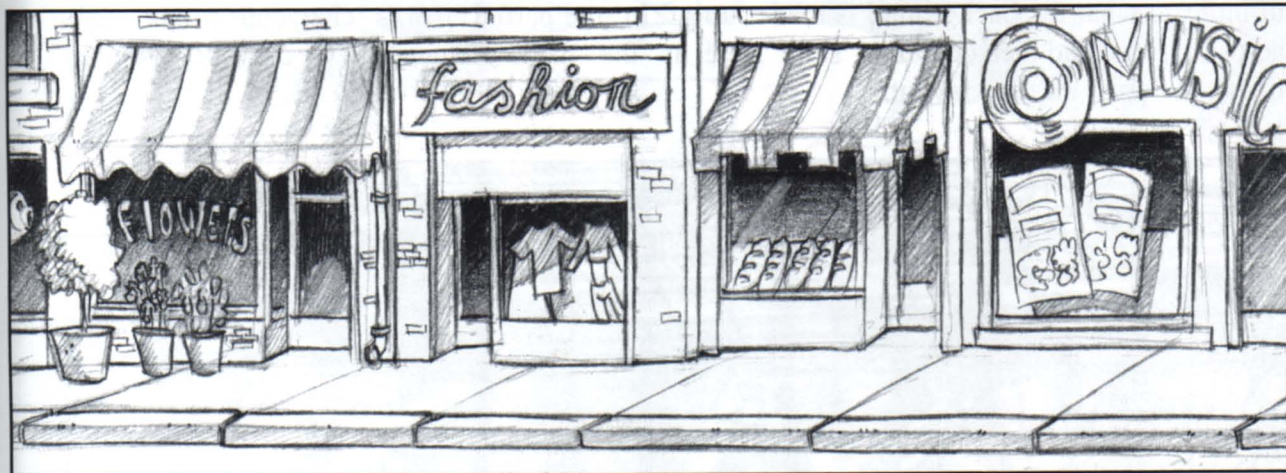

Character walks 'on the spot' and is placed slightly left of centre.

Pans should be folded like this, with the last peg hole position and the scene and sequence information in the bottom right hand corner.

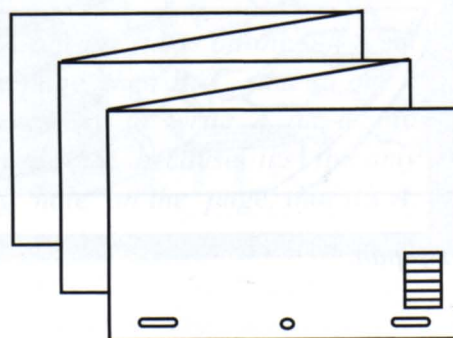



Zip Pans

Zip pans are used to create the impression of speed. A normal layout travelling at say an inch and a half per frame would strobe and cause mass blindness in the audience! In this case we draw the layout with speed lines to give the impression of the character or even an object travelling past at high speed. There is little or no detail in the background objects, just a few lines to indicate what the background is made up of. In the partial pan, a character might walk across a room and then do a little skip. Here, as the name suggests, we only draw speed lines in part of the layout.

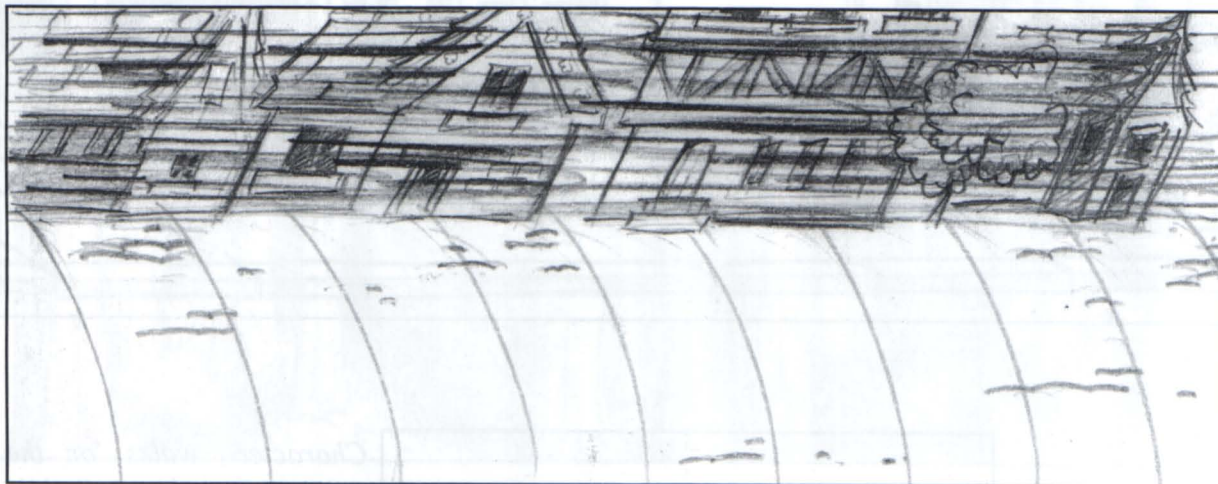

Full zip pan.

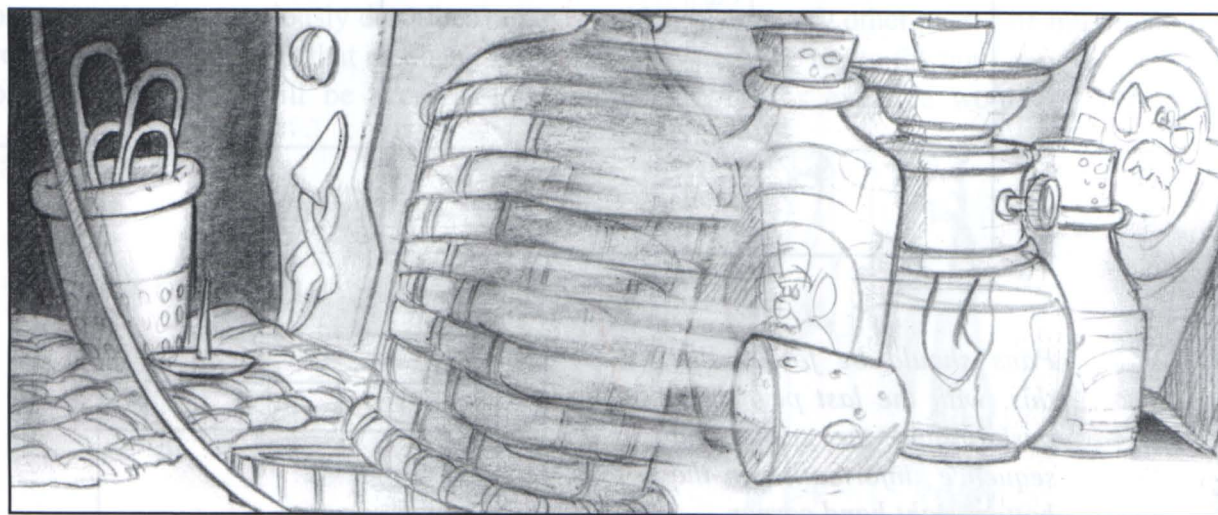

Partial zip pan.



If the character is running from left to right, then the props should lean from right to left and vice versa.



When you are doing panning shots, it is a good idea to have large and small areas of dark and light. Place some props close to the camera and others further away. Have a selection of grouped and individual props. In other words, reflect reality.



Peg hole A always starts on the left hand side of the page, then B, C, and so on. It is not necessary to write A on a still. It is assumed that because it's the only round peg hole on the page, that it's A.



Trees drawn like this will strobe on the screen.



Use a nice mixture for better results.

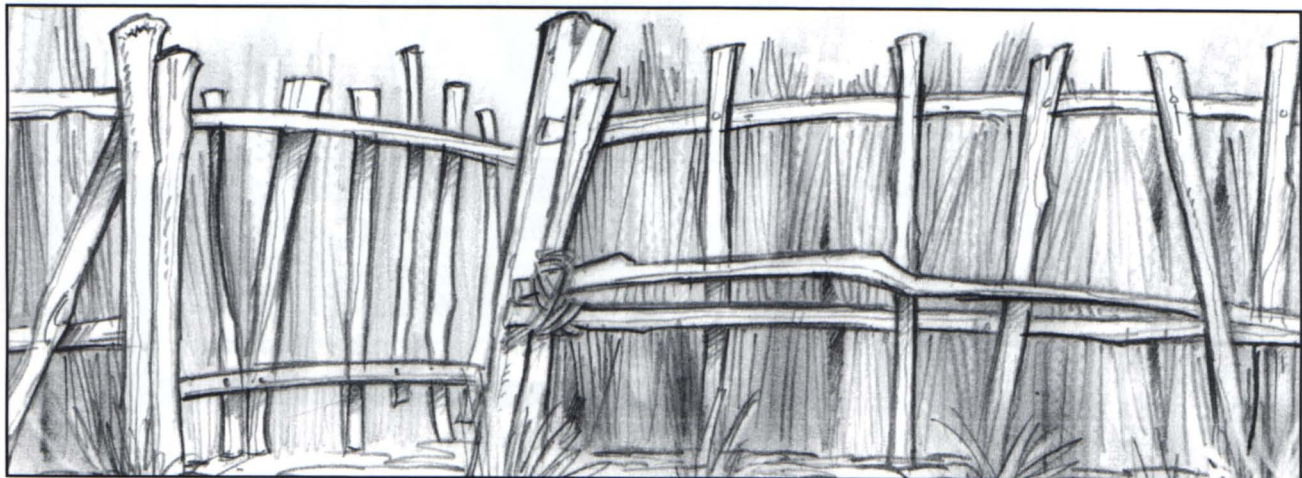

The same rule applies to almost any vertical rows of objects.

Answer
1. Pa
2. W
3. W
4. W

Assignment

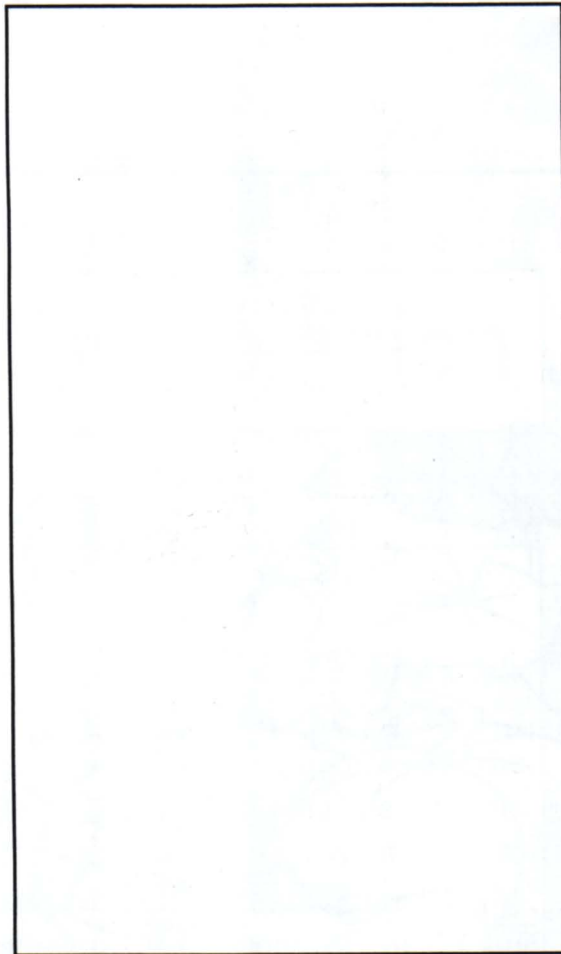

Draw a thumbnail suitable for a shot where we see a character climb a tree from the bottom to the top, with the camera following the character all the way up.

Answer the following questions orally.

1. Pans must *always* start from the left. True or false?
2. Why must we make a compensation in the field size when we rotate the camera?
3. What are vertical pans used for?
4. What general rule applies to vertical objects in a scene where the characters are running fast?

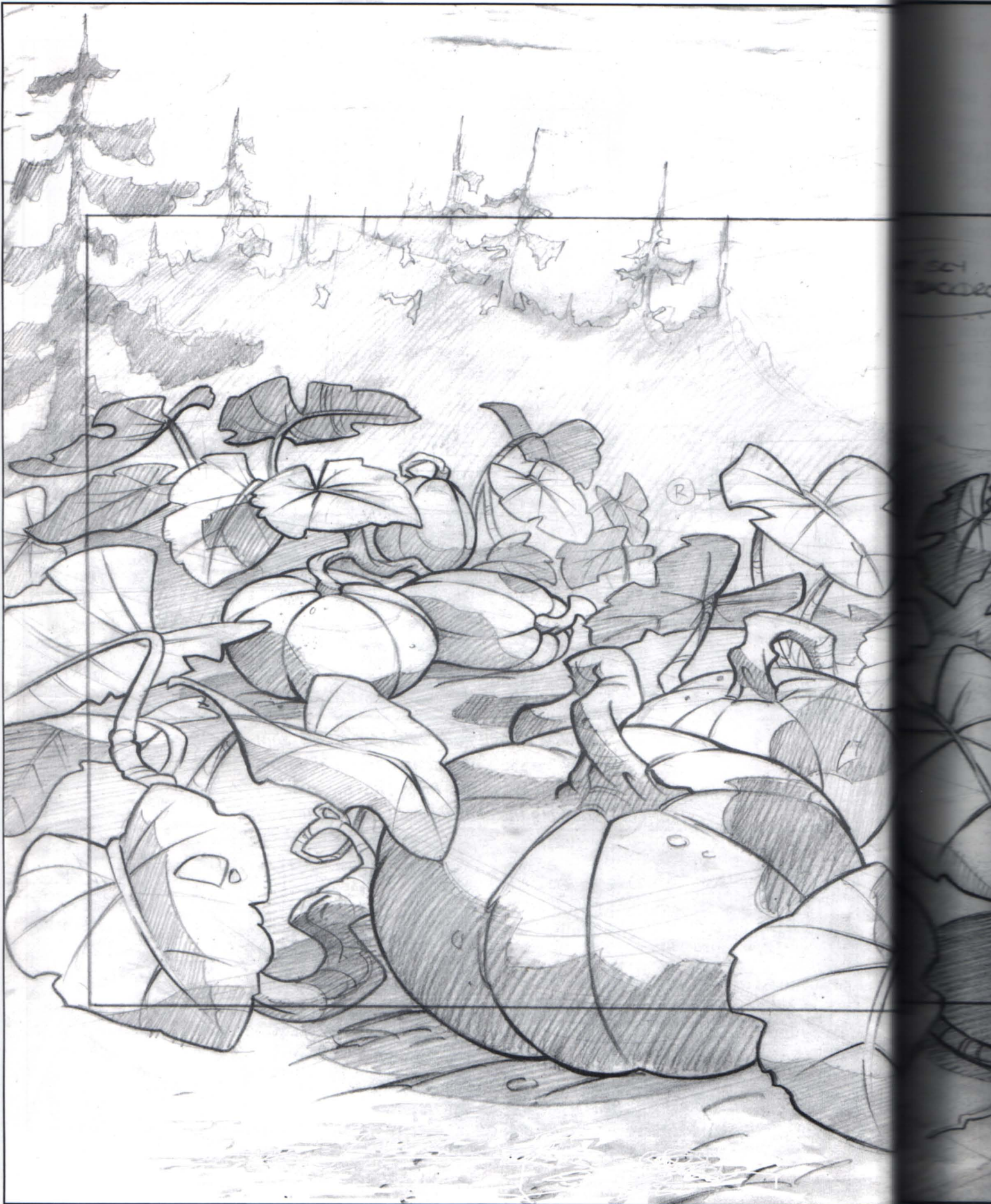

Composition

Composition of a layout deals with the overall structure of the picture, by manipulating the viewers into looking *where* you want them to look, through manipulation of the characters and props within their settings. This chapter shows you how to achieve this.

| |
|-------|
| SC 40 |
| BG 40 |
| OL |
| UL |
| OL |



Focal Points

Every layout needs at least one focal point. This is a place on the picture plane in which the main area of interest or piece of action is taking place. The idea is to draw the viewer's eye to this spot, otherwise the eye wanders without knowing where to linger. In classical film-making, the layout whilst being a highly thought out, well designed and executed image, should not take away from the animation itself. In TV there is a lot more held animation and longer scenes, giving the audience more time to look around. For this reason the layouts can be at least as good as the animation. In certain types of computer games, such as in 'point and click', the viewer will interact directly with the background. Therefore, the layout and background can be even better than the animation itself. Before doing a layout, ask yourself what exactly you want the audience to see. This will then become the main feature of the focal point. As humans, when we look at any image, we look at the centre first (with characters it's always the eyes first) and then look around the rest of the image. Placement of objects is all important in the composition of the layout. By placing objects in the centre of the picture-plane we get a well balanced, symmetrical image which can be good for drawing buildings such as cathedrals, office blocks etc. However, layouts more often than not look stronger with the main interest off to one side. We can divide our picture plan up with imaginary lines. The points where these lines cross are also good location points for placement of objects or characters. These cross-over points are called the *four key points*. One way of achieving this is to use the *rule of thirds*.

The Rule of Thirds.

Divide your picture plane into thirds. Remember that these are imaginary lines and there is no need to actually draw them on the layout. In the case of a pan the same rule applies. With a pan, the audience will see one field at a time, and will build up a mental picture of the entire scene. From here you can place the focal points on or near one of the dividing lines, either the horizontal or vertical. It doesn't need to be exactly on the line. Off-centre creates a more dynamic image than a central emphasis. This is because it causes the eye to wander around the image. Objects placed on the centre of the picture-plane need to fill the picture, whereas objects placed off-centre reveal the setting.

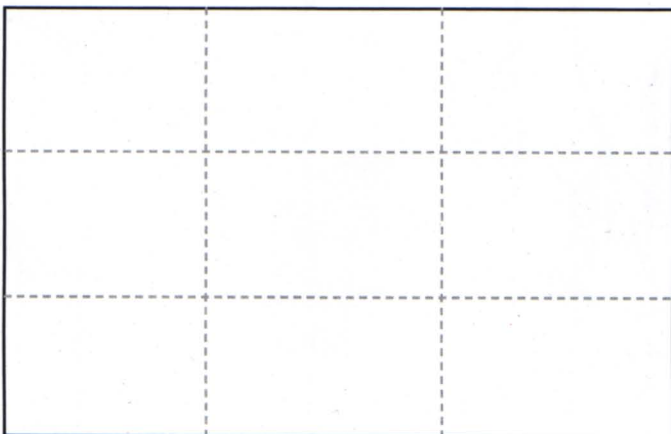

The main focal points should be placed on or near the imaginary lines and key points. The same rule applies to pans. The audience will build up an overall picture of the different images as they go past.

The Four Key Points

The points where the imaginary lines cross over are called the four key points. These are ideal places for locating the focal points.

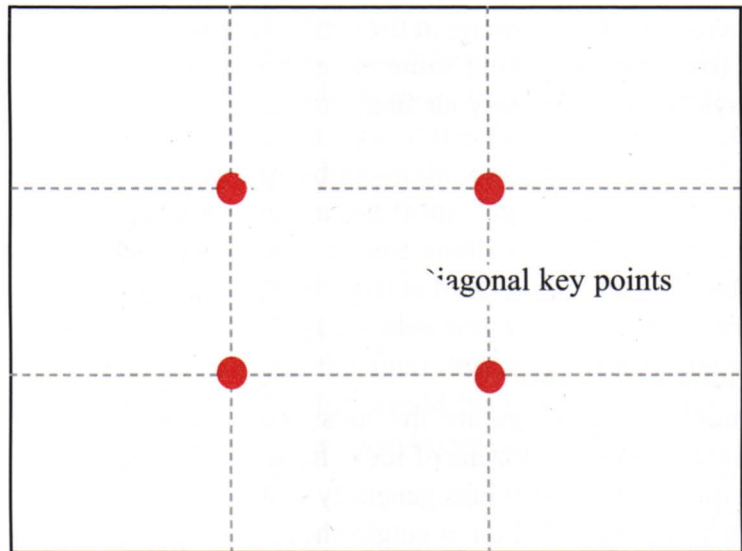

If you want to balance the main focal point with a less important one, an effective place is the diagonal key point. Make sure however, that it doesn't compete for attention with the main focal point.

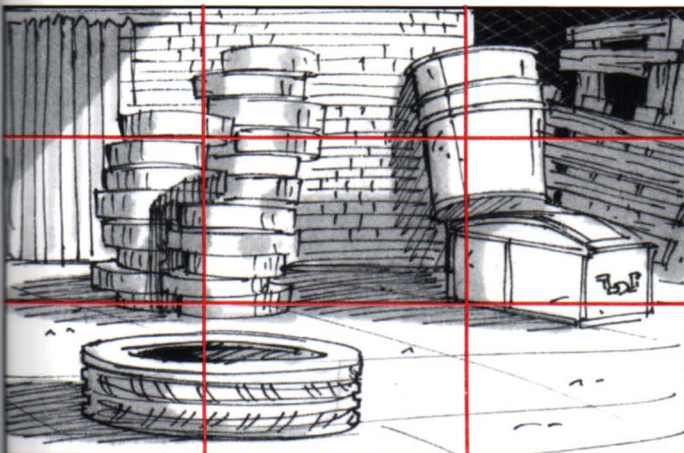

Place characters / objects on or near the key points.

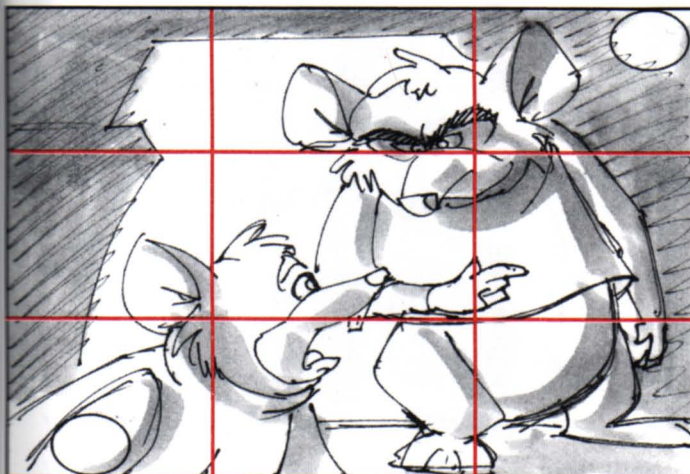

Balance characters / objects by using the diagonal key points or by lighting the characters or objects to bring them into the picture.

There is a lot of planning in the composition of a layout. We have to make sure that it is not too busy, or that it is not lacking some element that could strengthen the picture. There are several different ways you can choose your final image.

- * Thumbnails.
 - * Conceptual drawings.
 - * L-shaped frames.
- or any combination of these.

Thumbnail Drawings.

Thumbnail drawings are the most worthwhile drawings you will ever do. It takes only a few minutes to create dozens of ideas from which you can choose your final design. Thumbnails should be quick, rough drawings generally with little or no real amount of detail. An entire full length movie can be thumbnailed on a single sheet of A4 paper. This saves time and money in a big way and at this stage can be shown to the director to see if it's within the ball-park. Once the director agrees the thumbnails, they can be further developed into conceptual pieces or even the storyboard. When doing a key layout it's also worthwhile to do thumbnails. The first angle you choose for your shot may not be the most effective or dynamic, therefore thumbnails give you the chance to work out a more effective shot. Don't spend hours working on the same thumbnail! The whole point of thumbnails is that you can do lots of them in a very short period of time.

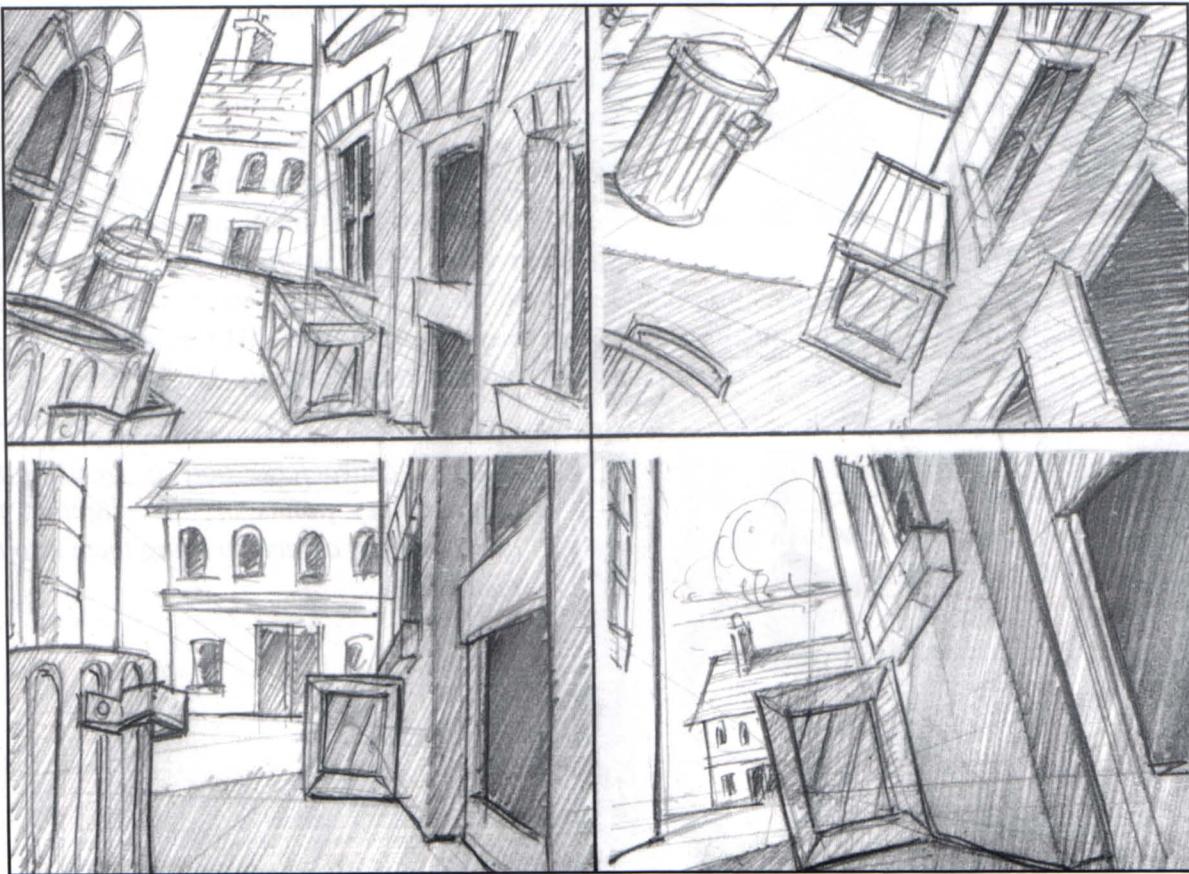

Do a few thumbnails using different camera angles to see which will give the best shot.

Conceptual Drawings.

Conceptual drawings are quite often done from the imagination, simply based on the name of the project or a read of the initial story treatment. These would consist of character design / development, location setting and design. Here too, the look and style of the project is established. Conceptual drawings are done by a wide range of artists, depending on the size of the studio. This gives the director a much broader pool or range of styles to choose from. The initial conceptual artwork and the final product quite often bear no resemblance to one another. The director will have his own thoughts on the project and will ask the conceptual artist to base their designs around these. The medium used can be anything that helps the artist get his idea across. For example, the artist may use chalk pastels to do the conceptual piece and the final artwork will be done in acrylic. It wouldn't be very often however that the layout artist would be required to do a conceptual piece. This is usually done at pre-production or storyboard stage.

L Shaped Frames / View Finders

L shaped frames are quite simply L-shaped pieces of card held in the hand or formed by the hand to frame off the picture plane enabling you to pick the best composition for your picture.

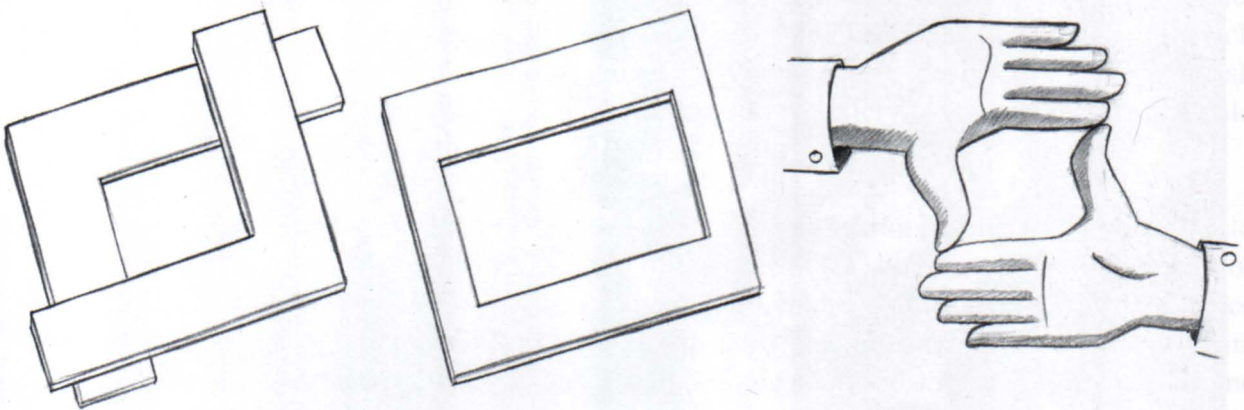

Any of these framing devices can be used when you are out reference hunting. If you are out on location, then these are an excellent way of containing your chosen view.

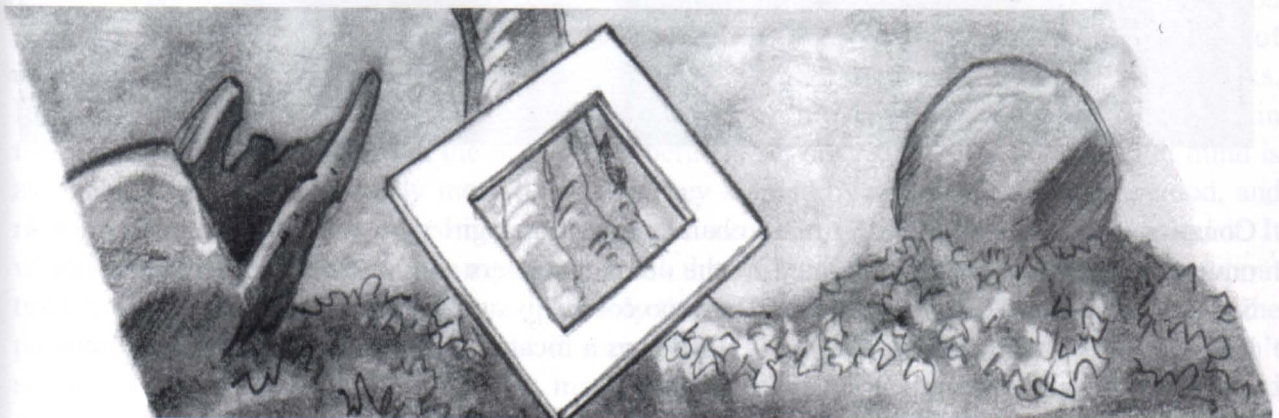

When you have collected your reference material, conceptual drawings, thumbnails or whatever, you can further frame these with your L-frames to get a different, maybe better composition.

Multiple Focal Points.

As you have seen, focal points are the area of a picture which draw the viewer's eye automatically. Usually you may want just one, but occasionally you may want a more complex picture, for example, if there is a crowd scene. In this case, the positions of each character need to be 'interesting' without fighting for all of the attention. If you have say, two focal points of equal importance, don't place them too far apart or the eye will play picture tennis (although this could be used to convey conflict). Various areas of activity can be placed around the picture plane so long as the eye is 'controlled' in looking from one place to the next.

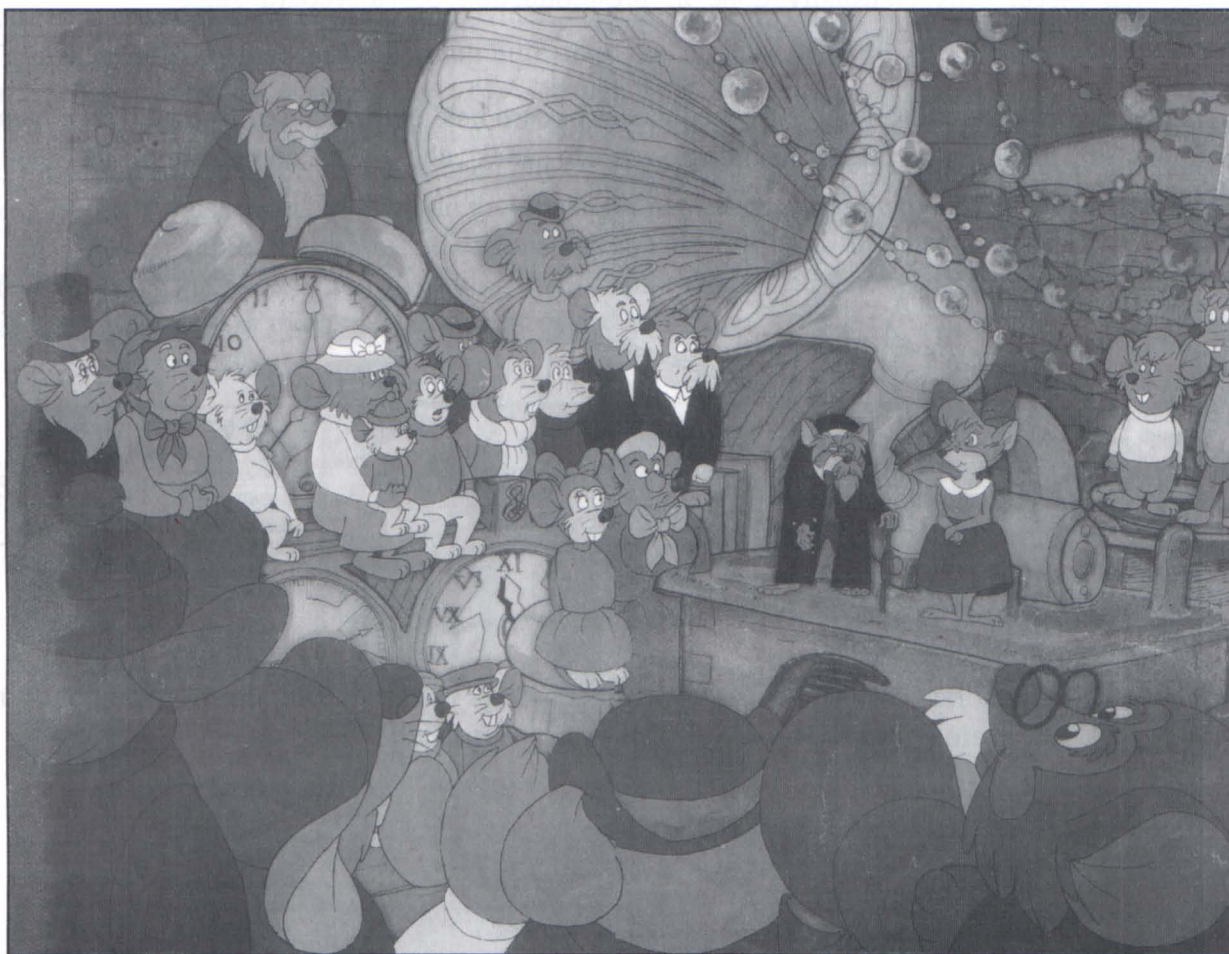

Complex focal points: Here the main character, a young girl mouse, standing beside an old mouse on the gramophone, is framed by the other characters and by the beads above her head. She will be doing most of the talking. Here too colour is used as part of the composition. The bearded mouse sitting behind the clock also forms a focal point. In this instance we use colour, the mouse against the relatively plain background.

Leading the Eye



We have now seen that whenever we look at any image, we always look at the centre first. Then our eye wanders around the rest of the picture. Because we want the audience to look at specific areas, we can influence them by 'leading the eye' to the focal point. For outdoor scenes, you can use footpaths, roads, rivers and railway lines on the ground plane, or fences, walls, hedges or buildings on the remainder of the picture plane. These all have strong, straight lines or serpentine shapes that can be exploited. You can make the objects on your layout look coincidental, but place them quite deliberately. Remember, you are playing on the audience's unconscious thought to make them look where you want. You may need to deviate slightly from the key layout and shift objects, props or characters around from layout to layout to give clarity to the rest of the picture. For this reason, it's not always a good idea to make a model of the set and use photographs to derive your layout. When considering the composition of any scene, we should always remember that unlike a comic book where the reader can look at an image for as long as they wish and look back at previous pages at will, a TV or movie audience will get only one look at each image (unless of course they're watching a video). Assuming though that the audience is watching for the first time, we must design the background and character poses so that they make a clear story statement which is visually interesting at the same time. When you design a scene, ask yourself if each frame would be strong enough to hang in a gallery. Avoid images that would confuse the audience.

The background in animation should never detract from the animation itself. The layout should never contain anything that would hi-jack the rest of the scene. We should consider the staging of the characters first, then design the layout around them. Remember, it's the action that the audience come to see. If there is equal importance given to all aspects of the project, i.e. character animation, background and special effects, then the audience will become confused and the image will become too 'busy'. If the audience's attention has to be drawn to a particular prop, then it may be better to do a close-up of the prop instead. One of the goals of composition is to be able to select and arrange things so that they hold their proper place within the picture.

To truly understand composition you need to draw, then draw some more and some more until you get the feeling that there is something right about your picture. The skills of drawing and the understanding of composition cannot be simply acquired through reading books. Books can only give guidelines. The strength of many of the world's most famous paintings lies in the composition. Whether or not the masters deliberately set out with circles or squares in mind is arguable however. It's probably more likely that they learned by experience what was good, and more unlikely that they drew geometric shapes on a canvas and built their painting around it. It would be nice to go back in a time-machine and ask them for their opinion on what critics say about their work. In animation terms however, probably the most important part of the composition is the perspective. Design your layout so that it supports the main action, but having said that, don't sacrifice the background either. There is many a background and many an overlay that has saved some poor quality animation. In some computer games e.g. 'point and click' games, the player interacts directly with the background and subsequently it must be of equal or better quality than the animation itself. This is probably the only time in animation that this happens.

Use straight lines or serpentine shapes to lead the eye.

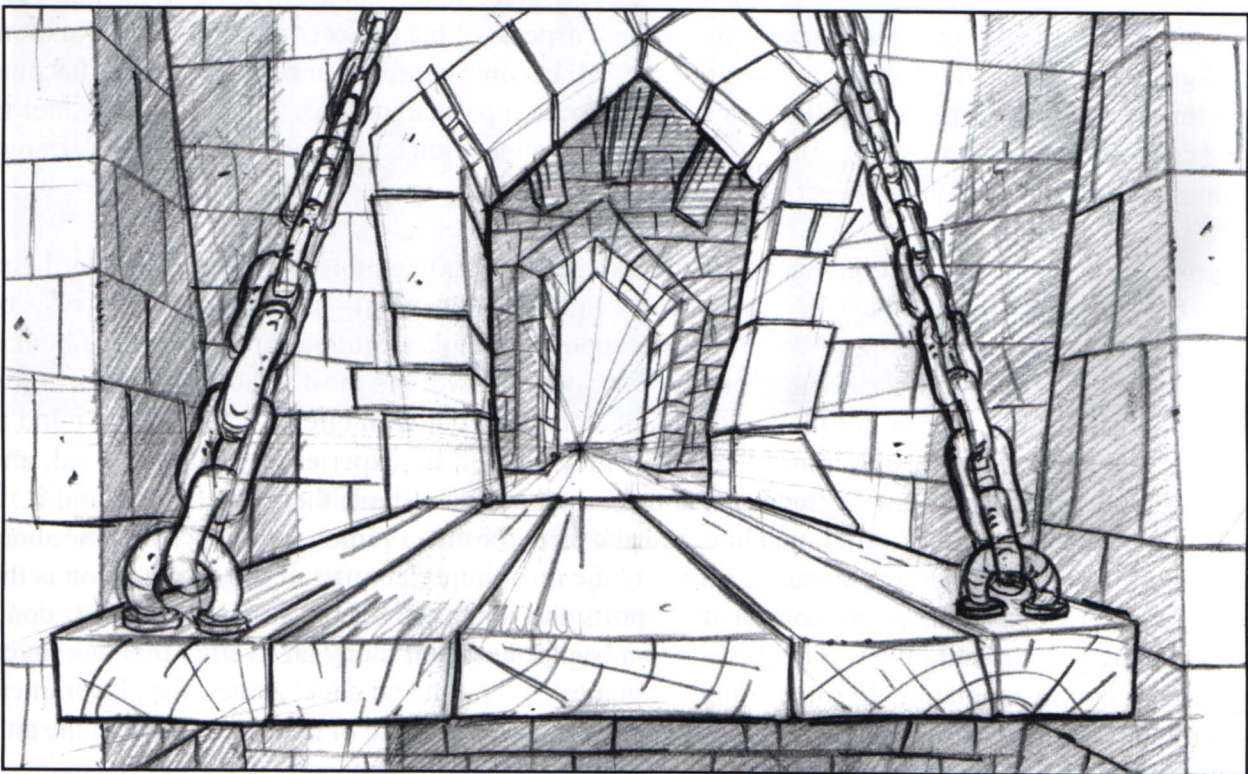
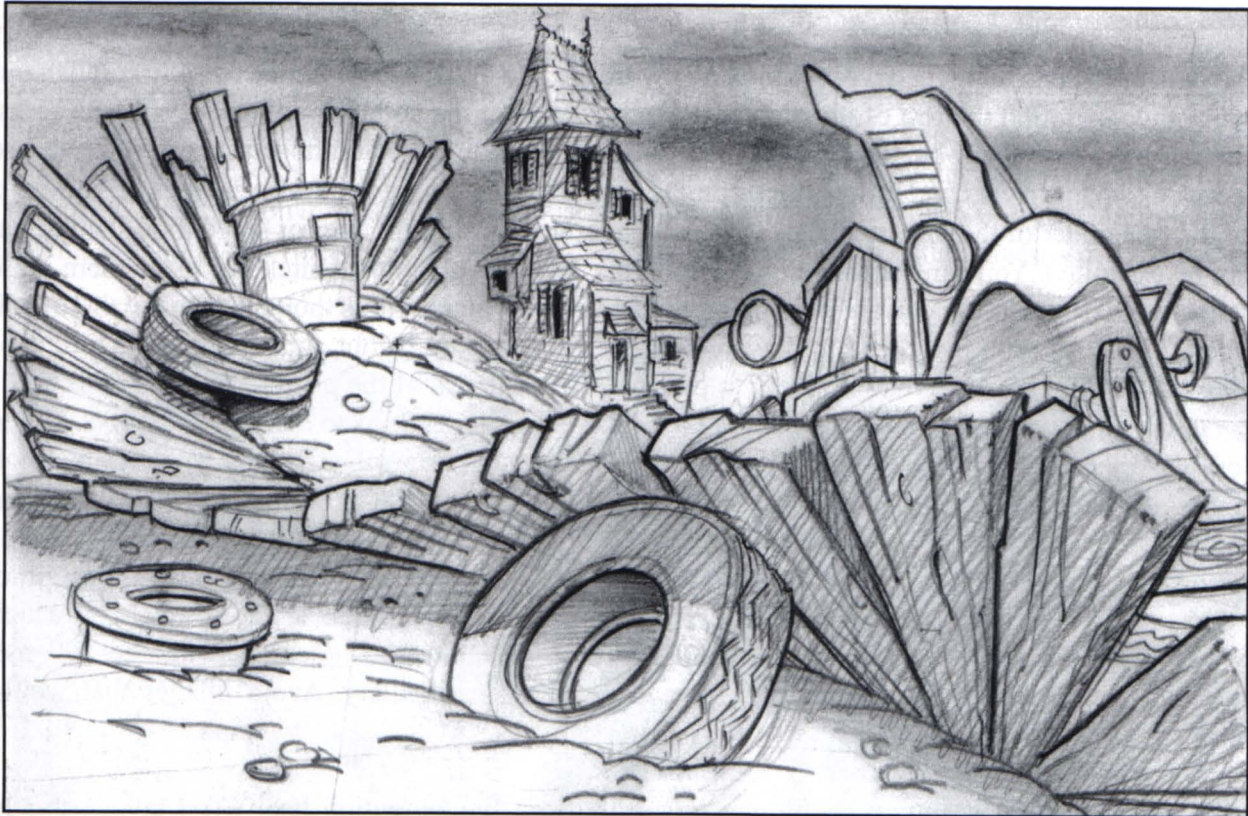

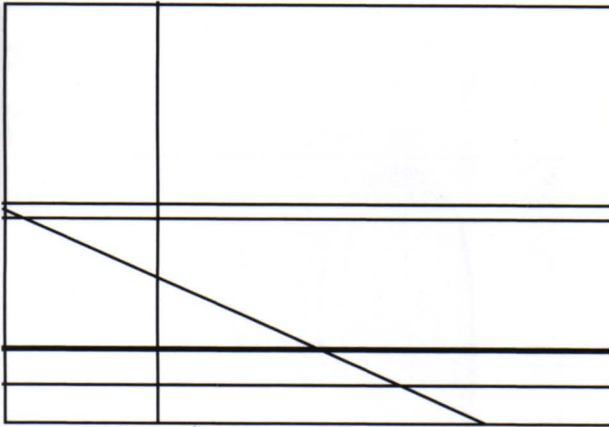

Beware of dominant horizontal or vertical lines as they can lead the audience's eyes off the screen.

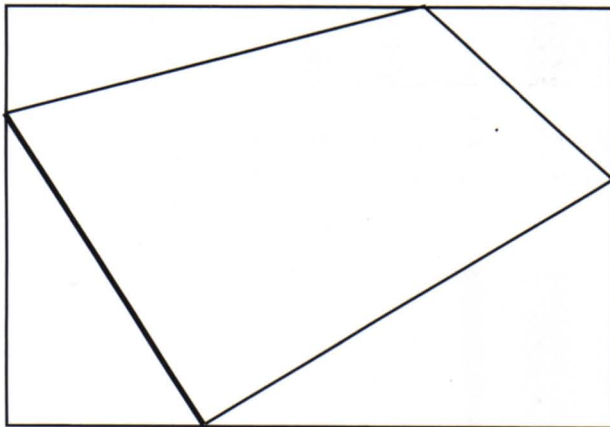
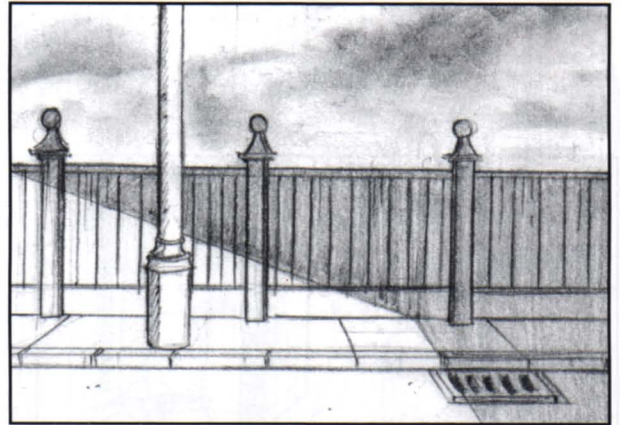

Here the eye is being forced to travel around the picture, but under control.

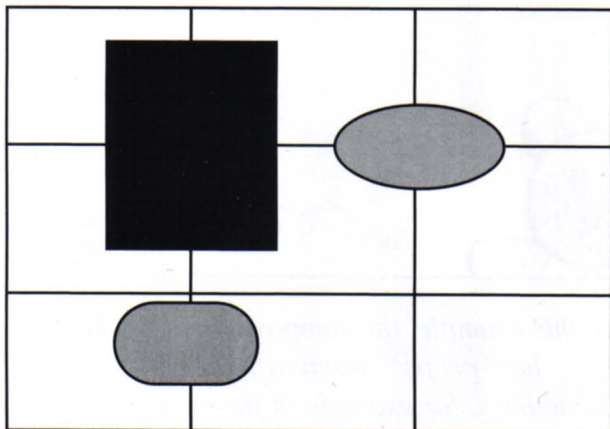
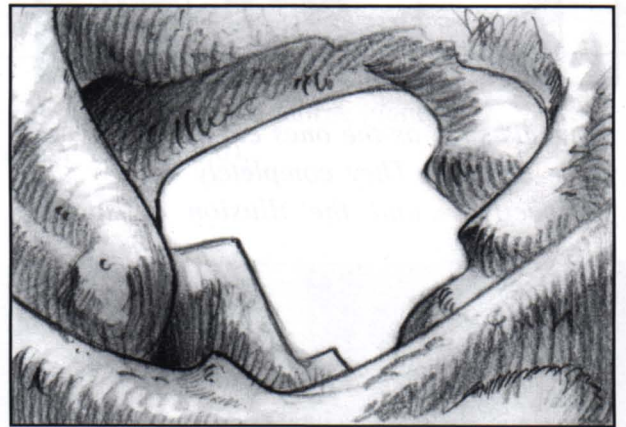

Here the mass of objects will cause the eye to jump from object to object.

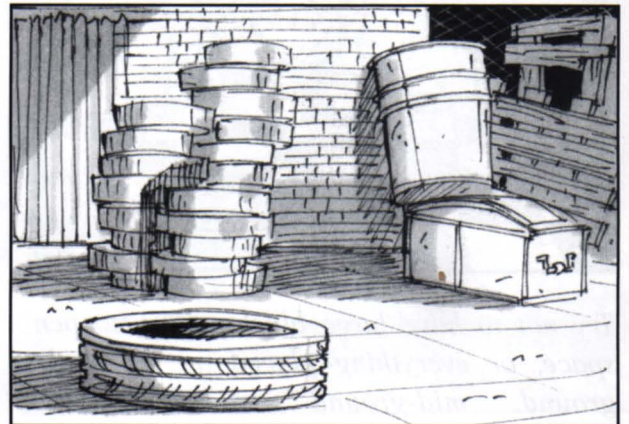

The form of composition chosen will depend on what's happening in each scene.

Compositional Errors

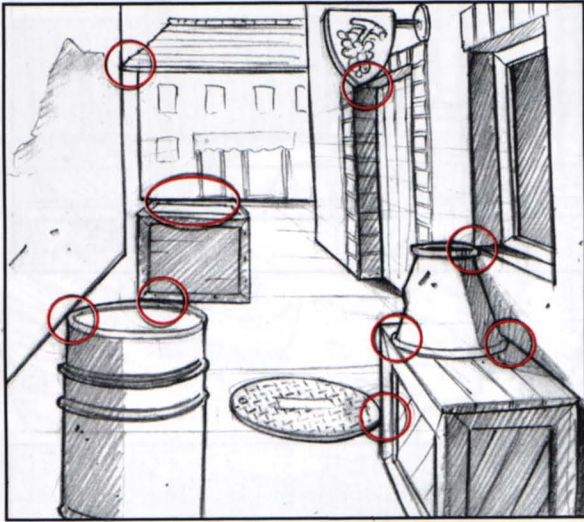

Tangents such as the ones circled above are to be avoided. They completely destroy the perspective and the illusion of space.



Avoid these type of compositional 'nasties' when it comes to the horizon line.

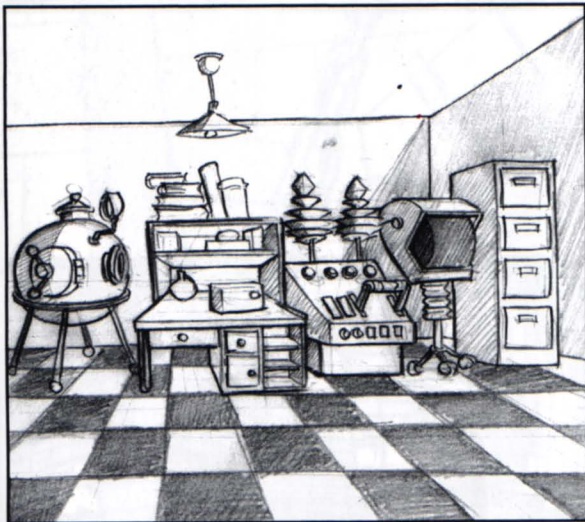

Try not to have large blocks of wide open space, or everything placed on the background, mid-ground or foreground.

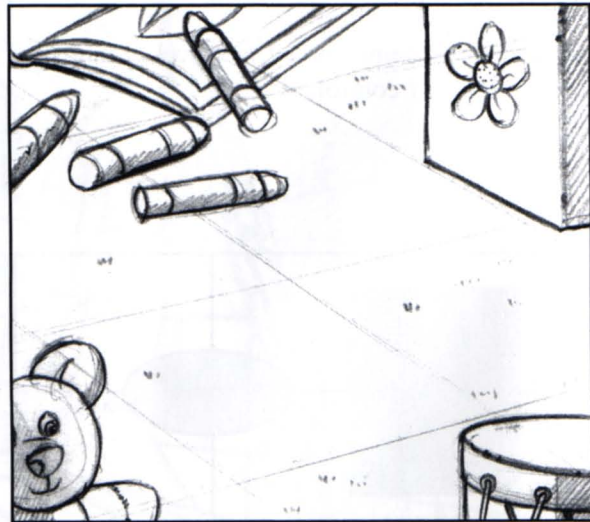

In this example, the composition is weakened by 'half-props' dominating the scene. Sometimes, for example in the case of a pan, an object or prop may end up being cut off, but don't start the scene off like this.

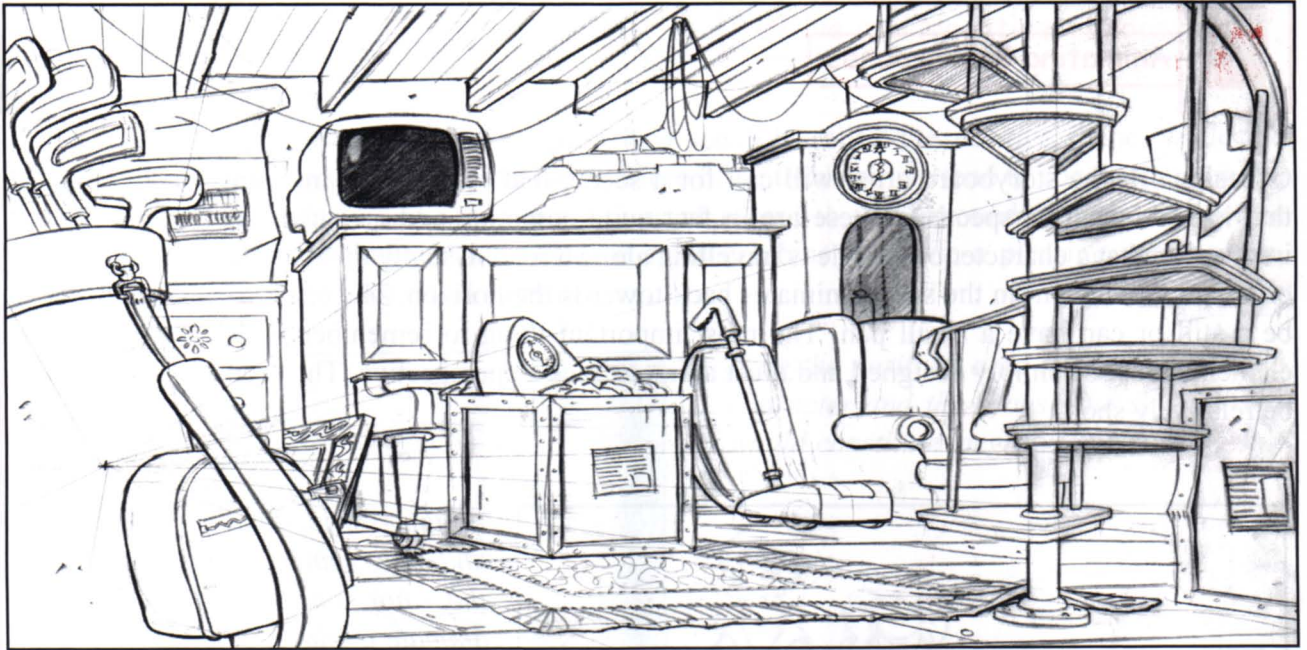

When possible, try and have something in each of the three planes,
(background, mid-ground and foreground).

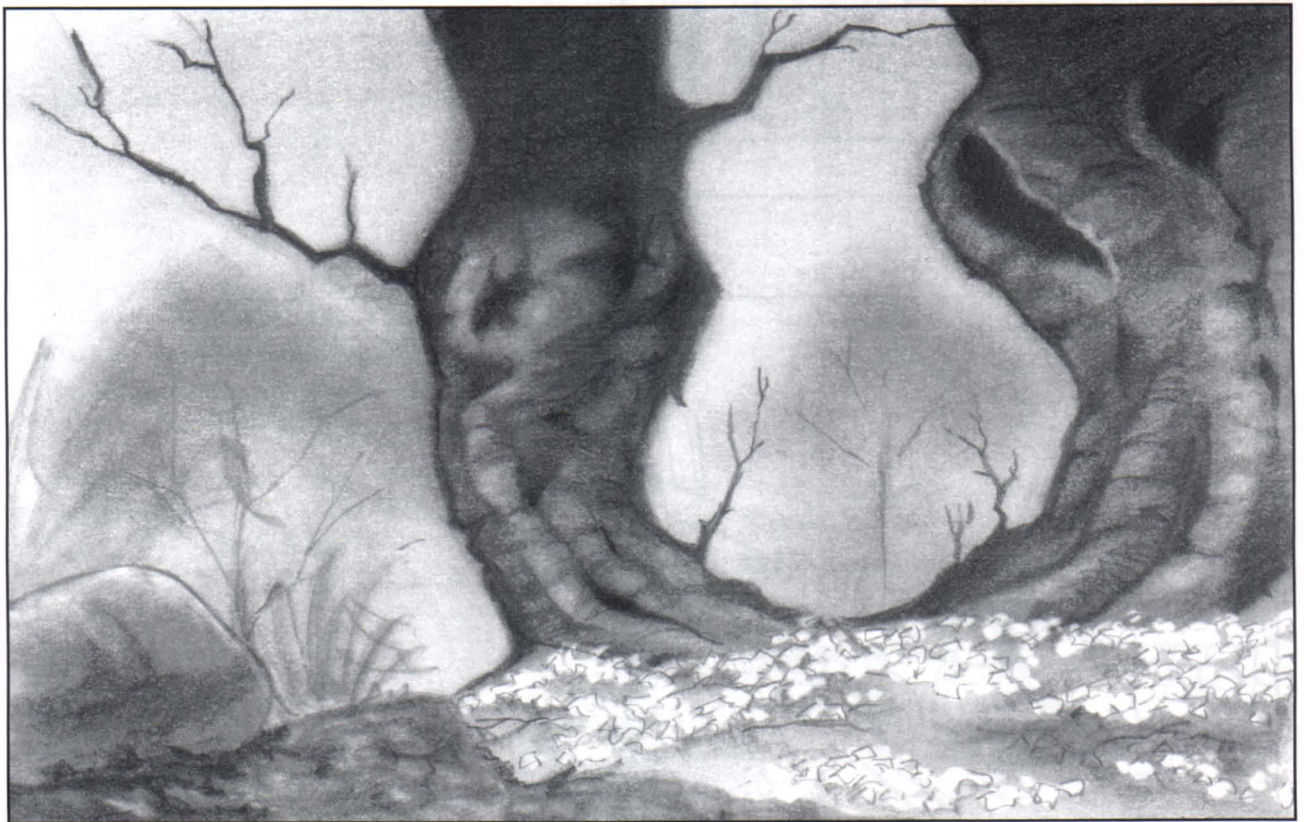

Consider the composition of *every* single item you draw on your layout, even
down to the fallen leaves.

Animating Backgrounds

Occasionally, the storyboard artist will call for a scene, that requires an animating background that is moving in perspective. These are in fact quite common, and are often used to give the impression that a character or vehicle is travelling along a road. Usually the mountain, road, fence or any other element in the scene animates back towards the horizon. The background can either be a still or can have a small pan. The most important thing to remember is that all of these elements must be simply designed and must animate back in perspective. The scene itself should be relatively short.



In this scene, the footpath, road and fence animate back towards the horizon. The characters animate in place.



In this scene, the road, wall and mountain animate back towards the horizon. The car animates in place.

Positive and Negative Shapes



The area taken up by a character or prop in a scene is called the *positive* shape, while the surrounding area is called the *negative* area. More often than not, we tend to concentrate on the design of our characters and props and pay scant regard to the surrounding area. It must be remembered that both positive and negative areas combine to create a pleasing composition, therefore both must receive equal attention.



Here the positive area is taken up by the character and the props. The sky and sea would constitute negative space.

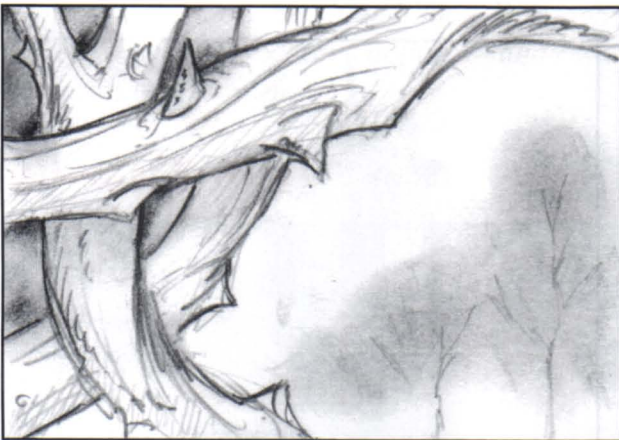

Quite often no character appears in the scene. In this instance, particular attention must be paid to the negative area.

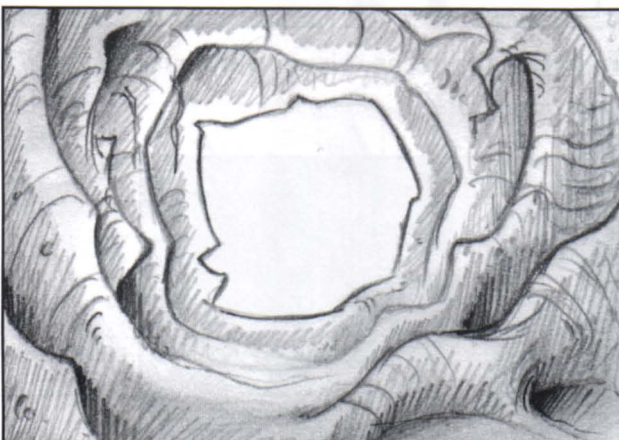

Here, each layer of the cave is a negative shape and great care must be taken in designing each one. The shapes should be pleasing to the eye.



Silhouette

Silhouette is a another vital component in a scene, not only with animation but with prop design also. For example, there may be no dialogue in a scene set in a dimly lit room, or, the characters may be seen as a silhouette on a window blind. Here the audience should be able to follow the action of the characters and be able to identify exactly what props the characters are reacting with.

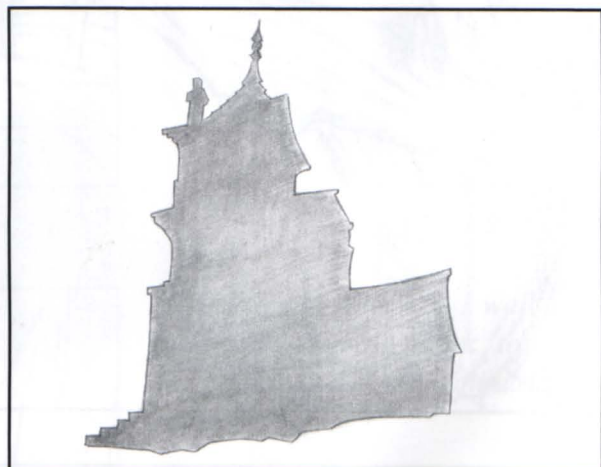
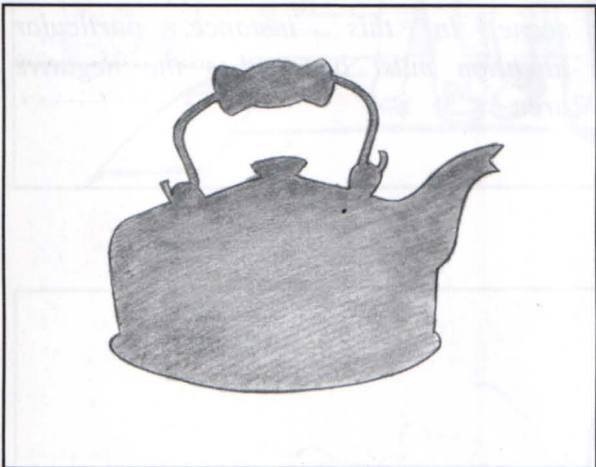
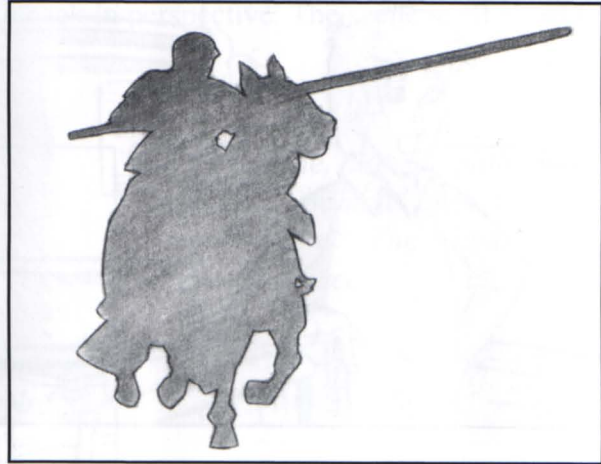

Sometimes special effects can help establish the mood of the scene. Using silhouette can add a touch of mystery or drama to a scene.



Framing



Once we have decided where to place our characters on the picture plane, it is important to keep the audience's attention focused in that area. The area of attention is called the *focal point*. In order to keep the audience's eye from wandering too much, we frame the action or spot on the screen that we want them to watch. A badly designed or located prop might lead the audience's eye away from the action, or lead the eye off screen altogether. Boots, shoes etc. are indicative of travel, therefore it is a good idea to have the toe of the boot pointing towards the characters.

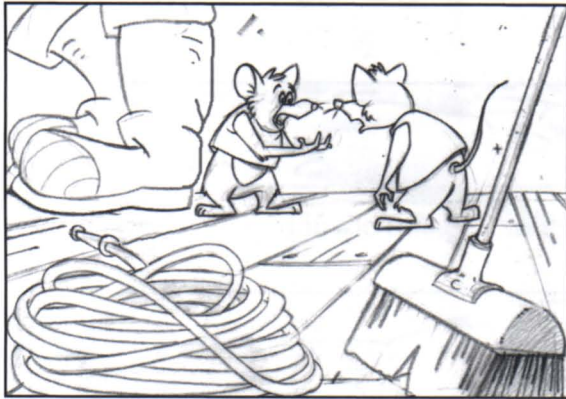

In this shot the hose, brush and boots lead the eye away from the action and subsequently off screen.

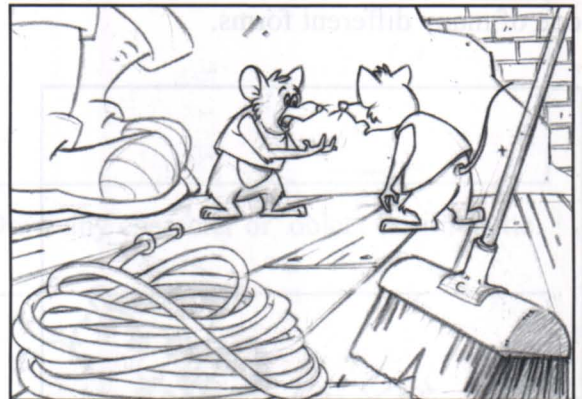

This can be rectified by pointing the hose in, adding another prop to lead the eye back in from the brush, in this case, the broken plaster and by pointing the boots in.

Methods of framing in a layout.

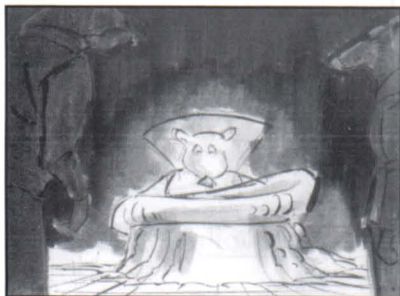

Characters held in the foreground



Spot - lighting.



Highlighting edges.



Wood, rope etc.



Props.



Natural elements



Rest Areas

In every movie or TV show there may be moments when the action may be quite intense for some time, or the scenes are choc-a-block with props. When this happens, it's a good idea to add a scene or two where the audience can 'rest their eyes'. To accomplish this, we will add in rest areas for the audience's eyes to wander into. The same rule can also apply to a particularly long scene, where the audience's eyes will begin to wander and again it's a good idea to give them somewhere to go. A rest area is a space on the layout where there is a large predominately clear area. It can take any one of many different forms.



The sky

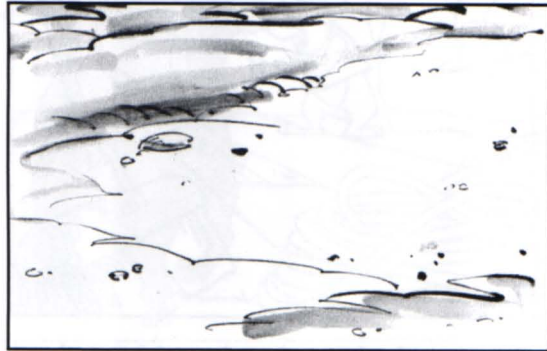

The ground



A wall

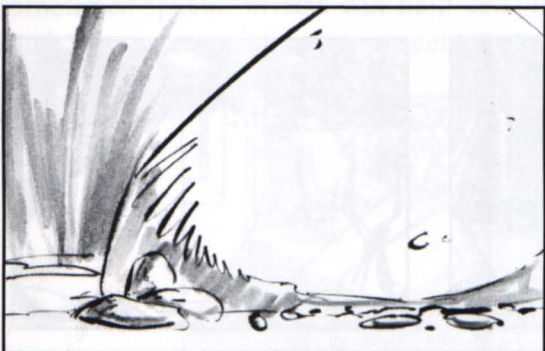

A rock

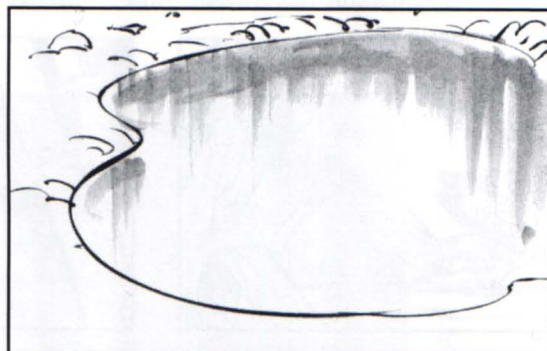

Water

Assignment



Draw the grid used in the rule of thirds.



Draw any character or object in silhouette.

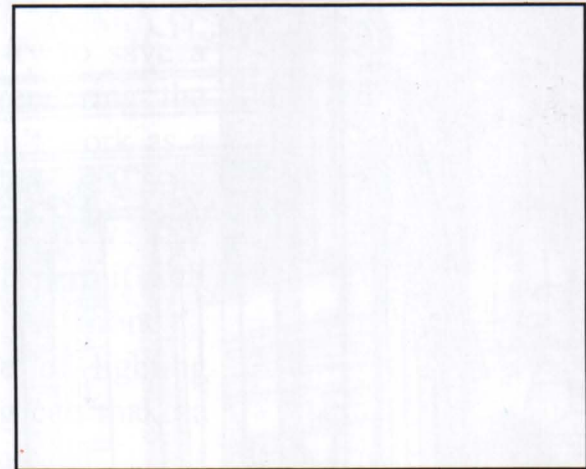

Draw any two rest areas other than the ones previously given.

Answer the following questions orally.

1. The general rule of composition is called what?
2. Why do we need focal points on our layout?
3. What might we use to choose the best composition for our layout?
4. Name some of the various methods used to lead the viewer's eye towards the focal point.
5. Why is silhouette important?
6. Name four methods of framing a layout?

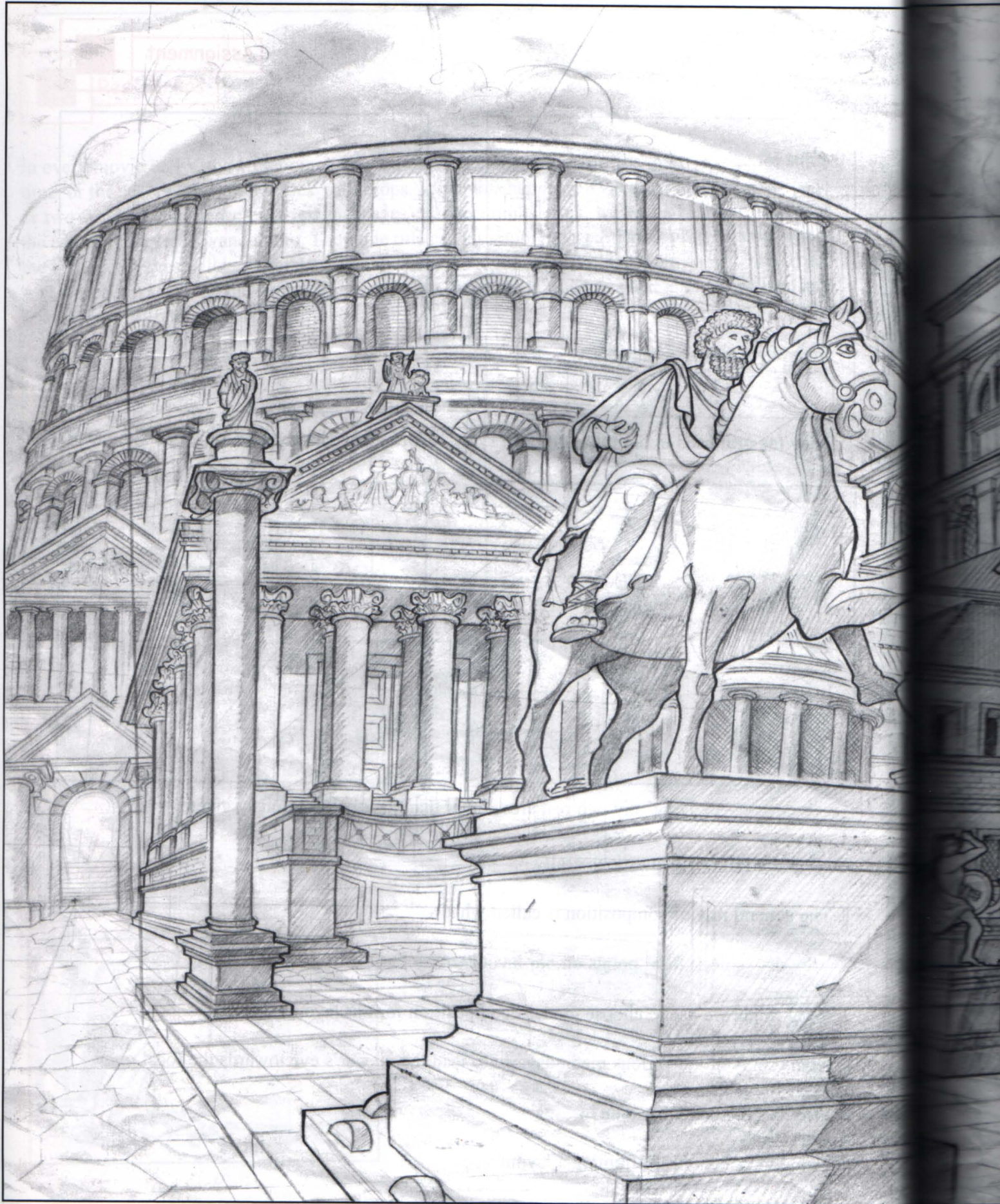



Lighting and Rendering

All too often, layout artists particularly beginners, try to save a weak layout by over-rendering the image. If a layout doesn't work as a line drawing it won't work as a fully rendered piece. Very few TV animation studios will permit full rendering as "time is money". However, effective use of lighting coupled with rendering can make a layout look quite dynamic.



Correct lighting is essential for good layout and good composition.

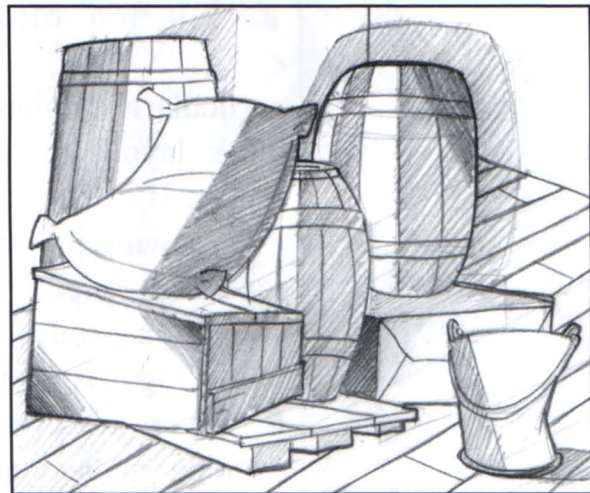

Inconsistent light kills illusion and makes for a bad layout and bad composition.

In most studios, the lighting of a scene is usually left up to the art director or background artist. The one thing the layout artist must do however, is to indicate from which direction the light is coming. This is indicated on the layout with an arrow drawn in red with 'light' written under. In studios with a large layout department, there is more time to render the drawing and the background artist is basically given a monotone version of the final background. The human eye sees intense colour, strong contrast, hard edges and black lines as being near, and sees soft contrast, soft edges and soft colour as far. Therefore it's important which line quality you use in order to give the illusion of depth (along with perspective) in your layout.

Bear in mind:

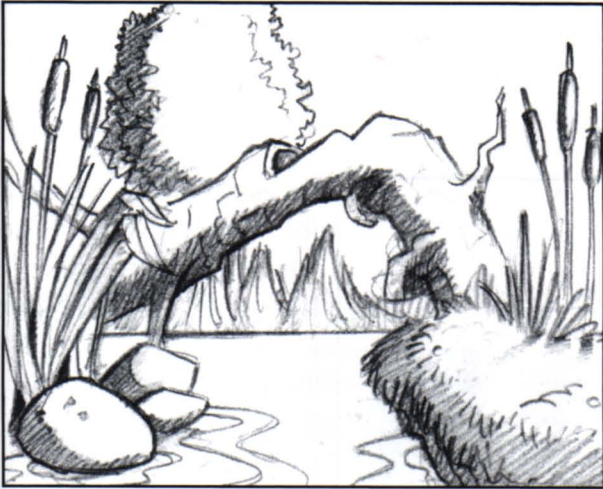

On a clear, sunlit day shadow patterns dominate.



On an overcast day local tones dominate.

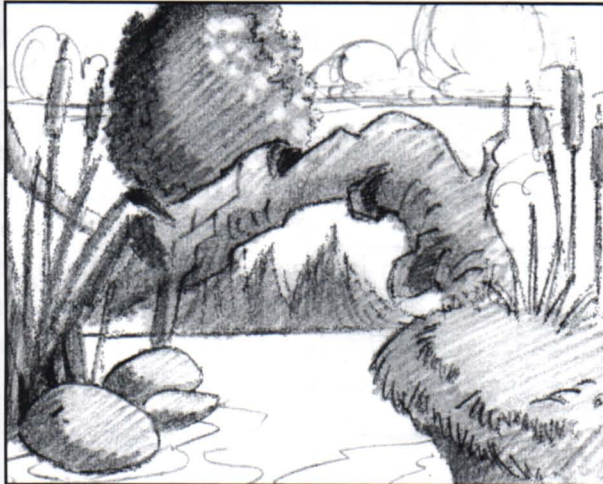

In hazy sunlight, a combination of shadow patterns and local tones dominate.



In moonlight, local tone and silhouette predominate.

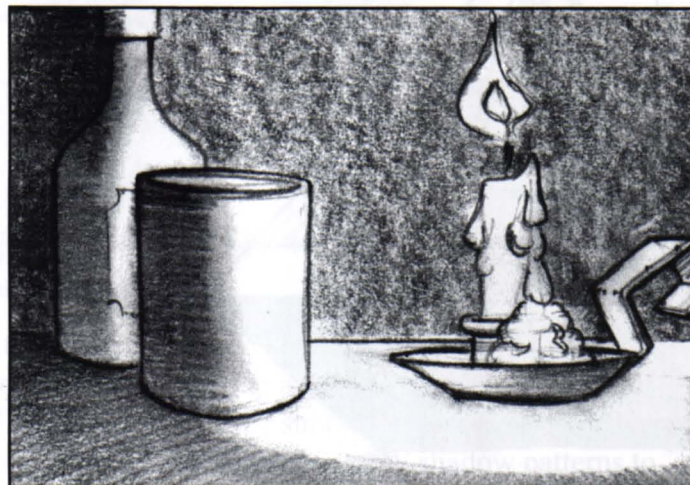

Artificial light radiates cast shadows, not fixed angles.

Working out Shadows

Natural lighting.

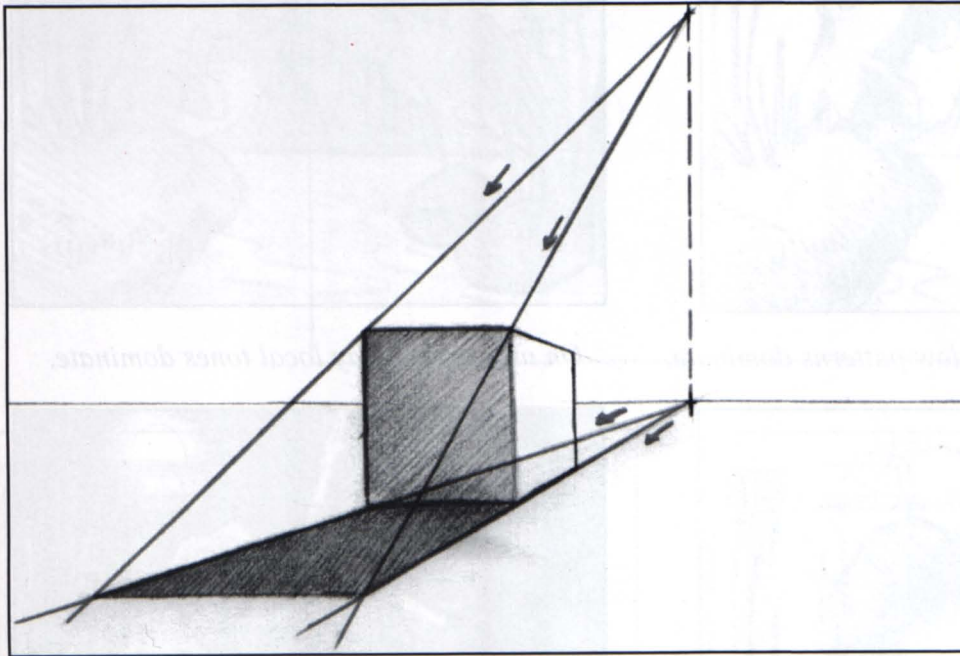

To establish the shadows for objects, first decide where the light source is. It's not always necessary to show the sun itself in an exterior scene. It is a good idea however to place a small cross on the layout so you'll have a reference point to work from. From this point, draw a vertical line down to the horizon line. To establish your shadows, draw a line from the light source through the top

front corners of your object, and a line from the point on the horizon line through the bottom front corners of your object. Where these lines intersect will give you the length of your shadow. Remember that the higher the light source, the shorter the shadow, and vice versa. The technique for establishing the shadows for multiple lighting is the same as for a single light source.

Artificial lighting.

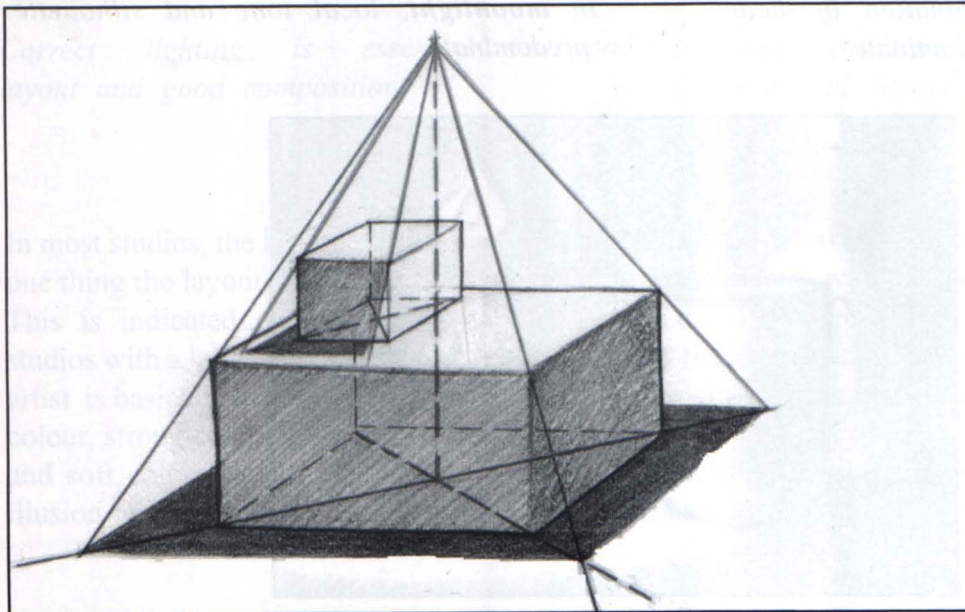

For internal scenes, a line is dropped from the light source to where it meets the floor. From here, a line is drawn through each corner of the props. A second line is brought from the light source through the topmost corners of the props. Where these lines meet gives the length of the shadow.

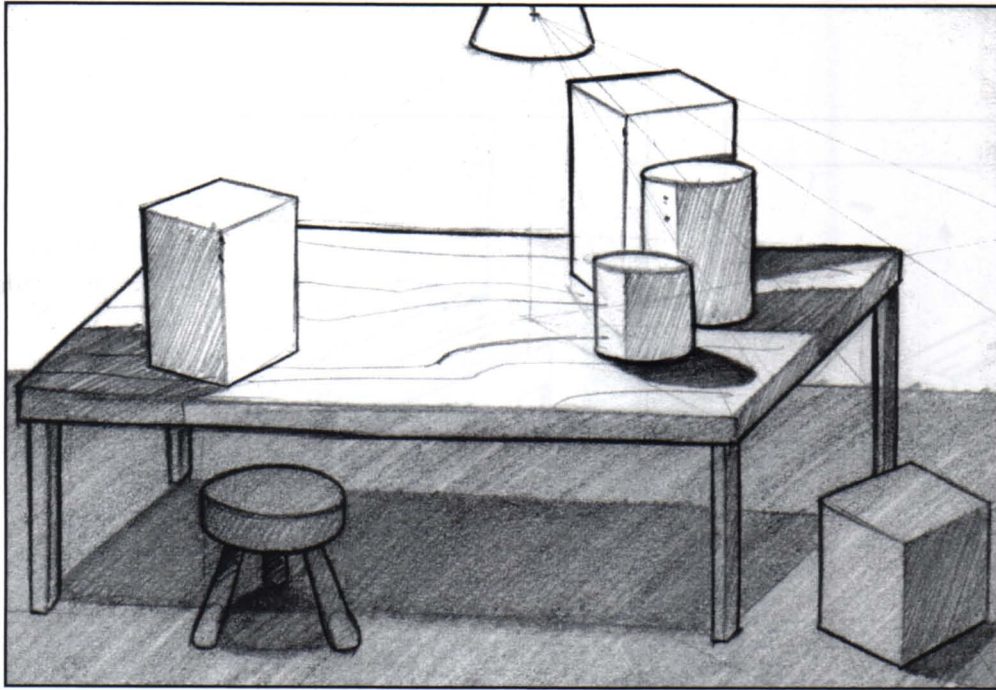

'Technically correct' lighting.

Where the shadows overlap, a third tone which will be a shade darker than the single cast shadows, will appear.

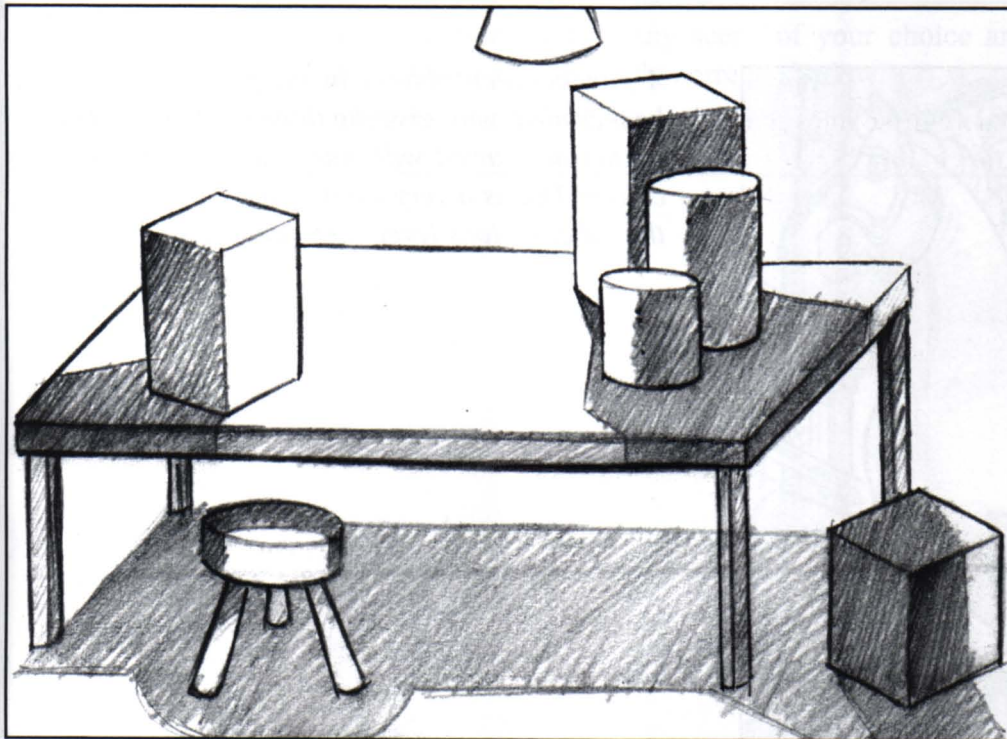

'Artistic licence', using lighting as part of the composition.

It goes without saying that it is important to stick to the rules of lighting when working out shadow patterns. However, playing around with the cast shadows can embellish the overall composition of the shot. More often than not, a professional artist will deviate from the 'technically correct' shadow patterns to make the layout a more exciting light-struck image.

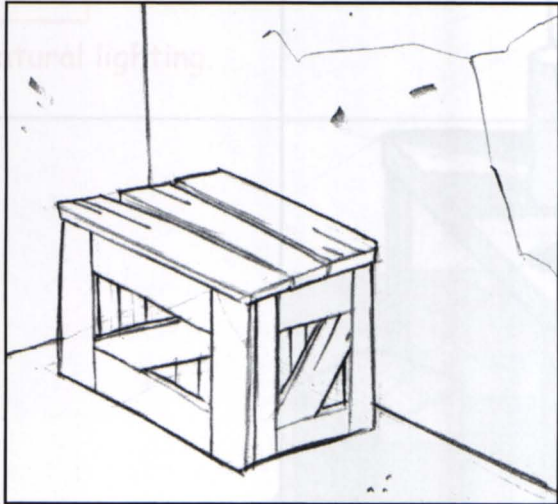

Leaving the area behind the box clear gives the impression that the box is away from the wall.

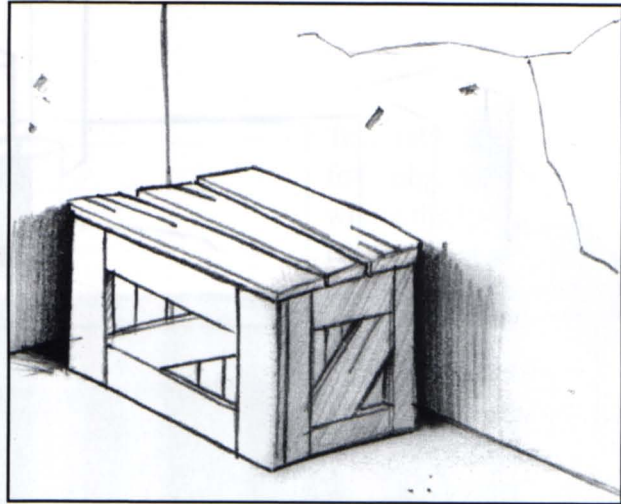

A darker area behind the box makes it look like it is nearer the wall. They are in fact the same distance.

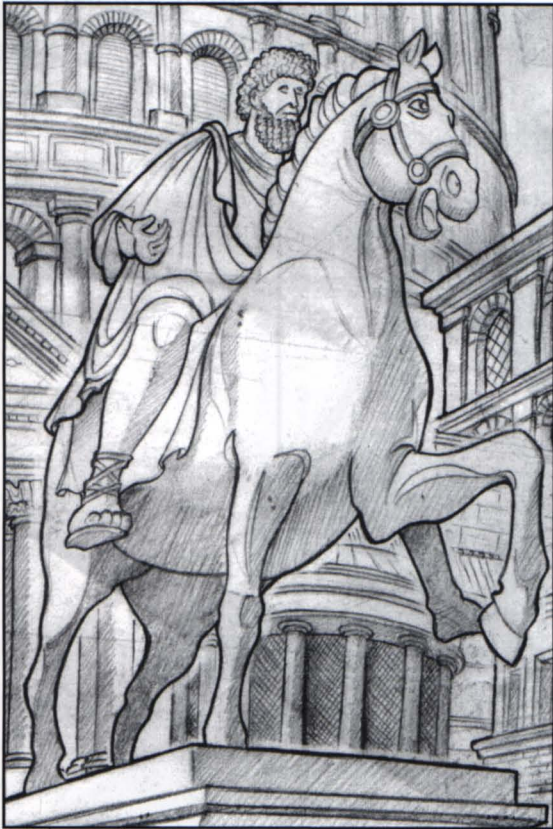

A gap between objects in the foreground and background will give the illusion of depth. The background artist will paint this area in a flat colour. This is a very subtle trick that works on the subconscious level of the audience.

Assignment

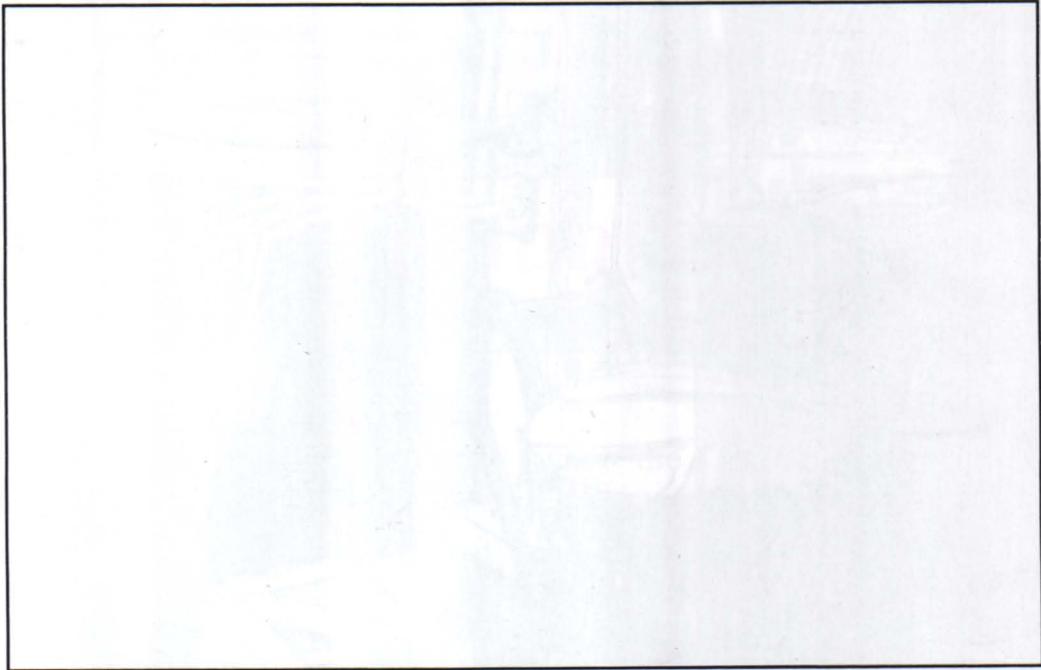

Draw a thumbnail of any scene of your choice and render with a 'technically correct' shadow.

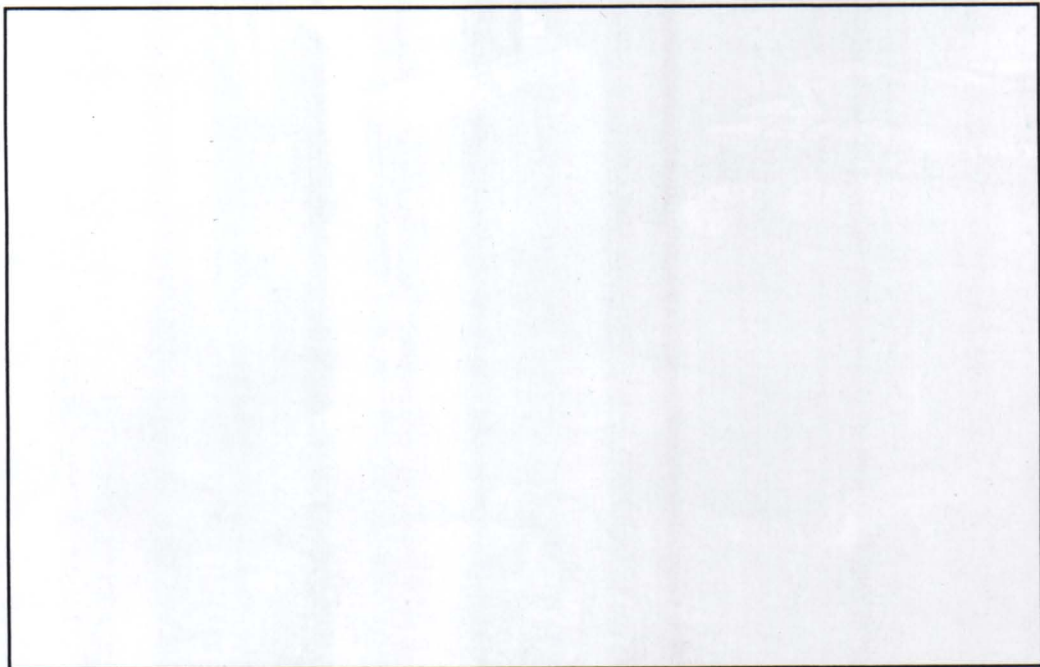

Using the same scene as above, now render it using 'artistic license'.





Staging

Irrespective of what the production is, be it live-action, animated or computer-games, careful consideration is always given to the placement of the characters within their environment. We call this 'staging'.

Staging is the area in animation where we pay particular attention to the placement of the characters and everything surrounding them within their environment. Unlike watching a live stage play where the audience take their seats and can only see the action from one angle, in the animation world we take the audience and bring them in and around the stage itself. Staging is pretty much about the composition of the scene. So have another read of the chapters on composition and framing.

Some of the principles of staging that the storyboard and layout artist should keep in mind are:

- **The Centre of Interest.** The audience will look where you want them to look;
- **Balance.** Without being too symmetrical;
- **Framing.** Controlling the eye movement of the audience;
- **Lighting.** A light-struck background adds depth and is an important factor in the composition of the scene;
- **Posterizing.** Simplifying the image into light and shadow;
- **Variety;**
- **Rhythm;**
- **Design.** Especially through research.



The whole point of staging is that the characters have somewhere to perform. When designing your layout, consider the implications involved if it were the design for a theatre stage. Are there any badly positioned objects or props that would get in the characters' way?

The storyboard artist will have greatly considered the staging elements of the scene. A good layout artist will embellish these without trying to fix what isn't broken.

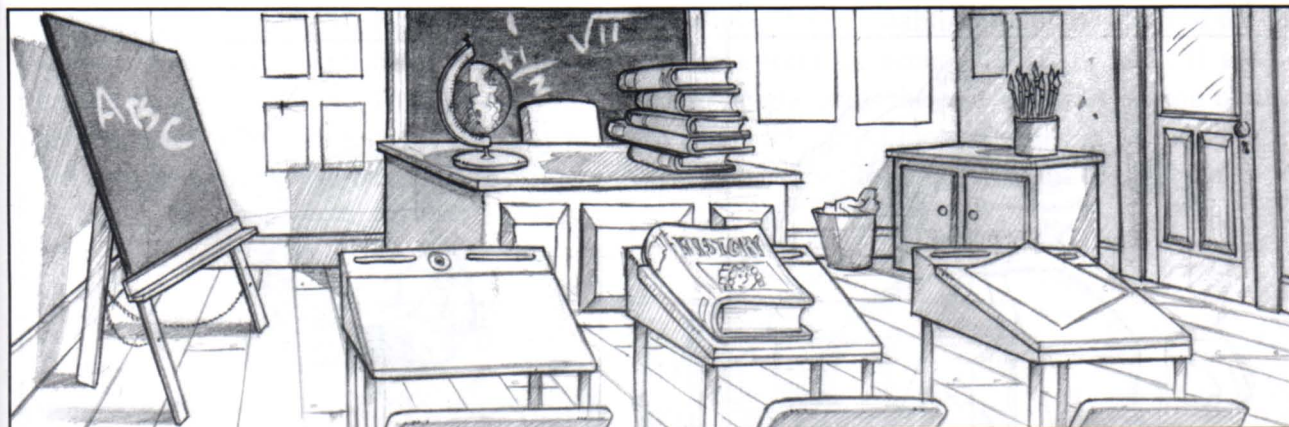

This is an establishing shot of a classroom. We have established most of the room of which the audience will have built up a mental picture.

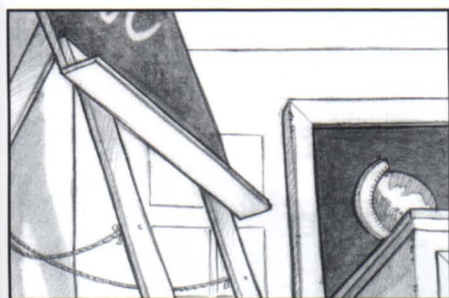

Changing the height of the camera to an upshot is no problem.

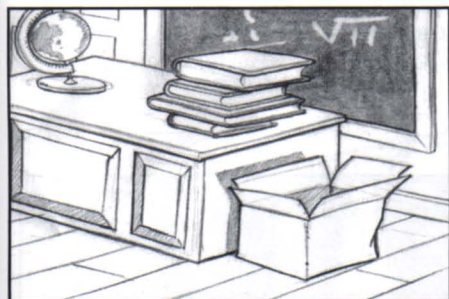

Here, the box beside the desk is okay, even though it is not in the establishing shot. The desk has been established and the audience would subconsciously accept that the box could be there.

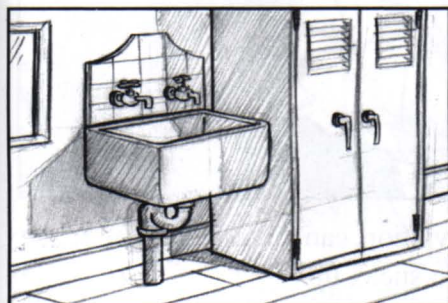

The cupboard and sink shown here were not shown in the establishing shot and may only confuse the audience. They could be included by somebody referring to them in a previous scene, and then seen going over to them

The camera angle that you choose will also add to the drama and mood of the scene. Choose angles and props that will reflect this.

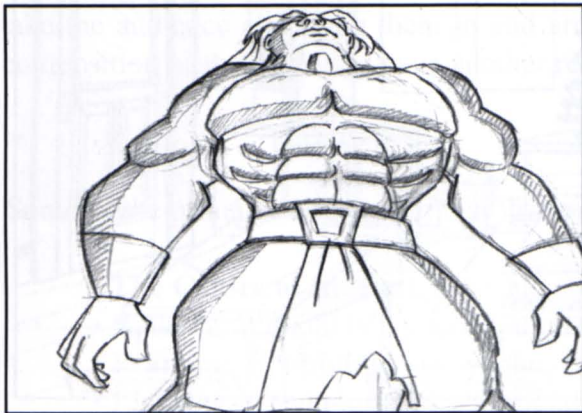

Up-shots emphasise awe and power.



Downshots emphasise weakness etc.



Straight-on, narrative, business-like.

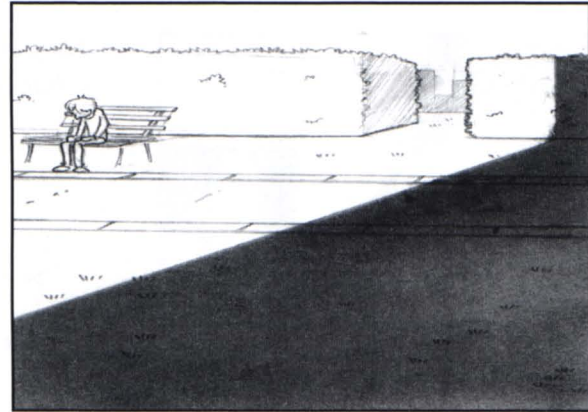

Long shots can create solitude and isolation.



Use of angles (over the shoulder) emphasises space and can indirectly emphasise power.



A slight deviation can give plenty of space for danger to sneak up.

Characters in Dialogue.

It would be a bizarre movie that didn't have characters involved in dialogue at some stage or other (although some TV shorts quite often don't) so we'll have a look at putting some scenes together that include dialogue. Let's assume that you have established the position of the characters with an establishing shot in the scene, or in a previous scene. Here Jack and Jill are having a conversation. They are about the same height and they are standing facing one another. Jack is standing approximately half way along a box. Jill looks like she is standing in the middle of a doorway, but if you follow the grid line at her toes, you will notice that she is in fact a few inches in front of the door.



Over Jack's shoulder.



Over Jill's shoulder.



Downshot

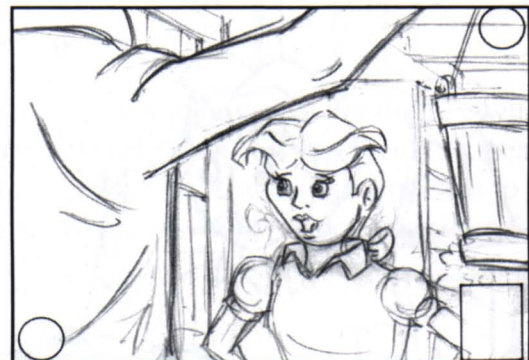

Framed

Spatial Relationship



This is a poor shot. Jill should always be looking to the left, unless we had previously seen her walk behind Jack and turn around.

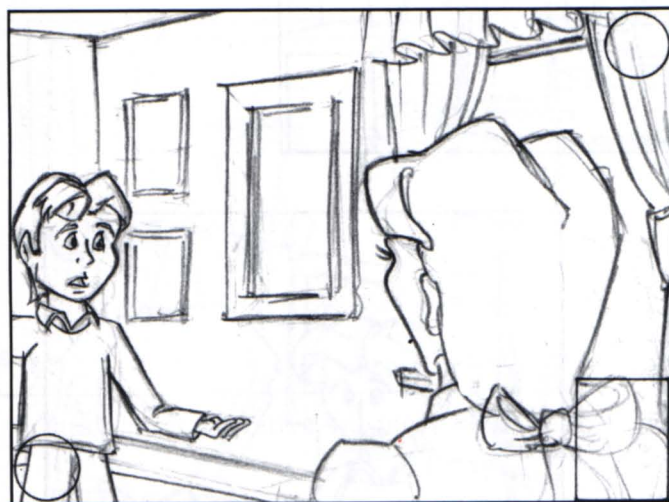

Here, the two characters are too far apart.



Here, the characters are too near.

Part of the success in staging depends on how quickly the audience sees what is being portrayed. Unlike reading a book, the audience will get one quick look at the scene, therefore it's important to try and get the message across immediately. Having said that, with so many people owning video-players nowadays, the audience have ample time to view the scene as often as they like. Children in particular will watch a favoured piece of animation over and over and over. This however doesn't stop storyboard and layout artists adding a personal gag into the scene. The addition of their own car parked at the kerbside complete with their own number plate, or a satellite dish in a medieval town or even a street named after themselves is not uncommon.

Jump Cuts.

Jump-cuts are the bad-boys of scene cuts. This is the result of poor fielding when reusing backgrounds, and results in too much of the background being revealed in the ensuing scenes.



Sc. 10 10 fld./4W ————— next scene —————> Sc. 20 10 fld./4E

This will happen if the scenes are running consecutively. If it was further down the line with several other scenes in-between, then it mightn't be as bad. When using cuts as transitions, bear in mind that it's better to go from say, a full-shot to a medium-shot, and a medium-shot to a close-up and not from a full to a full and a medium to a medium etc. (See 'camera transitions').

Group Shots.

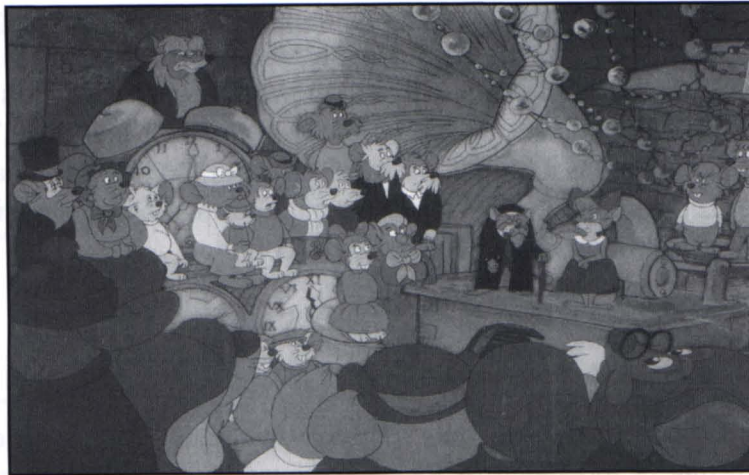

Incidental characters in the foreground and background are generally darker. Important characters are highlighted using brighter colours. Below are two methods of drawing attention to characters in a crowd.



Method 1.

The old mouse in the picture above waits until the young girl mouse has finished talking. We then cut to a close up of the old mouse as he delivers his speech.



Method 2. (Using sound)

When the young girl mouse in the group shot has finished delivering her speech, we then hear the sound of a bell ringing. The camera then cuts-to or trucks-in to the mouse sitting behind the clock.



Quite often movies centre on or at least include a journey of some kind or other. Directors often like to make the action go from screen left to screen right when the characters are going on the journey and screen right to screen left when they are coming home. You can of course do the opposite if you so desire, the point being that all of the action goes in one direction on the way out and the opposite direction on the way back.

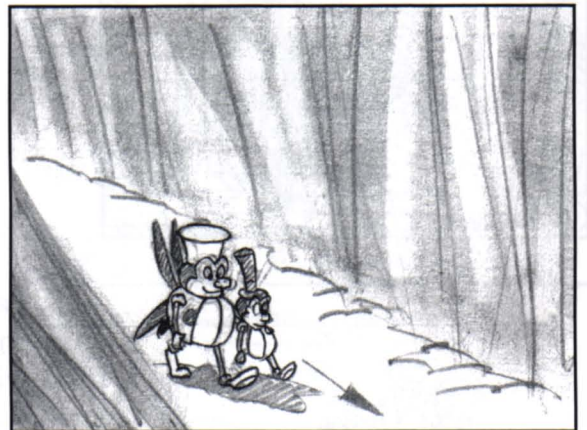
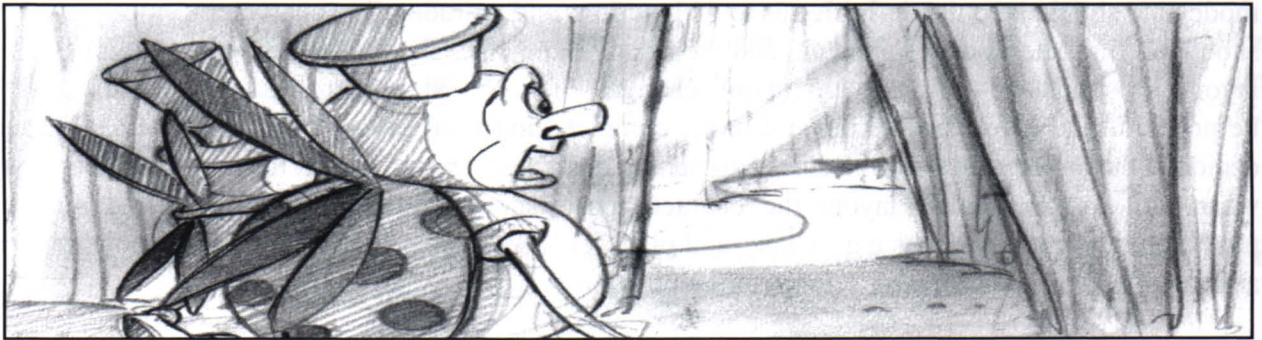

Here we have a medium shot of two characters moving screen left to screen right, cut to a long shot still going left to right and then to an extreme down shot. If the second shot had them walking in the opposite direction, then the audience may become confused as to where the characters were going. It's like watching a football game on TV, with the cameras always on one side of the playing field. If a player were seen running left to right up the field with the ball, then the camera cut to a medium shot with the player running right to left and scoring a goal, then the spectators would assume that the player had changed his mind, turned and scored an own-goal! Having said that, it does happen during a game that the camera switches sides, but the TV station will include a subtitle with something like 'Opposing View' written up in order not to confuse the viewers. Subtitles such as this would look very silly in a movie, unless they were included as part of a gag.



Character Layout

Among their many other tasks, the layout artist is also responsible for 'Posing-out' the character levels. This means taking the storyboard and redrawing the characters so that they are working in tandem with the background. These are the poses that the animators will then use to do their job. Quite often, a storyboard will be sufficiently strong enough that the poses can be taken directly from the storyboard itself and the layout artist will have little to do to embellish them. The characters themselves don't have to be fully detailed or rendered. They do however have to be on model and should be quite definitive as to their actions and attitudes. The character's emotional state should define their body language and their body language should define your drawing. If the layout artist wishes to make any major changes, then the storyboard department must always be notified. The layout artist does not have complete and final say in the scene set-up. He must decide if the storyboard poses need strengthening and must always be careful not to try and repair what isn't broken. In TV layout, the character poses should match the model sheets as much as possible. In computer games e.g. 'Click and play', choose a pose that can be easily looped when animated, so that the character returns to the position at which it had started.



Storyboard panel.



Layout artist will pose-out the characters from which the animators will work

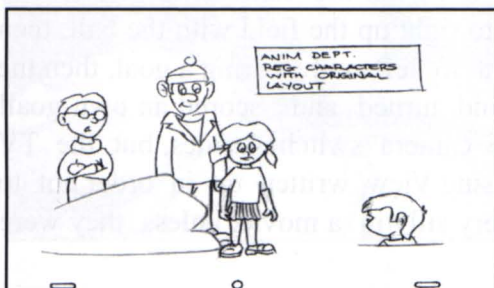

The layout artist should not drastically change the position or action of the characters.

Here's a method of using a pan to move from one character to another.



"He's over there"

Incidental character leads the camera over to where the other character is.

Camera stops at main character and starts to truck-in as the incidental character walks off-screen.

Using a short pan is another method of using incidental characters to get to the main characters. After the character has delivered his line, the camera pans 2 fields east.



"He's over there"

Sc.10 10 fld. C pan 2 East C

Cut-to



Sc.20

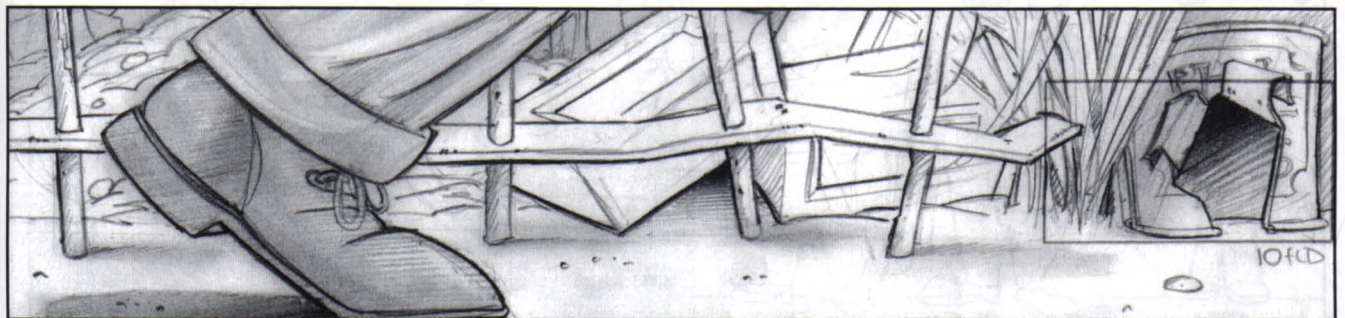

Here we follow the feet of an incidental character along a footpath. As the incidental character passes by where our main character lives, the camera begins to truck in. This could be quite a long pan.

Match or Reg. Lines

In almost every piece of animation we watch, we will at some stage see the characters go behind an object. When this happens, we must register the character to whatever it is the character goes behind. The character can either be registered (R) to the prop, or the prop can be put on an overlay, as previously mentioned. The most commonly used option is to simply register the characters to whatever it is they are going behind.

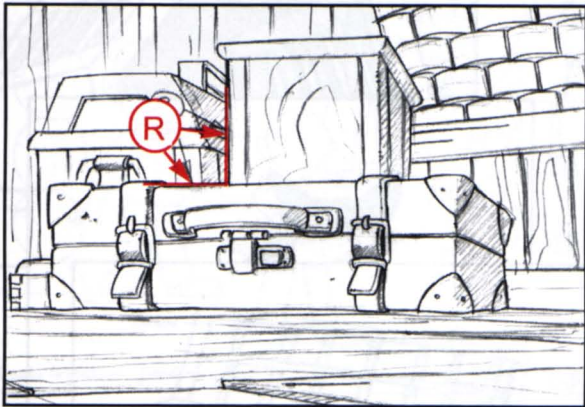

Matchline indicated on the original layout,

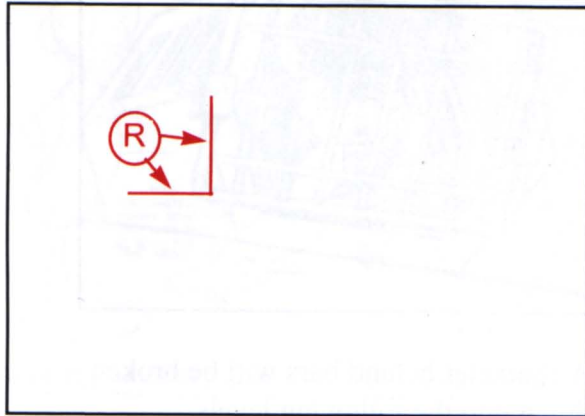

or on a separate sheet.

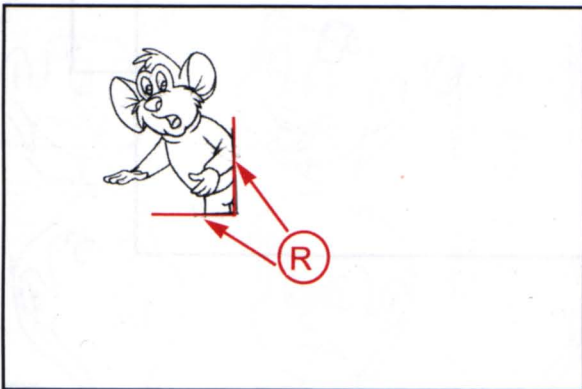

Cleaned-up character level will look like this. The line on the character that registers with the box will be inked the same colour as the box itself.

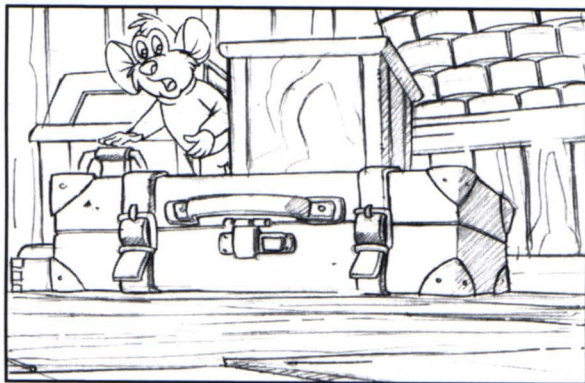

Final image.

The matchline is always drawn in red and is indicated with either an (M), (R) or (ML) and an arrow pointing to the line. It is important that the background artist knows exactly where the matchline is, as he will paint a sharp line along the edge of the prop. Similarly, the clean-up artist will place each drawing of the character onto the matchline and trace it onto the relevant part of the character. This ensures that the character and the background match exactly and that there is no jiggling around in the scene. It is generally not necessary for the animator or clean-up artist to do any work below the matchline. The scene and sequence number are placed on each level of artwork. In a TV series, any reused piece of artwork will have the original numbers written in red. Although every studio has their own numbering system, this general rule still applies.

Layout Notation or 'Tattooing the Baby'



The camera instructions as we have seen, are always placed on a separate piece of paper. There are other notes and instructions however that need to appear on the original layout itself. Trainee layout artists and students can often be 'precious' about their artwork, and asking them to write notes on their layout is like asking them to tattoo a baby. What must be remembered is that the layout is what we might call, 'a working drawing'. By this I mean that the layout is not produced as a separate entity purely to be admired. Firstly, the animator needs the layout in order to get the perspective grid where the characters will act. It is also needed for the position of any registration lines and the position of props etc. The special effects animator will do likewise. For example, a river in a layout will have a grid indicated to show the animator which way it will flow in perspective. The background artist will also need the original layout from which to paint the background from, so, by the time the movie is finished, the original layout will have been well and truly handled.



Make notes clear and concise. The background artist needs to know exactly what he is painting.



A line drawing with a note to the background artist. Although it looks like a daytime shot, it will be painted as night. There is no need to use up a box of 6B pencils, consequently over-rendering the layout to a point where it is shiny.

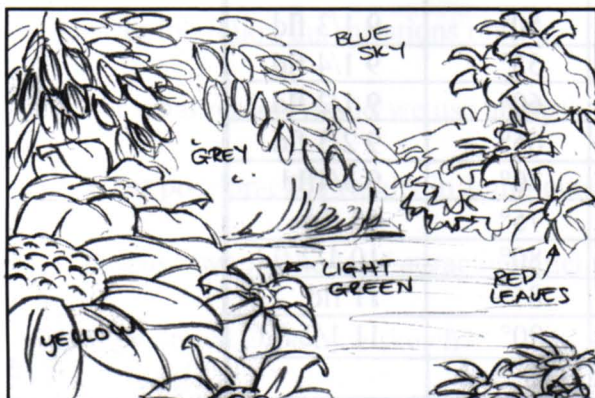

Do not write the colour of objects or the surroundings on the layout. This is not the layout artist's responsibility. The art director and background artist are paid handsomely to make these decisions.

In some of these shots previously mentioned, you will have noticed that the camera has rotated. Any time the camera rotates we must compensate with respect to the choice of field size in order to assure that the edges of the artwork don't show up on the screen. For example, with a 2fi° rotation on a 16 field set-up, the largest size available would be 15 field. For vertical pans the maximum fielding on a 16 field set-up is 11 fi field at 90° CCW and for a 12 field set-up the maximum fielding is approx. 8fi fields at 90° CCW rotation. The following chart gives an approximate idea of what the maximum field size the camera can be at, at a given rotation. The same chart applies whether the camera rotates clockwise or counter-clockwise. The advantage of these type of shots is that a relatively short background can be used in a cycle pan.

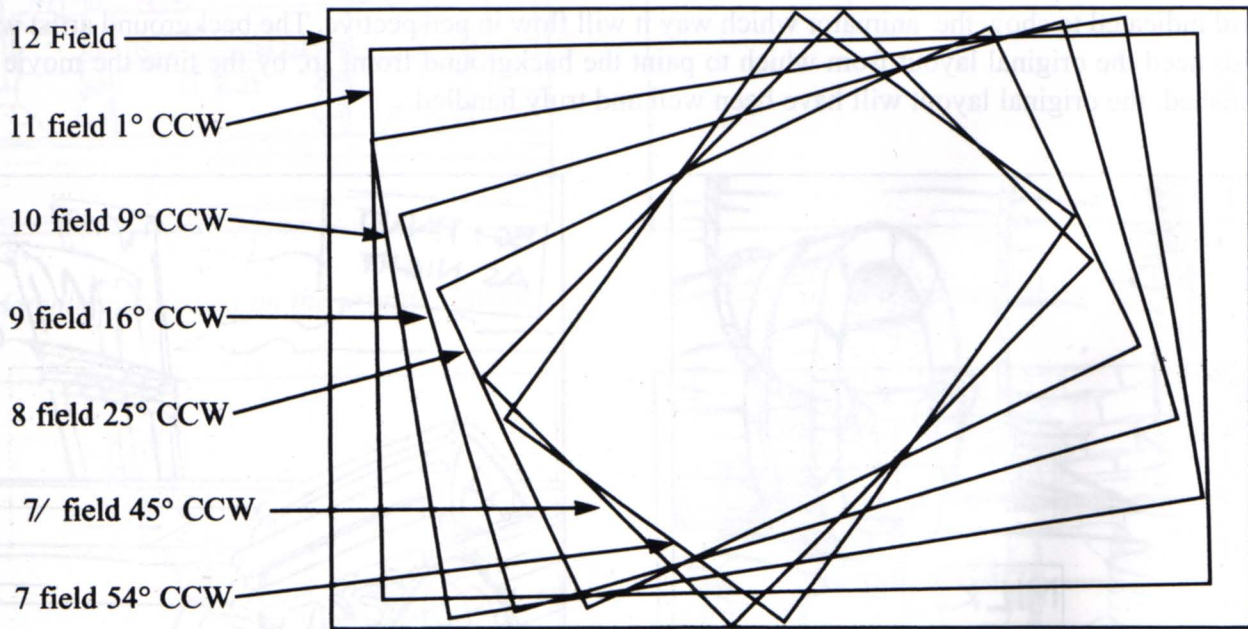

Tilt Field Limitations

| Rotation | Max. Field Size | Rotation | Max. Field Size |
|----------|-----------------|----------|-----------------|
| 2° | 15 fld | 50° | 9 1/3 fld |
| 5° | 14 fld | 55° | 9 1/4 fld |
| 10° | 13 fld | 60° | 9 1/2 fld |
| 15° | 12 fld | 65° | 9 2/3 fld |
| 20° | 11 1/4 fld | 70° | 9 3/4 fld |
| 25° | 10 3/4 fld | 75° | 10 fld |
| 30° | 10 1/2 fld | 80° | 10 1/2 fld |
| 35° | 9 3/4 fld | 85° | 11 fld |
| 40° | 9 2/3 fld | 90° | 11 1/2 fld |
| 45° | 9 1/2 fld | | |

Assignment



Using the sketch at the bottom of page 95, redraw the scene to give a better staging.

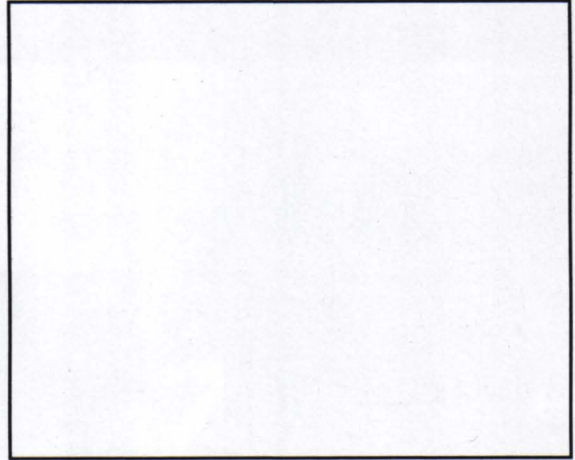

Draw a character using a shot that would emphasise weakness.

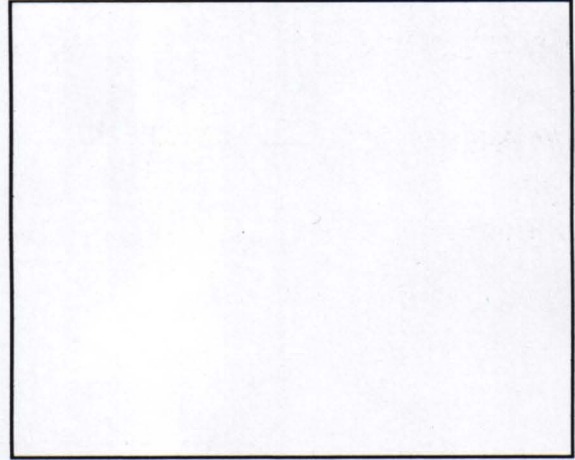
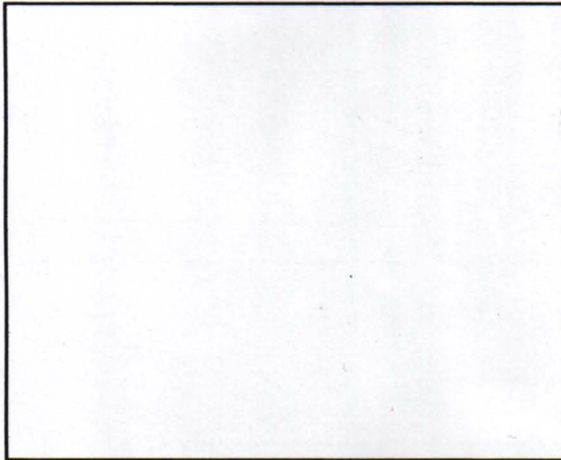

Draw two frames of characters in dialogue.

Answer the following questions orally.

1. For what reason would we use an upshot?
2. What poor practice results in Jump-cuts?
3. Discuss two methods of attracting attention to characters in a crowd scene.
4. Why do we use a blue sketch?

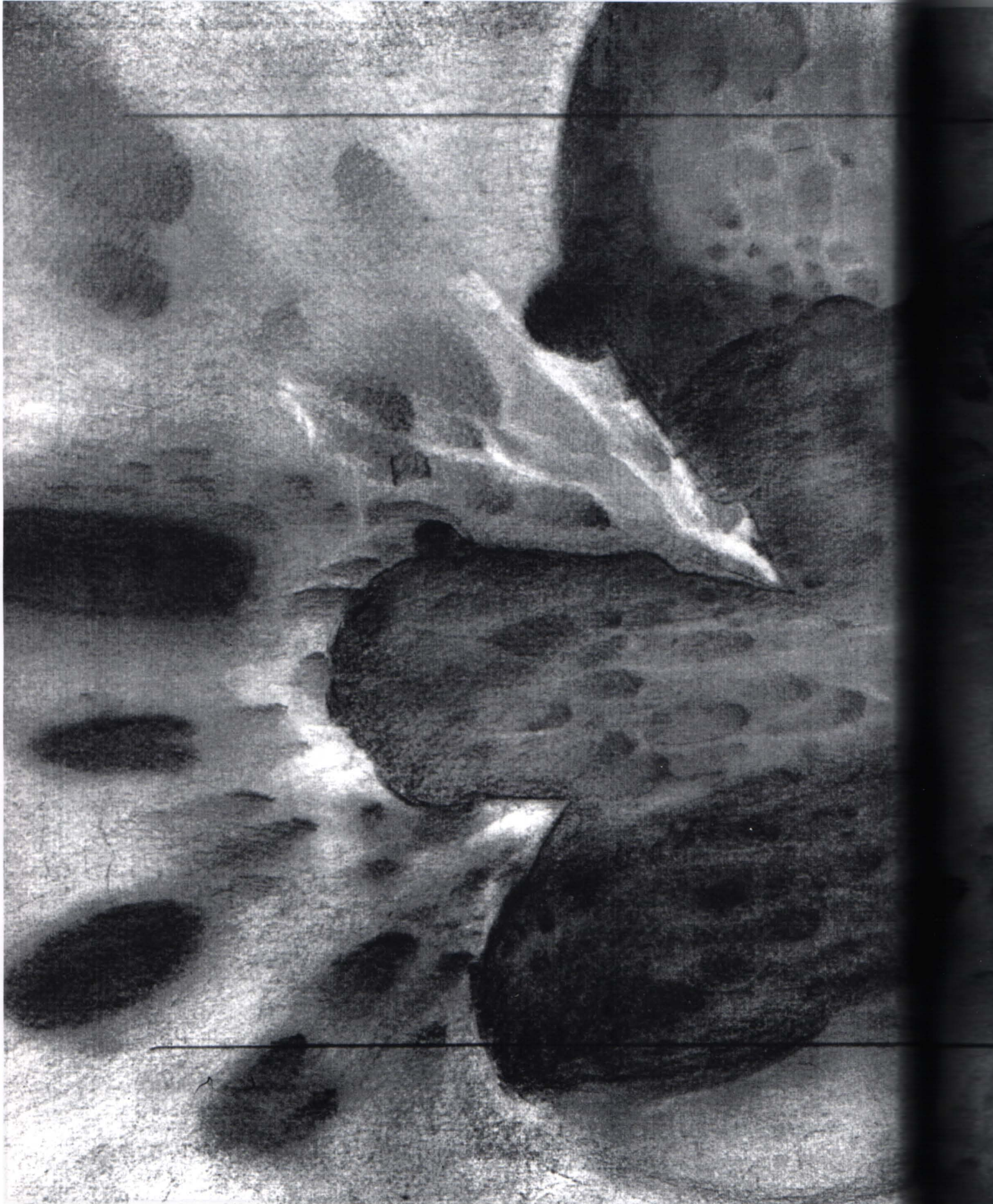

Techniques and Motifs

The techniques that follow, cover the basics of the most commonly used media in animation studios i.e., pencil or pen and ink. Although every artist has their favourite medium, it is usually down to the director or art director as to what type will be used in the project. It is advantageous therefore for the layout artist or storyboard artist to be proficient in all media. Motifs are symbols or marks on the layout which denote to the background artist what the object or props are made of.

Techniques

The vast majority of studios around the world use lead pencil in the production of layouts. I say studios as opposed to layout artists, because it is usually the art director's or film director's decision as to the style of the layouts. The two most commonly used pencils are the 2B and 6B. The preferred brand of pencil depends entirely on the individual artist. Try a few different brands yourself. A strong piece of advice though, is that 'expensive doesn't mean best'. Always place about seven or eight sheets of paper under your layout. It gives a much better line. It may be no harm also to place a small piece of paper under your hand to keep the drawing clean. Don't let your drawing look like it has been handled by everybody on the planet, by being grubby and dirty.

Lead Pencil

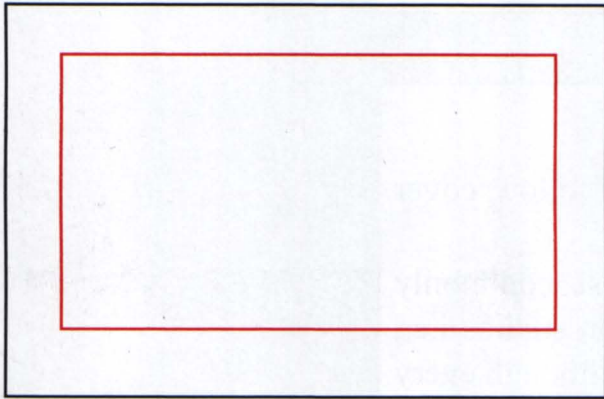

Start by drawing the cut-off.....

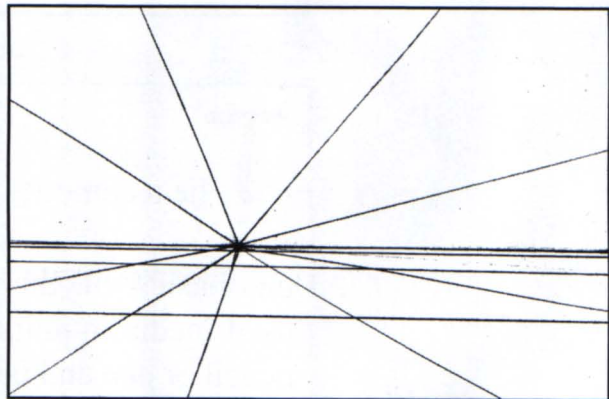

.....then add the grid.



The layout pencil tip should be flat to give a nice broad line. (left)

The animator's pencil is usually more rounded. (centre)

The clean-up artist's pencil is needle-sharp. (right)



Render the layout by using very fast pencil strokes back and forward across the page. It is for all the world - one long line. Do it like this, only a thousand times closer! Go over it a couple of times if you have to.

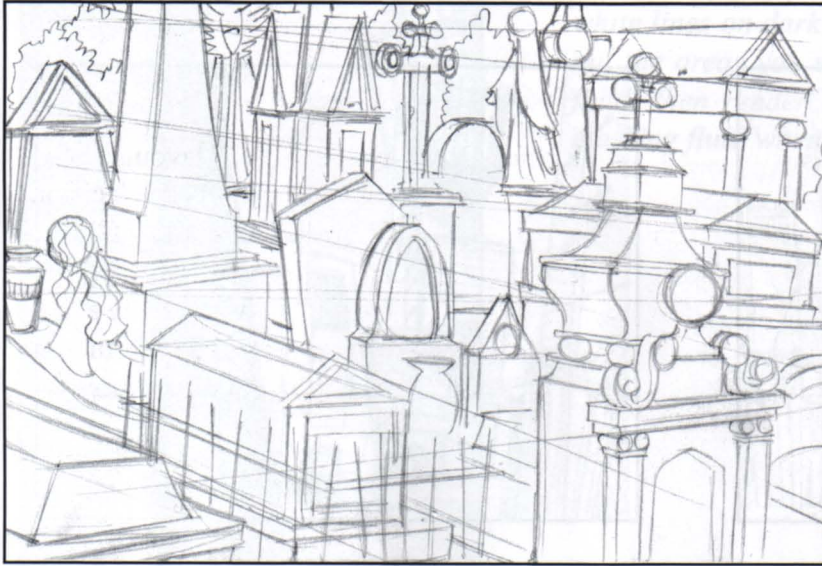

Lightly rough out the entire scene. Go back over the rough, but don't 'Clean up' the layout by using a sharp line. Try starting at the top right or left hand corner and work downwards to reduce the risk of smudging the layout. Use a variety of dark / light and thick / thin linework.



Ink / Marker

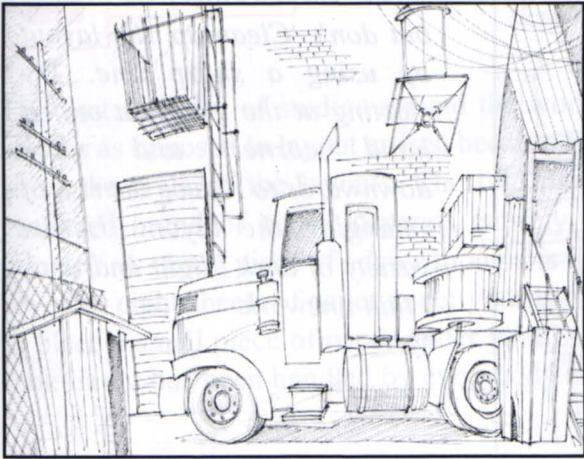

It's often a good idea to start off with a light pencil sketch.

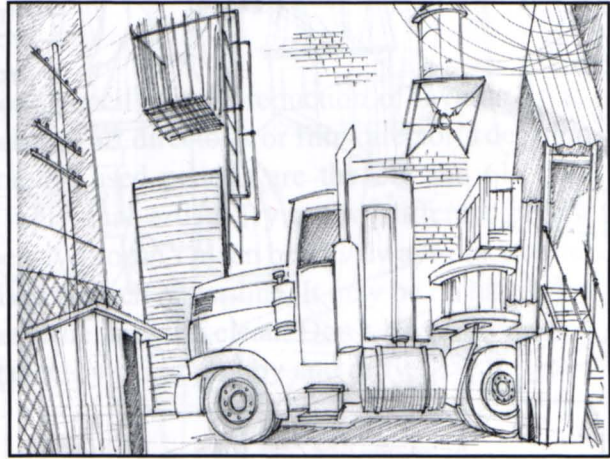

Go back over the layout with a fine-tip marker.



Finish the layout with markers of different thickness. If you wish, you can render with colour markers. Use either warm or cool grey (try different tones).



Use bleed-proof paint and a very fine brush to give the white lines on dark areas. Subsequently, you can paint out the areas you want to remain white with masking fluid, then render with the markers and rub off the masking fluid when you're finished.

Rectifying Mistakes on Ink Layouts.

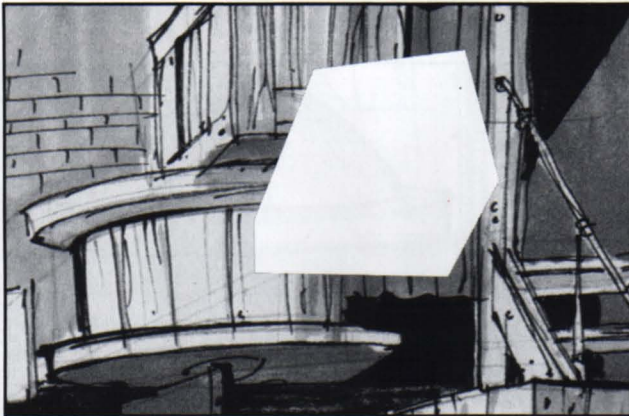

For ink layouts the cut-and-paste method is best. Put a clean sheet of paper under the layout and hold in place with removable tape. Cut through the layout and paper with a very sharp knife. Turn both pieces over and stick the patch on with permanent tape.



Finish off the layout as before.

Brush Pen

Brush pens can give excellent thick / thin lines with a single stroke. The technique is similar to that of ink. Again, the layout may be started by lightly roughing out in pencil.

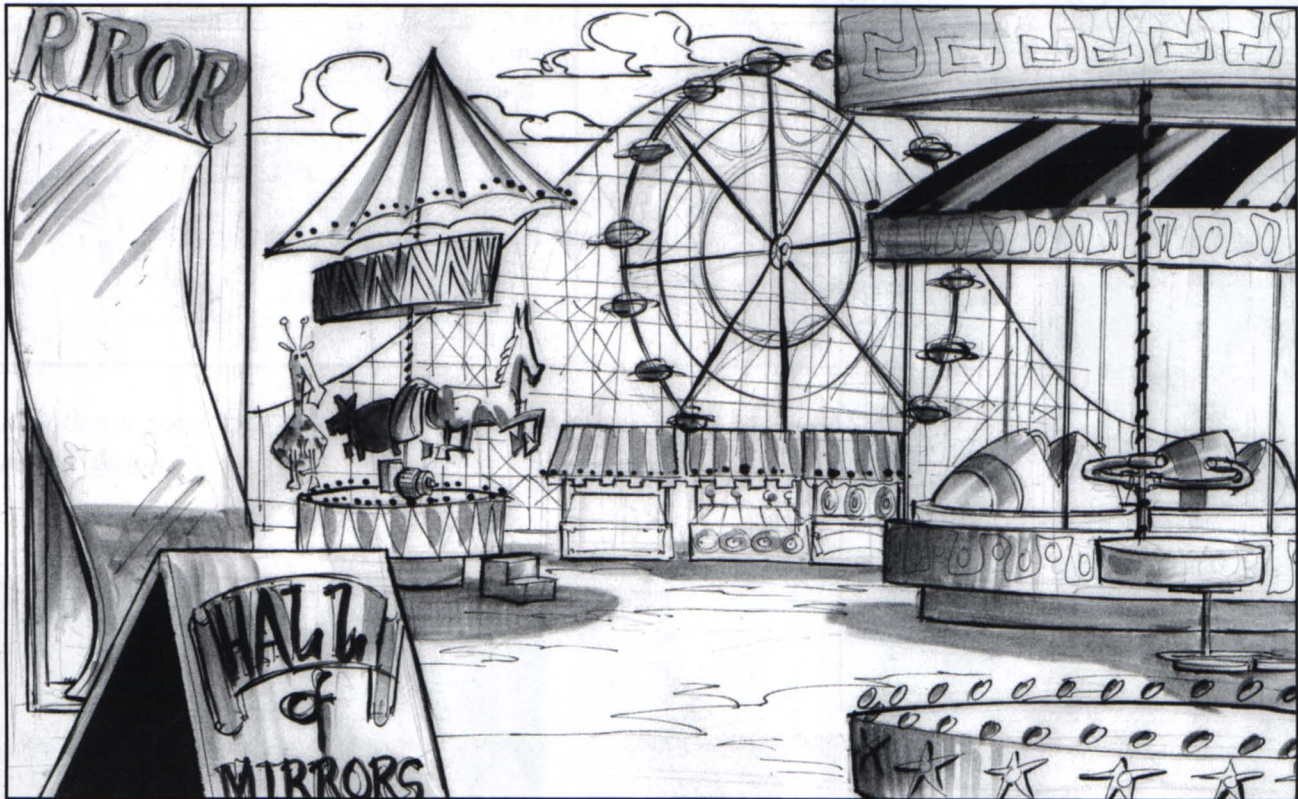

Mask off any areas you wish to remain clear with removable tape and shade in the rest as required.

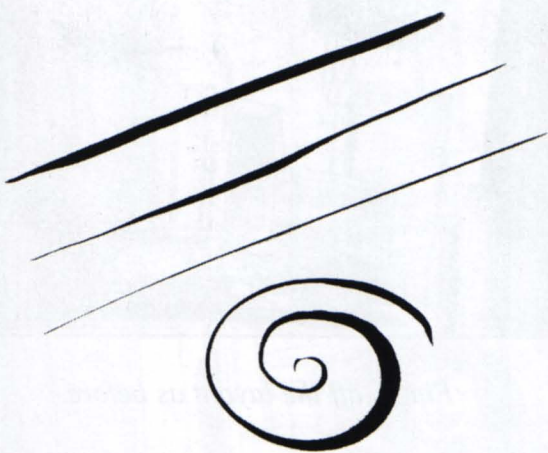

Brush pens can give an excellent variety of thick / thin lines.

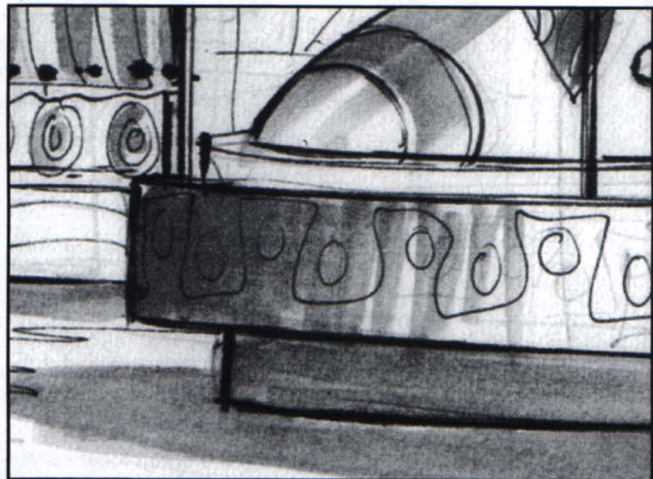

Grey shadow areas are done with old brush pens that are running out of ink.

Graphite Powder

Graphite powder layouts are in fact pencil layouts that use the graphite powder for all or part of the rendering. The powder can be applied using tissue paper, toilet paper or hand-towel. It's best to try all three to see which one is most suited to you. You can also try different brands. The different papers will leave different shades and quality of rendering. The layout is started as a light pencil drawing, as before. As with the previous two techniques, you can mask off any areas that you wish to remain clear. Graphite powder can be very messy and will undoubtedly get up your nose, so you may need to wear a protective mask. This technique can be long and laborious, but can lead to very pleasing results. Keep building up layers of graphite until you have the desired tones.



Use an electric eraser, putty rubber or hard eraser to pick out highlights. Use a burr stick for smudging also. Protect the layout with a layer of tissue paper (the type that dress-makers use) or with a proprietary fixative.

Charcoal

It's rare, if ever, that a production layout would be done with charcoal, although it's not uncommon for conceptual work to be done using this method. The advantage to using charcoal is that the work can be done much faster. The biggest disadvantage is the mess it makes. Once again, begin by roughing out the layout in pencil, or very lightly with a thin piece of charcoal stick, or charcoal pencil.



Interesting results can be had smudging with 'Burr sticks', tissues or your fingers. Charcoal can result in very moody layouts. Protect the final artwork with a proprietary fixative.

Cartooning



By cartooning, what we are trying to do is to take a real or imaginary object, and play around with its design so that it still *looks* real, but fits into a more make-believe world.

This is a photo of a real prop. Photos have little or no place in animation layout.



This is an illustration of the same prop. This type of drawing would have been more suited to advertisements or manuals.

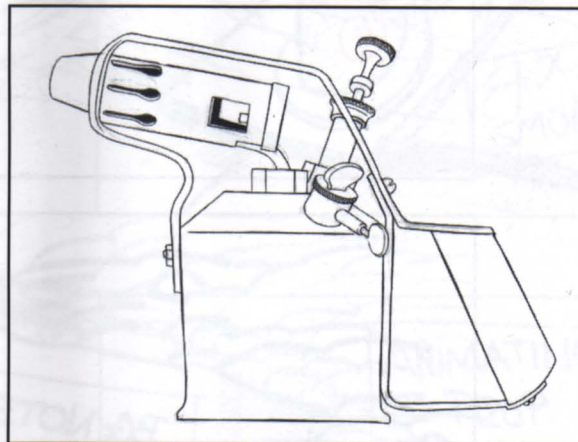

This is a cartooned version, again of the same prop. Note that there is much less line mileage and no ruler-drawn lines, which tend to lose the cartoon feeling. As you can see, plenty of artistic licence is employed.

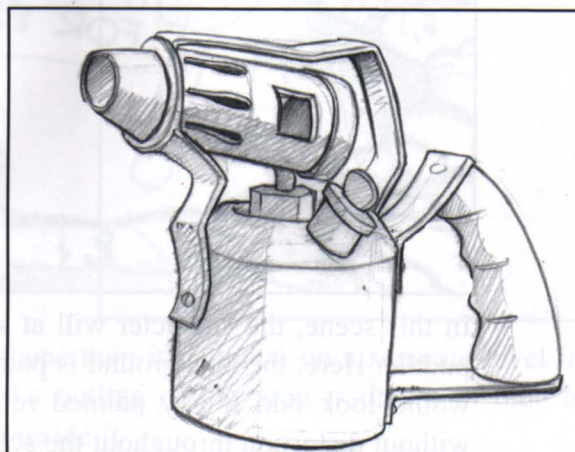

Special Effects

Special effects are normally animating elements. The layout artist can draw the effects on the layout in blue if he wishes, or he can simply draw a grid and indicate that it is for the animating elements. The special effects animator will design the effects. Studios tend to differ on the colour used to highlight effects, however blue is quite commonly used - with the exception of flames, which are usually indicated in red. As a layout artist, you can draw in the effects based on the storyboard. For flowing waters, it's ok to draw in waves, ripples etc. However, you must place a grid over the animating area so that the special effects artist uses the correct perspective for the scene.

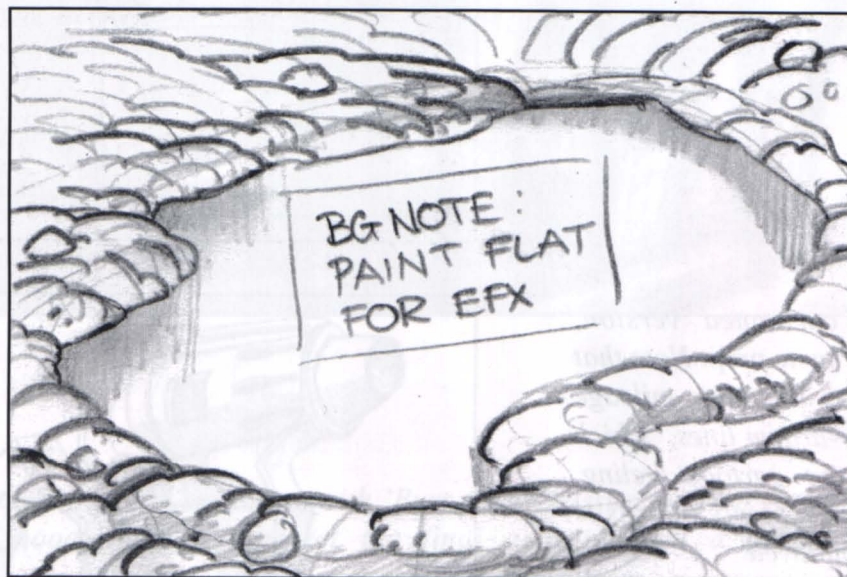
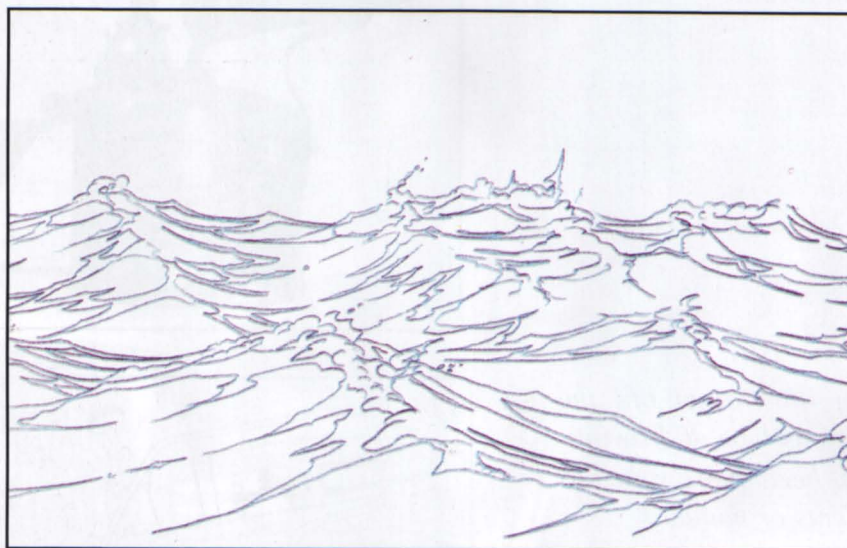

In this scene, the character will at some point walk through the puddle. Here, the background is painted flat, otherwise the scene would look odd if any painted reflections remained clear and without distortion throughout the scene.

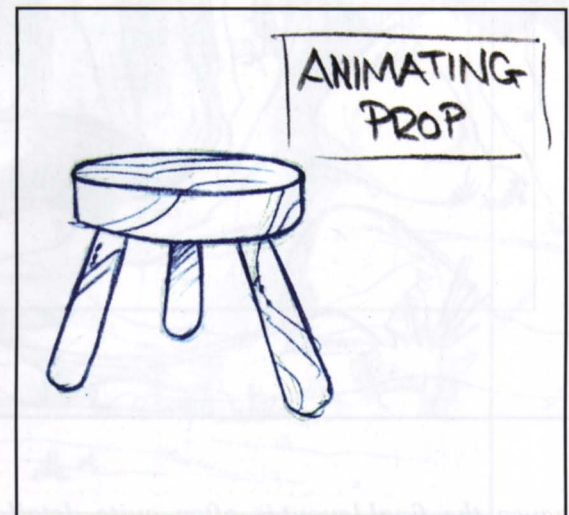
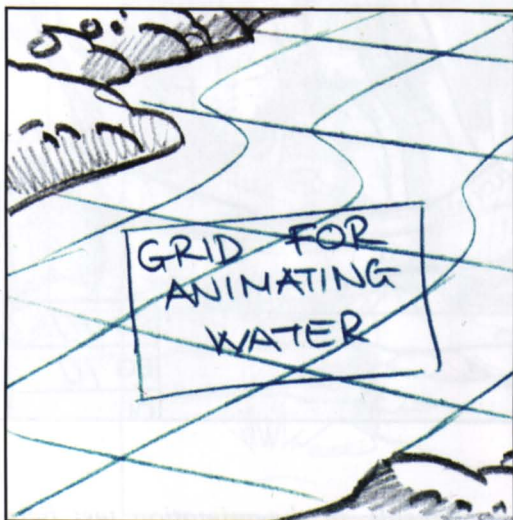
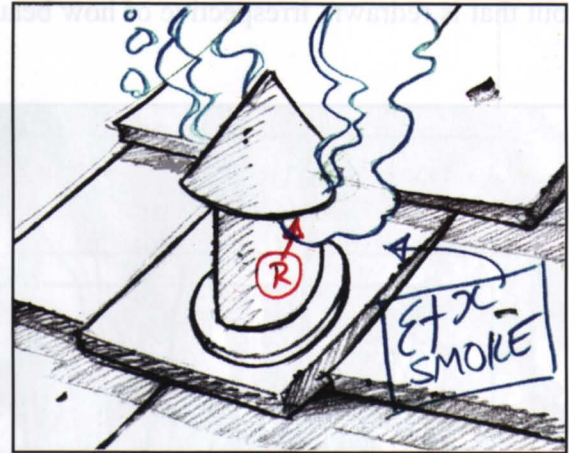
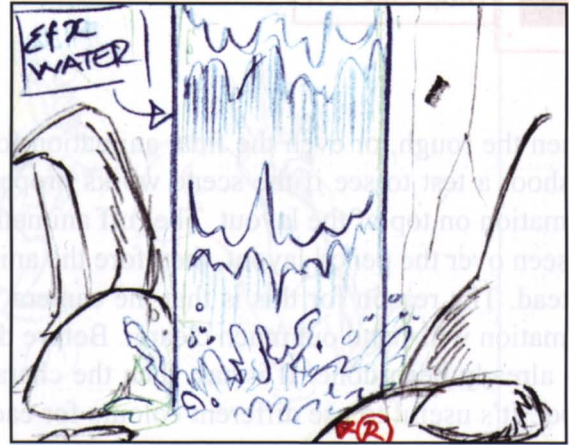
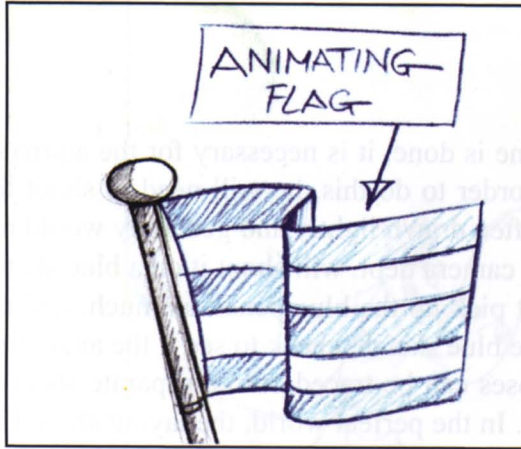

If a prop is going to animate later in a scene then it is drawn on a separate level in lead pencil with the note 'animating prop'. An outline of the prop is drawn in blue on the original layout with the note 'OL' written inside it.



Blue Sketch

When the rough, or even the final animation for a scene is done, it is necessary for the animator to shoot a test to see if the scene works properly. In order to do this, he will need to shoot the animation on top of the layout. The ruff animation is often drawn lightly and generally would not be seen over the pencil layout, therefore the animator / camera dept. will shoot it on a blue sketch instead. The reason for this is that the camera will not pick up the blue pencil as much, and the animation will stand out much clearer. Before doing the blue sketch, check to see if the animation has already been done. If it has, then the character poses can be traced onto a separate sheet of paper. It's useful to use different colours for each pose. In the perfect world, the layout should be done first, although this rarely happens. It's worth remembering that if there is an animated scene with two hundred character drawings and one layout that don't work together, then it's usually the layout that is redrawn, irrespective of how beautiful it is!

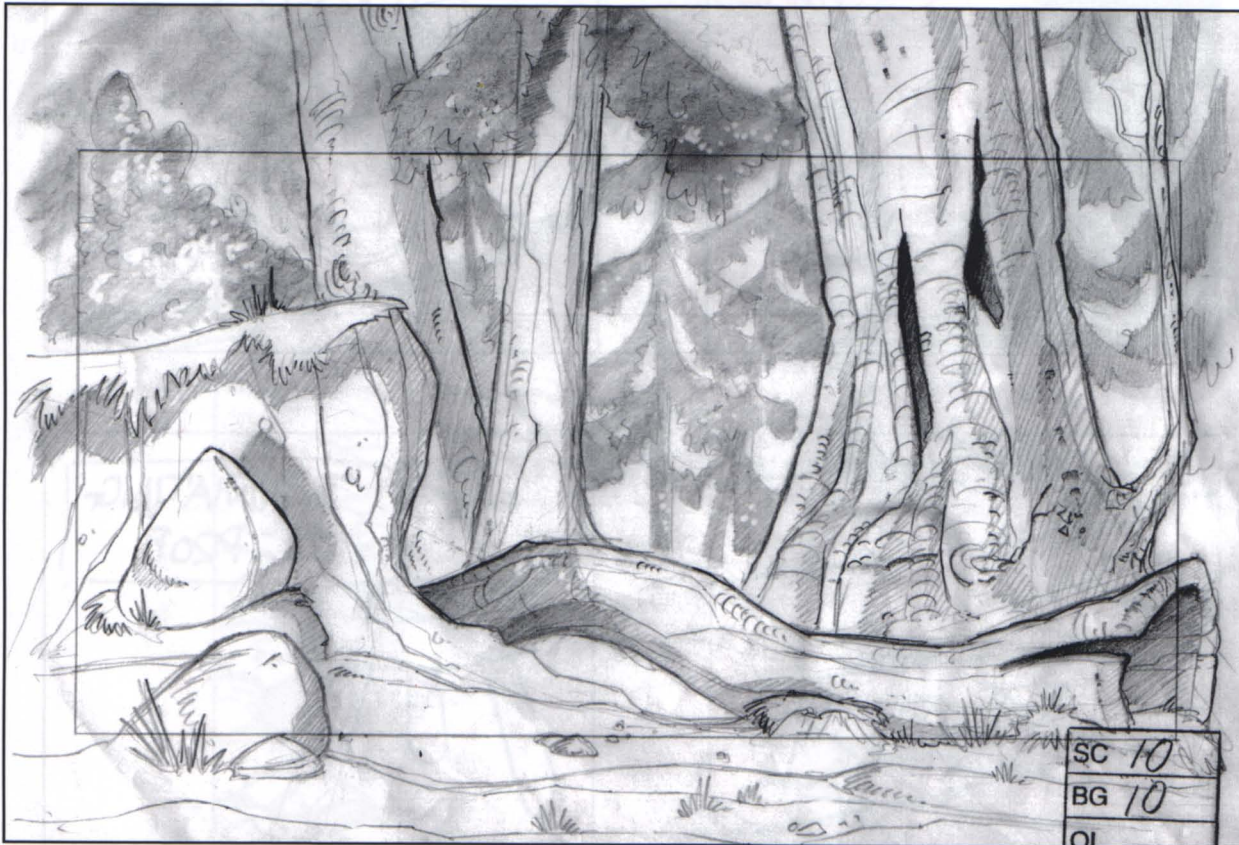

Because the final layout is often quite detailed, this may result in the animation test being lost on the background. Therefore we have to use a Blue Sketch of the layout to shoot our animation pencil tests.

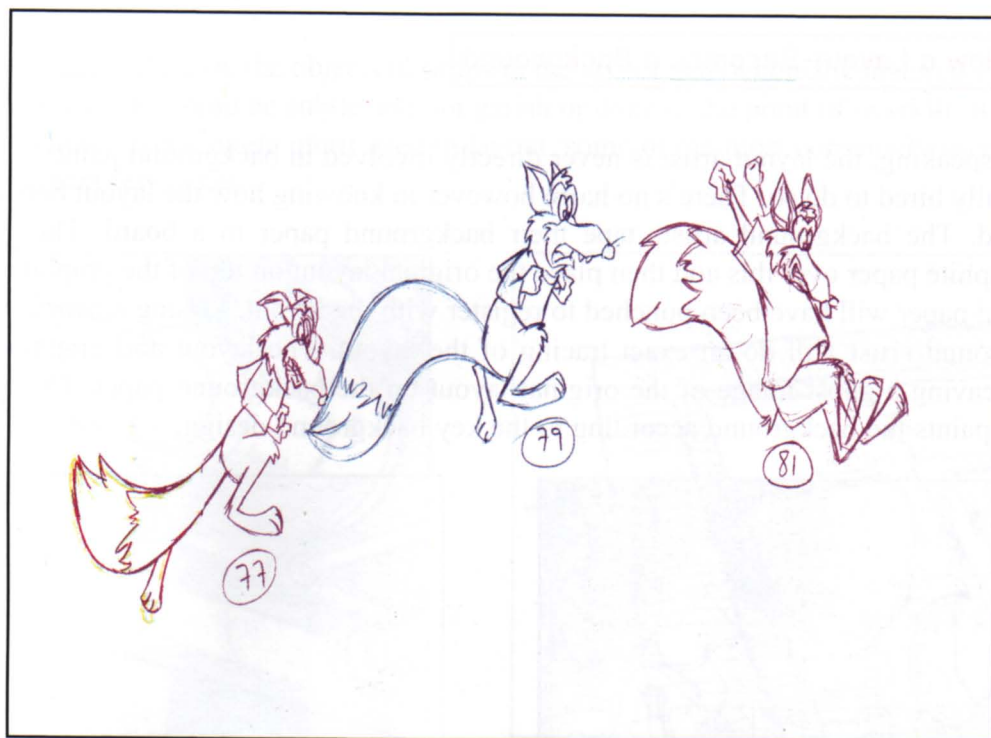

The layout artist traces the key animation poses on a separate sheet of paper to find the path of action.



All elements within the path of action are traced lightly with no rendering or detail. The remainder of the layout is a blue tracing of the original layout, including rendering.



How a Layout Becomes a Background

Generally speaking, the layout artist is never directly involved in background painting, unless she is specifically hired to do so. There's no harm however in knowing how the layout becomes a final background. The background artists tape their background paper to a board. They then place special graphite paper over this and then place the original layout on top of the graphite paper. The background paper will have been punched to register with the layout. Using a pencil or a scribe, the background artist will do an exact tracing of the layout. The layout and graphite paper are removed leaving a ghost image of the original layout on the background paper. The background artist then paints the background according to the key background design.

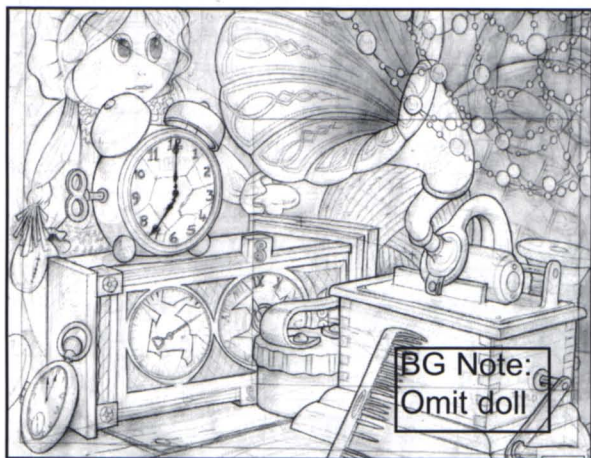

Original layout

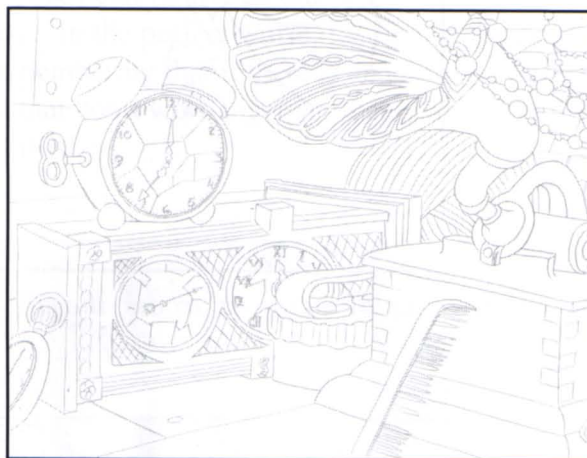

Exact, light graphite tracing of the original layout on background paper

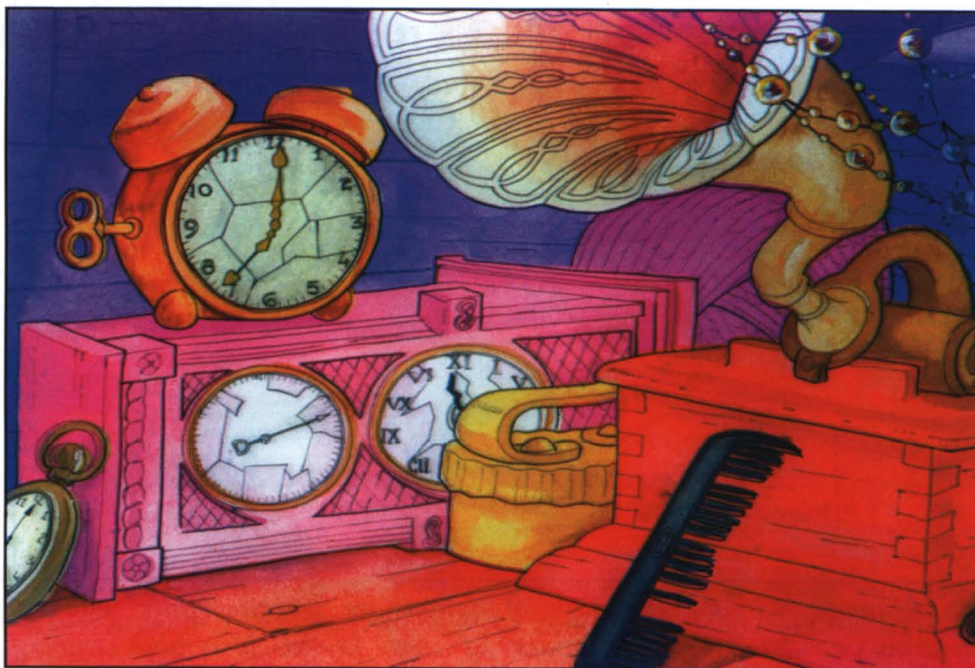

Final background

Motif

Motifs are marks or symbols on the objects or props in the layout that denote the material which they are made of. Motif work should be subtle and not garish or done to the point of overkill. It would be impossible to indicate every single motif used in layout, some of the most commonly used ones are indicated on the next few pages.

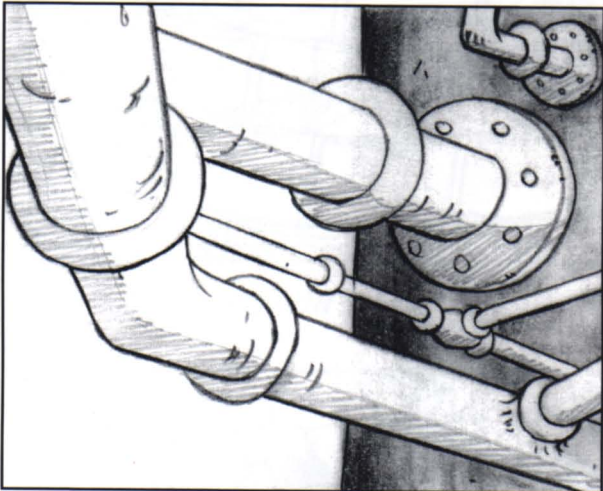

Pipes

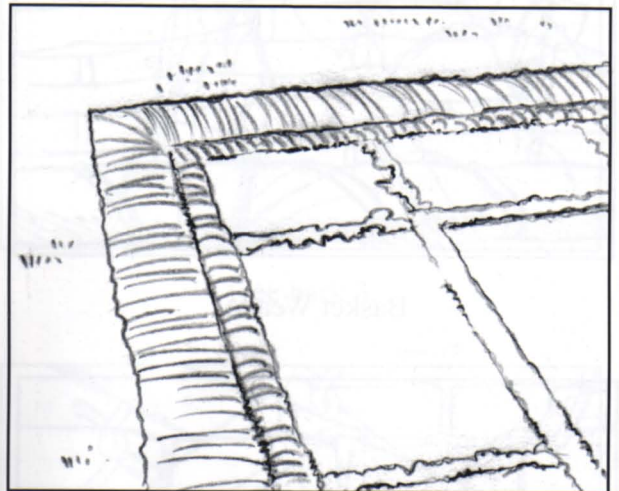

Carpet and rug

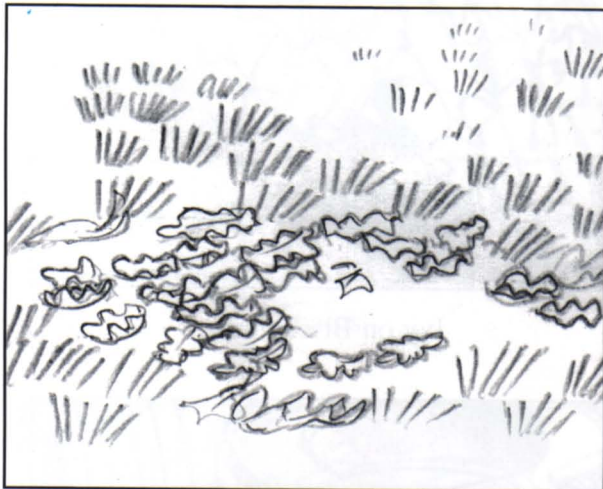

Grass and leaves

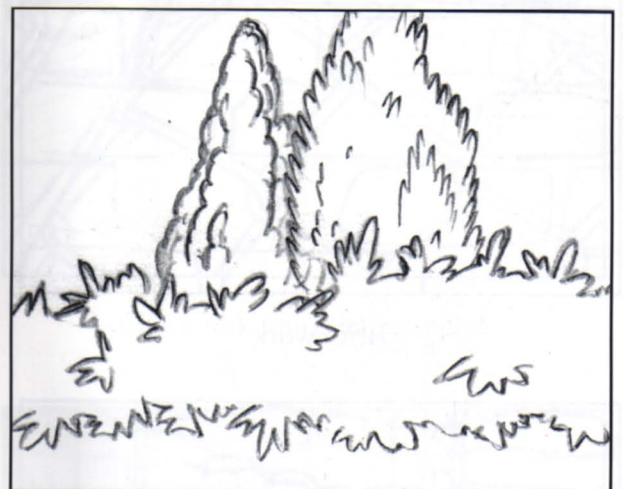

Foliage

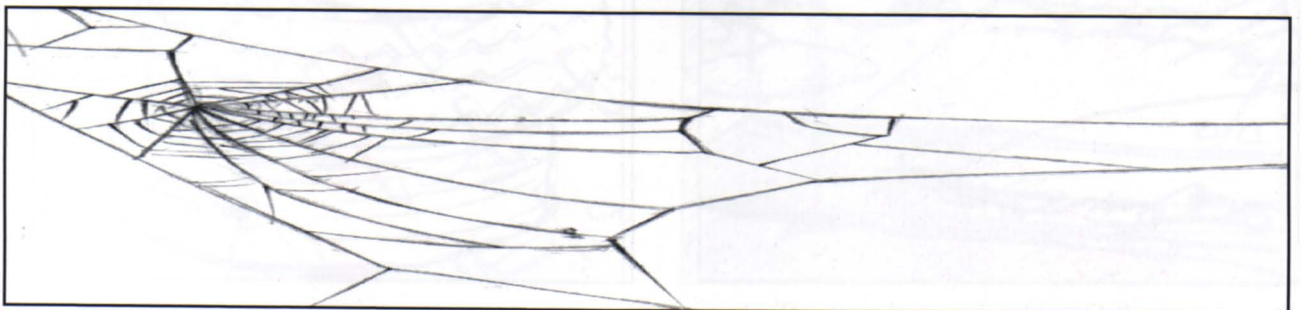

Cobweb

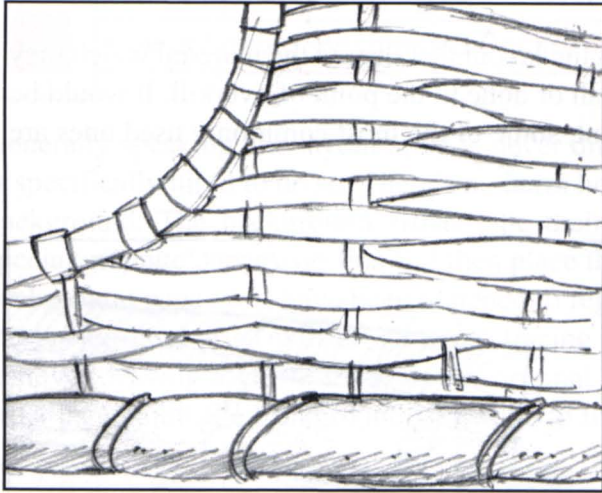

Basket Weave

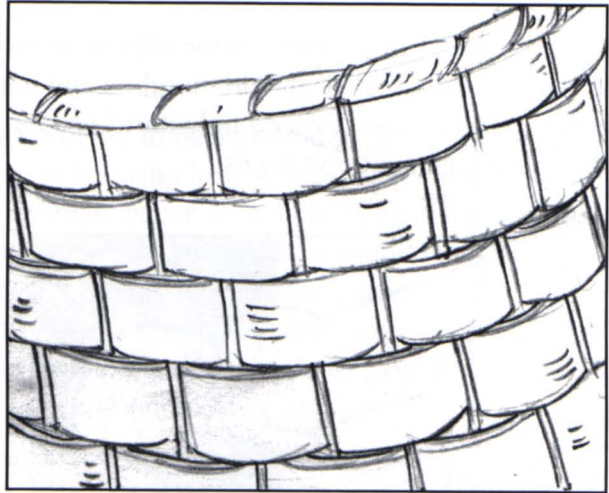

Basket Weave 2

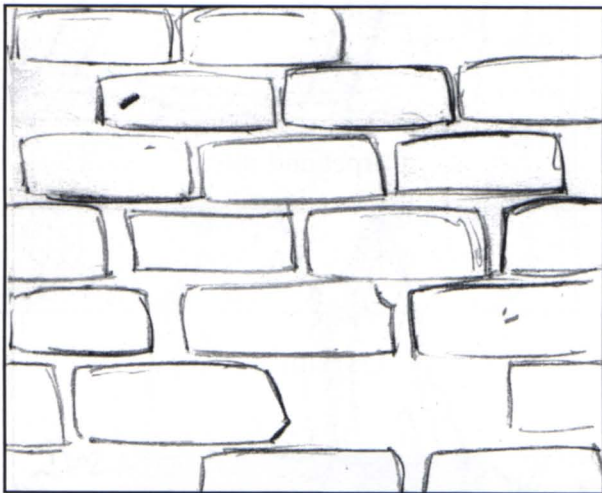

Brickwork



Ivy on Brickwork



Dry river bed. Can also be used with effects water over

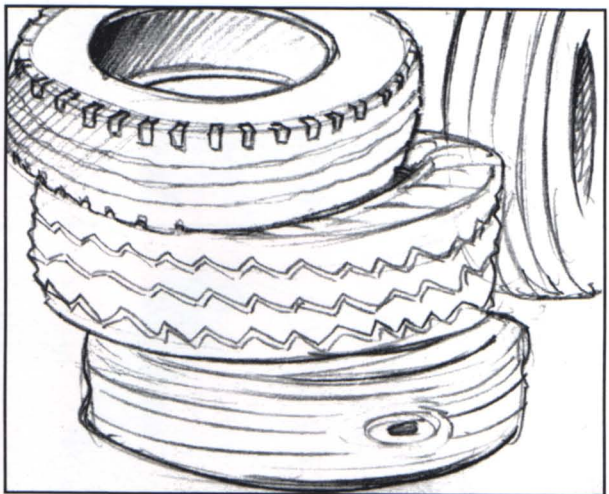

Tyres

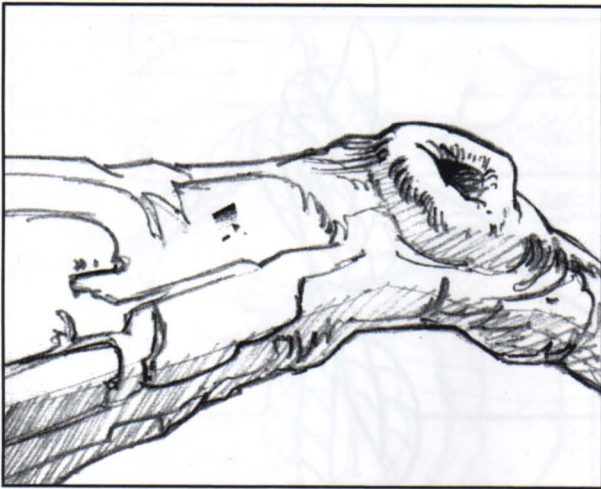

Tree bark 2.



Tree bark 3.

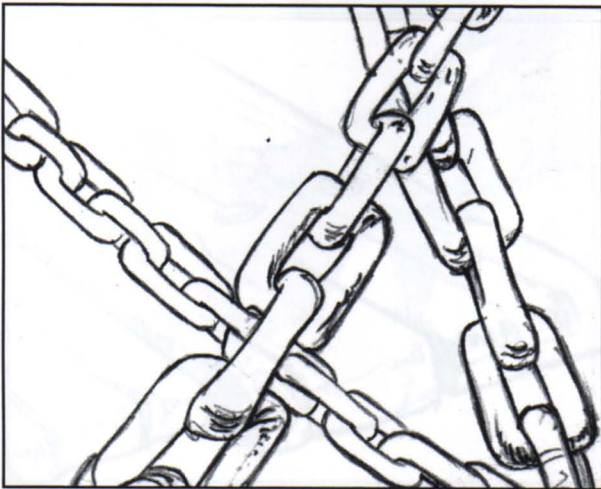

Chains.

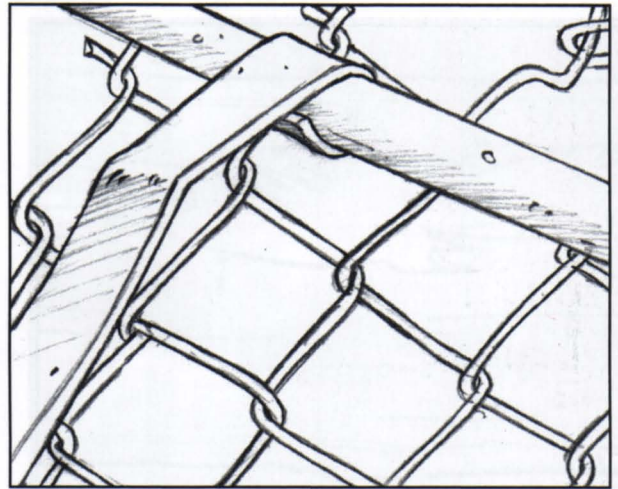

Chain link fence and support

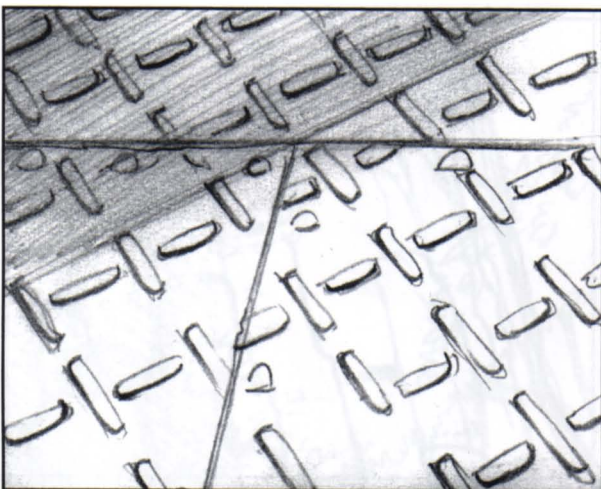

Metal deck floor

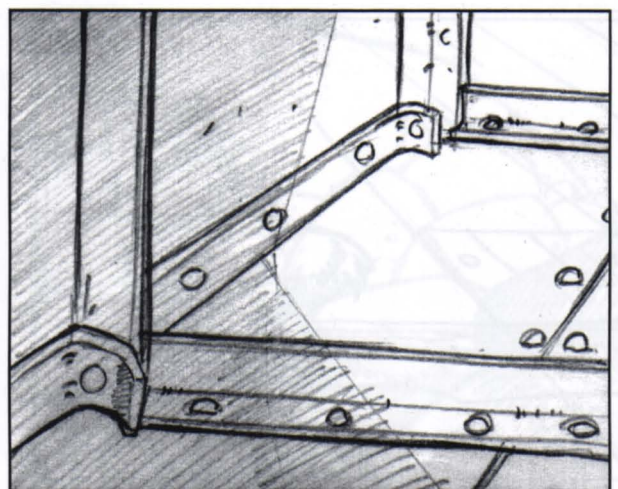

Metal duct



Rope and frayed end

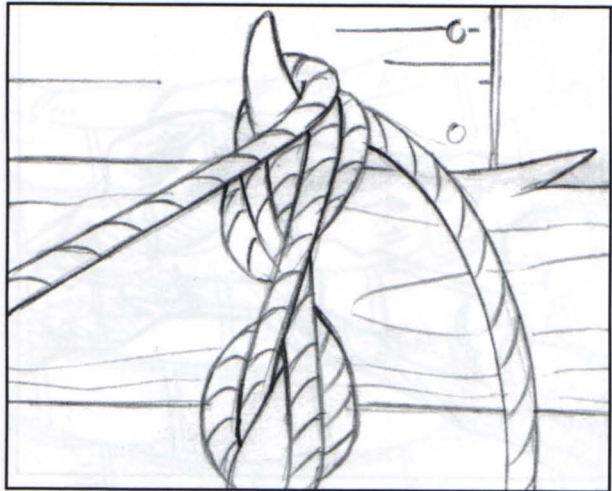

Rope 2



Old wood

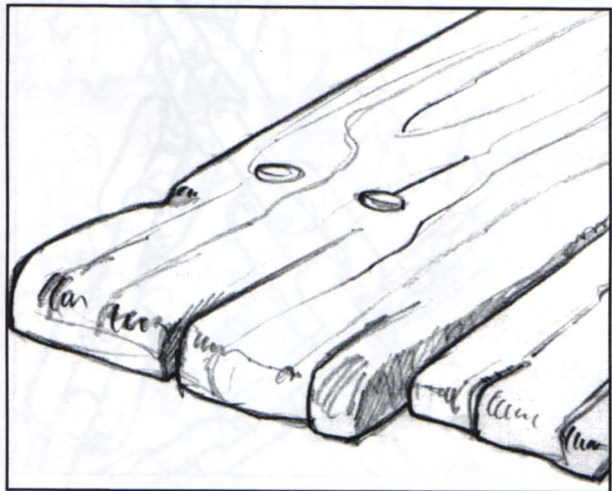

Old wood 2

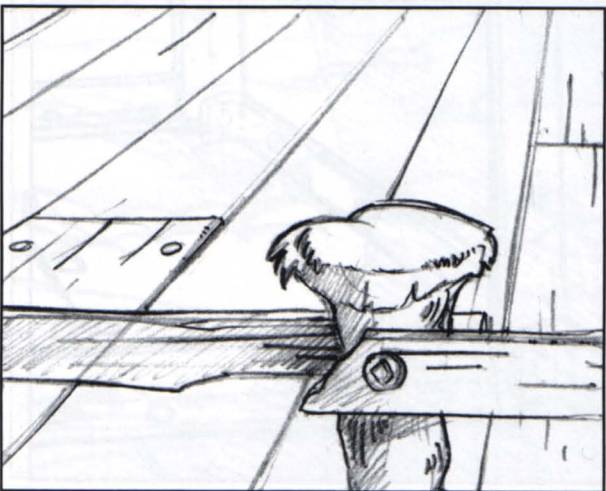

Wooden post

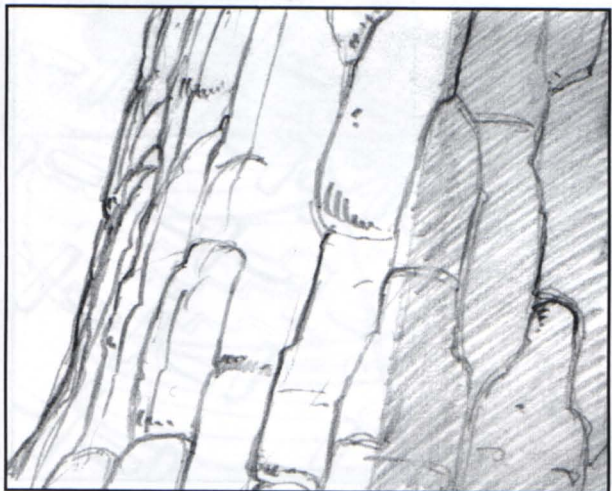

Tree bark

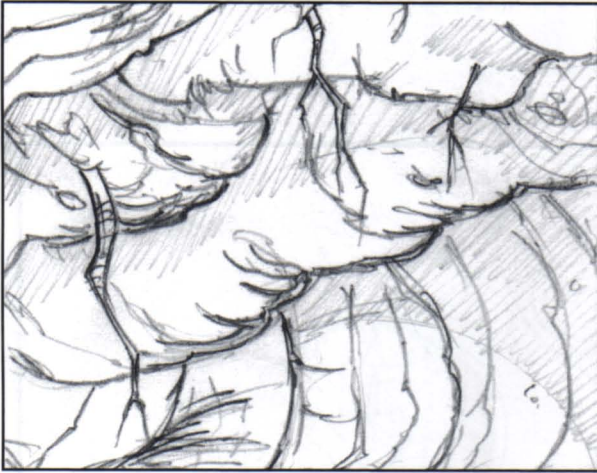

Earth underground.

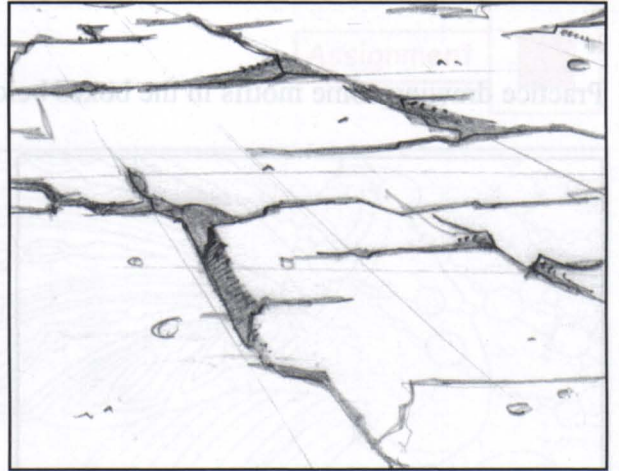

Dry soil.

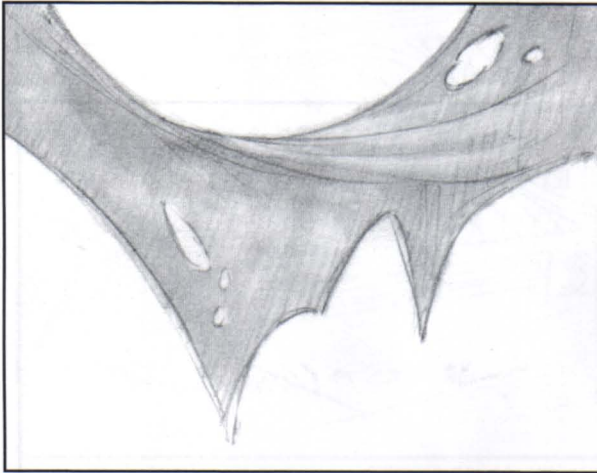

Cobweb 2.



Stormy sky.

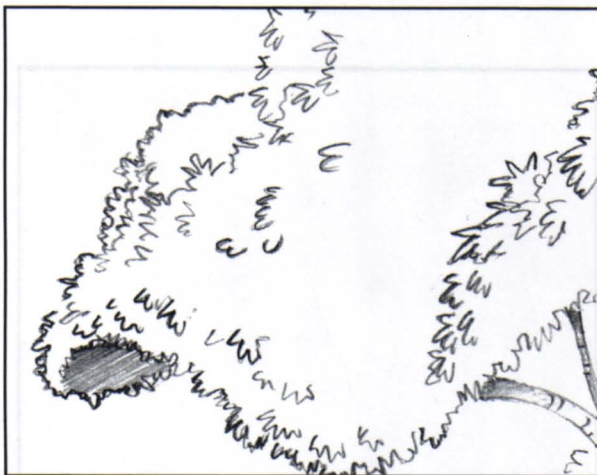

Foliage 2.

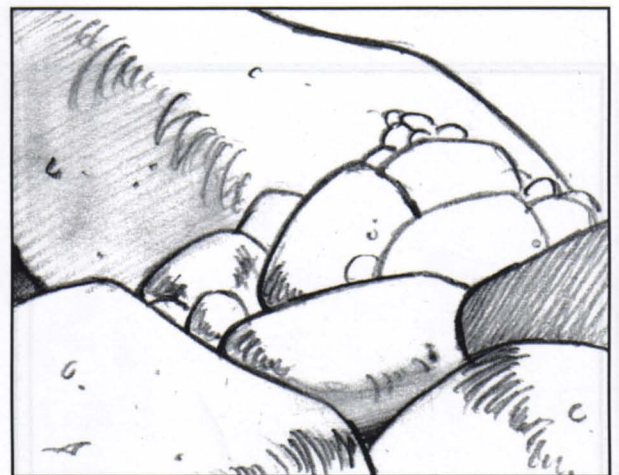

Rocks and pebbles.

Practice drawing some motifs in the boxes below.

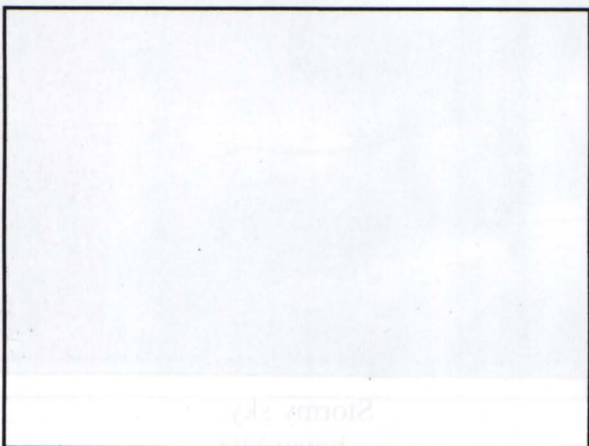
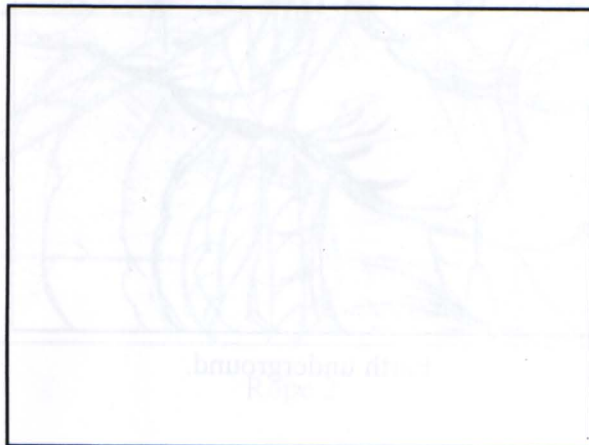
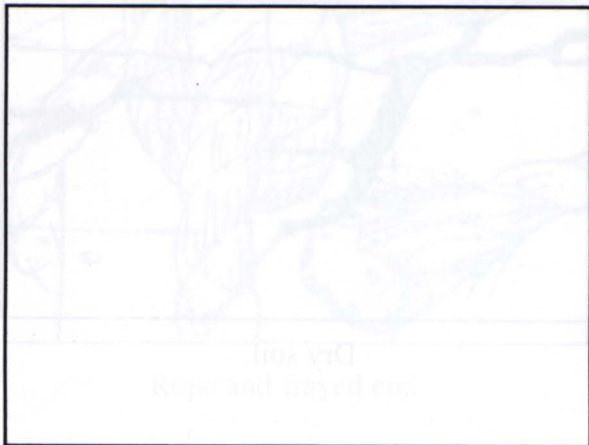

Assignment

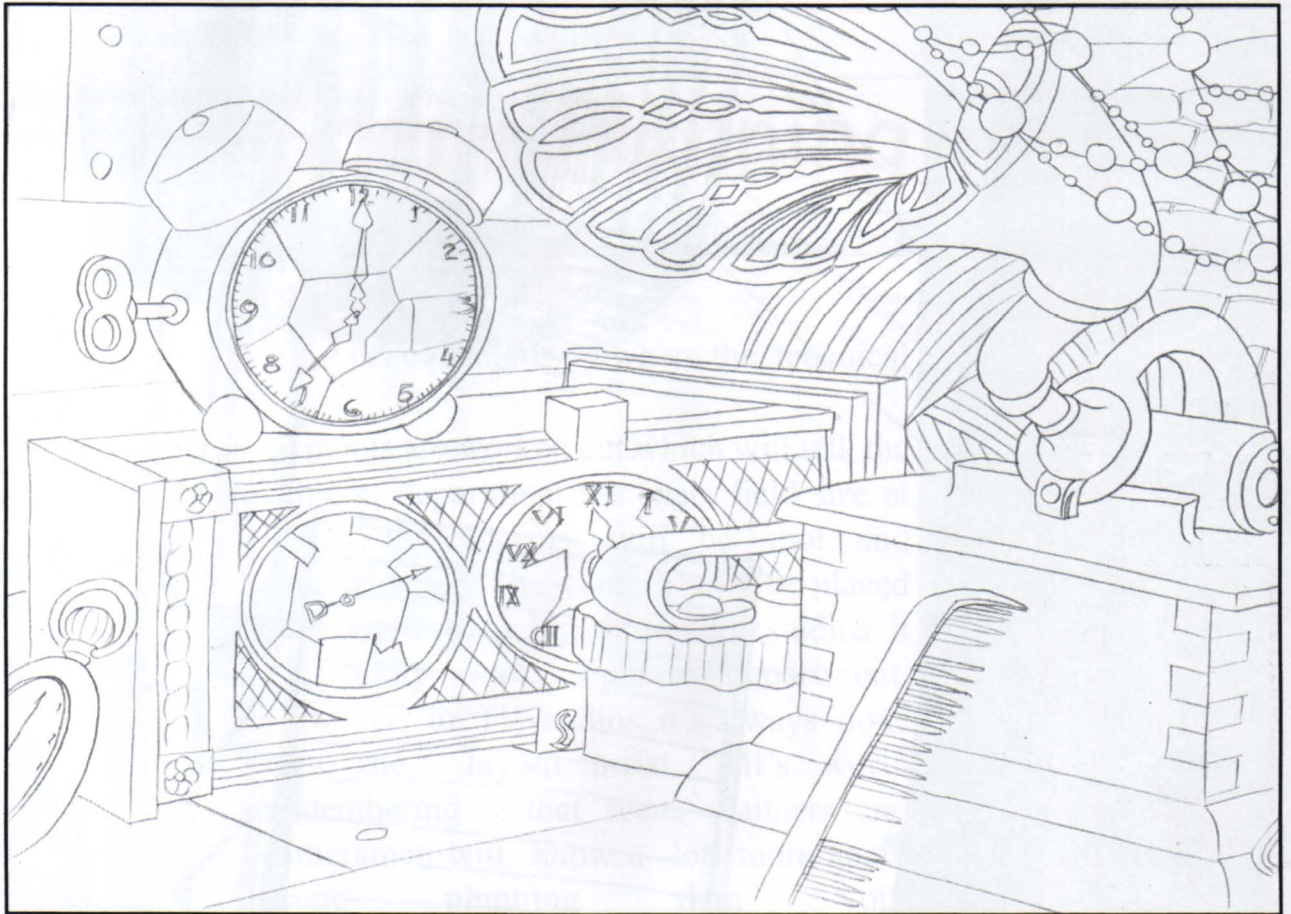

Render the sketch above using a medium of your choice.

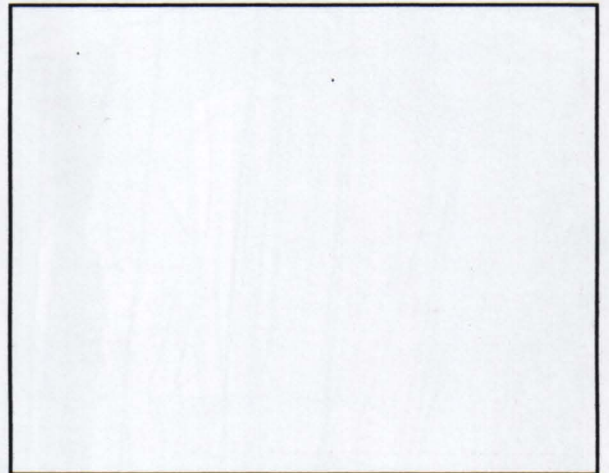
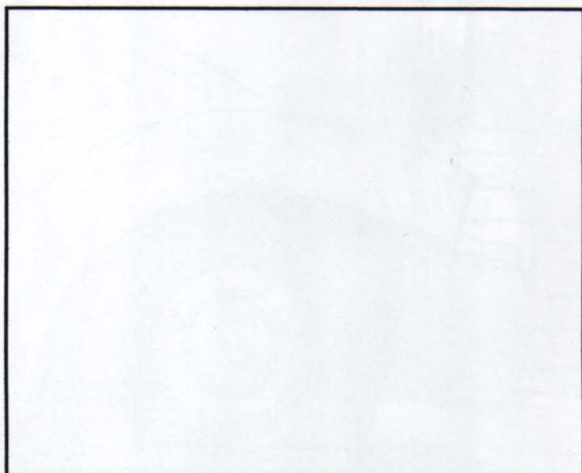

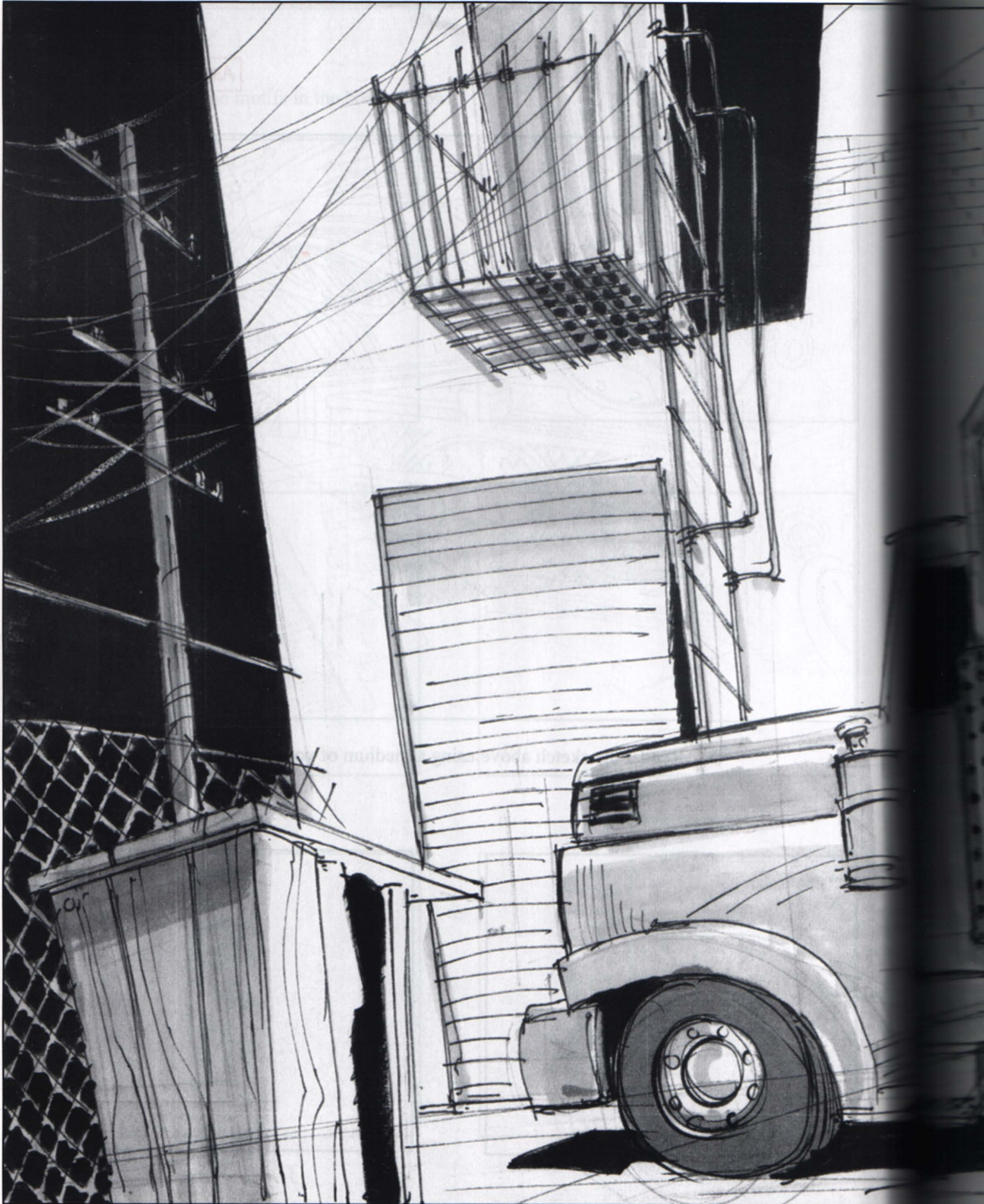



Scene Planning

Scene planning is where the technical elements are worked out which will tell the camera department the exact field size at which the artwork will be shot and exactly where the camera will be placed over artwork. In bigger feature studios it is usually a separate department. However, in TV studios, it's always done by the layout artist. It's worth remembering that scene planners and cameramen will know a lot more about scene planning than your average layout artist or animator. It is mainly done on computer nowadays and the longhand method of planning a pan is all but forgotten.

Field Size Graticule

There are a few extra tools in the layout artist's tool box besides pencils and erasers. One of them is called a Field-Size Graticule or Field Guide. It is used to check field sizes of artwork, and to determine the exact location of the camera centre over the artwork. The graticule should not be confused with cut-off guides, which we will deal with later. There are two graticules. The 12 field and the 16 field. These are essentially grids printed on plastic. The bold lines are 1" apart on both 12 and 16 field graticules and the thin lines are 5/16" apart. You will note also the compass notation, N,S,E,W. This is to tell the camera department which direction the camera should travel over.

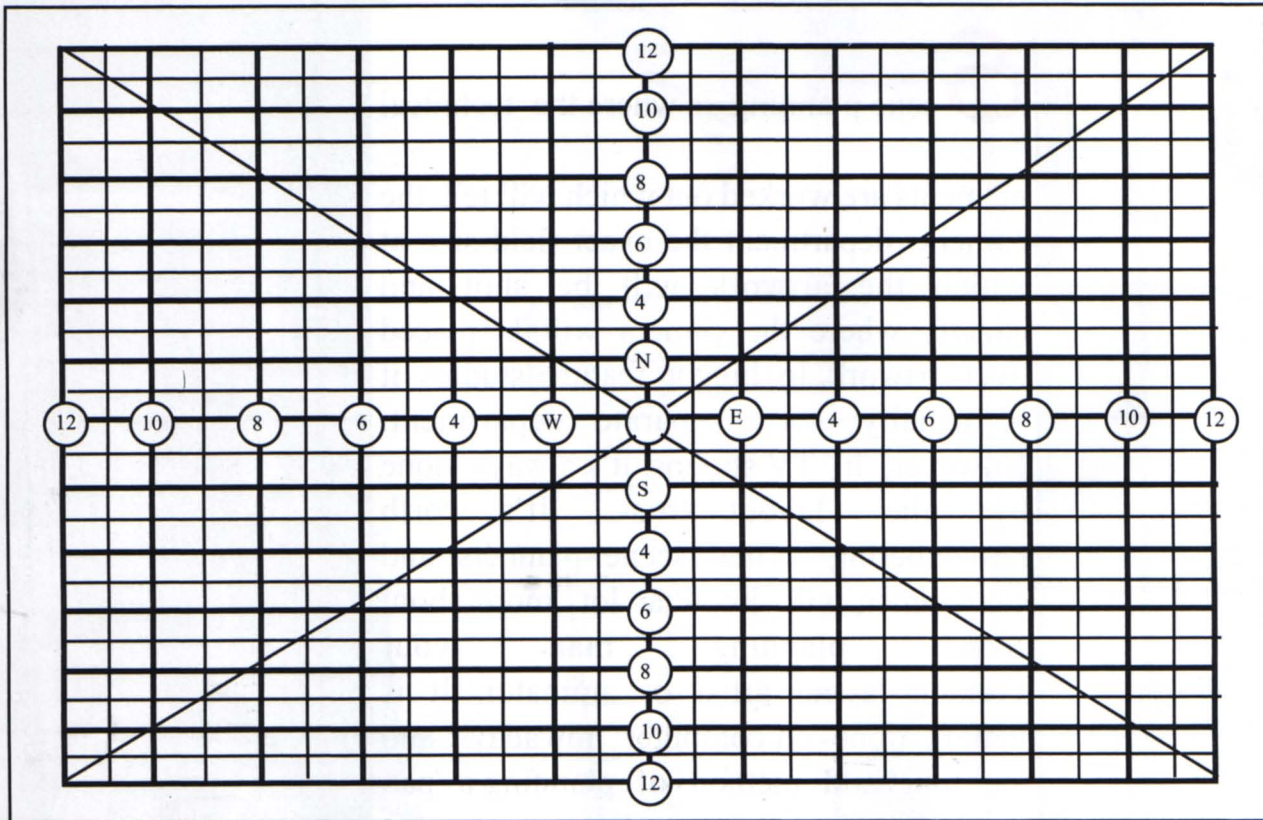

Field Guide

Field Size Set-up

The paper on which we draw our layout is generally referred to as a 'field'. There are two common fields used in animation, 12 and 16 field. The size of paper chosen is generally referred to as the 'set-up'. The 'field size' is the final size of the artwork that the camera will see for the particular scene, within the initial 12, 15 or 16 field. However, 15 field artwork is more commonly used now than 16 field. The reason for this, is that 15 field artwork is the same size as A3 paper, and therefore easier to copy for records, or for sending artwork around the world via fax or e-mail. Most artwork done in TV and computer game studios is done on 12 field, purely for cost reasons. Feature animation studios however tend to use 15 or 16 field and can sometimes go up to 24 field for multi-plane or bi-pack shots. Panning shots, irrespective of how long they are, will still be referred to by the initial size of the paper, so a scene could be 4 fields long on a 12 field set-up.

Cut-off Guides

This represents the size of the paper on which the layout is drawn.

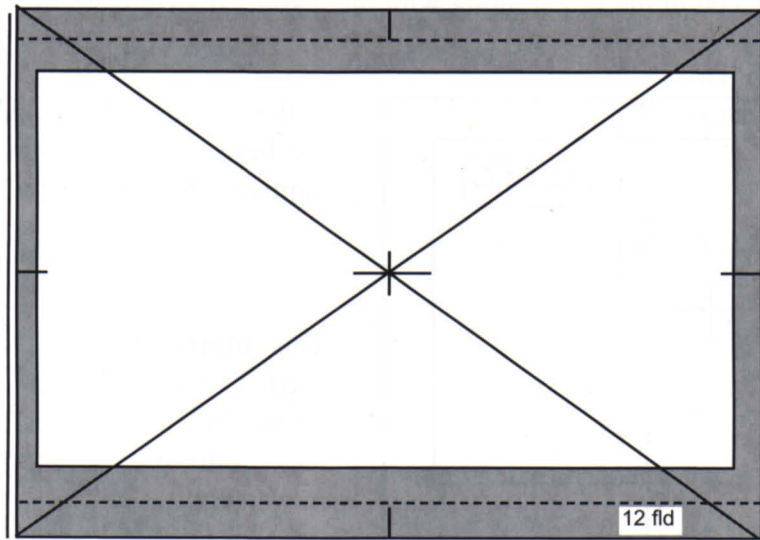

Cinema; 1:1.8

This represents the amount of image that will be seen on the TV or cinema screen.

Cut-off.

Safe titling.

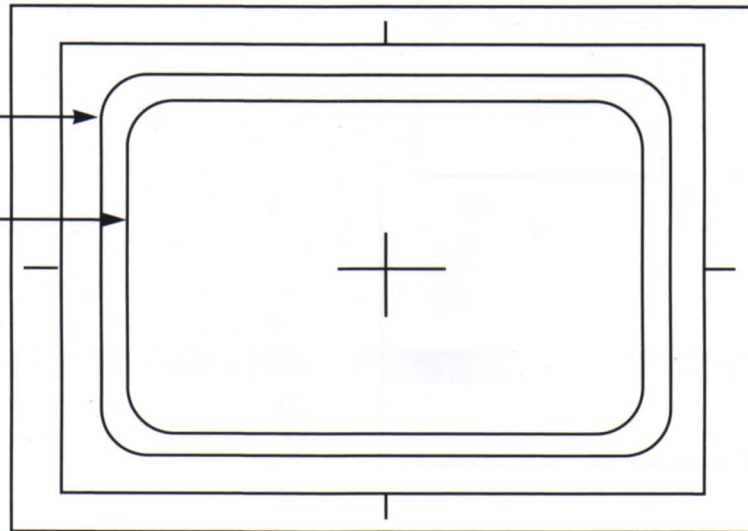

TV; 1:1.33 cut-off

TV and cinema cut-off guides show how much of your image you are going to see on the screen and come in a complete set from 6fld to 16fld. Quite often the storyboard artist will call for a particular field size. It is then up to the layout artist to decide if the size indicated is the best one for the scene, or if indeed the shot would benefit from being a field larger or smaller. The layout artist, or the scene planner will place the cut-off guide on the artwork to judge the most appropriate size of artwork for the scene. This occurs when a field size outside of the three general sizes 12, 15 or 16 field is chosen, or if the camera is going to truck in or out to a particular field. In feature animation, it is uncommon for artwork to be done outside the 12, 15 or 16 field format unless there is a truck in or out. In TV, layouts are usually done from 6 - 12 field and very rarely above.

The field-guide or scene planning information is usually indicated on a sheet of paper the same size as the set-up and is placed in the folder along with the layout, key character poses and dope sheet.

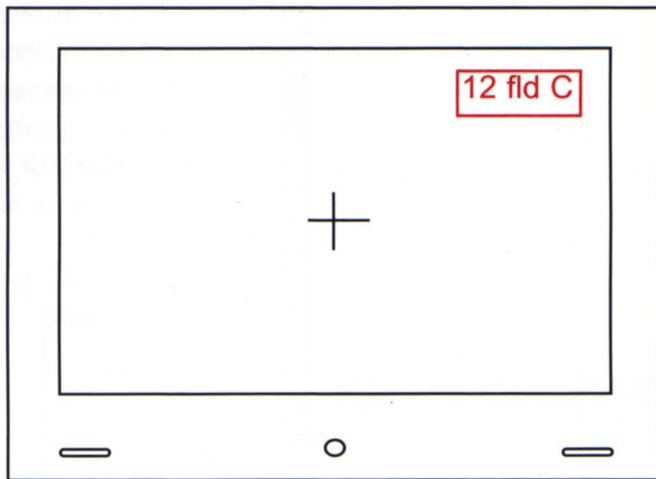

If there is no camera move in the scene, the field guide will have a *black* cut-off (some studios use red) with the instruction;

12 F.C.

This means that a 12 field set-up will be used. The artwork is 12 field and the centre of the camera lens will be over the centre of the artwork, without any movement.

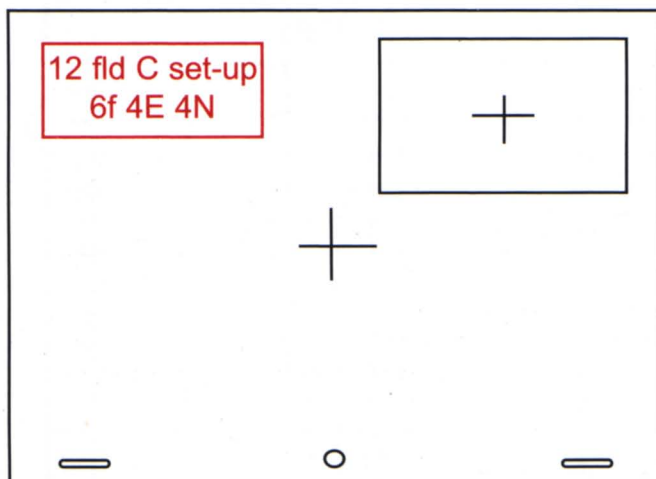

Supposing now we want a smaller field size, but still there will be no camera moves in the scene, we will get our graticule and place it over the artwork, then take our cut-off guides for whichever size we require and use the cut-off to see exactly what image we will finally see on screen. The field guide will then look like this. The example here means that the scene is 6 fields in size, the camera is 4" East and 4" North of the centre of the initial set-up centre.

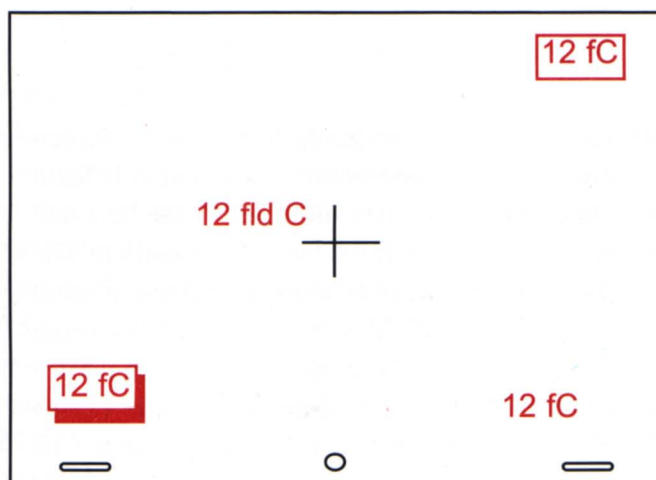

Exactly where on the field guide you write the scene planning information will differ from studio to studio and doesn't matter too much. The advantage to putting it in the top right hand corner is that it's easier to read if the drawing is in a folder. The important thing to remember is that it must be indicated.

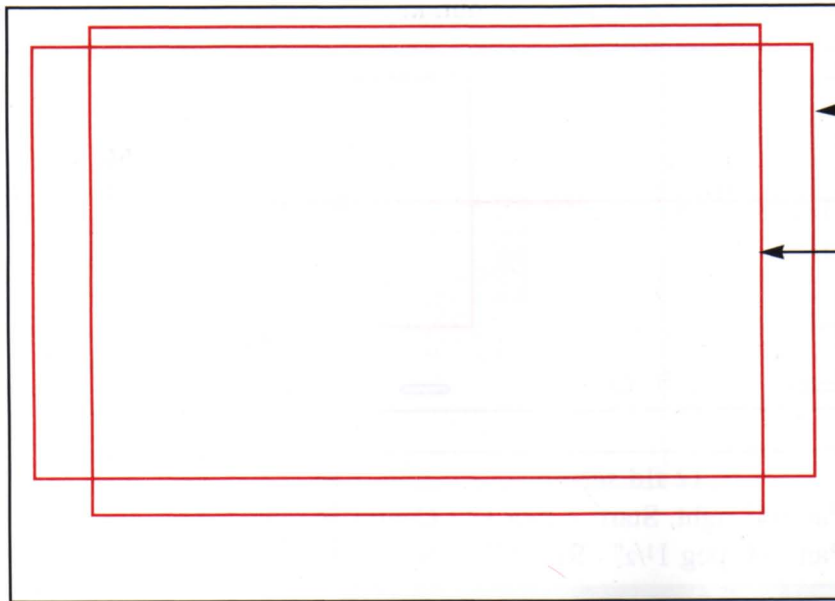

In the cinema you'll see this much.

On TV you'll see this much.

| | | | |
|------------------|-------------|------------------|-------------|
| 12 Field. | | 15 Field. | |
| Paper: | 12½" x 10½" | Paper: | 16" x 12½" |
| Cut-off: (T.V.) | 10" x 7½" | Cut-off: (T.V.) | 12½" x 9½" |
| (Film) | 11¼" x 6¼" | (Film) | 14" x 7½" |
| 16 Field. | | 24 Field. | |
| Paper: | 16" x 13½" | Paper: | 24" x 17½" |
| Cut-off: (T.V.) | 13¼" x 10" | Cut-off: (Film) | 21¼" x 11½" |
| (Film) | 15½" x 8" | | |

You will notice that in feature animation, you will see more in the *width* and less in the *height* of the image than in TV, and more in *height* and less in *width* in TV than in feature. This is why there are more short pans when movies are transferred to video. An image that is 'in field' on film may not fit on TV and so the editor transferring the movie may add in a short pan to give the audience all of the original information. Of course, quite often they don't bother, and we see less on video than in the original on the big screen, hence the popularity of wide-screen TV. You may also have noticed that the measurements use the Imperial system of feet and inches. This is common throughout the world, and is unlikely to change. The following abbreviations are commonly used in scene planning:

f. or fld. - field. *C* - centre. *CW* - clockwise. *CCW* - counter clockwise.
N - North. *S* - South. *E* - East. *W* - West.

In this example, the scene starts exactly on A peg hole, but stops before C peg hole.

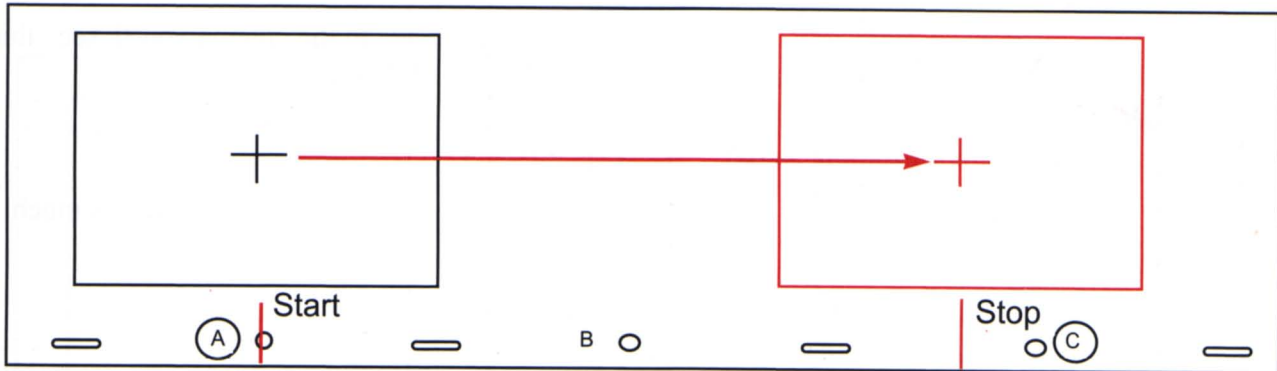

12 fld set-up
 Pan BG right. Start A peg 12 f Centre
 Pan to C peg 1 1/2" Right Of Centre

Let me explain the bottom line. The stop position is indicative of where the *centre of the camera lens* is. The C peg hole is 1f" to the right of this. We are more concerned where the camera centre is as opposed to the centre of the field. This distance can be measured with a ruler. Pans don't always have to move from peg hole to peg hole. A pan can be as little as 1/2".

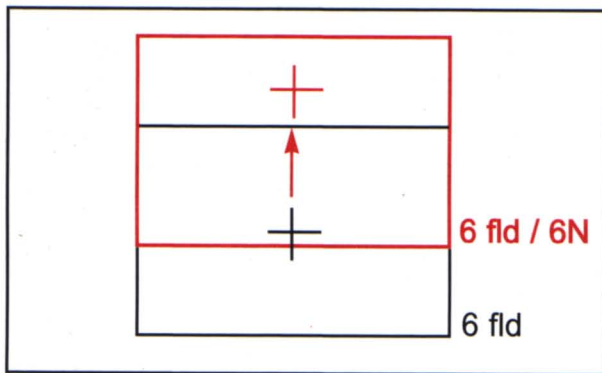

This type of movement is called a track. This example shows a simple track. It can of course go diagonally as well. It is written thus:

12 fld set-up
 Start 6fld / 6S
 track to
 6fld / 6N

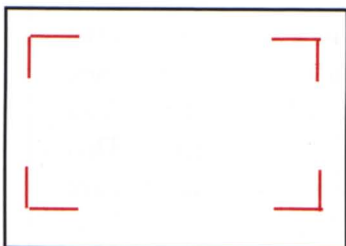

Corners



Broken Line

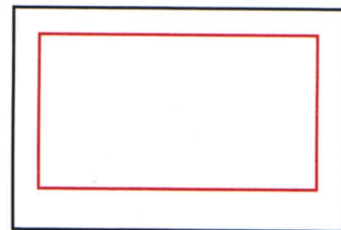

Full Monty

Studios differ in the way that they indicate the field guide, but at the end of the day it all amounts to the same thing, so it doesn't really matter which method you use!

Some more field guides.

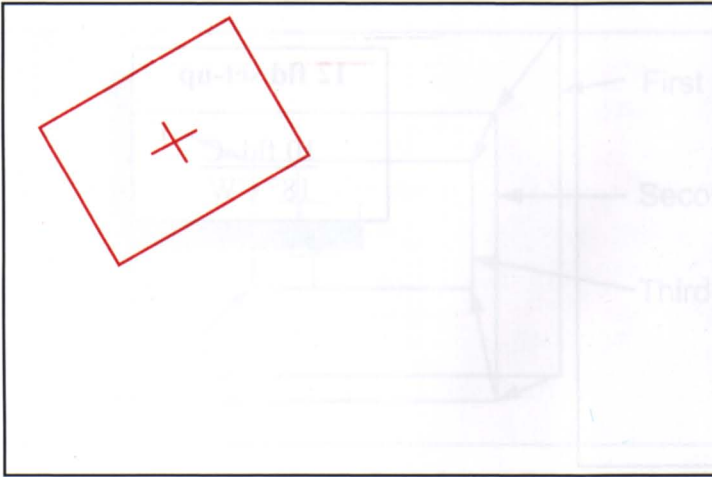

For a tilt shot in the corner of the artwork for example, we would call:

12 fld set-up
7f 3W2N
40° CCW Tilt

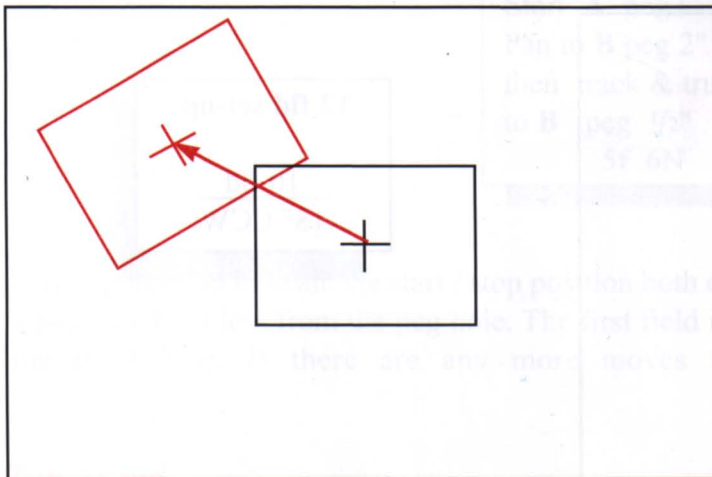

If there is a rotation in the scene, where the shot starts at the centre and then rotates to B, we would call:

12 fld set-up
Start 7FC rotate to 7fld. 3W2N
40° CCW curved pan as indicated.

Here, field (A) is black and field (B) is red.

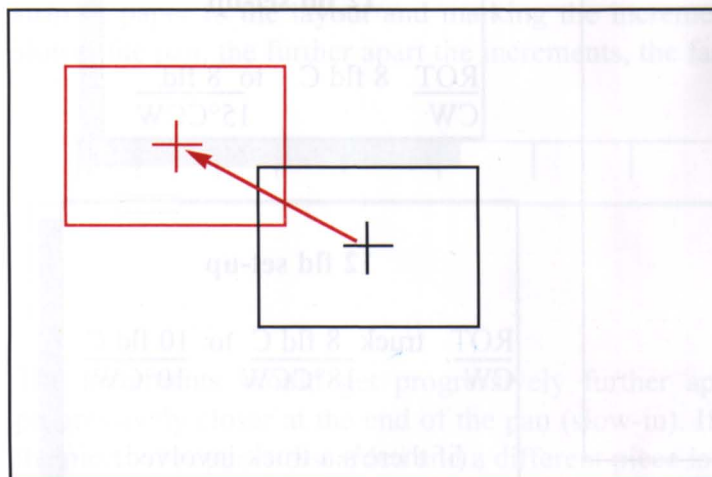

Here's a similar shot with no rotate or tilt.

12 fld set-up
Start 10FC, truck while tracking to 7F 3W2N

The following diagram may be also be added to your field guide when a tilt is being used.

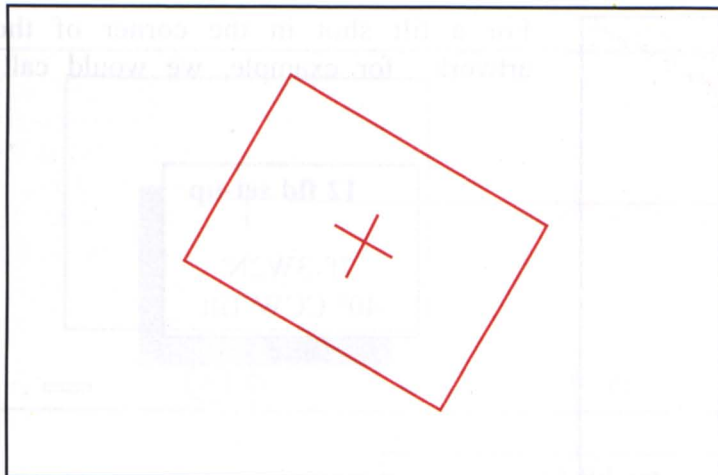

12 fld set-up

$\frac{10 \text{ fld } C}{18^\circ \text{ CW}}$

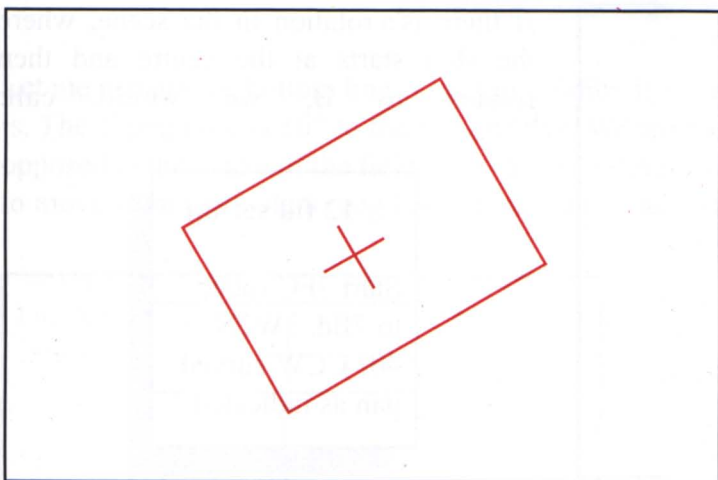

12 fld set-up

$\frac{10 \text{ fld}}{18^\circ \text{ CCW}}$

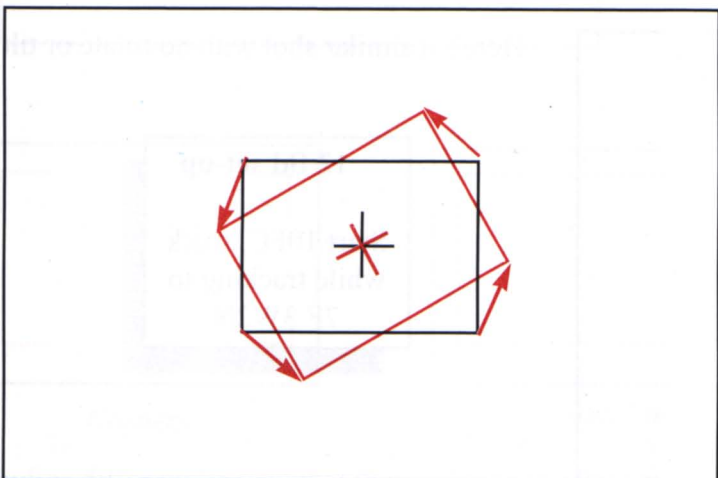

12 fld set-up

$\frac{\text{ROT}}{\text{CW}} \text{ } 8 \text{ fld } C \text{ to } \frac{8 \text{ fld}}{15^\circ \text{CCW}}$

12 fld set-up

$\frac{\text{ROT}}{\text{CW}} \text{ truck } \frac{8 \text{ fld } C}{18^\circ \text{CCW}} \text{ to } \frac{10 \text{ fld } C}{10^\circ \text{CW}}$

(if there's a truck involved)

Here's one that takes most moves in:

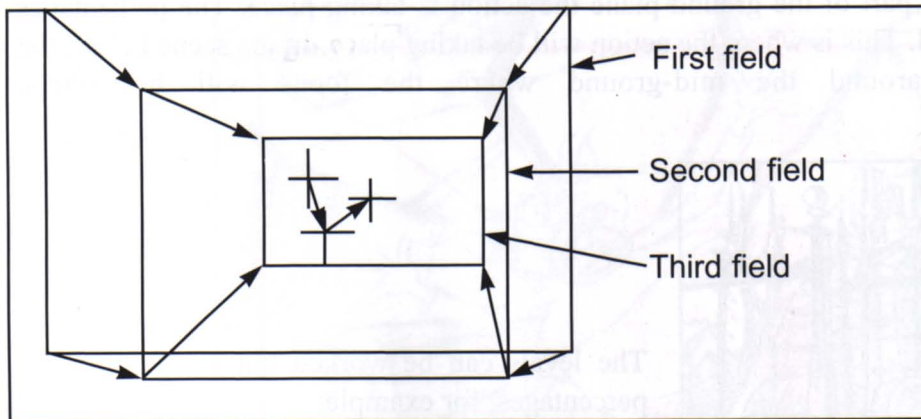

Arrows showing direction of movement connect the four corners of the fields. Arrows connecting the first field to the second one must be drawn in the colour of the first field. The cross-hairs indicating the centre of the field, are drawn in the colour of the field.

12 fld set-up

Pan right.

Start A peg C 11fC

Pan to B peg 2" ROC

then track & truck in

to B peg 1/2" LOC

5f 6N

It is important to indicate the start / stop position both on the layout and the field guide. Always call a position 4" or less from the peg hole. The first field is always drawn in black, the second red and the third blue. If there are any more moves then it's back to black, red, blue etc.

Pan Speed.

Working out the increments for a pan is a complicated calculation if done by hand. Fortunately, it is generally worked out on computer. However, if the layout artist wants to test a pan to see if the speed is too fast or too slow, he can use the 'Piece of Paper' technique. This involves taping a thin strip of paper to the layout and marking the increments by eye. The nearer the increments, the slower the pan, the further apart the increments, the faster the pan.

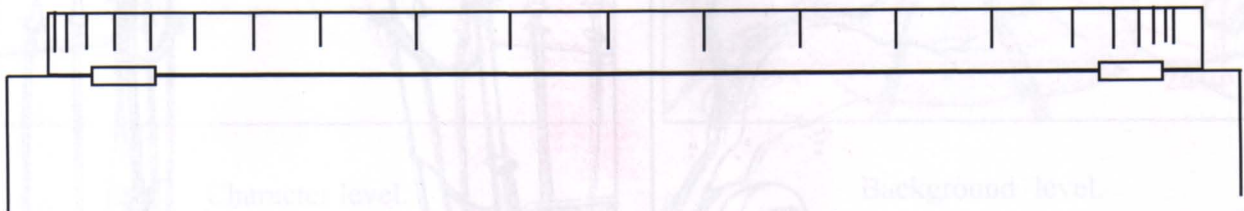

The increments should get progressively further apart at the start of the pan (slow-out) and progressively closer at the end of the pan (slow-in). If the speed of the pan is too fast or too slow, the piece of paper is discarded and a different piece is taped on and the procedure is repeated.

Multi-plane.

The camera will appear to pass through each level. Each element is painted separately and can vary in focus depending on which part of the ground plane the action is taking place. The percentages relate to a chosen master level. This is where the action will be taking place. In the scene below, the action will take place around the mid-ground where the focus will be 100%.



The levels can be worked out as percentages, for example:

- Overlay*.....200%
- OL / UL 1*.....100%
- OL / UL 2*.....75%
- Background*.....50%



Background

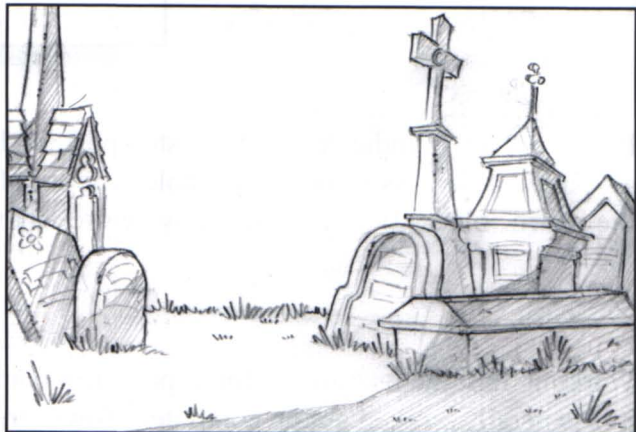

Overlay / Underlay 1



Overlay / Underlay 2.

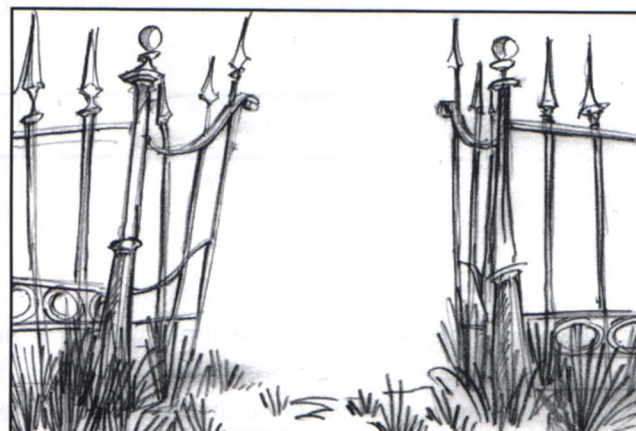

Overlay

n vary
stages
w, the
00%.

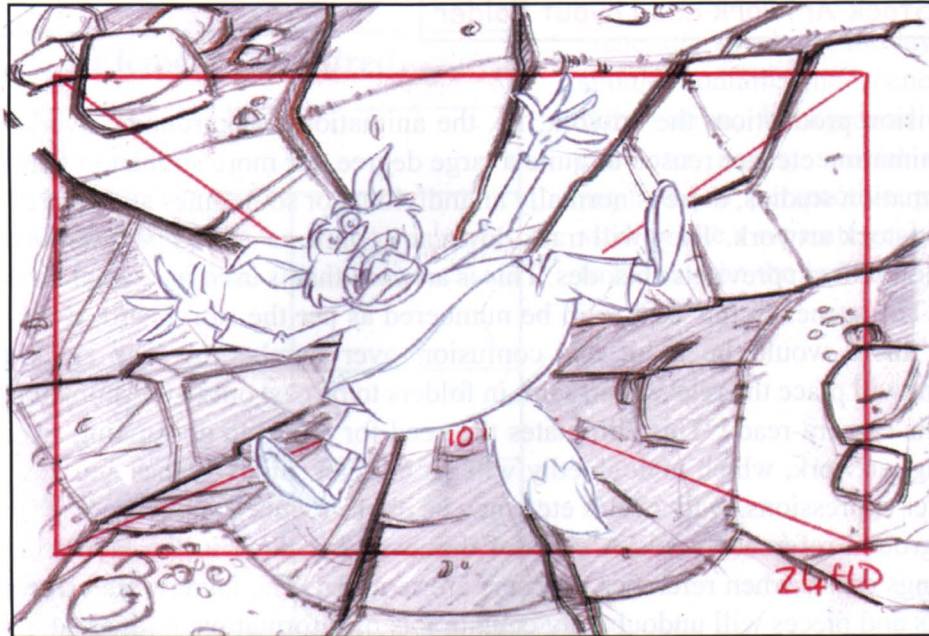

Bi-pack: Here the character level is animated and shot as a stand-alone level. The truck-in to the bottom of the canyon is shot and the final scene is a composite of the two pieces, so it looks like we are following the character as he is falling downwards.



Character level.

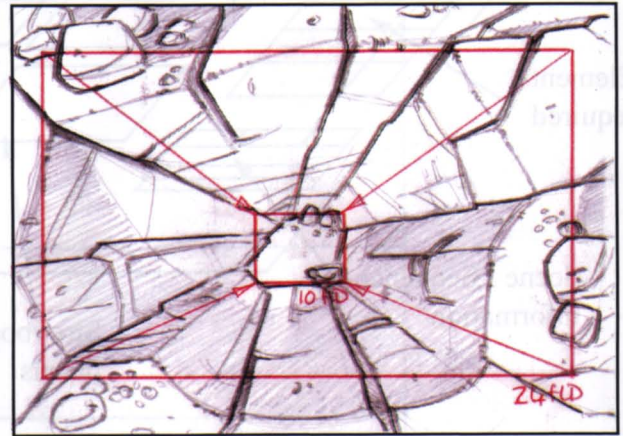

Background level.

Stock Artwork and Layout Folder

In a television production, the artwork, i.e. the animation, backgrounds, overlays, underlays, effects, animation etc. are reused to quite a large degree, far more so than in feature animation. In TV animation studios, there is normally an individual or sometimes an entire department that looks after stock artwork. They will track down any 'same as' (S.A.) material from episodes in a production or from previous episodes. This is artwork that is used in several different episodes or series. The scenes in this case, will be numbered as per the storyboard of the new episode, otherwise there would be a lot of confusion over numbering. The stock co-ordination department will place the relevant artwork in folders to be cast out to the animators etc. or when the scene is camera-ready. This eliminates the need for artists to go running around the studio 'borrowing' artwork, which undoubtedly will go missing. Stock scenes and key artwork such as character expressions, walk cycles etc., may be photo-reduced and pasted up in a stock scene and background reference book. A copy of this would be kept in the layout department and makes things easier when reference numbers are required. The layouts which are done and the sundry bits and pieces will undoubtedly contain lots of information, both artistic and technical. To make life easier for every department involved, we can put all of our artwork and technical information into a folder and write the details outside. This way, at a glance, any member of the team will know what's inside.

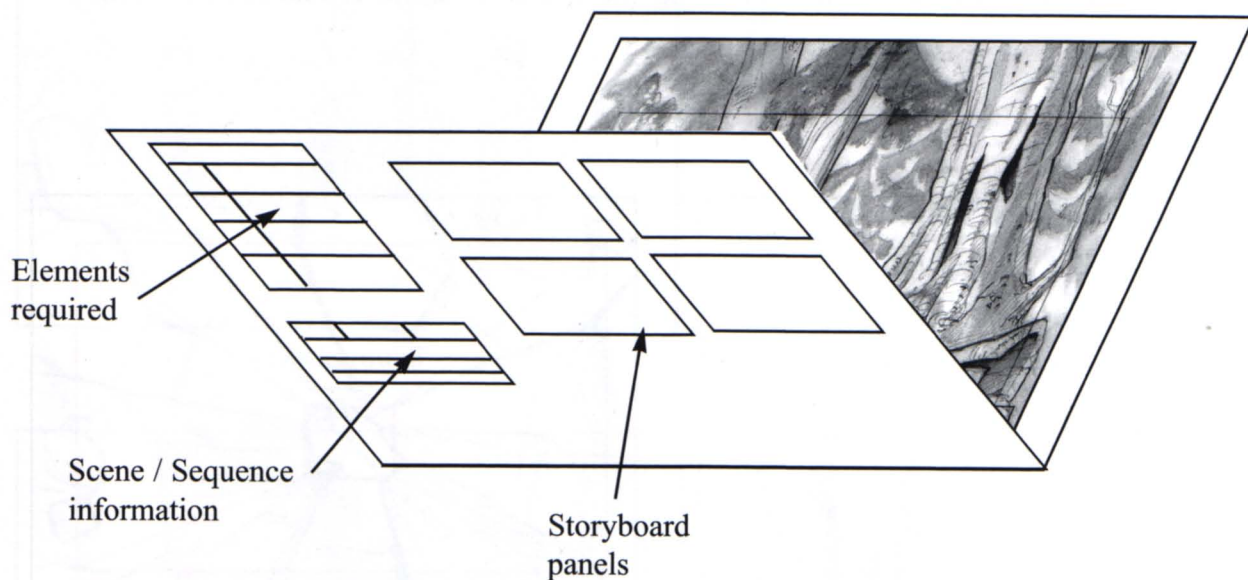

The storyboard panels on the folder can be as big or as small as you like. It is also necessary to sign your name to the layout in case there are any problems to be sorted, or praise to be handed out. Then everyone will know whose work it is!

| Elements Required | |
|-------------------|--|
| Animation | |
| Background | |
| Overlay | |
| Underlay | |
| Over/Underlay | |
| Held Cel | |
| Blue Sketch | |
| Field Guide | |

Generally speaking, the layout folder should contain; the scene planning information, background elements, character poses, special effects (if any) and a perspective grid. Some studios like a separate grid in addition to the one on the layout.

| SEQ: | SC: | Hook To: |
|--------------|-----|----------|
| Reuse sc: | | |
| Reuse in sc: | | |
| Drawn by: | | |

These type of labels can be done up quite cheaply, then copied and stuck to the layout folder.

We have seen the 'Elements Required' label on the folder. We will now have a look to see exactly what these elements are and their function. Let's assume that in a scene a character has walked into a room and has stood up on a box to deliver a speech. A second character, wearing a hat, comes in after her and stands behind the box.

The door is opened, then remains ajar.

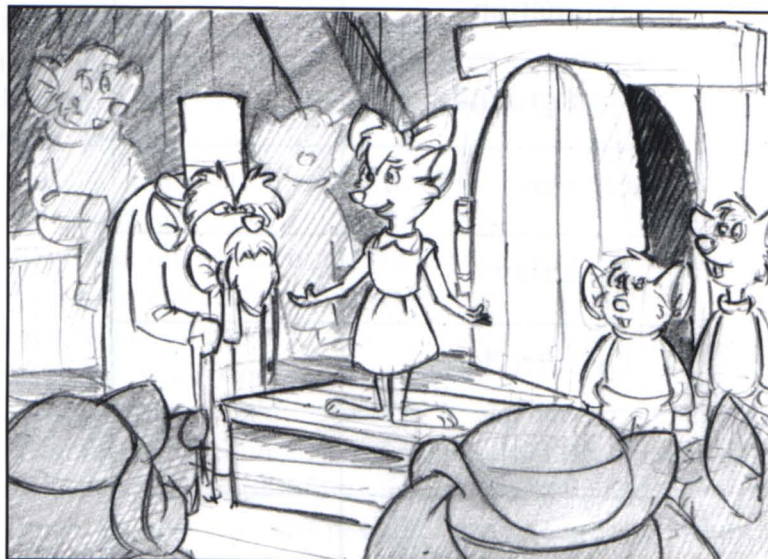

Animation Level.

Overlay (OL)

Any level that sits atop every other level.

Underlay / Overlay (UL / OL)

Usually a held element under an animating element and may be over another animating element or held level.

Held Level

Any prop or still character level. May have animated previously or at a later stage.

Underlay (UL)

Any level that sits under every other level.

Background

Always the first piece of artwork on the camera bed.

Camera bed.

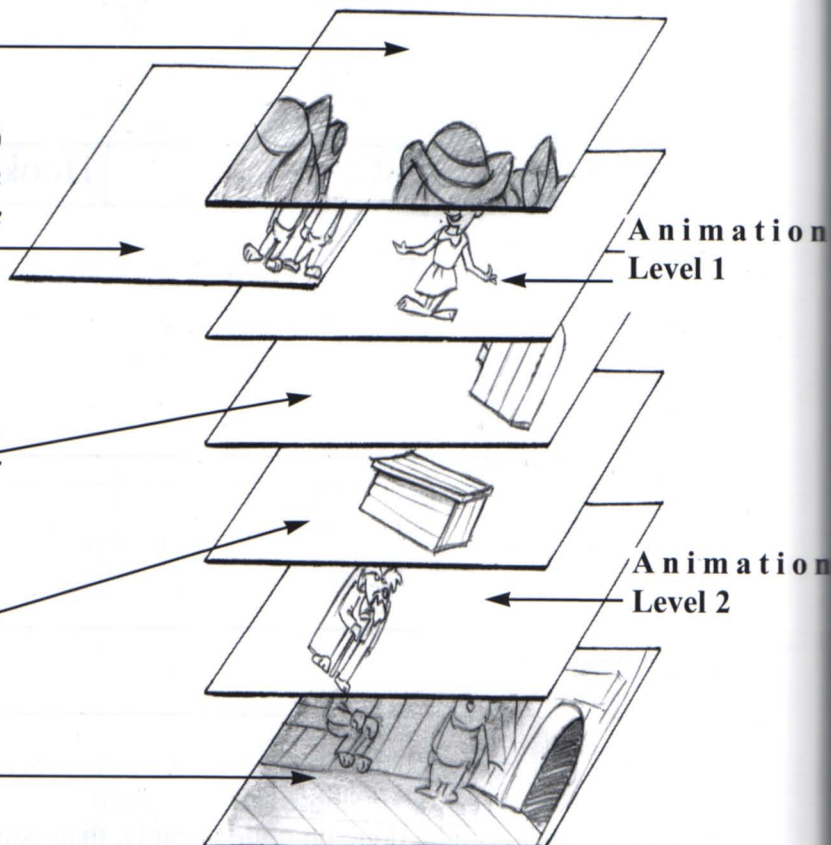

In the previous example, you may have noticed that there are five levels of artwork in addition to the two animating levels. This makes for a lot of artwork, and the chances of one or two pieces being mislaid at some stage is quite high. It is inevitable at background stage that the artwork will have to be placed on separate levels. At layout stage however, you can reduce the risk of losing any of the artwork by drawing all of the levels on a single field and then colour coding them on a Xeroxed copy, so that the background artist knows exactly how they have to be separated. When it comes to reusing individual elements in later scenes, then a copy of the layout with the required level highlighted should suffice. The required piece of artwork can be taken later by the production department and reused where and when necessary.

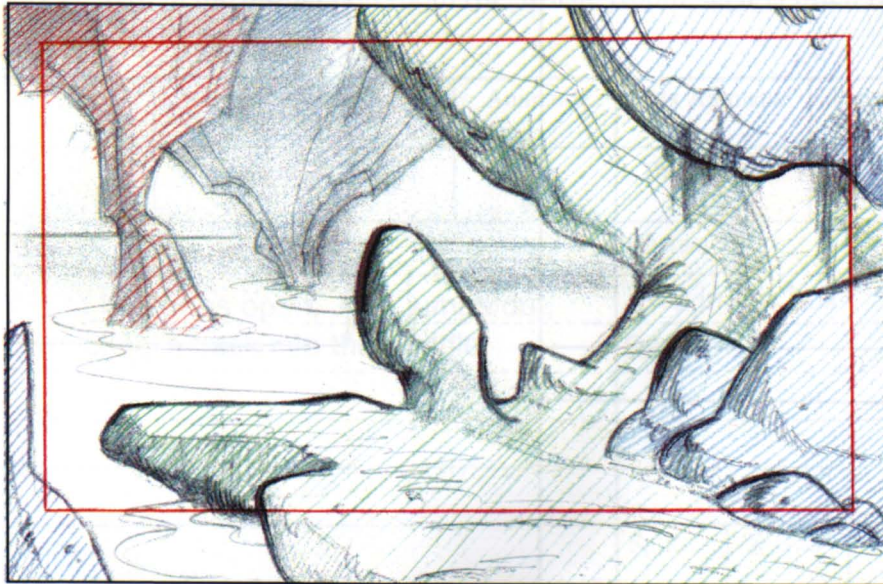

A single colour-coded Xerox may save artwork from being lost. This copy can be included in the scene folder.

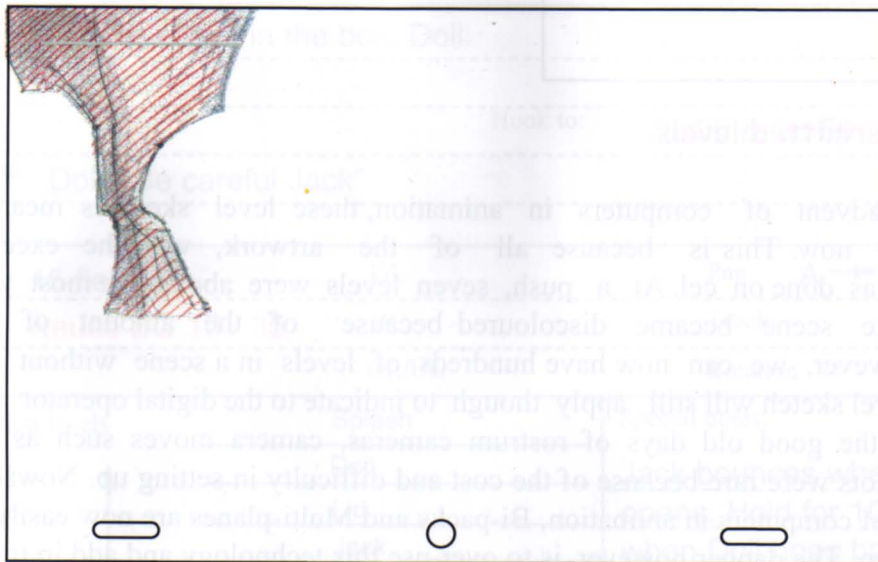

An individual element can be reused in a different scene at a later stage.

Level Sketch

A level sketch shows the animators and camera department at a glance, in which order the artwork will be when scanned-in. This information will be written to greater detail on the dope sheet, the sheet that gives the camera department all of the technical information required to scan the artwork into the computer. The level sketch is usually indicated on the field guide. Here are a few examples:

Animation
BG

OL
UL/OL
Animation
HC
UL
BG

OL
Animation
UL/OL
BG

Amount of Permitted levels.







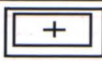

Before the advent of computers in animation, these level sketches meant a lot more than they do now. This is because all of the artwork, with the exception of the background, was done on cel. At a push, seven levels were about the most you could use. After this, the scene became discoloured because of the amount of acetate. With computers however, we can now have hundreds of levels in a scene without any change in colour. The level sketch will still apply though to indicate to the digital operator in which order they go. In the good old days of rostrum cameras, camera moves such as Bi-packs and Multi-plane shots were rare because of the cost and difficulty in setting up. Nowadays, with the advancement of computers in animation, Bi-packs and Multi-planes are now easily done and are seen more often. The danger however, is to over-use this technology and add in trucks, pans etc. at the drop of a hat. Remember, everything in moderation. Don't use every tool on the computer just because you can. Choose carefully!

Blue Book

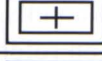

If there is one thing that an animation studio produces apart from the animation itself, is a mountain of paperwork. As more and more departments get involved, it is a good idea to keep central records of the make-up of each scene, the levels, requirements of each department and the director's notes. All of these notes are separated into their respective sequences and then compiled into what's called 'The Blue Book'. Each and every studio has their own format for the blue book. The layout of the blue book page doesn't matter, it's the content that counts. The blue book will probably be kept in the production room (or 'Music Room' as it is often referred to). A copy should be kept in the layout department also.

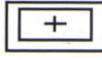
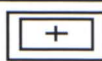
| Prod. | Seq. | Scene | Footage | Animator | Efx Animator | Panel No's |
|--|------------------|-------|------------|----------|---|--------------|
| Jack in the box | 80 | 40 | 6 - 07 | Aisling | Thomas B. | 101 - 106 |
| Description | | | | | Character | |
| Lid of box pops open, Jack jumps out, the doll falls back into the puddle. | | | | | Jack in the box Doll | |
| Special Effects | | | | | Split | X-Diss B-lit |
| Box lid pops open, splash from puddle. | | | | | | |
| Character Animation Jack in the box, Doll. | | | | | | |
| | | | | | Hook to: Sc 30 & Sc 50 | |
| Dialogue Doll: "Be careful Jack" | | | | | | |
| Field | 15 field pan | | OL | | Pan | A → B |
| BG | Reuse BG 10 / 35 | | HC | | Truck | |
| UL | | | OL/UL | | Rotation | |
| Animation levels | | | Splash | | Special notes: | |
| ↑ | | | Doll | | Jack bounces when lid opens. Hold for 10x | |
| | | | Lid | | when Doll hops back. | |
| | | | Jack | | Resume bounce when | |
| | | | Box | | he laughs | |
| | | | Background | | | |

| Scene | Scene: | Description | Reuse |
|-------|---|--------------------------------|----------|
| 10 |  | 12 fld C | |
| 20 |  | 8fld 5W2N | |
| 30 |  | 6fld 5W / 6S truck to 10 fld C | |
| 40 |  | 12 fld C | |
| 50 |  | 12 fld C | |
| 60 |  | 12fld pan A - B | 20 / 250 |
| 70 |  | 8 fld C | |
| 80 |  | 12 fld C | |
| 90 |  | 12 fld C | 80 / 250 |
| 100 |  | 8fld 3W / 2N | |
| | | | |
| | | | |

This sheet is a useful inclusion in the blue-book. It gives a complete description and a diagram of the camera moves for each and every scene.

| | |
|-------------------------|---|
| Director's Notes | |
| Date | Seq. <input type="text"/> Sc.s <input type="text"/> |
| Layout | 12 fld still |
| Background | Reuse layout from sc. 30 / 50, but paint as night sky. |
| Animation | Scout leaps over the wall and lands in the nettle patch. He pauses for a moment as he considers the situation, then shoots skyward. |
| Effects | None |
| Clean-up | Check new colour sep. on Scoots face. |

The director's notes let each department know exactly what they have to do and how they relate to the other departments.

Assignment

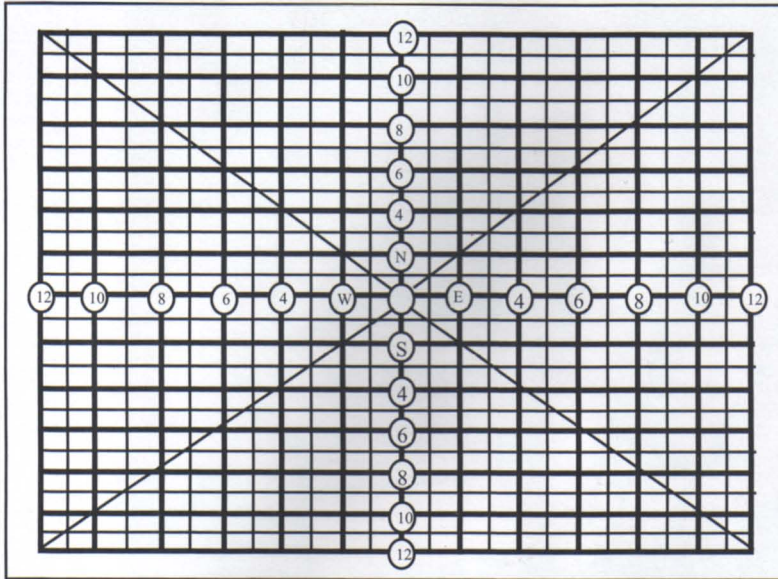

12 fld set-up
 Start 7fC rotate to 7 fld.
 3W 2N 40° CCW curved
 pan as indicated.

Draw a rough field guide for the camera instructions given above.

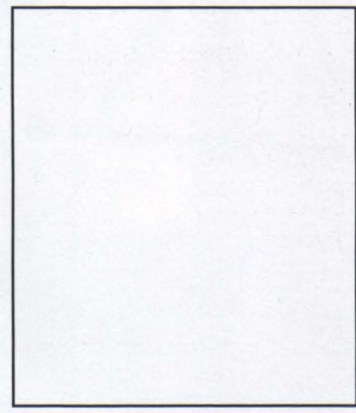
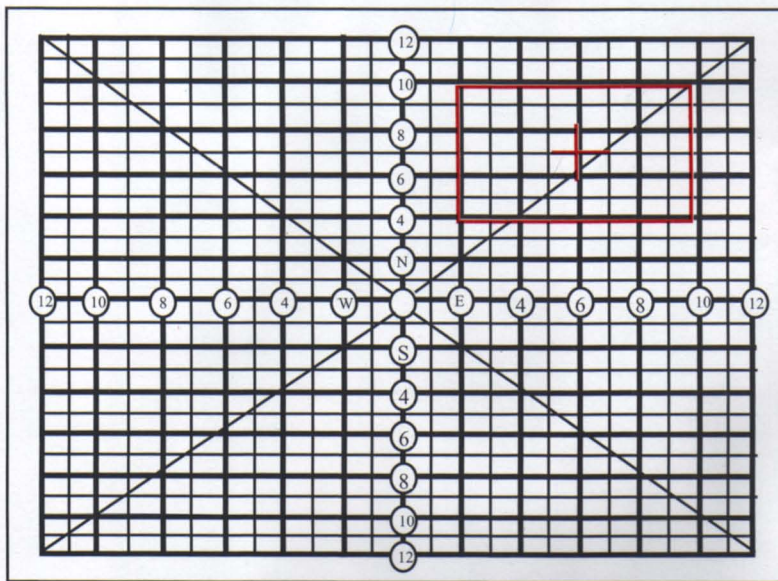

Write out the camera instructions for the cut-off shown.

Answer the following questions orally.

1. What is the difference between a field guide and a cut-off guide?
2. What is the difference between a tilt and a rotation?
3. What is the difference between a bi-pack and multi plane shot?

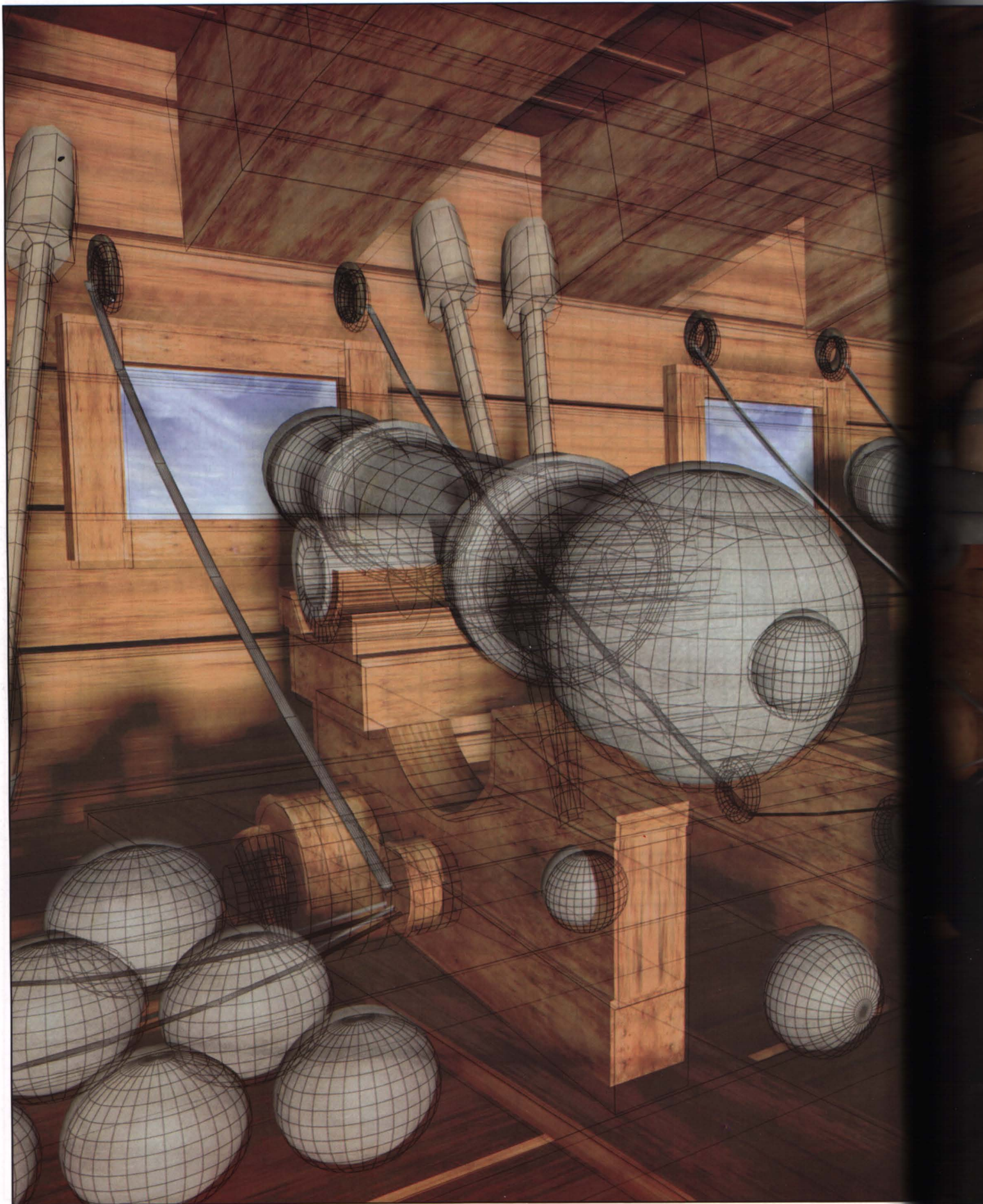

Computers and Layout

Computers are playing an ever increasing role in the field of animation. Shots that could never before be imagined are now commonplace. As computer programmes get better, so does the marriage of classical animation and computer generated imagery, where the computer elements no longer stick out of the scene like a sore thumb.

Computer animators / modellers need to have strong design / drawing skills. Computer models can take hours or even days to build. The studio can save time and money by the animator / modeller 'thumbnailing' their ideas and presenting them to the director for his approval. Occasionally however, the Computer Generated Imagery department will be served artwork by the layout department. In this instance, the animator / modeller must stick to what they have been given.

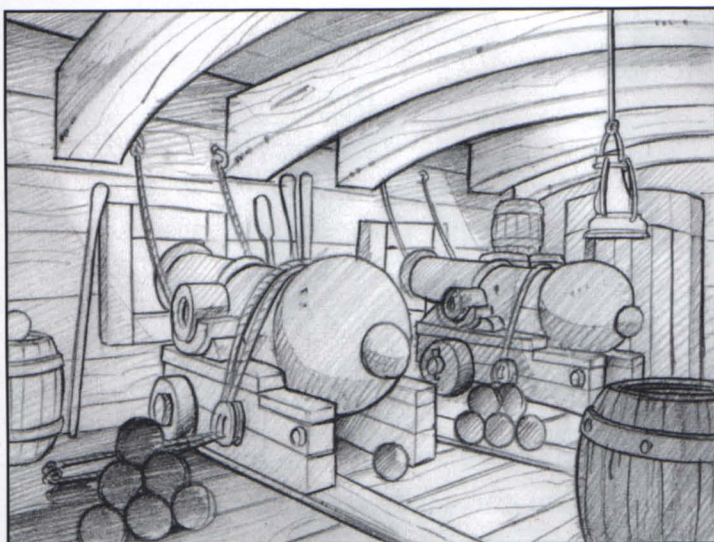

The layout is a 'still' of the final shot.

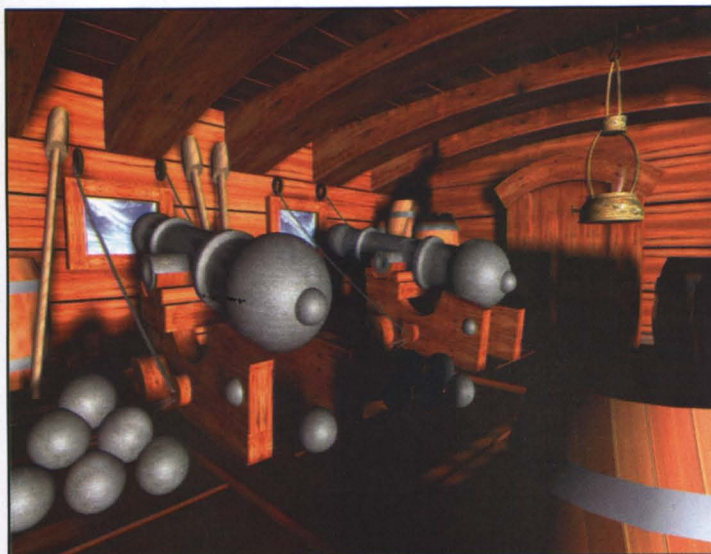

The final 3D model should be the same as the layout.

This method can be used when a 3D character is moving about a still image.

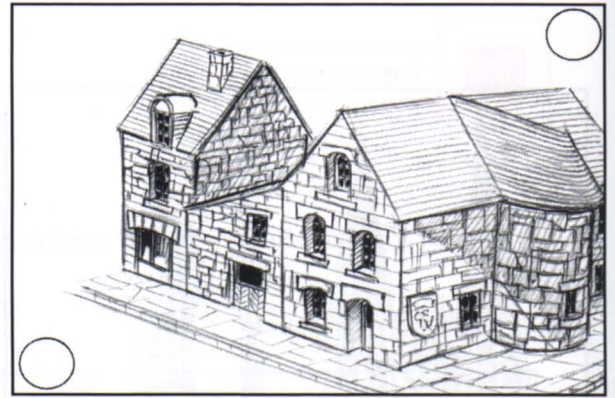

For a 3D model of a town, village or whatever, a series of drawings of the various buildings are completed first. These will then be built and placed wherever they are required. Another successful marriage of computer modelling and layout happens in the case of computer modelled structures. Say, for example, a project requires a few different shots of a cathedral. This might cause a headache for the layout artists, particularly if the building is a complex design. It is beneficial therefore for the layout artist to do an initial design of the building and from there make



a model or have a model made. It is quite simply a case of making print-outs of the building at the required camera angles, and cut-and-pasting them onto animation paper. From there, you can draw the remainder of the scene around the computer model. Storyboards for computer games differ from TV and feature in that they do not follow a straight path from start to finish. Most computer games have levels which must be accomplished before moving on. The storyboard must then cater for each level and for all options.

Character is asked a question which he must answer correctly to go on to the next level.

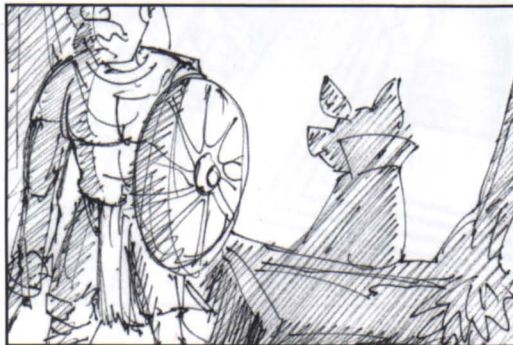

Option A. Go on to next level.



Option B. Game ends, return to start.

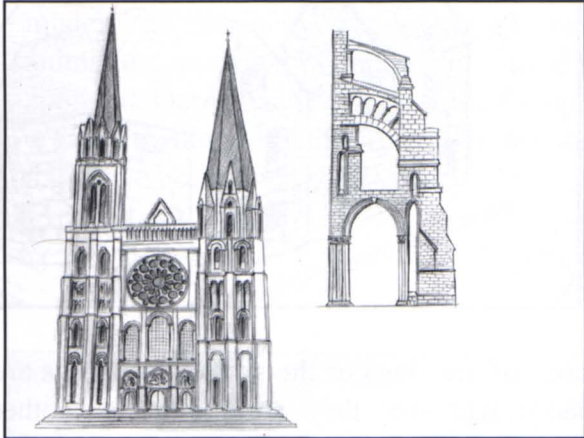

Initial designs are drawn up.

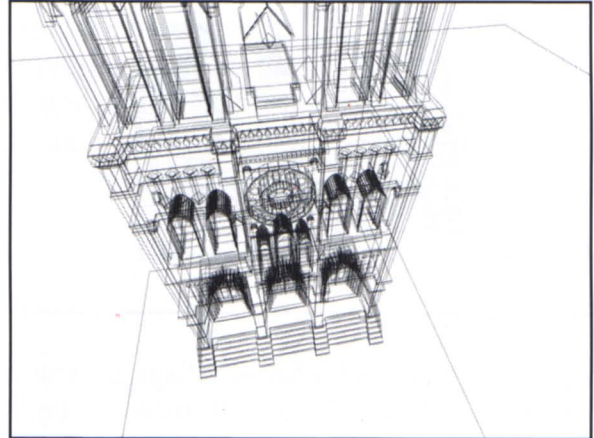

A model is built on computer.

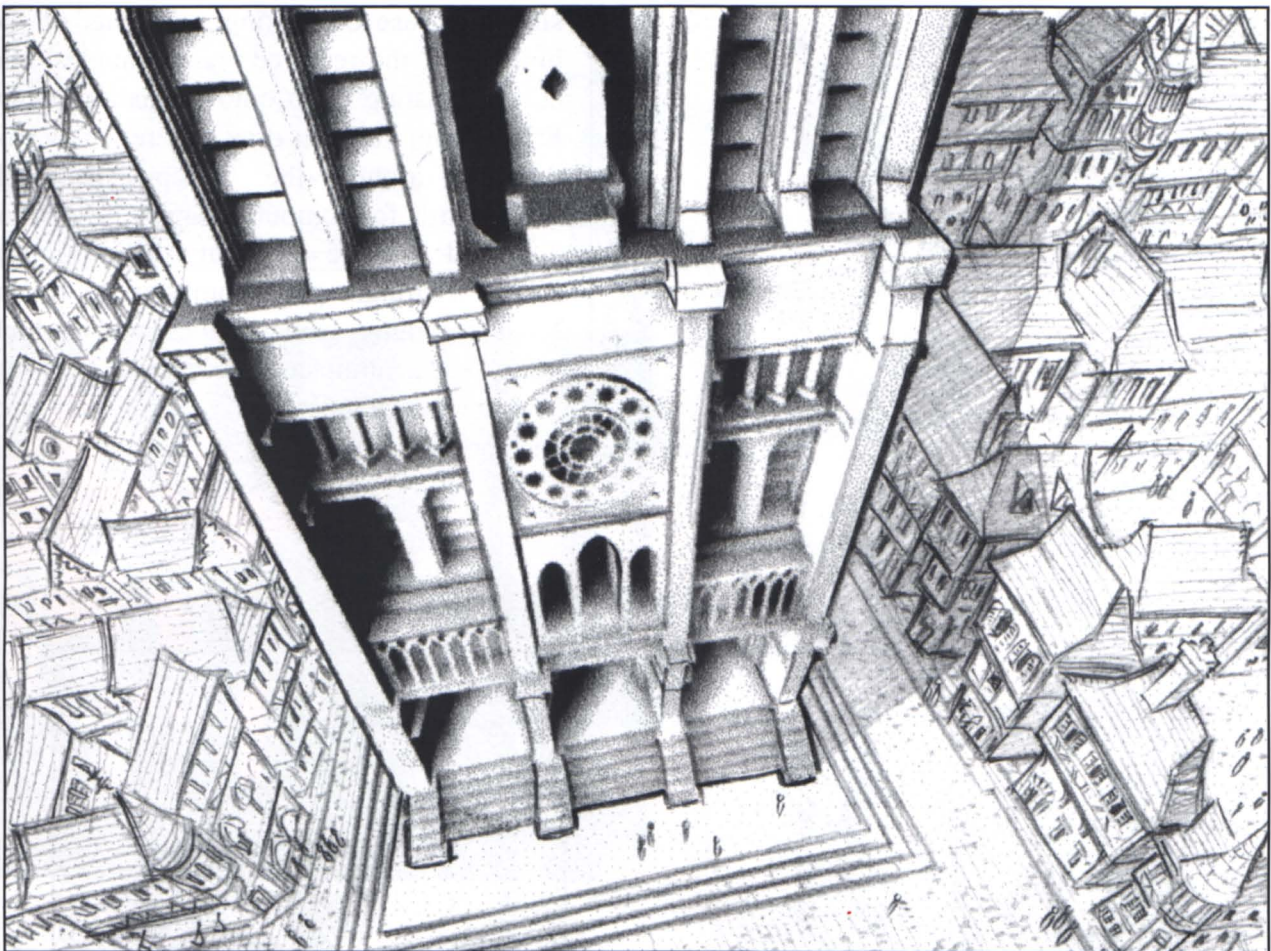

The remainder of the layout is drawn around the computer model.

Assignment



Turn the page on its side, then draw the gunroom from a different angle using a perspective of your choice.

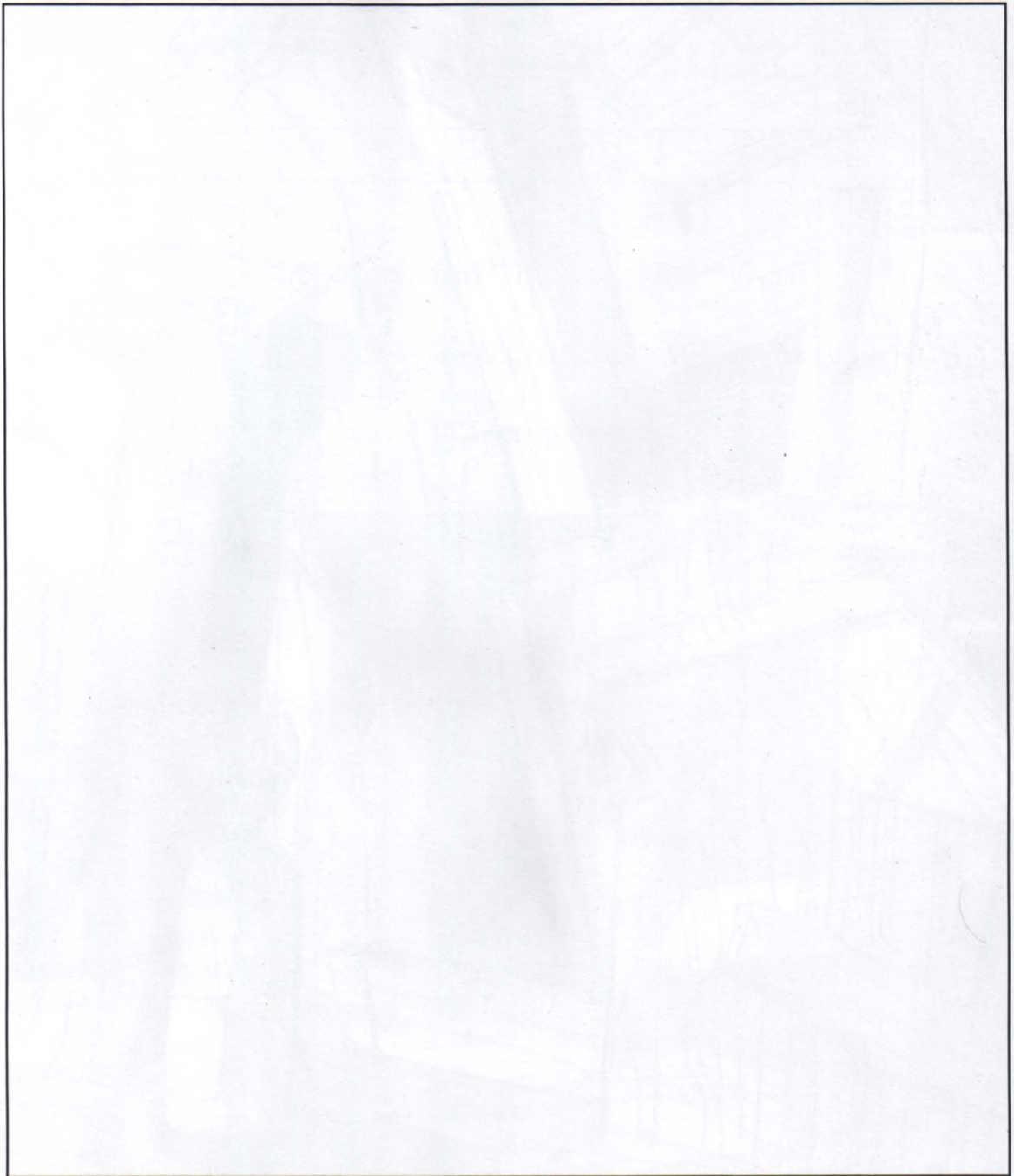

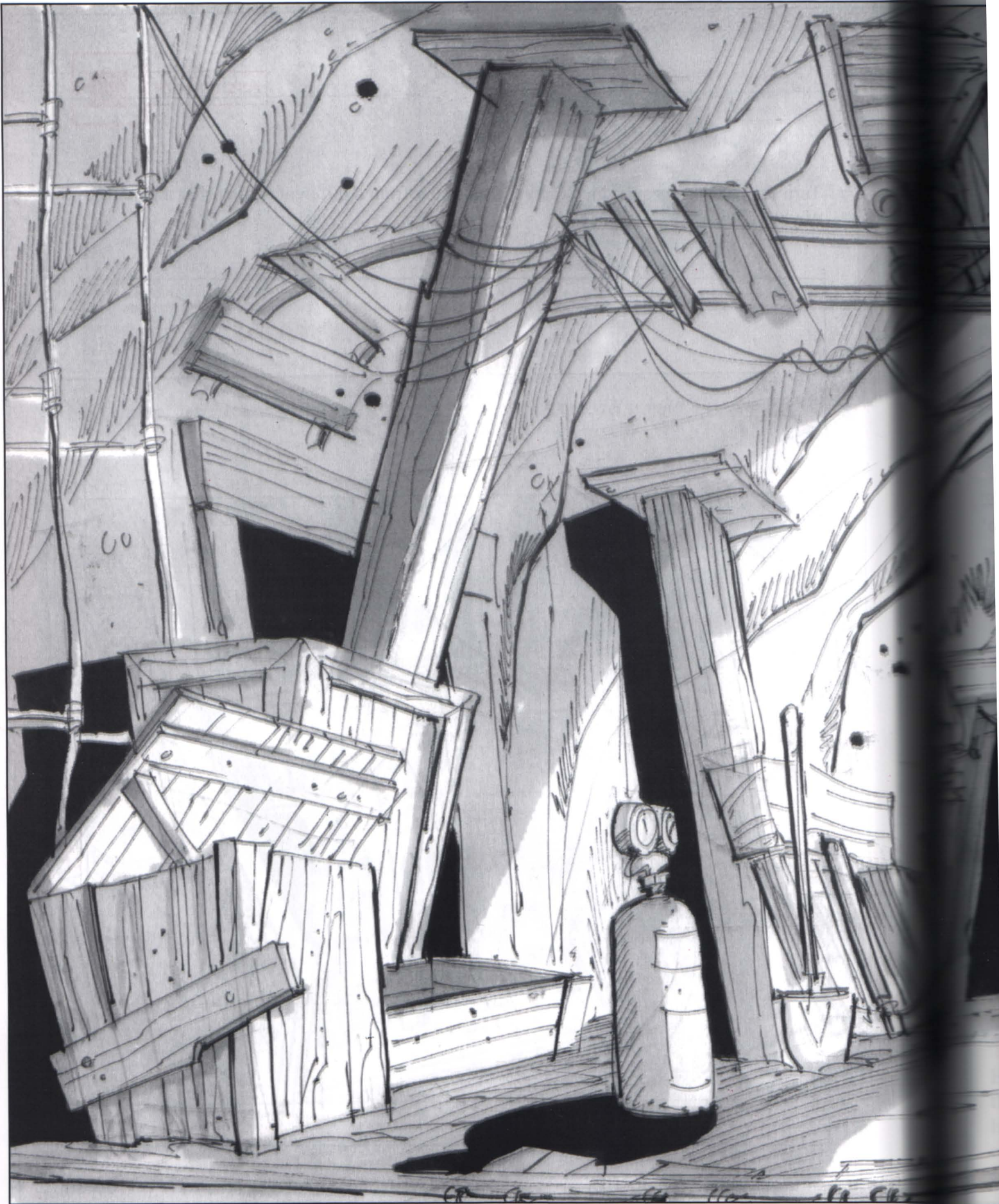



Storyboarding

The storyboard is the first visual version of the project. A strong storyboard is half the project done. It is the foundation on which the movie, TV series or computer game is built.

A storyboard is the first visual version of the project to be put on film, be it a feature length animation, live action film, TV series, advertisement, or computer game. The storyboard tells the story in a series of still pictures (usually key drawings), using anything from a handful of sketches for a commercial, up to two thousand panels for a feature. The storyboard is done directly from the script. The storyboard artist is usually a highly experienced artist. In the animation world, she would generally come from a layout or animation background, and in addition would also have a comprehensive knowledge of cinematography and character design. A knowledge or understanding of acting, dance and singing is also useful. The storyboard artist will have been briefed by the director on her thoughts on the particular piece, and will have copies of the characters' voices from which she will base the level of emotion of the character. She may also have copies of the character model sheets if they were designed by another artist, although this is not always necessary as the final design can be added later.

In a feature length project, it is common for each storyboard artist to work on a sequence. In a TV series the artist would work on an entire episode, although artists can of course work in teams. Not all projects are done from the beginning of the script. It is quite common to pick a good action scene or one with nice effects with a view to using it as a trailer to promote the project, or to use whilst seeking funding for the project. It can be from any part of the story, beginning, middle or end. It is up to the storyboard artist to succinctly convey the emotions of the characters in each and every scene, and to establish the mood throughout each sequence. The storyboard artist will decide on the level of involvement that the audience has with the characters. The reaction that the storyboard artist hopes to achieve from the audience will depend greatly on the project in question. In a feature movie, practically all of the emotions will be conveyed, such as laughing, crying, sadness, joy, relaxation, anxiety etc. Generally speaking, the same applies to TV series. Computer games on the other hand, will strive to excite the players and keep them at that level.

The storyboard panels graphically depict each scene of each sequence, indicating camera moves, dialogue, special effects, music and timing. The script itself will have the occasional suggestions of camera moves, although the storyboard artist will embellish these. The storyboard itself is a very convenient way of making certain that all of the artists working on the project share a common vision, in that everyone knows *what's* going to happen, *when* it will happen and *how* it will look. Storyboards are also a vital component of special effects technology which is becoming more important and more complex with each and every project, be it feature animation or computer games. The storyboard is the place where experimentation takes place and mistakes can be realised before it's too late. It is at this stage that the team can try different versions or options to see what will work best. Quite often, when producing the storyboard, discrepancies in the structure and format of the script are detected and corrections can be made also. When the storyboard is put together, it allows the production team to see and appreciate the size and content of the project. If the project is a full-length feature, then the design team will discuss the board, usually headed by the director. Naturally enough, the storyboard will allow each and every department to see how and where their particular elements will fit into the overall project, along with everyone else's. From the storyboard, the supervisor of each department can tell the director how many artists it will take to complete a particular scene / sequence and how long it will take. It can then be established if the storyboard artist's suggestions are in fact feasible, or if they are too difficult to do or quite simply too costly. The director may put forward a different suggestion which may also be incorporated.

The old saying of a picture being worth a thousand words must have been made up by a storyboard artist. A line in a script cannot express the mood or emotion of a scene in quite the same way that a storyboard can. It's worth remembering that unlike live action, it is not practical to shoot hundreds of feet of extra animation in order to select the best shots, although that's not to say that none goes to waste! When the storyboard (or part thereof) is complete, it is shot on camera, creating a *story reel* or *licra reel*. Each scene or sequence is shot to run the same length as the final shot in the project. The storyreel is then synchronised to a backing track using either the original score or a temporary track. As each scene is animated, it is shot and cut into the reel. This system continues through each level of animation, clean-up and finally colour, until the entire project is on film or on computer.

The storyboard is quite like an architect's drawing. All of the information is there to take the project from start to completion. Trying to begin a project without a storyboard is akin to putting building materials into a field and expecting a builder to come up with the house of your dreams. It won't work! The storyboard itself shouldn't be ambiguous. Remember, it is highly likely that a project storyboarded in one country will be animated in several others. The storyboard artists generally have no input into the actual story itself, other than to suggest an additional gag or whatever. Much in the same way that other artists won't make changes to the storyboard, the storyboard artist won't add in extra bits because they alone think would help.

The characters on the storyboard should be fairly recognizable, but it's not always necessary to do final 'on model' drawings. This is the job of the layout artist. The studio may however have a separate artist who does the character poses.

Some of the elements for a good storyboard are:

- * Good use of scene changes or transitions, e.g. cuts, dissolves, fades etc. A scene that stays too long on the character will bore the audience. A scene that is not long enough will mean that they might miss the action.
- * Good staging. Positioning of props, e.g. boxes, furniture etc. or even natural elements such as clouds or a puddle are as important as good character staging. The degree of work on the background will depend on the project in hand. The following is a very loose breakdown on the importance of the background.

Classical or Feature Animation ;

Here the backgrounds are done to a very high level, but fall slightly short of being fine art paintings in order that they don't detract from the animation itself, which is what the audience has come to see. They are usually painted in gouache or acrylics, although water-colour and oil paint have been used to great effect.

TV Animation;

Here the backgrounds very often play second fiddle to the animation and in a lot of cases are so simple that they contain little more than a horizon and a couple of props. In some cases however, the background needs to be as important as the animation, the reason being that there may be a lot of limited or held-animation giving the audience more time to let their eyes wander around the screen.

Computer Animation:

There are many different types of computer games; Shoot 'em Ups, Platform games, Point and Play, Racing etc. In the majority of games the player won't really care about the background. They're more interested in the characters and the effects of their actions. In Point and Play games the audience will interact directly with the background and so it should be as good, or even better than the animation itself.

Generally Speaking:

The storyboard artist will give an indication of what the set will look like. She may even go into some amount of detail, but at the end of the day it's the layout artist who will come up with the final design. The storyboards themselves are generally done on individual panels. These panels are then mounted on a wall or on display boards and presented to the director / the design team. The reason for the individual panels is that single images may be taken out and deleted or altered. Directors more often than not don't know what they want until they see what they don't want! Be prepared for rejection, you'll receive lots of it in your professional career. A successful artist will never fall in love with, or be 'precious' about their work. After the storyboard has been approved in its loose form, it can be re-worked onto a sheet of four to six panels (usually four). When complete, the sheets are photocopied onto A4 or A3 paper and held with a clip, then sent to each department in the studio. The reason for the clip is that it is likely that the board will change at some stage during the production. If the particular sequence is stapled together, it will be harder to take it apart to change a page. The reason for the A4 or A3 pages is that they are recognised around the world and are easy to photocopy, fax, or e-mail.

The following few pages will show you some of the stages in the production of a storyboard. It's not the formula that every studio uses, nor is it implied that it's the only way to produce a storyboard. For the beginner however, it can save a lot of time, trouble and money further down the line.

From the Start:

The whole project starts with an individual, or a group of people coming up with an idea. They then persuade some nice people to part with lots of money to turn their idea into a movie, TV series, computer-game or whatever. The idea they have is referred to as 'The Premise'. These people then employ the services of a professional scriptwriter to turn their thoughts into something more tangible.

So what is a Premise?

A Premise is basically the theme of the story. Most stories centre on an aim or objective being blocked by an emotional or physical barrier, leading to action being taken to overcome the barrier, resulting in the aim or objective being met. The first quarter or thereabouts of the movie should introduce the audience to the characters and the main story point. Half of the movie will then involve the action required to overcome the barrier and achieve the goal, and the last quarter wraps up the show. Try not to keep adding characters throughout the movie though, as it will only confuse the audience. In computer games, you can add characters whenever you like (depending of course on the type of game!) although these would tend to be incidental characters. All conflicts that have been introduced at the start should be resolved at the end. In TV shows, it is common to have a recurrent theme that starts in episode one and concludes in episode twelve, or whenever the series ends. These shows would additionally have conflicts within each episode which are subsequently resolved in each episode.

The Script

For most animation artists, the task of producing top-drawer artwork can be challenging enough, even with a head start. The layout artist is given the storyboard, the background artist is given the layout and the animator is given the storyboard plus the layout, and so on and so forth. Unfortunately, the storyboard artist has little or nothing to go on but the script. She occasionally gets some pre-production conceptual artwork, if the studio is sufficiently big enough to have such a department. Most however, have to come up with the goods themselves. The storyboard artist is handed the script and has to turn the words into pictures. Once the script has been agreed by all and sundry, and everyone has got their dime's worth of unnecessary changes, the go-ahead is given for the script itself to be completed. The script doesn't deviate much from the approved treatment. If the scriptwriter comes up with an alternative storypoint which they would like to include, then he will contact the production team for approval. Before we look at methods of producing the artwork, we'll first have a look at the make-up of a script. A script for a half-hour TV series episode usually runs to approximately thirty pages, whereas a script for a feature length movie may be about eighty pages.

So:

The scriptwriter goes off with the premise in his head and comes up with a 'treatment'. The treatment is in essay form, with the key words highlighted and excludes any superfluous detail. When the treatment is complete, the scriptwriter(s) present it to the production team. At this point, changes can be made as required. After a couple of drafts have been submitted, the scriptwriter(s) gets the go ahead to do up the script. The script follows a writing pattern similar to the treatment, but is further broken up into sequences.

Sample of a part of a treatment.

7

We pan around Doug's bedroom which is strewn with **toys** of every make and size. Action-hero figures line a row of shelves. Building blocks form a bridge over a train set which merrily chugs its way around the room. Sports equipment lies dormant in boxes. A baseball bat and tennis racket protrude from the top of one box. A **dartboard** hangs on the wall, the darts embedded in the wall itself. Clothes hang from a **mirror** in the shape of a clown. Several toy aeroplanes and spaceships hang from the ceiling.

A calendar with the days to school holidays crossed out. A blackboard with a painted handprint straddles a toy train-set, a toy train perpetually runs around the circular track.

These details always head a new sequence. From here to the next heading is a sequence. The scenes are made up with what's written in between.

Int. (internal) or Ext. (external) + Location + time of day, e.g. night, sunset etc.

MAIN TITLES OVER;

INT. - DOUG'S BEDROOM - DAY

We pan and truck through Doug's bedroom, over assorted toys scattered over the floor, cars and trucks, Action figures etc. A half built model aeroplane sits on top of a dresser. Clothes are strewn about the room. We pass a large mirror, held by a clown.. Shelves hold trophies and even more toys. Beside the dresser is a box with sports' equipment sticking out., a baseball bat, fishing rod, tennis racket etc. Above this is a dart board. Against the wall is Doug's bed. The bed itself is raised off the ground with storage space under and a table built on to the end. The storage space has been converted to a 'Super Hero' cave using bits of cardboard etc. On the table sits a computer and games consol. In a dark corner sits Doug, our six year old hero, reading a comic. A glow emits from the comic.

Cut to :

Down shot of comic, (which has come to life) where we see an action hero finish off a couple of 'baddies'.

DOUG

Wow, Captain Wham!, you're the greatest.
I'd love to be like you.

CAPTAIN WHAM

That's true Doug, I am indeed the greatest,
and nobody's as cool as me!

Inspired, Doug throws the comic down...

CAPTAIN WHAM (OS)

ouch!

....and runs over to his 'Super Hero' cave. Camera slowly trucks in as we hear banging and thumping from inside. We then see beams of light coming from inside. From the beams comes the **silhouette** of a Super hero. The light clicks off and we see Doug standing outside his cave, torch in hand, in a Super Hero outfit that he has made himself. He walks over to the **clown mirror**. Over Doug's shoulder, we see a reflection of a muscle bound Super Hero, as Doug gazes at his imaginary self.

Dissolve to:

Keep details brief and to the point. No 'Once upon a time' stuff.

Some camera instructions can be included. The Story-board Artist will include the rest in the board.

Dialogue is always Centred.

Key words are typed in Bold lettering.

The character's name must always accompany the dialogue. Extra instructions such as 'laughing', 'crying', 'shouting' etc. can also be added.

The storyboard artist will read the script over and over. She might get an overall idea for the project and present it on a single sheet of paper. The very first sketches the storyboard artist is going to do are tiny thumbnail drawings either on a few sheets of paper at her side, or on the script itself. As the artist is reading the script, images flash through her mind and it's always advisable to scribble these down, as they mightn't be remembered later on. The storyboard artist will of course read the script over and over and each time might come up with different ideas. She will also have a copy of the sound track and the character actor's voices in order to get a feel for the emotions of the character in the script. For example, the script may say that the character is crying, the storyboard artist may draw a character thrashing about, wailing uncontrollably, whereas the actor may only be gently sobbing. A mix-up there would look very silly on screen! The storyboard artist must carefully choose the scene types, for example, if the character has an evil look on his face or is winking at somebody, then she wouldn't use a long shot due to the fact that the character would be too small and the emotion would not be seen.

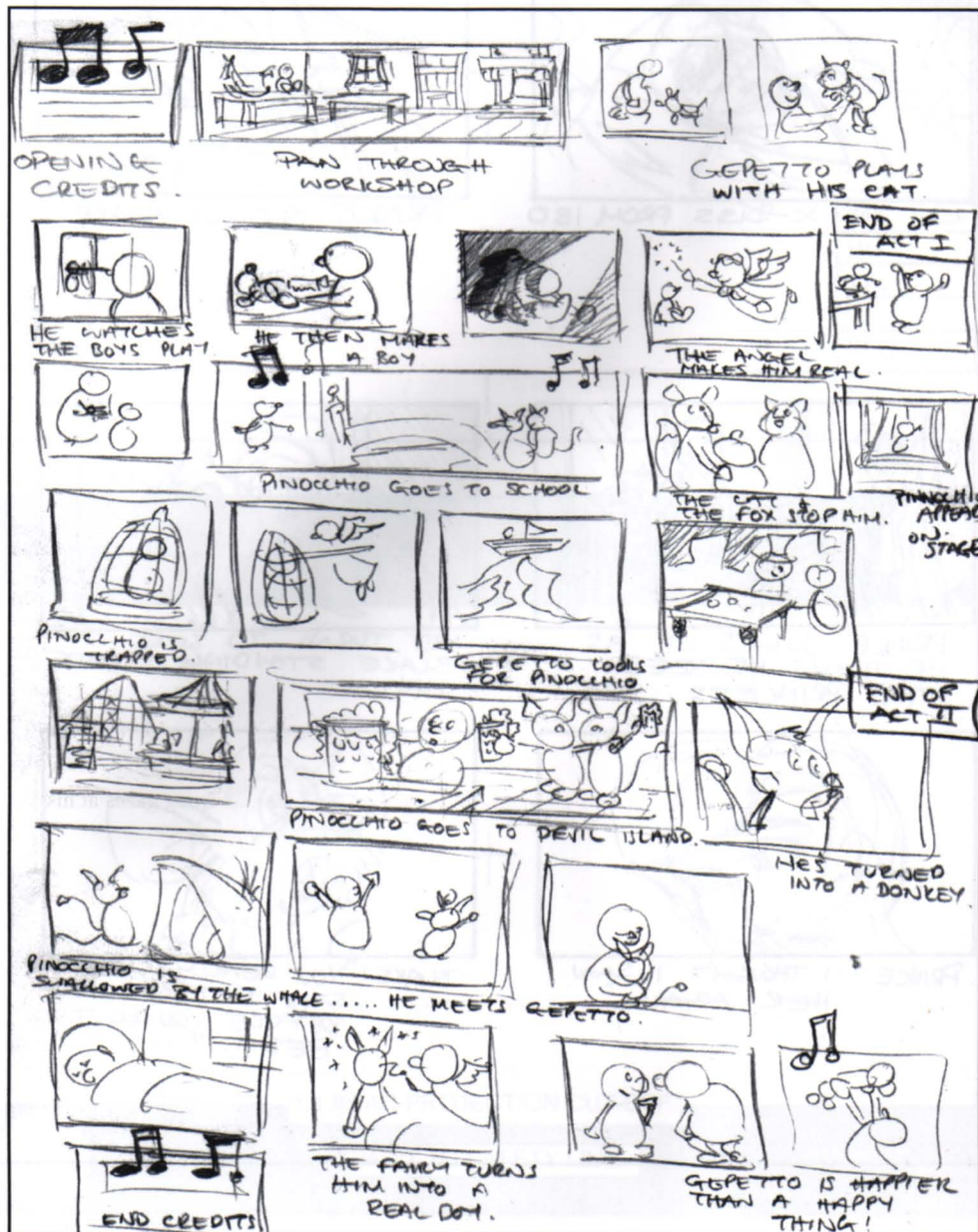

Having possibly discussed these scribbles with the director as to the make-up and general flow of the project, the storyboard artist will then start on more developed storyboard panels. There may be approximately six to eight of these to an A4 sheet. There should be some detail and a good idea as to who the characters are, but they don't necessarily have to be on model. This is still at the preliminary stage. The beauty of working to this scale is that quite a substantial amount of thumbnails can be done and presented for consideration in a relatively short period of time.



CUT TO: X-DISS FROM 180



PRINCE SLOWLY AWAKES



PRINCE JUMPS UP AS HE THINKS HE SEES THE PRINCESS.

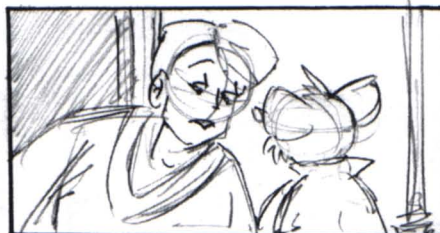

HE TURNS TO SEE BLAKE STANDING BESIDE HIM.



PRINCE: "I THOUGHT I SAW HER AGAIN."



BLAKE: "YOU REALLY SHOULD STOP EATING CHEESE BEFORE YOU GO TO BED !.."

Storyboard panel design will vary from studio to studio. Indicated below are two good designs that are commonly used. These can come in pads of various sizes. Storyboard artists will differ in their preferences as to the size of the panel they draw on, in that some like to draw small, others like to draw large. At the end of the day though, it's up to you! Indicate any tilts or rotations that might be included in the scene, the angle you draw it at doesn't have to be exact, the layout artist (or scene planners) will decide on the final angle.

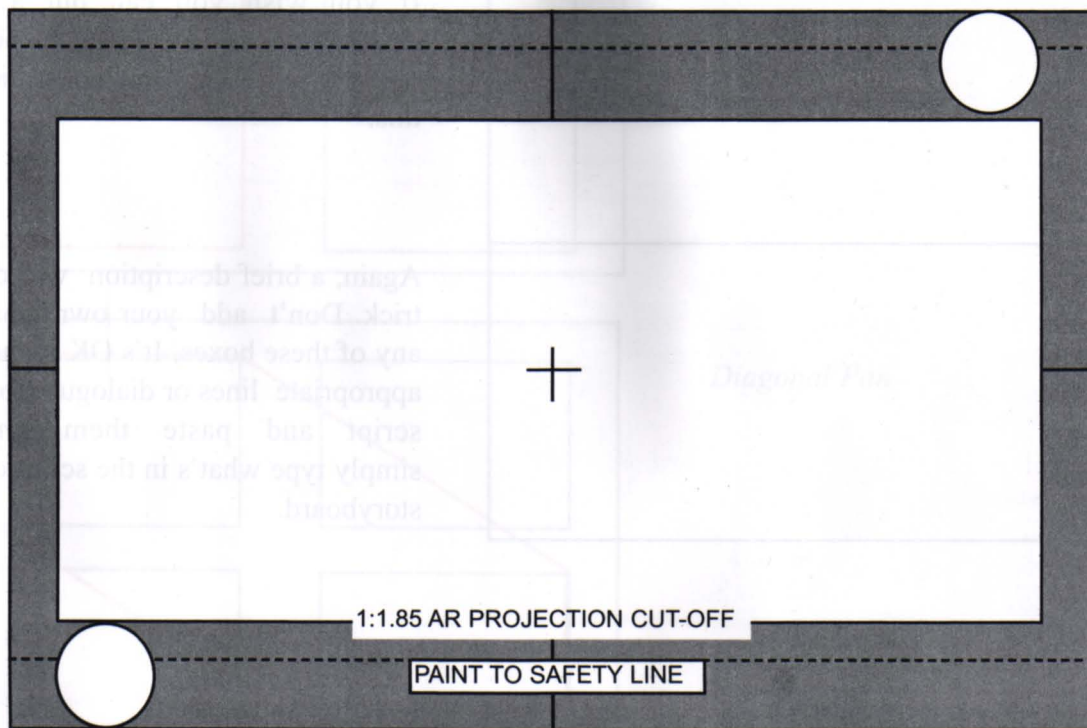
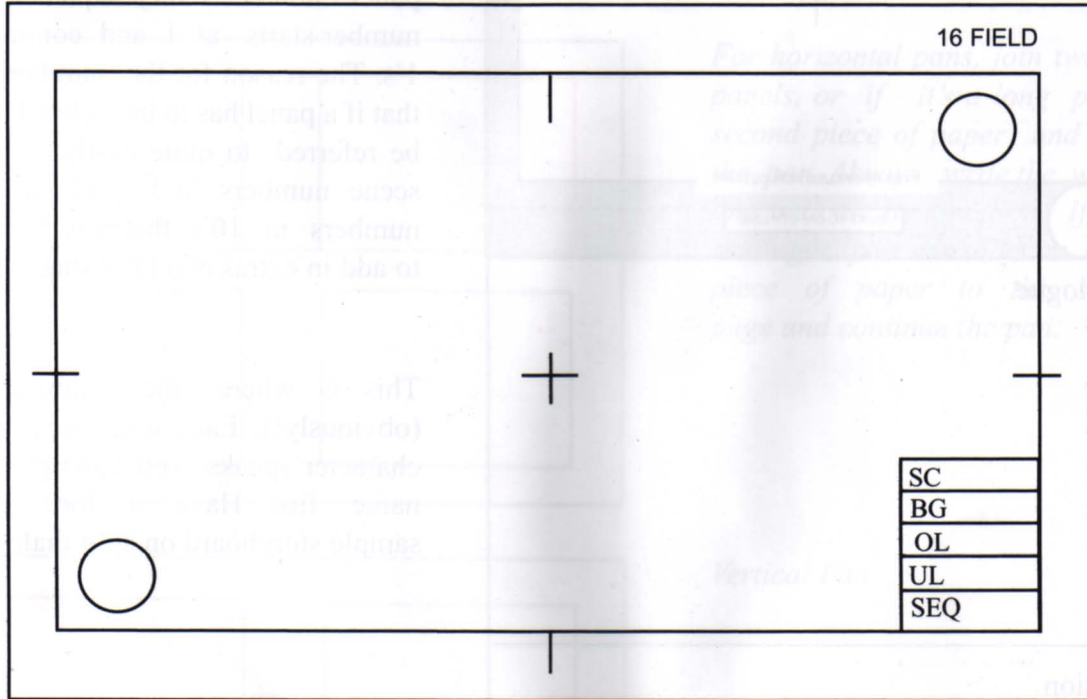

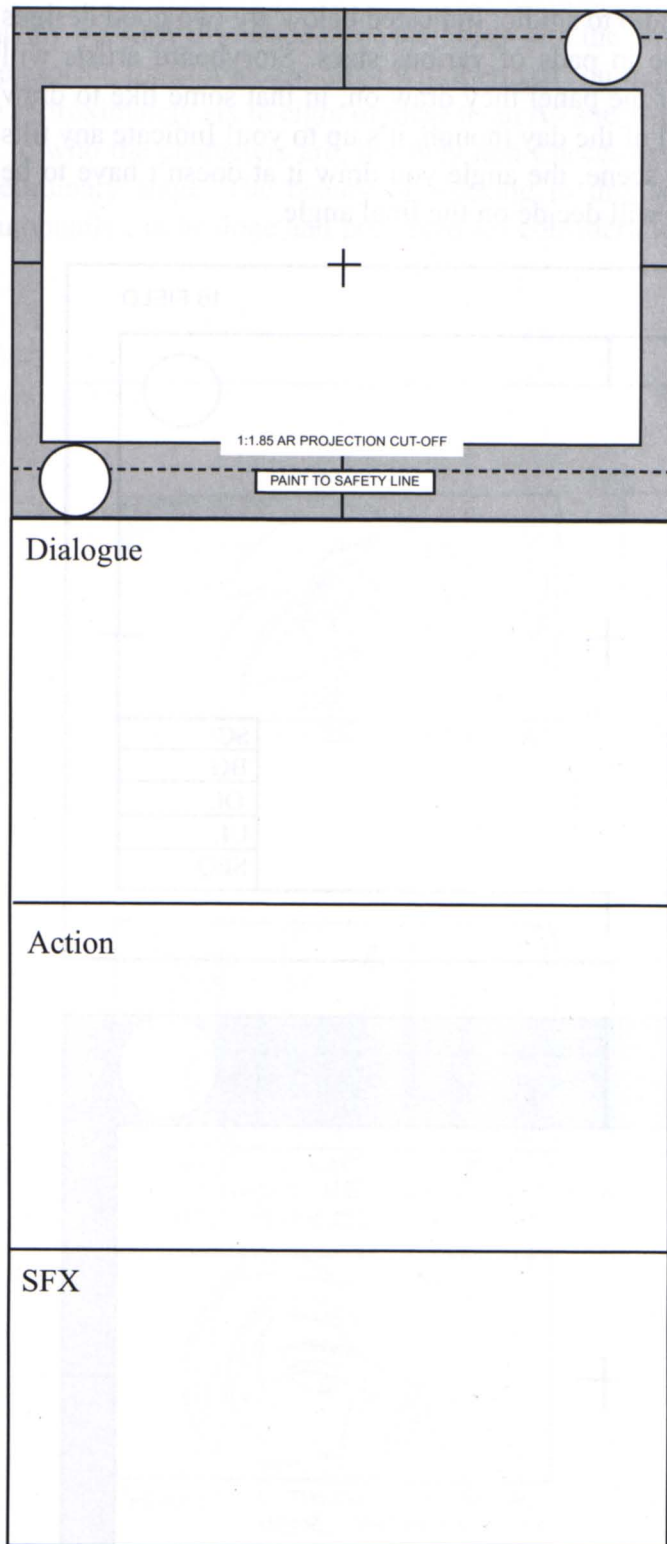

The shaded area represents the full field size. The blank portion represents the area that will be seen on the screen. The circle in the top right corner is for the timing and the circle in the bottom left is for the panel number. Every sequence panel number starts at 1 and continues in 1's. The reason for the numbering is that if a panel has to be deleted it can be referred to quite easily. Hint: Do scene numbers in 5's and sequence numbers in 10's, this way it's easier to add in extras at a later stage.

This is where the dialogue goes (obviously!). Each and *every* time a character speaks, you must put their name first. Have a look at the sample storyboard on split dialogue.

If you wish you can put a brief description of the action, as per the script here, though not all studios do this.

Again, a brief description will do the trick. Don't add your own words in any of these boxes. It's OK to cut the appropriate lines or dialogue from the script and paste them on, or simply type what's in the script on the storyboard.

There may be three or four of these panels to an A3 page.

The information that goes on the storyboard is important, the format it takes is secondary to this. The board itself is generally read from left to right and top to bottom, much like a comic. It may be worth remembering that the cut-offs vary between TV and cinema. They are: 1:1.33 for TV, 16:9 for wide screen and 1:1.85 for cinema. If you are adding pans, either horizontal, diagonal or vertical, they should be indicated as such on the storyboard. Try to avoid putting panning shots in a single panel. The diagrams below demonstrate useful ways of indicating pans on a storyboard.

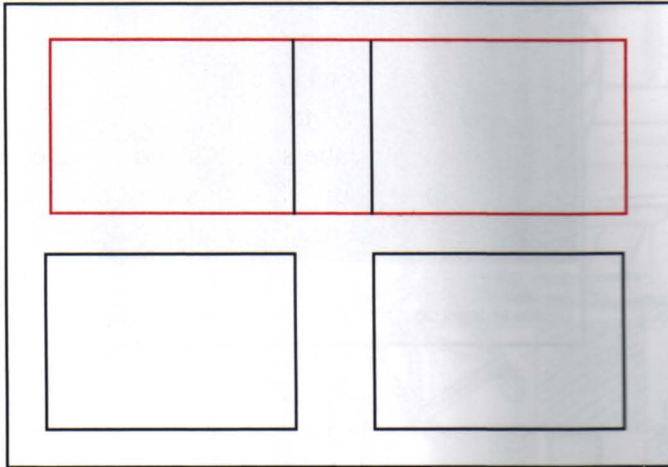

For horizontal pans, join two or more panels, or if it's a long pan, add a second piece of paper and continue the pan. Always write the word 'Pan' and indicate its direction. If your pan is longer, you can add an additional piece of paper to the storyboard page and continue the pan.

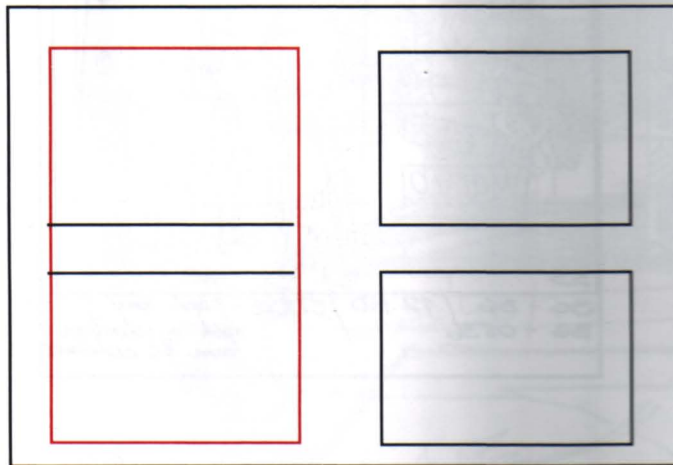

Vertical Pan

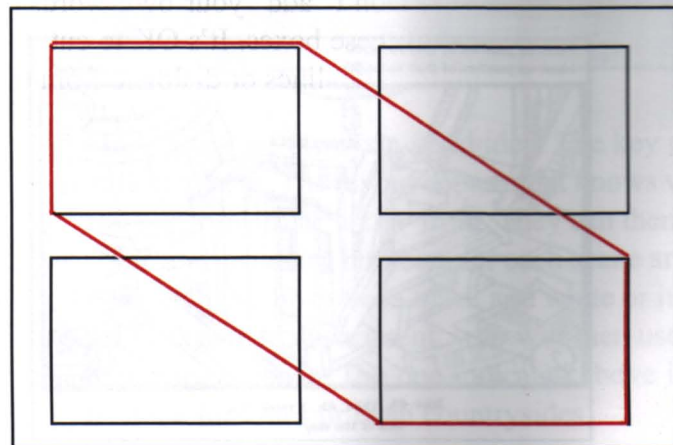

Diagonal Pan

As I have said before, every storyboard artist will her own preferences as to what size she does her artwork. It is not unheard of for an artist to do her panels on 16 field and then have them photo-reduced to fit a more regular format, i.e. A3 or A4. It's also not unheard of for storyboard artists to do A1 sized 'thumbnails'!

Styles of Storyboard.

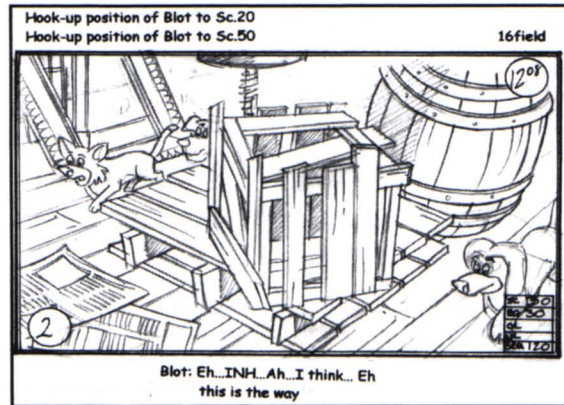
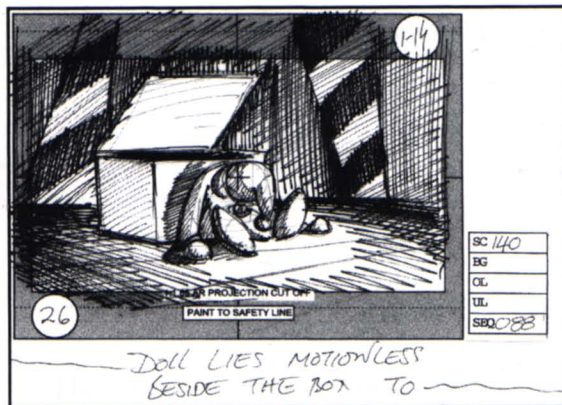
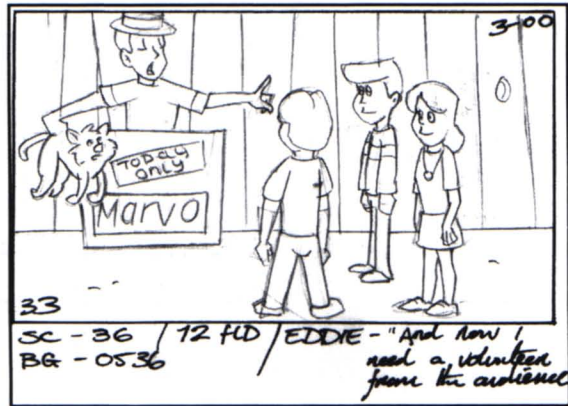
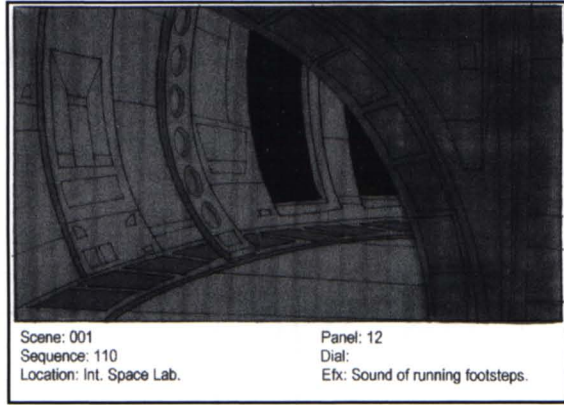
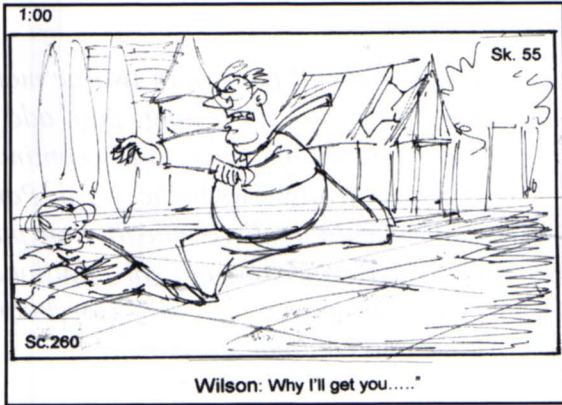



Floor Plans

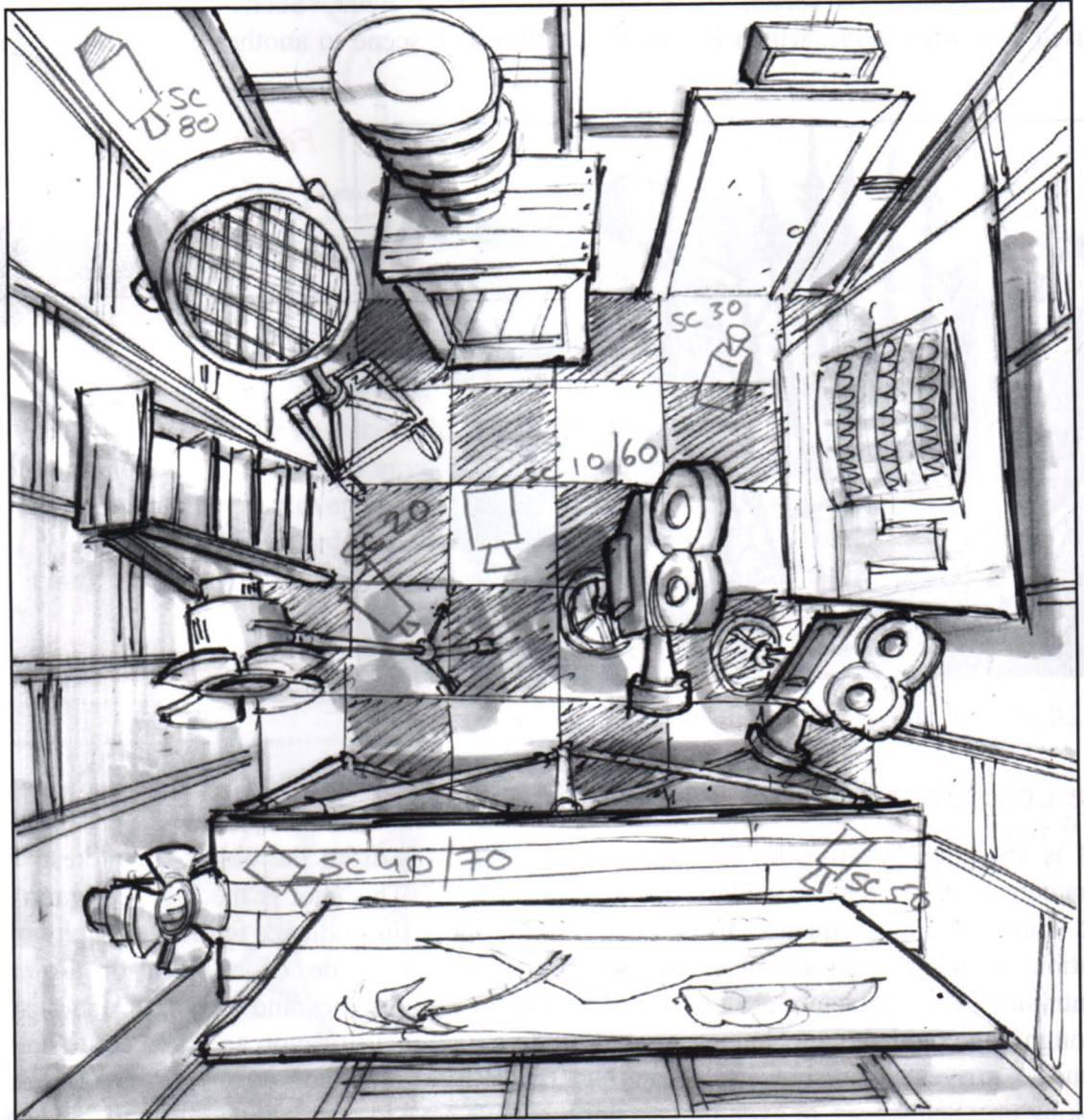

Floor plans are always a good idea. The key camera angles for each sequence can be indicated here. The layout department knows where the pans, medium-shots, close-ups etc. are going to be taken from. They can then develop these shots as key-layouts. The scene and sequence numbers for each scene are written beside the camera symbol. The floor-plan can be done in black and white or it can be used as an overall colour key for the background department, who will then use it to produce their colour keys for each scene or sequence. The one indicated above is for a single room. They can of course be done for cities or even countrysides.

Scene Types - Cinematography

In the TV or film industry, be it live action or animation, there are generally several types of shot used when shooting a scene, these are called *scene types*. Scene types shouldn't be confused with *transitions*, which is how to get from one scene to another. We'll look at those later.

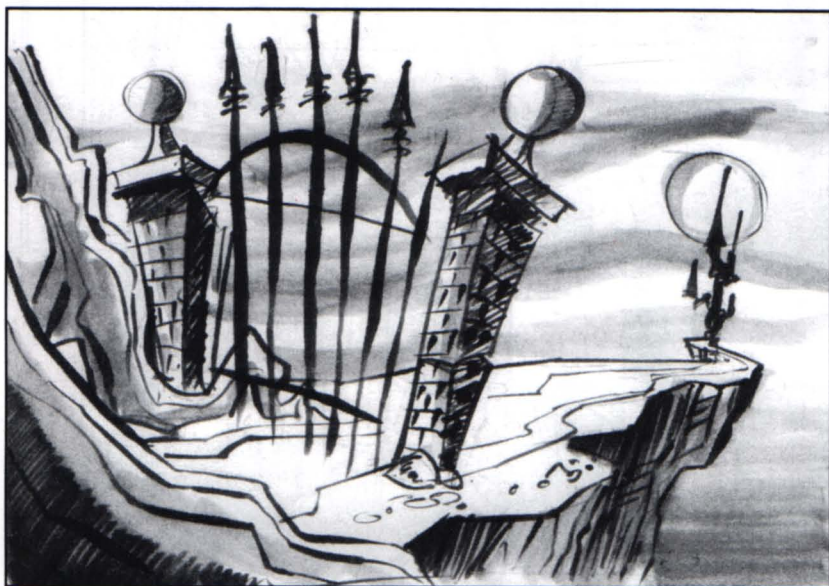

Feature: 15 or 16 field.

TV / Computer Games:
12 field.

The Long Shot or Establishing Shot

This is so called because the camera is usually far away from the object of interest, be it characters or props. The secondary title speaks for itself. This shot is the most common shot used when opening a sequence. Its purpose is to introduce the audience to the geography of the location in which the action is happening, be it the inside of a room or an entire countryside. The characters are usually incidental in these scenes and are often unnecessary, although you could show a character travelling to a particular location and then cut to a scene when he arrives. The shot itself can be 'Bird's-Eye' (looking down) or 'Worm's-Eye' (looking up). Sequences, or even movies don't always have to open with an 'establishing shot'. A good director could open a movie with a close-up of a character's eye and take the audience from there! The establishing shot can be a still or a pan. It just depends on how much information you want to give the audience.

When you're drawing your storyboard, don't overuse any one shot or scene type. For example, having all full shots or all medium shots should be avoided. As you are working on your section of the script, it's always a good idea to show your work to fellow artists to get their opinion. Be careful though, when you ask someone for their criticism - they tend to give it!

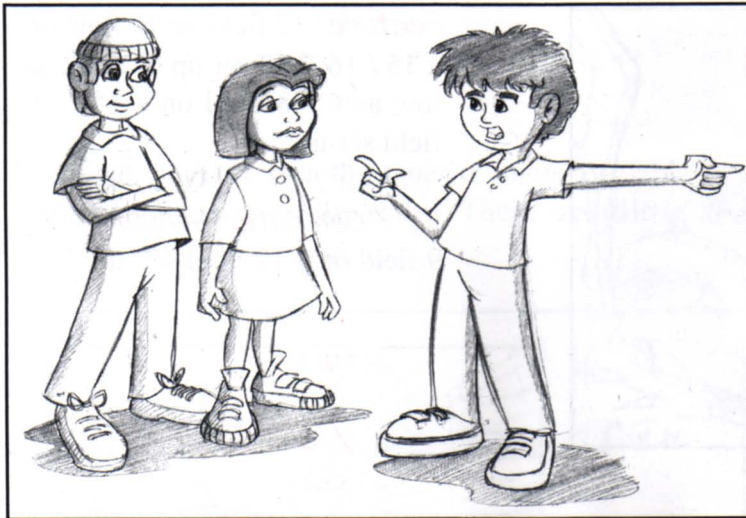

Feature: 15 or 16 field.

TV / Computer Games: 12 field.

The Full Shot

In the Full-shot, we see the characters in full figure. We use this shot to show their positions in relation to each other, also to show any important action between the characters. If there is a lot of dialogue, you can cut to an over-the-shoulder shot, from we'll say, a character who's doing the talking. We need to do this in order to retain the audience's interest. If one or more character moves about, it *may* be necessary to return to an establishing shot so that the audience is reoriented.



Feature: 15 or 16 field, or 12 field on a 15 / 16 field set-up.

TV / Computer Games: 9 - 12 field on a 12 field set-up.

The Medium Shot

This is the most common and overused shot, which is taken 'slightly higher than waist-up'. It's generally used when characters are in conversation. Again, it can be varied by using an over-the-shoulder shot, or by swapping these shots, but be careful not to swap too quickly between shots, or things may appear to strobe on screen. Eye contact between the characters is also important, which is something we'll look at later.



Feature: 12 field or 12 field on a 15 / 16 field set-up or truck as low as 6 - 8 field on a 15 / 16 field set-up.

TV / Computer Games: 8 or 9 field on a 12 field set-up.

The Close-up

The Close-up is a single-head shot. It is used to capture subtle expression on a character. It can also be used for dialogue. This shot centralises the audience's attention on what is affecting the particular character without interference from the surrounding environment. The close-up would usually have a soft-focus background behind it.

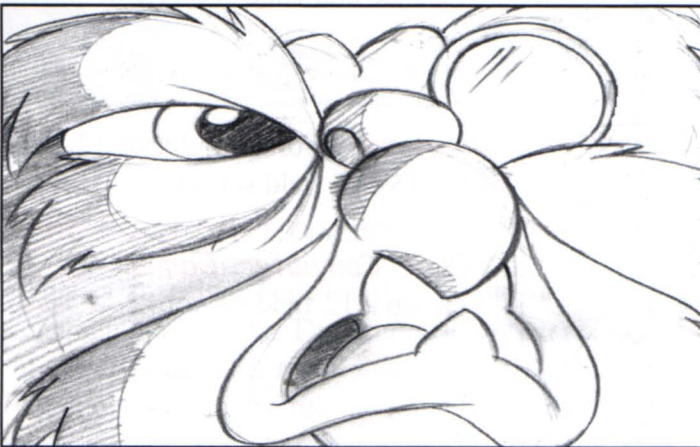

Feature: 12 field on a 15 / 16 field set-up or truck as low as 6 - 8 field on a 15 / 16 field set-up.

TV / Computer Games: 8 or 9 field on a 12 field set-up.

The Extreme Close-up

The Extreme Close-up is used to emphasise the eyes and general facial expression. It is used to show extreme emotion, such as anger, evil etc. This shot is very much concentrating on the inner thoughts and attitude of the character. Remember that these are emotions that people generally *don't* like to share and so we isolate them with the extreme shot. Emotions such as joy are better shared, and so we might use a medium or full shot instead. The extreme shot doesn't always have to be a face of course, it can be used for a close-up of a hand displaying a ring for example. The extreme close-up would usually have a colour-card behind it. This, as its name suggests, is merely a piece of background paper with a single colour matching the hook-up scenes behind. A full layout or background would be a complete waste.

Camera Transitions



Now that we have seen the types of shots available to us, we will look at the methods used for getting from one scene to another. These are called *Camera Transitions*.

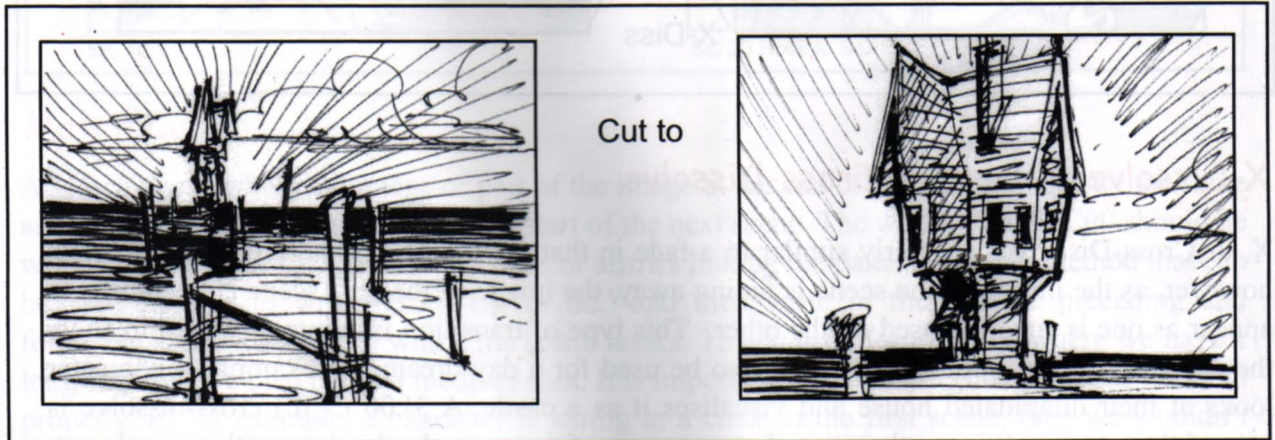

Cut to

This is the most common way of getting from one scene to another. Although it is categorised as a camera transition, it is in fact done by the editor. Here the scene quite simply 'jumps' from one image to another. Scenes can cut simply to change an angle, or can cut to an entirely different location with different characters.



Fade to / Fade from

This is an often used transition at the start or end of a sequence and can be used to indicate the end of a particular storyline. It's generally done 'To Black' or 'From Black'. Essentially what happens is that the aperture of the camera is slowly closed, causing the image to fade away to nothing. The length of the fade can last as long as you want it to last. However a 2'.00 (2 ft) fade is reasonably adequate.

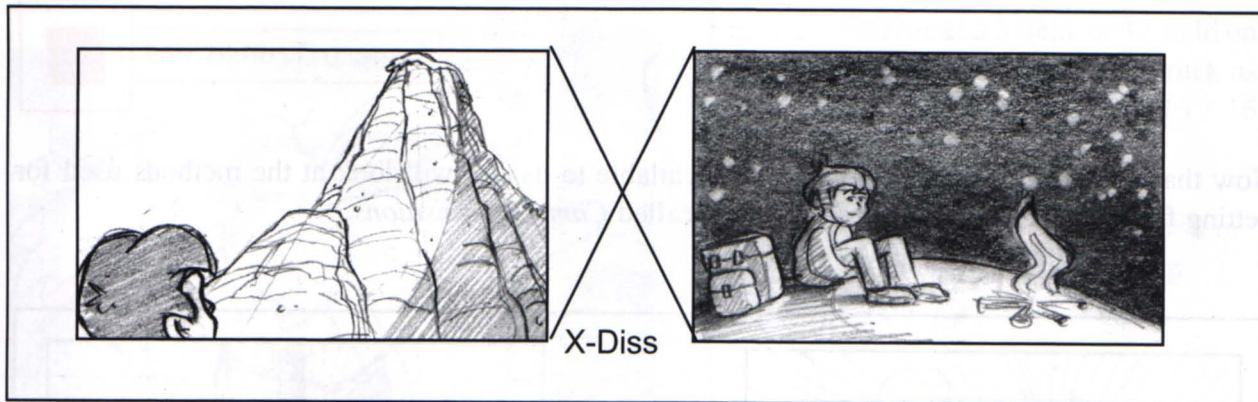

X-Dissolve, X-Diss. or Cross-Dissolve

X, or Cross-Dissolves are fairly similar to a fade in that the image gradually disappears. Here however, as the image of one scene is fading away, the image of the next scene is beginning to appear as one is superimposed on the other. This type of transition is commonly used to show the passage of time. Although it could also be used for a day-dream, for example, a character looks at their dilapidated house and visualises it as a castle. A 3'.00 (3 ft.) cross-dissolve is around the average. It is worth noting that a passage of time can also be done with a simple cut. If two characters are talking and one tells the other that he'll "see him tonight", then the scene can cut directly to that night. The character had already established that there was going to be a jump in time. Cross-dissolves at this point might be deemed to be 'overkill', that's *not* to say however that you cannot do both. The storyboard artist has to decide what will work best with each and every scene.

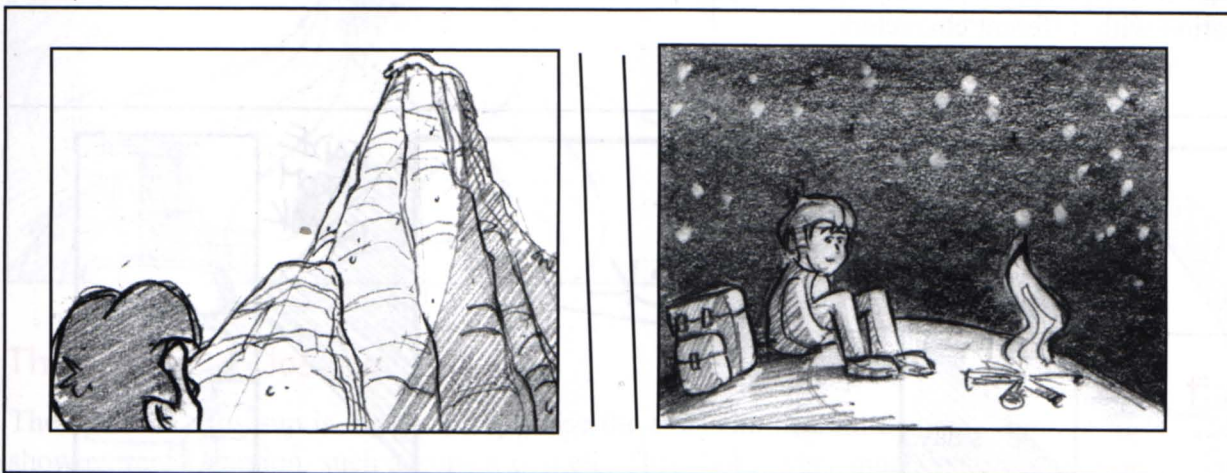

Ripple Dissolve

The ripple-dissolve is very similar to the cross-dissolve in that it is one image blending into the next. The difference here is that the scene appears to 'wobble' (remember Scooby-Do?). This transition is commonly used for dream sequences and can also be used for a passage of time.

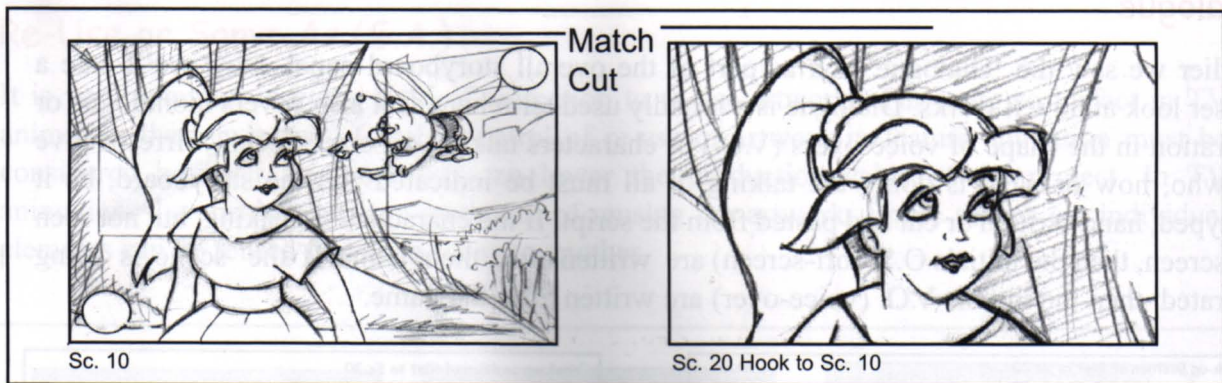

Match Cut

A *Match Cut* is where the image or part of the image at the end of one scene is exactly the same as the image or part of the image at the start of the next scene. The words 'Match Cut' should be written between the two panels with lines or arrows linking the panels. Another method that can be used here is to write 'Hook-Up to Sc.' and then write in the relative preceding and following scene numbers to which the scene hooks. This is used for example where we have a long shot and we then cut to a medium shot. It is important that all aspects of the scene hook up properly. If, for example, a character is sitting in a chair in the first scene, then we wouldn't expect to see him standing if we immediately cut to a medium shot in the next scene.

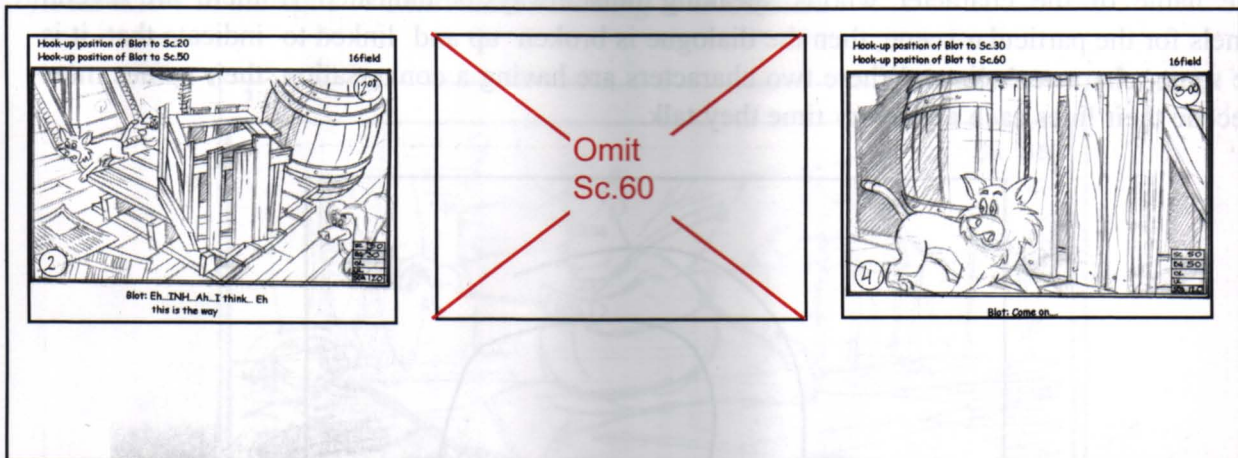

Omit

As sure as night follows day, one thing you can be certain of is that there are going to be changes to the storyboard during production. Usually it's the addition or omission of a scene. When a scene has been omitted, a large X is put through the panel (make it red if you want to). Quite often, the storyboard is amended in the production department, where they'll put a blank panel in with something like 'OMIT SC. 60', then re-copy the page and distribute it to each department. (This is why clips are used instead of staples). The scene numbers of the following scenes are not changed unless there have been quite a few changes with most of the scenes being omitted. The reason for this, is that these scenes may already be in production, and it would cause a logistical nightmare to try and chase up each one just to change the numbers, especially as they could be in another country.

Dialogue

Earlier we saw the 'Dialogue' box as part of the overall storyboard panel. Now we'll take a closer look at how it works. Dialogue is a broadly used term here as it also covers monologue or narration in the shape of voice-overs (V.O.) or characters talking off-screen (O.S.). Irrespective of who, how or what is doing the talking, it all must be indicated on the storyboard, be it re-typed, hand-written or cut and pasted from the script. If the character is speaking, but not seen on screen, then the initials O.S. (off-screen) are written after their name. If the scene is being narrated, then the initials V.O. (voice-over) are written after the name.

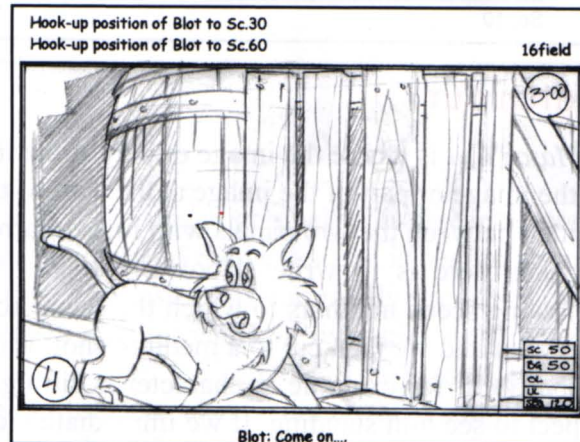
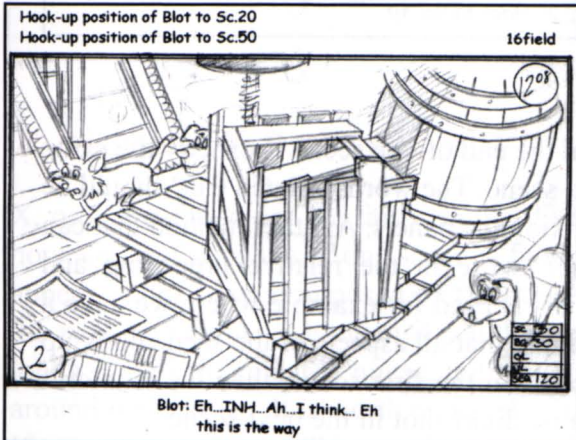

The name of the character who is speaking must always be indicated. If there are several panels for the particular scene, then the dialogue is broken up and linked to indicate that it is the same character's lines. Where two characters are having a conversation, their names must precede their lines each and every time they talk.

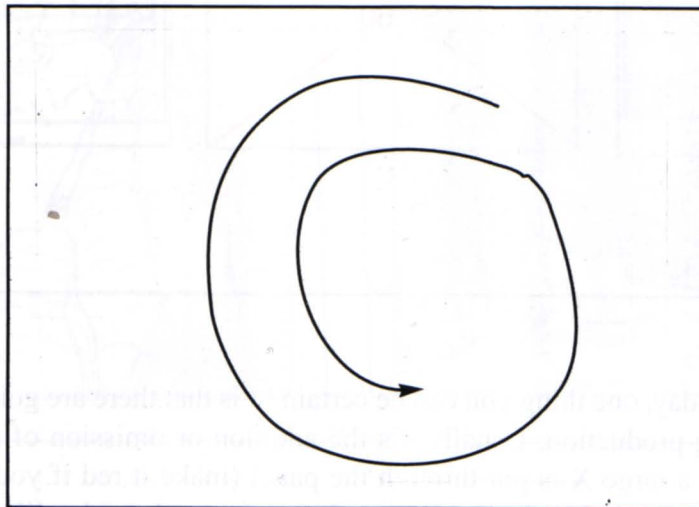

Wipe

A *Wipe* is in the fade category in that it is a way of finishing a scene. It can look like someone has pulled the image off the screen like a curtain, or it can spiral towards the centre of the screen, like in the old 'Batman' TV series. There are literally dozens of different types of wipes. The storyboard artist need only call up a wipe although they can call up the type if they wish. The director may make a decision on the specific type at a later stage.

Re-Use or Same-As (S.A.)

It is very common in every field of animation to re-use artwork. Far more so in fact in TV animation than in feature. Careful control of re-use of artwork in feature animation must be considered however, as too much can lower the production value of the project. In TV animation, the absolute most is made out of reusing the artwork. Entire scenes or individual elements can be reused from one scene to another.



Sc.10



Sc.20



Sc.30 Reuse BG from Sc.10

The most common reuse of artwork is the background, whether it's cutting to and from close-ups of characters in dialogue or characters returning to a location.

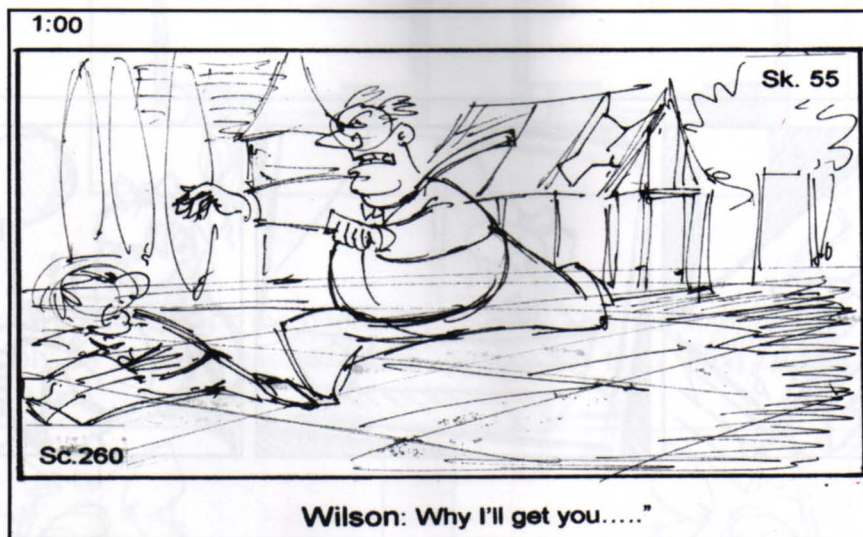

Any animation can be reused. However the most common reuses of animation are run and walk cycles. This information will be in the director's notes.

When artwork is being reused, the number of the scene from which it is being reused is always written in red on the storyboard, the dope sheet and on any production notes.

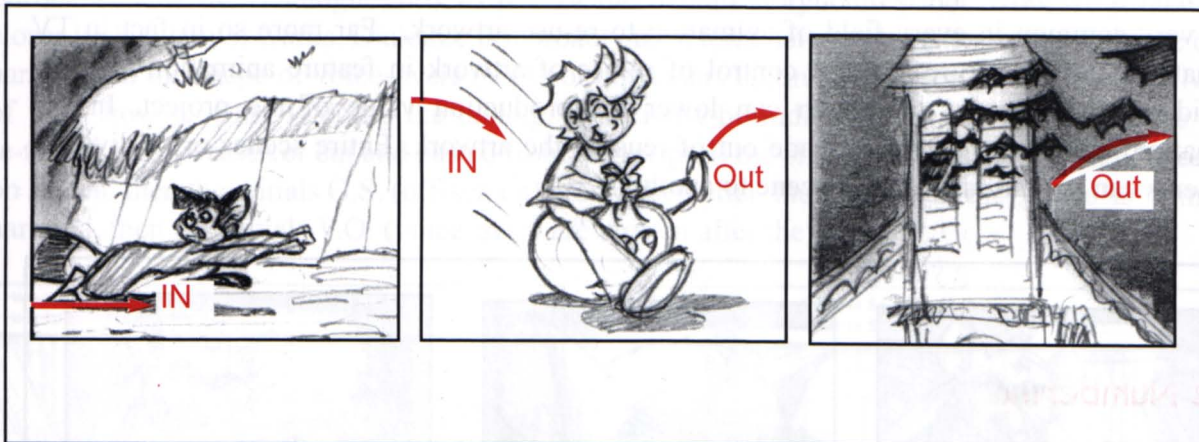

'In and Out'

Storyboard panels should indicate the *first*, *last* and possibly any *key poses in-between*. If an animator receives a storyboard and there is a character in the first panel, with no accompanying note, then he will animate the character from *that* position. The animator will assume that when we cut to the scene, the character is already on-screen in that position. If, however, the character walks on in the first panel, the storyboard artist should draw the character in the first panel, accompanied by a note and an arrow saying 'In'. If the character then walks off screen, then an arrow points to the edge of the panel with the word 'Out'.

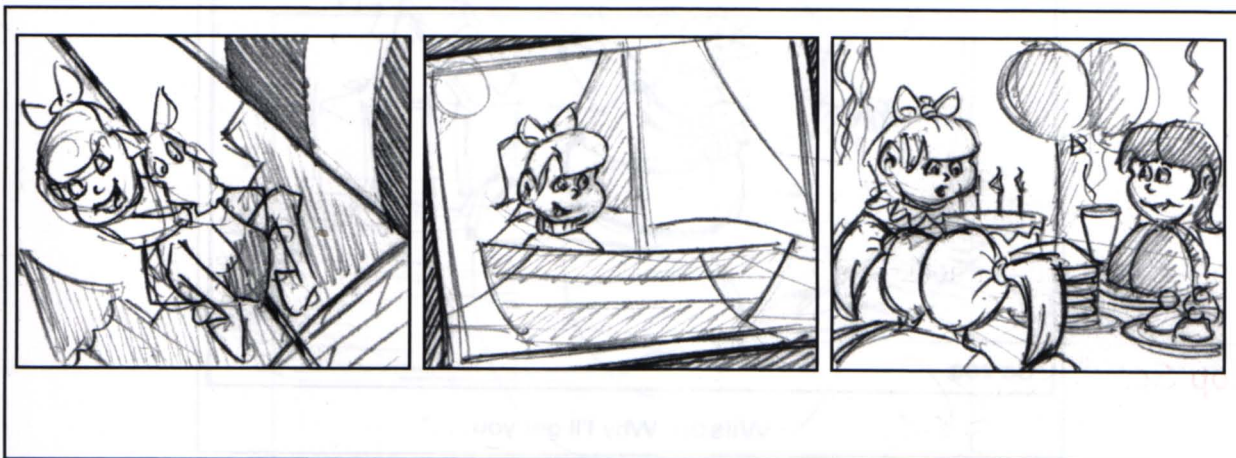

Montage

A montage is a series of shots of various activities that give a good overall impression very quickly and tells a large part of a story in a short period of time. Montages can be done with a series of cuts or cross-dissolves. These can be either various scenes or a series of photographs.

Additional Storyboard Notation.

The storyboard should be unambiguous. To this end, a few more notes are needed to ensure clarity for all of the other artists who will use it during production. I cannot emphasise enough the fact that storyboards are often done in one country and animated in another and communication may not always be possible when you need it. For example, the script may have been storyboarded by an English speaking storyboard artist living in America and animated by a French speaker working in France. Not only are there language barriers, but there's a huge time difference if they need to contact one another. Obviously there's no such thing as the perfect storyboard, but twenty minutes checking your notation can save hours or even days of someone trying to decipher and guess your work. Chances are they'll guess wrong.

Page Numbering

It goes without saying that each page of the storyboard should also be numbered in numerical order, 1 to whatever, or 1 of whatever. Additional pages can have a letter added if necessary, so a page added between page 1 and page 2 might be 1A etc.

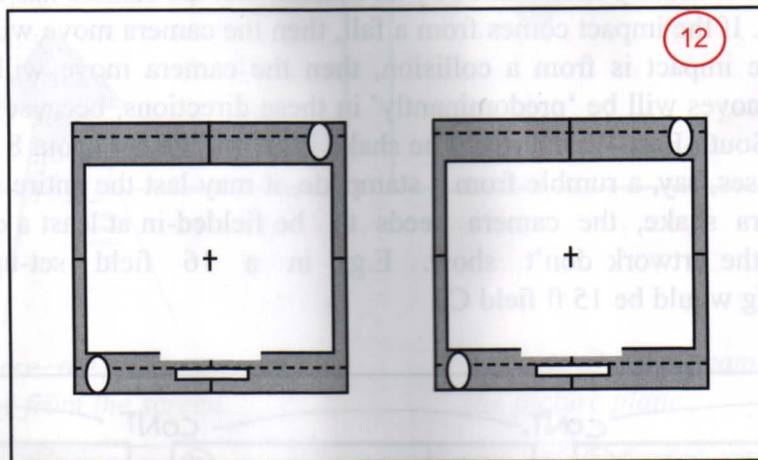

Flops

A scene can be switched to face the opposite direction. This might be employed in re-using animation or simply for hook-up reasons. In this instance, the term 'Flop' is used and not 'Flip'.

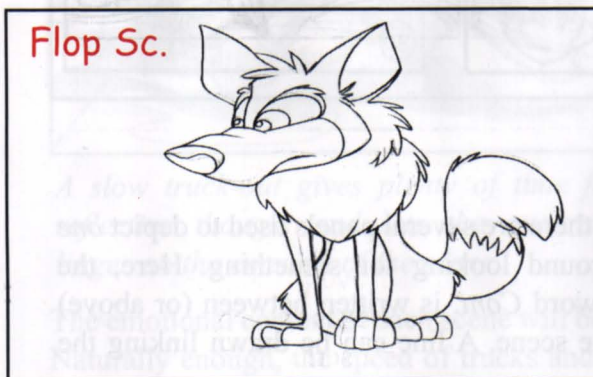

Original panel



Result

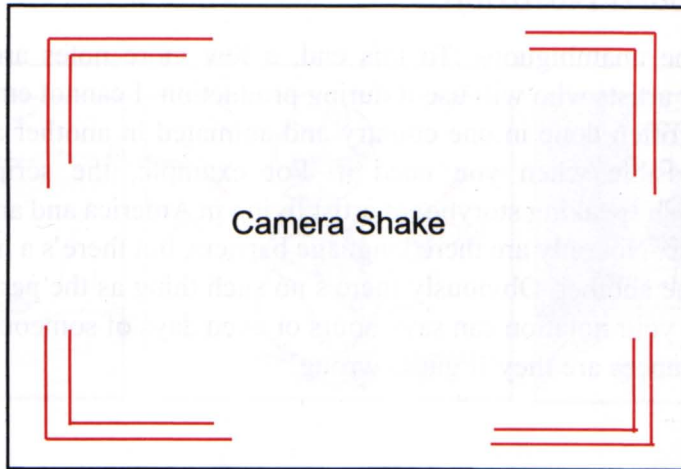

Camera Shakes or 'Jars'

If a character or object falls and hits the ground, or if a character or object collides with a wall, for example, the impact is usually exaggerated by an illusion that the camera has been shook with the force of the impact. If the impact comes from a fall, then the camera move will be predominantly North-South. If the impact is from a collision, then the camera move will be predominantly East-West. These moves will be 'predominantly' in these directions, because in fact, the camera will have a North-South-East-West move. The shake itself will be for about 8 to 16 frames for an impact. In some cases, say, a rumble from a stampede, it may last the entire scene. In a scene containing a camera shake, the camera needs to be fielded-in at least a quarter of a field so that the edges of the artwork don't show. E.g. in a 16 field set-up, the maximum permissible fielding would be 15 fl field C.

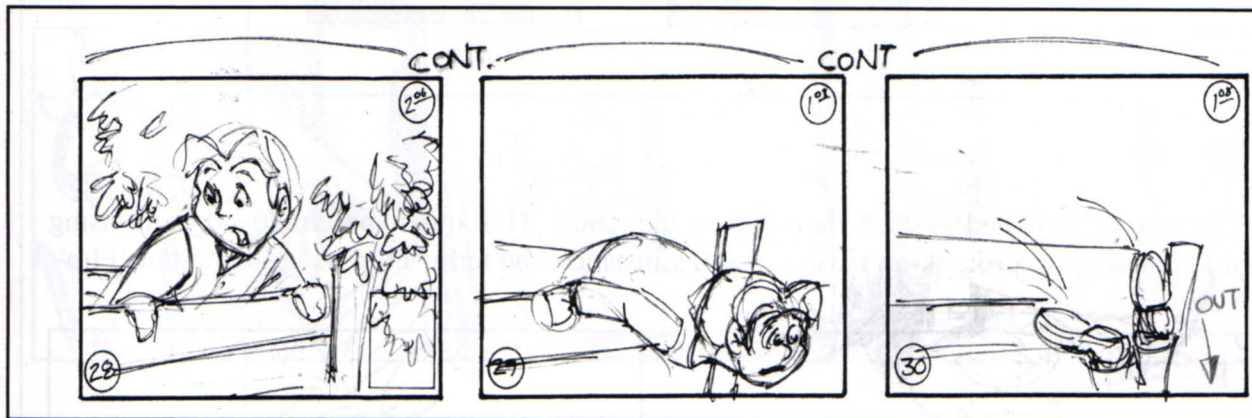

Cont.

Cont., or *Continue*, to give it its full name is used when there are several panels used to depict *one* scene. For instance, a character may be running around looking for something. Here, the storyboard artist may indicate several key poses. The word *Cont.* is written between (or above) each panel to show that it's a continuation of the same scene. A line can be drawn linking the words, but this isn't necessary.

Emotion

When an audience views a movie or TV show be it live action or animation, they want emotion as part of the package, both sensuous and dynamic, otherwise they might as well be watching a documentary. That's not to say that documentaries don't have emotion, they do, but on a different scale. The secret to effective use of emotion is in the timing. This is really down to the scriptwriter, the storyboard artist just has to make sure that the visuals are as strong.

Firstly a reminder that :

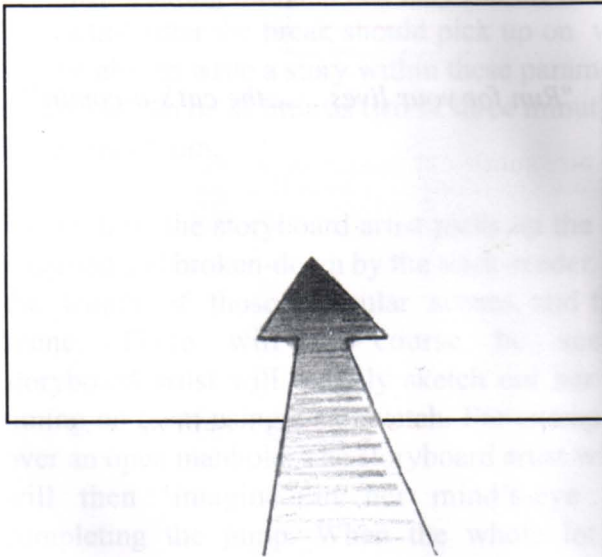

A truck is where the camera moves towards or away from the screen.

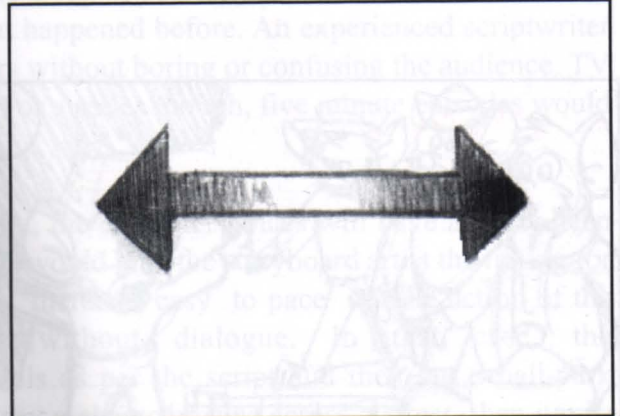

A pan is where the camera moves across the picture plane.



A slow truck-out gives plenty of time for reflective thought and lets the audience linger on the emotion of the scene.

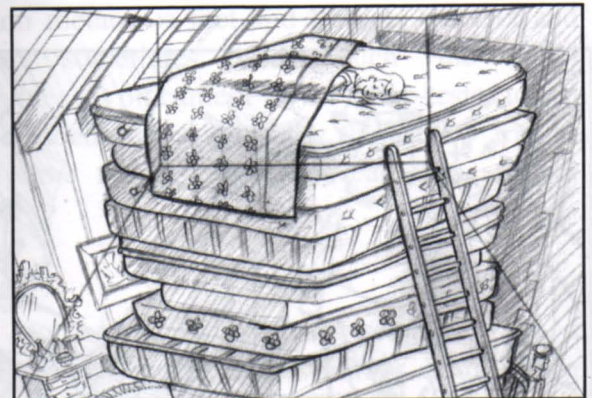

A slow truck-in gradually includes the audience into the scene without any feelings of intrusion.

The emotional content of each scene will be increased by creative use of fielding and use of trucks. Naturally enough, the speed of trucks and pans will greatly affect the scene. A fast truck-in will increase excitement, particularly when there's danger involved.

Usually in a scene, the action will either focus on one character at a time, or on a group of characters performing the same action, such as a song and dance routine. It would be unusual for several characters to be the centre of attention at the same time doing different things. Say for example, a group of mice are running about in a state of panic, because of an impending attack by a cat. The scene would work fine if each character who had a line of dialogue got to deliver it individually. If however, they were all shouting their lines at the same time then the audience may become confused. The characters can of course talk over one another in a more garbled way, providing that the audience doesn't lose out on a crucial part of the story by not hearing an important line being delivered.



"Run for your lives.....the cat's-a-comin'"



"We're all gonna die!"



Timing Storyboards

The average feature length animated movie lasts between one hour and ten minutes and one hour and twenty minutes. Computer games last as long as the player. An episode from a TV series lasts anything from 5 to 26 minutes. Commercial breaks bring this up to half an hour. In a TV series this has to be taken into account quite carefully. The last action before the break has to leave the audience wanting more. When they run off to make a cup of coffee, you will want them to return. The action after the break should pick up on what happened before. An experienced scriptwriter will be able to write a story within these parameters without boring or confusing the audience. TV animation can be as little as two or three minutes. For a series though, five minute episodes would be the minimum.

By the time the storyboard artist picks up the script, the character voices will have already been recorded and broken-down by the track-reader. This would give the storyboard artist the timing for the length of those particular scenes, and from there it's easy to pace out the action of the scene. There will of course be scenes without dialogue. In this case, the storyboard artist will roughly sketch out her panels as per the script and then put a ball-park timing on them using a stopwatch. For example, say a character runs across a street, then jumps over an open manhole. The storyboard artist will click the stopwatch on at the start of the run. She will then 'imagine' in her mind's-eye the character running down the street and completing the jump. When the whole lot is finished, she clicks the stopwatch off. The stopwatch will have registered the time in seconds. We know that there are 24 frames in a second and 16 frames in a foot. So all they you have to do is to multiply the total seconds by 24 to get the total frames, and divide the total frames by 16 to get the footage. Studios differ in the method used to measure footage. The most common method is feet and frames, but feet and inches, feet and seconds, and frames alone are sometimes used. When the initial timing has been put on the storyboard, it can then be shot on camera or on a line-tester to see if it works. If it is too fast, then a few frames can be added. If it is too slow, then a few frames can be omitted. The audience should have enough time to be able to read the action.

Timing Pans

If you intend adding a pan into your storyboard, it is advantageous to get a second body to operate the stop-watch. By forming your hands into L-frames or by using cut-off guides, you can move across the pan at the desired speed. The time-keeper will start the watch at the start of the pan and stop at the end of the pan. The most common problem with artists storyboarding for the first time, is that the storyboard moves too fast. A word of warning though, use a stop-watch and not a wrist watch. Half a second out on a wrist watch is 12 frames out in the action. The margin of error here is just too big.

Assignment

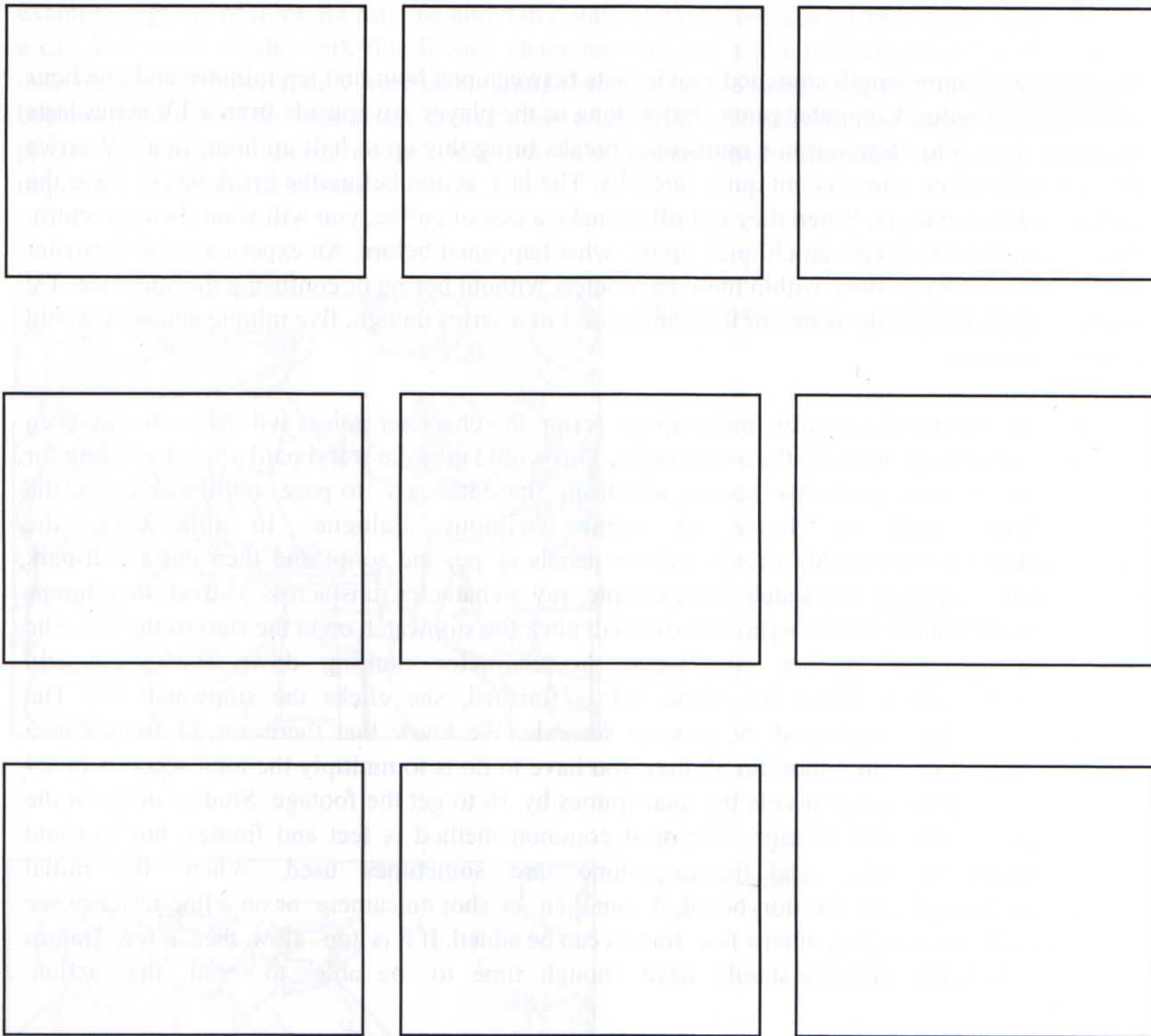

Tell a simple story using the panels above. Include all notation that you would expect to see on a storyboard.

Answer the following questions orally.

1. Discuss the process involved in the production of a storyboard.
2. List the information that you would put on a storyboard panel.
3. What is the difference between a camera shot type and a camera transition?

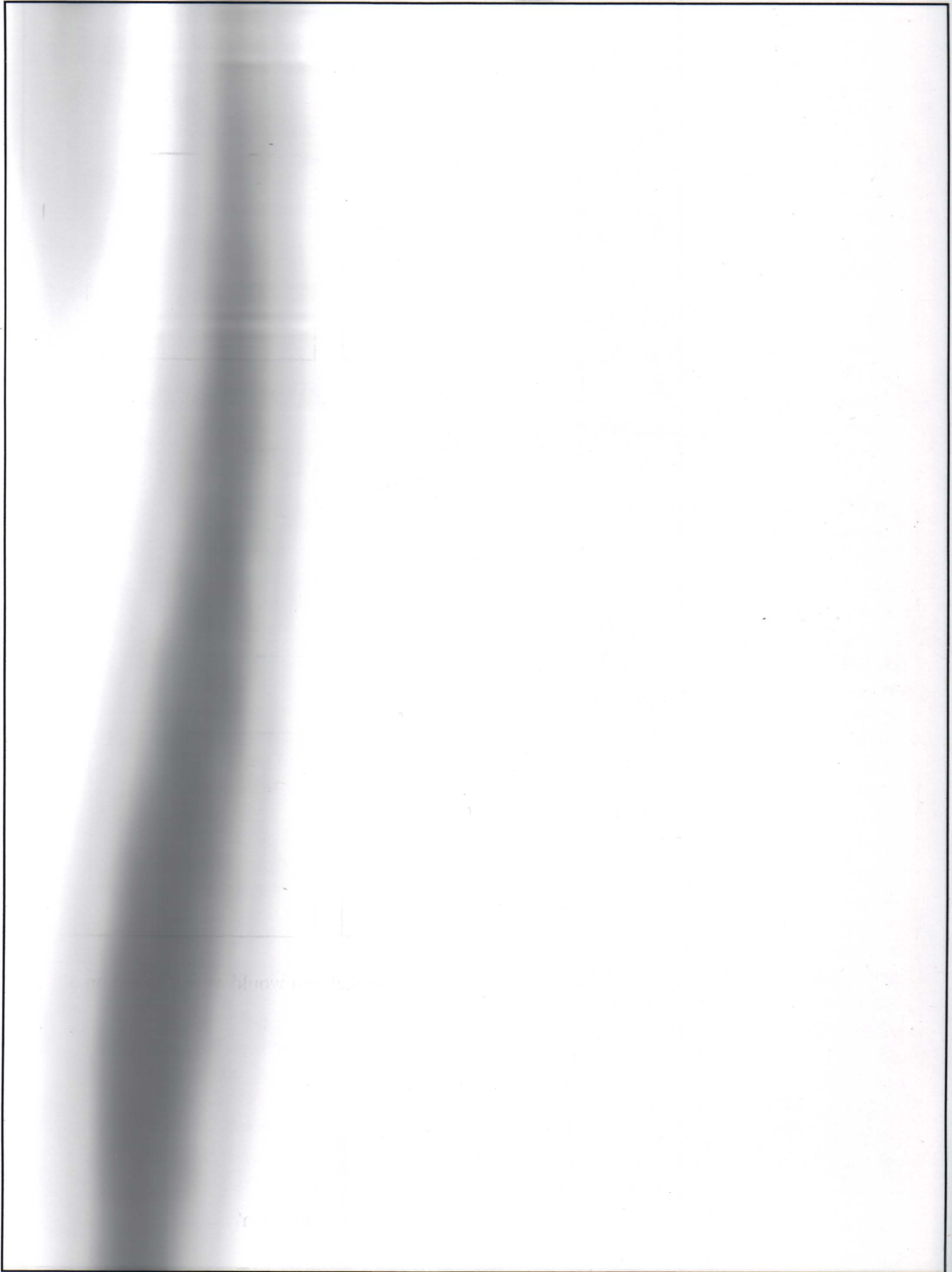

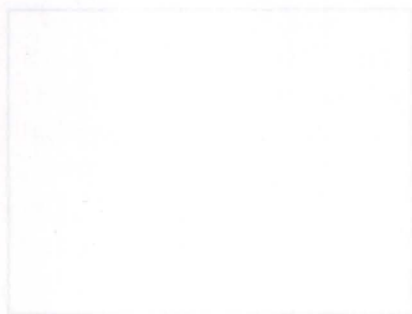

Tell a simple story using the panels above. Sketch your storyboard.

Answer the following questions orally.

1. Describe the process involved in the storyboard layout.
2. List the information that you would need to create a storyboard.
3. What is the difference between a storyboard and a script?



Index

Animating backgrounds 86
 Background
 How a layout becomes ... 126
 Bi-Pack 142
 Blue book 121
 Blue sketch 124
 Camera transitions 177
 Camera shakes 184
 Cut-to 177
 Dialogue 180
 Fades 177
 In and Out 182
 Matchcut 179
 Montage 182
 Omit 179
 Ripple dissolves 178
 Wipe 180
 X-dissolves 178
 Reuse 181
 Cartooning 121
 Characters in dialogue 99
 Character layout 104
 Character posing 106
 Cinematography 174
 Log / Establishing shot 174
 Full shot 175
 Medium 175
 Close-up 176
 Extreme close-up 176
 Circles 34
 4 point 34
 8 point 35
 Computers and Layout 122
 Conceptual drawings 73
 Cut-off guides 137
 Cylinders 36
 Equipment 14, 15
 Field size
 Graticule 136
 Set-up 139
 Floor plans 173
 Flow chart 15
 Focal points 70
 Multiple 71
 Four key points 71
 Framing 84
 Grids 24, 40
 Group shots 102
 Hills 47
 Jump cuts 104
 L-shaped frames 71
 Layout materials 12
 Layout folders 10
 Layout notes 109
 Level shots 120
 Lighting and Positioning
 Shadows 90
 Natural light 90
 Artificial light 90
 Match Lines 108
 Motif 127
 Multi-plane 144
 Overlays 61
 Page numbers 10
 Page 31
 Guard panels
 Horizontal 23
 Multi-panel 60
 Pan speed 43
 Paper 22
 Report 61
 Throat pins 187
 Title field 20
 Vertical 23
 Zip 64
 Perspective 17
 Axial 31
 Circles in perspective 74
 Forced 27
 One point 20
 Parallel lines 31
 Parallel planes 43
 Pictorial 31
 Three point 25
 Two point 23
 Positive and negative shapes 81
 Lines 102
 Drawing 113
 Lines 84
 Photo materials 29
 Labels 70
 L-shaped frames 71
 Layout materials 12
 Layout folders 10
 Layout notes 109
 Level shots 120
 Lighting and Positioning
 Shadows 90
 Natural light 90
 Artificial light 90
 Match Lines 108
 Motif 127
 Multi-plane 144
 Overlays 61
 Page numbers 10
 Page 31
 Guard panels
 Horizontal 23
 Multi-panel 60
 Pan speed 43
 Paper 22
 Report 61
 Throat pins 187
 Title field 20
 Vertical 23
 Zip 64
 Perspective 17
 Axial 31
 Circles in perspective 74
 Forced 27
 One point 20
 Parallel lines 31
 Parallel planes 43
 Pictorial 31
 Three point 25
 Two point 23



- Animating backgrounds 80
- Background
 - How a layout becomes ...*126
- Bi-Pack 145
- Blue book 151
- Blue sketch 124
- Camera transitions 177
 - Camera shakes* 184
 - Cut-to* 177
 - Dialogue*180
 - Fades* 177
 - In and Out* 182
 - Matchcut* 179
 - Montage* 182
 - Omit* 179
 - Ripple dissolves* 178
 - Wipe* 180
 - X-dissolves* 178
 - Reuse* 181
- Cartooning 121
- Characters in dialogue 99
- Character Layout 104
- Character Posing 106
- Cinematography 174
 - Long / Establishing shot 174
 - Full shot 175
 - Medium 175
 - Close-up 176
 - Extreme close-up 176
- Circles 34
 - 4 point* 34
 - 8 point* 35
- Computers and Layout 155
- Conceptual drawings 73
- Cut-off guides 137
- Cylinders 36
- Equipment 14, 15
- Field size
 - Graticule* 136
 - Set-up* 139
- Floor plans 173
- Flow chart 15
- Focal points 70
 - Multiple* 74
- Four key points 71
- Framing 83
- Grids 24, 40
- Group shots 102
- Hills 47
- Jump cuts 101
- L-shaped frames 73
- Layout artists role 12
- Layout folder 146
- Layout notation 109
 - Level sketch* 150
- Lighting and Rendering 87
 - Shadows* 90
 - Natural light* 90
 - Artificial light* 90
- Match Lines 108
- Motif 127
- Multi-plane 144
- Overlays 61
- Page numbering 183
- Pans 51
 - Curved pans* 63
 - Diagonals* 57
 - Horizontal* 55
 - Multi-position* 60
 - Pan speed* 143
 - Paper* 52
 - Repeat* 61
 - Timing pans* 187
 - Tilt-field* 56
 - Vertical* 53
 - Zip* 64
- Perspective 17
 - Aerial* 31
 - Circles in perspective* 34
 - Forced* 27
 - One point* 20
 - Parallel rule* 21
 - Parallel objects* 43
 - Pictorial* 31
 - Three point* 25
 - Two point* 23
- Positive and Negative shapes 81
- Reg. lines 108
- Rendering 113
- Rest areas 84
- Rotation graticule 59
- Rule of thirds 70
- Scale 32
- Scene planning 135
- Scene types 174
- Silhouette 82
- Spatial relationships 100
- Special effects 122
- Staging 95
- Stairs
 - Spiral* 38
 - Standard* 41
- Stock artwork 146
- Storyboard artists role 12
- Storyboarding 161
 - Computer* 164
 - Continuation* 184
 - Emotion* 185
 - Feature* 163
 - Flop scenes* 183
 - Notation* 183
 - Numbering* 183
 - Script* 165,6
 - Styles* 172
 - Story premise* 164
 - Timing* 187
 - Treatment* 165
 - TV* 163
- Techniques and motifs 113
 - Brush pen* 118
 - Charcoal* 120
 - Graphite powder* 119
 - Ink / marker* 116
 - Lead pencil* 114
- Tiled floors 45
- Thumbnail drawings 72
- View finders 73

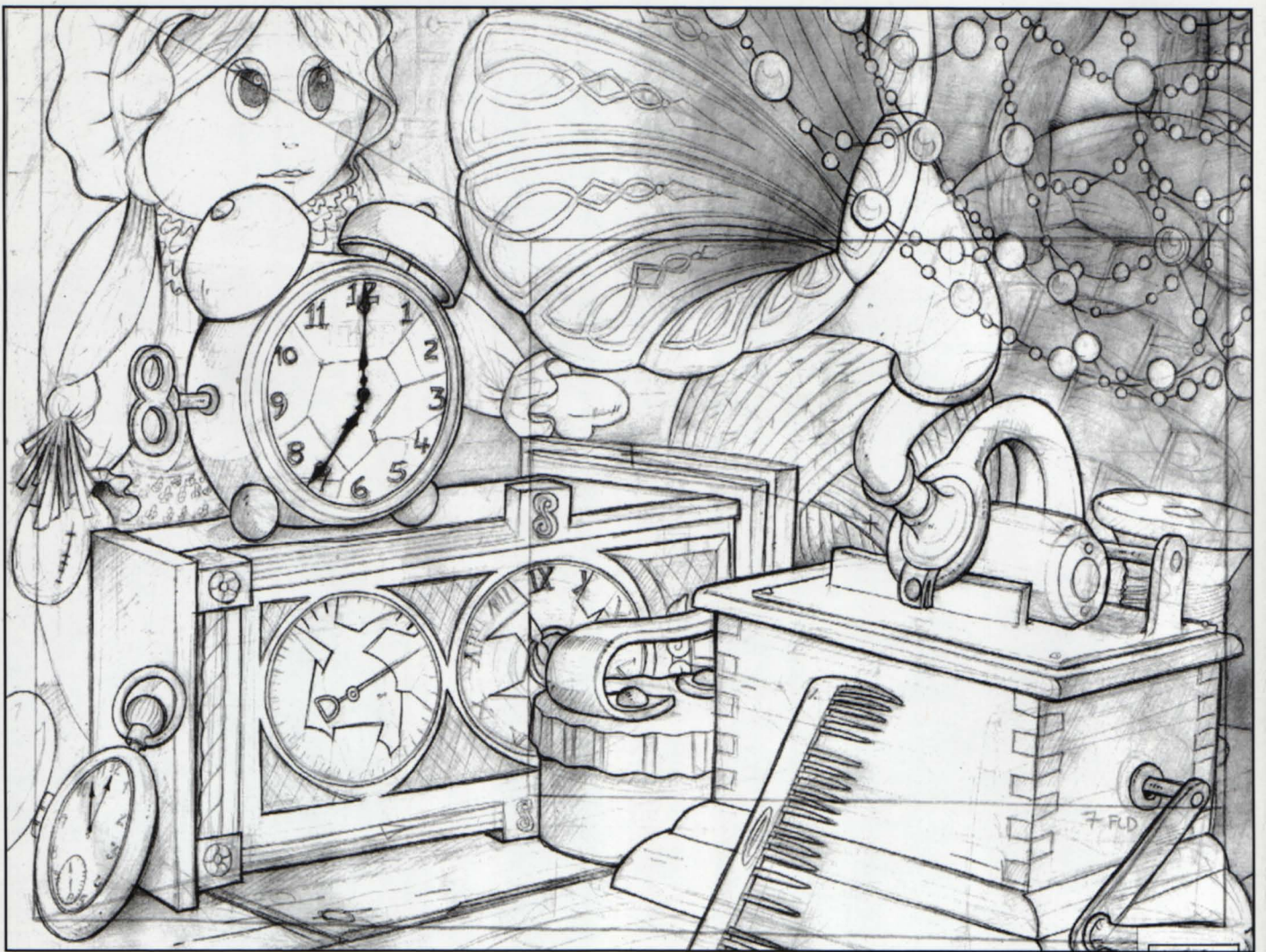

The Art of Layout and Storyboarding is designed to guide the beginner layout artist to become proficient in one of the most exciting areas of animation.

The book uses easy to understand methods and techniques, and covers layout for feature, TV and computer game animation.

The language used is simple, and doesn't assume that the reader has any previous experience in the field of animation.

The Art of Layout and Storyboarding is the perfect textbook for teachers, and will also serve graphic artists, illustrators and animation artists seeking a new discipline.

The book contains over four hundred and twenty images and reveals the secrets to help the beginner to achieve the same results.

ISBN 0-9535732-0-6