

# PV226: Process Mining seminar

---

**Martin Macák**

[macak@mail.muni.cz](mailto:macak@mail.muni.cz)

September 26, 2019

LAB OF SOFTWARE ARCHITECTURES  
AND INFORMATION SYSTEMS

FACULTY OF INFORMATICS  
MASARYK UNIVERSITY, BRNO



# Outline

---

1. Basic overview of Process Mining
2. Course introduction

# Process mining

---

- Process-centric data analysis
- What really happened in the past?
- Why did it happen?
- What is likely to happen in the future?
- When and why do people deviate?
- How to redesign a process to improve it?
- ...

# Process mining

---

- Typically working with event logs which represent processes
- These logs have to contain cases (sequences of events)

```
Martin;order_start  
Martin;select_hamburger  
Martin;choose_card_payment  
Martin;confirm_order  
Martin;order_end
```

# Process mining

---

- Each event has:
  - caseId
  - activity
  - timestamp (optional)
  - resource (optional)
  - other data (optional)

```
1;order_accept;Dec 2, 2017 10:30:58 AM;Peter;21  
1;order_cooked;Dec 2, 2017 10:39:24 AM;Victor;24  
1;order_delivered;Dec 2, 2017 11:12:37 AM;Emma;19
```

# Process mining

---

- Sometimes, the mapping is not clear

```
1;order_accept;Dec 2, 2017 10:30:58 AM;Peter;21
1;order_cooked;Dec 2, 2017 10:39:24 AM;Victor;24
2;order_accept;Dec 2, 2017 10:40:21 AM;Peter;21
3;order_accept;Dec 2, 2017 10:42:19 AM;Greg;34
1;order_delivered;Dec 2, 2017 11:12:37 AM;Emma;19
2;order_cooked;Dec 2, 2017 11:17:04 AM;Victor;24
2;order_delivered;Dec 2, 2017 11:24:00 AM;Peter;21
```

- For example, the name of the worker can be:
  - resource
  - activity
  - caseId

# Analysis of the past

---

## 1. Process discovery techniques

- From the event log, we create a model that represents how the process was executed in reality
- Model can be represented as a petri net, activity diagram, BPMN diagram, ...

## 2. Conformance checking techniques

- We can check the deviations from the created model in historic data

# Process discovery

---

```
1;order_accept;Dec 2, 2017 10:30:58 AM;Peter;21
1;order_cooked;Dec 2, 2017 10:39:24 AM;Victor;24
2;order_accept;Dec 2, 2017 10:40:21 AM;Peter;21
3;order_accept;Dec 2, 2017 10:42:19 AM;Greg;34
1;order_delivered;Dec 2, 2017 11:12:37 AM;Emma;19
2;order_cooked;Dec 2, 2017 11:17:04 AM;Victor;24
2;order_delivered;Dec 2, 2017 11:24:00 AM;Peter;21
```

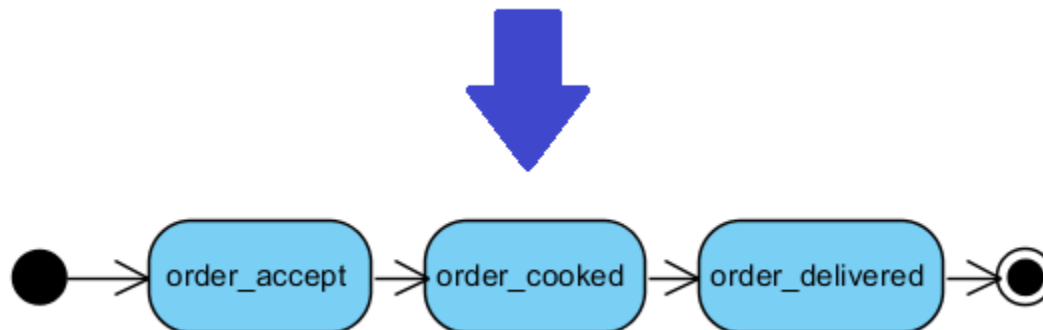



# Process discovery challenges

---

- Concurrency
- Loops
- Noisy behavior
- No negative examples in the log
- Too many allowed behaviors

# Process discovery activities

---

- Explore processes at run-time
- Discover process models
- Compare the model of desired behavior with the model of reality
- Check the deviations in historic data
- Promote the model that shows the desired behavior

# Adding additional perspectives

---

- Control flow is not the only perspective
- We can enhance the existing process models with:
  - Social network analysis
  - Organizational structures
  - Resource behavior analysis
  - Time perspective
  - Decision points mining
  - ...

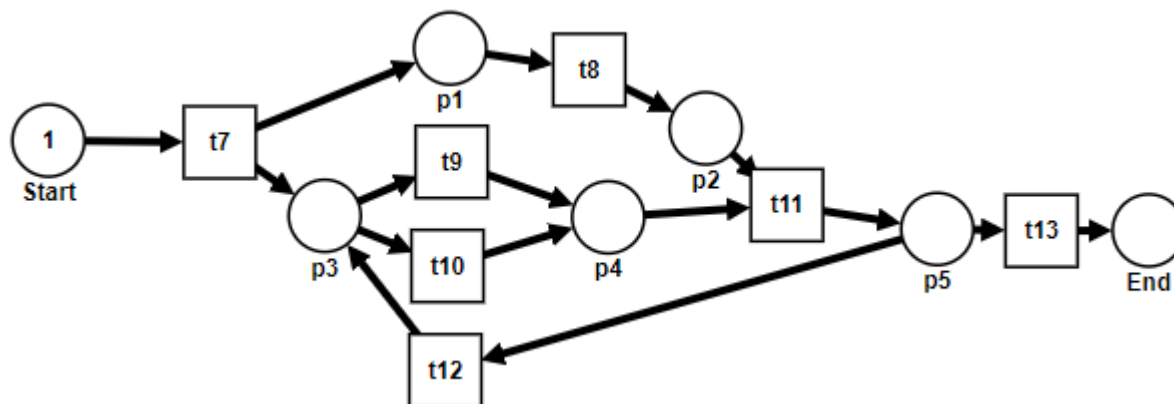

# Additional perspectives

- We can add many others
- We can combine them to the integrated model
- Our model is enhanced, we might get better results

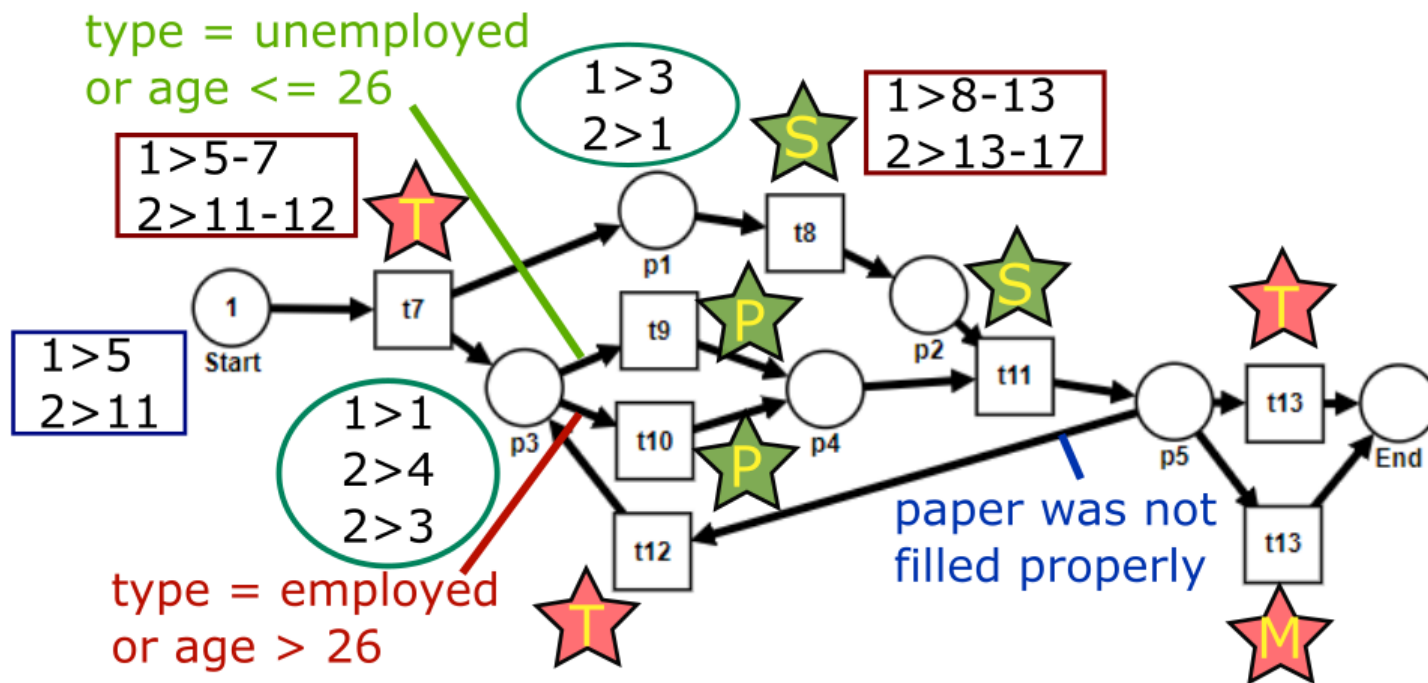

# Conformance checking

- We can use the existing model to identify deviations in the behavior from logs

```
1;order_accept;  
1;order_nofitication;  
1;order_delivered;  
1;order_cooked;  
//NOK
```

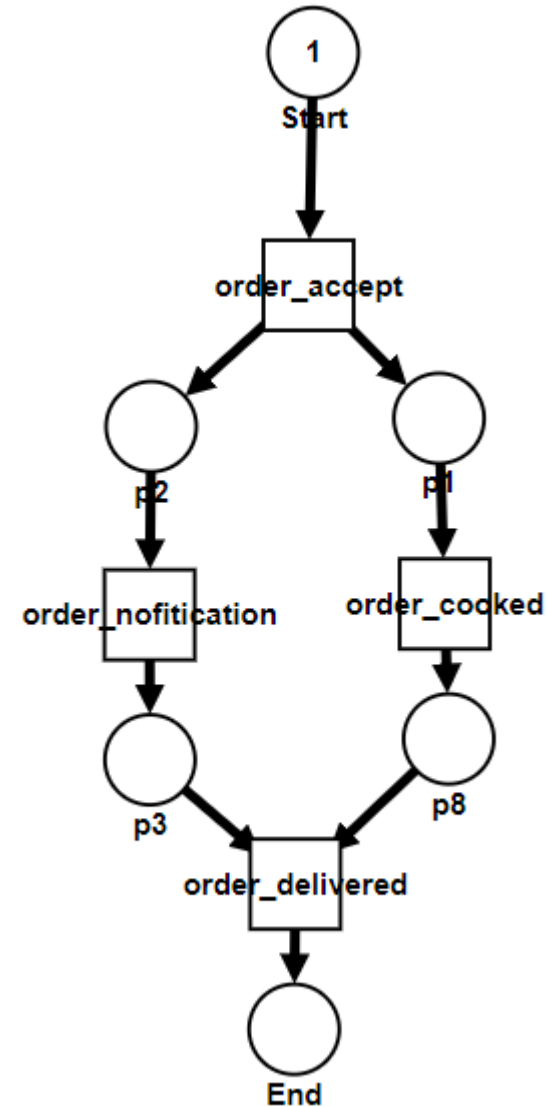

# Analysis of the present

---

- Also called operational support
- We use our model to analyze running cases
- We can:
  - Detect deviations in real-time data using the model of the desired behavior
  - Do real-time predictions (prob. of success, remaining time,...)
  - Make recommendations

# Operational support: Detect deviations

---

- We consider only the partial trace of a particular case
- We want immediate response when the deviation occurs
  - a) Token-based replay
  - b) Business rules

# Detect deviations: Token-based replay

- Check the conformance with the model

```
1;order_accept; //OK
1;order_nofitication; //OK
1;order_cooked; //OK
1;order_delivered; //OK
```

```
5;order_accept; //OK
5;order_nofitication; //OK
5;order_delivered; //NOK
```

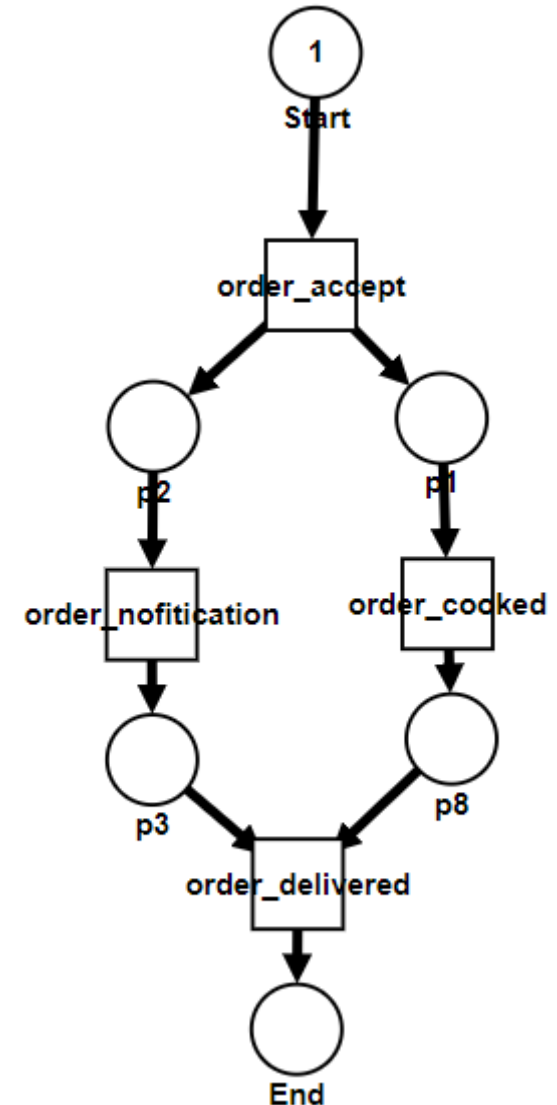



# Detect deviations: Business rules

- Specific rules we want to follow
- To define them, we can use *Declare*
  - Constraint-based workflow language that uses graphical notations and semantics based on Linear Temporal Logic
- Example:
  - **a** and **b** cannot happen in the same case
  - **a** cannot happen before **c** has happened
  - every **d** have to be eventually followed by **a** or **b**

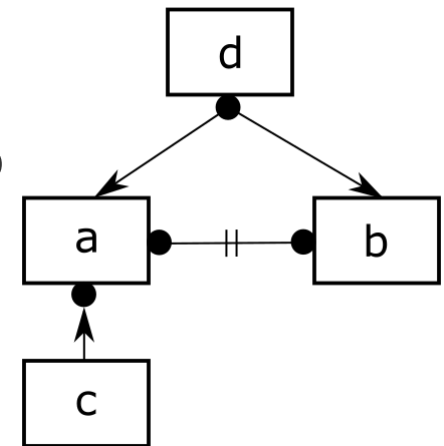
$$\begin{aligned} & ! ( (\blacklozenge a) \wedge (\blacklozenge b) ) \\ & (!a) \bar{W} c \\ & \square (d \Rightarrow (\blacklozenge (a \vee b))) \end{aligned}$$

# Operational support: Predict & Recommend

---

- We can apply data mining techniques (supervised learning, ...)
- Examples of predictions:
  - Total cost of the current case
  - Total service time for the current case
  - Probability of meeting the deadline
  - Remaining flow time
- Examples of recommendations:
  - Minimize the total costs
  - Maximize the number of accepted cases
  - Minimize resource usage
  - Minimize the remaining flow time







# PV226 Course information

---

- e-learning (recommended: 2. – 7. week)
- <https://www.coursera.org/learn/process-mining>



You passed this course! Your grade is 100.00%.

Item	Status	Due	Weight	Grade
 <b>Quiz 1</b> Quiz	Passed	Jul 15 8:59 AM CEST	10%	<b>100%</b>
 <b>Quiz 2</b> Quiz	Passed	Jul 22 8:59 AM CEST	10%	<b>100%</b>
 <b>Quiz 3</b> Quiz	Passed	Jul 29 8:59 AM CEST	10%	<b>100%</b>
 <b>Quiz 4</b> Quiz	Passed	Aug 5 8:59 AM CEST	10%	<b>100%</b>
 <b>Quiz 5</b> Quiz	Passed	Aug 12 8:59 AM CEST	10%	<b>100%</b>
 <b>Quiz 6</b> Quiz	Passed	Aug 19 8:59 AM CEST	10%	<b>100%</b>
 <b>Final Quiz</b> Quiz	Passed	Aug 19 8:59 AM CEST	40%	<b>100%</b>

# PV226 Course information

---

- Project
  - Application of Process Mining to a problem
  - You can come up with your own topic, set your own difficulty
  - You can work in pairs
  - We will have a meeting (**24.10.?**) where we will discuss your topics
  - **5.12.** – presentation of your work in Lasaris seminar (A319)
  - Optional consultations of your project / email communication 😊
- Examples of project types:
  - Process discovery in tool Disco (<https://fluxicon.com/disco/>)
  - Process analysis in tool ProM (<http://www.promtools.org/>)
  - Process analysis using Python (<https://github.com/pm4py/pm4py-source>)
  - Survey research paper about the specific usage of Process Mining

# Questions?

---



# Sources

---

- Presentation based on the book **Process Mining: Data Science in Action**
- <https://www.springer.com/gp/book/9783662498507>
- Use school VPN and you can download it! 😊

