



# Chapter 2: Static Routing

## Instructor Materials

CCNA Routing and Switching

Routing and Switching Essentials v6.0



# Chapter 2: Static Routing

**Routing and Switching Essentials 6.0  
Planning Guide**

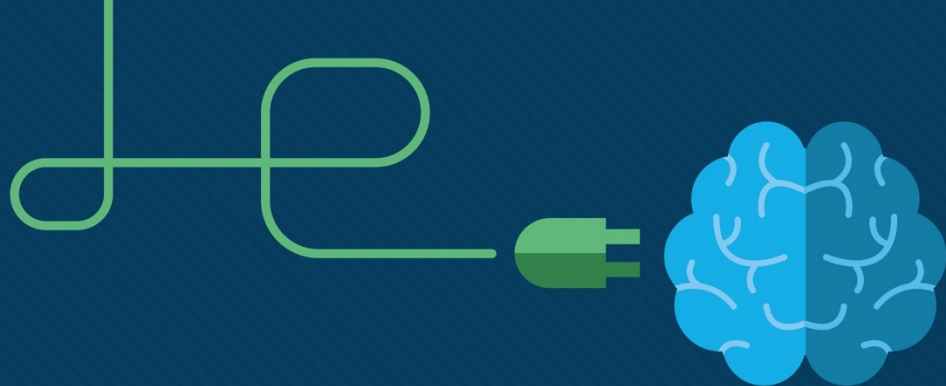

# Chapter 2: Static Routing

CCNA Routing and Switching

Routing and Switching Essentials v6.0



# Chapter 2 - Sections & Objectives

## ▪ 2.1 Static Routing Advantages

- Explain how static routes are implemented in a small to medium-sized business network.
- Explain advantages and disadvantages of static routing.
- Explain the purpose of different types of static routes.

## ▪ 2.2 Configure Static and Default Routes

- Configure static routes to enable connectivity in a small to medium-sized business network.
- Configure IPv4 static routes by specifying a next-hop address.
- Configure an IPv4 default route.
- Configure IPv6 static routes by specifying a next-hop address.
- Configure an IPv6 default route.
- Configure a floating static route to provide a backup connection.
- Configure IPv4 and IPv6 static host routes that direct traffic to a specific host.

# Chapter 2 - Sections & Objectives (Cont.)

## ▪ 2.3 Troubleshoot Static and Default Routes

- Given an IP addressing scheme, configure IP address parameters on devices to provide end-to-end connectivity in a small to medium-sized business network.
- Explain how a router processes packets when a static route is configured.
- Troubleshoot common static and default route configuration issues.

# 2.1 Implement Static Routes

## Reach Remote Networks

- A router learns about remote networks in two ways:
  - Manually entered into the route table using static routes
    - Static routes are not automatically updated and must be reconfigured when topology changes
  - Dynamically (Automatically) learned using a routing protocol

### Static and Default Routes

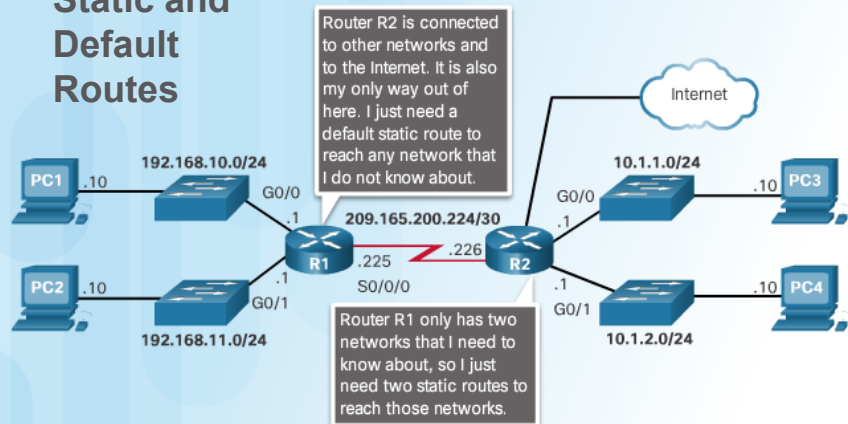

### Dynamic Routing

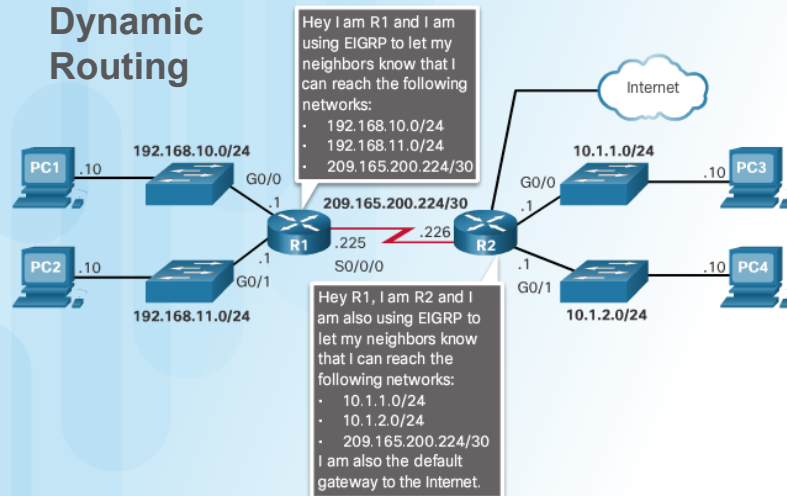

## Why Use Static Routing?

### Dynamic versus Static Routing

	Dynamic Routing	Static Routing
Configuration Complexity	Generally independent of the network size	Increases with network size
Topology Changes	Automatically adapts to topology changes	Administrator intervention required
Scaling	Suitable for simple and complex topologies	Suitable for simple topologies
Security	Less secure	More secure
Resource Usage	Uses CPU, memory, link bandwidth	No extra resources needed
Predictability	Route depends on the current topology	Route to destination is always the same



# When to Use Static Routes

Three uses for static routes:

- Smaller networks that are not expected to grow
- Routing to and from stub networks
  - Stub network accessed by a single route and has one neighbor
  - 172.16.3.0 is a stub network
- A single default route to represent a path to any network not found in the routing table
  - Use default route on R1 to point to R2 for all other networks

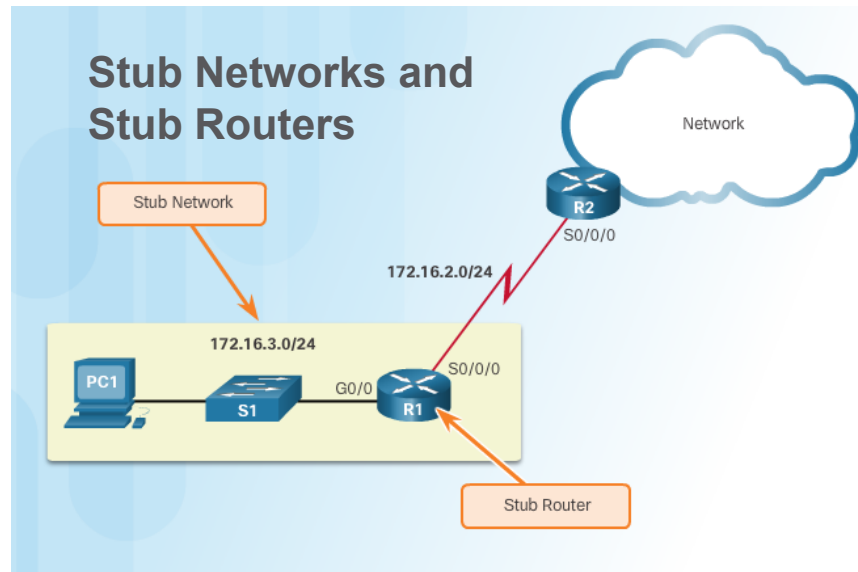

# Static Route Applications

### Use Static Routes To:

- Connect to a specific network
- Connect a stub router
- Summarize routing table entries which reduces size of routing advertisements
- Create a backup route in case a primary route link fails

# Types of Static Routes

## Standard Static Route

- R2 configured with a static route to reach the stub network 172.16.3.0/24

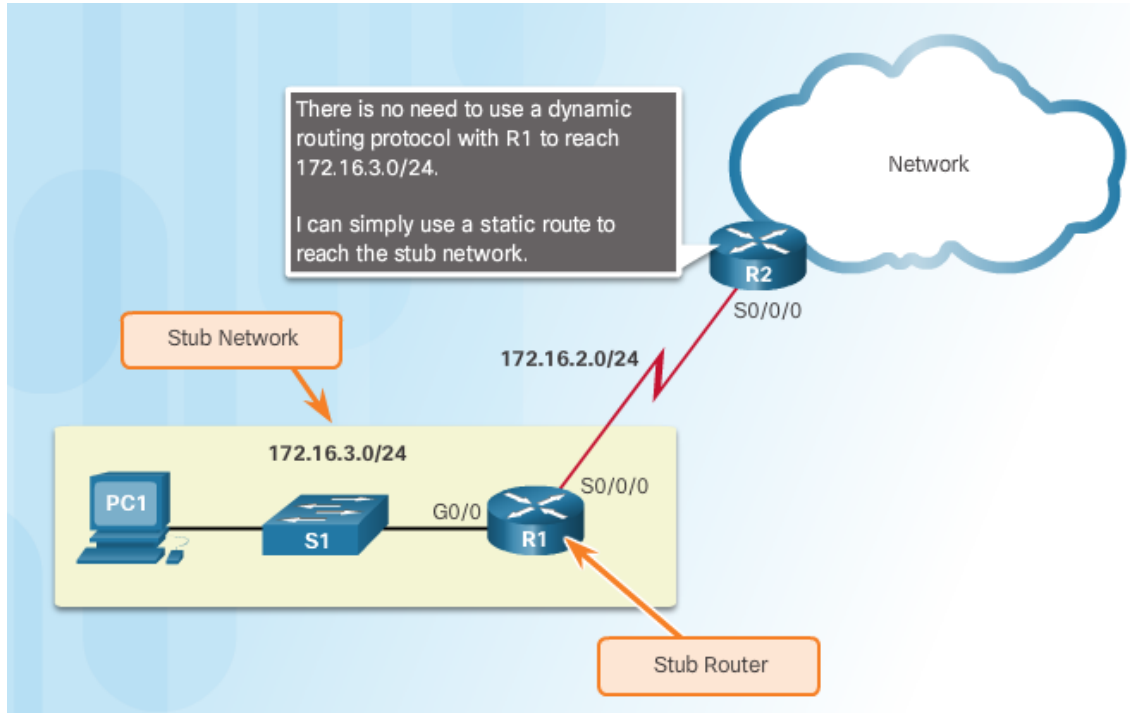

# Types of Static Routes

## Default Static Route

- Default route matches all packets and is used when a packet does not match a specific route in the routing table
- Can be dynamically learned or statically configured
- Default Static route uses 0.0.0.0/0 as the destination IPv4 address
- Creates a Gateway of Last Resort
- Common use is when connecting a company's edge router to the ISP network
- Router has only one router to which it is connected

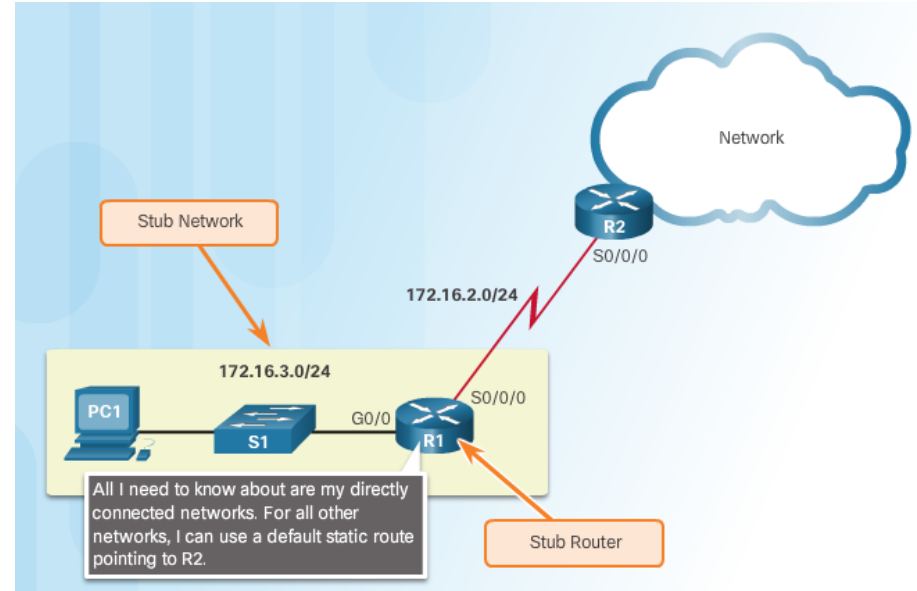

# Summary Static Route

- Multiple static routes can be summarized into a single network address
  - Destination networks must be contiguous
  - Multiple static routes must use the same exit interface or next hop
  - In figure, four networks is summarized into one summary static route

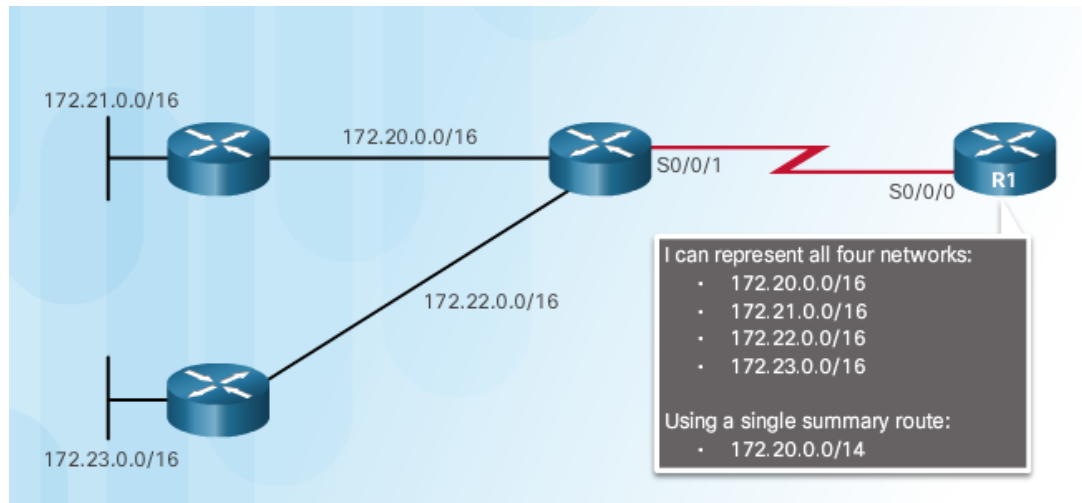

# Floating Static Route

- Static routes that are used to provide a backup path
- Used when primary route is not available
- Configured with a higher administrative distance (trustworthiness) than the primary route
- Example: EIGRP administrative distance equals 90. A floating static route with an AD of 91 or higher would serve as backup route and will be used if EIGRP route goes down.

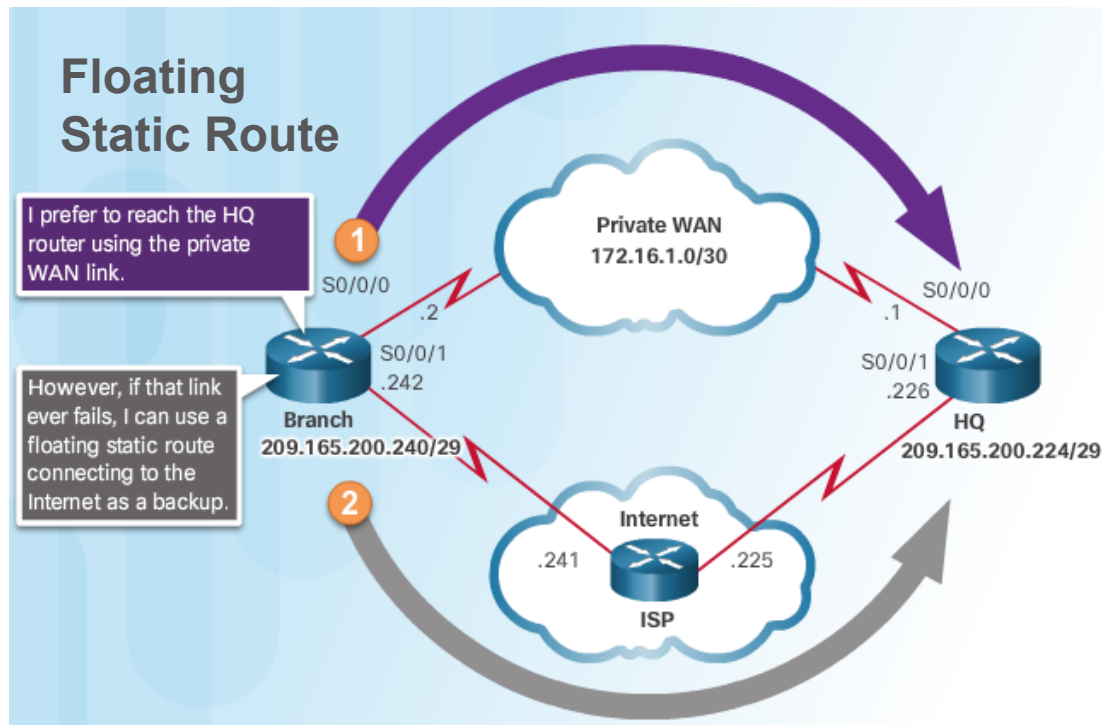

# 2.2 Configure Static and Default Routes

# Configure IPv4 Static Routes

## ip route Command

### ip route Command Syntax

```
Router(config)# ip route network-address subnet-mask (ip-address | exit-intf)
```

Parameter	Description
network-address	Destination network address of the remote network to be added to the routing table
subnet-mask	<ul style="list-style-type: none"><li>Subnet mask of the remote network to be added to the routing table.</li><li>The subnet mask can be modified to summarize a group of networks.</li></ul>
ip-address	<ul style="list-style-type: none"><li>Commonly referred to as the next-hop router's IP address.</li><li>Typically used when connecting to a broadcast media (i.e., Ethernet).</li><li>Commonly creates a recursive lookup</li></ul>
exit-intf	<ul style="list-style-type: none"><li>Use the outgoing interface to forward packets to the destination network.</li><li>Also referred to as a directly attached static route.</li><li>Typically used when connecting in a point-to-point configuration.</li></ul>
distance	<ul style="list-style-type: none"><li>(Optional) Configures an administrative distance.</li><li>Typically used to configure a floating static route.</li></ul>



# Configure IPv4 Static Routes Next-Hop Options

- In this example, each router only has entries for directly connected network

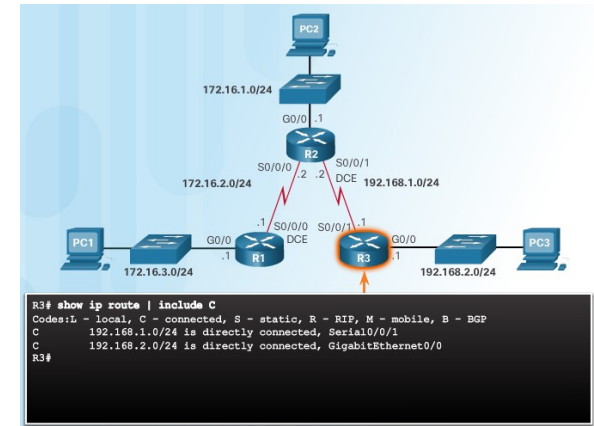
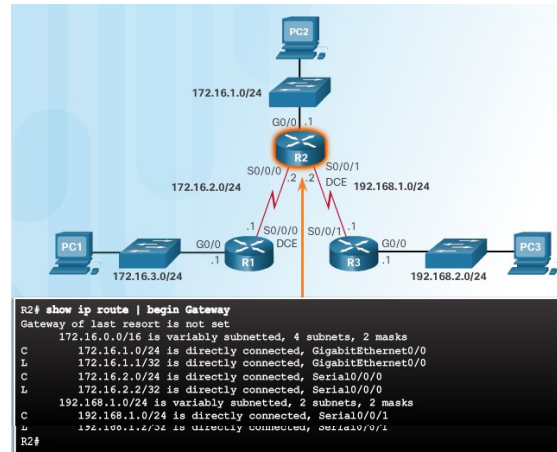
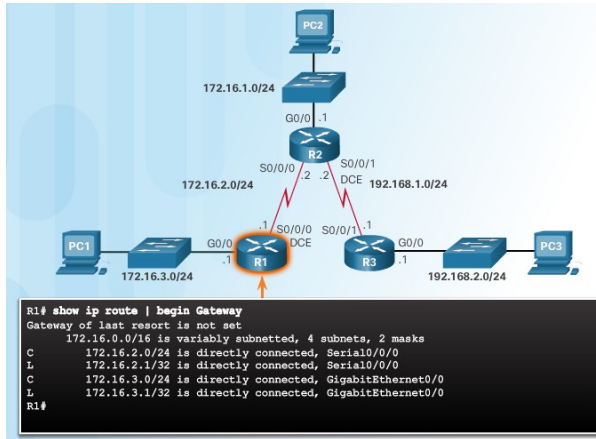

# Configure IPv4 Static Routes Next-Hop Options (Cont.)

- R1 does not have an entry in its routing table for the R3 LAN network
- In a static route next-hop can be identified by
  - Next-hop IP address
  - Router exit interface
  - Next-hop IP address and exit interface

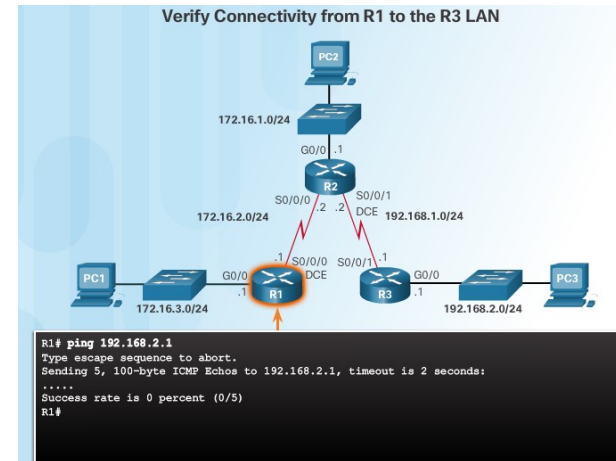
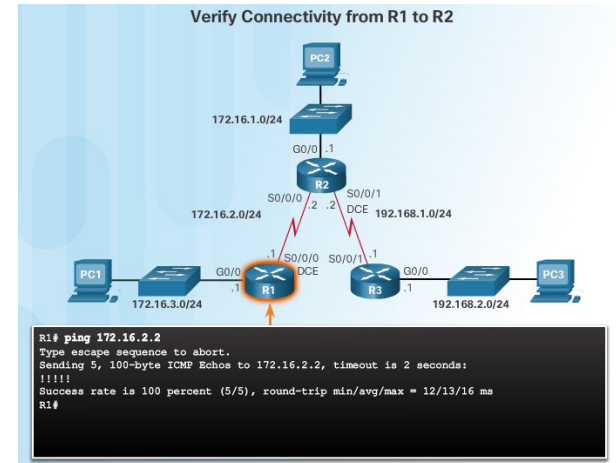

## Configure IPv4 Static Routes

# Configure a Next-Hop Static Route

- In this example, only the next-hop IP address is specified
- Before packet is forwarded the router must determine the exit interface to use (route resolvability)

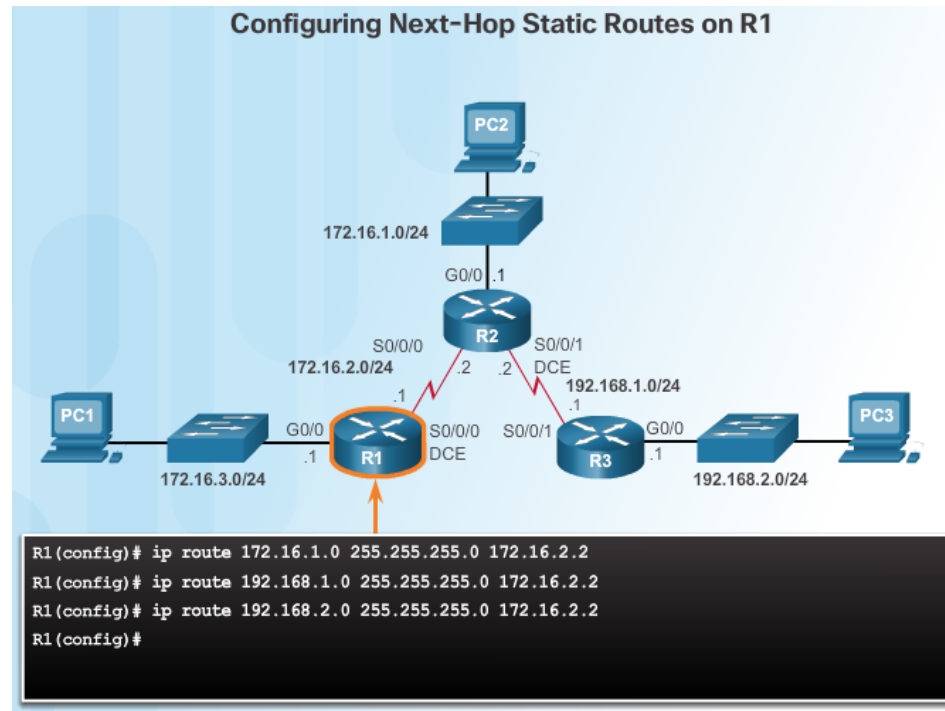

## Configure IPv4 Static Routes

# Configure a Next-Hop Static Route (Cont.)

- In example, when a packet is destined for 192.168.2.0/24 network, R1:
  - Looks for match (#1) and needs to forward packets to 172.16.2.2
  - R1 must determine how to reach 172.16.2.2 first
  - Searches a second time for 172.16.2.0/24 (#2) and matches to exit interface s0/0/0
  - Takes two routing table lookups, process referred to as recursive lookup
  - If the exit interface is “down” or “administratively down” then the static route configured with next-hop will not be installed in routing table

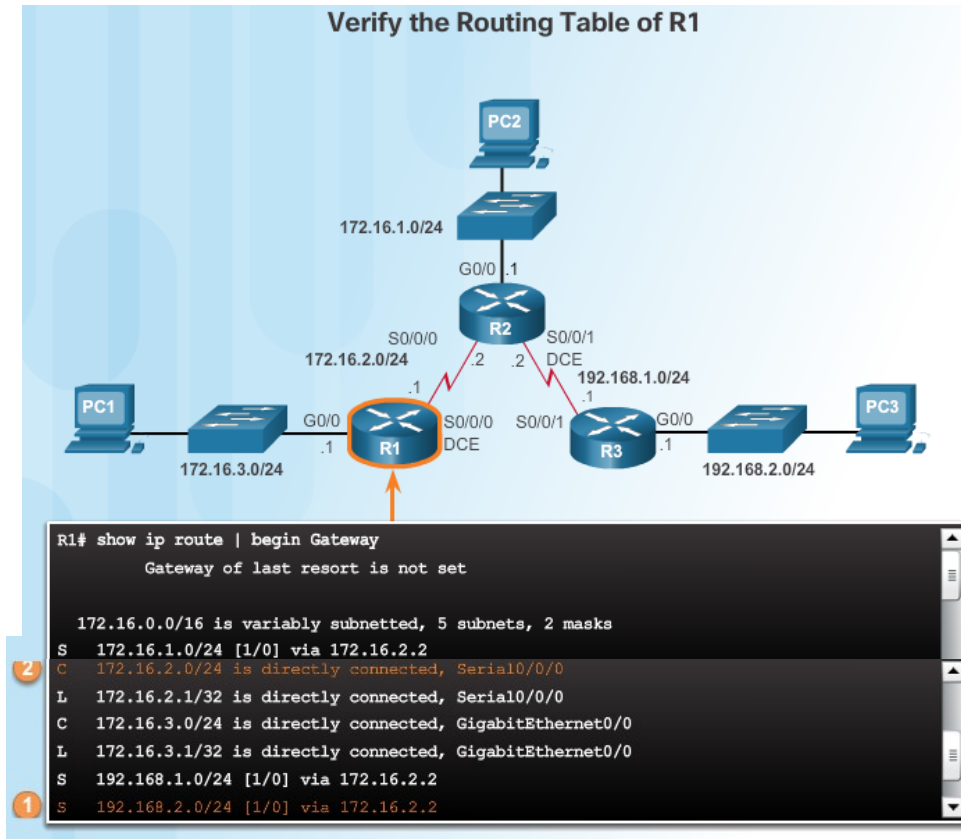

## Configure IPv4 Static Routes

# Configure a Directly Connected Static Route

- Use the exit interface to specify next-hop so no other lookups are required
- Administrative distance of static route is 1

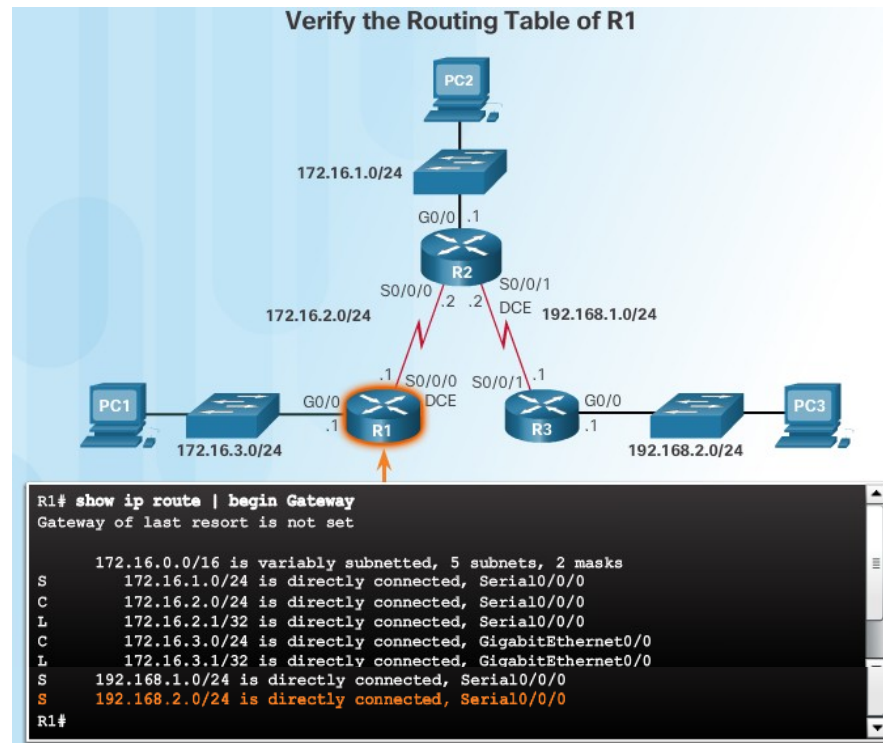
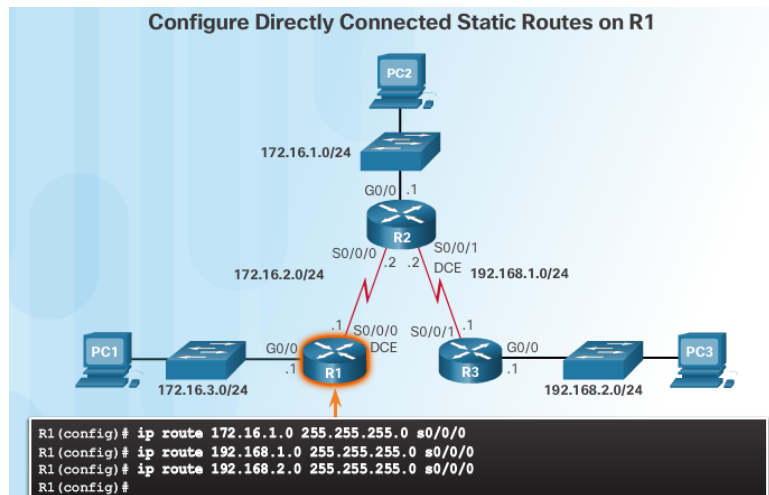

# Configure a Directly Connected Static Route (Cont.)

- Cisco Express Forwarding (CEF)
  - default behavior on IOS 12.0 or later
  - provides optimized lookup
  - uses a Forwarding Information Base (FIB) which is a copy of the routing table and an adjacency table that includes Layer 2 addresses
  - no recursive lookup needed for next-hop IP address lookups

## Configure IPv4 Static Routes

# Configure a Fully Specified Static Route

- Both the exit interface and the next-hop IP address are specified
- When exit interface is an Ethernet network, fully specified static route is used
- Note: With CEF, a next-hop address could be used instead

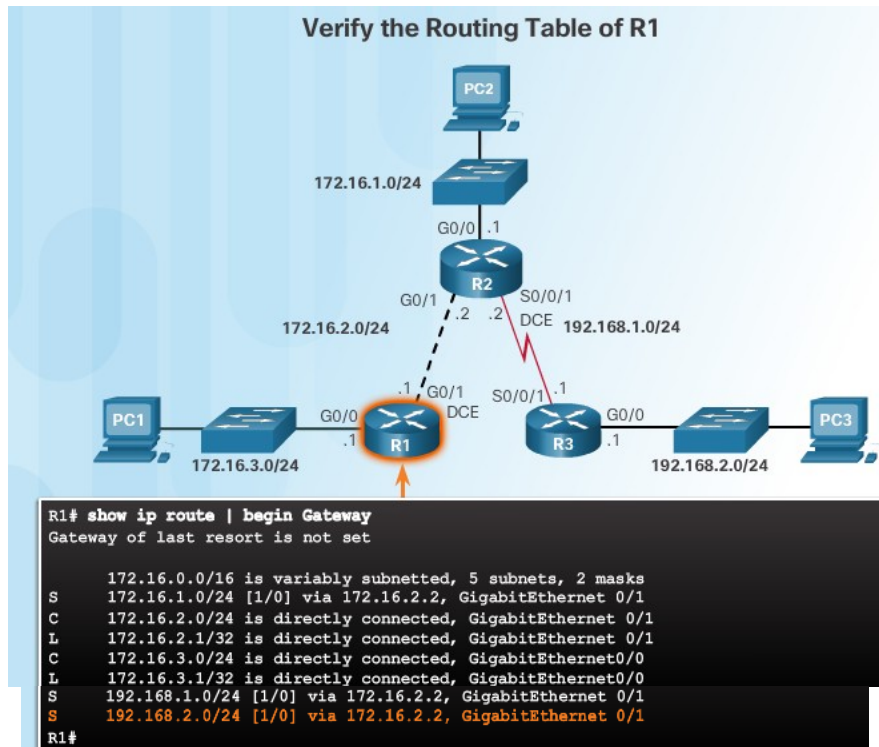
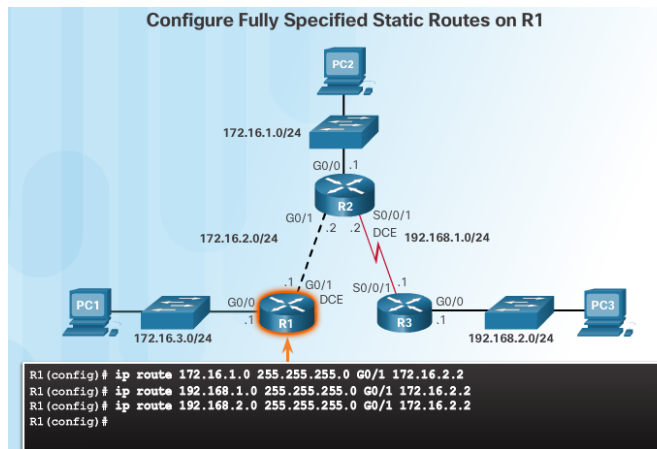

# Configure IPv4 Static Routes

## Verify a Static Route

### Verify the Routing Table of R1

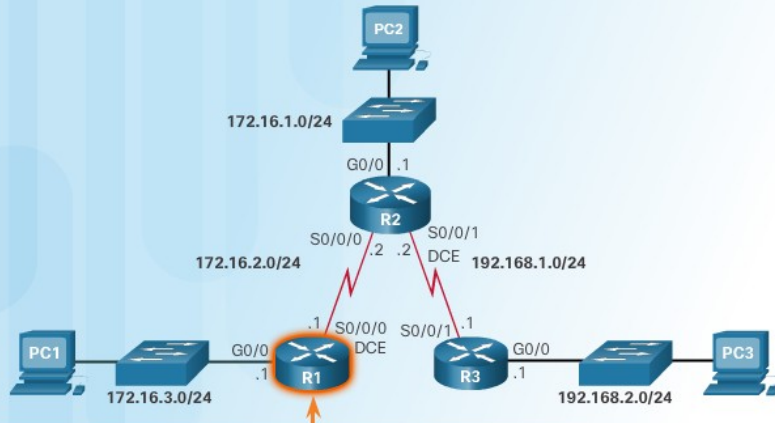

```
R1# show ip route static | begin Gateway
Gateway of last resort is not set

 172.16.0.0/16 is variably subnetted, 5 subnets, 2 masks
S   172.16.1.0/24 [1/0] via 172.16.2.2
S   192.168.1.0/24 [1/0] via 172.16.2.2
S   192.168.2.0/24 [1/0] via 172.16.2.2
R1#
```

### Verify a Specific Entry in the Routing Table

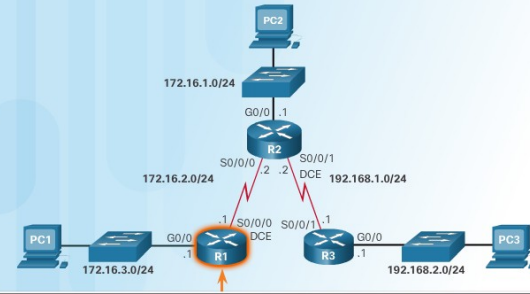

```
R1# show ip route 192.168.2.1
Routing entry for 192.168.2.0/24
Known via "static", distance 1, metric 0
Routing Descriptor Blocks:
* 172.16.2.2
  Route metric is 0, traffic share count is 1
R1#
```

### Verify the Static Route Configuration

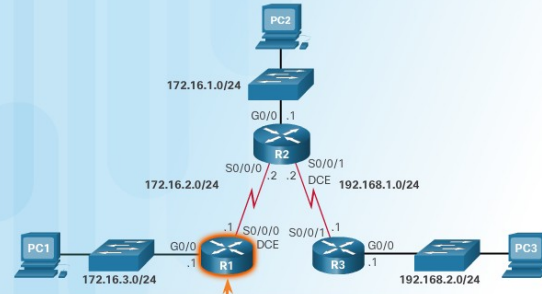

```
R1# show running-config | section ip route
ip route 172.16.1.0 255.255.255.0 172.16.2.2
ip route 192.168.1.0 255.255.255.0 172.16.2.2
ip route 192.168.2.0 255.255.255.0 172.16.2.2
R1#
```



# Configure IPv4 Default Routes

## Default Static Route

- Default static routes are commonly used when connecting:
  - An edge router to a service provider network
  - A stub router (a router with only one upstream neighbor router)
- Default route is used when no other routes in the routing table match the destination IP

### Default Static Route Syntax

```
Router(config)#ip route 0.0.0.0 0.0.0.0 {ip-address | exit-intf}
```

Parameter	Description
0.0.0.0 0.0.0.0	Matches any network address.
ip-address	<ul style="list-style-type: none"><li>• Commonly referred to as the next-hop router's IP address.</li><li>• Typically used when connecting to a broadcast media (i.e., Ethernet).</li><li>• Commonly creates a recursive lookup.</li></ul>
exit-intf	<ul style="list-style-type: none"><li>• Use the outgoing interface to forward packets to the destination network.</li><li>• Also referred to as a directly attached static route.</li><li>• Typically used when connecting in a point-to-point configuration.</li></ul>

## Configure IPv4 Default Routes

# Configure a Default Static Route

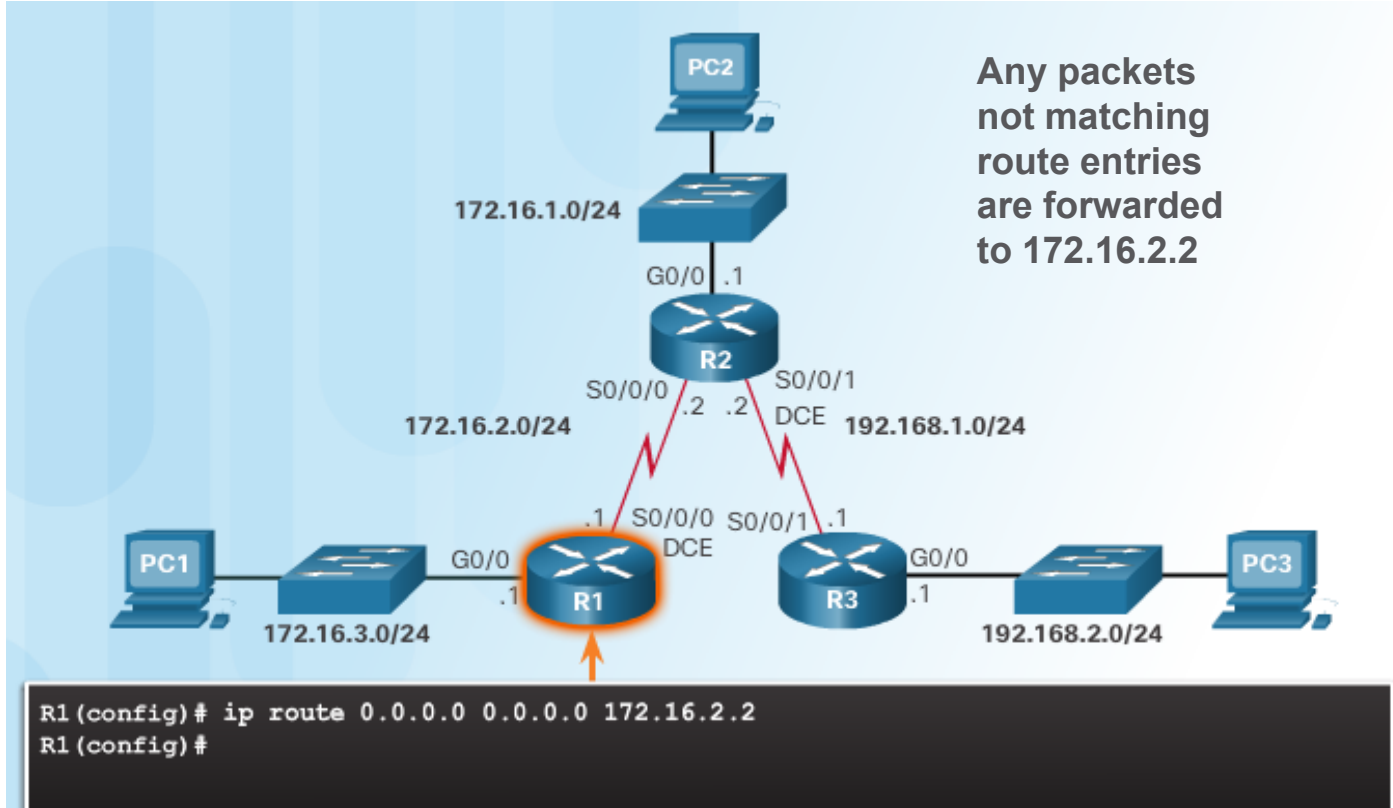

# Configure IPv4 Default Routes

## Verify a Default Static Route

- **show ip route static** displays just the static routes
  - **S** indicates static route
  - candidate default route indicated by \*
  - /0 mask in route entry indicates none of the bits are required to match

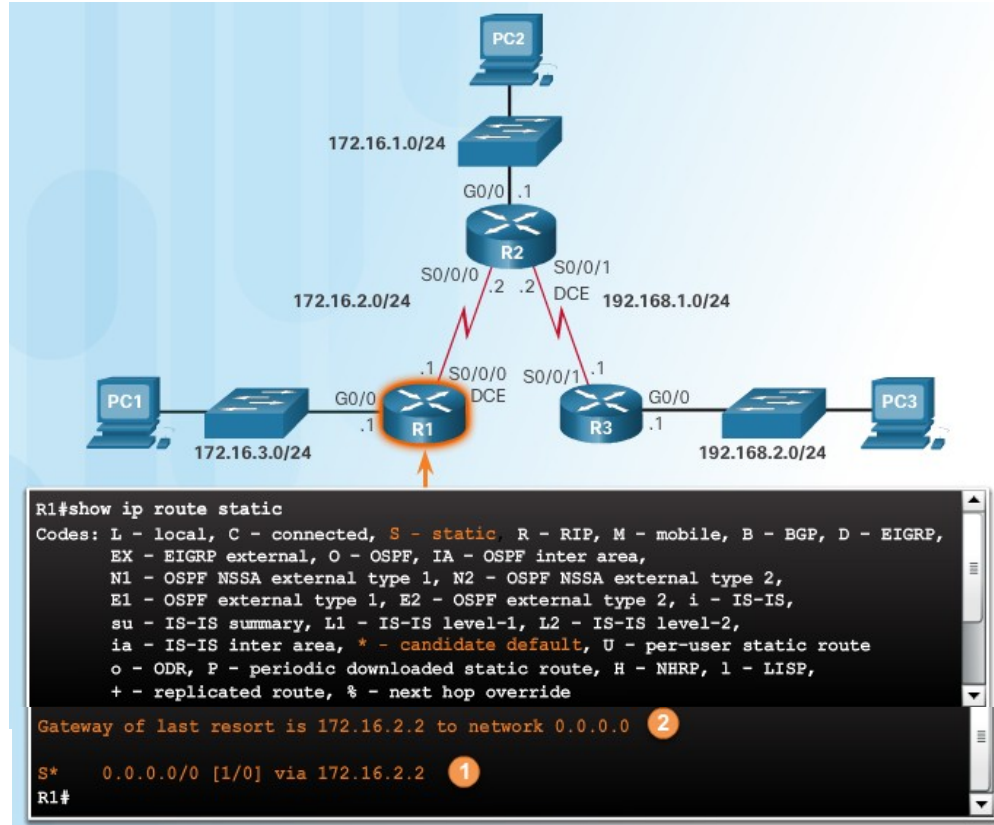

## Packet Tracer – Configuring IPv4 Static and Default Routes



### Packet Tracer - Configuring IPv4 Static and Default Routes

#### Topology

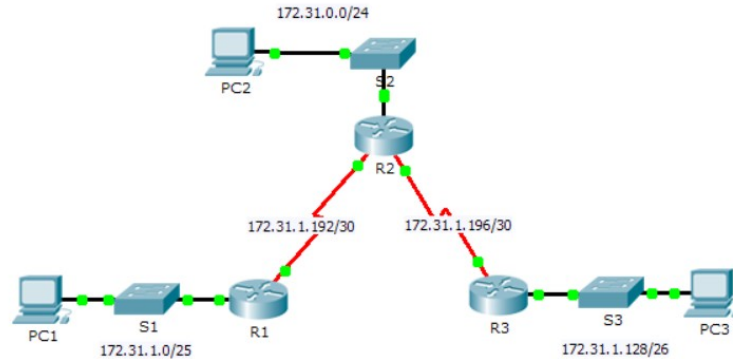

#### Addressing Table

Device	Interface	IPv4 Address	Subnet Mask	Default Gateway
R1	G0/0	172.31.1.1	255.255.255.128	N/A
	S0/0/0	172.31.1.104	255.255.255.252	N/A

## Lab – Configuring IPv4 Static and Default Routes



### Lab – Configuring IPv4 Static and Default Routes

#### Topology

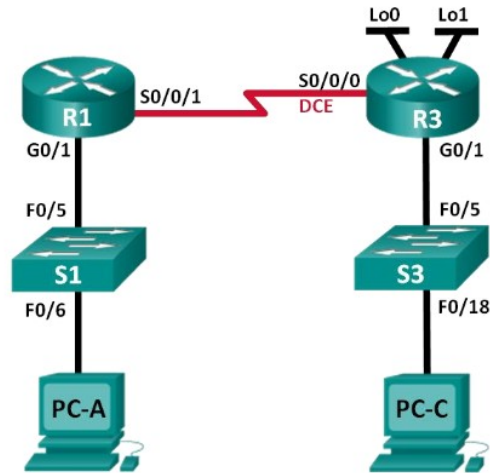

#### Addressing Table

Device	Interface	IP Address	Subnet Mask	Default Gateway
R1	G0/1	192.168.0.1	255.255.255.0	N/A
	S0/0/1	10.1.1.1	255.255.255.252	N/A
R3	G0/1	192.168.1.1	255.255.255.0	N/A

# Configure IPv6 Static Routes

## The ipv6 route Command

```
Router(config)# ipv6 route ipv6-prefix/prefix-length {ipv6-address | exit-intf}
```

Parameter	Description
ipv6-prefix	Destination network address of the remote network to be added to the routing table.
prefix-length	Prefix length of the remote network to be added to the routing table.
ipv6-address	<ul style="list-style-type: none"><li>• Commonly referred to as the next-hop router's IP address.</li><li>• Typically used when connecting to a broadcast media (i.e., Ethernet).</li><li>• Commonly creates a recursive lookup.</li></ul>
exit-intf	<ul style="list-style-type: none"><li>• Use the outgoing interface to forward packets to the destination network.</li><li>• Also referred to as a directly attached static route.</li><li>• Typically used when connecting in a point-to-point configuration.</li></ul>

## The ipv6 route Command (Cont.)

- **ipv6 unicast-routing** enables the router to forward IPv6 packets

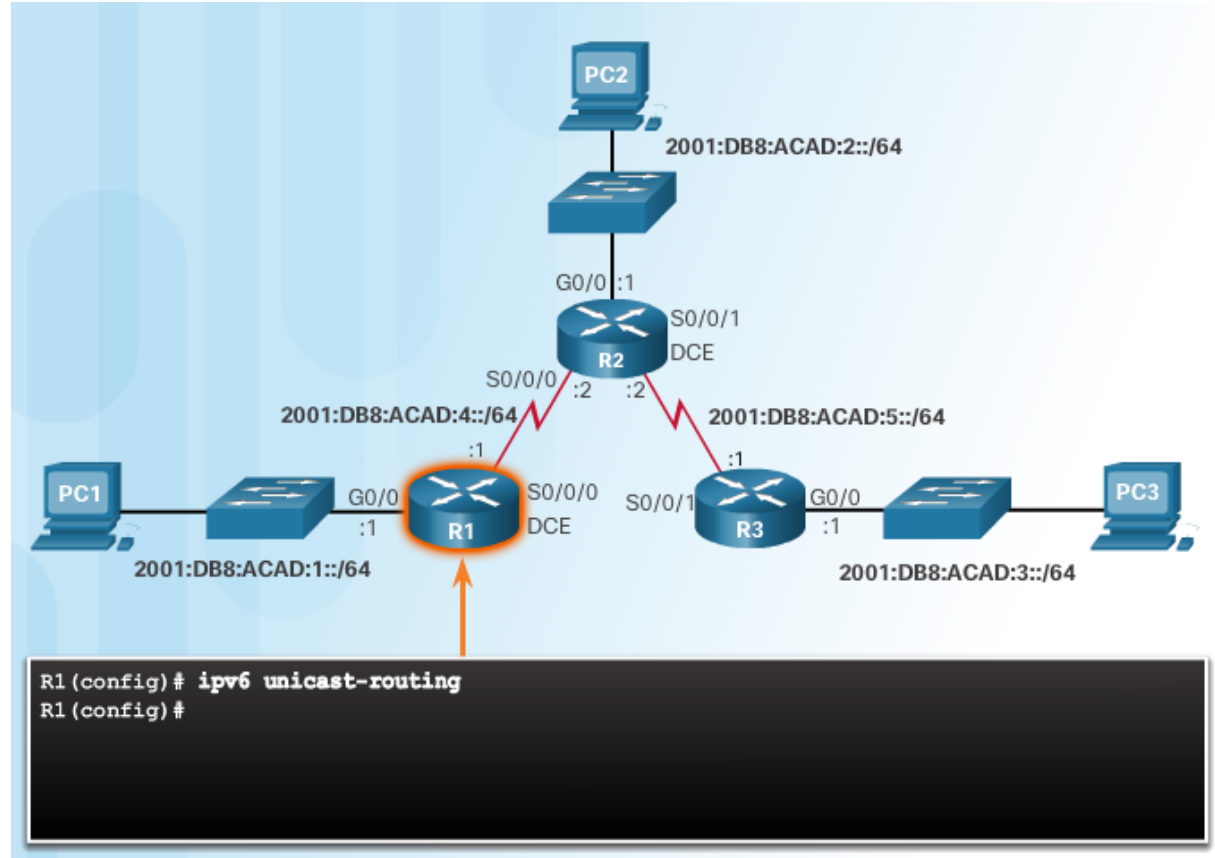

# Configure IPv6 Static Routes

## Next-Hop Options

- Each router only knows about directly connected networks
  - R1 can **ping** R2 (ipv6 2001:DB8:ACAD:4::2) but cannot **ping** R3 (ipv6 2001:DB8:ACAD:3::2)

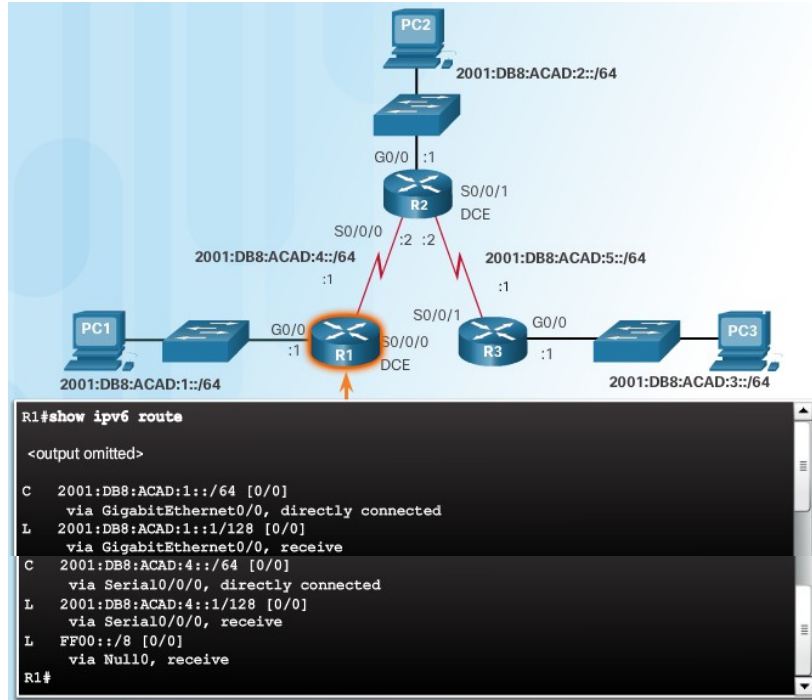

```
R1#show ipv6 route
<output omitted>
C 2001:DB8:ACAD:1::/64 [0/0]
  via GigabitEthernet0/0, directly connected
L 2001:DB8:ACAD:1::1/128 [0/0]
  via GigabitEthernet0/0, receive
C 2001:DB8:ACAD:4::/64 [0/0]
  via Serial0/0/0, directly connected
L 2001:DB8:ACAD:4::1/128 [0/0]
  via Serial0/0/0, receive
L FF00::/8 [0/0]
  via Null0, receive
R1#
```

```
R2#show ipv6 route
<output omitted>
C 2001:DB8:ACAD:2::/64 [0/0]
  via GigabitEthernet0/0, directly connected
L 2001:DB8:ACAD:2::1/128 [0/0]
  via GigabitEthernet0/0, receive
C 2001:DB8:ACAD:4::/64 [0/0]
  via Serial0/0/0, directly connected
L 2001:DB8:ACAD:4::2/128 [0/0]
  via Serial0/0/0, receive
C 2001:DB8:ACAD:5::/64 [0/0]
  via Serial0/0/1, directly connected
L 2001:DB8:ACAD:5::2/128 [0/0]
  via Serial0/0/1, receive
L FF00::/8 [0/0]
  via Null0, receive
R2#
```

```
R3#show ipv6 route
<output omitted>
C 2001:DB8:ACAD:3::/64 [0/0]
  via GigabitEthernet0/0, directly connected
L 2001:DB8:ACAD:3::1/128 [0/0]
  via GigabitEthernet0/0, receive
C 2001:DB8:ACAD:5::/64 [0/0]
  via Serial0/0/1, directly connected
L 2001:DB8:ACAD:5::1/128 [0/0]
  via Serial0/0/1, receive
L FF00::/8 [0/0]
  via Null0, receive
R3#
```



# Next-Hop Options (Cont.)

- Next hop can be identified by an IPv6 address, exit interface, or both.
- Destination is specified by one of three route types:
  - **Next-hop static IPv6 route** - Only the next-hop IPv6 address is specified
  - **Directly connected static IPv6 route** - Only the router exit interface is specified
  - **Fully specified static IPv6 route** - The next-hop IPv6 address and exit interface are specified

## Configure IPv6 Static Routes

# Configure a Next Hop Static IPv6 Route

Three next-hop static routes are configured on R1

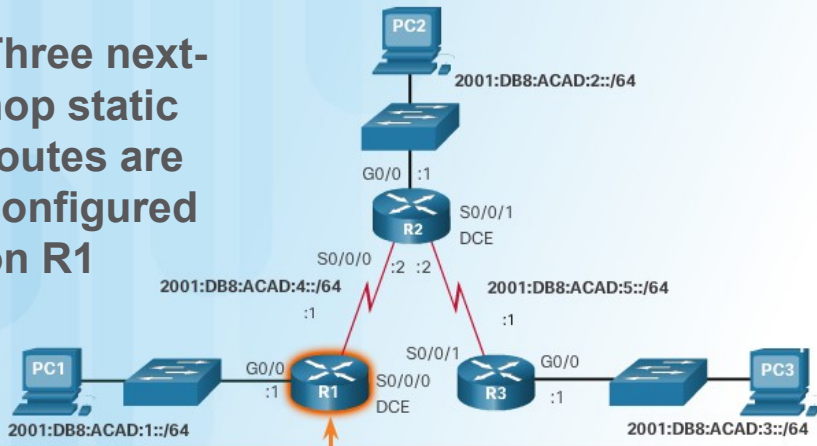

```
R1(config)# ipv6 route 2001:DB8:ACAD:2::/64 2001:DB8:ACAD:4::2
R1(config)# ipv6 route 2001:DB8:ACAD:5::/64 2001:DB8:ACAD:4::2
R1(config)# ipv6 route 2001:DB8:ACAD:3::/64 2001:DB8:ACAD:4::2
R1(config)#
```

As with IPv4, must resolve the route to determine the exit interface to use to forward the packet

```
R1# show ipv6 route
IPv6 Routing Table - default - 8 entries
Codes: C - Connected, L - Local, S - Static, U - Per-user Static route, B - BGP,
R - RIP, H - NHRP, I1 - ISIS L1, I2 - ISIS L2, IA - ISIS interarea,
IS - ISIS summary, D - EIGRP, EX - EIGRP external, ND - ND Default,
NDP - ND Prefix, DCE - Destination, NDr - Redirect, O - OSPF Intra,
OI - OSPF Inter, OE1 - OSPF ext 1, OE2 - OSPF ext 2, ON1 - OSPF NSSA ext 1,
ON2 - OSPF NSSA ext 2

C 2001:DB8:ACAD:1::/64 [0/0]
  via GigabitEthernet0/0, directly connected
L 2001:DB8:ACAD:1::1/128 [0/0]
  via GigabitEthernet0/0, receive
S 2001:DB8:ACAD:2::/64 [1/0]
  via 2001:DB8:ACAD:4::2
S 2001:DB8:ACAD:3::/64 [1/0]
  via 2001:DB8:ACAD:4::2
C 2001:DB8:ACAD:4::/64 [0/0]
  via Serial0/0/0, directly connected
L 2001:DB8:ACAD:4::1/128 [0/0]
  via Serial0/0/0, receive
S 2001:DB8:ACAD:5::/64 [1/0]
  via 2001:DB8:ACAD:4::2
L FF00::/8 [0/0]
  via Null0, receive
R1#
```

The IPv6 address matches the route for the directly connected network 2001:DB8:ACAD:4::/64 with the exit interface Serial 0/0/0.

## Configure IPv6 Static Routes

# Configure a Directly Connected Static IPv6 Route

- Alternative to next hop is to specify the exit interface
- Packet destined for 2001:DB8:ACAD:3::/64 network, forwarded out Serial 0/0/0 – no other lookups needed

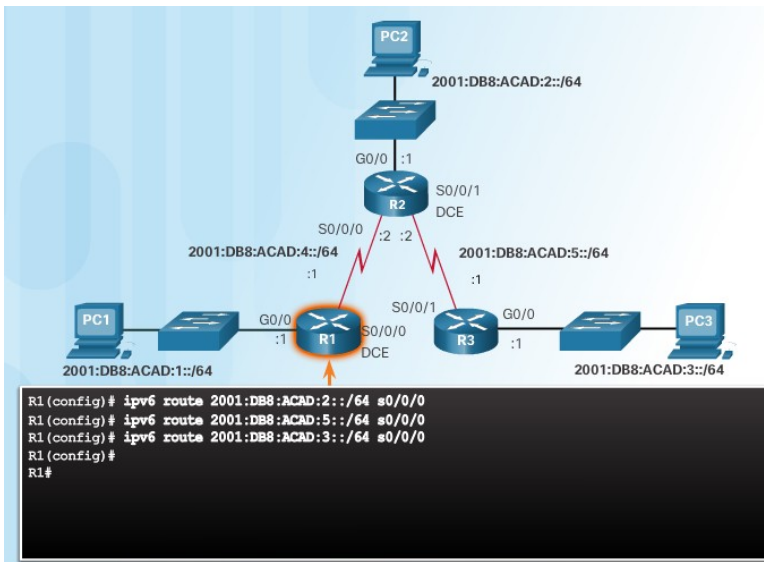

```
R1# show ipv6 route
IPv6 Routing Table - default - 8 entries
Codes: C - Connected, L - Local, S - Static, U - Per-user Static route
       B - BGP, R - RIP, I1 - ISIS L1, I2 - ISIS L2
       IA - ISIS interarea, IS - ISIS summary, D - EIGRP, EX - EIGRP external
       ND - ND Default, NDp - ND Prefix, DCE - Destination, Ndr - Redirect
       O - OSPF Intra, OI - OSPF Inter, OE1 - OSPF ext 1, OE2 - OSPF ext 2
       ON1 - OSPF NSSA ext 1, ON2 - OSPF NSSA ext 2
C 2001:DB8:ACAD:1::/64 [0/0]
  via GigabitEthernet0/0, directly connected
L 2001:DB8:ACAD:1::1/128 [0/0]
  via GigabitEthernet0/0, receive
S 2001:DB8:ACAD:2::/64 [1/0]
  via Serial0/0/0, directly connected
S 2001:DB8:ACAD:3::/64 [1/0]
  via Serial0/0/0, directly connected
C 2001:DB8:ACAD:4::/64 [0/0]
  via Serial0/0/0, directly connected
L 2001:DB8:ACAD:4::1/128 [0/0]
  via Serial0/0/0, receive
S 2001:DB8:ACAD:5::/64 [1/0]
  via Serial0/0/0, directly connected
L FF00::/8 [0/0]
  via Null0, receive
R1#
```

## Configure IPv6 Static Routes

# Configure a Fully Specified Static IPv6 Route

- Fully specified static route must be used if IPv6 link-local address is used as next-hop

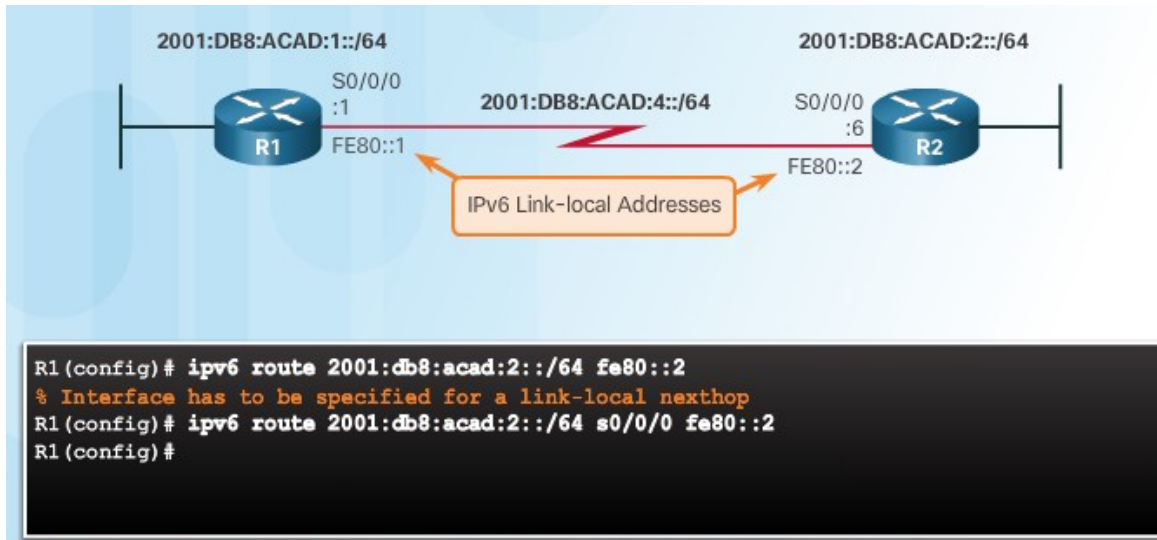

```
R1# show ipv6 route static | begin 2001:DB8:ACAD:2::/64
S 2001:DB8:ACAD:2::/64 [1/0]
  via FE80::2, Serial10/0/0
```

# Configure IPv6 Static Routes

## Verify IPv6 Static Routes

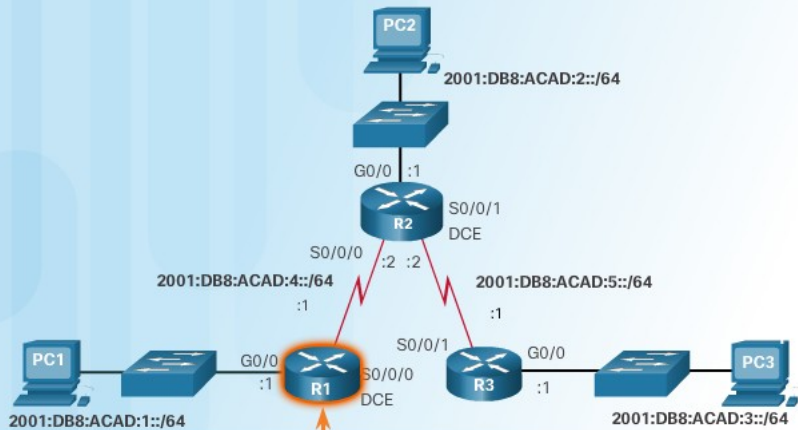

```
R1# show ipv6 route static
IPv6 Routing Table - default - 8 entries
Codes: C - Connected, L - Local, S - Static, U - Per-user Static route, B - BGP,
R - RIP, I1 - ISIS L1, I2 - ISIS L2, IA - ISIS interarea, IS - ISIS summary,
D - EIGRP, EX - EIGRP external, ND - ND Default, NDp - ND Prefix,
DCE - Destination, NDR - Redirect, O - OSPF Intra, OI - OSPF Inter,
OE1 - OSPF ext 1, OE2 - OSPF ext 2, ON1 - OSPF NSSA ext 1,
ON2 - OSPF NSSA ext 2
S 2001:DB8:ACAD:2::/64 [1/0]
  via 2001:DB8:ACAD:4::2
S 2001:DB8:ACAD:3::/64 [1/0]
  via 2001:DB8:ACAD:4::2
S 2001:DB8:ACAD:5::/64 [1/0]
  via 2001:DB8:ACAD:4::2
R1#
```

```
R1# show ipv6 route 2001:db8:acad:3::
Routing entry for 2001:DB8:ACAD:3::/64
Known via "static", distance 1, metric 0
Route count is 1/1, share count 0
Routing paths:
  2001:DB8:ACAD:4::2
  Last updated 00:19:11 ago
R1#
```

```
R1# show running-config | section ipv6 route
ipv6 route 2001:DB8:ACAD:2::/64 2001:DB8:ACAD:4::2
ipv6 route 2001:DB8:ACAD:3::/64 2001:DB8:ACAD:4::2
ipv6 route 2001:DB8:ACAD:5::/64 2001:DB8:ACAD:4::2
R1#
```

# Configure IPv6 Default Routes

## Default Static IPv6 Route

- Default static route matches all packets not specified in routing table

```
Router(config)# ipv6 route ::/0 (ipv6-address | exit-intf)
```

Parameter	Description
::/0	Matches any IPv6 prefix regardless of prefix length.
ipv6-address	<ul style="list-style-type: none"><li>• Commonly referred to as the next-hop router's IPv6 address.</li><li>• Typically used when connecting to a broadcast media (i.e., Ethernet).</li><li>• Commonly creates a recursive lookup.</li></ul>
exit-intf	<ul style="list-style-type: none"><li>• Use the outgoing interface to forward packets to the destination network.</li><li>• Also referred to as a directly attached static route.</li><li>• Typically used when connecting in a point-to-point configuration.</li></ul>

## Configure IPv6 Default Routes

# Configure a Default Static IPv6 Route

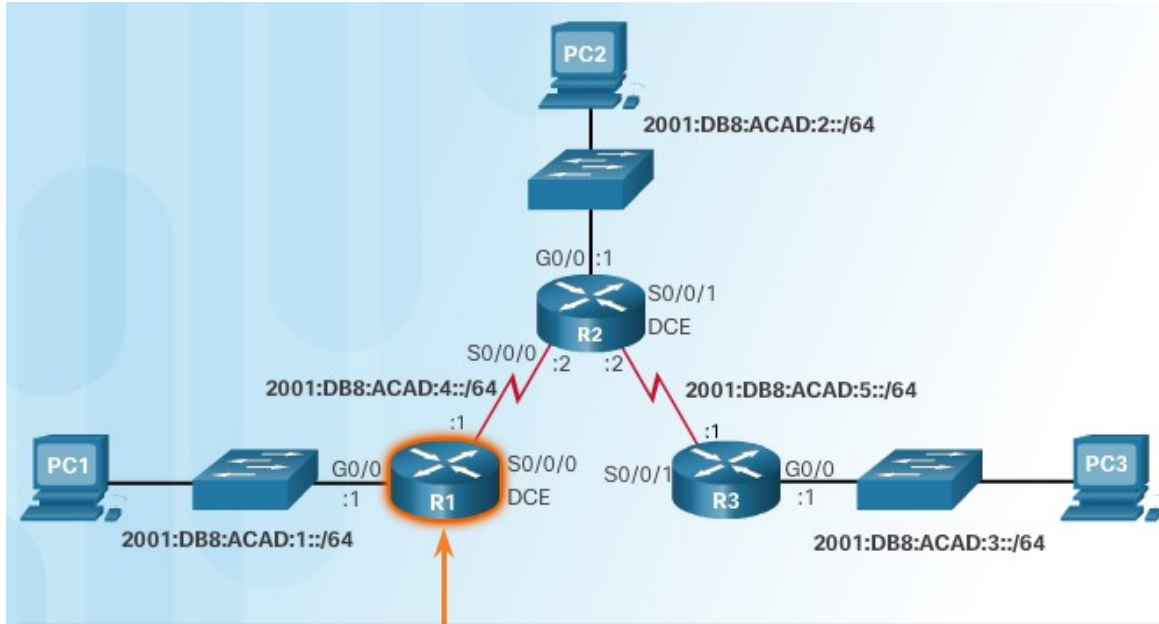

- R1 is a stub router because it is only connected to R2
- More efficient to configure a default static IPv6 route in this topology

```
R1(config)# ipv6 route ::/0 2001:DB8:ACAD:4::2
R1(config)#
```

# Configure IPv6 Default Routes

## Verify a Default Static Route

- `::/0` mask indicates that none of the bits are required to match
- If a more specific match does not exist, the default static IPv6 route matches all packets.

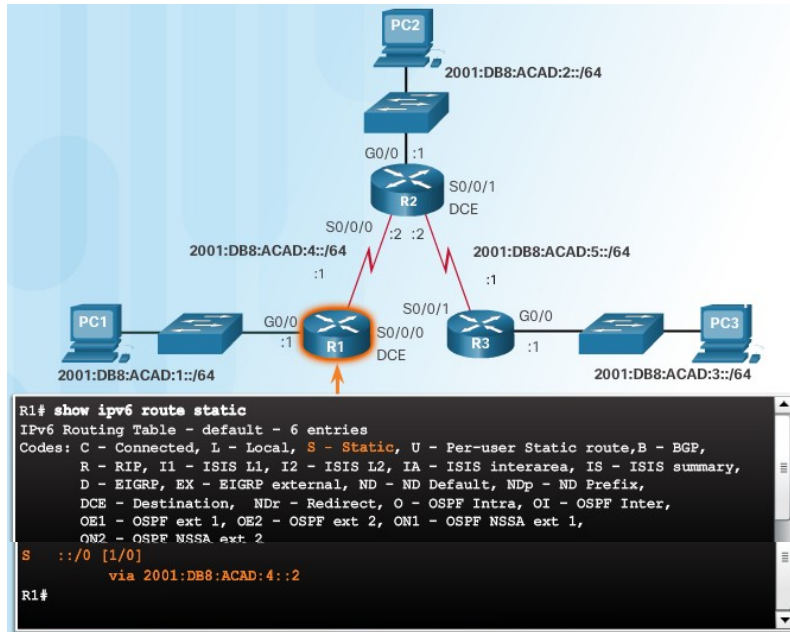

```
R1# ping 2001:0DB8:ACAD:3::1
Type escape sequence to abort.
Sending 5, 100-byte ICMP Echos to 2001:DB8:ACAD:3::1,
timeout is 2 seconds:
!!!!
Success rate is 100 percent (5/5), round-trip min/avg/max
= 28/28/28 ms
R1#
```



## Packet Tracer – Configuring IPv6 Static and Default Routes



### Packet Tracer - Configuring IPv6 Static and Default Routes

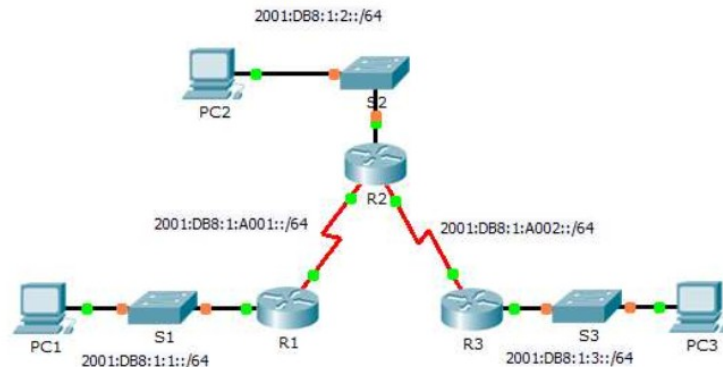

IPv6 Addressing Table

Device	Interface	IPv6 Address/Prefix	Default Gateway
R1	G0/0	2001:DB8:1:1::1/64	N/A
	S0/0/0	2001:DB8:1:A001::1/64	N/A
	G0/0	2001:DB8:1:2::1/64	N/A

## Lab – Configuring IPv6 Static and Default Routes



### Lab – Configuring IPv6 Static and Default Routes

#### Topology

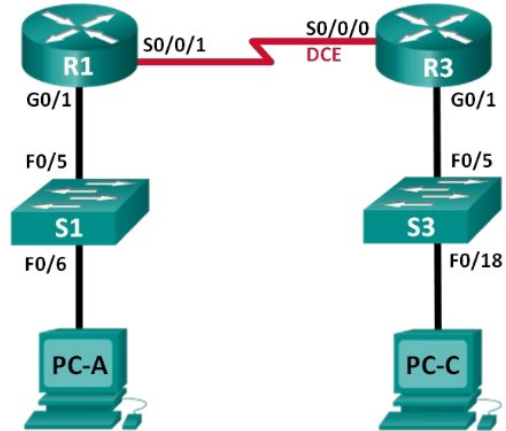

#### Addressing Table

Device	Interface	IPv6 Address / Prefix Length	Default Gateway
R1	G0/1	2001:DB8:ACAD:A::/64 eui-64	N/A
	S0/0/1	FC00::1/64	N/A

# Configure Floating Static Routes

## Floating Static Routes

Floating static routes have an administrative distance greater than the dynamic routing protocol or other static route

- Used as backup routes
- Administrative distance of common routing protocols
  - EIGRP = 90
  - IGRP = 100
  - OSPF = 110
  - IS-IS = 115
  - RIP = 120
- By default, AD of static route = 1
- Static route AD can be increased to make route less desirable until preferred route is lost

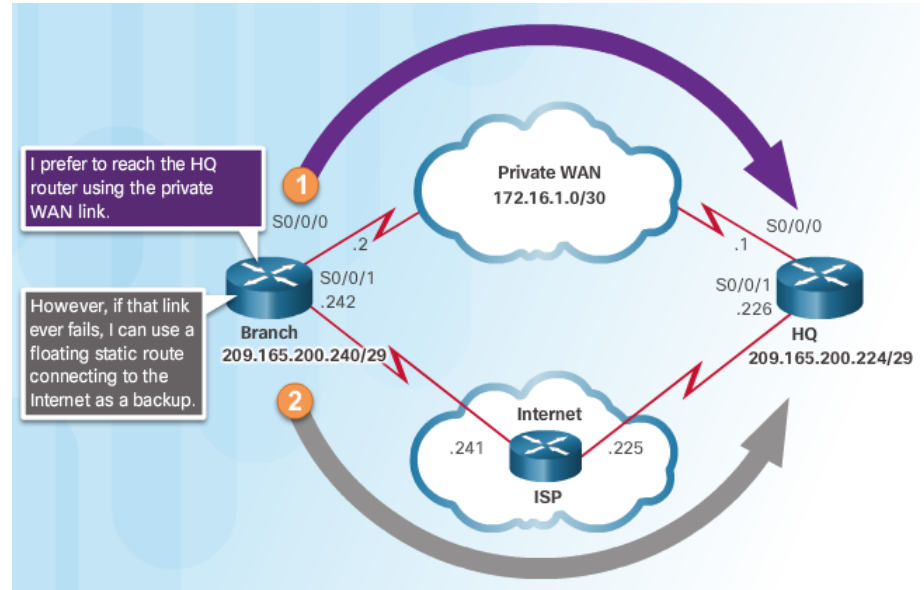

# Configure Floating Static Routes

## Configure a Floating Static Route

### Configuring a Floating Static Route to R3

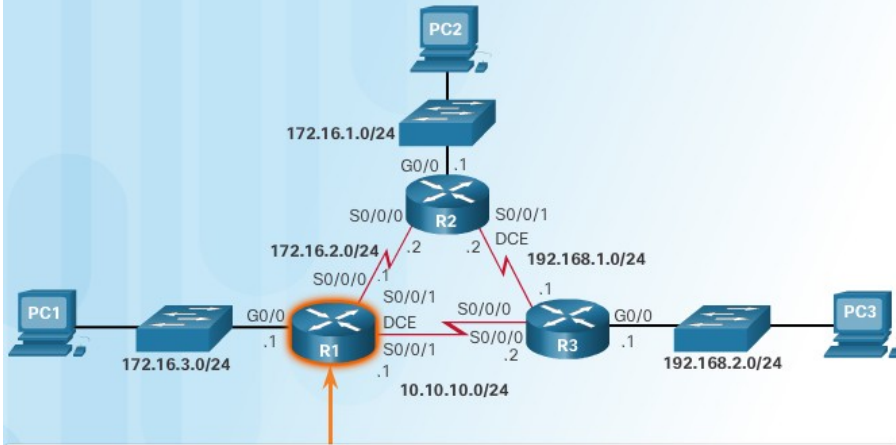

```
R1(config)# ip route 0.0.0.0 0.0.0.0 172.16.2.2
R1(config)# ip route 0.0.0.0 0.0.0.0 10.10.10.2 5
R1(config)#
```

**Preferred router from  
R1 is to R2 (AD = 1)**

```
R1# show ip route static | begin Gateway
Gateway of last resort is 0.0.0.0 to network 0.0.0.0

S* 0.0.0.0/0 [1/0] via 172.16.2.2
R1#
```

# Configure Floating Static Routes

## Test the IPv4 Floating Static Route

### Verify the Path to the R3 LAN

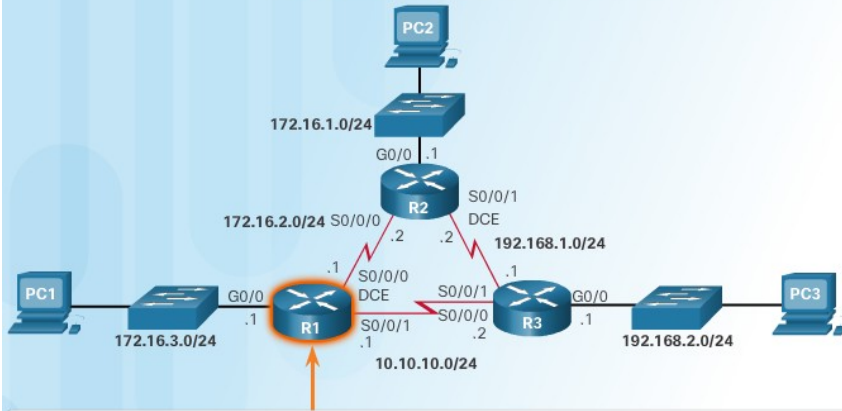

```
R1# traceroute 192.168.2.1
Type escape sequence to abort.
Tracing the route to 192.168.2.1
VRF info: (vrf in name/id, vrf out name/id)
 0 172.16.2.2 4 msec 4 msec 8 msec
 1 172.16.2.2 4 msec 4 msec 8 msec
 2 192.168.1.1 12 msec * 12 msec
R1#
```

### Simulate a Router Failure on R2

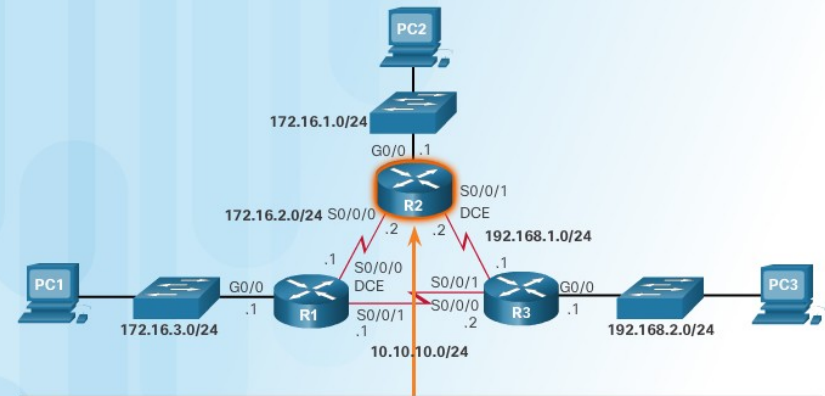

```
R2(config)# int s0/0/0
R2(config-if)# shut
*Feb 21 16:33:35.939: %LINK-5-CHANGED: Interface Serial0/0/0, changed
state to administratively down
*Feb 21 16:33:36.939: %LINEPROTO-5-UPDOWN: Line protocol on Interface
Serial0/0/0, changed state to down
R2(config-if)# int s0/0/1
R2(config-if)# shut
R2(config-if)#
*Feb 21 16:33:42.543: %LINK-5-CHANGED: Interface Serial0/0/1, changed
```

# Configure Floating Static Routes

## Test the IPv4 Floating Static Route (Cont.)

### Verify the Default Route on R1

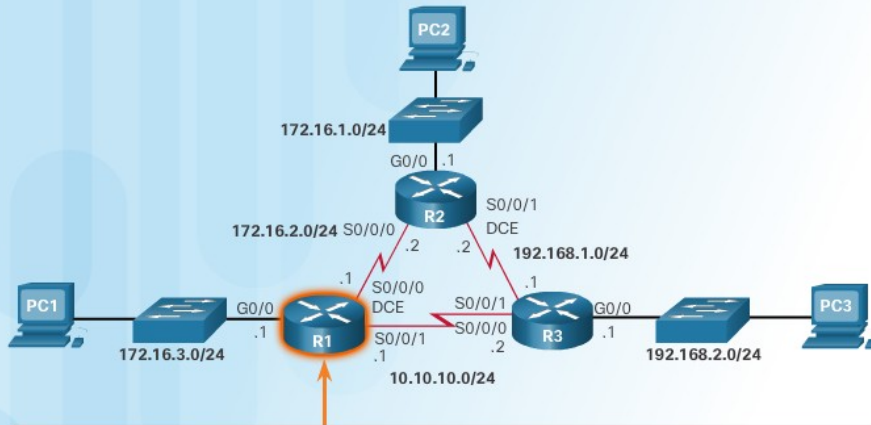

```
*Feb 21 16:35:58.435: %LINK-3-UPDOWN: Interface Serial0/0/0, changed
state to down
*Feb 21 16:35:59.435: %LINEPROTO-5-UPDOWN: Line protocol on Interface
Serial0/0/0, changed state to down
R1#
R1# show ip route static | begin Gateway
Gateway of last resort is 0.0.0.0 to network 0.0.0.0
S* 0.0.0.0/0 [5/0] via 10.10.10.2
R1#
```

### Verify the Path to the R3 LAN

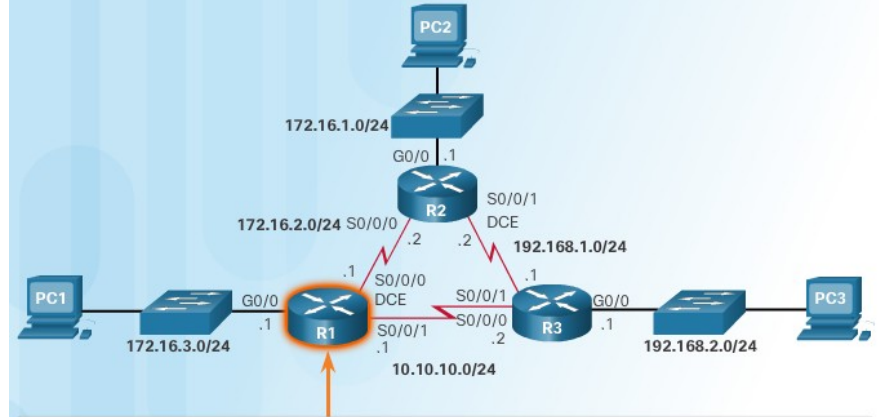

```
R1# traceroute 192.168.2.1
Type escape sequence to abort.
Tracing the route to 192.168.2.1
VRF info: (vrf in name/id, vrf out name/id)
 1 10.10.10.2 4 msec 4 msec *
R1#
```

## Configure Floating Static Routes

# Configure an IPv6 Floating Static Route

- Similar to IPv4 floating static routes

### Configure an IPv6 Floating Static Routes to R3

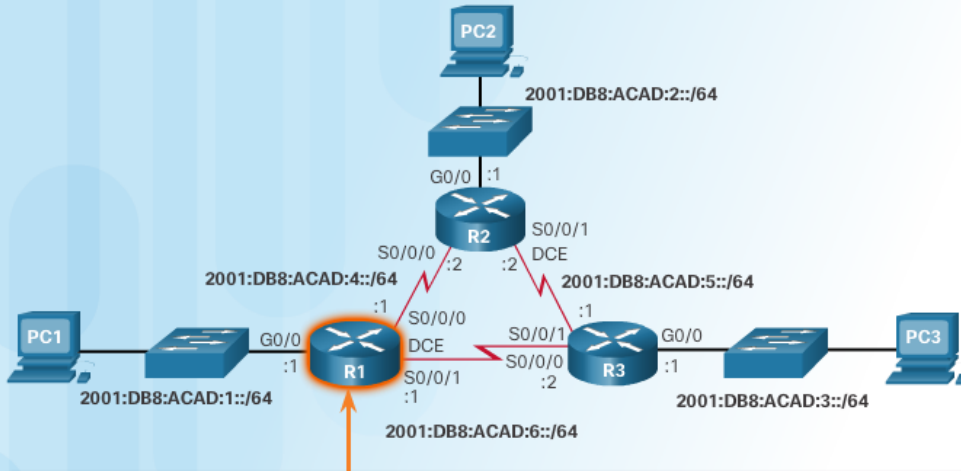

```
R1(config)# ipv6 route ::/0 2001:db8:acad:4::2
R1(config)# ipv6 route ::/0 2001:db8:acad:6::2 5
R1(config)#
```

```
R1# show run | include ipv6 route
ipv6 route ::/0 2001:DB8:ACAD:6::2 5
ipv6 route ::/0 2001:DB8:ACAD:4::2
R1#
```

### Verify the IPv6 Floating Static Route is not in the Routing Table

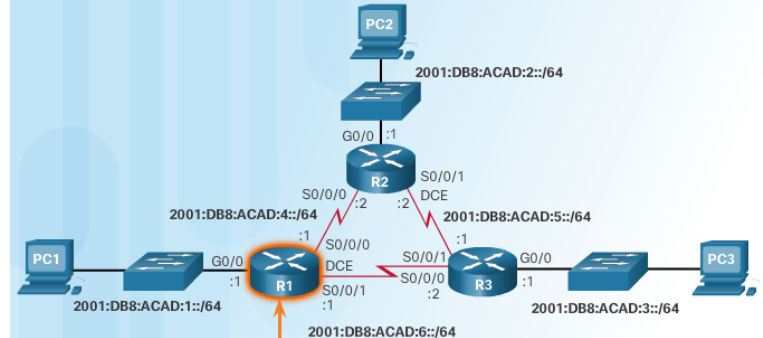

```
R1# show ipv6 route static | begin S :
S  ::/0 [1/0]
  via 2001:DB8:ACAD:4::2
R1#
```

## Packet Tracer - Configuring Floating Static Routes



### Packet Tracer - Configuring Floating Static Routes

#### Topology

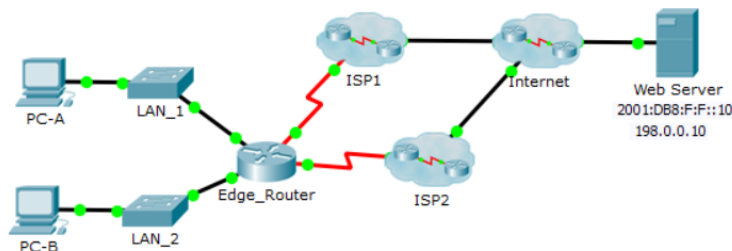

#### Objectives

- Part 1: Configure an IPv4 Floating Static Route**
- Part 2: Test Failover to the IPv4 Floating Static Route**
- Part 3: Configure and Test Failover for an IPv6 Floating Static Route**

#### Background

In this activity, you will configure IPv4 and IPv6 floating static routes. These routes are manually configured with an administrative distance greater than that of the primary route and, therefore, would not be in the routing table until the primary route fails. You will test failover to the backup routes, and then restore connectivity to the primary route.

#### Part 1: Configure an IPv4 Floating Static Route

Step 1: Configure an IPv4 static default route



# Configure Static Host Routes

## Automatically Installed Host Routes

Host route is an IPv4 address with a 32-bit mask or IPv6 address with a 128-bit mask.

- Automatically installed when IP address is configured
- Configured as a static host route
- Allows more efficiency for packets directed to the router
- Local route marked with “L” (introduced in IOS 15)

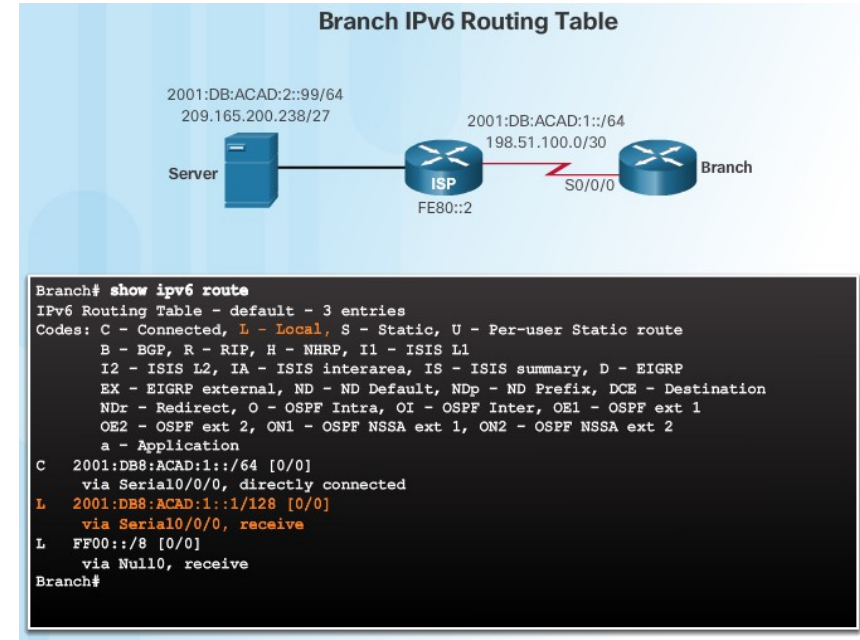
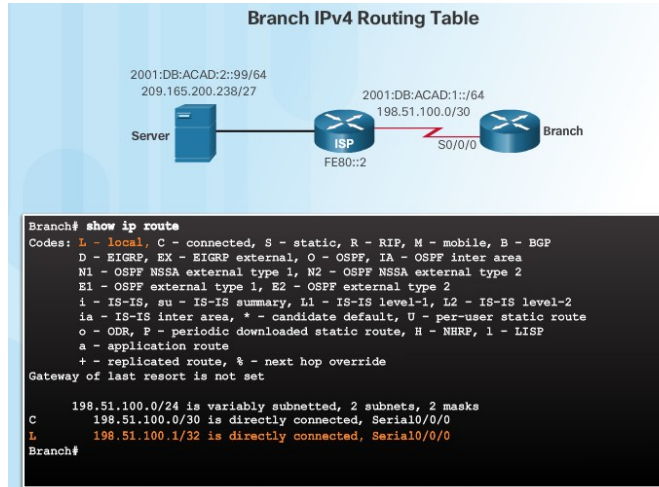

# Configure Static Host Routes

## Configure IPv4 and IPv6 Static Host Routes

### IPv4 and IPv6 Host Route Configuration and Verification



```
Branch(config)# ip route 209.165.200.238 255.255.255.255 198.51.100.2
Branch(config)# ipv6 route 2001:db8:acad:2::99/128 2001:db8:acad:1::2
Branch(config)# end
Branch# show ip route | begin Gateway
Gateway of last resort is not set

    198.51.100.0/24 is variably subnetted, 2 subnets, 2 masks
C       198.51.100.0/30 is directly connected, Serial0/0/0
L       198.51.100.1/32 is directly connected, Serial0/0/0
S       209.165.200.0/32 is subnetted, 1 subnets
        S    209.165.200.238 [1/0] via 198.51.100.2
Branch# show ipv6 route

C 2001:DB8:ACAD:1::/64 [0/0]
   via Serial0/0/0, directly connected
L 2001:DB8:ACAD:1::1/128 [0/0]
   via Serial0/0/0, receive
S 2001:DB8:ACAD:2::99/128 [1/0]
   via 2001:DB8:ACAD:1::2
L FF00::/8 [0/0]
   via Null0, receive
Branch#
```

### Fully Specified IPv6 Host Route with the Next-Hop Link-Local Address

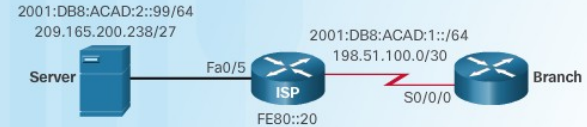

```
Branch(config)# no ipv6 route 2001:db8:acad:2::99/128 2001:db8:acad:1::2
Branch(config)# ipv6 route 2001:db8:acad:2::99/128 serial 0/0/0 fe80::2
Branch(config)# end
Branch# show ipv6 route

S ::/0 [1/0]
   via 2001:DB8:ACAD:1::2
C 2001:DB8:ACAD:1::/64 [0/0]
   via Serial0/0/0, directly connected
L 2001:DB8:ACAD:1::1/128 [0/0]
   via Serial0/0/0, receive
S 2001:DB8:ACAD:2::99/128 [1/0]
   via FE80::2, Serial0/0/0
L FF00::/8 [0/0]
   via Null0, receive
Branch#
```

## 2.3 Troubleshoot Static and Default Routes

# Packet Processing with Static Routes

## Static Routes and Packet Forwarding

PC1 sending packet to PC3 - Packet arrives on G0/0

R1 has no specific route to 192.168.2.0 so uses default route

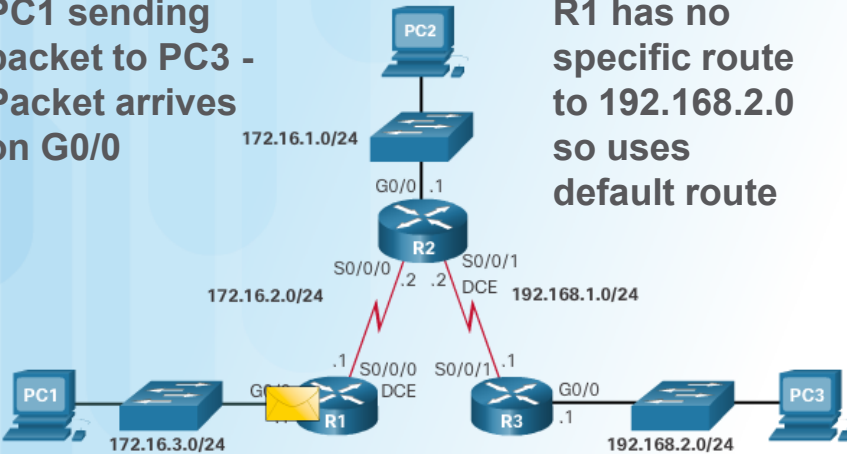

R1 encapsulates packet in new frame

Frame forwarded out S0/0/0

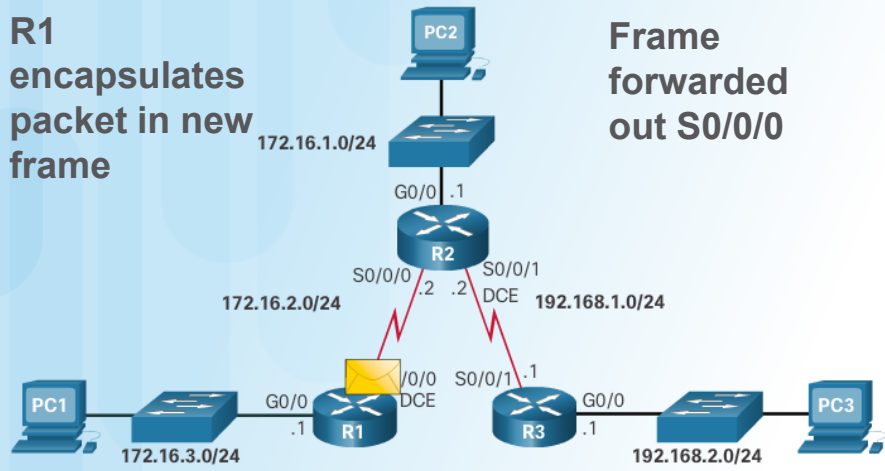

# Packet Processing with Static Routes

## Static Routes and Packet Forwarding (Cont.)

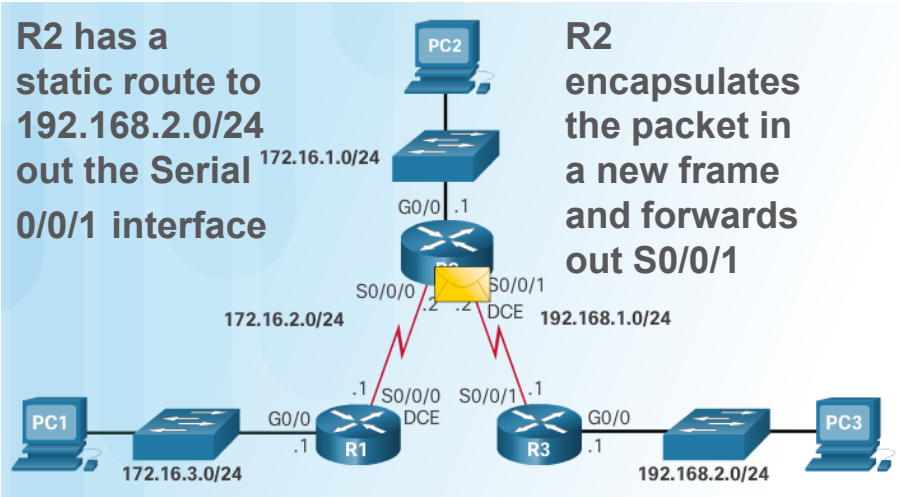
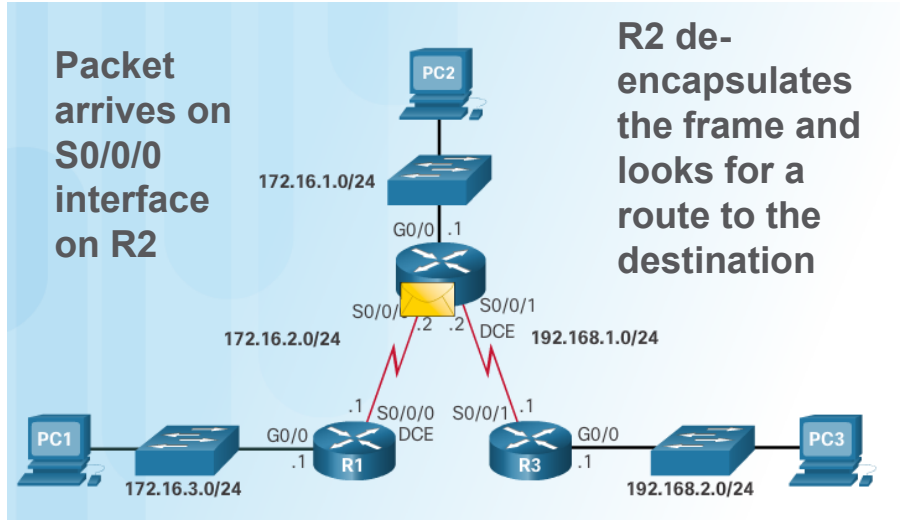

## Static Routes and Packet Forwarding (Cont.)

R3 de-encapsulates the frame and sees a connected route to 192.168.2.0/24 out G0/0

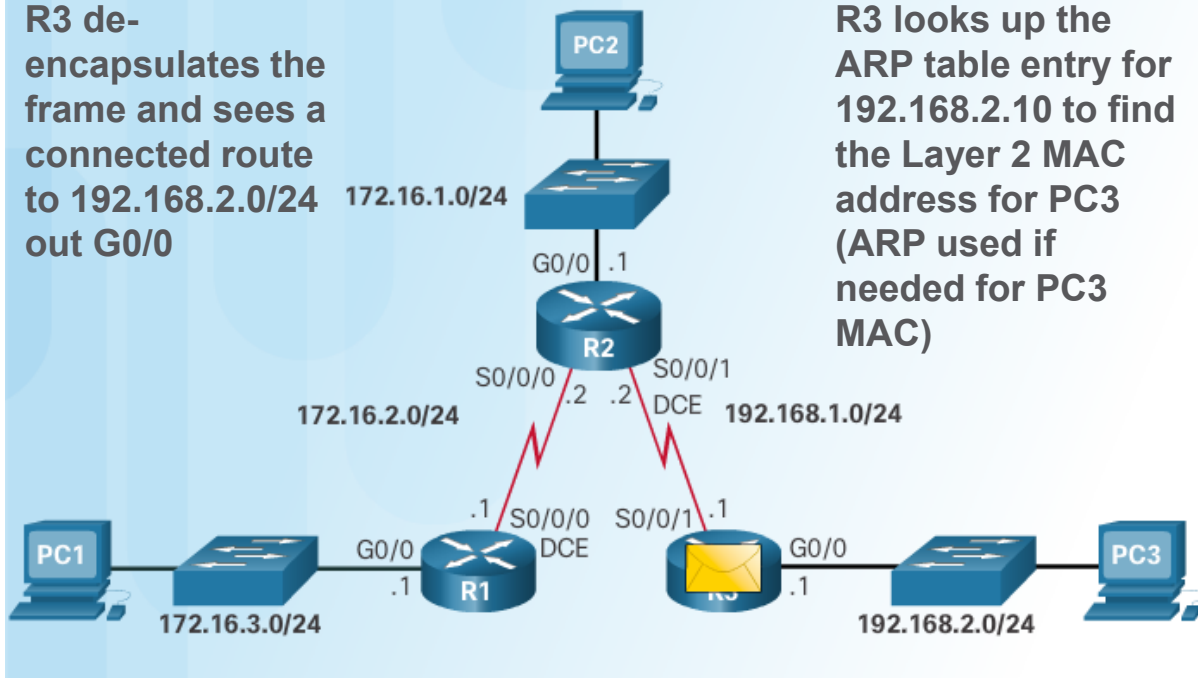

R3 looks up the ARP table entry for 192.168.2.10 to find the Layer 2 MAC address for PC3 (ARP used if needed for PC3 MAC)

- R3 encapsulates the packet in a new frame with the MAC address of the G0/0 interface as the source Layer 2 address and the MAC address of PC3 as the destination MAC address
- Frame is forwarded out of G0/0 interface and packet arrives on the NIC interface of PC3

# Troubleshoot IPv4 Static and Default Route Configuration

## Troubleshoot a Missing Route

- Common IOS troubleshooting commands include:
  - ping**
  - tracert**
  - show ip route**
  - show ip interface brief**
  - show cdp neighbors detail**

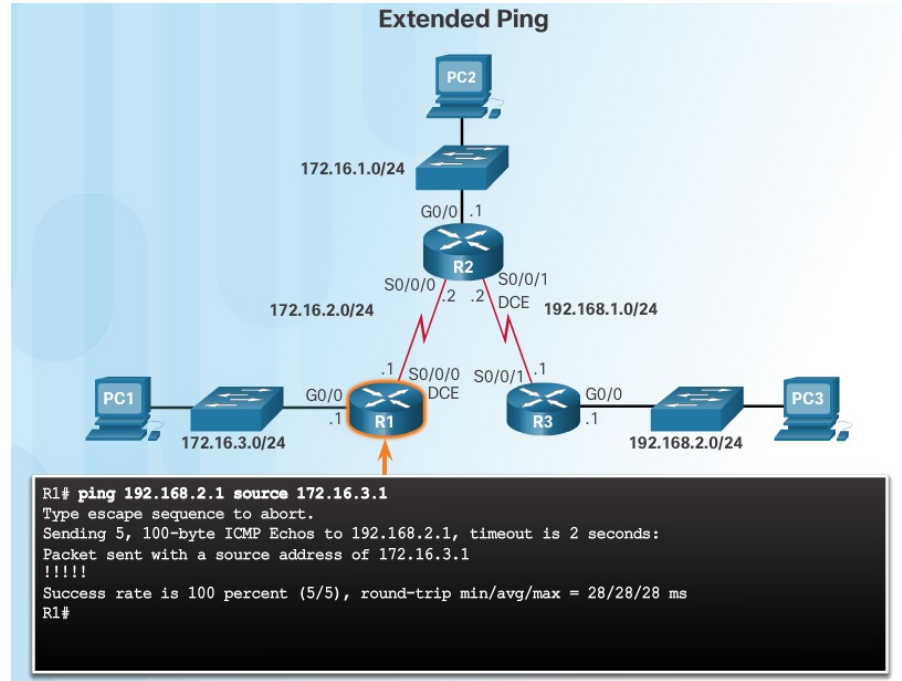

# Troubleshoot IPv4 Static and Default Route Configuration

## Troubleshoot a Missing Route (Cont.)

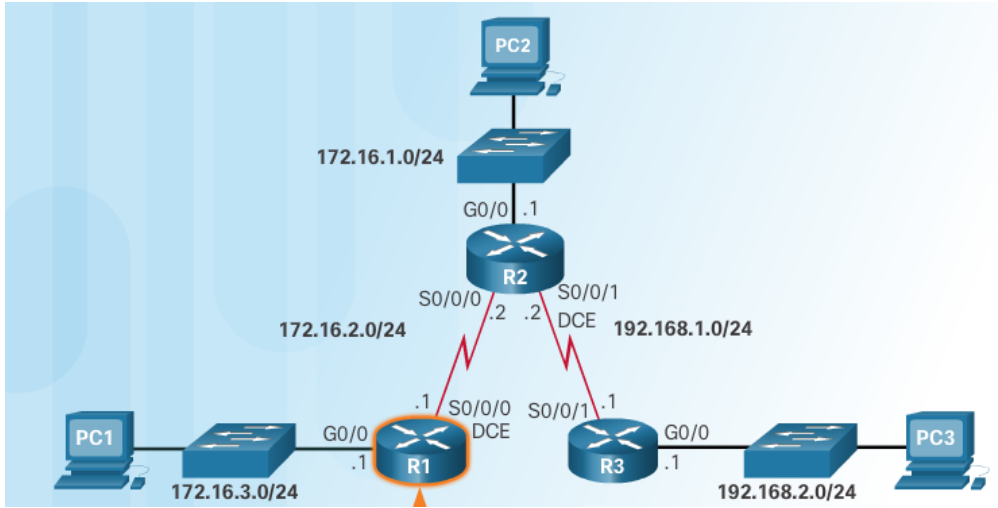

```

R1# show ip interface brief
Interface      IP-Address  OK? Method Status      Protocol
Embedded-Service-Engine0/0 unassigned YES unset  administratively down down
GigabitEthernet0/0  172.16.3.1 YES manual up          up
GigabitEthernet0/1  unassigned YES unset  administratively down down
Serial0/0/0        172.16.2.1 YES manual up          up
Serial0/0/1        unassigned YES unset  administratively down down
R1#
    
```

```

R1# traceroute 192.168.2.1
Type escape sequence to abort.
Tracing the route to 192.168.2.1
VRF info: (vrf in name/id, vrf out name/id)
 0 172.16.2.2 4 msec 4 msec 8 msec
 1 172.168.1.1 12 msec 12 msec *
R1#
    
```

```

R1# show ip route | begin Gateway
Gateway of last resort is not set

    172.16.0.0/16 is variably subnetted, 5 subnets, 2 masks
S   172.16.1.0/24 [1/0] via 172.16.2.2
C   172.16.2.0/24 is directly connected, Serial0/0/0
L   172.16.2.1/32 is directly connected, Serial0/0/0
C   172.16.3.0/24 is directly connected, GigabitEthernet0/0
L   172.16.3.1/32 is directly connected, GigabitEthernet0/0
L   172.16.3.1/32 is directly connected, GigabitEthernet0/0
S   192.168.1.0/24 [1/0] via 172.16.2.2
S   192.168.2.0/24 [1/0] via 172.16.2.2
R1#
    
```

```

R1# show cdp neighbors
Capability Codes: R - Router, T - Trans Bridge,
                  B - Source Route Bridge, S - Switch, H - Host,
                  I - IGMP, r - Repeater, P - Phone, D - Remote,
                  C - CVTVA, M - Two-port Mac Relay

Device ID    Local Intrfce   Holdtme    Capability   Platform    Port ID
netlab-cs5   Gig 0/0         156        S I          WS-C2960-   Fas 0/1
R2           Ser 0/0/0       153        R S I       CISCO1941   Ser 0/0/0
R1#
    
```



# Troubleshoot IPv4 Static and Default Route Configuration

## Solve a Connectivity Problem

### Verify Connectivity to the R3 LAN

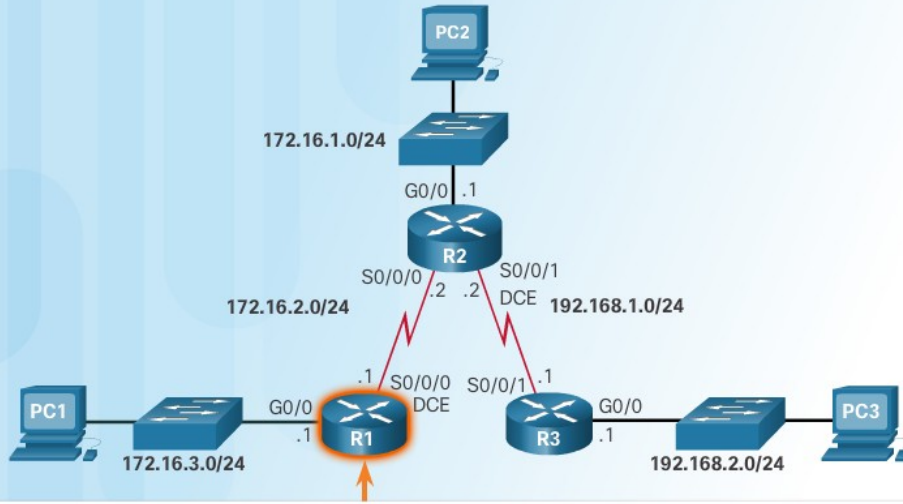

```
R1# ping 192.168.2.1 source g0/0
Type escape sequence to abort.
Sending 5, 100-byte ICMP Echos to 192.168.2.1, timeout is 2 seconds:
Packet sent with a source address of 172.16.3.1
.....
Success rate is 0 percent (0/5)
R1#
```

```
R1# traceroute 192.168.2.1
Type escape sequence to abort.
Tracing the route to 192.168.2.1
VRF info: (vrf in name/id, vrf out name/id)
 0 172.16.2.2 4 msec 4 msec 8 msec
 1 172.16.2.1 12 msec 12 msec 12 msec
 2 172.16.2.2 12 msec 8 msec 8 msec
 3 172.16.2.1 20 msec 16 msec 20 msec
 4 172.16.2.2 16 msec 16 msec 16 msec
 5 172.16.2.1 20 msec 20 msec 24 msec
 6 172.16.2.2 20 msec
 7 172.16.2.2 20 msec
```

**A traceroute reveals that R2 forwards the traceroute back to R1. R1 returns it to R2**

# Troubleshoot IPv4 Static and Default Route Configuration

## Solve a Connectivity Problem (Cont.)

### Verify the Routing Table

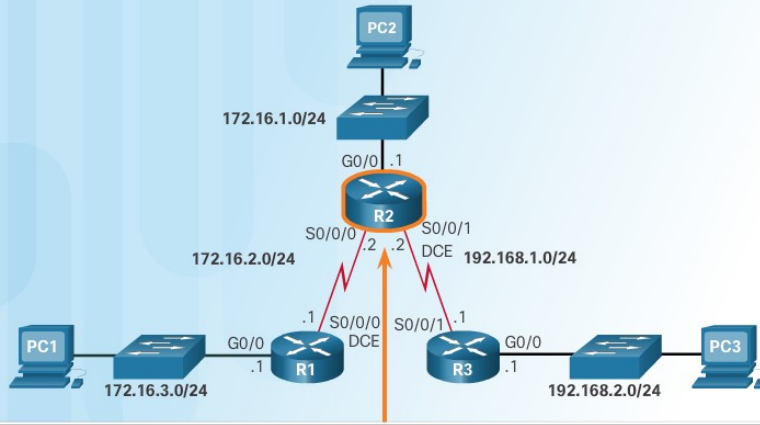

```
172.16.0.0/16 is variably subnetted, 5 subnets, 2 masks
C    172.16.1.0/24 is directly connected, GigabitEthernet0/0
L    172.16.1.1/32 is directly connected, GigabitEthernet0/0
C    172.16.2.0/24 is directly connected, Serial0/0/0
L    172.16.2.2/32 is directly connected, Serial0/0/0
S    172.16.3.0/24 is directly connected, Serial0/0/0
192.168.1.0/24 is variably subnetted, 2 subnets, 2 masks
C    192.168.1.0/24 is directly connected, Serial0/0/1
L    192.168.1.2/32 is directly connected, Serial0/0/1
S    192.168.2.0/24 [1/0] via 172.16.2.1
R2#
```

Static route to 192.168.2.0/24 has been configured using the next-hop address 172.16.2.1.

```
R2# show running-config | section ip route
ip route 172.16.3.0 255.255.255.0 172.16.2.1
ip route 192.168.2.0 255.255.255.0 172.16.2.1
R2#
R2# conf t
Enter configuration commands, one per line. End with CNTL/Z.
R2(config)# no ip route 192.168.2.0 255.255.255.0 172.16.2.1
R2(config)# ip route 192.168.2.0 255.255.255.0 192.168.1.1
R2(config)#
```

Incorrect route is removed and the correct route is then entered

```
R1# ping 192.168.2.1 source g0/0
Type escape sequence to abort.
Sending 5, 100-byte ICMP Echos to 192.168.2.1, timeout is 2 seconds:
Packet sent with a source address of 172.16.3.1
!!!!
Success rate is 100 percent (5/5), round-trip min/avg/max = 28/28/28 ms
R1#
```

# Troubleshoot IPv4 Static and Default Route Configuration

## Packet Tracer – Troubleshooting Static Routes



Cisco Networking Academy®

Mind Wide Open™

### Packet Tracer - Troubleshooting Static Routes

#### Topology

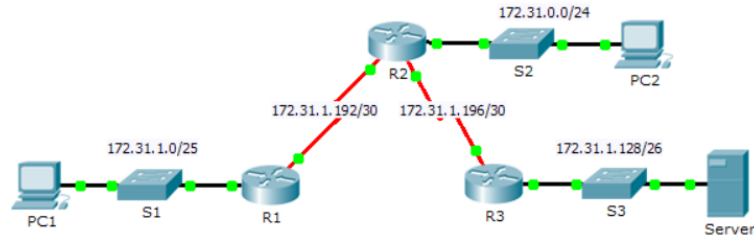

#### Addressing Table

Device	Interface	IPv4 Address	Subnet Mask	Default Gateway
R1	G0/0	172.31.1.1	255.255.255.128	N/A
	S0/0/0	172.31.1.194	255.255.255.252	N/A
R2	G0/0	172.31.0.1	255.255.255.0	N/A
	S0/0/0	172.31.1.193	255.255.255.252	N/A
	S0/0/1	172.31.1.197	255.255.255.252	N/A
R3	G0/0	172.31.1.129	255.255.255.192	N/A
	S0/0/1	172.31.1.198	255.255.255.252	N/A
PC1	NIC	172.31.1.126	255.255.255.128	172.31.1.1

# Troubleshoot IPv4 Static and Default Route Configuration

## Lab – Troubleshooting Static Routes



Cisco Networking Academy®

Mind Wide Open™

### Lab – Troubleshooting IPv4 and IPv6 Static Routes

#### Topology

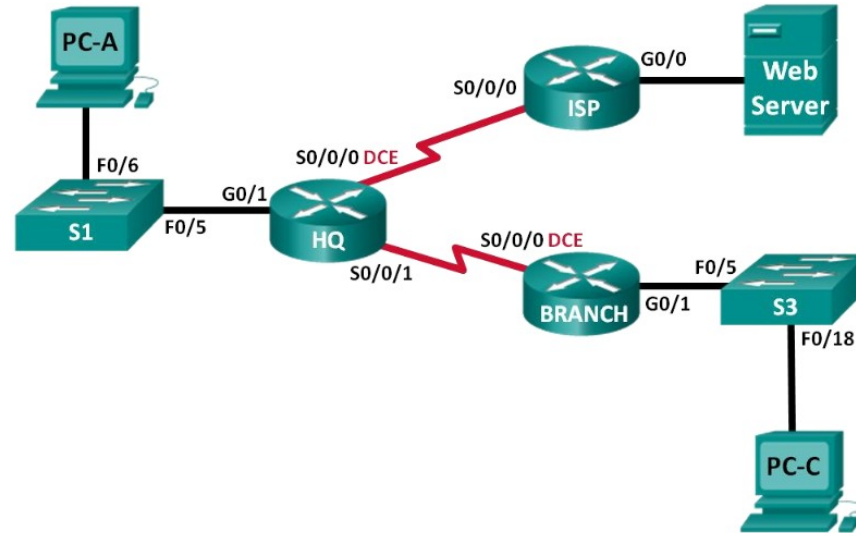

# 2.4 Chapter Summary

## Chapter 2: Static Routing

- Explain how static routes are implemented in a small to medium-sized business network.
- Configure static routes to enable connectivity in a small to medium-sized business network.
- Troubleshoot static and default route configurations.

