



Chapter 6: VLANs

Instructor Materials

CCNA Routing and Switching

Routing and Switching Essentials v6.0



Chapter 6: VLANs

Routing and Switching Essentials v6.0
Planning Guide

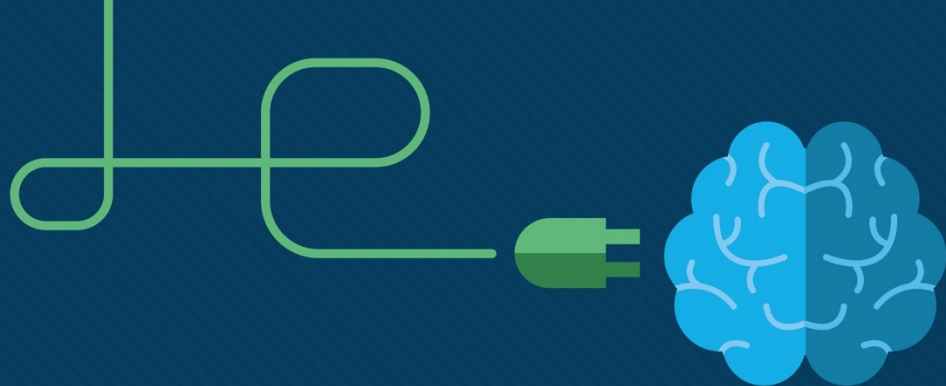

Chapter 6: VLANs

CCNA Routing and Switching

Routing and Switching Essentials v6.0



Chapter 6 - Sections & Objectives

- 6.1 VLAN Segmentation
 - Explain the purpose of VLANs in a switched network.
 - Explain how a switch forwards frames based on VLAN configuration in a multi-switch environment.
- 6.2 VLAN Implementations
 - Configure a switch port to be assigned to a VLAN based on requirements.
 - Configure a trunk port on a LAN switch.
 - Troubleshoot VLAN and trunk configurations in a switched network.
- 6.3 Inter-VLAN Routing Using Routers
 - Describe the two options for configuring Inter-VLAN routing.
 - Configure legacy Inter-VLAN Routing.
 - Configure Router-on-a-Stick Inter-VLAN Routing

6.1 VLAN Segmentation

VLAN Definitions

- VLANs can segment LAN devices without regard for the physical location of the user or device.
 - In the figure, IT users on the first, second, and third floors are all on the same LAN segment. The same is true for HR and Sales users.
- A VLAN is a logical partition of a Layer 2 network.
 - Multiple partitions can be created and multiple VLANs can co-exist.
 - The partitioning of the Layer 2 network takes place inside a Layer 2 device, usually via a switch.
 - Each VLAN is a broadcast domain that can span multiple physical LAN segments.
 - Hosts on the same VLAN are unaware of the VLAN's existence.

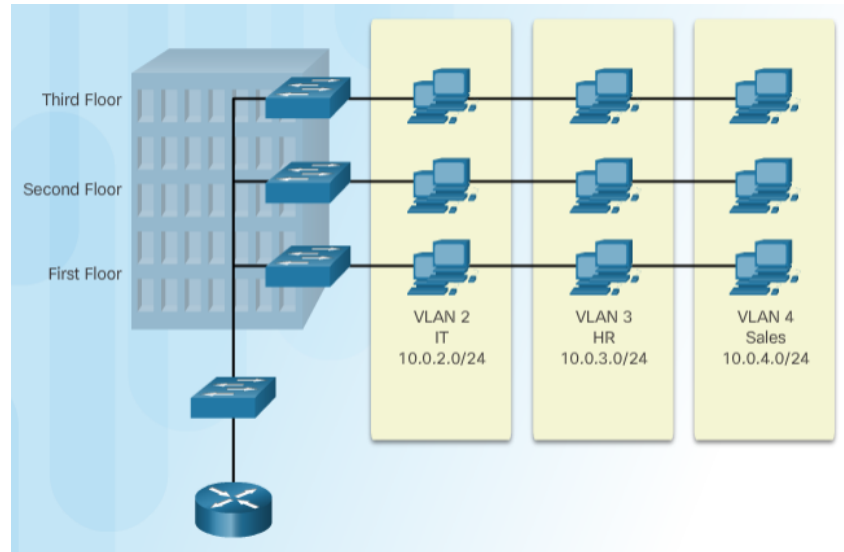

- VLANs are mutually isolated and packets can only pass between VLANs via a router.

Benefits of VLANs

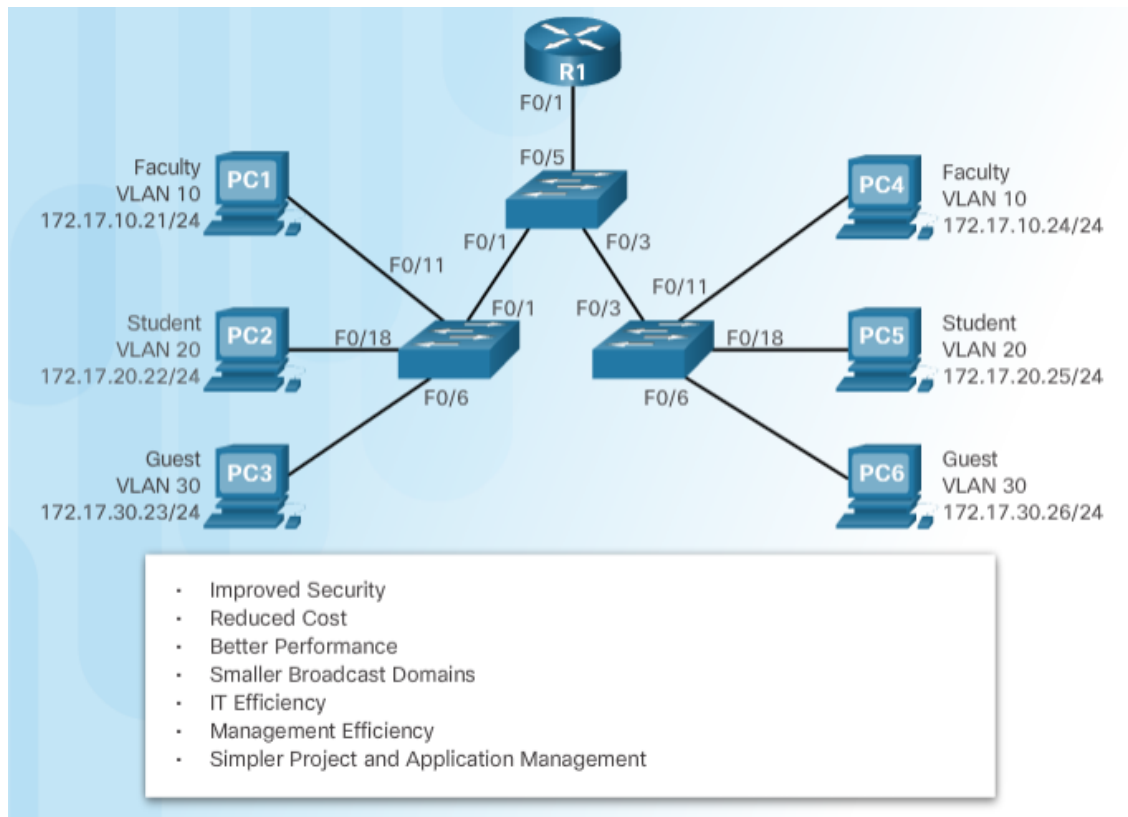

Types of VLANs

- Common types of VLANs:
 - Default VLAN** – Also known as VLAN 1. All switch ports are members of VLAN 1 by default.
 - Data VLAN** – Data VLANs are commonly created for specific groups of users or devices. They carry user generated traffic.
 - Native VLAN** – This is the VLAN that carries all untagged traffic. This is traffic that does not originate from a VLAN port (e.g., STP BPDU traffic exchanged between STP enabled switches). The native VLAN is VLAN 1 by default.
 - Management VLAN** – This is a VLAN that is created to carry network management traffic including SSH, SNMP, Syslog, and more. VLAN 1 is the default VLAN used for network management.

Default VLAN Assignment

```
Switch# show vlan brief
```

VLAN	Name	Status	Ports
1	default	active	Fa0/1, Fa0/2, Fa0/3, Fa0/4 Fa0/5, Fa0/6, Fa0/7, Fa0/8 Fa0/9, Fa0/10, Fa0/11, Fa0/12 Fa0/13, Fa0/14, Fa0/15, Fa0/16 Fa0/17, Fa0/18, Fa0/19, Fa0/20 Fa0/21, Fa0/22, Fa0/23, Fa0/24 Gi0/1, Gi0/2
1002	fddi-default	act/unsup	
1003	token-ring-default	act/unsup	
1004	fddinet-default	act/unsup	
1005	trnet-default	act/unsup	

Initially, all switch ports are members of VLAN 1.

Voice VLANs

- To support time-sensitive voice traffic, Cisco switches support a voice VLAN that requires:
 - Assured bandwidth
 - Delay of less than 150 ms across the network to ensure voice quality
 - Transmission priority over other types of network traffic
 - Ability to be routed around congested areas on the network.

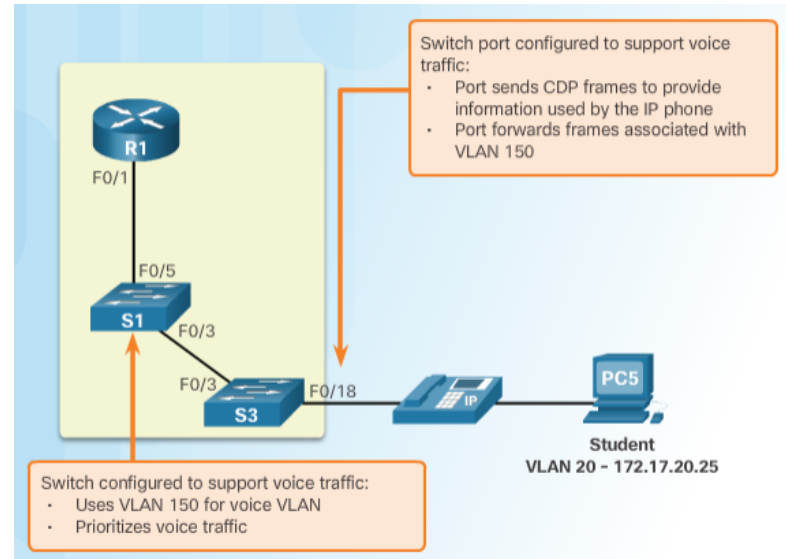

- The voice VLAN feature enables access ports to carry user and IP voice traffic.
 - In the figure, the S3 F0/18 interface has been configured to tag student traffic on VLAN 20 and voice traffic on VLAN 150.

Packet Tracer – Who Hears the Broadcast?



Packet Tracer – Who Hears the Broadcast?

Topology

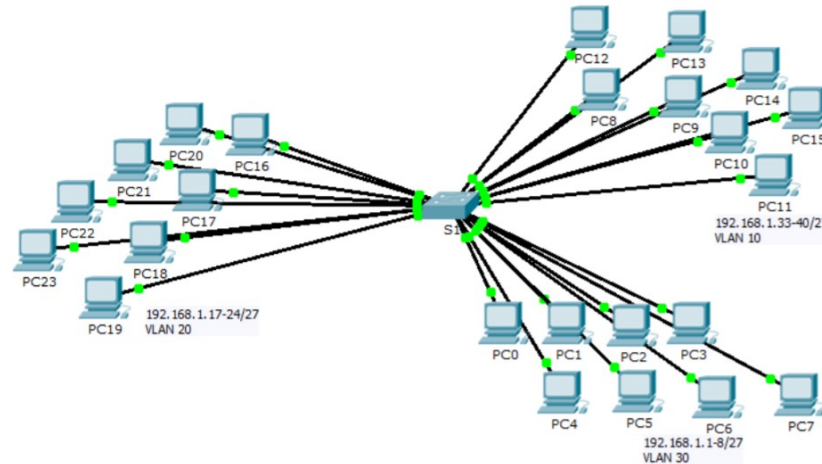

Objectives

Part 1: Observe Broadcast Traffic in a VLAN Implementation

Part 2: Complete Review Questions

Scenario

In this activity, a 24-port Catalyst 2960 switch is fully populated. All ports are in use. You will observe broadcast traffic in a VLAN implementation and answer some reflection questions.

VLANs in a Multi-Switched Environment

VLAN Trunks

- A VLAN trunk is a point-to-point link that carries more than one VLAN.
 - Usually established between switches to support intra VLAN communication.
 - A VLAN trunk or trunk ports are not associated to any VLANs.
- Cisco IOS supports IEEE 802.1q, a popular VLAN trunk protocol.

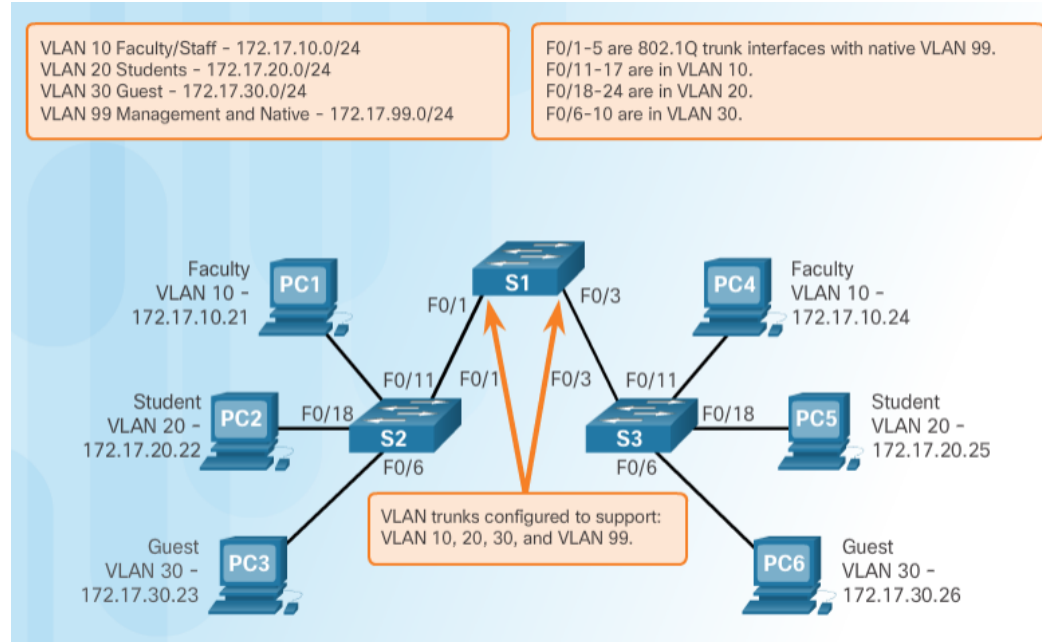

The links between switches S1 and S2, and S1 and S3 are configured to transmit traffic coming from VLANs 10, 20, 30, and 99 across the network.

Controlling Broadcast Domains with VLANs

- If a switch port receives a broadcast frame, it forwards it out all ports except the originating port.
 - Eventually the entire network receives the broadcast because the network is one broadcast domain.
- VLANs can be used to limit the reach of broadcast frames because each VLAN is a broadcast domain.
 - VLANs help control the reach of broadcast frames and their impact in the network.
- In the figure, PC1 on VLAN 10 sends a broadcast frame.
 - Trunk links between S2 - S1 and S1 - S3 propagate the broadcast to other devices in VLAN 10.
 - Only devices in the same VLAN receive the broadcast therefore, PC4 would receive the broadcast.

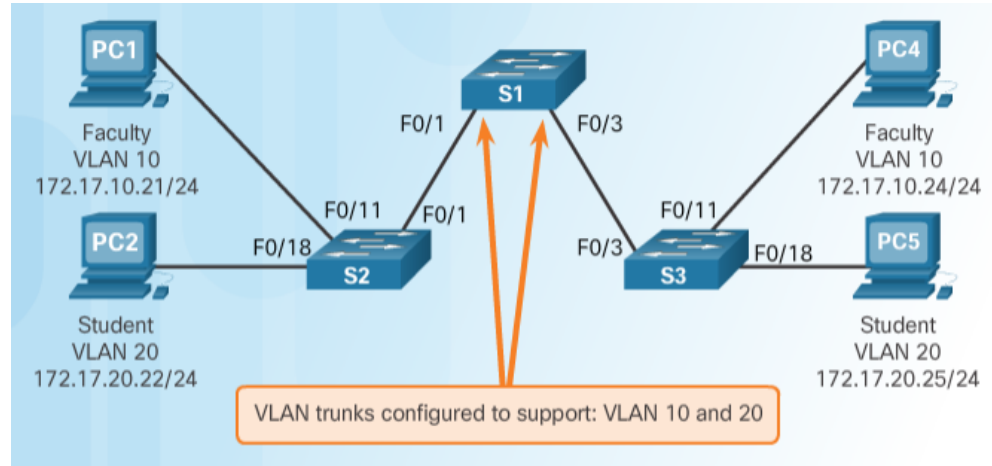

Tagging Ethernet Frames for VLAN Identification

- Before a frame is forwarded across a trunk link, it must be tagged with its VLAN information.
 - Frame tagging is the process of adding a VLAN identification header to the frame.
 - It is used to properly transmit multiple VLAN frames through a trunk link.
- IEEE 802.1Q is a very popular VLAN trunking protocol that defines the structure of the tagging header added to the frame.
 - Switches add VLAN tagging information after the Source MAC address field.
 - The fields in the 802.1Q VLAN tag includes VLAN ID (VID).
 - Trunk links add the tag information before sending the frame and then remove the tags before forwarding frames through non-trunk ports.

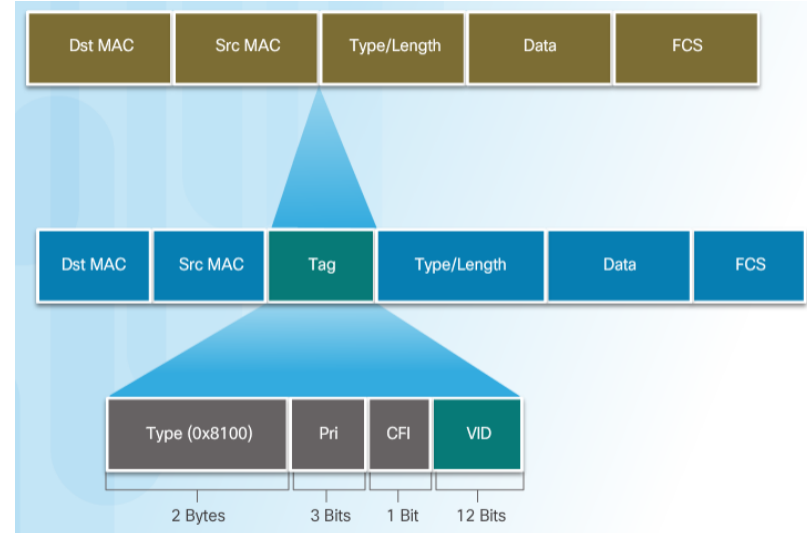

VLANs in a Multi-Switched Environment

Native VLANs and 802.1Q Tagging

- Control traffic sent on the native VLAN should not be tagged.
- Frames received untagged, remain untagged and are placed in the native VLAN when forwarded.
- If there are no ports associated to the native VLAN and no other trunk links, an untagged frame is dropped.
- When configuring a switch port on a Cisco switch, configure devices so that they do not send tagged frames on the native VLAN.
- In Cisco switches, the native VLAN is VLAN 1, by default.

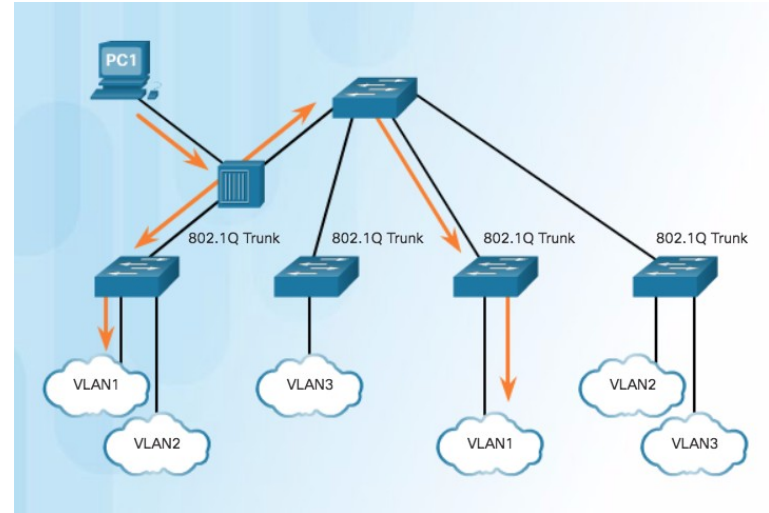

VLANs in a Multi-Switched Environment

Voice VLAN Tagging

- An access port connecting a Cisco IP phone can be configured to use two separate VLANs:
 - A VLAN for voice traffic
 - A VLAN for data traffic from a device attached to the phone.
- The link between the switch and the IP phone behaves like a trunk to carry traffic from both VLANs.

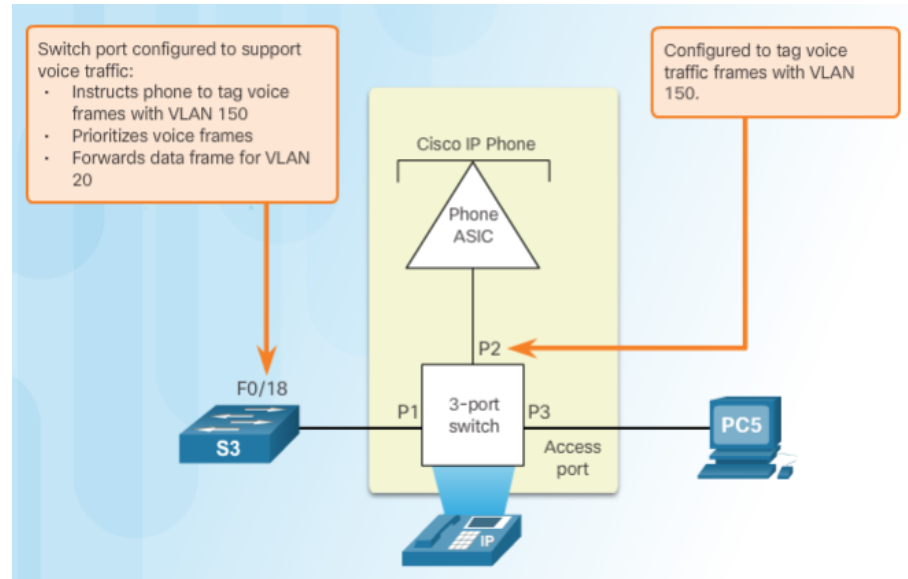

- Cisco IP Phone contains an integrated three-port 10/100 switch dedicated to these devices:
 - Port 1 connects to the switch or other VoIP device.
 - Port 2 is an internal 10/100 interface that carries the IP phone traffic.
 - Port 3 (access port) connects to a PC or other device.

Packet Tracer – Investigating a VLAN Implementation



Packet Tracer – Investigating a VLAN Implementation

Topology

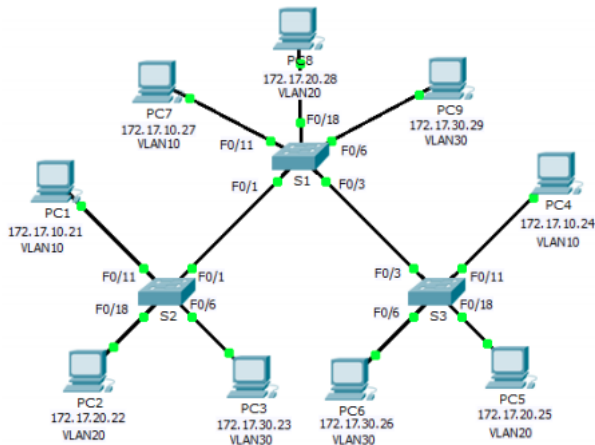

Addressing Table

Device	Interface	IP Address	Subnet Mask	Default Gateway
S1	VLAN 99	172.17.99.31	255.255.255.0	N/A
S2	VLAN 99	172.17.99.32	255.255.255.0	N/A
S3	VLAN 99	172.17.99.33	255.255.255.0	N/A

6.2 VLAN Implementation

VLAN Ranges on Catalyst Switches

- VLANs are split into two categories:
 - **Normal range VLANs**
 - VLAN numbers from 1 to 1,005
 - Configurations stored in the vlan.dat (in the flash memory)
 - IDs 1002 through 1005 are reserved for legacy Token Ring and Fiber Distributed Data Interface (FDDI) VLANs, automatically created and cannot be removed.
 - **Extended Range VLANs**
 - VLAN numbers from 1,006 to 4,096
 - Configurations stored in the running configuration (NVRAM)
 - VLAN Trunking Protocol (VTP) does not learn extended VLANs

- Cisco Catalyst 2960 and 3560 Series switches support over 4,000 VLANs.

```
Switch# show vlan brief
```

VLAN	Name	Status	Ports
1	default	active	Fa0/1, Fa0/2, Fa0/3, Fa0/4 Fa0/5, Fa0/6, Fa0/7, Fa0/8 Fa0/9, Fa0/10, Fa0/11, Fa0/12 Fa0/13, Fa0/14, Fa0/15, Fa0/16 Fa0/17, Fa0/18, Fa0/19, Fa0/20 Fa0/21, Fa0/22, Fa0/23, Fa0/24 Gi0/1, Gi0/2
1002	fddi-default	act/unsup	
1003	token-ring-default	act/unsup	
1004	fddinet-default	act/unsup	
1005	trnet-default	act/unsup	

Creating a VLAN

Cisco Switch IOS Commands

Enter global configuration mode.	<code>S1# configure terminal</code>
Create a VLAN with a valid id number.	<code>S1(config)# vlan vlan-id</code>
Specify a unique name to identify the VLAN.	<code>S1(config-vlan)# name vlan-name</code>
Return to the privileged EXEC mode.	<code>S1(config-vlan)# end</code>

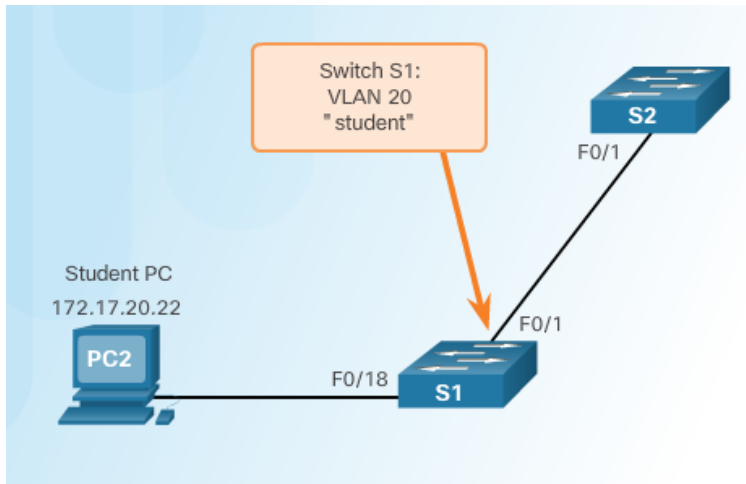

```
S1# configure terminal
S1(config)# vlan 20
S1(config-vlan)# name student
S1(config-vlan)# end
```

Assigning Ports to VLANs

Cisco Switch IOS Commands

Enter global configuration mode.	S1# configure terminal
Enter interface configuration mode.	S1(config)# interface interface_id
Set the port to access mode.	S1(config-if)# switchport mode access
Assign the port to a VLAN.	S1(config-if)# switchport access vlan vlan_id
Return to the privileged EXEC mode.	S1(config-if)# end

Example 1

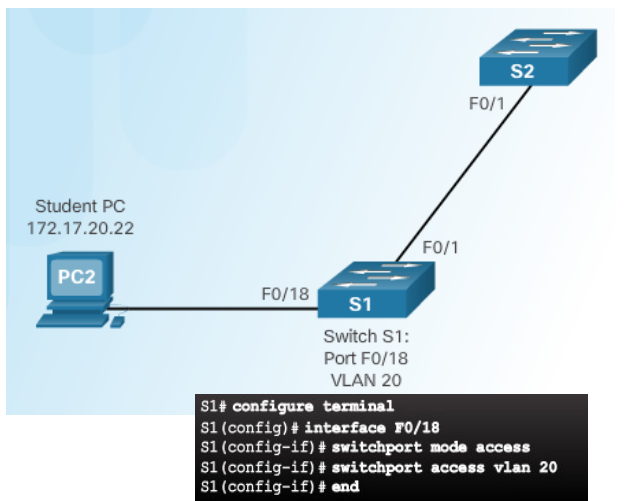

Example 2

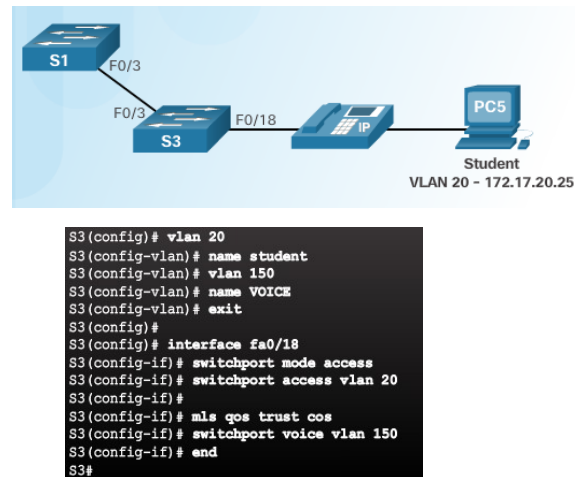

Changing VLAN Port Membership

- Remove VLAN Assignment

Cisco Switch IOS Commands

Enter global configuration mode.	S1# <code>configure terminal</code>
Enter interface configuration mode	S1(config)# <code>interface F0/18</code>
Remove the VLAN assignment from the port.	S1(config-if)# <code>no switchport access vlan</code>
Return to the privileged EXEC mode.	S1(config-if)# <code>end</code>

Even though interface F0/18 was previously assigned to VLAN 20, it reset to the default VLAN1.



```
S1(config)# int F0/18
S1(config-if)# no switchport access vlan
S1(config-if)# end
S1# show vlan brief
```

VLAN	Name	Status	Ports
1	default	active	Fa0/1, Fa0/2, Fa0/3, Fa0/4 Fa0/5, Fa0/6, Fa0/7, Fa0/8 Fa0/9, Fa0/10, Fa0/11, Fa0/12 Fa0/13, Fa0/14, Fa0/15, Fa0/16 Fa0/17, Fa0/18, Fa0/19, Fa0/20 Fa0/21, Fa0/22, Fa0/23, Fa0/24 Gi0/1, Gi0/2
20	student	active	
1002	fddi-default	act/unsup	
1003	token-ring-default	act/unsup	
1004	fddinet-default	act/unsup	
1005	trnet-default	act/unsup	

```
S1#
```

VLAN Assignment

Deleting VLANs

- Use the **no vlan *vlan-id*** global configuration mode command to remove VLAN.

```
S1# conf t
S1(config)# no vlan 20
S1(config)# end
S1#
S1# sh vlan brief
```

VLAN	Name	Status	Ports
1	default	active	Fa0/1, Fa0/2, Fa0/3, Fa0/4 Fa0/5, Fa0/6, Fa0/7, Fa0/8 Fa0/9, Fa0/10, Fa0/12, Fa0/13 Fa0/14, Fa0/15, Fa0/16, Fa0/17 Fa0/18, Fa0/19, Fa0/20, Fa0/21 Fa0/22, Fa0/23, Fa0/24, Gi0/1 Gi0/2
1002	fddi-default	act/unsup	
1003	token-ring-default	act/unsup	
1004	fddinet-default	act/unsup	
1005	trnet-default	act/unsup	

```
S1#
```

- To delete the entire `vlan.dat` file, use the **delete flash:vlan.dat** privileged EXEC mode command.
 - delete vlan.dat** can be used if the `vlan.dat` file has not been moved from its default location.

Verifying VLAN Information

- VLAN configurations can be validated using the Cisco IOS **show vlan** and **show interfaces** command options.

```
S1# show vlan name student

VLAN Name                Status    Ports
-----
20 student                active    Fa0/11, Fa0/18

VLAN Type SAID MTU Parent RingNo BridgeNo Stp BrdgMode Trans1 Trans2
-----
20 enet 100020 1500 - - - - - 0 0

Remote SPAN VLAN
-----
Disabled

Primary Secondary Type          Ports
-----
S1# show vlan summary
Number of existing VLANs          : 7
Number of existing VTP VLANs     : 7
Number of existing extended VLANs : 0

S1#
```

```
S1# show interfaces vlan 20
Vlan20 is up, line protocol is down
Hardware is EtherSVI, address is 001c.57ec.0641 (bia 001c.57ec.0641)
MTU 1500 bytes, BW 1000000 Kbit, DLY 10 usec,
    reliability 255/255, txload 1/255, rxload 1/255
Encapsulation ARPA, loopback not set
ARP type: ARPA, ARP Timeout 04:00:00
Last input never, output never, output hang never
Last clearing of "show interface" counters never
Input queue: 0/75/0/0 (size/max/drops/flushes); Total output drops: 0
Queueing strategy: fifo
Output queue: 0/40 (size/max)
5 minute input rate 0 bits/sec, 0 packets/sec
5 minute output rate 0 bits/sec, 0 packets/sec
  0 packets input, 0 bytes, 0 no buffer
Received 0 broadcasts (0 IP multicast)
  0 runts, 0 giants, 0 throttles
  0 input errors, 0 CRC, 0 frame, 0 overrun, 0 ignored
  0 packets output, 0 bytes, 0 underruns
  0 output errors, 0 interface resets
  0 output buffer failures, 0 output buffers swapped out
```

VLAN Assignment

Packet Tracer – Configuring VLANs



Cisco Networking Academy®

Mind Wide Open™

Packet Tracer – Configuring VLANs

Topology

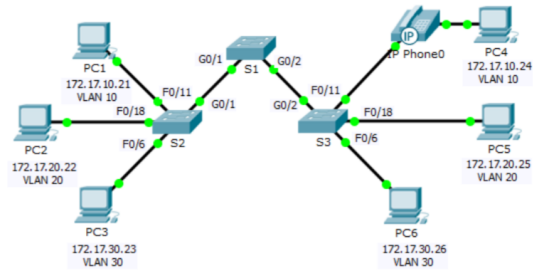

Addressing Table

Device	Interface	IP Address	Subnet Mask	VLAN
PC1	NIC	172.17.10.21	255.255.255.0	10
PC2	NIC	172.17.20.22	255.255.255.0	20
PC3	NIC	172.17.30.23	255.255.255.0	30
PC4	NIC	172.17.10.24	255.255.255.0	10
PC5	NIC	172.17.20.25	255.255.255.0	20
PC6	NIC	172.17.30.26	255.255.255.0	30

Objectives

Part 1: Verify the Default VLAN Configuration

Part 2: Configure VLANs

Part 3: Assign VLANs to Ports

Background

VLANs are helpful in the administration of logical groups, allowing members of a group to be easily moved, changed, or added. This activity focuses on creating and naming VLANs, and assigning access ports to specific VLANs.



Configuring IEEE 802.1q Trunk Links

Cisco Switch IOS Commands

Enter global configuration mode.	<code>S1# configure terminal</code>
Enter interface configuration mode.	<code>S1(config)# interface interface_id</code>
Force the link to be a trunk link.	<code>S1(config-if)# switchport mode trunk</code>
Specify a native VLAN for untagged frames.	<code>S1(config-if)# switchport trunk native vlan vlan_id</code>
Specify the list of VLANs to be allowed on the trunk link.	<code>S1(config-if)# switchport trunk allowed vlan vlan-list</code>
Return to the privileged EXEC mode.	<code>S1(config-if)# end</code>

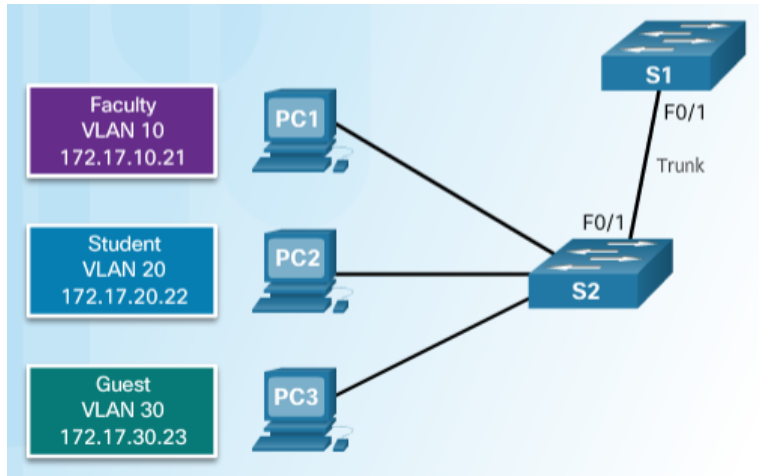

Native VLAN
VLAN 99
172.17.99.0/24

```
S1(config)# interface FastEthernet0/1
S1(config-if)# switchport mode trunk
S1(config-if)# switchport trunk native vlan 99
S1(config-if)# switchport trunk allowed vlan 10,20,30,99
S1(config-if)# end
```

Resetting the Trunk to Default State

Cisco Switch IOS Commands

Enter global configuration mode.	S1# configure terminal
Enter interface configuration mode.	S1(config)# interface interface_id
Set trunk to allow all VLANs.	S1(config-if)# no switchport trunk allowed vlan
Reset native VLAN to default.	S1(config-if)# no switchport trunk native vlan
Return to the privileged EXEC mode.	S1(config-if)# end

```
S1(config)# interface f0/1
S1(config-if)# no switchport trunk allowed vlan
S1(config-if)# no switchport trunk native vlan
S1(config-if)# end
S1# show interfaces f0/1 switchport
Name: Fa0/1
Switchport: Enabled
Administrative Mode: trunk
Operational Mode: trunk
Administrative Trunking Encapsulation: dot1q
Operational Trunking Encapsulation: dot1q
Negotiation of Trunking: On
Access Mode VLAN: 1 (default)
Trunking Native Mode VLAN: 1 (default)
Administrative Native VLAN tagging: enabled
<output omitted>
Administrative private-vlan trunk mappings: none
Operational private-vlan: none
Trunking VLANs Enabled: ALL
Pruning VLANs Enabled: 2-1001
<output omitted>
```

F0/1 is configured as an access port which removes the trunk feature.

```
S1(config)# interface f0/1
S1(config-if)# switchport mode access
S1(config-if)# end
S1# show interfaces f0/1 switchport
Name: Fa0/1
Switchport: Enabled
Administrative Mode: static access
Operational Mode: static access
Administrative Trunking Encapsulation: dot1q
Operational Trunking Encapsulation: native
Negotiation of Trunking: Off
Access Mode VLAN: 1 (default)
Trunking Native Mode VLAN: 1 (default)
Administrative Native VLAN tagging: enabled
<output omitted>
```

Verifying Trunk Configuration

```
S1(config)# interface f0/1
S1(config-if)# switchport mode trunk
S1(config-if)# switchport trunk native vlan 99
S1(config-if)# end
S1# show interfaces f0/1 switchport
Name: Fa0/1
Switchport: Enabled
Administrative Mode: trunk
Operational Mode: trunk
Administrative Trunking Encapsulation: dot1q
Operational Trunking Encapsulation: dot1q
Negotiation of Trunking: On
Access Mode VLAN: 1 (default)
Trunking Native Mode VLAN: 99 (VLAN0099)
Administrative Native VLAN tagging: enabled
Voice VLAN: none
Administrative private-vlan host-association: none
Administrative private-vlan mapping: none
Administrative private-vlan trunk native VLAN: none
Administrative private-vlan trunk Native VLAN tagging: enabled
Administrative private-vlan trunk encapsulation: dot1q
Administrative private-vlan trunk normal VLANs: none
Administrative private-vlan trunk associations: none
Administrative private-vlan trunk mappings: none
Operational private-vlan: none
Trunking VLANs Enabled: ALL
Pruning VLANs Enabled: 2-1001
<output omitted>
```

Packet Tracer – Configuring Trunks



Packet Tracer – Configuring Trunks

Topology

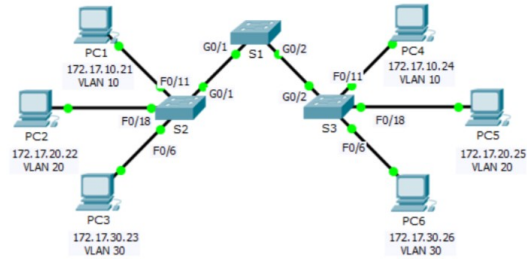

Addressing Table

Device	Interface	IP Address	Subnet Mask	Switch Port	VLAN
PC1	NIC	172.17.10.21	255.255.255.0	S2 F0/11	10
PC2	NIC	172.17.20.22	255.255.255.0	S2 F0/18	20
PC3	NIC	172.17.30.23	255.255.255.0	S2 F0/6	30
PC4	NIC	172.17.10.24	255.255.255.0	S3 F0/11	10
PC5	NIC	172.17.20.25	255.255.255.0	S3 F0/18	20
PC6	NIC	172.17.30.26	255.255.255.0	S3 F0/6	30

Objectives

Part 1: Verify VLANs

Part 2: Configure Trunks

Background

Trunks are required to pass VLAN information between switches. A port on a switch is either an access port or a trunk port. Access ports carry traffic from a specific VLAN assigned to the port. A trunk port by default is a member of all VLANs; therefore, it carries traffic for all VLANs. This activity focuses on creating trunk ports, and assigning them to a native VLAN other than the default.

Lab – Configuring VLANs and Trunks

Cisco Networking Academy™
Mind Wide Open™

Lab - Configuring VLANs and Trunking

Topology

Addressing Table

Device	Interface	IP Address	Subnet Mask	Default Gateway
S1	VLAN 1	192.168.1.11	255.255.255.0	N/A
S2	VLAN 1	192.168.1.12	255.255.255.0	N/A
PC-A	NIC	192.168.10.3	255.255.255.0	192.168.10.1
PC-B	NIC	192.168.10.4	255.255.255.0	192.168.10.1
PC-C	NIC	192.168.20.3	255.255.255.0	192.168.20.1

Objectives

- Part 1: Build the Network and Configure Basic Device Settings
- Part 2: Create VLANs and Assign Switch Ports
- Part 3: Maintain VLAN Port Assignments and the VLAN Database
- Part 4: Configure an 802.1Q Trunk between the Switches
- Part 5: Delete the VLAN Database

Background / Scenario

Modern switches use virtual local-area networks (VLANs) to improve network performance by separating large Layer 2 broadcast domains into smaller ones. VLANs can also be used as a security measure by controlling which hosts can communicate. In general, VLANs make it easier to design a network to support the goals of an organization.

IP Addressing Issues with VLANs

- Common practice to associate a VLAN with an IP network.
 - Different IP networks must communicate through a router.
 - All devices within a VLAN must be part of the same IP network to communicate.
- In the figure, PC1 cannot communicate to the server because it has a wrong IP address configured.

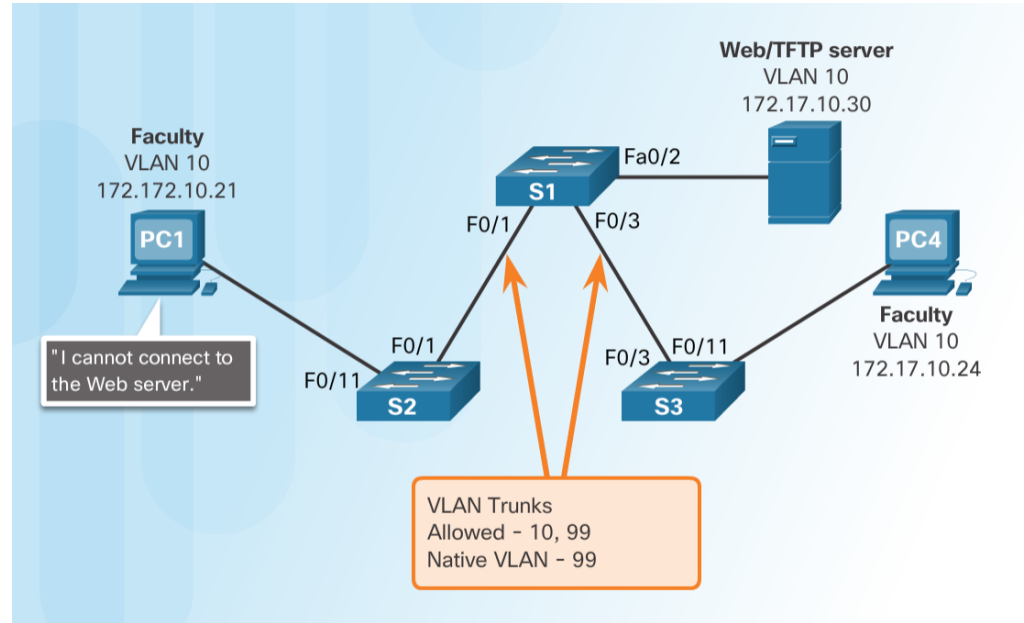

Troubleshoot VLANs and Trunks

Missing VLANs

- If all the IP address mismatches have been solved, but the device still cannot connect, check if the VLAN exists in the switch.

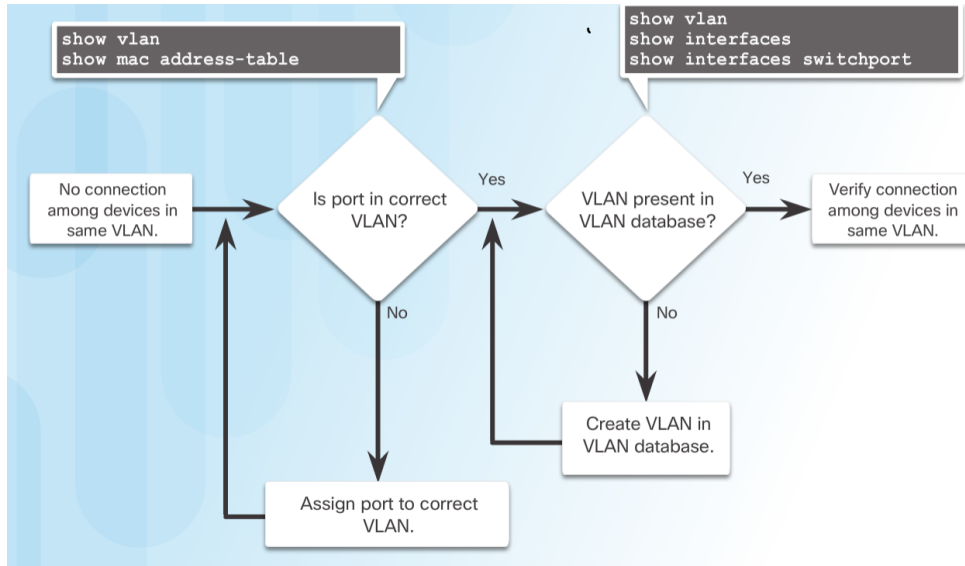

If the VLAN to which the port belongs is deleted, the port becomes inactive and is unable to communicate with the rest of the network.

- It is not functional until the missing VLAN is created or the VLAN is removed from the port.

```
S1# show interfaces FastEthernet 0/1 switchport
Name: Fa0/1
Switchport: Enabled
Administrative Mode: static access
Operational Mode: static access
Administrative Trunking Encapsulation: dot1q
Operational Trunking Encapsulation: native
Negotiation of Trunking: Off
Access Mode VLAN: 10 (Inactive)
Trunking Native Mode VLAN: 1 (default)
Administrative Native VLAN tagging: enabled
Voice VLAN: none
```

Introduction to Troubleshooting Trunks

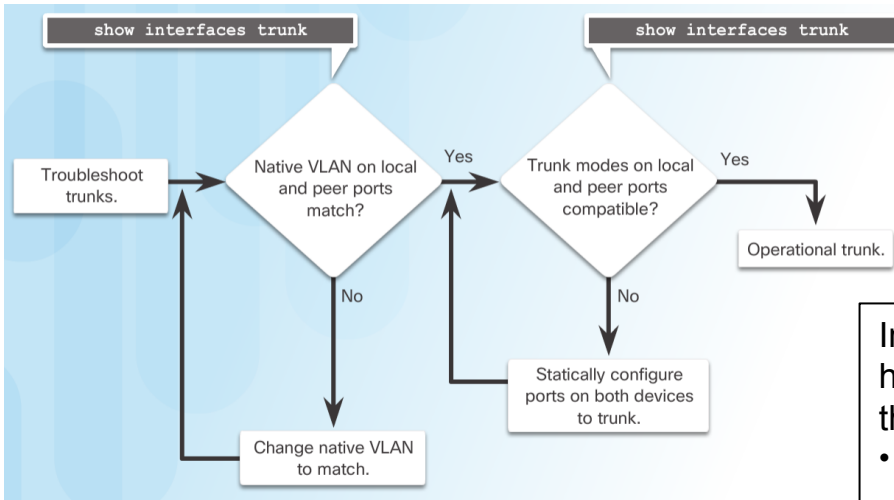

In this example, the Native VLAN should be VLAN 99 however, the output of the command identifies VLAN 2 as the Native VLAN.

- To solve this problem, configure the same native VLAN on both sides.

```
SW1# show interfaces f0/1 trunk
```

Port	Mode	Encapsulation	Status	Native vlan
Fa0/1	auto	802.1q	trunking	2

```
<output omitted>
```

Common Problems with Trunks

- Trunking issues are usually associated with incorrect configurations.
- The most common type of trunk configuration errors are:

Problem	Result	Example
Native VLAN Mismatches	Poses a security risk and creates unintended results.	For example, one port is defined as VLAN 99 and the other is defined as VLAN 100.
Trunk Mode Mismatches	Causes loss of network connectivity.	For example, one side of the trunk is configured as an access port.
Allowed VLANs on Trunks	Causes unexpected traffic or no traffic to be sent over the trunk.	The list of allowed VLANs does not support current VLAN trunking requirements.

- When a trunk problem is suspected, it is recommended to troubleshoot in the order shown above.

Incorrect Port Mode

- In this example, PC4 cannot reach the Web server.
- The trunk links on S1 and S3 are verified and reveal that the S3 trunk port has been configured as an access port.

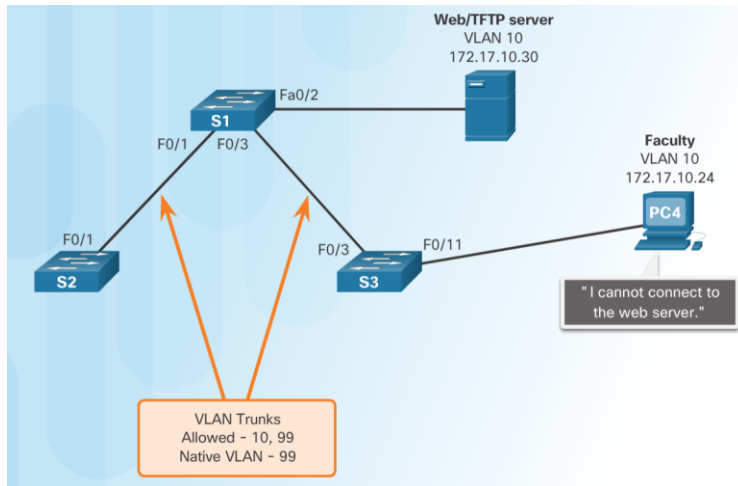

```
S1# show interfaces trunk
Port Mode Encapsulation Status Native vlan
Fa0/1 on 802.1q trunking 99
Port Vlans allowed on trunk
Fa0/1 10,99
Port Vlans allowed and active in management domain
Fa0/1 10,99
Port Vlans in spanning tree forwarding state and not pruned
Fa0/1 10,99
S1# show interface f0/3 switchport
Name: Fa0/3
Switchport: Enabled
Administrative Mode: trunk
```

```
S3# show interfaces trunk
S3#
S3# show interface f0/3 switchport
Name: Fa0/3
Switchport: Enabled
Administrative Mode: static access
...
```

To resolve the issue, the S3 F03 port is configured as a trunk link.

```
S3# config terminal
S3(config)# interface f0/3
S3(config-if)# switchport mode trunk
S3(config-if)# end
```

Incorrect VLAN List

- In this example, PC5 cannot reach the Student Email server.
- The output of the **switchport trunk allowed vlan** command reveals S1 is not allowing VLAN 20.

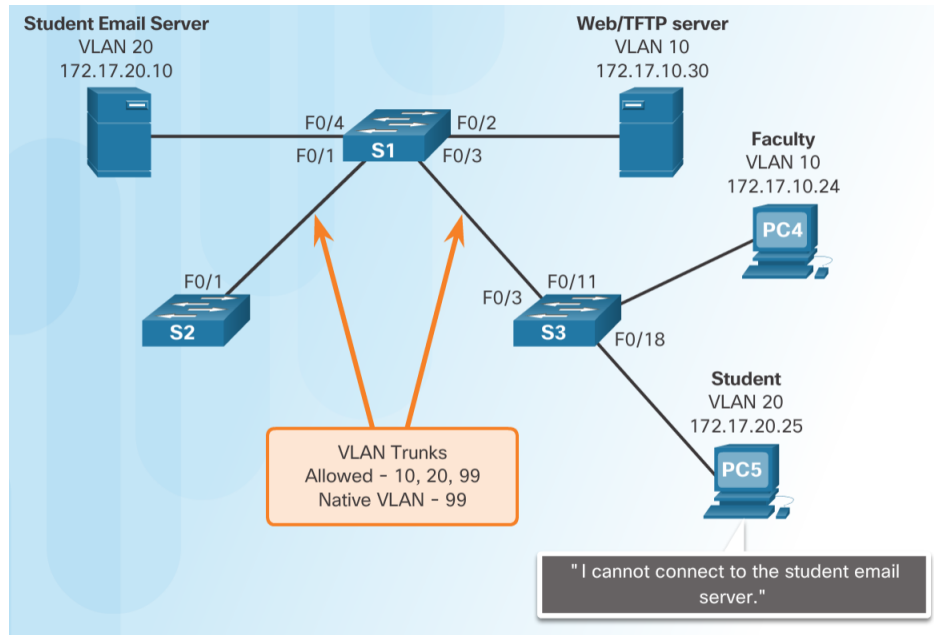

```
S1# show interfaces trunk
Port      Mode      Encapsulation  Status      Native vlan
Fa0/1     on        802.1q         trunking    99
Fa0/3     on        802.1q         trunking    99
Port      Vlans allowed on trunk
Fa0/1     10,99
Fa0/3     10,99
...
S1#
```

To resolve the issue, the S1 F0/1 port is configured to allow VLANs 10, 20, and 99.

```
S1# config terminal
S1(config)# interface f0/1
S1(config-if)# switchport trunk allowed vlan 10,20,99
S1(config-if)# interface f0/3
S1(config-if)# switchport trunk allowed vlan 10,20,99
S1# show interfaces trunk
Port      Mode      Encapsulation  Status      Native vlan
Fa0/1     on        802.1q         trunking    99
Fa0/3     on        802.1q         trunking    99
Port      Vlans allowed on trunk
Fa0/1     10,20,99
Fa0/3     10,20,99
...
```

Packet Tracer - Troubleshooting a VLAN Implementation - Scenario 1



Packet Tracer - Troubleshooting a VLAN Implementation Scenario 1

Topology

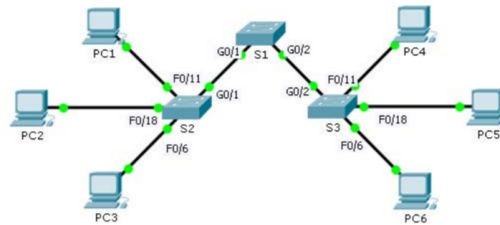

Addressing Table

Device	Interface	IPv4 Address	Subnet Mask	Switch Port	VLAN
PC1	NIC	172.17.10.21	255.255.255.0	S1 F0/11	10
PC2	NIC	172.17.20.22	255.255.255.0	S1 F0/18	20
PC3	NIC	172.17.30.23	255.255.255.0	S1 F0/6	30
PC4	NIC	172.17.10.24	255.255.255.0	S2 F0/11	10
PC5	NIC	172.17.20.25	255.255.255.0	S2 F0/18	20
PC6	NIC	172.17.30.26	255.255.255.0	S2 F0/6	30

Objectives

Part 1: Test Connectivity between PCs on the Same VLAN

Part 2: Investigate Connectivity Problems by Gathering Data

Part 3: Implement the Solution and Test Connectivity

Scenario

In this activity, you will troubleshoot connectivity problems between PCs on the same VLAN. The activity is complete when PCs on the same VLAN can ping each other. Any solution you implement must conform to the Addressing Table.

Packet Tracer - Troubleshooting a VLAN Implementation - Scenario 2



Packet Tracer – Troubleshooting a VLAN Implementation Scenario 2

Topology

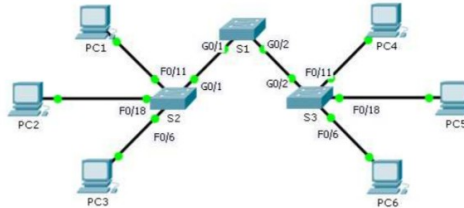

Addressing Table

Device	Interface	IPv4 Address	Subnet Mask	Default Gateway
S1	VLAN 56	192.168.56.11	255.255.255.0	N/A
S2	VLAN 56	192.168.56.12	255.255.255.0	N/A
S3	VLAN 56	192.168.56.13	255.255.255.0	N/A
PC1	NIC	192.168.10.21	255.255.255.0	192.168.10.1
PC2	NIC	192.168.20.22	255.255.255.0	192.168.20.1
PC3	NIC	192.168.30.23	255.255.255.0	192.168.30.1
PC4	NIC	192.168.10.24	255.255.255.0	192.168.10.1
PC5	NIC	192.168.20.25	255.255.255.0	192.168.20.1
PC6	NIC	192.168.30.26	255.255.255.0	192.168.30.1

VLAN and Port Assignments

Ports	VLAN Number - Name	Network
F0/1 – F0/5	VLAN 56 – Management&Native	192.168.56.0/24
F0/6 – F0/10	VLAN 30 – Guest(Default)	192.168.30.0/24
F0/11 – F0/17	VLAN 10 – Faculty/Staff	192.168.10.0/24
F0/18 – F0/24	VLAN 20 – Students	192.168.20.0/24

Lab - Troubleshooting VLAN Configurations



Lab - Troubleshooting VLAN Configurations

Topology

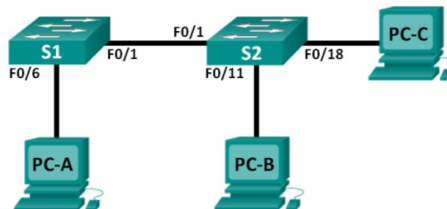

Addressing Table

Device	Interface	IP Address	Subnet Mask	Default Gateway
S1	VLAN 1	192.168.1.2	255.255.255.0	N/A
S2	VLAN 1	192.168.1.3	255.255.255.0	N/A
PC-A	NIC	192.168.10.2	255.255.255.0	192.168.10.1
PC-B	NIC	192.168.10.3	255.255.255.0	192.168.10.1
PC-C	NIC	192.168.20.3	255.255.255.0	192.168.20.1

Switch Port Assignment Specifications

Ports	Assignment	Network
F0/1	802.1Q Trunk	N/A
F0/6-12	VLAN 10 – Students	192.168.10.0/24
F0/13-18	VLAN 20 – Faculty	192.168.20.0/24
F0/19-24	VLAN 30 – Guest	192.168.30.0/24

Objectives

Part 1: Build the Network and Configure Basic Device Settings

Part 2: Troubleshoot VLAN 10

Part 3: Troubleshoot VLAN 20

6.3 Inter-VLAN Routing Using Routers

What is Inter-VLAN Routing?

- Layer 2 switches cannot forward traffic between VLANs without the assistance of a router.
- Inter-VLAN routing is a process for forwarding network traffic from one VLAN to another, using a router.
- There are three options for inter-VLAN routing:
 - Legacy inter-VLAN routing
 - Router-on-a-Stick
 - Layer 3 switching using SVIs

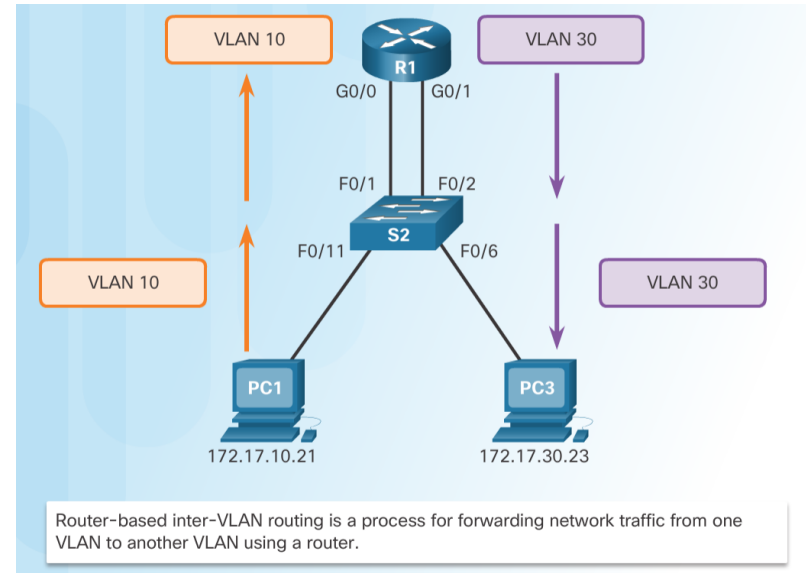

Inter-VLAN Routing Operation

Legacy Inter-VLAN Routing

- In the past:
 - Router interfaces were used to route between VLANs.
 - Each VLAN was connected to a different physical router interface.
 - Packets would arrive on the router through one interface, be routed and leave through another.
 - Because the router interfaces were connected to VLANs and had IP addresses from that specific VLAN, routing between VLANs was achieved.
 - Large networks with large number of VLANs required many router interfaces.

In this example, the router was configured with two separate physical interfaces to interact with the different VLANs and perform the routing.

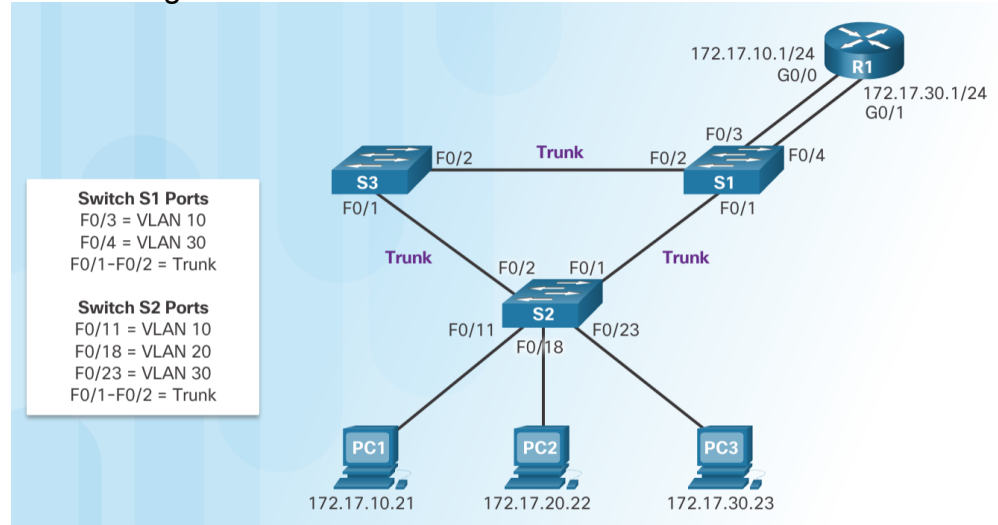

Router-on-a-Stick Inter-VLAN Routing

- The router-on-a-stick approach uses only one of the router's physical interface.
 - One of the router's physical interfaces is configured as a 802.1Q trunk port so it can understand VLAN tags.
 - Logical subinterfaces are created; one subinterface per VLAN.
 - Each subinterface is configured with an IP address from the VLAN it represents.
 - VLAN members (hosts) are configured to use the subinterface address as a default gateway.

In this example, the R1 interface is configured as a trunk link and connects to the trunk F0/4 port on S1.

- Router accepts VLAN-tagged traffic on the trunk interface
- Router internally routes between the VLANs using subinterfaces.
- Router then forwards the routed traffic as VLAN-tagged for the destination VLAN out the trunk link.

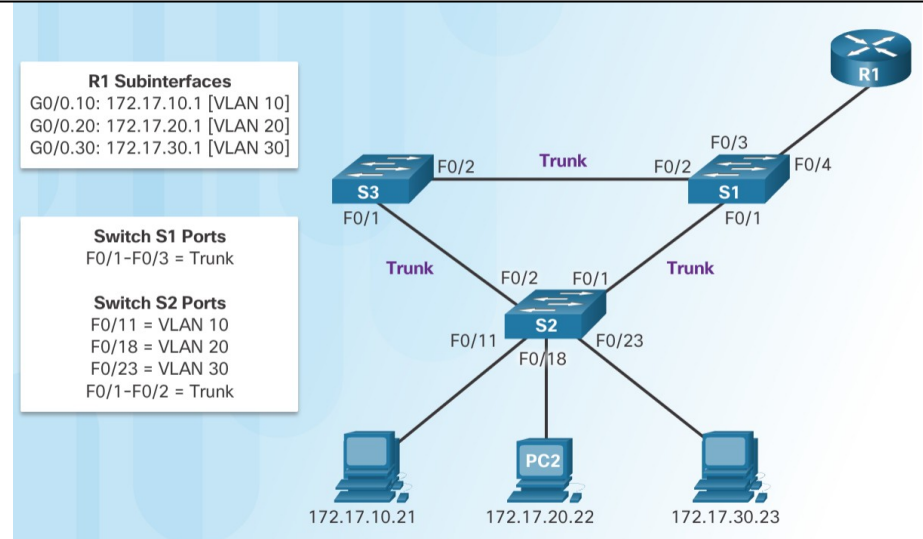

Configure Legacy Inter-VLAN Routing

Configure Legacy Inter-VLAN Routing: Preparation

- Legacy inter-VLAN routing requires routers to have multiple physical interfaces.
- Each one of the router's physical interfaces is connected to a unique VLAN.
- Each interface is also configured with an IP address for the subnet associated with the particular VLAN.
- Network devices use the router as a gateway to access the devices connected to the other VLANs.

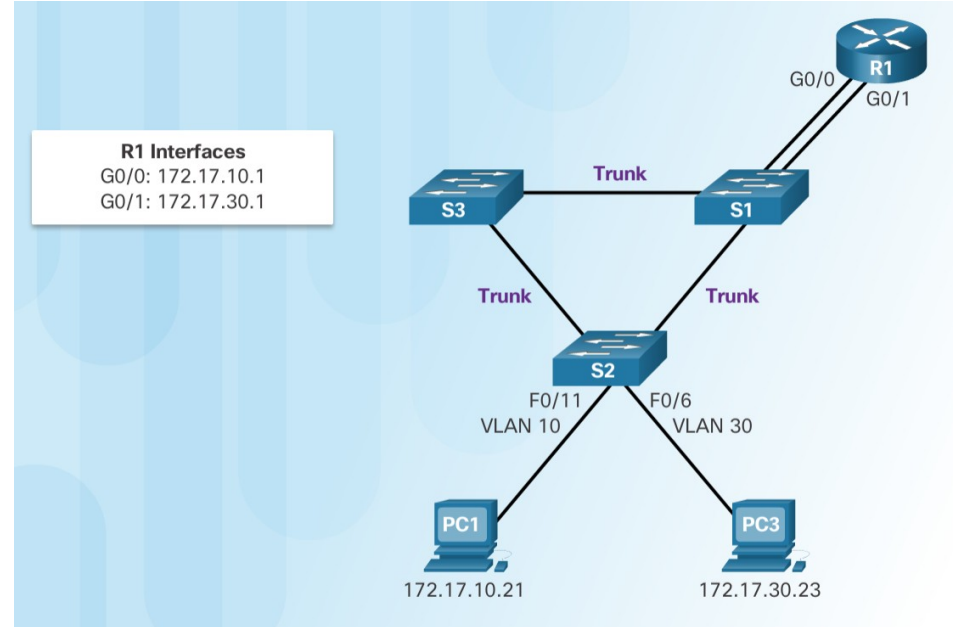

Configure Legacy Inter-VLAN Routing

Configure Legacy Inter-VLAN Routing: Switch Configuration

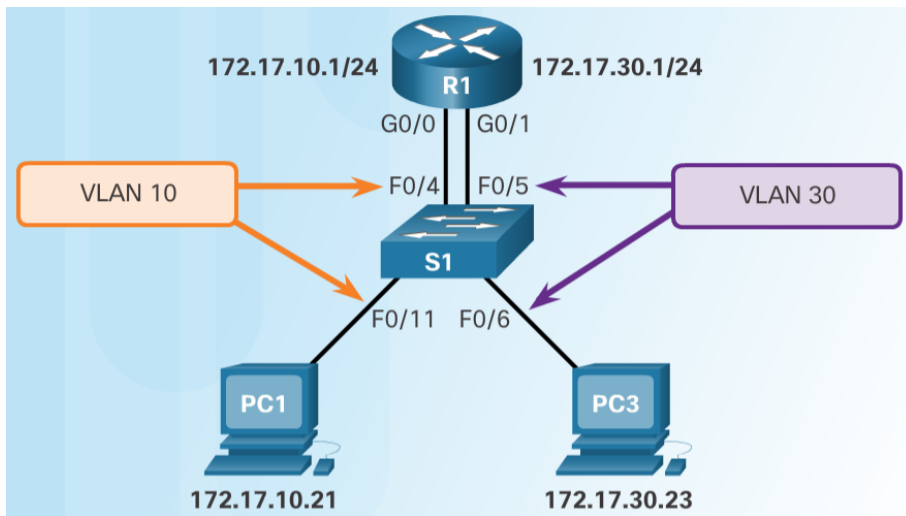

- Configure the VLANs on the switch and then assign the ports to their respective VLANs.
- In this example, the S1 ports are configured as follows:
 - Ports F0/4 and F0/11 of S1 are on VLAN 10
 - Ports F0/5 and F0/16 ports are on VLAN 30.

```
S1(config)# vlan 10
S1(config-vlan)# vlan 30
S1(config-vlan)# interface f0/11
S1(config-if)# switchport access vlan 10
S1(config-if)# interface f0/4
S1(config-if)# switchport access vlan 10
S1(config-if)# interface f0/6
S1(config-if)# switchport access vlan 30
S1(config-if)# interface f0/5
S1(config-if)# switchport access vlan 30
S1(config-if)# end
```

Configure Legacy Inter-VLAN Routing

Configure Legacy Inter-VLAN Routing: Router Interface Configuration

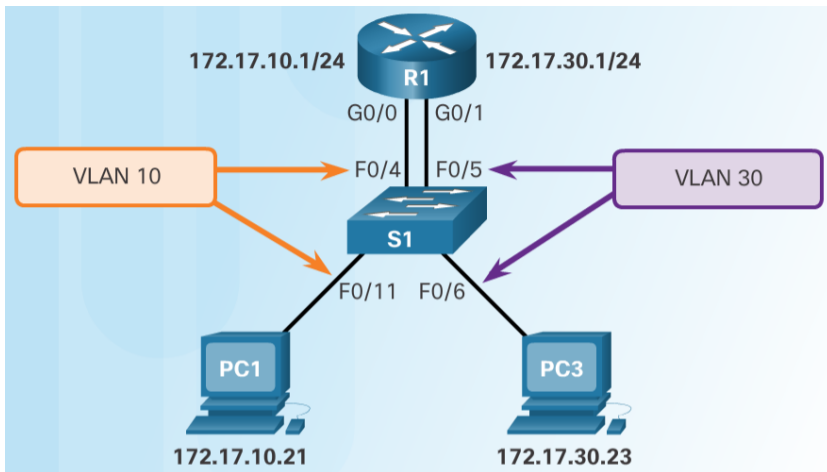

- Next configure the router interfaces.

```
R1(config)# interface g0/0
R1(config-if)# ip address 172.17.10.1 255.255.255.0
R1(config-if)# no shutdown
*Mar 20 01:42:12.951: %LINK-3-UPDOWN: Interface GigabitEthernet0/0, changed state to up
*Mar 20 01:42:13.951: %LINEPROTO-5-UPDOWN: Line protocol on Interface GigabitEthernet0/0,
changed state to up
R1(config-if)# interface g0/1
R1(config-if)# ip address 172.17.30.1 255.255.255.0
R1(config-if)# no shutdown
*Mar 20 01:42:54.951: %LINK-3-UPDOWN: Interface GigabitEthernet0/1, changed state to up
*Mar 20 01:42:55.951: %LINEPROTO-5-UPDOWN: Line protocol on Interface GigabitEthernet0/1,
```

Lab – Configuring Per-Interface Inter-VLAN Routing



Lab – Configuring Per-Interface Inter-VLAN Routing

Topology

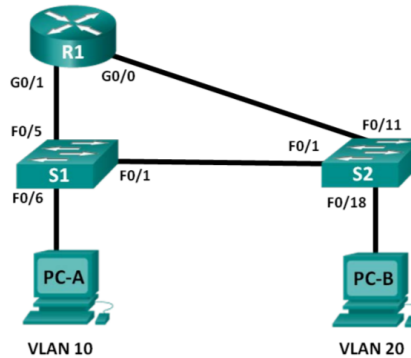

Addressing Table

Device	Interface	IP Address	Subnet Mask	Default Gateway
R1	G0/0	192.168.20.1	255.255.255.0	N/A
	G0/1	192.168.10.1	255.255.255.0	N/A
S1	VLAN 10	192.168.10.11	255.255.255.0	192.168.10.1
S2	VLAN 10	192.168.10.12	255.255.255.0	192.168.10.1
PC-A	NIC	192.168.10.3	255.255.255.0	192.168.10.1
PC-B	NIC	192.168.20.3	255.255.255.0	192.168.20.1

Objectives

Part 1: Build the Network and Configure Basic Device Settings

Part 2: Configure Switches with VLANs and Trunking

Part 3: Verify Trunking, VLANs, Routing, and Connectivity

Configure Router-on-a-Stick Inter-VLAN Routing

Configure Router-on-a Stick: Preparation

- An alternative to legacy inter-VLAN routing is to use VLAN trunking and subinterfaces.
- VLAN trunking allows a single physical router interface to route traffic for multiple VLANs.
- The physical interface of the router must be connected to a trunk link on the adjacent switch.
- On the router, subinterfaces are created for each unique VLAN.
- Each subinterface is assigned an IP address specific to its subnet or VLAN and is also configured to tag frames for that VLAN.

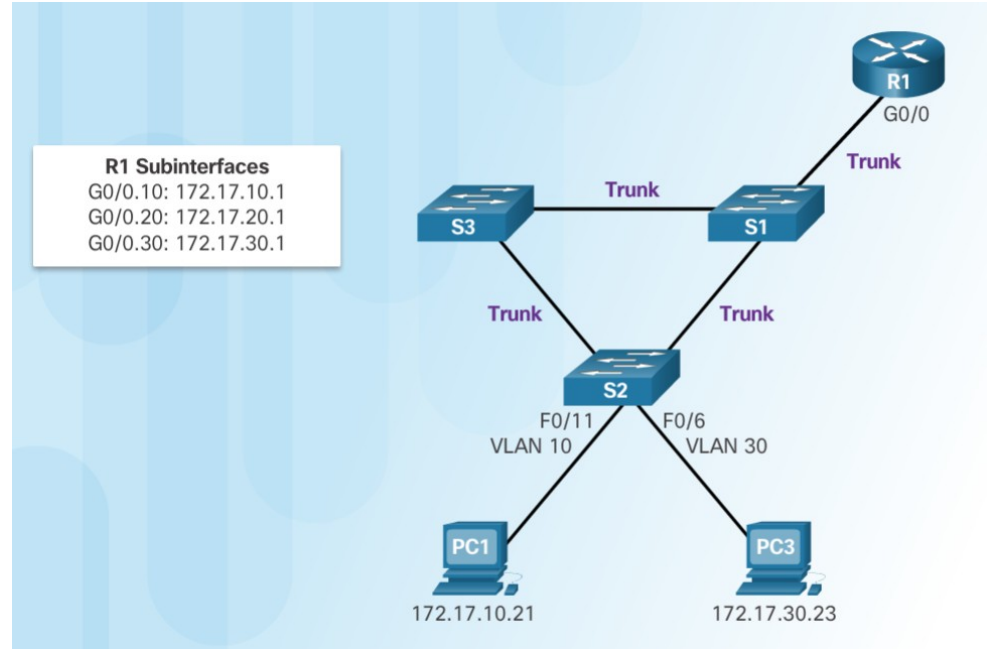

Configure Router-on-a-Stick Inter-VLAN Routing

Configure Router-on-a Stick: Switch Configuration

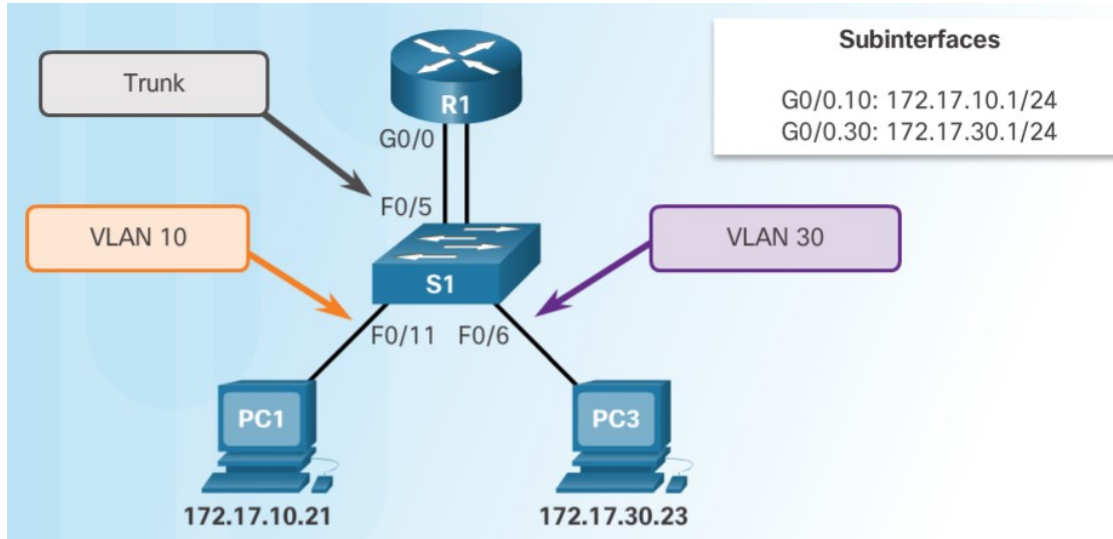

- To enable inter-VLAN routing using router-on-a stick, start by enabling trunking on the switch port that is connected to the router.

```
S1(config)# vlan 10
S1(config-vlan)# vlan 30
S1(config-vlan)# interface f0/5
S1(config-if)# switchport mode trunk
S1(config-if)# end
S1#
```

Configure Router-on-a-Stick Inter-VLAN Routing

Configure Router-on-a-Stick: Router Subinterface Configuration

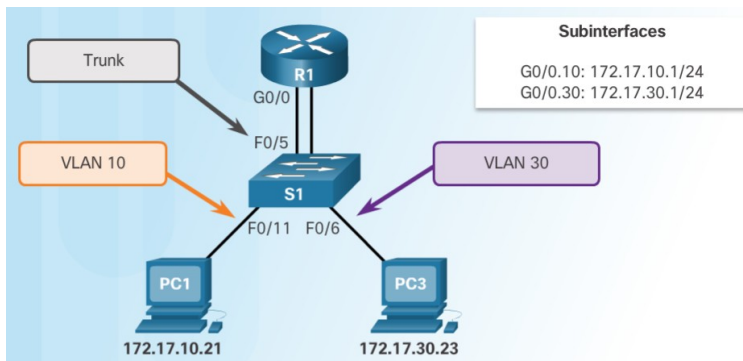

- The router-on-a-stick method requires subinterfaces to be configured for each routable VLAN.
- The subinterfaces must be configured to support VLANs using the **encapsulation dot1Q VLAN-ID** interface configuration command.

```
R1(config)# interface g0/0.10
R1(config-subif)# encapsulation dot1q 10
R1(config-subif)# ip address 172.17.10.1 255.255.255.0
R1(config-subif)# interface g0/0.30
R1(config-subif)# encapsulation dot1q 30
R1(config-subif)# ip address 172.17.30.1 255.255.255.0
R1(config)# interface g0/0
R1(config-if)# no shutdown
*Mar 20 00:20:59.299: %LINK-3-UPDOWN: Interface GigabitEthernet0/0, changed state to down
*Mar 20 00:21:02.919: %LINK-3-UPDOWN: Interface GigabitEthernet0/0, changed state to up
*Mar 20 00:21:03.919: %LINEPROTO-5-UPDOWN: Line protocol on Interface GigabitEthernet0/0,
changed state to up
```

Configure Router-on-a Stick: Verifying Subinterfaces

- By default, Cisco routers are configured to route traffic between local subinterfaces.
 - As a result, routing does not specifically need to be enabled.
- Use the **show vlan** and **show ip route** commands to verify the subinterface configurations.

```
R1# show vlan
<output omitted>

Virtual LAN ID: 10 (IEEE 802.1Q Encapsulation)

  vLAN Trunk Interface:  GigabitEthernet0/0.10

  Protocols Configured:  Address:      Received:    Transmitted:
                        IP             172.17.10.1  11          18

<output omitted>

Virtual LAN ID: 30 (IEEE 802.1Q Encapsulation)

  vLAN Trunk Interface:  GigabitEthernet0/0.30

  Protocols Configured:  Address:      Received:    Transmitted:
                        IP             172.17.30.1  11          8

<output omitted>
```

The **show vlan** command displays information about the Cisco IOS VLAN subinterfaces.

```
R1# show ip route
Codes: L - local, C - connected, S - static, R - RIP, M - mobile, B - BGP, D - EIGRP,
       EX - EIGRP external, O - OSPF, IA - OSPF inter area,
       N1 - OSPF NSSA external type 1, N2 - OSPF NSSA external type 2,
       E1 - OSPF external type 1, E2 - OSPF external type 2, i - IS-IS,
       su - IS-IS summary, L1 - IS-IS level-1, L2 - IS-IS level-2
       ia - IS-IS inter area, * - candidate default, U - per-user static route
       o - ODR, P - periodic downloaded static route, H - NHRP, l - LISP,
       + - replicated route, % - next hop override

Gateway of last resort is not set

    172.17.0.0/16 is variably subnetted, 4 subnets, 2 masks
C       172.17.10.0/24 is directly connected, GigabitEthernet0/0.10
L       172.17.10.1/32 is directly connected, GigabitEthernet0/0.10
C       172.17.30.0/24 is directly connected, GigabitEthernet0/0.30
L       172.17.30.1/32 is directly connected, GigabitEthernet0/0.30
```

The **show ip route** command displays the routing table containing the networks associated with outgoing subinterfaces.

Configure Router-on-a-Stick Inter-VLAN Routing

Configure Router-on-a Stick: Verifying Routing

- Remote VLAN device connectivity can be tested using the **ping** command.
 - The command sends an ICMP echo request and when a host receives an ICMP echo request, it responds with an ICMP echo reply.
- Tracert** is a useful utility for confirming the routed path taken between two devices.

```
PC1> ping 172.17.30.23

Pinging 172.17.30.23 with 32 bytes of data:

Reply from 172.17.30.23: bytes=32 time=17ms TTL=127
Reply from 172.17.30.23: bytes=32 time=15ms TTL=127
Reply from 172.17.30.23: bytes=32 time=18ms TTL=127
Reply from 172.17.30.23: bytes=32 time=19ms TTL=127

Ping statistics for 172.17.30.23:
    Packets: Sent = 4, Received = 4, Lost = 0 (0% loss),
```

```
Approximate round trip times in milli-seconds:
    Minimum = 15ms, Maximum = 19ms, Average = 17ms

PC1> tracert 172.17.30.23

Tracing route to 172.17.30.23 over a maximum of 30 hops:

  0  9 ms    7 ms    9 ms    172.17.10.1
  1 16 ms   15 ms   16 ms   172.17.30.23

Trace complete.
```

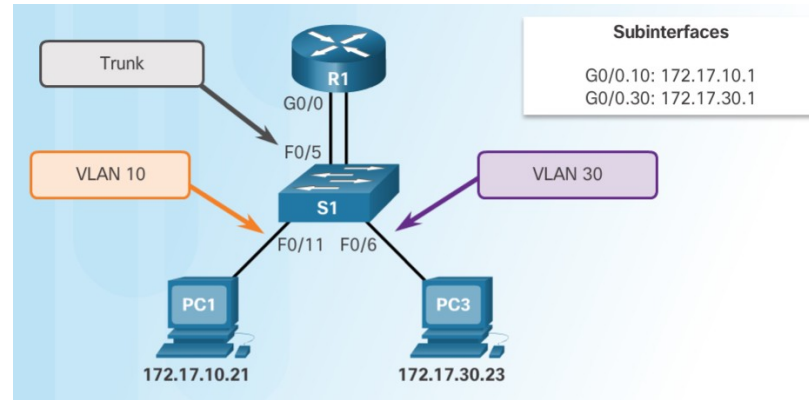



Packet Tracer – Configuring Router-on-a-Stick Inter-VLAN Routing

Topology

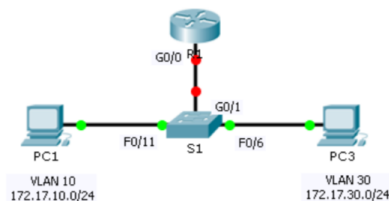

Addressing Table

Device	Interface	IPv4 Address	Subnet Mask	Default Gateway
R1	G0/0.10	172.17.10.1	255.255.255.0	N/A
	G0/0.30	172.17.30.1	255.255.255.0	N/A
PC1	NIC	172.17.10.10	255.255.255.0	172.17.10.1
PC2	NIC	172.17.30.10	255.255.255.0	172.17.30.1

Objectives

Part 1: Test Connectivity without Inter-VLAN Routing

Part 2: Add VLANs to a Switch

Part 3: Configure Subinterfaces

Part 4: Test Connectivity with Inter-VLAN Routing

Scenario

In this activity, you will check for connectivity prior to implementing inter-VLAN routing. You will then configure VLANs and inter-VLAN routing. Finally, you will enable trunking and verify connectivity between VLANs.

Lab - Configuring 801.2Q Trunk-Based Inter-VLAN Routing



Lab – Configuring 802.1Q Trunk-Based Inter-VLAN Routing

Topology

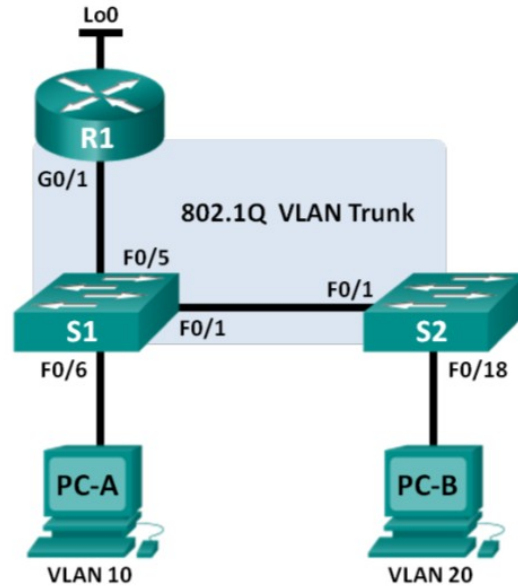

Configure Router-on-a-Stick Inter-VLAN Routing

Packet Tracer - Inter-VLAN Routing Challenge



Cisco Networking Academy®

Mind Wide Open™

Packet Tracer – Inter-VLAN Routing Challenge

Topology

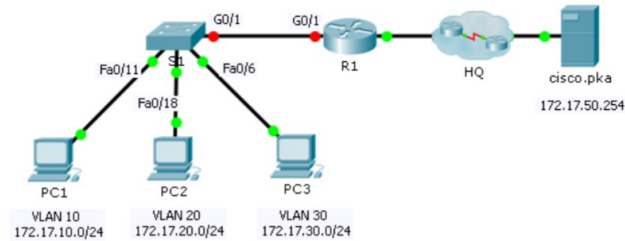

Addressing Table

Device	Interface	IP Address	Subnet Mask	Default Gateway
R1	G0/0	172.17.25.2	255.255.255.252	N/A
	G0/1.10	172.17.10.1	255.255.255.0	N/A
	G0/1.20	172.17.20.1	255.255.255.0	N/A
	G0/1.30	172.17.30.1	255.255.255.0	N/A
	G0/1.88	172.17.88.1	255.255.255.0	N/A
	G0/1.99	172.17.99.1	255.255.255.0	N/A
S1	VLAN 99	172.17.99.10	255.255.255.0	172.17.99.1
PC1	NIC	172.17.10.21	255.255.255.0	172.17.10.1
PC2	NIC	172.17.20.22	255.255.255.0	172.17.20.1
PC3	NIC	172.17.30.23	255.255.255.0	172.17.30.1

6.4 Chapter Summary

Packet Tracer - Skills Integration Challenge



Packet Tracer – Skills Integration Challenge

Topology

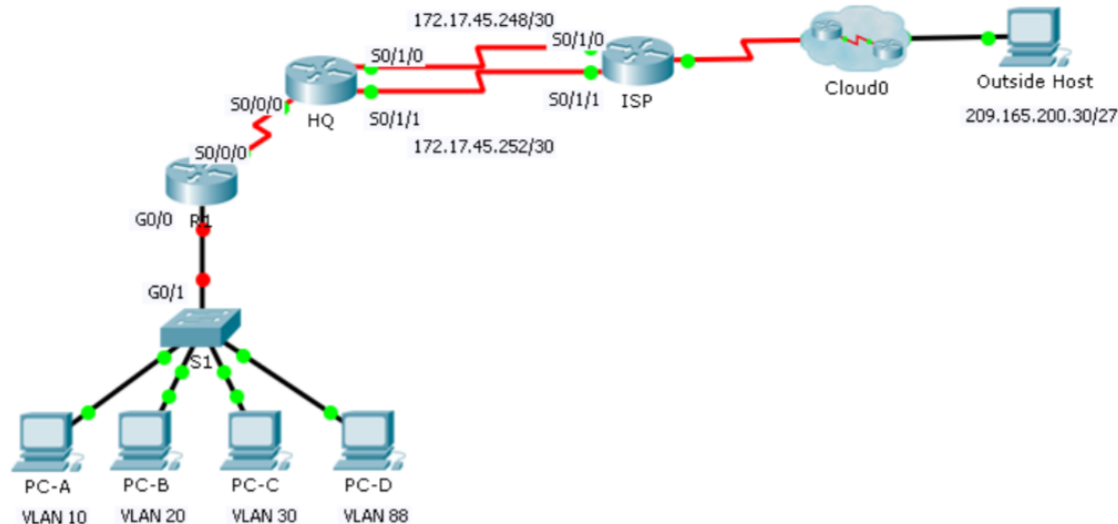

Chapter 6: VLANs

- Explain how VLANs segment broadcast domains in a small to medium-sized business network.
- Implement VLANs to segment a small to medium-sized business network..
- Configure routing between VLANs in a small to medium-sized business network.

