

Chapter 8: DHCP

Instructor Materials

CCNA Routing and Switching

Routing and Switching Essentials v6.0



Chapter 8: DHCP

Routing and Switching Essentials v6.0
Planning Guide

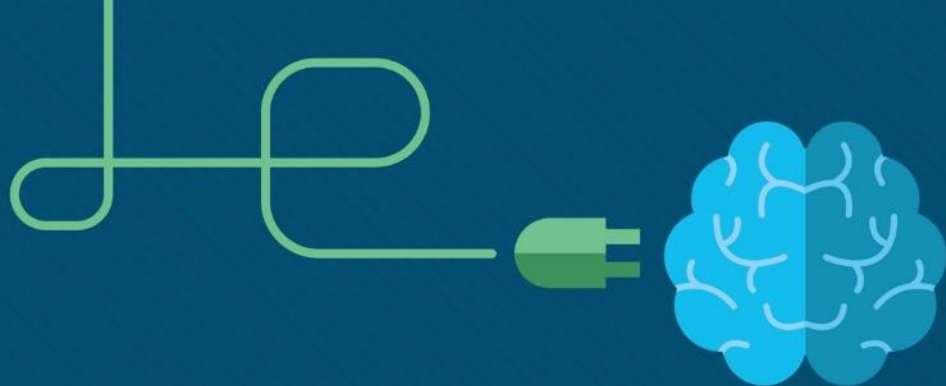

Chapter 8: DHCP

CCNA Routing and Switching

Routing and Switching Essentials v6.0



Chapter 8 - Sections & Objectives

▪ 8.1 DHCPv4

- Implement DHCPv4 to operate across multiple LANs in a small to medium-sized business network.
- Explain how DHCPv4 operates in a small- to medium-sized business network.
- Configure a router as a DHCPv4 server.
- Configure a router as a DHCPv4 client.
- Troubleshoot a DHCP configuration for IPv4 in a switched network.

▪ 8.2 DHCPv6

- Implement DHCPv6 to operate across multiple LANs in a small to medium-sized business network.
- Explain the operation of DHCPv6.
- Configure stateless DHCPv6 for a small to medium-sized business.
- Configure stateful DHCPv6 for a small to medium-sized business.
- Troubleshoot a DHCP configuration for IPv6 in a switched network.

8.1 DHCPv4

DHCPv4 Operation

Introducing DHCPv4

- DHCPv4 assigns IPv4 addresses and other network configuration information dynamically.
 - A dedicated DHCPv4 server is scalable and relatively easy to manage.
 - A Cisco router can be configured to provide DHCPv4 services in a small network.

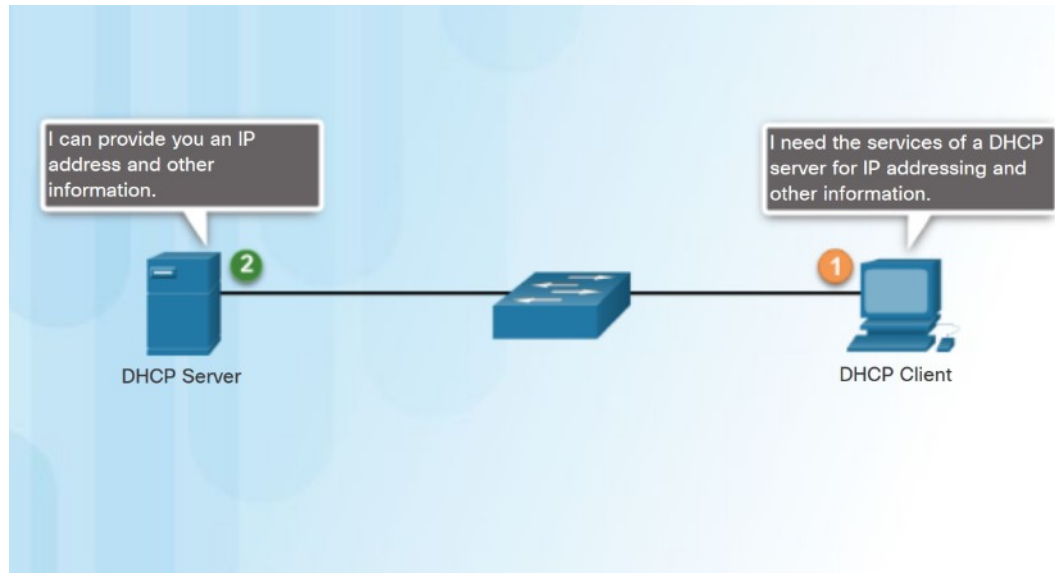

DHCPv4 Operation

DHCPv4 Operation

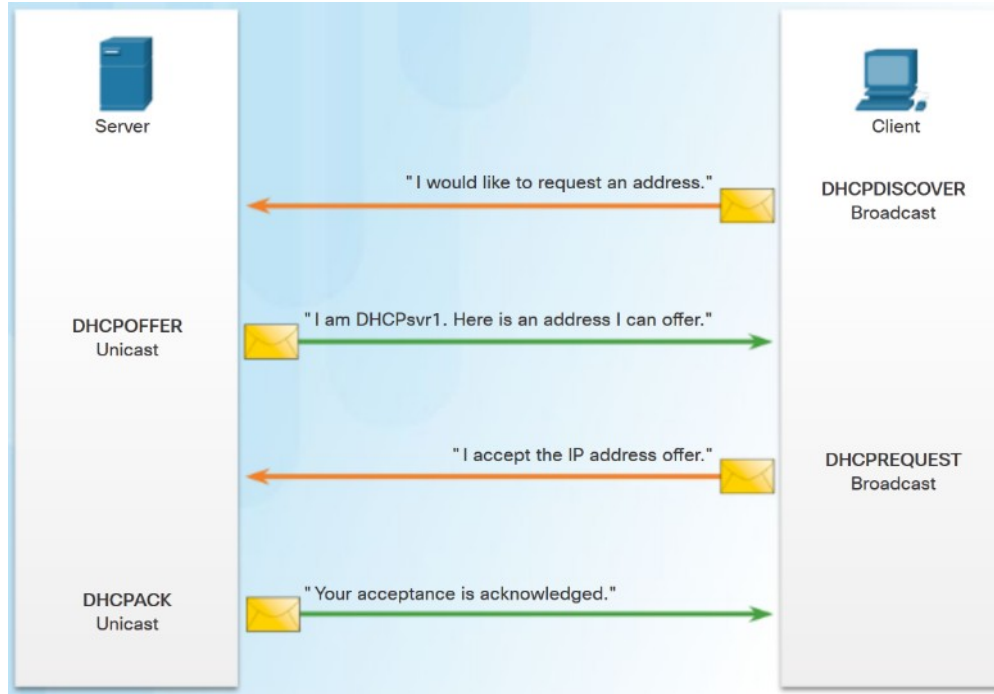

- Four step process for a client to obtain a lease:
 - DHCP Discover (DHCPDISCOVER)** - client uses Layer 2 and Layer 3 broadcast addresses to find a DHCP server.
 - DHCP Offer (DHCPOFFER)** - DHCPv4 server sends the binding DHCPOFFER message to the requesting client as a unicast.
 - DHCP Request (DHCPREQUEST)** – the client sends back a broadcast DHCPREQUEST in response to the servers offer.
 - DHCP Acknowledgment (DHCPACK)** – the server replies with a unicast DHCPACK message.

DHCPv4 Message Format

- DHCPv4 messages:

- If sent from the client, use UDP source port 68 and destination port 67.
- If sent from the server, use UDP source port 67 and destination port 68.

8	16	24	32
OP Code (1)	Hardware Type (1)	Hardware Address Length (1)	Hops (1)
Transaction Identifier			
Seconds - 2 bytes		Flags - 2 bytes	
Client IP Address (CIADDR) - 4 bytes			
Your IP Address (YIADDR) - 4 bytes			
Server IP Address (SIADDR) - 4 bytes			
Gateway IP Address (GIADDR) - 4 bytes			
Client Hardware Address (CHADDR) - 16 bytes			
Server Name (SNAME) - 64 bytes			
Boot Filename - 128 bytes			
DHCP Options - variable			

Format and fields of a DHCPv4 Message

DHCPv4 Operation

DHCPv4 Discover and Offer Messages

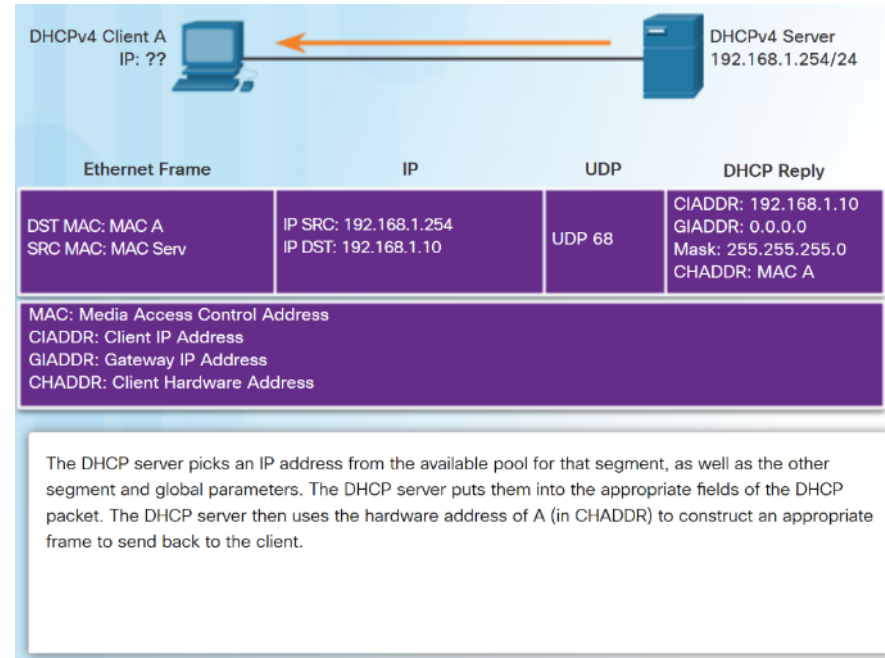
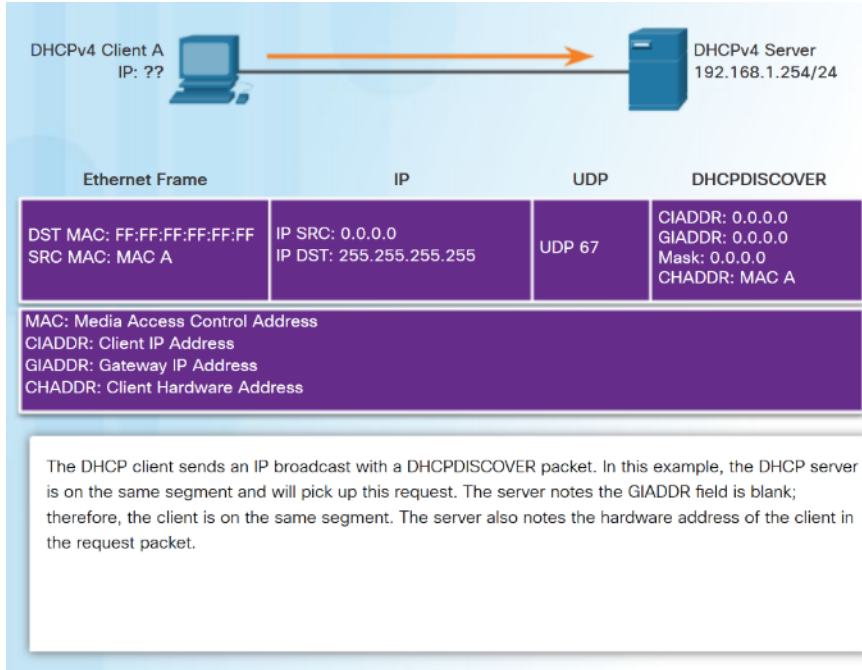

Configuring a Basic DHCPv4 Server

- Configuring a Cisco router as a DHCPv4 server:
 - Excluding IPv4 Addresses – **ip dhcp excluded-address** can exclude a single address or a range of addresses from being assigned.
 - Configuring a DHCPv4 Pool - **ip dhcp pool pool-name** command creates a pool with the specified name and puts the router in DHCPv4 configuration mode.
 - Address pool assigned using **network** command.
 - Default gateway assigned using **default-router** command.
 - Other commands are optional.

```
R1 (config) # ip dhcp excluded-address 192.168.10.1 192.168.10.9
R1 (config) # ip dhcp excluded-address 192.168.10.254
R1 (config) # ip dhcp pool LAN-POOL-1
R1 (dhcp-config) # network 192.168.10.0 255.255.255.0
R1 (dhcp-config) # default-router 192.168.10.1
R1 (dhcp-config) # dns-server 192.168.11.5
R1 (dhcp-config) # domain-name example.com
R1 (dhcp-config) # end
R1 #
```

Configuring a Basic DHCPv4 Server

Verifying DHCPv4

```
R1# show running-config | section dhcp
ip dhcp excluded-address 192.168.10.1 192.168.10.9
ip dhcp excluded-address 192.168.10.254
ip dhcp excluded-address 192.168.11.1 192.168.11.9
ip dhcp excluded-address 192.168.11.254
ip dhcp pool LAN-POOL-1
 network 192.168.10.0 255.255.255.0
 default-router 192.168.10.1
 dns-server 192.168.11.5
 domain-name example.com
ip dhcp pool LAN-POOL-2
 network 192.168.11.0 255.255.255.0
 default-router 192.168.11.1
 dns-server 192.168.11.5
 domain-name example.com
R1#
```

```
R1# show ip dhcp binding
Bindings from all pools not associated with VRF:
IP address      Client-ID/      Lease expiration    Type
Hardware address/
User name
192.168.10.10   0100.e018.5bdd.35  May 28 2013 01:06 PM Automatic
192.168.11.10   0100.b0d0.d817.e6  May 28 2013 01:10 PM Automatic

R1# show ip dhcp server statistics
Memory usage      25307
Address pools     2
Database agents   0
Automatic bindings 2
Manual bindings   0
Expired bindings  0
Malformed messages 0
Secure arp entries 0

Message           Received
BOOTREQUEST       0
DHCPDISCOVER      8
DHCPREQUEST       3
DHCPDECLINE       0
DHCPRELEASE       0
DHCPIFORM         0
```

- Verify DHCPv4 configuration using the **show running-config |section dhcp** command.
- Verify the operation of DHCPv4 using the **show ip dhcp binding** command.
- Verify that messages are being received or sent by the router using the **show ip dhcp server statistics** command.

Configuring a Basic DHCPv4 Server

DHCPv4 Relay

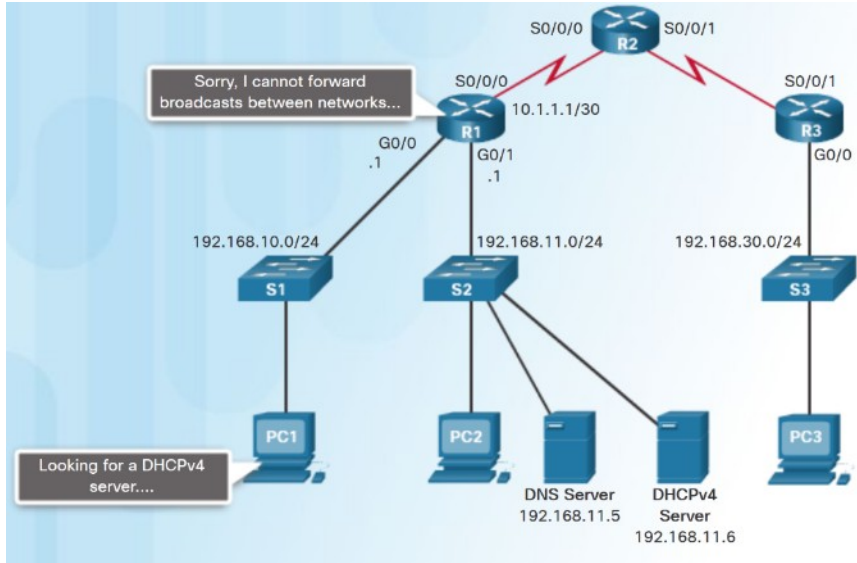

```
R1(config)# interface g0/0
R1(config-if)# ip helper-address 192.168.11.6
R1(config-if)# end
R1# show ip interface g0/0
GigabitEthernet0/0 is up, line protocol is up
  Internet address is 192.168.10.1/24
  Broadcast address is 255.255.255.255
  Address determined by setup command
  MTU is 1500 bytes
  Helper address is 192.168.11.6
<output omitted>
```

- DHCPDISCOVER messages are sent as broadcast messages.
- Routers do not forward broadcasts.
- A Cisco IOS helper address is configured so that the router acts as a relay agent forwarding the message to the DHCPv4 server.

Lab - Configuring Basic DHCPv4 on a Router

 Cisco Networking Academy[®] Mind Wide Open[™]

Lab - Configuring Basic DHCPv4 on a Router

Topology

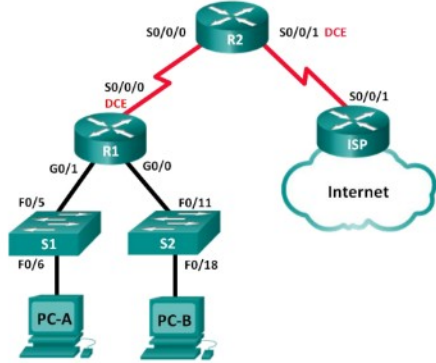

The diagram illustrates a network topology for a DHCPv4 lab. It features three routers: R1, R2, and an ISP. R1 is connected to R2 via their S0/0/0 interfaces. R1 is also connected to two switches, S1 and S2, via their G0/1 and G0/0 interfaces. S1 is connected to PC-A via F0/6, and S2 is connected to PC-B via F0/18. R2 is connected to the ISP via their S0/0/1 interfaces. The ISP is represented by a cloud icon labeled 'Internet'.

Addressing Table

Device	Interface	IP Address	Subnet Mask	Default Gateway
R1	G0/0	192.168.0.1	255.255.255.0	N/A
	G0/1	192.168.1.1	255.255.255.0	N/A
	S0/0/0 (DCE)	192.168.2.253	255.255.255.252	N/A
R2	S0/0/0	192.168.2.254	255.255.255.252	N/A
	S0/0/1 (DCE)	209.165.200.226	255.255.255.224	N/A
ISP	S0/0/1	209.165.200.225	255.255.255.224	N/A
PC-A	NIC	DHCP	DHCP	DHCP
PC-B	NIC	DHCP	DHCP	DHCP

Lab - Configuring Basic DHCPv4 on a Switch

 Cisco Networking Academy® Mind Wide Open™

Lab – Configuring Basic DHCPv4 on a Switch

Topology

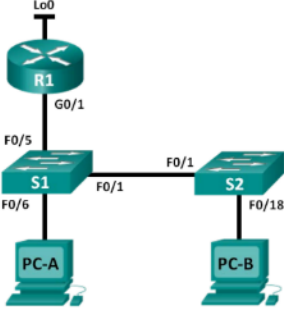

```
graph TD
    R1((R1)) ---|G0/1| S1[S1]
    R1 ---|F0/5| S1
    S1 ---|F0/1| S2[S2]
    S1 ---|F0/6| PC-A[PC-A]
    S2 ---|F0/18| PC-B[PC-B]
```

Addressing Table

Device	Interface	IP Address	Subnet Mask
R1	G0/1	192.168.1.10	255.255.255.0
	Lo0	209.165.200.225	255.255.255.224
S1	VLAN 1	192.168.1.1	255.255.255.0
	VLAN 2	192.168.2.1	255.255.255.0

Objectives

Part 1: Build the Network and Configure Basic Device Settings

Part 2: Change the SDM Preference

- Set the SDM preference to lanbase-routing on S1.

Part 3: Configure DHCPv4

- Configure DHCPv4 for VLAN 1

Configuring a Router as DHCPv4 Client

- Small office/home office (SOHO) and branch sites often have to be configured as DHCPv4 clients.
- Use the **ip address dhcp interface** configuration mode command.

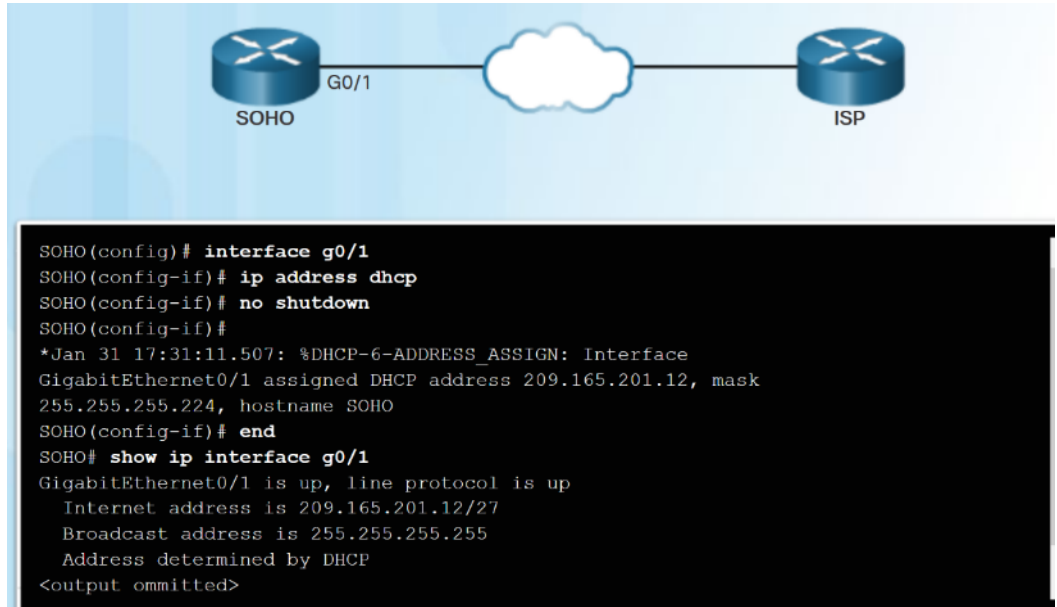

Configuring a Wireless Router as a DHCPv4 Client

The screenshot shows the configuration interface for a Cisco Wireless-N Broadband Router (WRT300N) with firmware version v0.93.3. The main menu includes Setup, Wireless Security, Access Restrictions, Applications & Gaming, Administration, and Status. The 'Setup' menu is expanded to show 'Internet Setup', 'Basic Setup', 'DDNS', 'MAC Address Clone', and 'Advanced Routing'. The 'Internet Setup' section is active, showing 'Internet Connection type' set to 'Automatic Configuration - DHCP'. Below this, there are fields for 'Host Name', 'Domain Name', and 'MTU' (set to 1500). A 'Help...' link is visible on the right side of the page.

- Wireless routers are set to receive IPv4 addressing information automatically from the ISP.

Packet Tracer - Configuring DHCPv4 Using Cisco IOS

Packet Tracer - Configuring DHCP Using Cisco IOS

Topology

Addressing Table

Device	Interface	IPv4 Address	Subnet Mask	Default Gateway
R1	G0/0	192.168.10.1	255.255.255.0	N/A
	S0/0/0	10.1.1.1	255.255.255.252	N/A
	G0/0	192.168.20.1	255.255.255.0	N/A
R2	G0/1	DHCP Assigned	DHCP Assigned	N/A
	S0/0/0	10.1.1.2	255.255.255.252	N/A
	S0/0/1	10.2.2.2	255.255.255.252	N/A
R3	G0/0	192.168.30.1	255.255.255.0	N/A
	S0/0/1	10.2.2.1	255.255.255.0	N/A
PC1	NIC	DHCP Assigned	DHCP Assigned	DHCP Assigned
PC2	NIC	DHCP Assigned	DHCP Assigned	DHCP Assigned
DNS Server	NIC	192.168.20.254	255.255.255.0	192.168.20.1

Objectives

- Part 1: Configure a Router as a DHCP Server
- Part 2: Configure DHCP Relay
- Part 3: Configure a Router as a DHCP Client
- Part 4: Verify DHCP and Connectivity

Troubleshooting Tasks

Troubleshooting Task 1:	Resolve address conflicts.
Troubleshooting Task 2:	Verify physical connectivity.
Troubleshooting Task 3:	Test with a static IPv4 address.
Troubleshooting Task 4:	Verify switch port configuration.
Troubleshooting Task 5:	Test from the same subnet or VLAN.

```
R1# show ip dhcp conflict
IP address Detection Method Detection time
192.168.10.32 Ping Feb 16 2013 12:28 PM
192.168.10.64 Gratuitous ARP Feb 23 2013 08:12 AM
```

Verify Router DHCPv4 Configuration

```
R1# show running-config | section interface GigabitEthernet0/0
interface GigabitEthernet0/0
 ip address 192.168.10.1 255.255.255.0
 ip helper-address 192.168.11.6
 duplex auto
 speed auto
R1#

R1# show running-config | include no service dhcp
R1#
```

- Verify DHCPv4 Relay - use **show running-config** command to verify that the ip helper address is configured.
- Verify DHCPv4 configuration - use the **show running-config | include no service dhcp** command to verify dhcp is enabled because there is no match for the **no service dhcp**.

Troubleshoot DHCPv4

Debugging DHCPv4

- The extended ACL is used with the **debug ip packet** command to display only DHCPv4 messages.
- Another troubleshooting command is the **debug ip dhcp server events**.

```
R1(config)# access-list 100 permit udp any any eq 67
R1(config)# access-list 100 permit udp any any eq 68
R1(config)# end
R1# debug ip packet 100
IP packet debugging is on for access list 100
*IP: s=0.0.0.0 (GigabitEthernet0/1), d=255.255.255.255,
len 333, rcvd 2
*IP: s=0.0.0.0 (GigabitEthernet0/1), d=255.255.255.255,
len 333, stop process pak for forus packet
*IP: s=192.168.11.1 (local), d=255.255.255.255
(GigabitEthernet0/1), len 328, sending broad/multicast
<output omitted>

R1# debug ip dhcp server events
DHCPD: returned 192.168.10.11 to address pool LAN-POOL-1
DHCPD: assigned IP address 192.168.10.12 to client
0100.0103.85e9.87.
DHCPD: checking for expired leases.
DHCPD: the lease for address 192.168.10.10 has expired.
DHCPD: returned 192.168.10.10 to address pool LAN-POOL-1
```

Lab - Troubleshooting DHCPv4

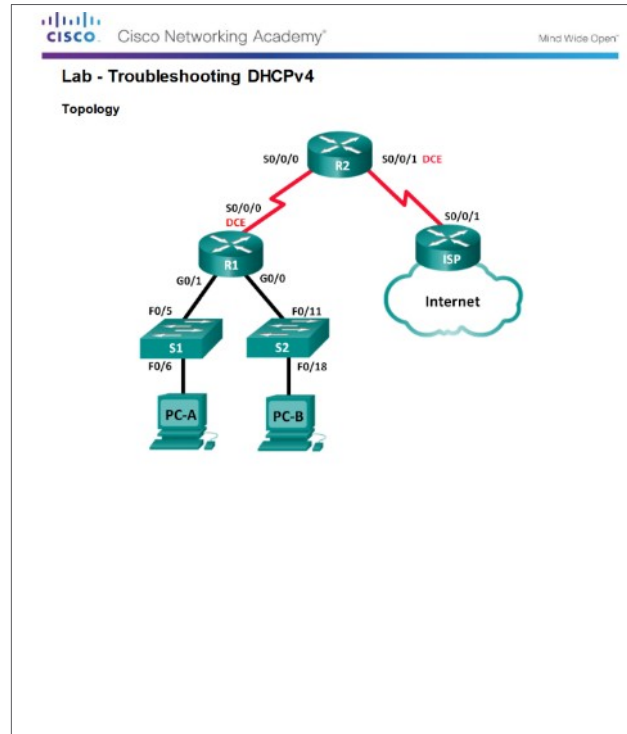

8.2 DHCPv6

Stateless Address Autoconfiguration (SLAAC)

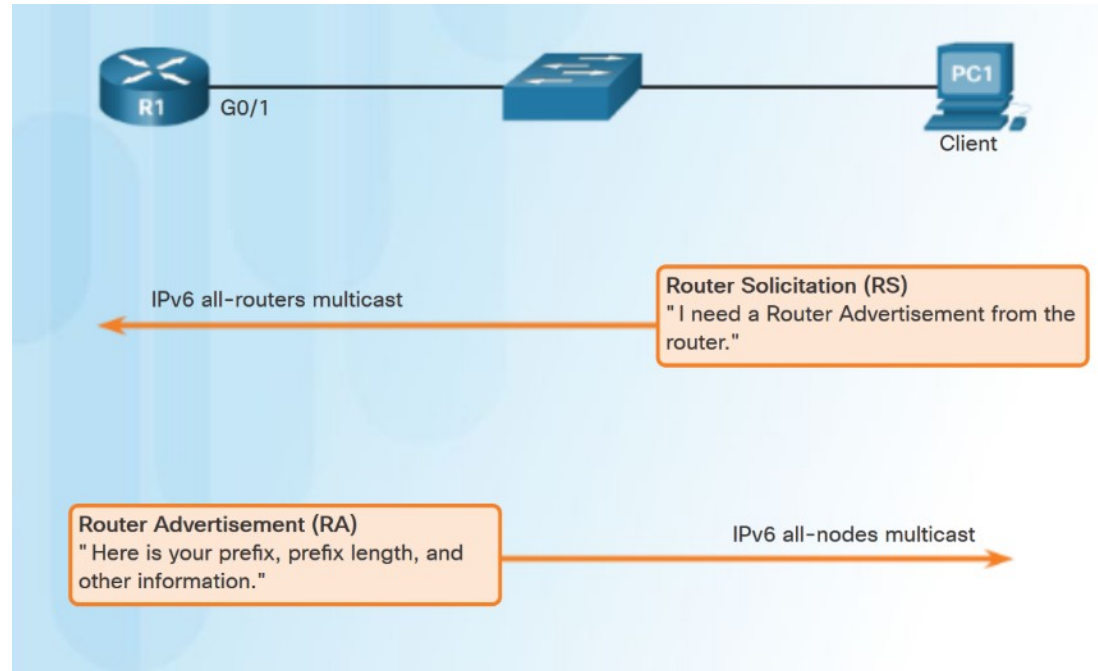

- Two methods to dynamically assign IPv6 global unicast addresses:
 - Stateless Address Autoconfiguration (SLAAC).
 - Dynamic Host Configuration Protocol for IPv6 (Stateful DHCPv6).
- SLAAC uses ICMPv6 Router Solicitation and Router Advertisement messages to provide addressing and other configuration information.

SLAAC and DHCPv6

SLAAC Operation

- The router must have IPv6 routing enabled—**ipv6 unicast-routing**
- PC1 sends an RS message to the all-routers multicast address that it needs an RA.
- R1 responds with an RA message that has the prefix and prefix length of the network.
- PC1 uses this information to create its IPv6 global unicast address. It creates its interface id using EUI-64 or randomly generates it.
- PC1 must verify that the address is unique by sending an ICMPv6 Neighbor Solicitation message.

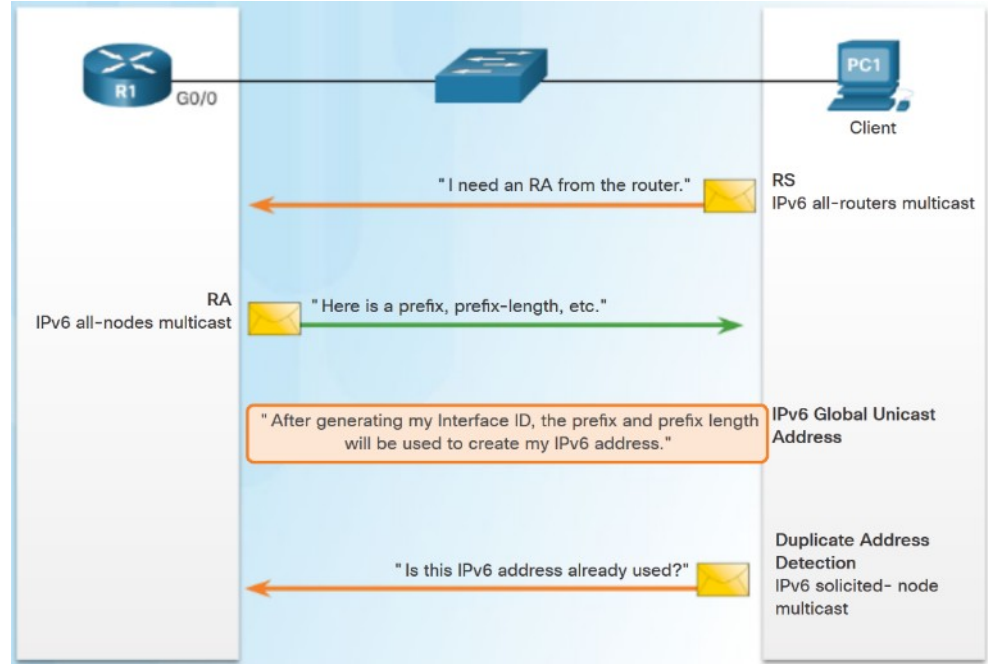

SLAAC and DHCPv6

SLAAC and DHCPv6

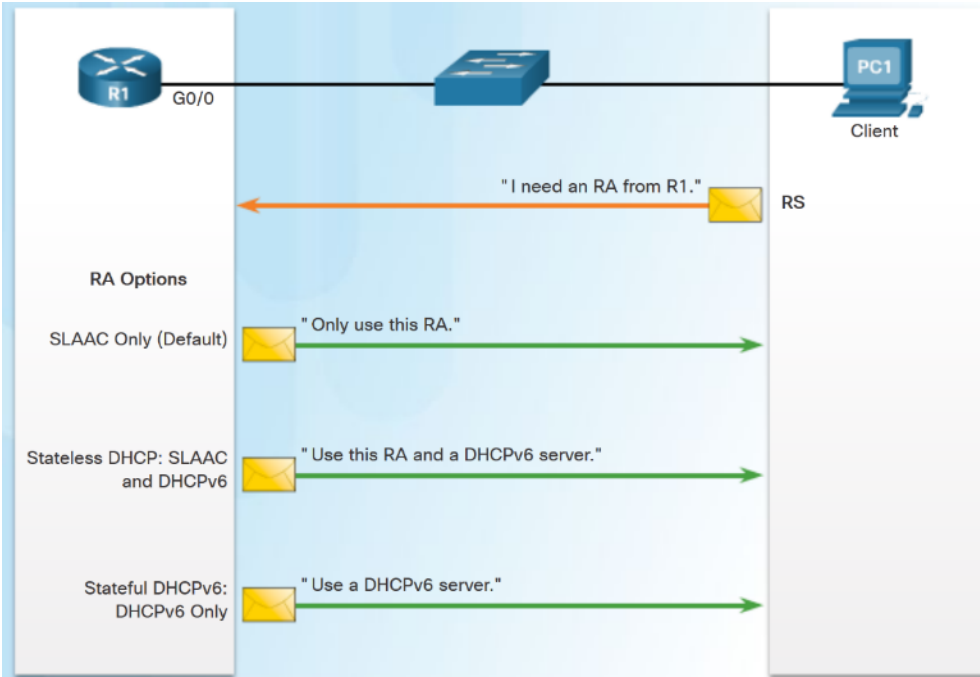

- Different combinations of the Managed Address Configuration flag (M flag) and the Other Configuration flag (O flag) in the RA determine how the IPv6 address is assigned:

- SLAAC (Router Advertisement only)
- Stateless DHCPv6 (Router Advertisement and DHCPv6)
- Stateful DHCPv6 (DHCPv6 only)

SLAAC and DHCPv6

SLAAC Option

- SLAAC is the default on Cisco routers. Both the M flag and the O flag are set to 0 in the RA.
- This option instructs the client to use the information in the RA message only.

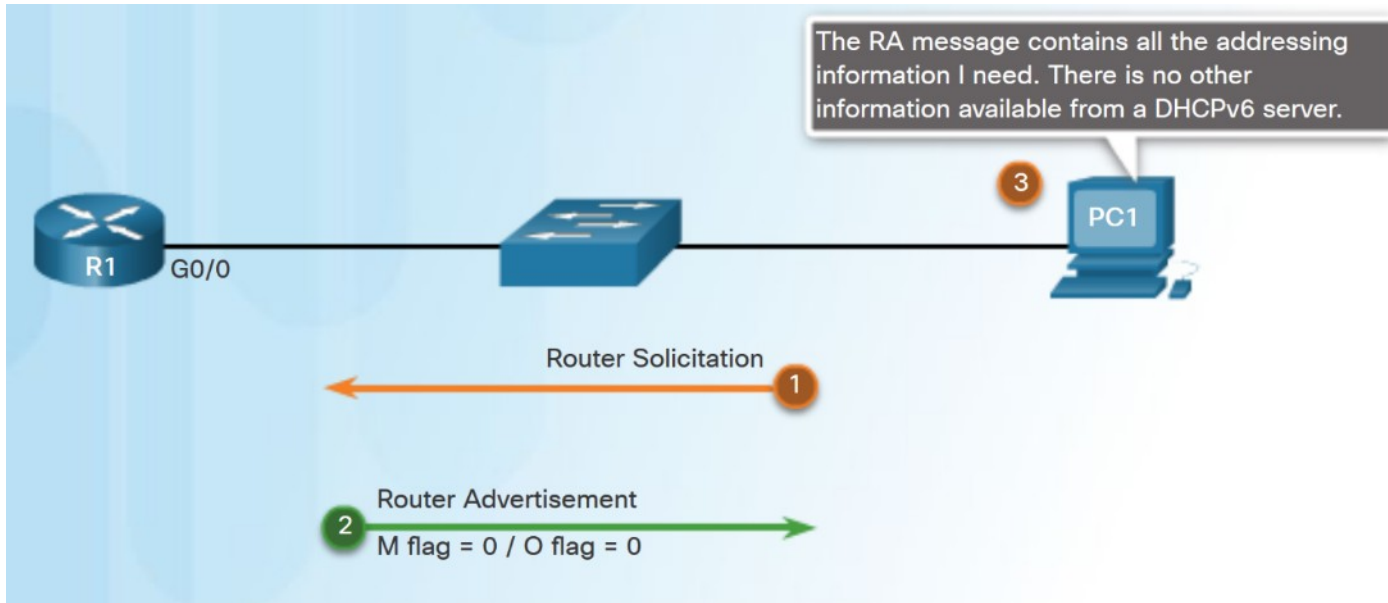

SLAAC and DHCPv6

Stateless DHCPv6 Option

- DHCPv6 is defined in RFC 3315.
- Stateless DHCPv6 option - client uses the RA message for addressing, additional parameters are obtained from DHCPv6 server.
- O flag is set to 1 and the M flag is left at the default setting of 0. Use command **ipv6 nd other-config-flag**.

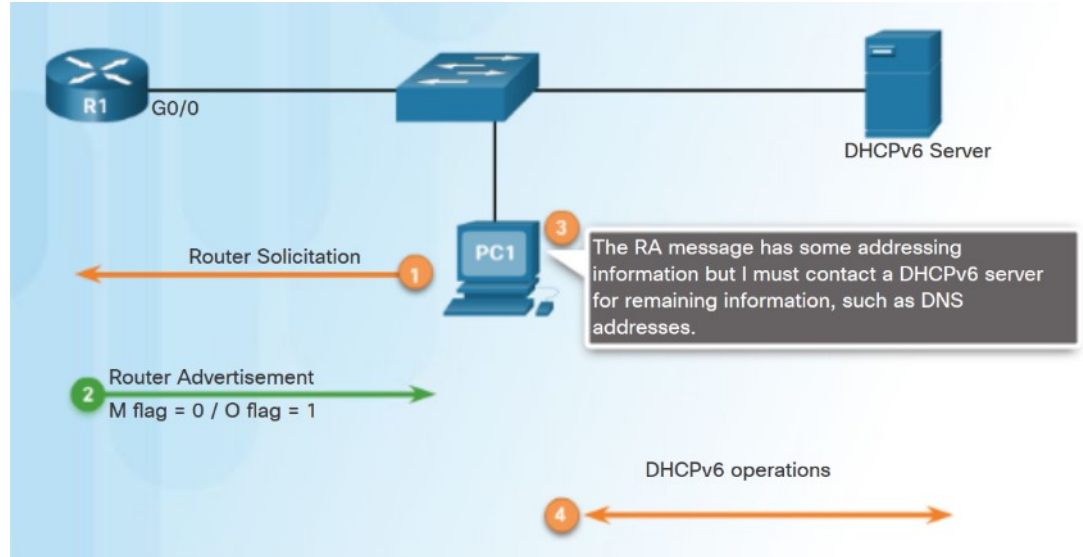

SLAAC and DHCPv6

Stateful DHCPv6 Option

- RA message informs the client not to use the information in the RA message.
- All addressing and configuration information must be obtained from a stateful DHCPv6 server.
- M flag is set to 1. Use the command **ipv6 nd managed-config-flag**.

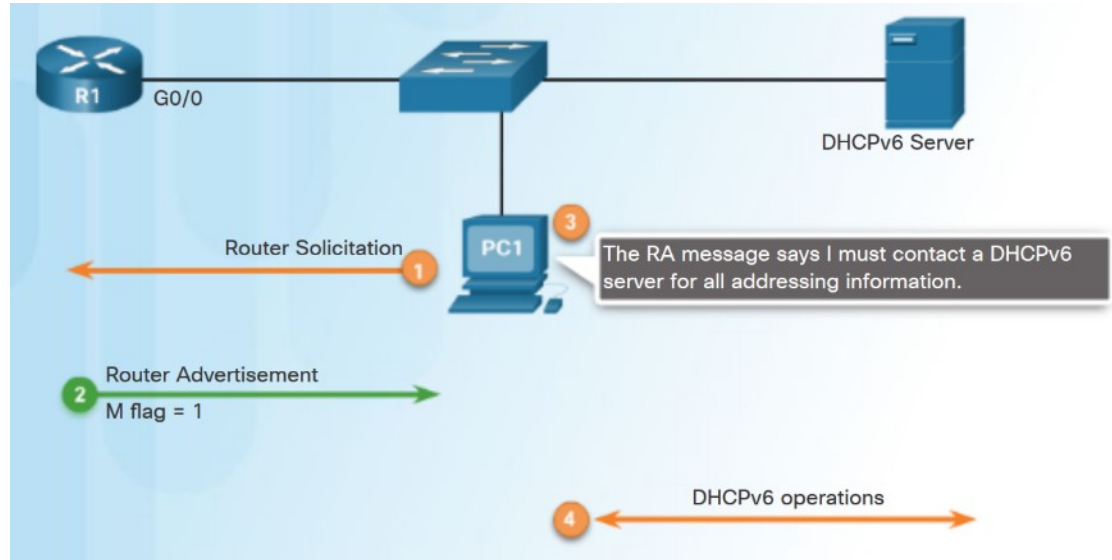

SLAAC and DHCPv6

DHCPv6 Operations

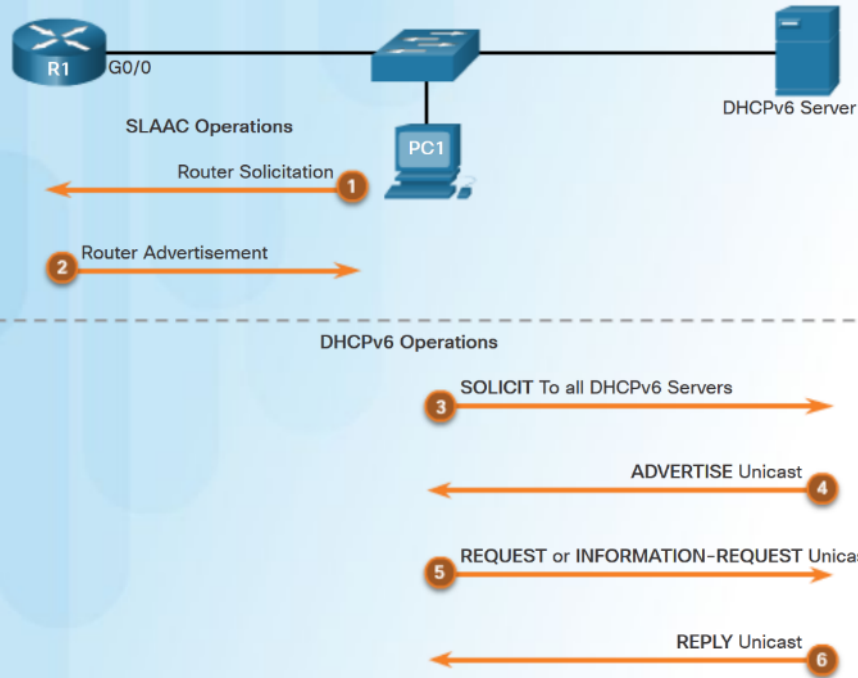

- DHCPv6 messages from server to client use UDP port 546. Client to server use UDP port 547.
- Client sends a DHCPv6 SOLICIT message using FF02::1:2.
- DHCPv6 server responds with a DHCPv6 ADVERTISE unicast message.
- Stateless DHCPv6 client - Generates its own address. Sends a DHCPv6 INFORMATION-REQUEST to the DHCPv6 server requesting only configuration parameters.
- Stateful DHCPv6 client - Sends a DHCPv6 REQUEST message to server for an IPv6 address and all other configuration parameters.

Configuring a Router as a Stateless DHCPv6 Server

- **Step 1** – Enable IPv6 routing. **ipv6 unicast-routing**
- **Step 2** – Configure a DHCPv6 pool. **ipv6 dhcp pool *pool-name***
- **Step 3** – Configure pool parameters. **dns-server *server-address***
- **Step 4** – Configure the DHCPv6 interface **ipv6 dhcp server *pool-name***

```
R1(config)# ipv6 unicast-routing
R1(config)# ipv6 dhcp pool IPV6-STATELESS
R1(config-dhcpv6)# dns-server 2001:db8:cafe:aaaa::5
R1(config-dhcpv6)# domain-name example.com
R1(config-dhcpv6)# exit
R1(config)# interface g0/1
R1(config-if)# ipv6 address 2001:db8:cafe:1::1/64
R1(config-if)# ipv6 dhcp server IPV6-STATELESS
R1(config-if)# ipv6 nd other-config-flag
```

Configuring a Router as a Stateless DHCPv6 Client

- **Step 1** – IPv6 enabled on interface **ipv6 enable**
- **Step 2** – enable automatic configuration of IPv6 addressing **ipv6 address autoconfig**

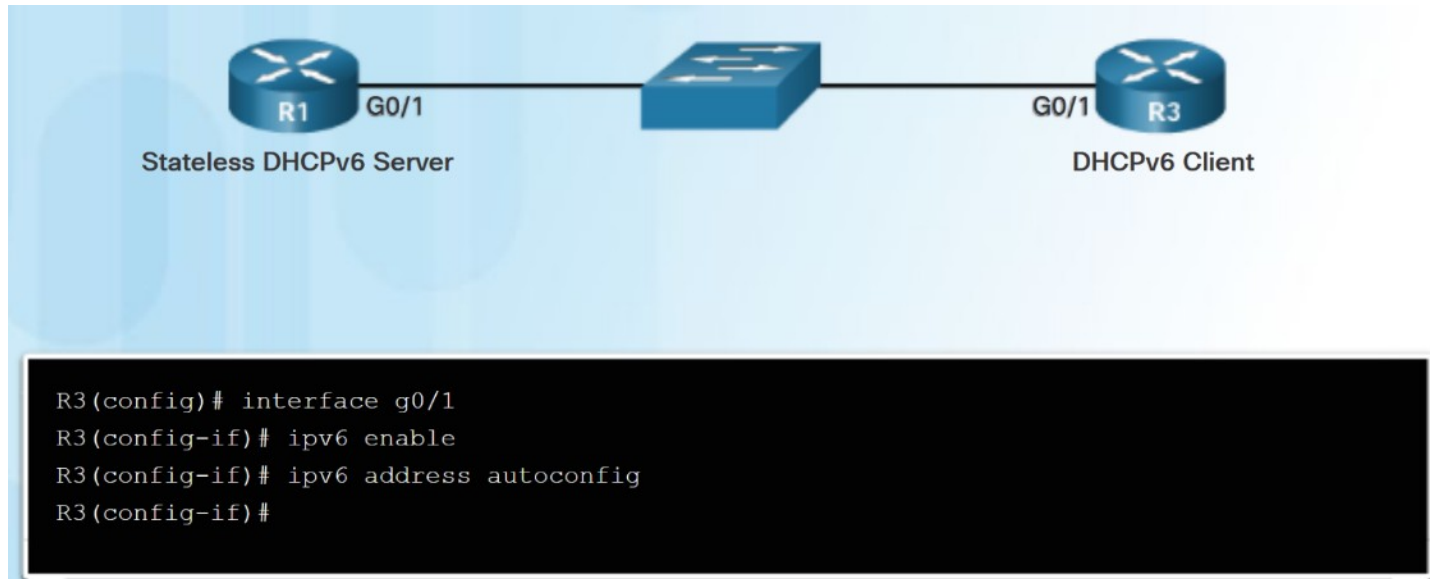

Verifying Stateless DHCPv6

- Commands to verify Stateless DHCPv6:
 - show ipv6 dhcp pool**
 - show running-config**
 - show ipv6 interface**
 - debug ipv6 dhcp detail**

```
R1# show ipv6 dhcp pool
DHCPv6 pool: IPV6-STATELESS
  DNS server: 2001:DB8:CAFE:AAAA::5
  Domain name: example.com
  Active clients: 0
R1#
```

```
R3# show ipv6 interface g0/1
GigabitEthernet0/1 is up, line protocol is up
IPv6 is enabled, link-local address is FE80::32F7:DFF:FE25:2DE1
No Virtual link-local address(es):
Stateless address autoconfig enabled
Global unicast address(es):
  2001:DB8:CAFE:1:32F7:DFF:FE25:2DE1, subnet is 2001:DB8:CAFE:1::/64 [EUI/CAL/PRE]
  valid lifetime 2591935 preferred lifetime 604735
Joined group address(es):
  FE02::1
  FE02::1:FF25:2DE1
MTU is 1500 bytes
ICMP error messages limited to one every 100 milliseconds
ICMP redirects are enabled
ICMP unreachable are sent
ND DAD is enabled, number of DAD attempts: 1
ND reachable time is 30000 milliseconds (using 30000)
ND NS retransmit interval is 1000 milliseconds
Default router is FE80::D68C:B5FF:FECE:A0C1 on
  GigabitEthernet0/1
R3#
```

Configuring a Router as a Stateful DHCPv6 Server

- **Step 1** – Enable IPv6 Routing.
 - **ipv6 unicast routing**
- **Step 2** – Configure a DHCPv6 pool.
 - **ipv6 dhcp pool** *pool-name*
- **Step 3** – Configure pool parameters:
 - **address prefix** *prefix/length*
 - **dns-server** *dns-server-address*
 - **domain-name** *domain-name*
- **Step 4** - Configure DHCPv6 interface:
 - **ipv6 dhcp server** *pool-name*
 - **ipv6 nd managed-config-flag**

```
R1(config)# ipv6 unicast-routing
R1(config)# ipv6 dhcp pool IPV6-STATEFUL
R1(config-dhcpv6)# address prefix 2001:DB8:CAFE:1::/64 lifetime infinite
R1(config-dhcpv6)# dns-server 2001:db8:cafe:aaaa::5
R1(config-dhcpv6)# domain-name example.com
R1(config-dhcpv6)# exit
R1(config)# interface g0/1
R1(config-if)# ipv6 address 2001:db8:cafe:1::1/64
R1(config-if)# ipv6 dhcp server IPV6-STATEFUL
R1(config-if)# ipv6 nd managed-config-flag
```

Configuring a Router as a Stateful DHCPv6 Client

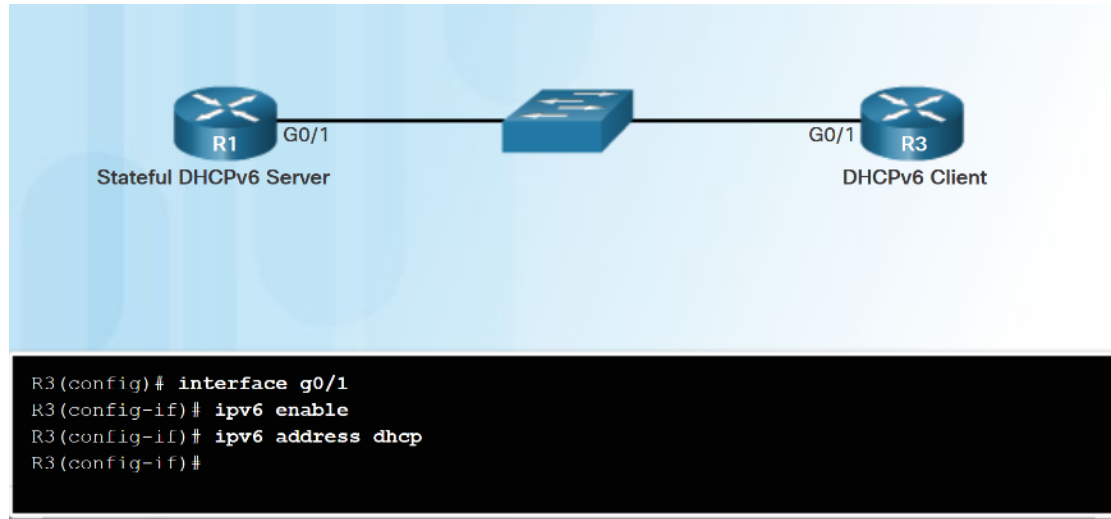

- **Step 1** – Allow the router to send RS messages and participate in DHCPv6.
 - **ipv6 enable**
- **Step 2** – Make the router a DHCPv6 client.
 - **ipv6 address dhcp**

Stateful DHCPv6 Server

Verifying Stateful DHCPv6

- Use the following commands to verify Stateful DHCPv6:
 - **show ipv6 dhcp pool**
 - **show ipv6 dhcp binding**
 - **show ipv6 interface**

```
R1# show ipv6 dhcp binding
Client: FE80::32F7:DFE:FE25:2DE1
DUID: 0003000130F70D252DE0
Username : unassigned
IA NA: IA ID 0x00040001, T1 43200, T2 69120
Address: 2001:DB8:CAFE:1:5844:47B2:2603:C171
        preferred lifetime INFINITY, , valid lifetime INFINITY,
R1#
```

```
R3# show ipv6 interface g0/1
GigabitEthernet0/1 is up, line protocol is up
IPv6 is enabled, link-local address is
FE80::32F7:DFE:FE25:2DE1
No Virtual link-local address(es):
Global unicast address(es):
  2001:DB8:CAFE:1:5844:47B2:2603:C171, subnet is
2001:DB8:CAFE:1:5844:47B2:2603:C171/128
Joined group address(es):
  FF02::1
  FF02::1:FF03:C171
  FF02::1:FF25:2DE1
MTU is 1500 bytes
ICMP error messages limited to one every 100 milliseconds
ICMP redirects are enabled
ICMP unreachable are sent
ND DAD is enabled, number of DAD attempts: 1
ND reachable time is 30000 milliseconds (using 30000)
ND NS retransmit interval is 1000 milliseconds
Default router is FE80::D68C:B5FF:FECE:A0C1 on
GigabitEthernet0/1
R3#
```

Configuring a Router as a DHCPv6 Relay Agent

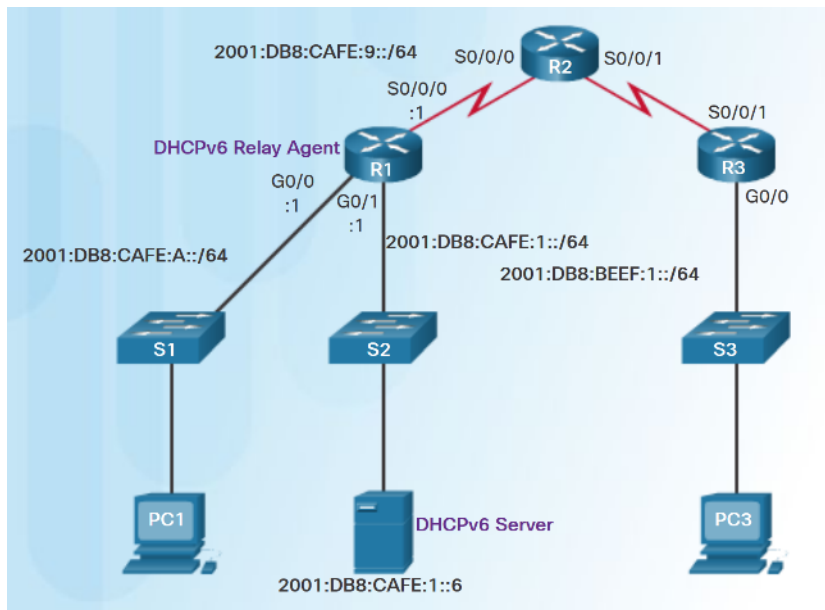

- If the DHCPv6 server is located on a different network than the client, the router can be configured as a DHCPv6 relay agent.

- **ipv6 dhcp relay destination**
destination-address

```
R1(config)# interface g0/0
R1(config-if)# ipv6 dhcp relay destination 2001:db8:cafe:1::6
R1(config-if)# end
R1# show ipv6 dhcp interface g0/0
GigabitEthernet0/0 is in relay mode
Relay destinations:
  2001:DB8:CAFE:1::6
R1#
```

Lab - Configuring Stateless and Stateful DHCPv6



Lab – Configuring Stateless and Stateful DHCPv6

Topology



Addressing Table

Device	Interface	IPv6 Address	Prefix Length	Default Gateway
R1	G0/1	2001:DB8:ACAD:A::1	64	N/A
S1	VLAN 1	Assigned by SLAAC	64	Assigned by SLAAC
PC-A	NIC	Assigned by SLAAC and DHCPv6	64	Assigned by R1

Objectives

Part 1: Build the Network and Configure Basic Device Settings

Part 2: Configure the Network for SLAAC

Part 3: Configure the Network for Stateless DHCPv6

Part 4: Configure the Network for Stateful DHCPv6

Background / Scenario

The dynamic assignment of IPv6 global unicast addresses can be configured in three ways:

- Stateless Address Autoconfiguration (SLAAC) only
- Stateless Dynamic Host Configuration Protocol for IPv6 (DHCPv6)
- Stateful DHCPv6

With SLAAC (pronounced slack), a DHCPv6 server is not needed for hosts to acquire IPv6 addresses. It can be used to receive additional information that the host needs, such as the domain name and the domain name server (DNS) address. When SLAAC is used to assign the IPv6 host addresses and DHCPv6 is used to assign other network parameters, it is called Stateless DHCPv6.

With Stateful DHCPv6, the DHCP server assigns all information, including the host IPv6 address.

Determination of how hosts obtain their dynamic IPv6 addressing information is dependent on flag settings contained within the router advertisement (RA) messages.

In this lab, you will initially configure the network to use SLAAC. After connectivity has been verified, you will configure DHCPv6 settings and change the network to use Stateless DHCPv6. After verification that Stateless

Troubleshooting Tasks

Troubleshooting Task 1	Resolve address conflicts.
Troubleshooting Task 2	Verify allocation method.
Troubleshooting Task 3	Test with a static IPv6 address.
Troubleshooting Task 4	Verify switch port configuration.
Troubleshooting Task 5	Test from the same subnet or VLAN.

Verify Router DHCPv6 Configuration

- Use the **show ipv6 interface** command to verify DHCPv6 configuration.

SLAAC

```
R1# show ipv6 interface g0/1
GigabitEthernet0/1 is up, line protocol is up
  IPv6 is enabled, link-local address is
  FE80::D68C:B5FF:FECE:A0C1
<output omitted>

Hosts use stateless autoconfig for addresses.
```

Stateless DHCPv6

```
R1# show ipv6 interface g0/1
GigabitEthernet0/1 is up, line protocol is up
  IPv6 is enabled, link-local address is FE80::D68C:B5FF:FECE:A0C1
<output omitted>

Hosts use DHCP to obtain other configuration.
```

Stateful DHCPv6

```
R1# show ipv6 interface g0/1
GigabitEthernet0/1 is up, line protocol is up
  IPv6 is enabled, link-local address is FE80::D68C:B5FF:FECE:A0C1
<output omitted>

Hosts use DHCP to obtain routable addresses.
```

Troubleshoot DHCPv6

Debugging DHCPv6

```
R1# debug ipv6 dhcp detail
IPv6 DHCP debugging is on (detailed)
R1#
*Feb  3 21:27:41.123: IPv6 DHCP: Received SOLICIT from FE80::32F7:DFE:FE25:2DE1 on
GigabitEthernet0/1
*Feb  3 21:27:41.123: IPv6 DHCP: detailed packet contents
*Feb  3 21:27:41.123:   src FE80::32F7:DFE:FE25:2DE1 (GigabitEthernet0/1)
*Feb  3 21:27:41.127:   dst FF02::1:2
*Feb  3 21:27:41.127:   type SOLICIT(1), xid 13190645
*Feb  3 21:27:41.127:   option ELAPSED-TIME(8), len 2
*Feb  3 21:27:41.127:     elapsed-time 0
*Feb  3 21:27:41.127:   option CLIENTID(1), len 10
*Feb  3 21:27:41.127:     000
*Feb  3 21:27:41.127: IPv6 DHCP: Using interface pool IPV6-STATEFUL
*Feb  3 21:27:41.127: IPv6 DHCP: Creating binding for FE80::32F7:DFE:FE25:2DE1
in pool IPV6-STATEFUL
<output omitted>
```

- To verify the receipt and transmission of DHCPv6 messages:
 - **debug ipv6 dhcp detail**

Lab - Troubleshooting DHCPv6



Lab - Troubleshooting DHCPv6

Topology



Addressing Table

Device	Interface	IPv6 Address	Prefix Length	Default Gateway
R1	G0/1	2001:DB8:ACAD:A::1	64	N/A
S1	VLAN 1	Assigned by SLAAC	64	Assigned by SLAAC
PC-A	NIC	Assigned by SLAAC and DHCPv6	64	Assigned by SLAAC

Objectives

Part 1: Build the Network and Configure Basic Device Settings

Part 2: Troubleshoot IPv6 Connectivity

Part 3: Troubleshoot Stateless DHCPv6

Background / Scenario

The ability to troubleshoot network issues is a very useful skill for network administrators. It is important to understand IPv6 address groups and how they are used when troubleshooting a network. Knowing what commands to use to extract IPv6 network information is necessary to effectively troubleshoot.

In this lab, you will load configurations on R1 and S1. These configurations will contain issues that prevent Stateless DHCPv6 from functioning on the network. You will troubleshoot R1 and S1 to resolve these issues.

Note: The routers used with CCNA hands-on labs are Cisco 1941 Integrated Services Routers (ISRs) with Cisco IOS Release 15.2(4)M3 (universalk9 image). The switches used are Cisco Catalyst 2960s with Cisco IOS Release 15.0(2) (lanbasek9 image). Other routers, switches and Cisco IOS versions can be used. Depending on the model and Cisco IOS version, the commands available and output produced might vary from what is shown in the labs. Refer to the Router Interface Summary Table at the end of this lab for the correct interface identifiers.

Note: Make sure that the router and switch have been erased and have no startup configurations. If you are unsure, contact your instructor.

Note: The default bias template used by the Switch Database Manager (SDM) does not provide IPv6 address capabilities. Verify that SDM is using either the **dual-ipv4-and-ipv6** template or the **lanbase-routing** template. The new template will be used after reboot even if the configuration is not saved.

8.3 Chapter Summary

Packet Tracer - Skills Integration Challenge



Packet Tracer – Skills Integration Challenge

Topology

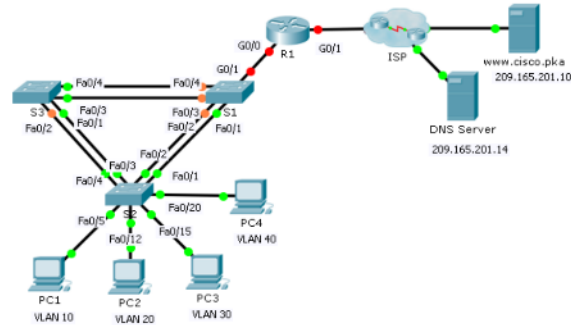

Addressing Table

Device	Interface	IP Address	Subnet Mask	Default Gateway
R1	G0/0.10	172.31.10.1	255.255.255.224	N/A
	G0/0.20	172.31.20.1	255.255.255.240	N/A
	G0/0.30	172.31.30.1	255.255.255.128	N/A
	G0/0.40	172.31.40.1	255.255.255.192	N/A
	G0/1	DHCP Assigned	DHCP Assigned	N/A
PC1	NIC	DHCP Assigned	DHCP Assigned	DHCP Assigned
PC2	NIC	DHCP Assigned	DHCP Assigned	DHCP Assigned
PC3	NIC	DHCP Assigned	DHCP Assigned	DHCP Assigned
PC4	NIC	DHCP Assigned	DHCP Assigned	DHCP Assigned

Chapter 8: DHCP

- Implement DHCPv4 to operate across multiple LANs in a small to medium-sized business network.
- Implement DHCPv6 to operate across multiple LANs in a small to medium-sized business network.

