

# Natural Language Processing with Deep Learning

## CS224N/Ling284

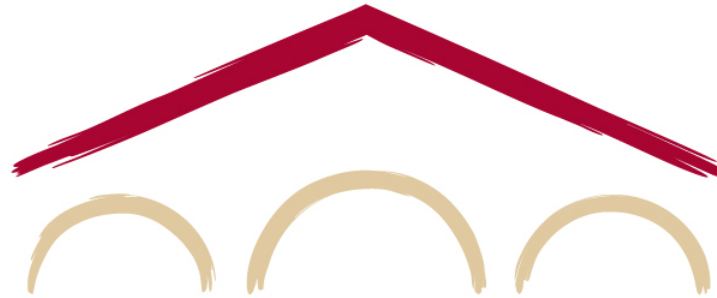

Christopher Manning

Lecture 5: Language Models and Recurrent Neural Networks

(oh, and finish neural dependency parsing 😊)

# Lecture Plan

1. Neural dependency parsing (20 mins)
2. A bit more about neural networks (15 mins)
3. Language modeling + RNNs (45 mins)

- A new NLP task: **Language Modeling**

motivates

- A new family of neural networks: **Recurrent Neural Networks (RNNs)**

These are two of the most important concepts for the rest of the class!

## Reminders:

You should have handed in Assignment 2 by today

In Assignment 3, out today, you build a neural dependency parser using PyTorch

# 1. How do we gain from a neural dependency parser? Indicator Features Revisited

- Problem #1
- Problem #2
- Problem #3

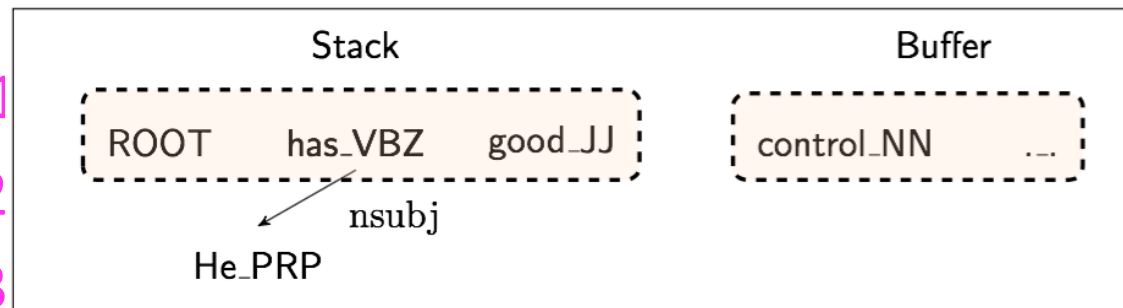

dense

dim = ~1000

0.1 0.9 -0.2 0.3 ... -0.1 -0.5

More than 95% of parsing time is consumed by  
feature computation

**Neural Approach:**

- $s1.w = \text{good} \wedge s1.t = \text{JJ}$
- $s2.w = \text{has} \wedge s2.t = \text{VBZ} \wedge s1.w = \text{good}$
- $lc(s2).t = \text{PRP} \wedge s2.t = \text{VBZ} \wedge s1.t = \text{JJ}$
- $lc(s2).w = \text{He} \wedge lc(s2).l = \text{nsubj} \wedge s2.w = \text{has}$

learn a dense and compact feature representation

# A neural dependency parser [Chen and Manning 2014]

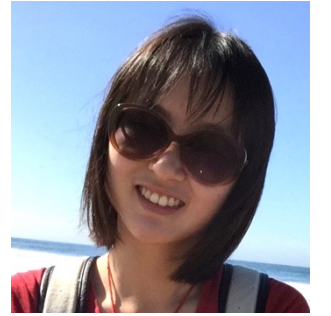

- Results on English parsing to Stanford Dependencies:
  - Unlabeled attachment score (UAS) = head
  - Labeled attachment score (LAS) = head and label

Parser	UAS	LAS	sent. / s
MaltParser	89.8	87.2	469
MSTParser	91.4	88.1	10
TurboParser	<b>92.3</b>	89.6	8
C & M 2014	92.0	<b>89.7</b>	<b>654</b>



# First win: Distributed Representations

- We represent each word as a  $d$ -dimensional dense vector (i.e., word embedding)
  - Similar words are expected to have close vectors.
- Meanwhile, **part-of-speech tags** (POS) and **dependency labels** are also represented as  $d$ -dimensional vectors.
  - The smaller discrete sets also exhibit many semantical similarities.

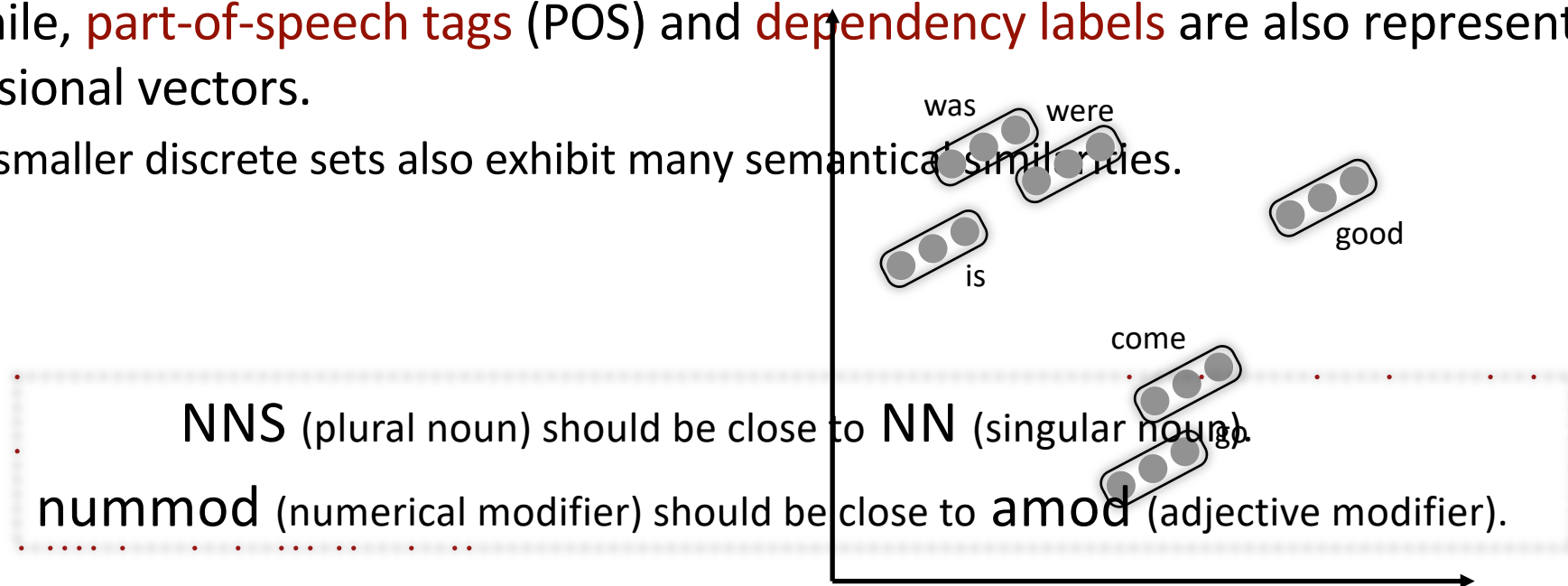

# Extracting Tokens & vector representations from configuration

- We extract a set of tokens based on the stack / buffer positions:

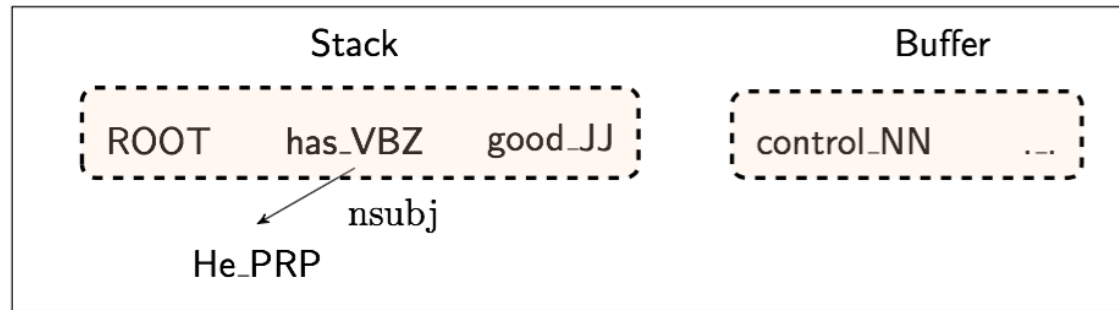

	word	POS	dep.
s1	good	JJ	∅
s2	has	VBZ	∅
b1	control	NN	∅
lc(s1)	∅	+	∅
rc(s1)	∅	∅	∅
lc(s2)	He	PRP	nsubj
rc(s2)	∅	∅	∅



A concatenation of the vector representation of all these is the neural representation of a configuration

# Second win: Deep Learning classifiers are non-linear classifiers

- A **softmax classifier** assigns classes  $y \in \mathcal{C}$  based on inputs  $x \in \mathbb{R}^d$  via the probability:

$$p(y|x) = \frac{\exp(W_y \cdot x)}{\sum_{c=1}^C \exp(W_c \cdot x)}$$

a.k.a. “cross entropy loss”

- We train the weight matrix  $W \in \mathbb{R}^{C \times d}$  to minimize the neg. log loss :  $\sum_i -\log p(y_i|x_i)$
- **Traditional ML classifiers** (including Naïve Bayes, SVMs, logistic regression and softmax classifier) are not very powerful classifiers: they only **give linear decision boundaries**

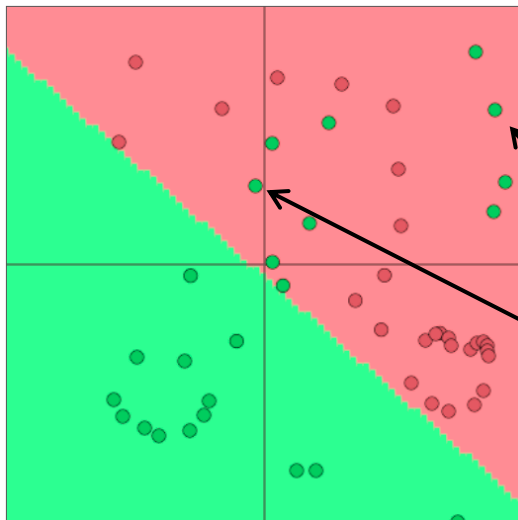

This can be quite limiting

→ Unhelpful when a problem is complex

Wouldn't it be cool to get these correct?

# Neural Networks are more powerful

- Neural networks can learn much more complex functions with nonlinear decision boundaries!
  - Non-linear in the original space, linear for the softmax at the top of the neural network

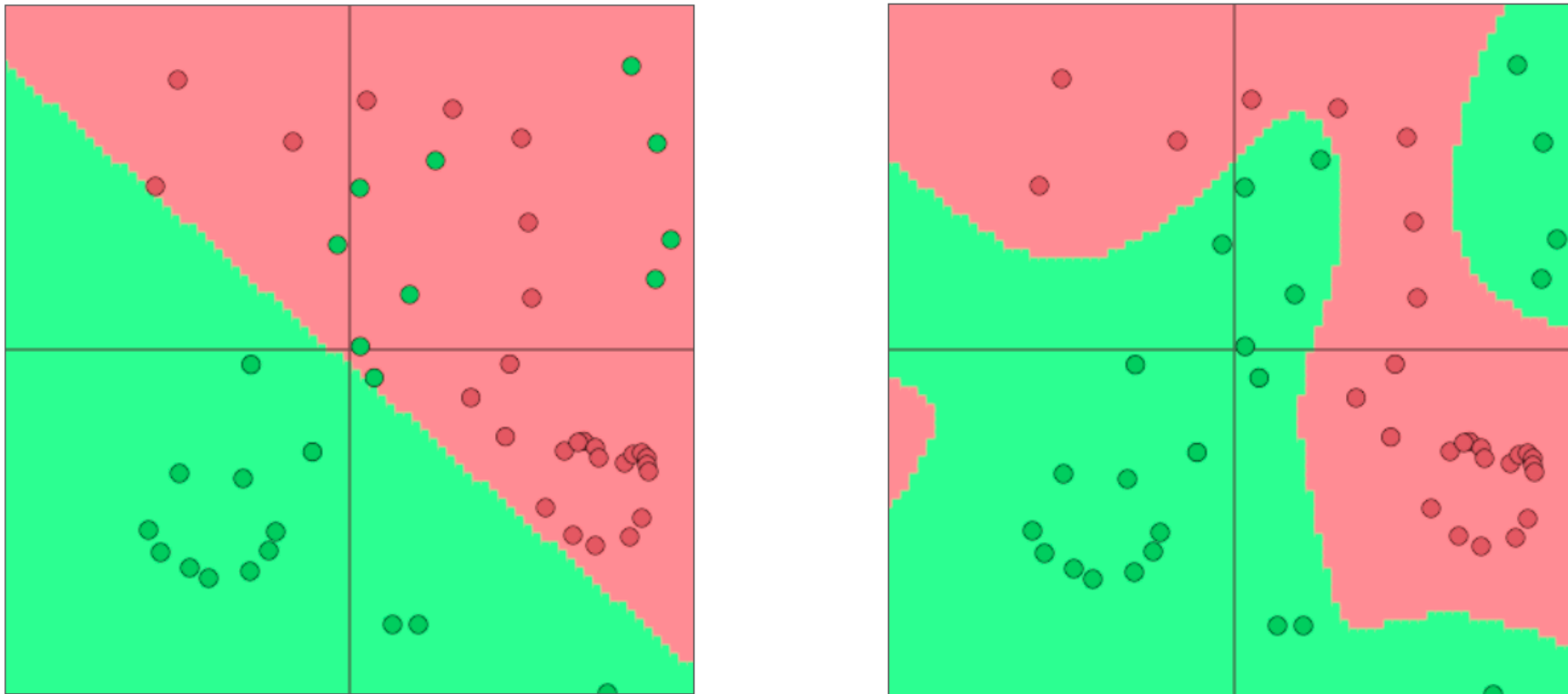

Visualizations with ConvNetJS by Andrej Karpathy!

<http://cs.stanford.edu/people/karpathy/convnetjs/demo/classify2d.html>

# Simple feed-forward neural network multi-class classifier

## Softmax probabilities

Output layer  $y$

$$y = \text{softmax}(Uh + b_2)$$

Hidden layer  $h$

$$h = \text{ReLU}(Wx + b_1)$$

Input layer  $x$

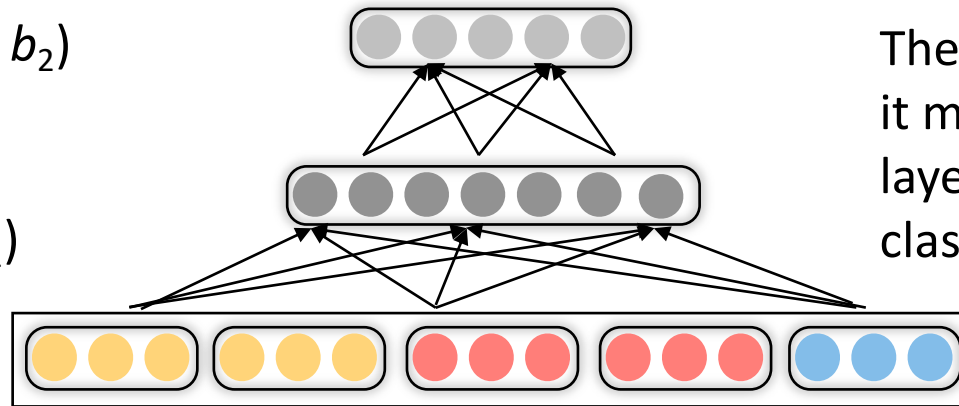

$x$  is result of lookup

$$x_{(j, \dots, j+d)} = Le$$

lookup + concat

Log loss (cross-entropy error) will be back-propagated to the embeddings

The hidden layer re-represents the input — it moves inputs around in an intermediate layer vector space—so it can be easily classified with a (linear) softmax

ReLU = Rectified Linear Unit

$$\text{rect}(z) = \max(z, 0)$$

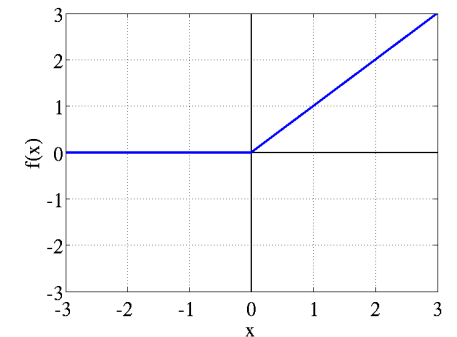

# Neural Dependency Parser Model Architecture

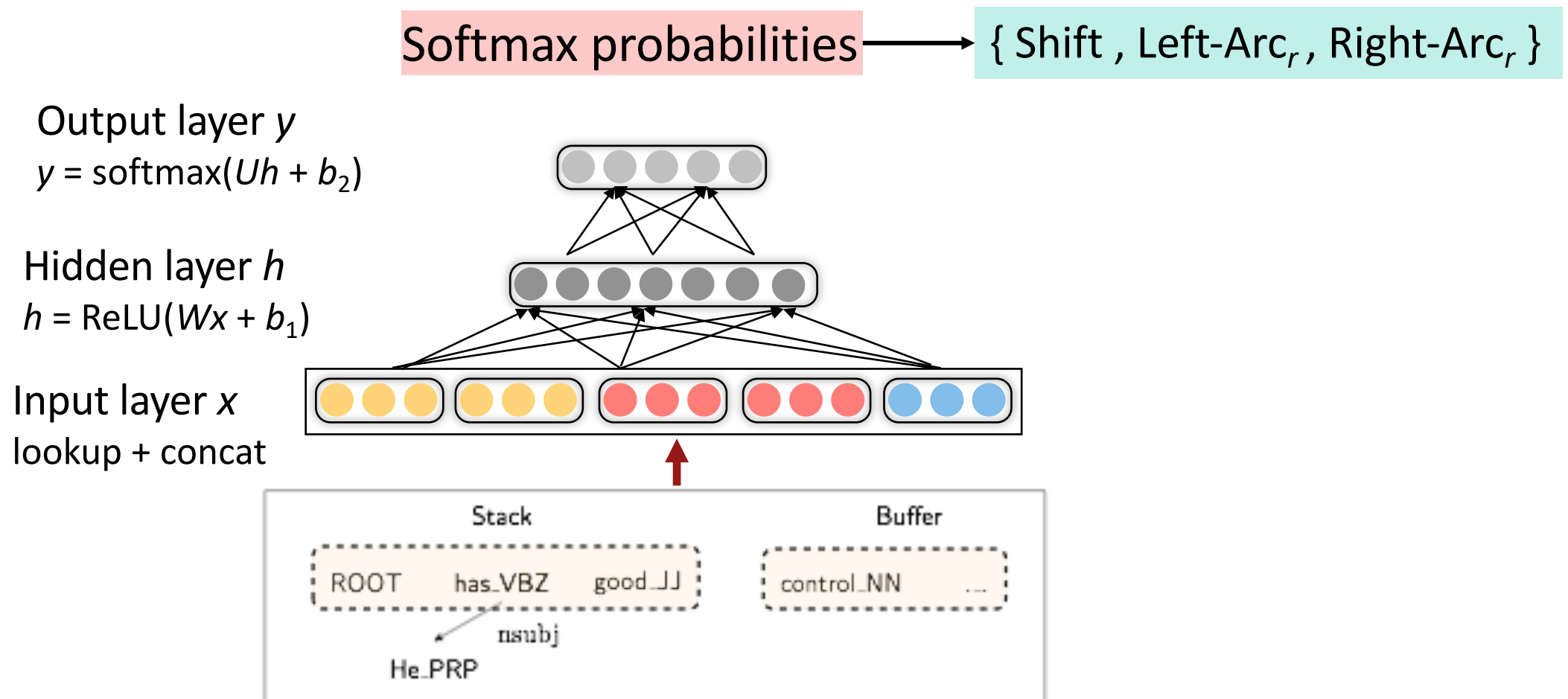

# Dependency parsing for sentence structure

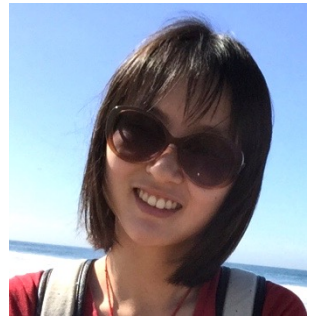

Chen and Manning (2014) showed that neural networks can accurately determine the structure of sentences, supporting meaning interpretation

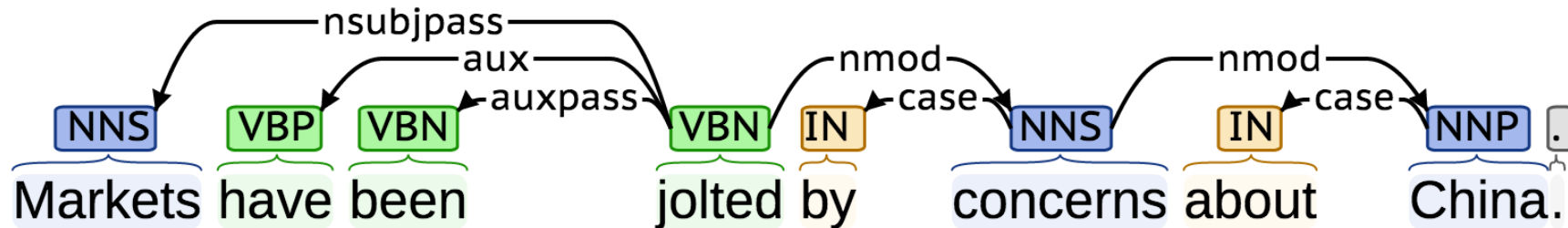

It was the first simple, successful neural dependency parser

The dense representations (and non-linear classifier) let it outperform other greedy parsers in both accuracy and speed

# Further developments in transition-based neural dependency parsing

This work was further developed and improved by others, including in particular at Google

- Bigger, deeper networks with better tuned hyperparameters
- Beam search
- Global, conditional random field (CRF)-style inference over the decision sequence

Leading to SyntaxNet and the Parsey McParseFace model (2016):

“The World’s Most Accurate Parser”

<https://research.googleblog.com/2016/05/announcing-syntaxnet-worlds-most.html>



Method	UAS	LAS (PTB WSJ SD 3.3)
Chen & Manning 2014	92.0	89.7
Weiss et al. 2015	93.99	92.05
Andor et al. 2016	94.61	92.79



# Graph-based dependency parsers

- Compute a score for every possible dependency (choice of head) for each word
  - Doing this well requires more than just knowing the two words
  - We need good “contextual” representations of each word token, which we will develop in the coming lectures
- Repeat the same process for each other word; find the best parse (MST algorithm)

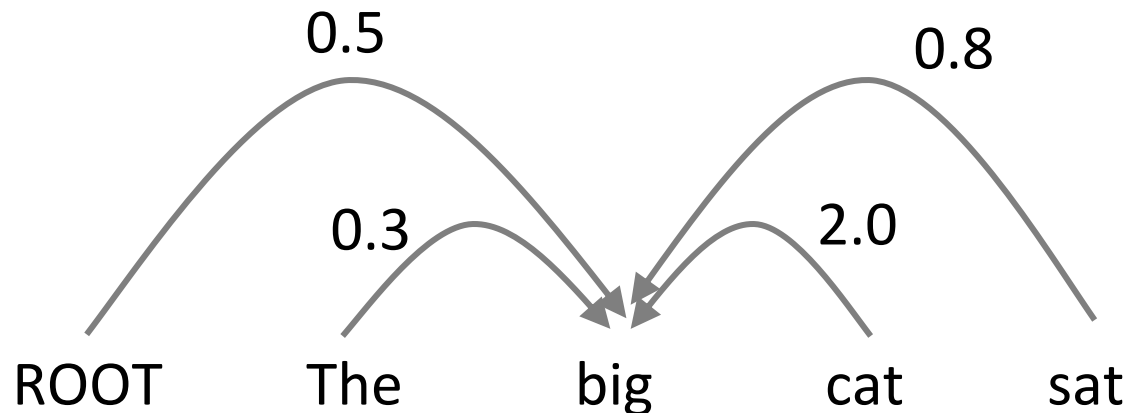

e.g., picking the head for “big”

# Graph-based dependency parsers

- Compute a score for every possible dependency (choice of head) for each word
  - Doing this well requires more than just knowing the two words
  - We need good “contextual” representations of each word token, which we will develop in the coming lectures
- Repeat the same process for each other word; find the best parse (MST algorithm)

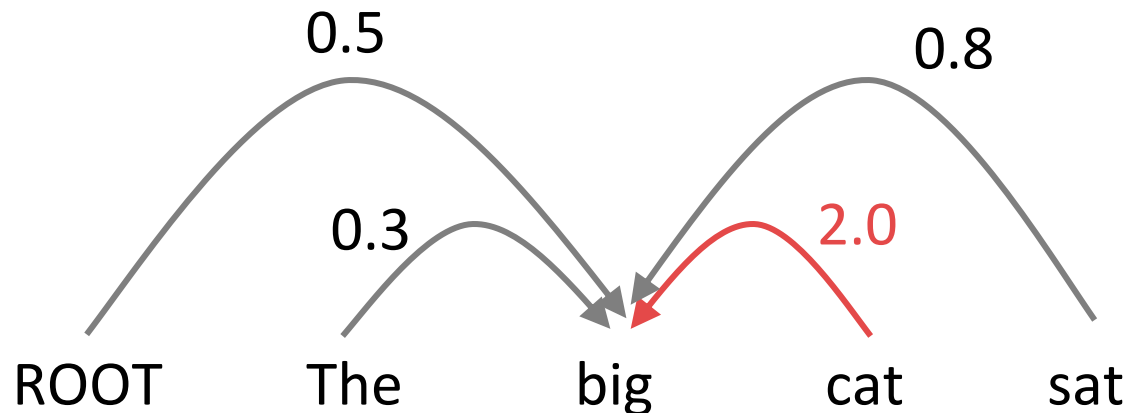

e.g., picking the head for “big”

# A Neural graph-based dependency parser

[Dozat and Manning 2017; Dozat, Qi, and Manning 2017]

- This paper revived interest in graph-based dependency parsing in a neural world
  - Designed a biaffine scoring model for neural dependency parsing
    - Also crucially uses a neural sequence model, something we discuss next week
- Really great results!
  - **But slower than the simple neural transition-based parsers**
    - There are  $n^2$  possible dependencies in a sentence of length  $n$



Method	UAS	LAS (PTB WSJ SD 3.3)
Chen & Manning 2014	92.0	89.7
Weiss et al. 2015	93.99	92.05
Andor et al. 2016	94.61	92.79
<b>Dozat &amp; Manning 2017</b>	<b>95.74</b>	<b>94.08</b>

## 2. A bit more about neural networks

# We have models with many parameters! Regularization!

- A full loss function includes **regularization** over all parameters  $\theta$ , e.g., L2 regularization:

$$J(\theta) = \frac{1}{N} \sum_{i=1}^N -\log \left( \frac{e^{f_{y_i}}}{\sum_{c=1}^C e^{f_c}} \right) + \lambda \sum_k \theta_k^2$$

- Classic view: Regularization works to prevent **overfitting** when we have a lot of features (or later a very powerful/deep model, etc.)
- Now: Regularization **produces models that generalize well** when we have a “big” model
  - We do not care that our models overfit on the training data, even though they are **hugely** overfit

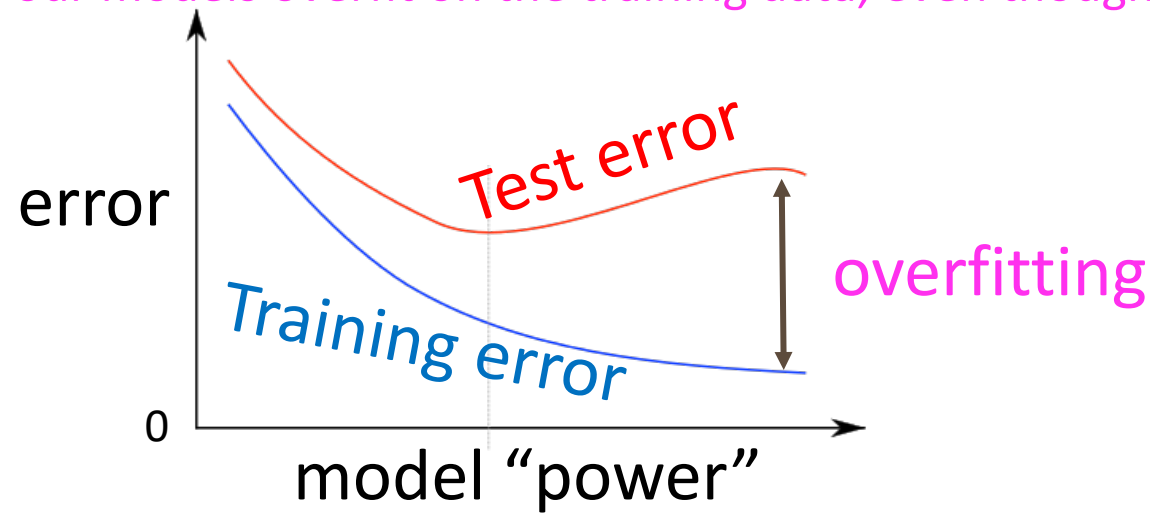

# Dropout (Srivastava, Hinton, Krizhevsky, Sutskever, & Salakhutdinov 2012/JMLR 2014)

Preventing Feature Co-adaptation = Good Regularization Method!

- Training time: at each instance of evaluation (in online SGD-training), randomly set 50% of the inputs to each neuron to 0
- Test time: halve the model weights (now twice as many)
- (Except usually only drop first layer inputs a little (~15%) or not at all)
- This prevents feature co-adaptation: A feature cannot only be useful in the presence of particular other features
- In a single layer: A kind of middle-ground between Naïve Bayes (where all feature weights are set independently) and logistic regression models (where weights are set in the context of all others)
- Can be thought of as a form of model bagging (i.e., like an ensemble model)
- Nowadays usually thought of as strong, feature-dependent regularizer  
[Wager, Wang, & Liang 2013]

# “Vectorization”

- E.g., looping over word vectors versus concatenating them all into one large matrix and then multiplying the softmax weights with that matrix:

```
from numpy import random
N = 500 # number of windows to classify
d = 300 # dimensionality of each window
C = 5 # number of classes
W = random.rand(C,d)
wordvectors_list = [random.rand(d,1) for i in range(N)]
wordvectors_one_matrix = random.rand(d,N)

%timeit [W.dot(wordvectors_list[i]) for i in range(N)]
%timeit W.dot(wordvectors_one_matrix)
```

- 1000 loops, best of 3: **639  $\mu$ s** per loop
- 10000 loops, best of 3: **53.8  $\mu$ s** per loop ← Now using a single a  $C \times N$  matrix
- Matrices are awesome!!! Always try to use vectors and matrices rather than for loops!
- The speed gain goes from 1 to 2 orders of magnitude with GPUs!

# Non-linearities, old and new

logistic (“sigmoid”)

$$f(z) = \frac{1}{1 + \exp(-z)}$$

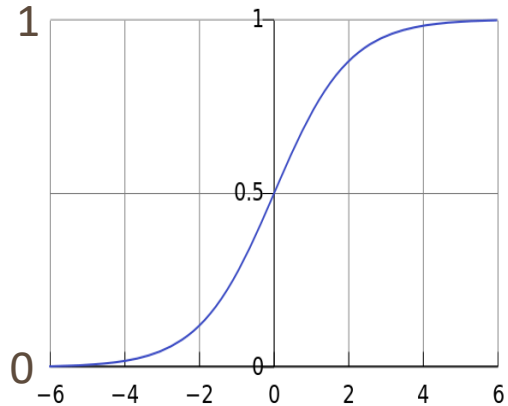

tanh

$$f(z) = \tanh(z) = \frac{e^z - e^{-z}}{e^z + e^{-z}}$$

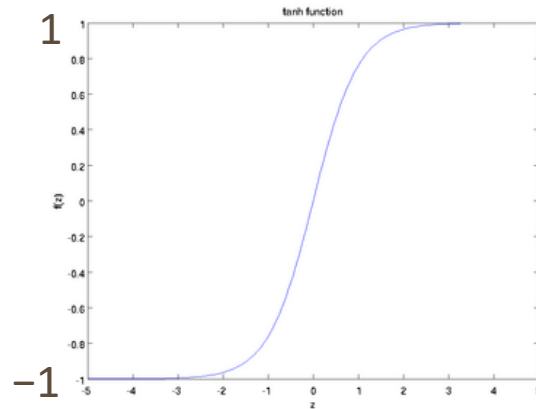

hard tanh

$$\text{HardTanh}(x) = \begin{cases} -1 & \text{if } x < -1 \\ x & \text{if } -1 \leq x \leq 1 \\ 1 & \text{if } x > 1 \end{cases}$$

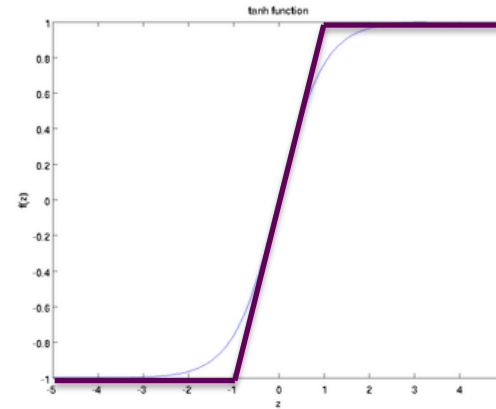

ReLU (Rectified Linear Unit)

$$\text{rect}(z) = \max(z, 0)$$

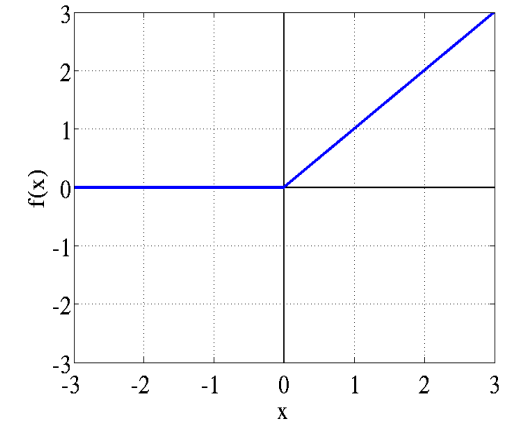

tanh is just a rescaled and shifted sigmoid ( $2 \times$  as steep,  $[-1,1]$ ):

$$\tanh(z) = 2\text{logistic}(2z) - 1$$

Both logistic and tanh are still used in various places (e.g., to get a probability), but are no longer the defaults for making deep networks

For building a deep network, the first thing you should try is ReLU — it trains quickly and performs well due to good gradient backflow

Leaky ReLU /  
Parametric ReLU

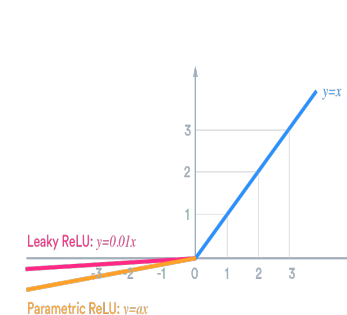

Swish [Ramachandran,  
Zoph & Le 2017]

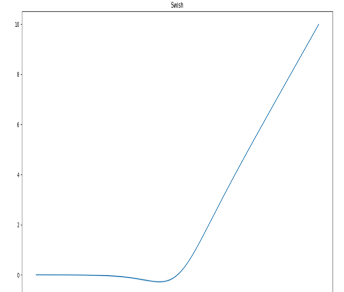



# Parameter Initialization

- You normally must initialize weights to small random values (i.e., not zero matrices!)
  - To avoid symmetries that prevent learning/specialization
- Initialize hidden layer biases to 0 and output (or reconstruction) biases to optimal value if weights were 0 (e.g., mean target or inverse sigmoid of mean target)
- Initialize **all other weights**  $\sim \text{Uniform}(-r, r)$ , with  $r$  chosen so numbers get neither too big or too small [later the need for this is removed with use of layer normalization]
- Xavier initialization has variance inversely proportional to fan-in  $n_{in}$  (previous layer size) and fan-out  $n_{out}$  (next layer size):

$$\text{Var}(W_i) = \frac{2}{n_{in} + n_{out}}$$

# Optimizers

- Usually, plain SGD will work just fine!
  - However, getting good results will often require hand-tuning the learning rate
    - See next slide
- For more complex nets and situations, or just to avoid worry, you often do better with one of a family of more sophisticated “adaptive” optimizers that scale the parameter adjustment by an accumulated gradient.
  - These models give differential per-parameter learning rates
    - Adagrad
    - RMSprop
    - Adam ← A fairly good, safe place to begin in many cases
    - SparseAdam
    - ...

# Learning Rates

- You can just use a constant learning rate. Start around  $lr = 0.001$ ?
  - It must be order of magnitude right – try powers of 10
    - Too big: model may diverge or not converge
    - Too small: your model may not have trained by the assignment deadline
- Better results can generally be obtained by allowing learning rates to decrease as you train
  - By hand: halve the learning rate every  $k$  epochs
    - An epoch = a pass through the data (**shuffled** or sampled – not in same order each time)
  - By a formula:  $lr = lr_0 e^{-kt}$ , for epoch  $t$
  - There are fancier methods like cyclic learning rates (q.v.)
- Fancier optimizers still use a learning rate but it may be an initial rate that the optimizer shrinks – so you may want to start with a higher learning rate

## 3. Language Modeling + RNNs

# Language Modeling

- **Language Modeling** is the task of predicting what word comes next

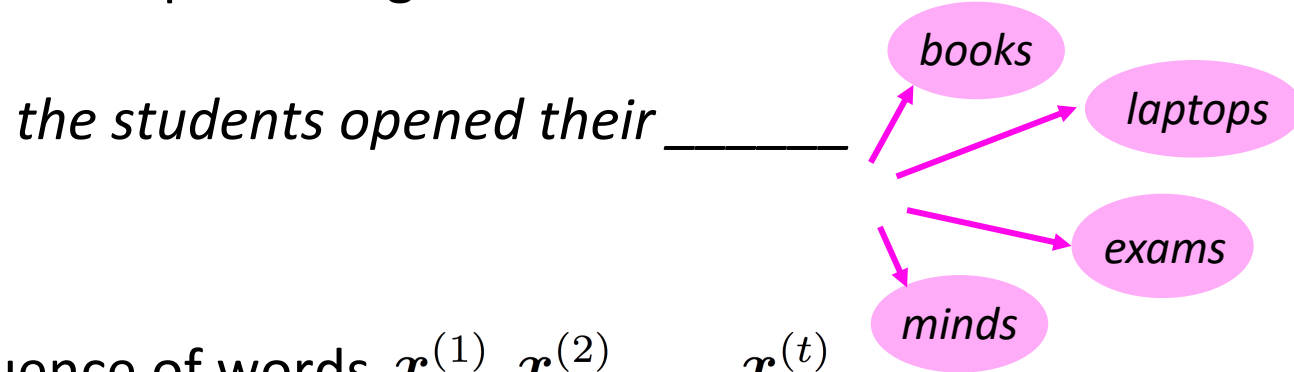

- More formally: given a sequence of words  $\mathbf{x}^{(1)}, \mathbf{x}^{(2)}, \dots, \mathbf{x}^{(t)}$ , compute the probability distribution of the next word  $\mathbf{x}^{(t+1)}$ :

$$P(\mathbf{x}^{(t+1)} \mid \mathbf{x}^{(t)}, \dots, \mathbf{x}^{(1)})$$

where  $\mathbf{x}^{(t+1)}$  can be any word in the vocabulary  $V = \{\mathbf{w}_1, \dots, \mathbf{w}_{|V|}\}$

- A system that does this is called a **Language Model**

# Language Modeling

- You can also think of a Language Model as a system that **assigns probability to a piece of text**
- For example, if we have some text  $\mathbf{x}^{(1)}, \dots, \mathbf{x}^{(T)}$ , then the probability of this text (according to the Language Model) is:

$$\begin{aligned} P(\mathbf{x}^{(1)}, \dots, \mathbf{x}^{(T)}) &= P(\mathbf{x}^{(1)}) \times P(\mathbf{x}^{(2)} | \mathbf{x}^{(1)}) \times \dots \times P(\mathbf{x}^{(T)} | \mathbf{x}^{(T-1)}, \dots, \mathbf{x}^{(1)}) \\ &= \prod_{t=1}^T P(\mathbf{x}^{(t)} | \mathbf{x}^{(t-1)}, \dots, \mathbf{x}^{(1)}) \end{aligned}$$

  
This is what our LM provides

# You use Language Models every day!

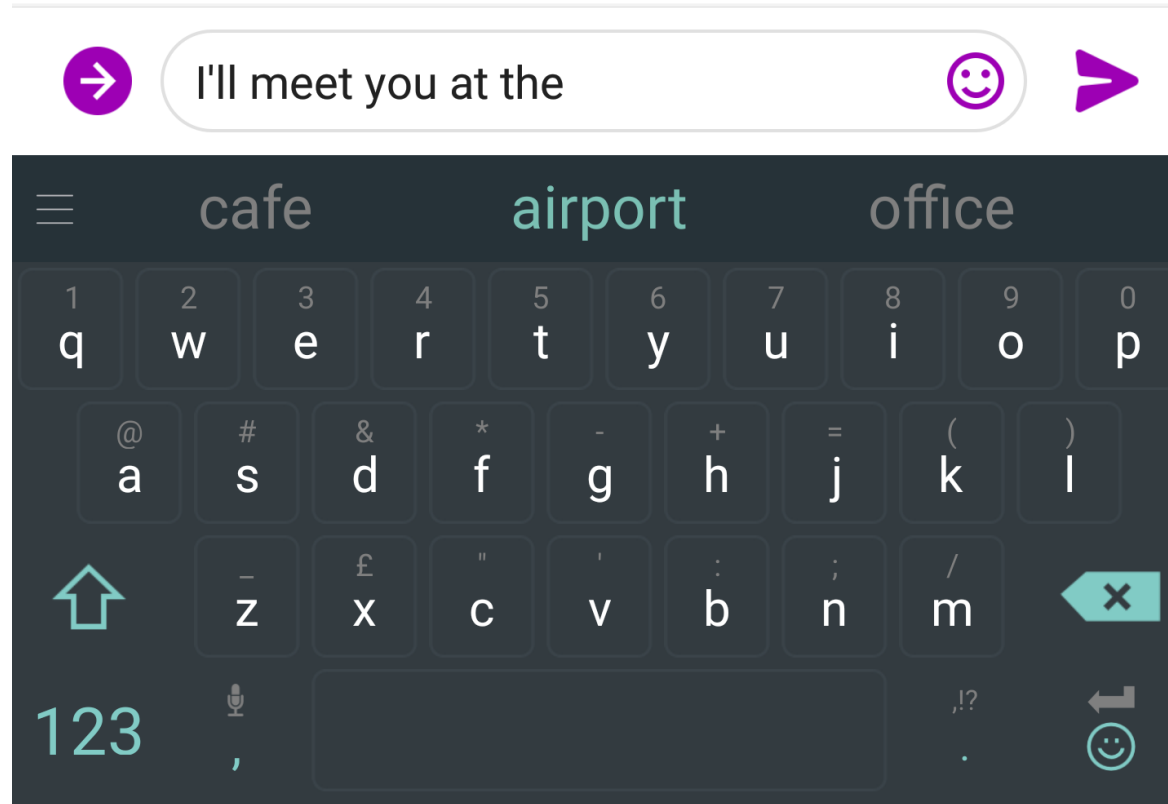

# You use Language Models every day!



what is the | 

- what is the **weather**
- what is the **meaning of life**
- what is the **dark web**
- what is the **xfl**
- what is the **doomsday clock**
- what is the **weather today**
- what is the **keto diet**
- what is the **american dream**
- what is the **speed of light**
- what is the **bill of rights**

[Google Search](#) [I'm Feeling Lucky](#)



# n-gram Language Models

*the students opened their \_\_\_\_\_*

- **Question:** How to learn a Language Model?
- **Answer** (pre- Deep Learning): learn an *n*-gram Language Model!
- **Definition:** A *n*-gram is a chunk of *n* consecutive words.
  - **unigrams:** “the”, “students”, “opened”, “their”
  - **bigrams:** “the students”, “students opened”, “opened their”
  - **trigrams:** “the students opened”, “students opened their”
  - **4-grams:** “the students opened their”
- **Idea:** Collect statistics about how frequent different n-grams are and use these to predict next word.

# n-gram Language Models

- First we make a **Markov assumption**:  $x^{(t+1)}$  depends only on the preceding  $n-1$  words

$$P(\mathbf{x}^{(t+1)} | \mathbf{x}^{(t)}, \dots, \mathbf{x}^{(1)}) = P(\mathbf{x}^{(t+1)} | \overbrace{\mathbf{x}^{(t)}, \dots, \mathbf{x}^{(t-n+2)}}^{n-1 \text{ words}}) \quad (\text{assumption})$$

prob of a n-gram  $\rightarrow$

$$= P(\mathbf{x}^{(t+1)}, \mathbf{x}^{(t)}, \dots, \mathbf{x}^{(t-n+2)})$$

prob of a (n-1)-gram  $\rightarrow$

$$P(\mathbf{x}^{(t)}, \dots, \mathbf{x}^{(t-n+2)}) \quad (\text{definition of conditional prob})$$

- **Question:** How do we get these  $n$ -gram and  $(n-1)$ -gram probabilities?
- **Answer:** By **counting** them in some large corpus of text!

$$\approx \frac{\text{count}(\mathbf{x}^{(t+1)}, \mathbf{x}^{(t)}, \dots, \mathbf{x}^{(t-n+2)})}{\text{count}(\mathbf{x}^{(t)}, \dots, \mathbf{x}^{(t-n+2)})} \quad (\text{statistical approximation})$$

# n-gram Language Models: Example

Suppose we are learning a 4-gram Language Model.

~~as the proctor started the clock, the~~ *students opened their* \_\_\_\_\_  
discard } condition on this

$$P(\mathbf{w} | \text{students opened their}) = \frac{\text{count}(\text{students opened their } \mathbf{w})}{\text{count}(\text{students opened their})}$$

For example, suppose that in the corpus:

- “students opened their” occurred 1000 times
- “students opened their *books*” occurred 400 times
  - $\rightarrow P(\text{books} | \text{students opened their}) = 0.4$
- “students opened their *exams*” occurred 100 times
  - $\rightarrow P(\text{exams} | \text{students opened their}) = 0.1$

Should we have discarded the “proctor” context?

# Sparsity Problems with n-gram Language Models

## Sparsity Problem 1

**Problem:** What if “students opened their  $w$ ” never occurred in data? Then  $w$  has probability 0!

**(Partial) Solution:** Add small  $\delta$  to the count for every  $w \in V$ . This is called *smoothing*.

$$P(w|\text{students opened their}) = \frac{\text{count}(\text{students opened their } w)}{\text{count}(\text{students opened their})}$$

## Sparsity Problem 2

**Problem:** What if “students opened their” never occurred in data? Then we can’t calculate probability for *any*  $w$ !

**(Partial) Solution:** Just condition on “opened their” instead. This is called *backoff*.

**Note:** Increasing  $n$  makes sparsity problems worse. Typically, we can’t have  $n$  bigger than 5.

# Storage Problems with $n$ -gram Language Models

**Storage:** Need to store count for all  $n$ -grams you saw in the corpus.

$$P(\mathbf{w}|\text{students opened their}) = \frac{\text{count}(\text{students opened their } \mathbf{w})}{\text{count}(\text{students opened their})}$$

Increasing  $n$  or increasing corpus increases model size!

# n-gram Language Models in practice

- You can build a simple trigram Language Model over a 1.7 million word corpus (Reuters) in a few seconds on your laptop\*

Business and financial news

today the \_\_\_\_\_

get probability distribution

company	0.153
bank	0.153
price	0.077
italian	0.039
emirate	0.039
...	

**Sparsity problem:**  
not much granularity  
in the probability  
distribution

Otherwise, seems reasonable!

\* Try for yourself: <https://nlpforhackers.io/language-models/>

# Generating text with a n-gram Language Model

You can also use a Language Model to generate text

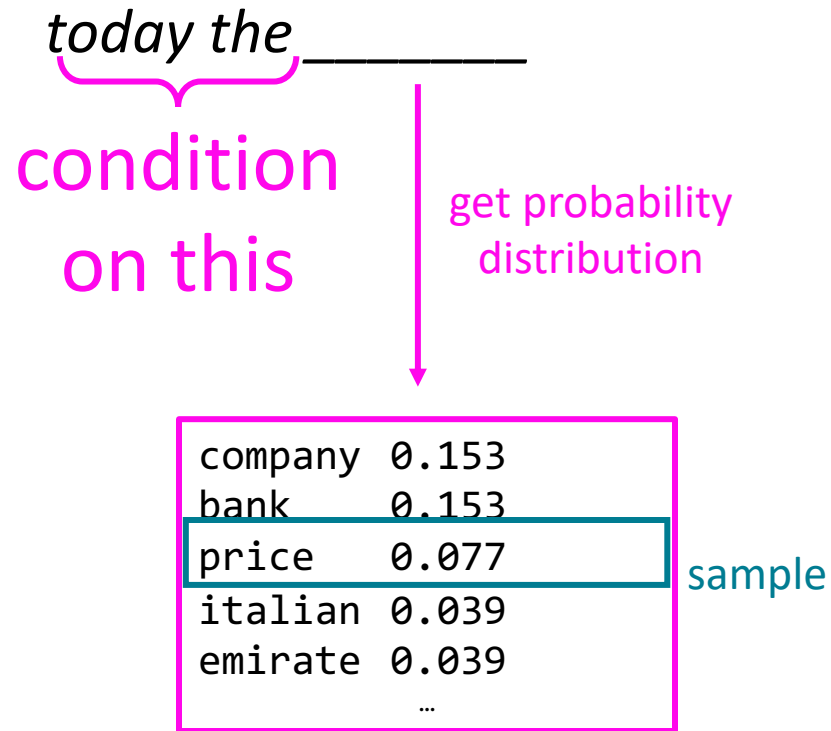

# Generating text with a n-gram Language Model

You can also use a Language Model to generate text

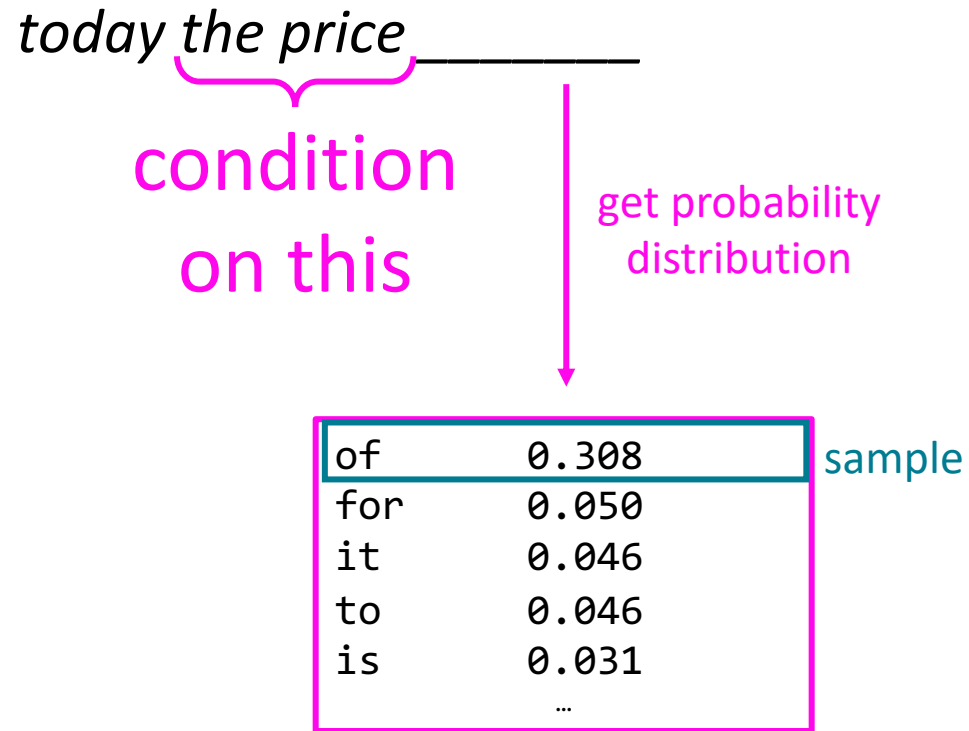



# Generating text with a n-gram Language Model

You can also use a Language Model to generate text

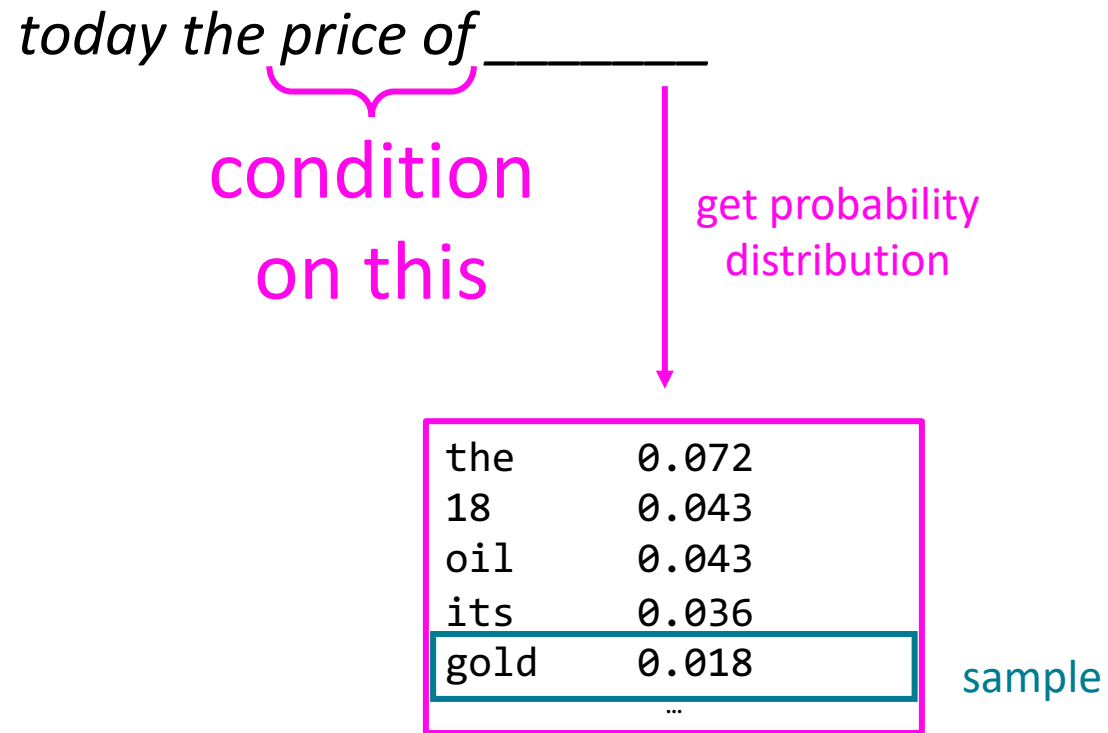

# Generating text with a n-gram Language Model

You can also use a Language Model to generate text

*today the price of gold per ton , while production of shoe lasts and shoe industry , the bank intervened just after it considered and rejected an imf demand to rebuild depleted european stocks , sept 30 end primary 76 cts a share .*

Surprisingly grammatical!

...but **incoherent**. We need to consider more than three words at a time if we want to model language well.

But increasing  $n$  worsens sparsity problem,  
and increases model size...

# How to build a *neural* Language Model?

- Recall the Language Modeling task:
  - Input: sequence of words  $x^{(1)}, x^{(2)}, \dots, x^{(t)}$
  - Output: prob dist of the next word  $P(x^{(t+1)} | x^{(t)}, \dots, x^{(1)})$
- How about a **window-based neural model**?
  - We saw this applied to Named Entity Recognition in Lecture 3:

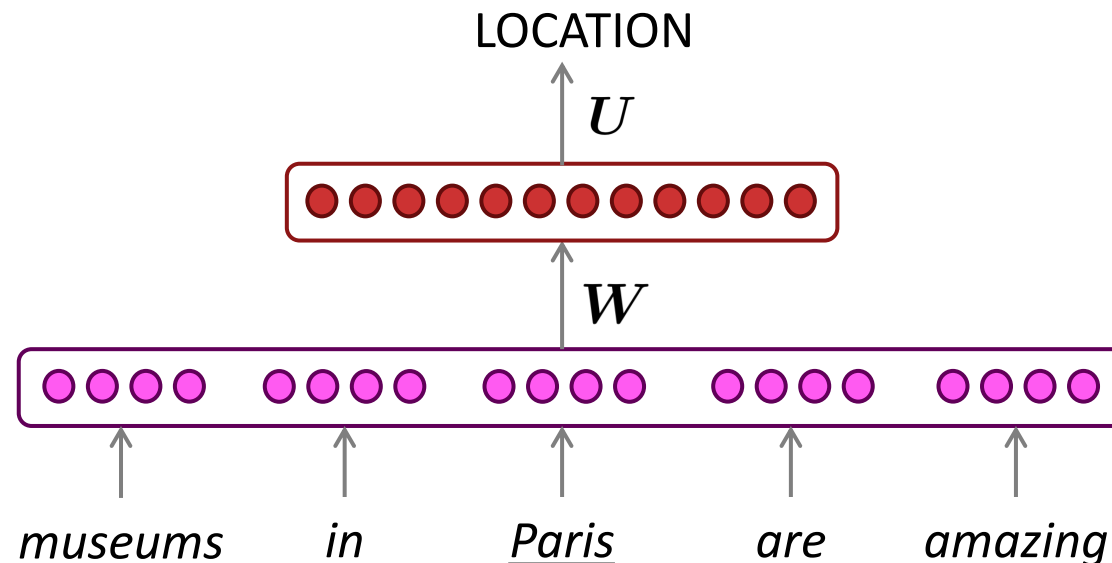

# A fixed-window neural Language Model

~~as the proctor started the clock~~  
discard

the students opened their \_\_\_\_\_  
fixed window

# A fixed-window neural Language Model

output distribution

$$\hat{y} = \text{softmax}(U\mathbf{h} + \mathbf{b}_2) \in \mathbb{R}^{|V|}$$

hidden layer

$$\mathbf{h} = f(\mathbf{W}\mathbf{e} + \mathbf{b}_1)$$

concatenated word embeddings

$$\mathbf{e} = [\mathbf{e}^{(1)}; \mathbf{e}^{(2)}; \mathbf{e}^{(3)}; \mathbf{e}^{(4)}]$$

words / one-hot vectors

$$\mathbf{x}^{(1)}, \mathbf{x}^{(2)}, \mathbf{x}^{(3)}, \mathbf{x}^{(4)}$$

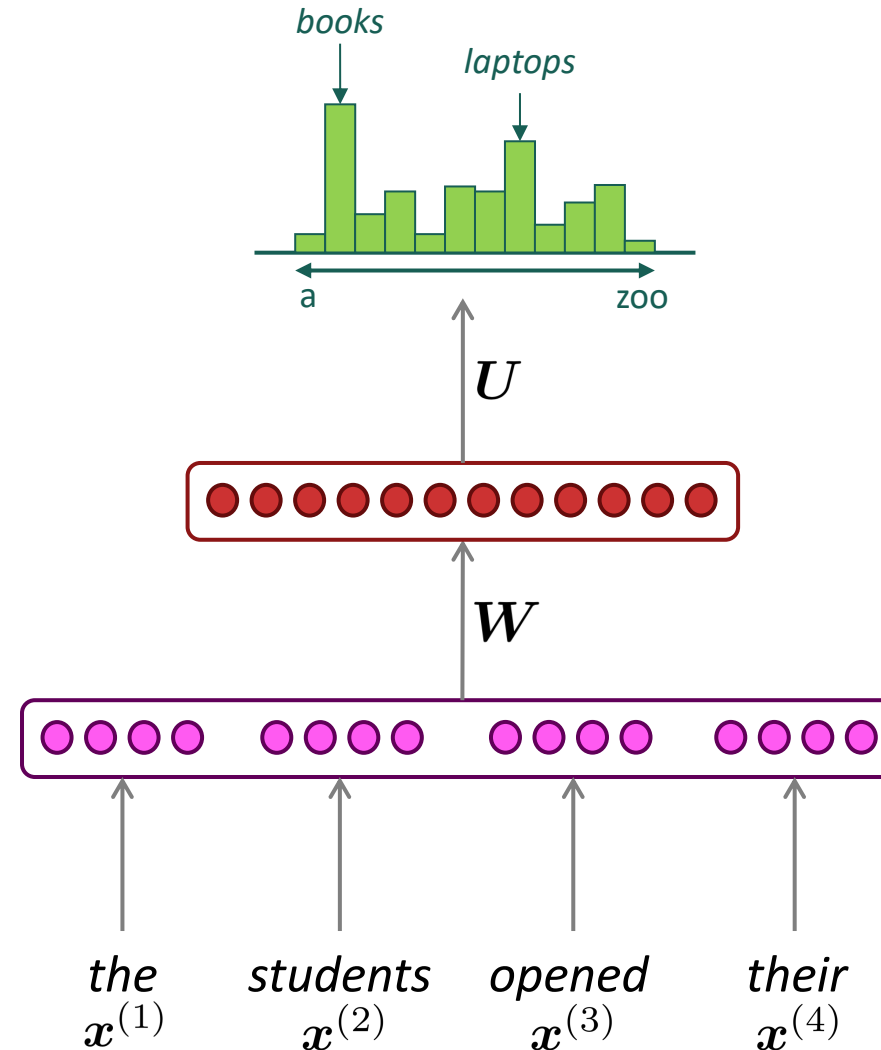

# A fixed-window neural Language Model

Approximately: Y. Bengio, et al. (2000/2003): A Neural Probabilistic Language Model

**Improvements** over  $n$ -gram LM:

- No sparsity problem
- Don't need to store all observed  $n$ -grams

Remaining **problems**:

- Fixed window is **too small**
  - Enlarging window enlarges  $W$
  - Window can never be large enough!
  - $x^{(1)}$  and  $x^{(2)}$  are multiplied by completely different weights in  $W$ .
- No symmetry** in how the inputs are processed.

We need a neural architecture that can process *any length input*

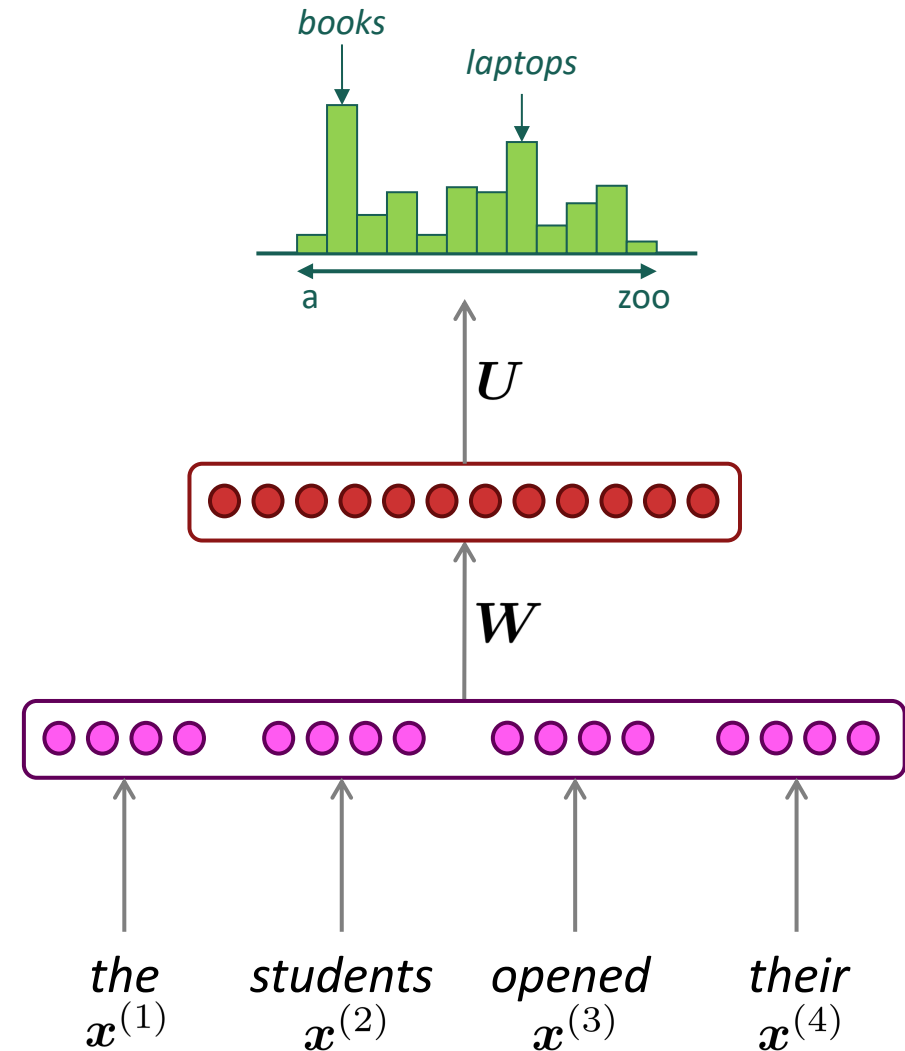

# Recurrent Neural Networks (RNN)

A family of neural architectures

**Core idea:** Apply the same weights  $W$  repeatedly

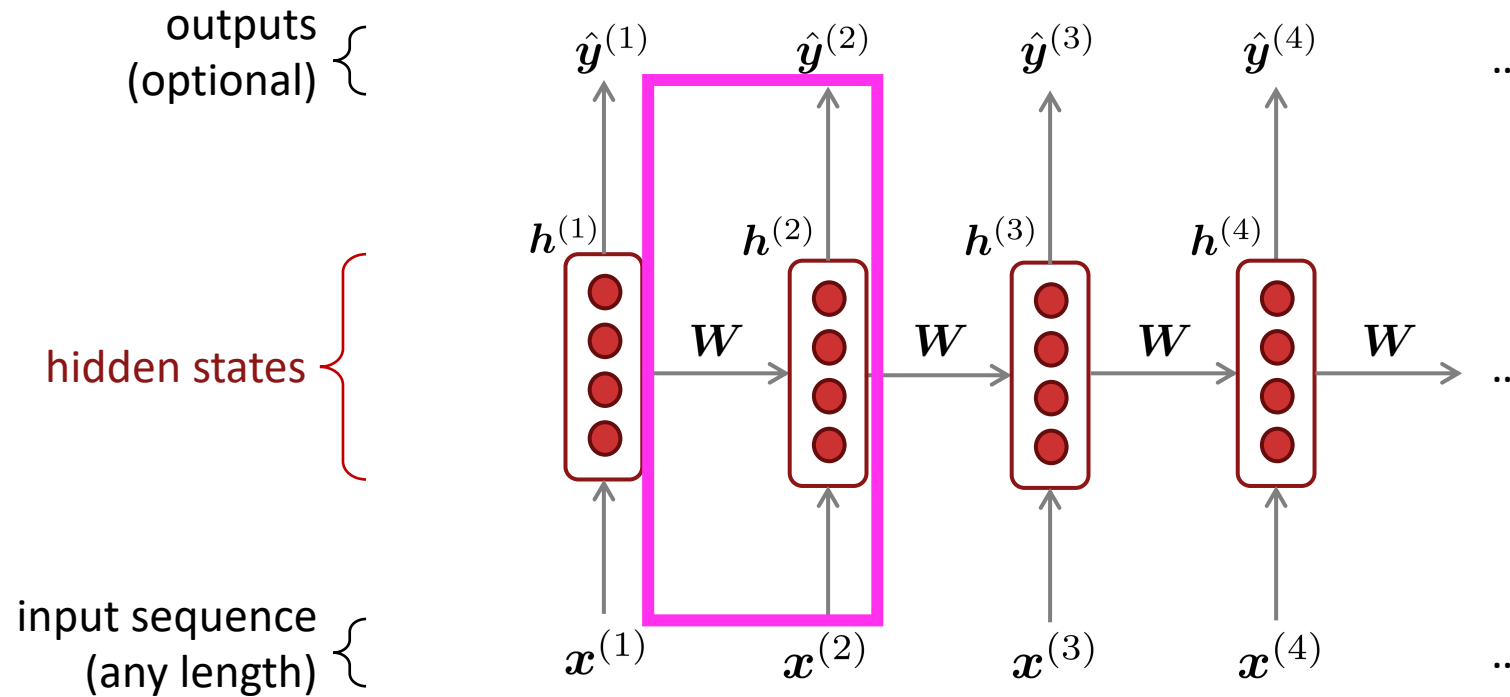

# A Simple RNN Language Model

$$\hat{y}^{(4)} = P(x^{(5)} | \text{the students opened their})$$

output distribution

$$\hat{y}^{(t)} = \text{softmax}(U\mathbf{h}^{(t)} + \mathbf{b}_2) \in \mathbb{R}^{|V|}$$

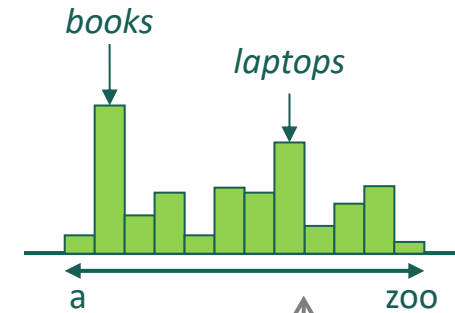

hidden states

$$\mathbf{h}^{(t)} = \sigma(\mathbf{W}_h \mathbf{h}^{(t-1)} + \mathbf{W}_e \mathbf{e}^{(t)} + \mathbf{b}_1)$$

$\mathbf{h}^{(0)}$  is the initial hidden state

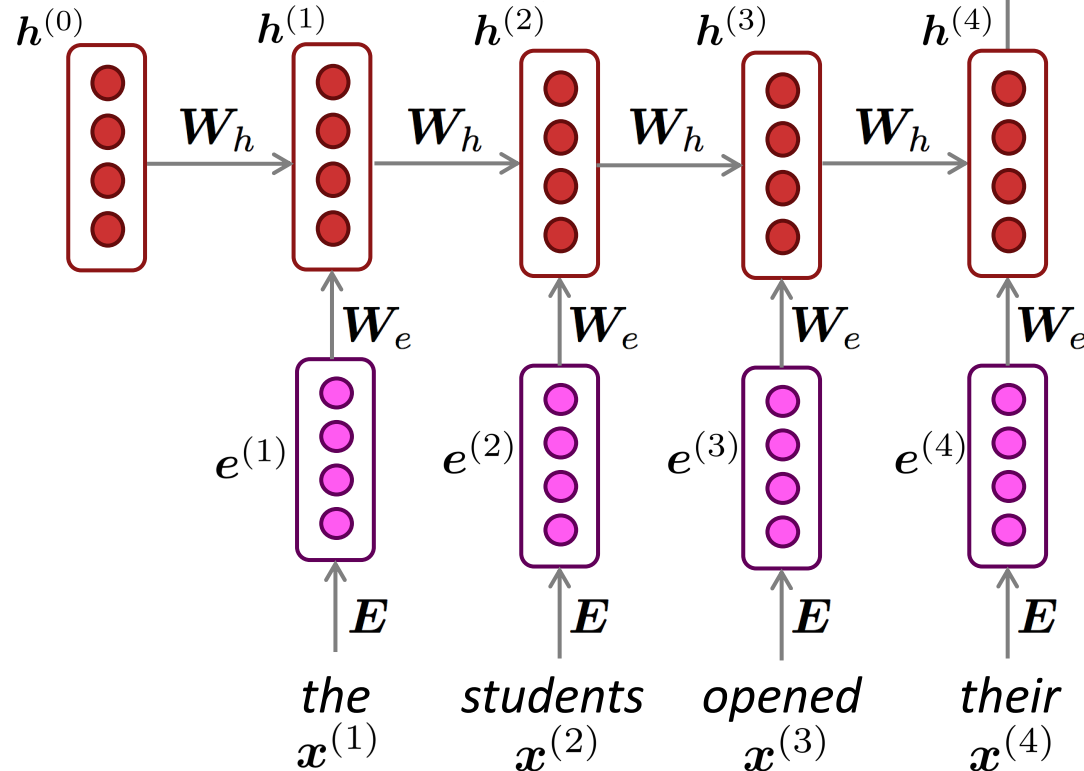

word embeddings

$$\mathbf{e}^{(t)} = \mathbf{E}x^{(t)}$$

words / one-hot vectors

$$\mathbf{x}^{(t)} \in \mathbb{R}^{|V|}$$

*Note: this input sequence could be much longer now!*



# RNN Language Models

## RNN Advantages:

- Can process **any length** input
- Computation for step  $t$  can (in theory) use information from **many steps back**
- **Model size doesn't increase** for longer input context
- Same weights applied on every timestep, so there is **symmetry** in how inputs are processed.

## RNN Disadvantages:

- Recurrent computation is **slow**
- In practice, difficult to access information from **many steps back**

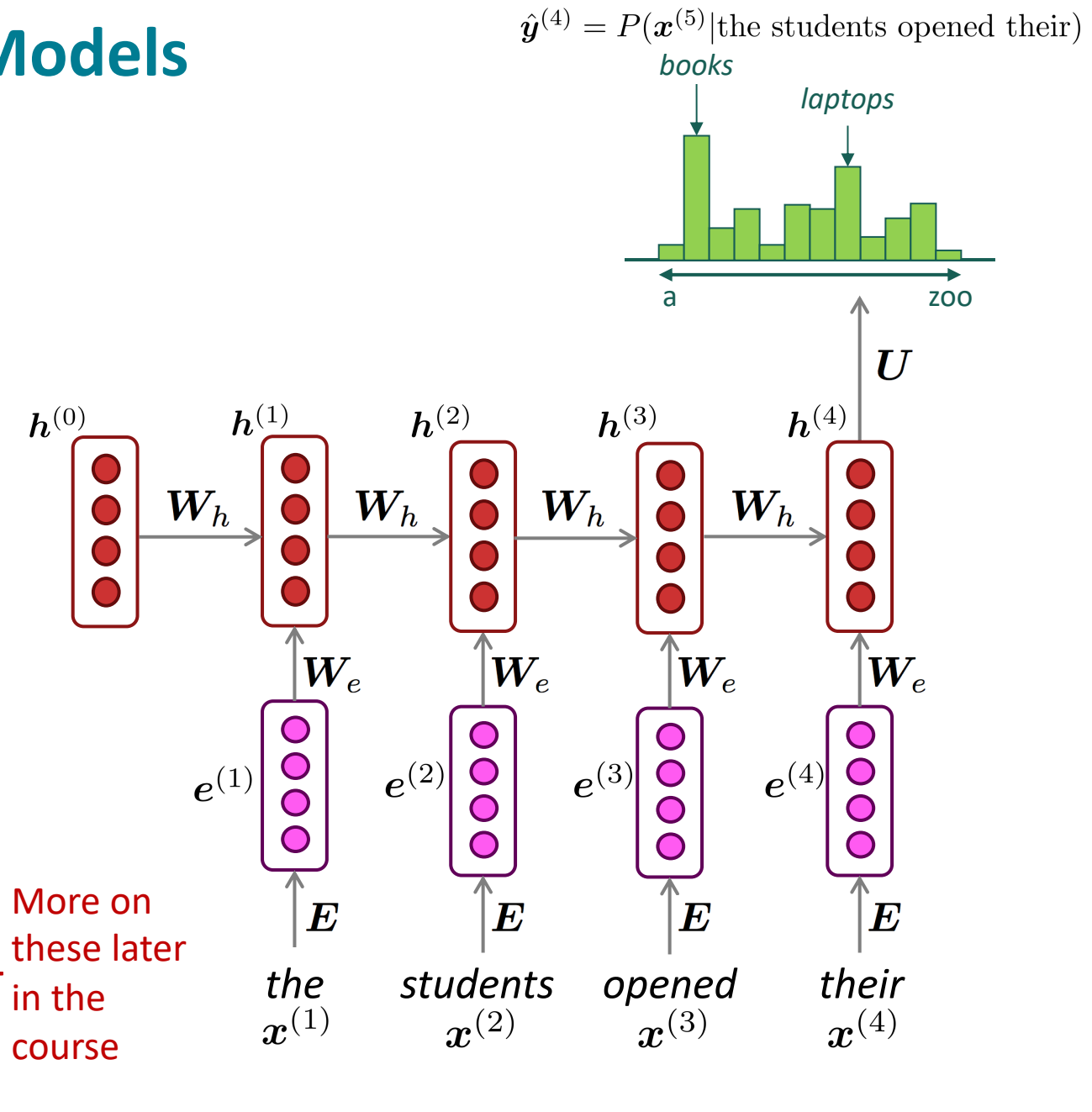

More on these later in the course

# Training an RNN Language Model

- Get a **big corpus of text** which is a sequence of words  $x^{(1)}, \dots, x^{(T)}$
- Feed into RNN-LM; compute output distribution  $\hat{\mathbf{y}}^{(t)}$  **for every step  $t$** .
  - i.e. predict probability dist of *every word*, given words so far
- **Loss function** on step  $t$  is **cross-entropy** between predicted probability distribution  $\hat{\mathbf{y}}^{(t)}$ , and the true next word  $\mathbf{y}^{(t)}$  (one-hot for  $x^{(t+1)}$ ):

$$J^{(t)}(\theta) = CE(\mathbf{y}^{(t)}, \hat{\mathbf{y}}^{(t)}) = - \sum_{w \in V} \mathbf{y}_w^{(t)} \log \hat{\mathbf{y}}_w^{(t)} = - \log \hat{\mathbf{y}}_{x_{t+1}}^{(t)}$$

- Average this to get **overall loss** for entire training set:

$$J(\theta) = \frac{1}{T} \sum_{t=1}^T J^{(t)}(\theta) = \frac{1}{T} \sum_{t=1}^T - \log \hat{\mathbf{y}}_{x_{t+1}}^{(t)}$$

# Training an RNN Language Model

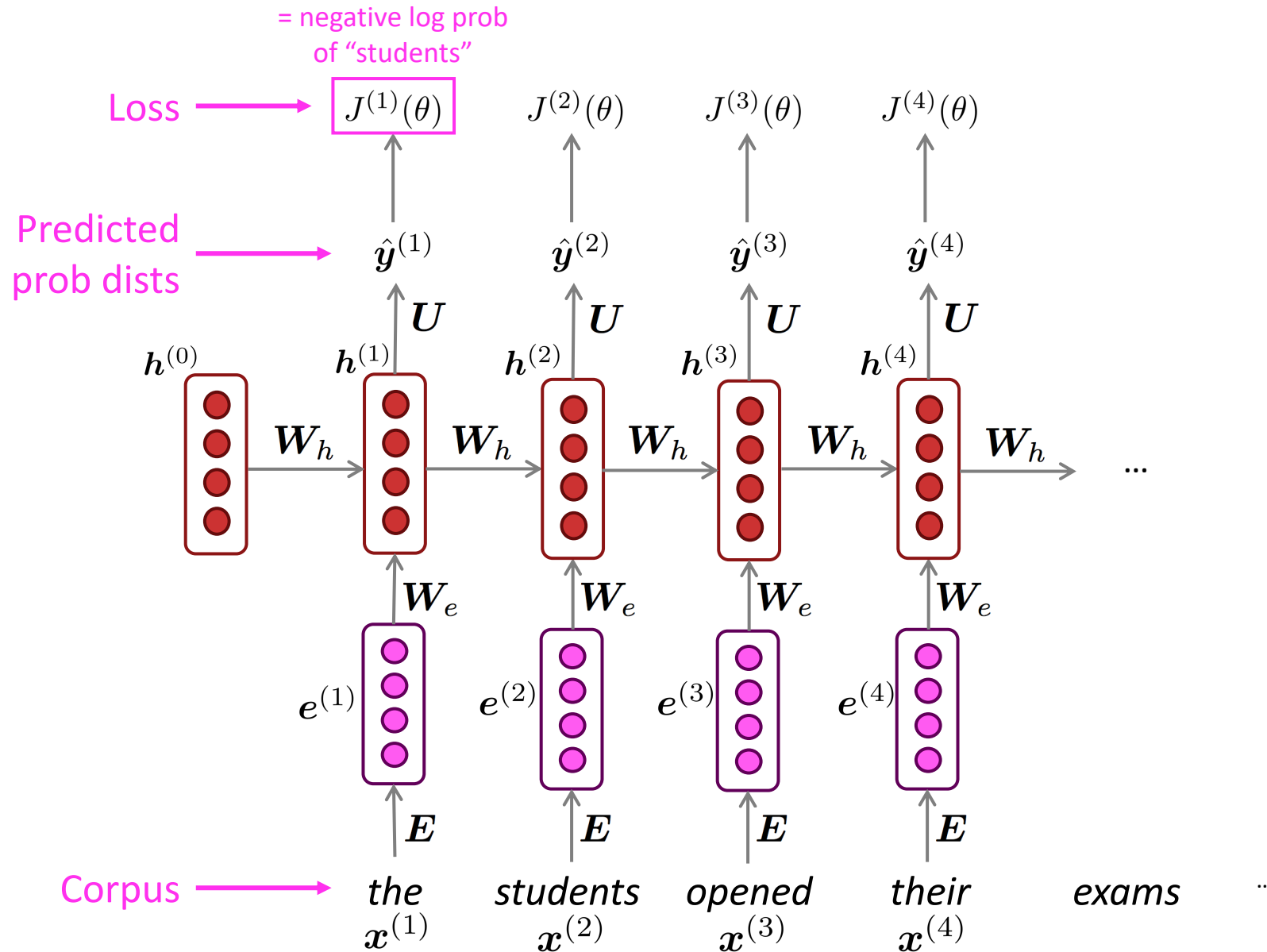

# Training an RNN Language Model

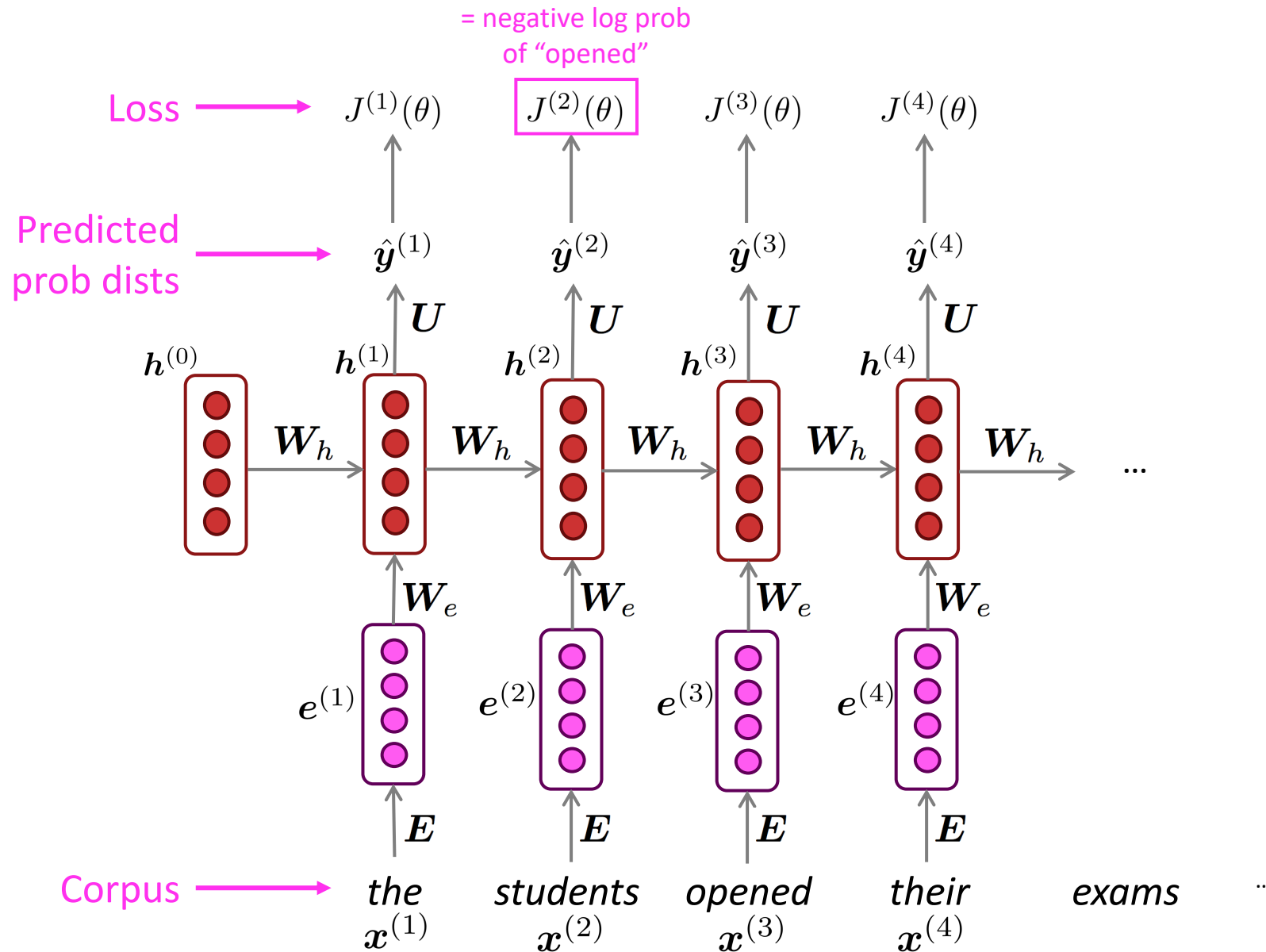

# Training an RNN Language Model

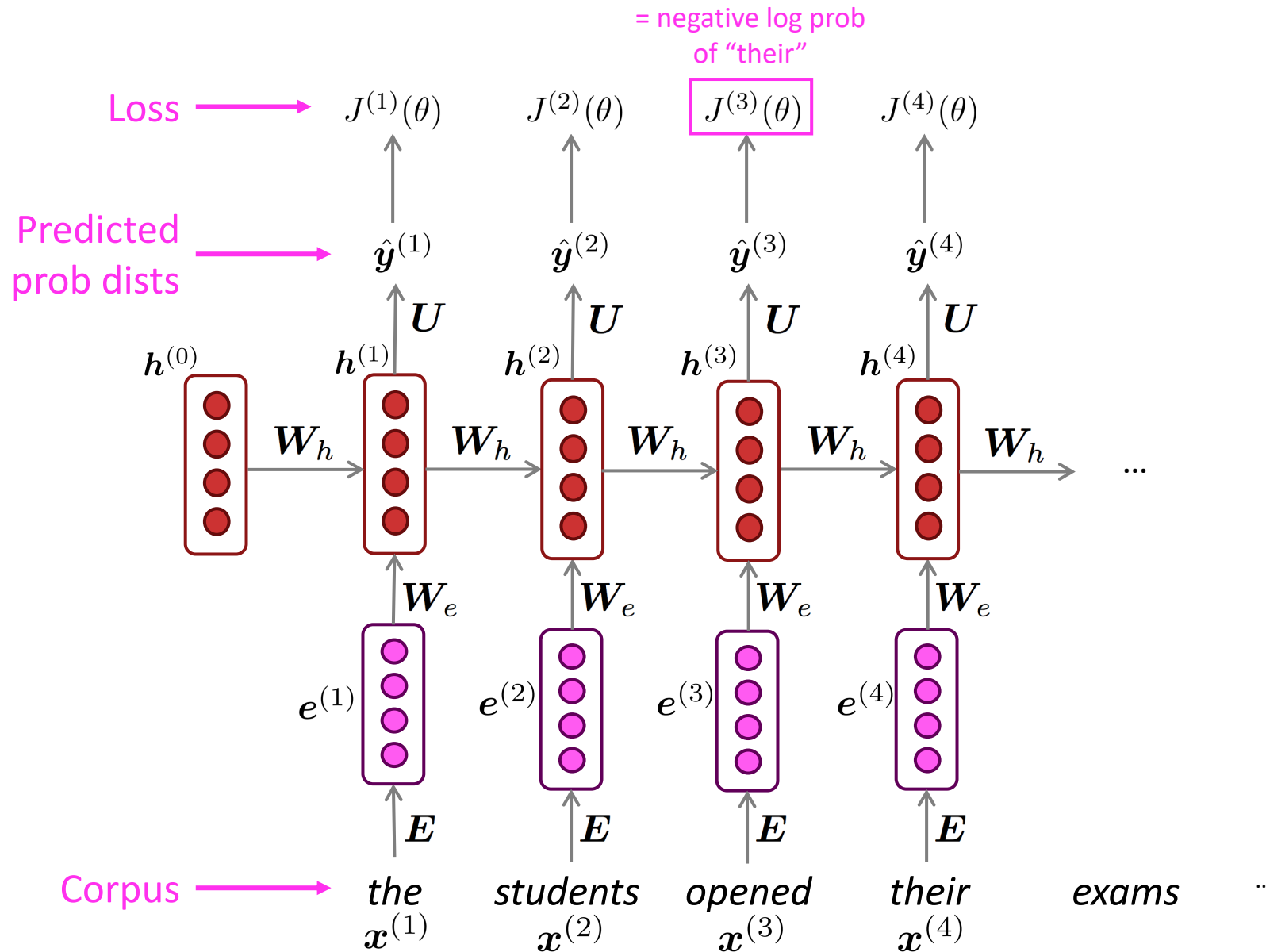

# Training an RNN Language Model

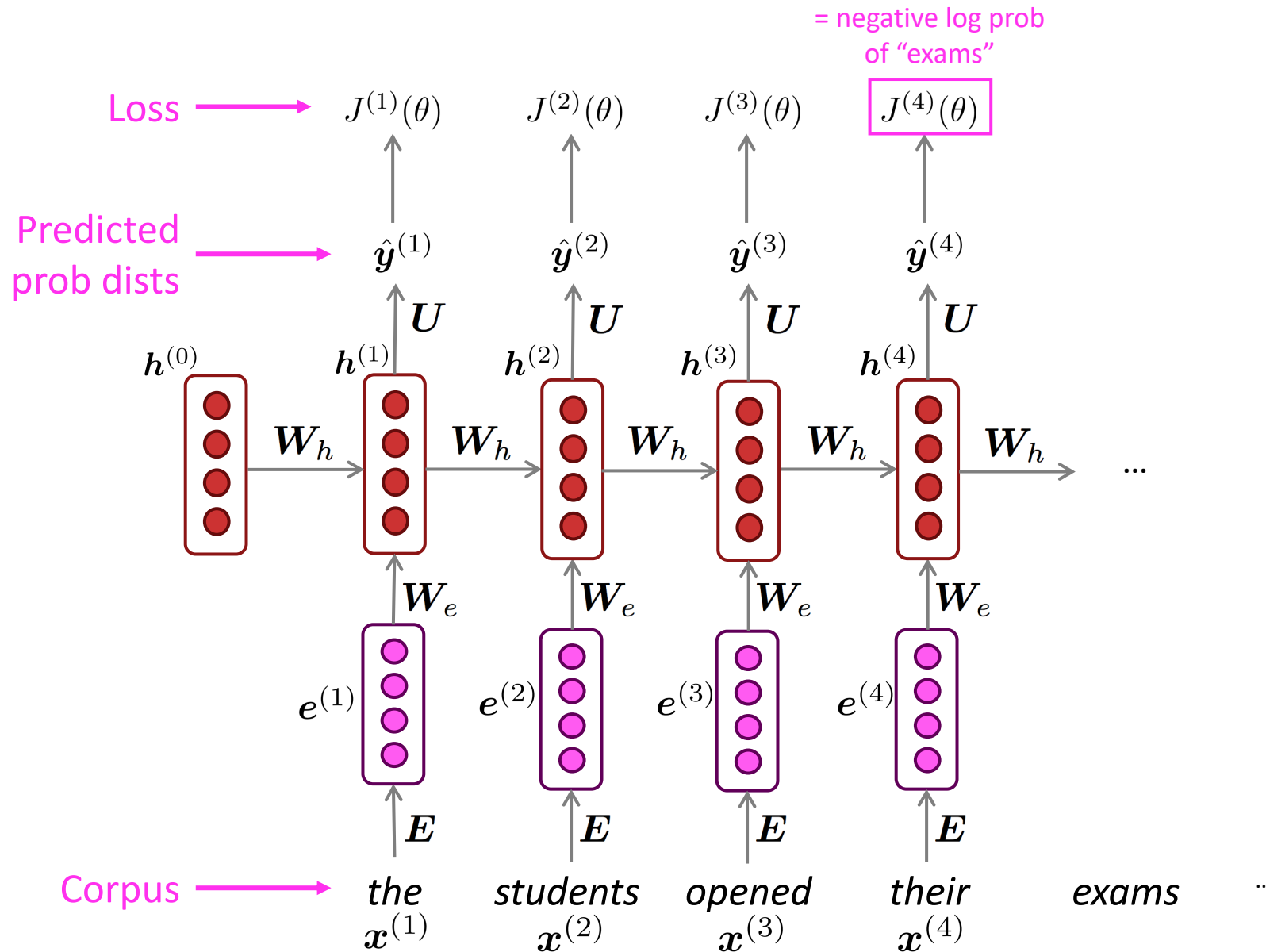

# Training an RNN Language Model

“Teacher forcing”

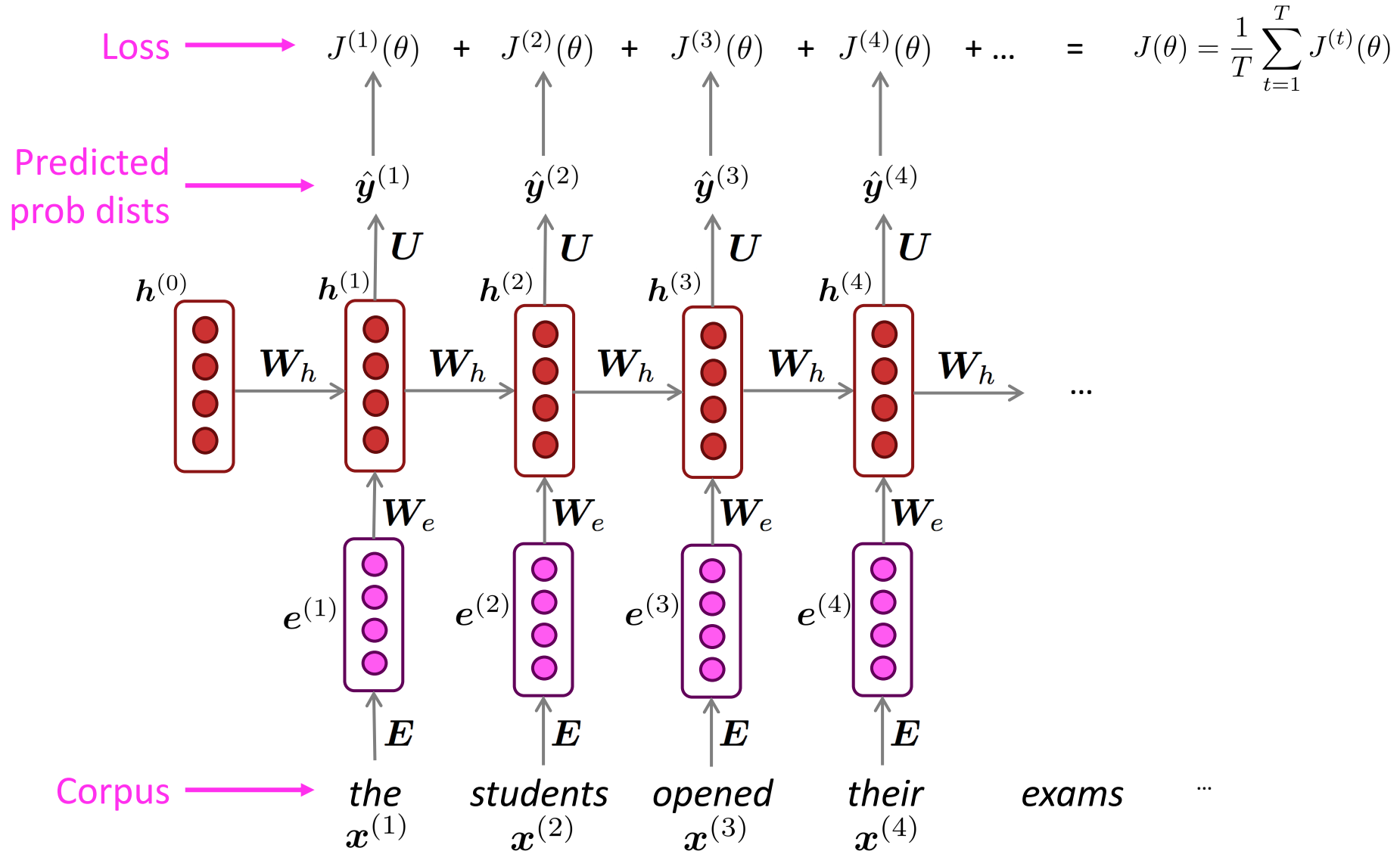

# Training a RNN Language Model

- However: Computing loss and gradients across **entire corpus**  $\mathbf{x}^{(1)}, \dots, \mathbf{x}^{(T)}$  is **too expensive!**

$$J(\theta) = \frac{1}{T} \sum_{t=1}^T J^{(t)}(\theta)$$

- In practice, consider  $\mathbf{x}^{(1)}, \dots, \mathbf{x}^{(T)}$  as a **sentence** (or a **document**)
- Recall: **Stochastic Gradient Descent** allows us to compute loss and gradients for small chunk of data, and update.
- Compute loss  $J(\theta)$  for a sentence (actually, a batch of sentences), compute gradients and update weights. Repeat.



# Backpropagation for RNNs

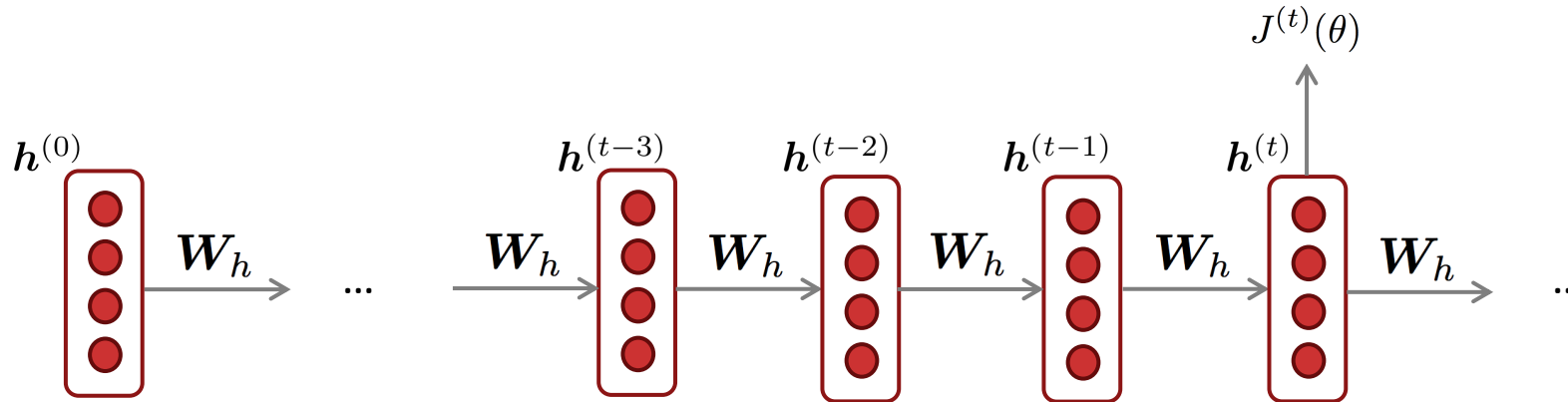

**Question:** What's the derivative of  $J^{(t)}(\theta)$  w.r.t. the **repeated** weight matrix  $W_h$  ?

**Answer:** 
$$\frac{\partial J^{(t)}}{\partial W_h} = \sum_{i=1}^t \frac{\partial J^{(t)}}{\partial W_h} \Big|_{(i)}$$

“The gradient w.r.t. a repeated weight is the sum of the gradient w.r.t. each time it appears”

Why?

# Multivariable Chain Rule

- Given a multivariable function  $f(x, y)$ , and two single variable functions  $x(t)$  and  $y(t)$ , here's what the multivariable chain rule says:

$$\underbrace{\frac{d}{dt} f(x(t), y(t))}_{\text{Derivative of composition function}} = \frac{\partial f}{\partial x} \frac{dx}{dt} + \frac{\partial f}{\partial y} \frac{dy}{dt}$$

Derivative of composition function

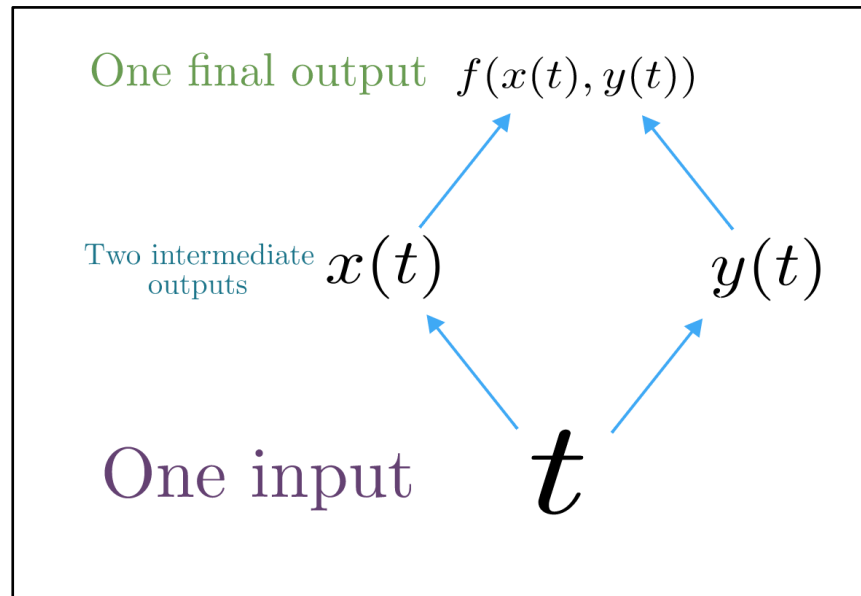

**Source:**

<https://www.khanacademy.org/math/multivariable-calculus/multivariable-derivatives/differentiating-vector-valued-functions/a/multivariable-chain-rule-simple-version>

# Backpropagation for RNNs: Proof sketch

- Given a multivariable function  $f(x, y)$ , and two single variable functions  $x(t)$  and  $y(t)$ , here's what the multivariable chain rule says:

$$\underbrace{\frac{d}{dt} f(x(t), y(t))}_{\text{Derivative of composition function}} = \frac{\partial f}{\partial x} \frac{dx}{dt} + \frac{\partial f}{\partial y} \frac{dy}{dt}$$

Derivative of composition function

In our example:

Apply the multivariable chain rule:

$$\frac{\partial J^{(t)}}{\partial \mathbf{W}_h} = \sum_{i=1}^t \frac{\partial J^{(t)}}{\partial \mathbf{W}_h} \Big|_{(i)} \frac{\partial \mathbf{W}_h \Big|_{(i)}}{\partial \mathbf{W}_h} = 1$$

$$= \sum_{i=1}^t \frac{\partial J^{(t)}}{\partial \mathbf{W}_h} \Big|_{(i)}$$

Source:

<https://www.khanacademy.org/math/multivariable-calculus/multivariable-derivatives/differentiating-vector-valued-functions/a/multivariable-chain-rule-simple-version>

# Backpropagation for RNNs

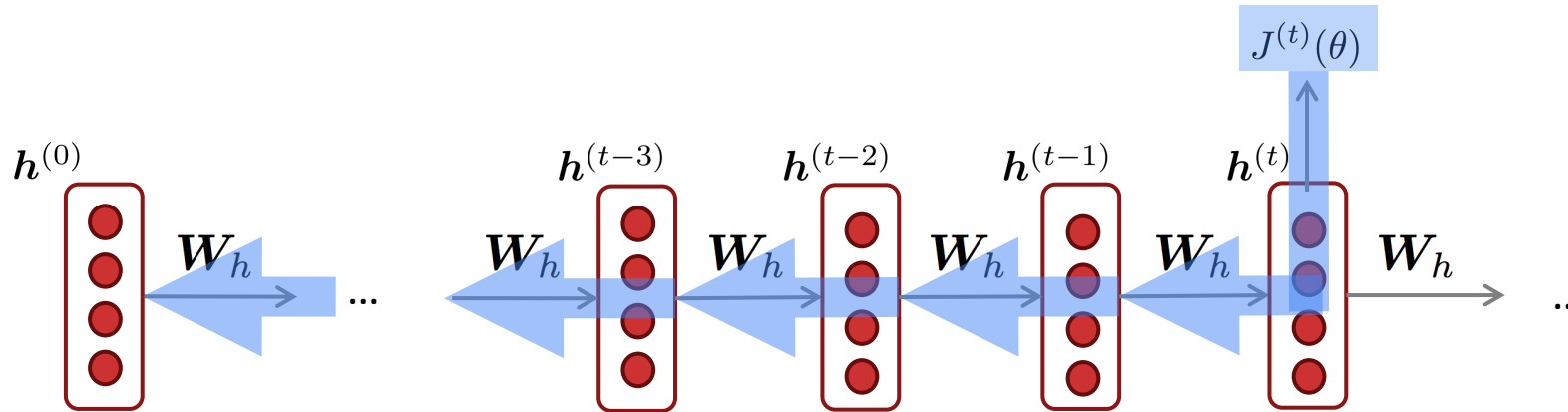

$$\frac{\partial J^{(t)}}{\partial \mathbf{W}_h} = \sum_{i=1}^t \frac{\partial J^{(t)}}{\partial \mathbf{W}_h} \Big|_{(i)}$$

**Question:** How do we calculate this?

**Answer:** Backpropagate over timesteps  $i=t, \dots, 0$ , summing gradients as you go. This algorithm is called “**backpropagation through time**” [Werbos, P.G., 1988, *Neural Networks 1*, and others]

# Generating text with a RNN Language Model

Just like a n-gram Language Model, you can use a RNN Language Model to **generate text** by **repeated sampling**. Sampled output becomes next step's input.

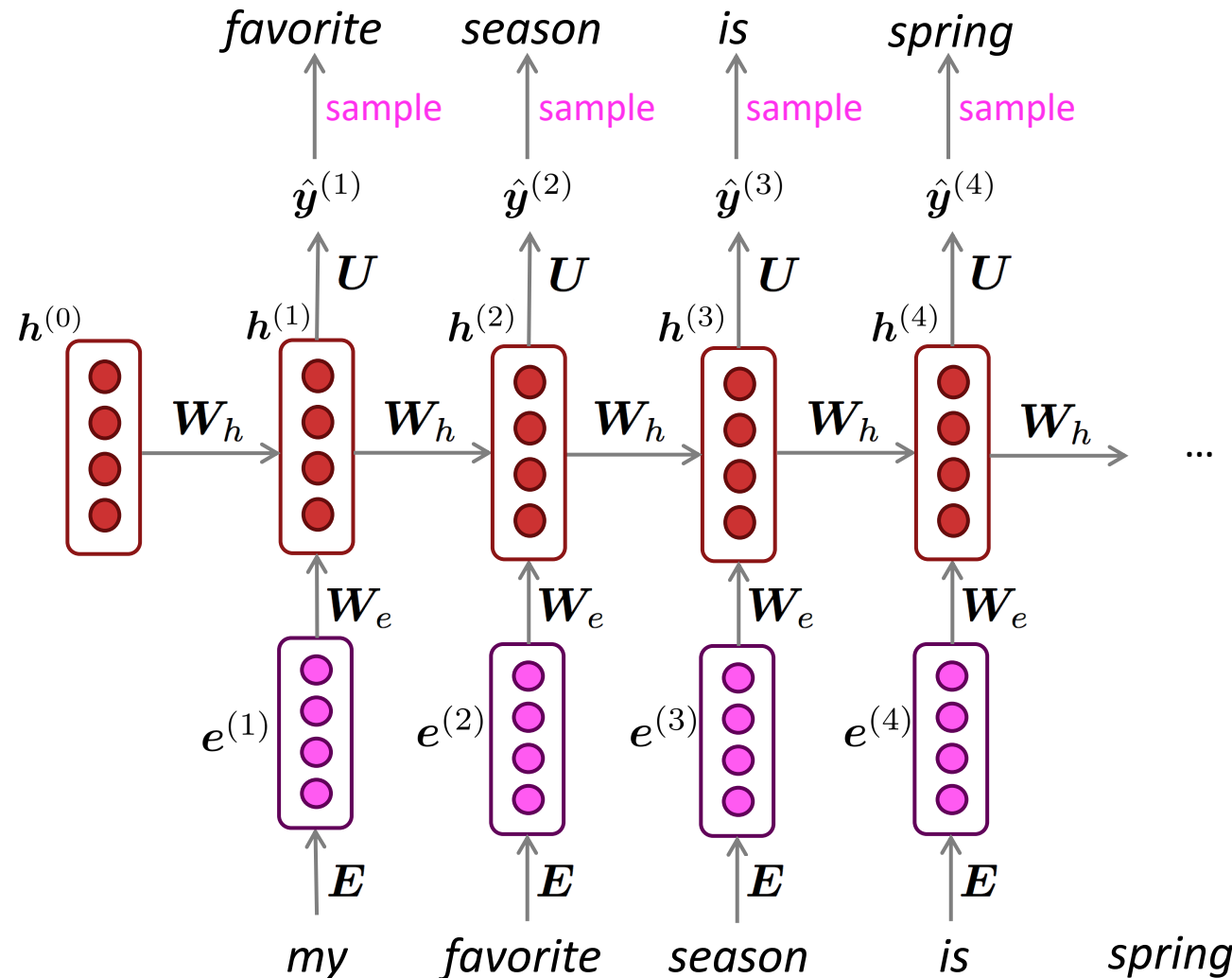

# Generating text with an RNN Language Model

Let's have some fun!

- You can train an RNN-LM on any kind of text, then generate text in that style.
- RNN-LM trained on **Obama speeches**:



*The United States will step up to the cost of a new challenges of the American people that will share the fact that we created the problem. They were attacked and so that they have to say that all the task of the final days of war that I will not be able to get this done.*

**Source:** <https://medium.com/@samim/obama-rnn-machine-generated-political-speeches-c8abd18a2ea0>

# Generating text with an RNN Language Model

Let's have some fun!

- You can train an RNN-LM on any kind of text, then generate text in that style.
- RNN-LM trained on *Harry Potter*:



“Sorry,” Harry shouted, panicking—“I’ll leave those brooms in London, are they?”

“No idea,” said Nearly Headless Nick, casting low close by Cedric, carrying the last bit of treacle Charms, from Harry’s shoulder, and to answer him the common room perched upon it, four arms held a shining knob from when the spider hadn’t felt it seemed. He reached the teams too.

**Source:** <https://medium.com/deep-writing/harry-potter-written-by-artificial-intelligence-8a9431803da6>

# Generating text with an RNN Language Model

Let's have some fun!

- You can train an RNN-LM on any kind of text, then generate text in that style.
- RNN-LM trained on **recipes**:



```
Title: CHOCOLATE RANCH BARBECUE  
Categories: Game, Casseroles, Cookies, Cookies  
Yield: 6 Servings
```

```
2 tb Parmesan cheese -- chopped  
1 c Coconut milk  
3 Eggs, beaten
```

```
Place each pasta over layers of lumps. Shape mixture into the moderate oven and simmer  
until firm. Serve hot in bodied fresh, mustard, orange and cheese.
```

```
Combine the cheese and salt together the dough in a large skillet; add the ingredients  
and stir in the chocolate and pepper.
```



















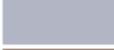



**Source:** <https://gist.github.com/nylki/1efbaa36635956d35bcc>



# Generating text with a RNN Language Model

Let's have some fun!

- You can train a RNN-LM on any kind of text, then generate text in that style.
- RNN-LM trained on **paint color names**:

	Ghasty Pink 231 137 165		Sand Dan 201 172 143
	Power Gray 151 124 112		Grade Bat 48 94 83
	Navel Tan 199 173 140		Light Of Blast 175 150 147
	Bock Coe White 221 215 236		Grass Bat 176 99 108
	Horble Gray 178 181 196		Sindis Poop 204 205 194
	Homestar Brown 133 104 85		Dope 219 209 179
	Snader Brown 144 106 74		Testing 156 101 106
	Golder Craam 237 217 177		Stoner Blue 152 165 159
	Hurky White 232 223 215		Burple Simp 226 181 132
	Burf Pink 223 173 179		Stanky Bean 197 162 171
	Rose Hork 230 215 198		Turdly 190 164 116

This is an example of a **character-level RNN-LM** (predicts what **character** comes next)

# Evaluating Language Models

- The standard **evaluation metric** for Language Models is **perplexity**.

$$\text{perplexity} = \prod_{t=1}^T \left( \frac{1}{P_{\text{LM}}(\mathbf{x}^{(t+1)} | \mathbf{x}^{(t)}, \dots, \mathbf{x}^{(1)})} \right)^{1/T}$$

Normalized by number of words

Inverse probability of corpus, according to Language Model

- This is equal to the exponential of the cross-entropy loss  $J(\theta)$  :

$$= \prod_{t=1}^T \left( \frac{1}{\hat{y}_{\mathbf{x}_{t+1}}^{(t)}} \right)^{1/T} = \exp \left( \frac{1}{T} \sum_{t=1}^T -\log \hat{y}_{\mathbf{x}_{t+1}}^{(t)} \right) = \exp(J(\theta))$$

**Lower perplexity is better!**

# RNNs have greatly improved perplexity

*n*-gram model →

Increasingly complex RNNs ↓

Model	Perplexity
Interpolated Kneser-Ney 5-gram (Chelba et al., 2013)	67.6
RNN-1024 + MaxEnt 9-gram (Chelba et al., 2013)	51.3
RNN-2048 + BlackOut sampling (Ji et al., 2015)	68.3
Sparse Non-negative Matrix factorization (Shazeer et al., 2015)	52.9
LSTM-2048 (Jozefowicz et al., 2016)	43.7
2-layer LSTM-8192 (Jozefowicz et al., 2016)	30
Ours small (LSTM-2048)	43.9
Ours large (2-layer LSTM-2048)	39.8

Perplexity improves (lower is better)

Source: <https://research.fb.com/building-an-efficient-neural-language-model-over-a-billion-words/>

# Why should we care about Language Modeling?

- Language Modeling is a **benchmark task** that helps us **measure our progress** on understanding language
- Language Modeling is a **subcomponent** of many NLP tasks, especially those involving **generating text** or **estimating the probability of text**:
  - Predictive typing
  - Speech recognition
  - Handwriting recognition
  - Spelling/grammar correction
  - Authorship identification
  - Machine translation
  - Summarization
  - Dialogue
  - etc.

# Recap

- **Language Model**: A system that predicts the next word
- **Recurrent Neural Network**: A family of neural networks that:
  - Take sequential input of any length
  - Apply the same weights on each step
  - Can optionally produce output on each step
- **Recurrent Neural Network  $\neq$  Language Model**
- We've shown that RNNs are a great way to build a LM.
- But RNNs are useful for much more!

# RNNs can be used for tagging

e.g., part-of-speech tagging, named entity recognition

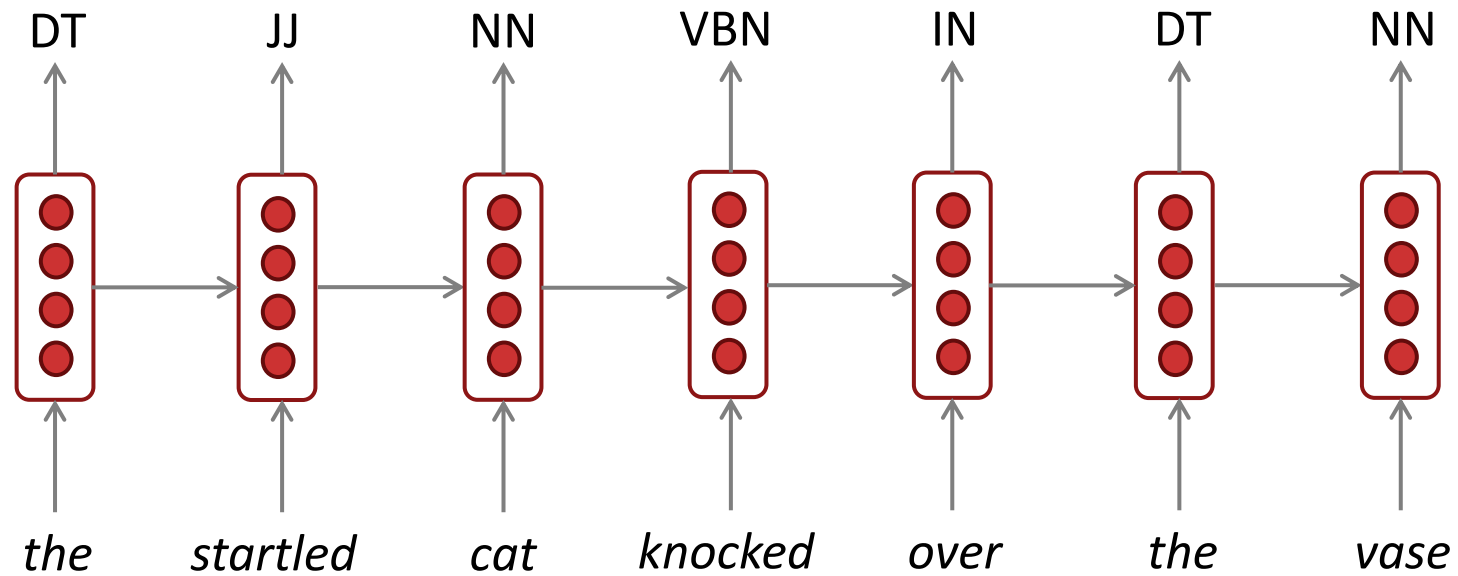

# RNNs can be used for sentence classification

e.g., sentiment classification

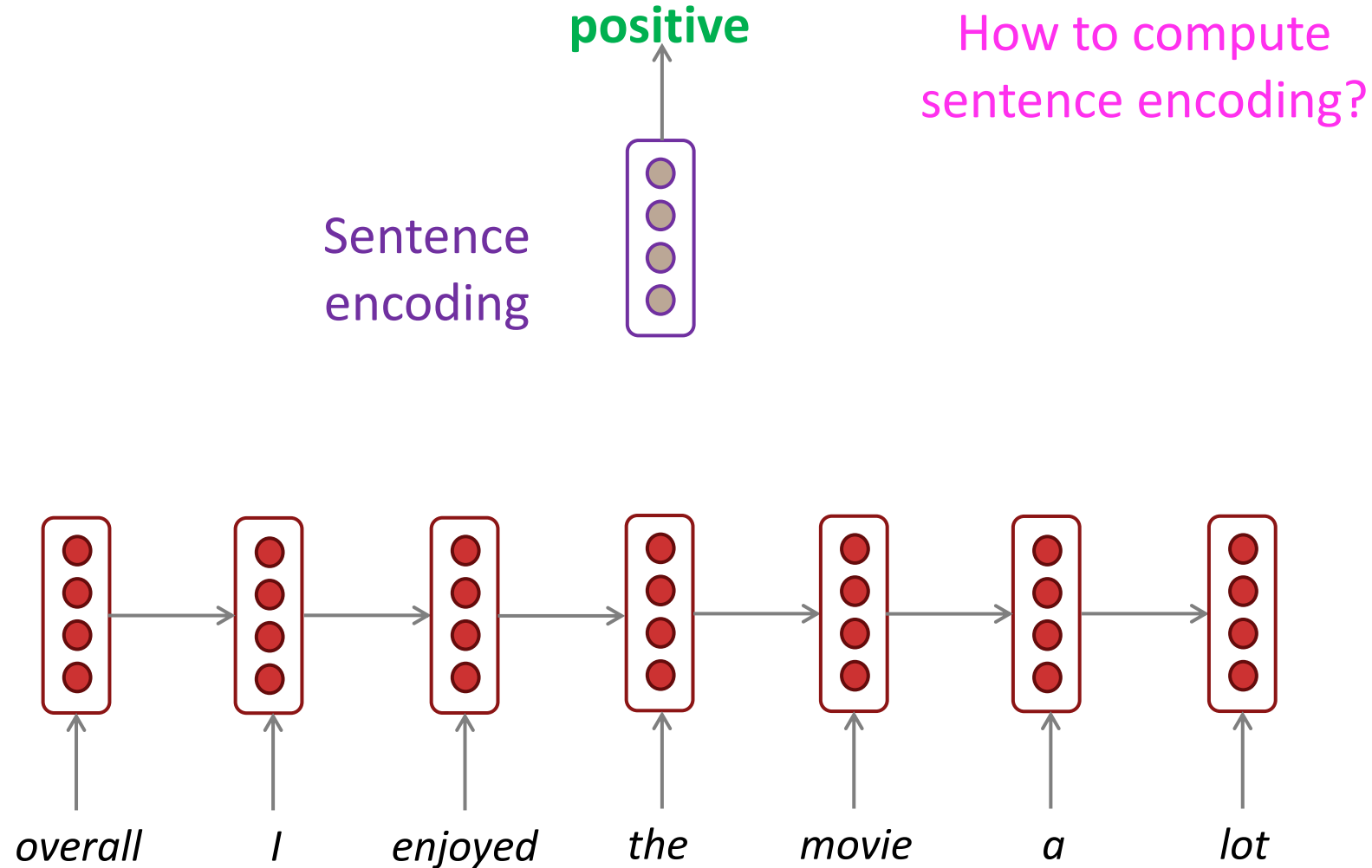

# RNNs can be used for sentence classification

e.g., sentiment classification

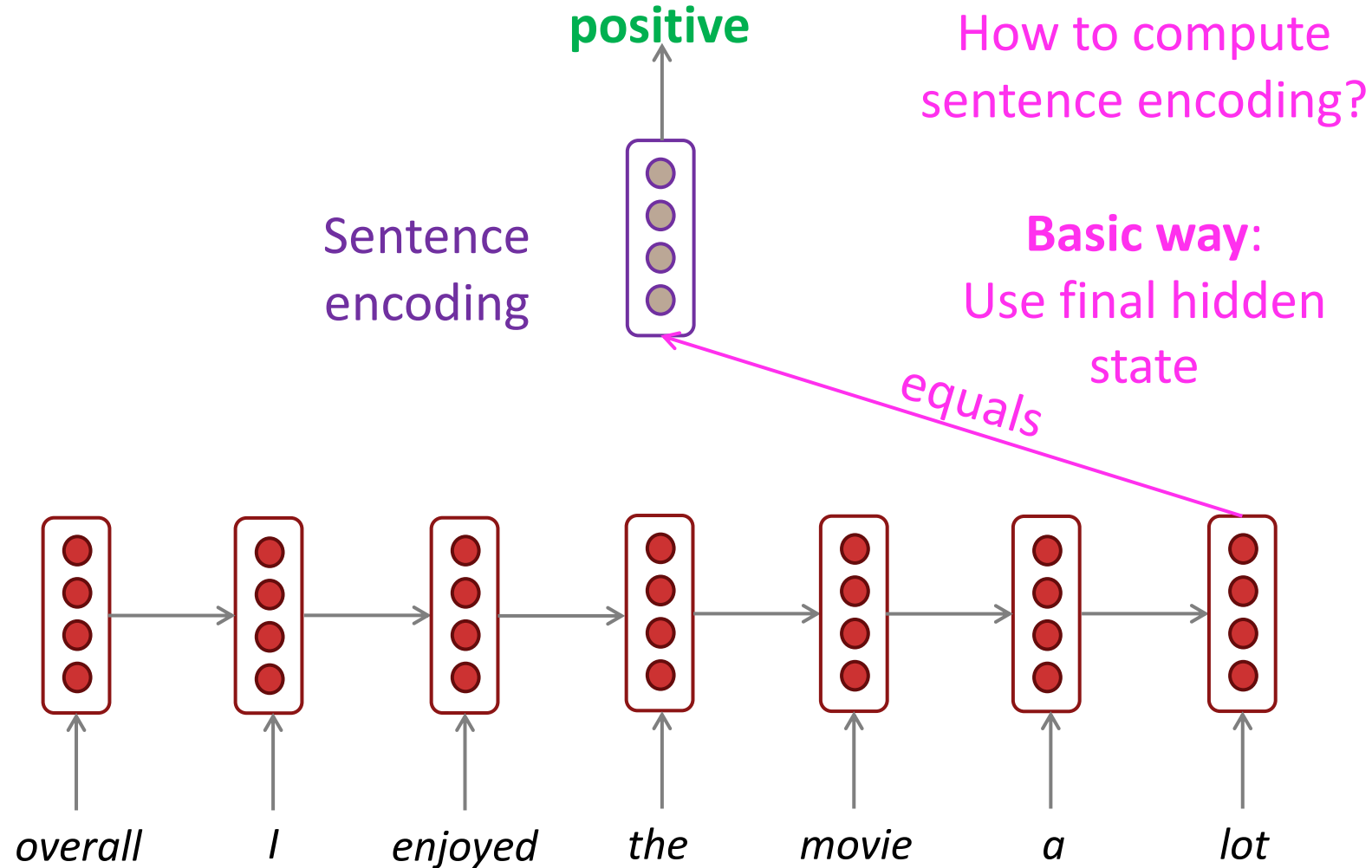



# RNNs can be used for sentence classification

e.g., sentiment classification

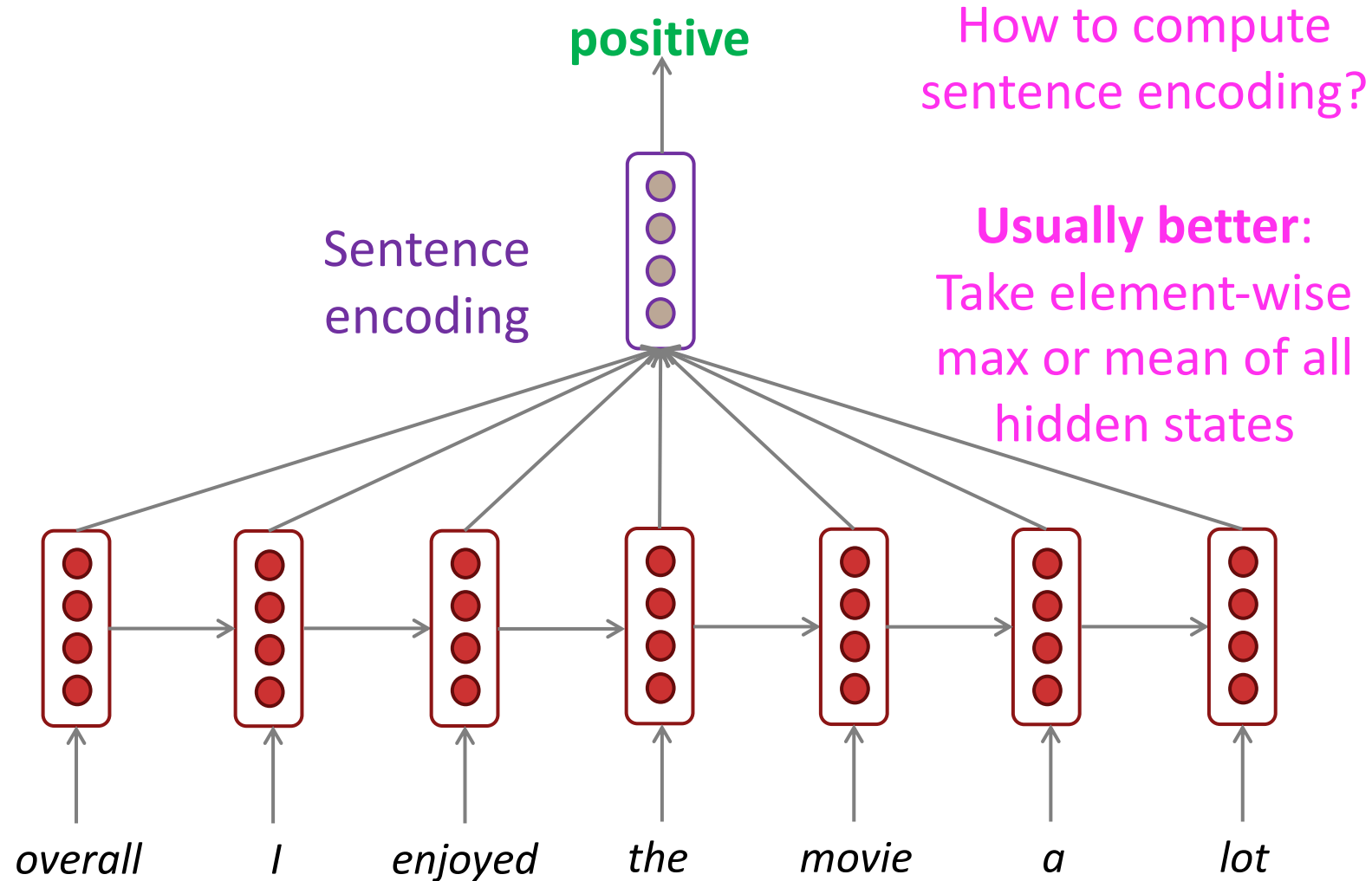

# RNNs can be used as an encoder module

e.g., question answering, machine translation, *many other tasks!*

Here the RNN acts as an **encoder** for the Question (the hidden states represent the Question). The encoder is part of a larger neural system.

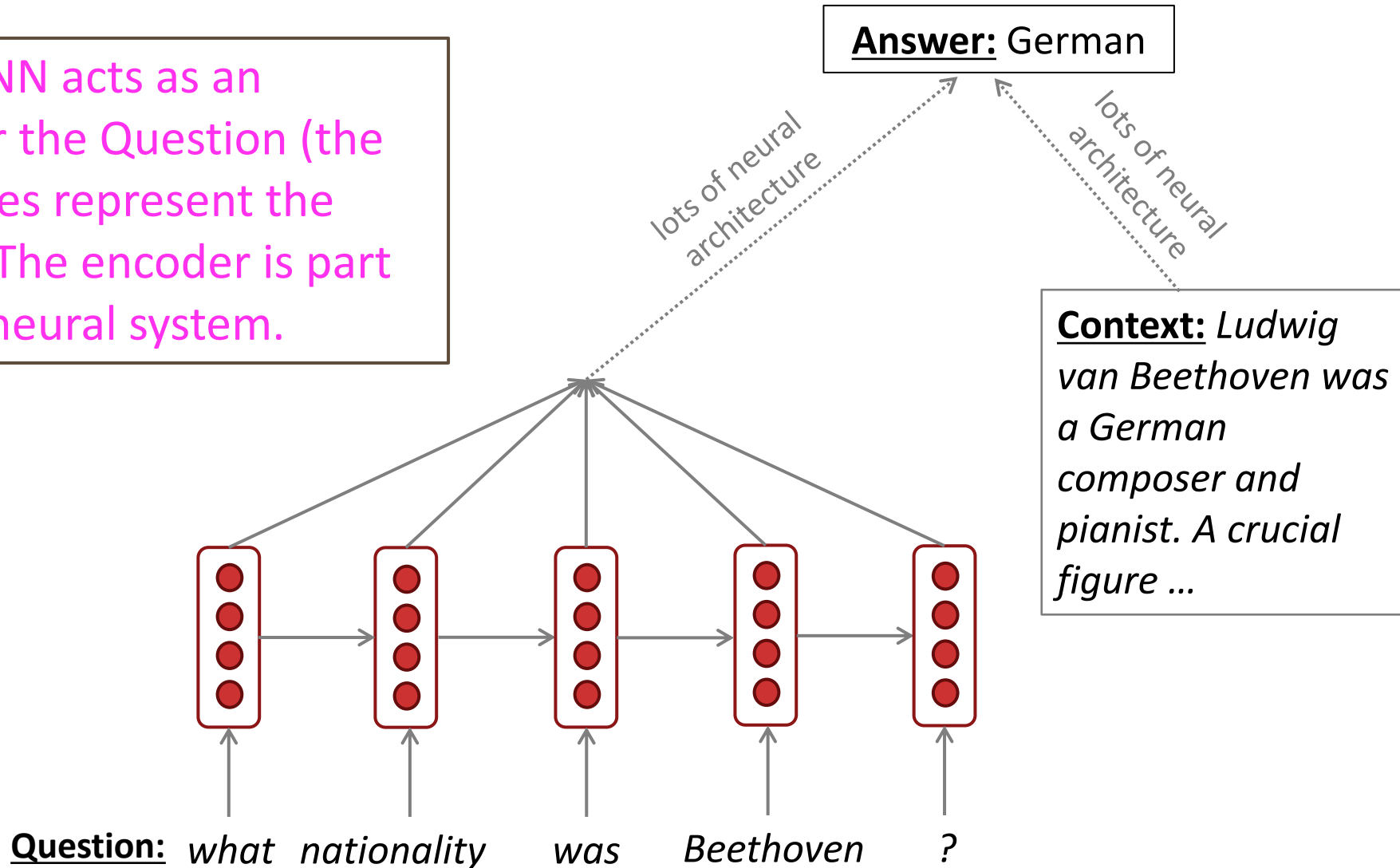

# RNN-LMs can be used to generate text

e.g., speech recognition, machine translation, summarization

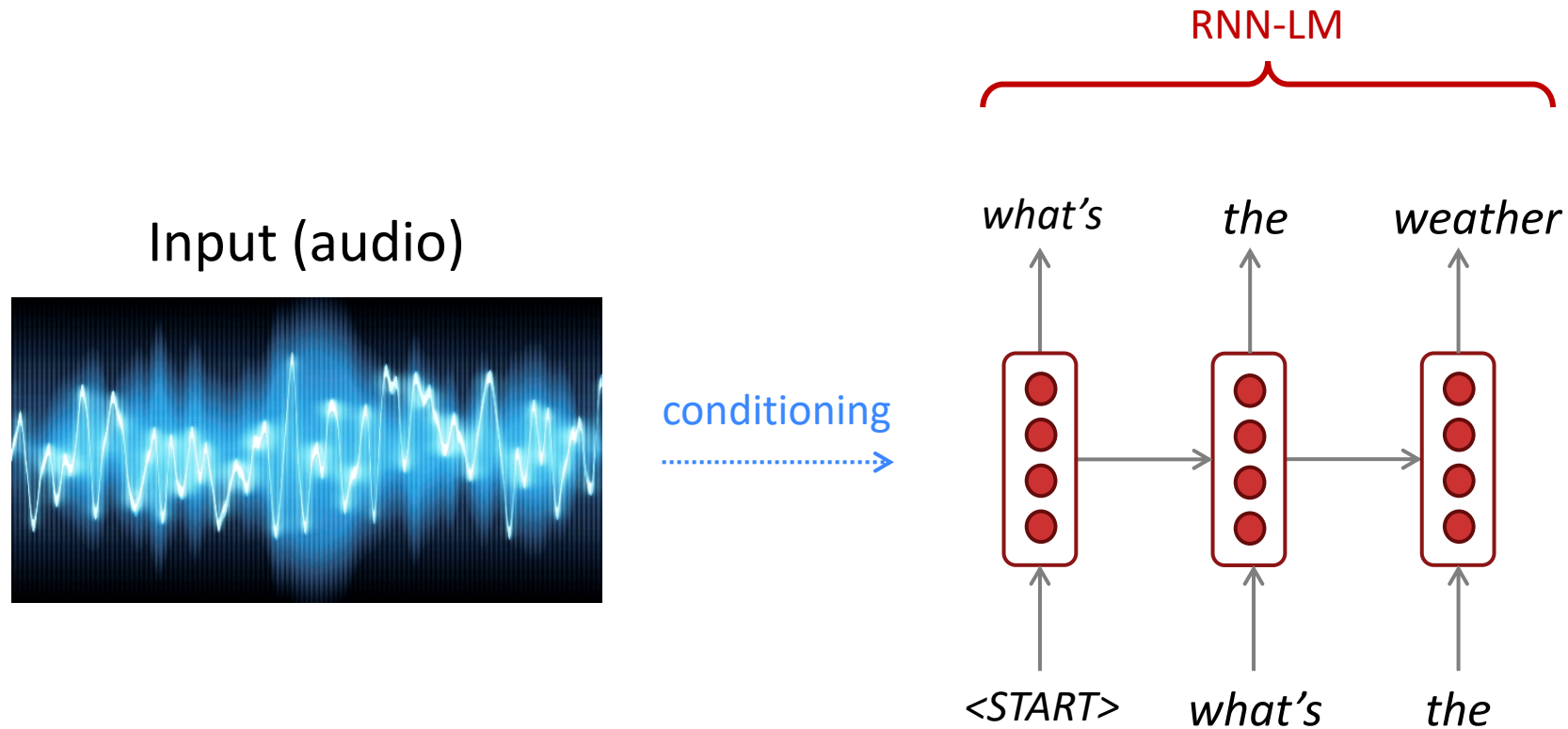

This is an example of a *conditional language model*. We'll see Machine Translation in much more detail later.

# Terminology and a look forward

The RNN described in this lecture = **simple**/vanilla/**Elman** RNN



**Next lecture:** You will learn about other RNN flavors

like **GRU** and **LSTM** and multi-layer RNNs



**By the end of the course:** You will understand phrases like  
*“stacked bidirectional LSTM with residual connections and self-attention”*

