



Module 6: EtherChannel

Instructor Materials

Switching, Routing and Wireless
Essentials v7.0 (SRWE)



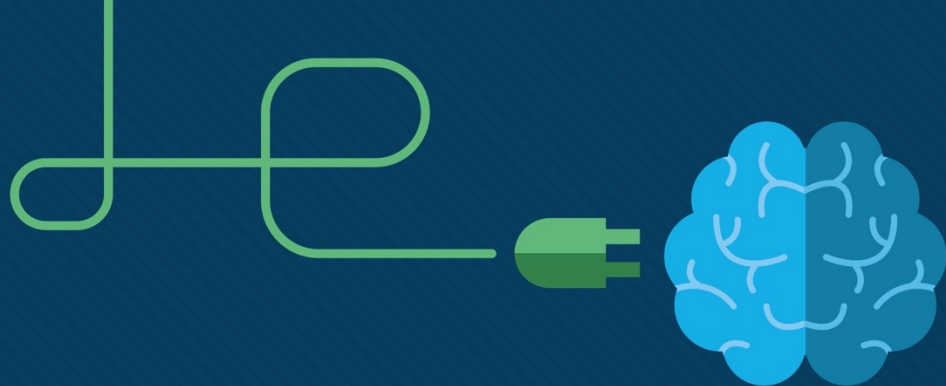

Module 6: EtherChannel

Switching, Routing and Wireless
Essentials v7.0 (SRWE)



Module Objectives

Module Title: EtherChannel

Module Objective: Troubleshoot EtherChannel on switched links.

Topic Title	Topic Objective
EtherChannel Operation	Describe EtherChannel technology.
Configure EtherChannel	Configure EtherChannel.
Verify and Troubleshoot EtherChannel	Troubleshoot EtherChannel.

6.1 EtherChannel Operation

Link Aggregation

- There are scenarios in which more bandwidth or redundancy between devices is needed than what can be provided by a single link. Multiple links could be connected between devices to increase bandwidth. However, Spanning Tree Protocol (STP), which is enabled on Layer 2 devices like Cisco switches by default, will block redundant links to prevent switching loops.
- A link aggregation technology is needed that **allows redundant links between devices that will not be blocked by STP**. That technology is known as EtherChannel.
- EtherChannel is a link aggregation technology that groups multiple physical Ethernet links together into one single logical link. It is used to provide **fault-tolerance, load sharing, increased bandwidth, and redundancy** between switches, routers, and servers.
- EtherChannel technology makes it possible to combine the number of physical links between the switches to increase the overall speed of switch-to-switch communication.

EtherChannel

EtherChannel technology was originally developed by Cisco as a LAN switch-to-switch technique of grouping several Fast Ethernet or Gigabit Ethernet ports into one logical channel.

When an EtherChannel is configured, the **resulting virtual interface is called a port channel**. The physical interfaces are bundled together into a port channel interface, as shown in the figure.

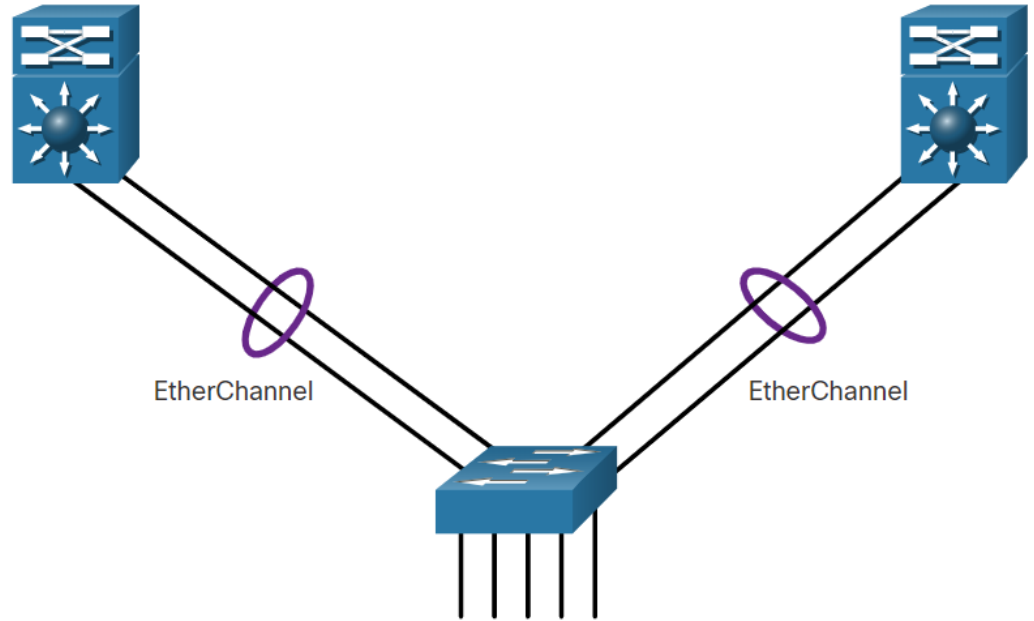

Advantages of EtherChannel

EtherChannel technology has many advantages, including the following:

- **Most configuration tasks can be done on the EtherChannel interface** instead of on each individual port, ensuring configuration consistency throughout the links.
- EtherChannel relies on existing switch ports. There is **no need to upgrade the link** to a faster and more expensive connection to have more bandwidth.
- **Load balancing** takes place between links that are part of the same EtherChannel.
- EtherChannel creates an aggregation that is seen as one logical link. When several EtherChannel bundles exist between two switches, **STP may block one of the bundles** to prevent switching loops. When STP blocks one of the redundant links, it blocks the entire EtherChannel. This blocks all the ports belonging to that EtherChannel link. Where there is only one EtherChannel link, all physical links in the EtherChannel are active because STP sees only one (logical) link.
- EtherChannel provides redundancy because the overall link is seen as one logical connection. Additionally, the **loss of one physical link** within the channel does not create a change in the topology.

Implementation Restrictions

EtherChannel has certain implementation restrictions, including the following:

- **Interface types cannot be mixed.** For example, Fast Ethernet and Gigabit Ethernet cannot be mixed within a single EtherChannel.
- Currently each EtherChannel can consist of **up to eight** compatibly-configured Ethernet ports. EtherChannel provides **full-duplex bandwidth up to 800 Mbps** (Fast EtherChannel) or **8 Gbps** (Gigabit EtherChannel) between one switch and another **switch or host**.
- The Cisco **Catalyst 2960** Layer 2 switch currently supports **up to six** EtherChannels.
- The individual EtherChannel group member port configuration must be consistent on **both devices**. If the physical ports of one side are configured as trunks, the physical ports of the other side must also be configured as trunks within the same native VLAN. Additionally, **all ports** in each EtherChannel link must be configured as **Layer 2** ports.
- Each EtherChannel has a logical port channel interface. A configuration applied to the port channel interface affects all physical interfaces that are assigned to that interface.

AutoNegotiation Protocols

EtherChannels can be formed through negotiation using one of two protocols, Port Aggregation Protocol (PAgP) or **Link Aggregation Control Protocol (LACP)**. These protocols allow ports with similar characteristics to form a channel through dynamic negotiation with adjoining switches.

Note: It is also **possible** to configure a **static or unconditional** EtherChannel without PAgP (devadesátá léta) or LACP (2000).

PAgP Operation

PAgP (pronounced “Pag - P”) is a **Cisco-proprietary protocol** that aids in the automatic creation of EtherChannel links. When an EtherChannel link is configured using PAgP, **PAgP packets** are sent between EtherChannel-capable ports to negotiate the forming of a channel. When PAgP identifies matched Ethernet links, it groups the links into an EtherChannel. **The EtherChannel is then added to the spanning tree as a single port.**

When enabled, PAgP also manages the EtherChannel. **PAgP packets are sent every 30 seconds.** PAgP checks for configuration consistency and manages link additions and failures between two switches. It ensures that when an EtherChannel is created, all ports have the same type of configuration.

Note: In EtherChannel, it is mandatory that **all ports have the same speed, duplex setting, and VLAN information.** Any port modification after the creation of the channel also changes all other channel ports.

PAgP Operation (Cont.)

PAgP helps create the EtherChannel link by detecting the configuration of each side and ensuring that links are compatible so that the EtherChannel link can be enabled when needed. The modes for PAgP as follows:

- **On** - This mode forces the interface to channel without PAgP. Interfaces configured in the on mode do not exchange PAgP packets.
- **PAgP desirable** - This PAgP mode places an interface in an active negotiating state in which the interface initiates negotiations with other interfaces by **sending PAgP packets**.
- **PAgP auto** - This PAgP mode places an interface in a passive negotiating state in which the interface responds to the PAgP packets that it **receives but does not initiate** PAgP negotiation.

The modes must be compatible on each side. If one side is configured to be in auto mode, it is placed in a passive state, waiting for the other side to initiate the EtherChannel negotiation. **If the other side is also set to auto, the negotiation never starts** and the EtherChannel does not form. If all modes are disabled by using the **no** command, or if no mode is configured, then the EtherChannel is disabled. The on mode manually places the interface in an EtherChannel, without any negotiation. It works only if the other side is also set to on. If the other side is set to negotiate parameters through PAgP, no EtherChannel forms, because the side that is set to on mode does not negotiate. No negotiation between the two switches means there is no checking to make sure that all the links in the EtherChannel are terminating on the other side, or that there is PAgP compatibility on the other switch.

PAgP Mode Settings Example

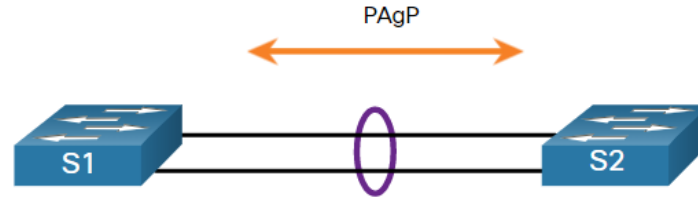

The table shows the various combination of PAgP modes on S1 and S2 and the resulting channel establishment

S1	S2	Channel Establishment
On	On	Yes
On	Desirable/Auto	No
Desirable	Desirable	Yes
Desirable	Auto	Yes
Auto	Desirable	Yes
Auto	Auto	No

Filtry Wiresharku pro PAgP

WIRESHARK	Flags	NEWS	Get Acquainted	Get Net
pagp.flags.slowhello	Slow Hello	Boolean	1.0.0 to 3.4.0	
pagp.flags.state	Consistent State	Boolean	1.0.0 to 3.4.0	
pagp.flushlocaldev	Flush Local Device ID	Ethernet or other MAC address	1.0.0 to 3.4.0	
pagp.flushpartnerdev	Flush Partner Device ID	Ethernet or other MAC address	1.0.0 to 3.4.0	
pagp.localdev	Local Device ID	Ethernet or other MAC address	1.0.0 to 3.4.0	
pagp.locallearncap	Local Learn Capability	Unsigned integer, 1 byte	1.0.0 to 3.4.0	
pagp.localgroupcap	Local Group Capability	Unsigned integer, 4 bytes	1.0.0 to 3.4.0	
pagp.localgroupifindex	Local Group ifindex	Unsigned integer, 4 bytes	1.0.0 to 3.4.0	
pagp.localportpri	Local Port Hot Standby Priority	Unsigned integer, 1 byte	1.0.0 to 3.4.0	
pagp.localsentportifindex	Local Sent Port ifindex	Unsigned integer, 4 bytes	1.0.0 to 3.4.0	
pagp.numtlvs	Number of TLVs	Unsigned integer, 2 bytes	1.0.0 to 3.4.0	
pagp.partnercount	Partner Count	Unsigned integer, 2 bytes	1.0.0 to 3.4.0	
pagp.partnerdev	Partner Device ID	Ethernet or other MAC address	1.0.0 to 3.4.0	
pagp.partnergroupcap	Partner Group Capability	Unsigned integer, 4 bytes	1.0.0 to 3.4.0	
pagp.partnergroupifindex	Partner Group ifindex	Unsigned integer, 4 bytes	1.0.0 to 3.4.0	
pagp.partnerlearncap	Partner Learn Capability	Unsigned integer, 1 byte	1.0.0 to 3.4.0	
pagp.partnerportpri	Partner Port Hot Standby Priority	Unsigned integer, 1 byte	1.0.0 to 3.4.0	
pagp.partnersentportifindex	Partner Sent Port ifindex	Unsigned integer, 4 bytes	1.0.0 to 3.4.0	
pagp.tlv	Type	Unsigned integer, 2 bytes	1.0.0 to 3.4.0	
pagp.tlv_length	Length	Unsigned integer, 2 bytes	2.0.0 to 3.4.0	
pagp.tlv_length.invalid	Invalid TLV length	Label	2.0.0 to 3.4.0	
pagp.tlvagportmac	Agport MAC Address	Ethernet or other MAC address	1.0.0 to 3.4.0	
pagp.tlvdevname	Device Name	Character string	1.0.0 to 3.4.0	
pagp.tlvportname	Physical Port Name	Character string	1.0.0 to 3.4.0	
pagp.transid	Transaction ID	Unsigned integer, 4 bytes	1.0.0 to 3.4.0	
pagp.version	Version	Unsigned integer, 1 byte	1.0.0 to 3.4.0	

LACP Operation

LACP is part of an IEEE specification (802.3ad) that allows several physical ports to be bundled to form a single logical channel. LACP allows a switch to negotiate an automatic bundle by sending LACP packets to the other switch. It performs a function similar to PAgP with Cisco EtherChannel. Because LACP is an IEEE standard, it can be used to facilitate EtherChannels in **multivendor environments**. On Cisco devices, both protocols are supported.

LACP provides the same negotiation benefits as PAgP. LACP helps create the EtherChannel link by detecting the configuration of each side and making sure that they are compatible so that the EtherChannel link can be enabled when needed. The modes for LACP are as follows:

- **On** - This mode forces the interface to channel without LACP. Interfaces configured in the on mode do not exchange LACP packets.
- **LACP active** - This LACP mode places a port in an active negotiating state. In this state, the port initiates negotiations with other ports by sending **LACP packets**.
- **LACP passive** - This LACP mode places a port in a passive negotiating state. In this state, the port responds to the LACP packets that it receives but does not initiate LACP packet negotiation.

LACP Mode Settings Example

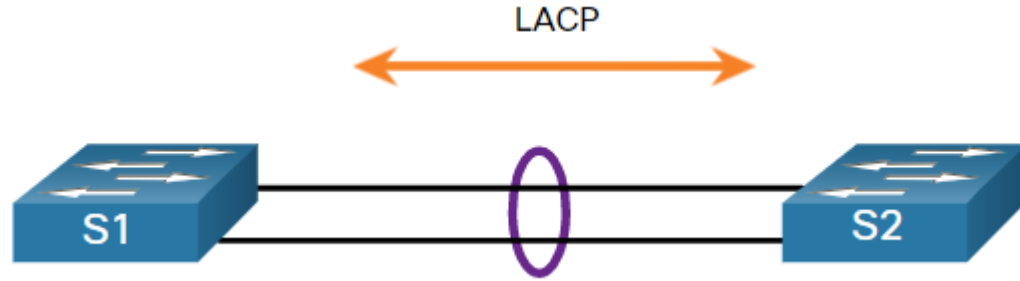

The table shows the various combination of LACP modes on S1 and S2 and the resulting channel establishment outcome.

S1	S2	Channel Establishment
On	On	Yes
On	Active/Passive	No
Active	Active	Yes
Active	Passive	Yes
Passive	Active	Yes
Passive	Passive	No

Filtry Wiresharku pro LACP

<https://www.wireshark.org/docs/dfref/l/lacp.html>

WIRESHARK	Flags	Wireshark	Get Acquainted
pagp.flags.autohello	Auto Hello	Boolean	1.0.0 to 3.4.0
pagp.flags.slowhello	Slow Hello	Boolean	1.0.0 to 3.4.0
pagp.flags.state	Consistent State	Boolean	1.0.0 to 3.4.0
pagp.flushlocaldev	Flush Local Device ID	Ethernet or other MAC address	1.0.0 to 3.4.0
pagp.flushpartnerdev	Flush Partner Device ID	Ethernet or other MAC address	1.0.0 to 3.4.0
pagp.localdev	Local Device ID	Ethernet or other MAC address	1.0.0 to 3.4.0
pagp.locallearncap	Local Learn Capability	Unsigned integer, 1 byte	1.0.0 to 3.4.0
pagp.localgroupcap	Local Group Capability	Unsigned integer, 4 bytes	1.0.0 to 3.4.0
pagp.localgroupifindex	Local Group ifindex	Unsigned integer, 4 bytes	1.0.0 to 3.4.0
pagp.localportpri	Local Port Hot Standby Priority	Unsigned integer, 1 byte	1.0.0 to 3.4.0
pagp.localsentportifindex	Local Sent Port ifindex	Unsigned integer, 4 bytes	1.0.0 to 3.4.0
pagp.numtlvs	Number of TLVs	Unsigned integer, 2 bytes	1.0.0 to 3.4.0
pagp.partnercount	Partner Count	Unsigned integer, 2 bytes	1.0.0 to 3.4.0
pagp.partnerdev	Partner Device ID	Ethernet or other MAC address	1.0.0 to 3.4.0
pagp.partnergroupcap	Partner Group Capability	Unsigned integer, 4 bytes	1.0.0 to 3.4.0
pagp.partnergroupifindex	Partner Group ifindex	Unsigned integer, 4 bytes	1.0.0 to 3.4.0
pagp.partnerlearncap	Partner Learn Capability	Unsigned integer, 1 byte	1.0.0 to 3.4.0
pagp.partnerportpri	Partner Port Hot Standby Priority	Unsigned integer, 1 byte	1.0.0 to 3.4.0
pagp.partnersentportifindex	Partner Sent Port ifindex	Unsigned integer, 4 bytes	1.0.0 to 3.4.0
pagp.tlv	Type	Unsigned integer, 2 bytes	1.0.0 to 3.4.0
pagp.tlv_length	Length	Unsigned integer, 2 bytes	2.0.0 to 3.4.0
pagp.tlv_length.invalid	Invalid TLV length	Label	2.0.0 to 3.4.0
pagp.tlvagportmac	Agport MAC Address	Ethernet or other MAC address	1.0.0 to 3.4.0
pagp.tlvdevname	Device Name	Character string	1.0.0 to 3.4.0
pagp.tlvportname	Physical Port Name	Character string	1.0.0 to 3.4.0
pagp.transid	Transaction ID	Unsigned integer, 4 bytes	1.0.0 to 3.4.0
pagp.version	Version	Unsigned integer, 1 byte	1.0.0 to 3.4.0

6.2 Configure EtherChannel

Configuration Guidelines

The following guidelines and restrictions are useful for configuring EtherChannel:

- **EtherChannel support** - All Ethernet interfaces must support EtherChannel with no requirement that interfaces be physically contiguous.
- **Speed and duplex** - Configure all interfaces in an EtherChannel to operate at the **same speed and in the same duplex mode**.
- **VLAN match** - All interfaces in the EtherChannel bundle must be assigned to the **same VLAN** or be configured as a **trunk**.
- **Range of VLANs** - An EtherChannel supports the same **allowed range of VLANs on all the interfaces** in a trunking EtherChannel. If the allowed range of VLANs is not the same, the interfaces do not form an EtherChannel, even when they are set to **auto** or **desirable** mode.

Configuration Guidelines (Cont.)

- The **figure** shows a configuration that would allow an EtherChannel to form between S1 and S2.
- If these settings must be changed, configure them in port channel interface configuration mode. Any configuration that is applied to the port channel interface also affects individual interfaces. However, configurations that are applied to the individual interfaces do not affect the port channel interface. Therefore, making configuration changes to an interface that is part of an EtherChannel link may cause interface compatibility issues.
- The port channel can be configured in **access mode, trunk mode** (most common), or on a **routed port**.

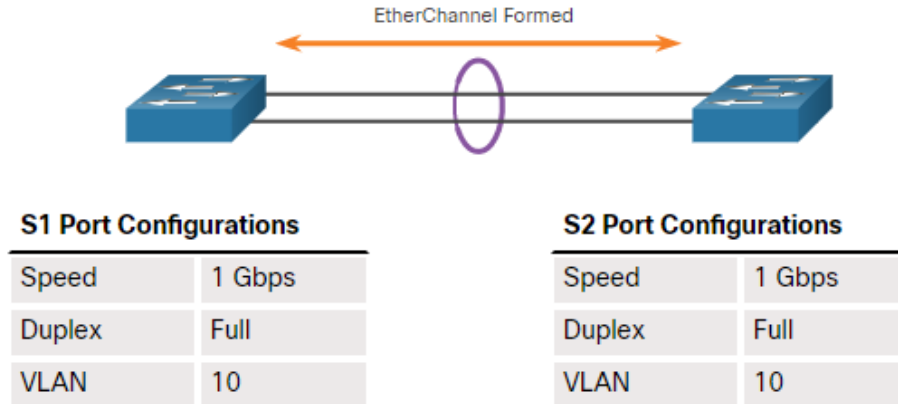

LACP Configuration Example

Configuring EtherChannel with LACP requires the following three steps:

- **Step 1.** Specify the **interfaces** that compose the EtherChannel group using the **interface range** *interface* global configuration mode command. The **range** keyword allows you to select several interfaces and configure them all together.
- **Step 2.** Create the **port channel** interface with the **channel-group** *identifier mode active* command in interface range configuration mode. The identifier specifies a channel group number. The **mode active** keywords identify this as an LACP EtherChannel configuration. [Definice kanálu](#)
- **Step3.** To change Layer 2 settings on the port channel interface, enter port channel interface configuration mode using the **interface port-channel** command, followed by the interface identifier. In the example, S1 is configured with an LACP EtherChannel. The port channel is configured as a trunk interface with the allowed VLANs specified. [Nastavení parametrů kanálu](#)

```
S1(config)# interface range FastEthernet 0/1 - 2
S1(config-if-range)# channel-group 1 mode active
Creating a port-channel interface Port-channel 1
S1(config-if-range)# exit
S1(config-if)# interface port-channel 1
S1(config-if)# switchport mode trunk
S1(config-if)# switchport trunk allowed vlan 1,2,20
```

Ukázka CCNP: Port-Channel Load Balancing Hash Option

The global command **port-channel load-balance** *hash*. The *hash* option has the following keyword choices:

- **dst-ip**: Destination IP address
- **dst-mac**: Destination MAC address
- **dst-mixed-ip-port**: Destination IP address and destination TCP/UDP port
- **dst-port**: Destination TCP/UDP port
- **src-dst-ip**: Source and destination IP addresses
- **src-dst-ip-only**: Source and destination IP addresses only
- **src-dst-mac**: Source and destination MAC addresses
- **src-dst-mixed-ip-port**: Source and destination IP addresses and source and destination TCP/UDP ports
- **src-dst-port**: Source and destination TCP/UDP ports only
- **src-ip**: Source IP address
- **src-mac**: Source MAC address
- **src-mixed-ip-port**: Source IP address and source TCP/UDP port
- **src-port**: Source TCP/UDP port

Packet Tracer – Configure EtherChannel

In this Packet Tracer, you will complete the following objectives:

- Configure Basic Switch Settings
- Configure an EtherChannel with Cisco PAgP
- Configure and 802.3ad EtherChannel
- Configure a Redundant EtherChannel Link

6.3 Verify and Troubleshoot EtherChannel

Verify EtherChannel

As always, when you configure devices in your network, you must verify your configuration. If there are problems, you will also need to be able to troubleshoot and fix them. There are a number of commands to verify an EtherChannel configuration:

- The **show interfaces port-channel** command displays the general status of the port channel interface.
- The **show etherchannel summary** command displays one line of information per port channel.
- The **show etherchannel port-channel** command displays information about a specific port channel interface.
- The **show interfaces etherchannel** command can provide information about the **role of a physical member interface** of the EtherChannel.

Common Issues (typické problémy) with EtherChannel Configurations

All interfaces within an EtherChannel must have the same configuration of speed and duplex mode, native and allowed VLANs on trunks, and access VLAN on access ports. Ensuring these configurations will significantly reduce network problems related to EtherChannel. Common EtherChannel issues include the following:

- Assigned ports in the EtherChannel are **not part of the same VLAN**, or **not configured as trunks**. Ports with **different native VLANs** cannot form an EtherChannel.
- **Trunking** was configured on some of the ports that make up the EtherChannel, but **not all of them**. It is not recommended that you configure trunking mode on individual ports that make up the EtherChannel. When configuring a trunk on an EtherChannel, verify the trunking mode on the EtherChannel.
- If the allowed **range of VLANs is not the same**, the ports do not form an EtherChannel even when PAgP is set to the **auto** or **desirable** mode.
- The **dynamic negotiation options** for PAgP and LACP **are not compatibly** configured on both ends of the EtherChannel.

Troubleshoot EtherChannel Example

In the figure, interfaces Fa0/1 and Fa0/2 on switches S1 and S2 are connected with an EtherChannel. However, the EtherChannel is not operational.

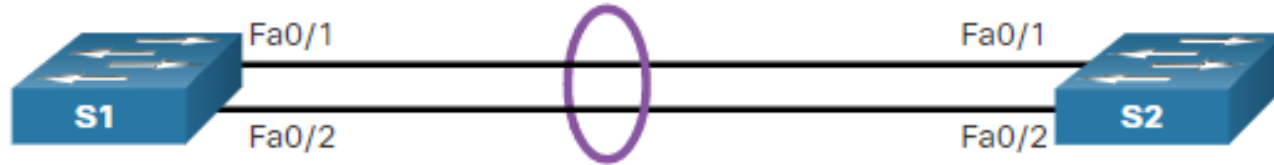

Typické stavy logických kanálů

- U – **USED**.
- D – **DOWN**.
- P – Port Channel – ruční nastavení.
- M – Není splněna podmínka nastavená příkazem **port-channel min-links** *min-member-interfaces*.
- S – L2.
- R – L3.

Troubleshoot EtherChannel Example (Cont.)

Step 1. View the EtherChannel Summary Information: The output of the **show etherchannel summary** command indicates that the EtherChannel is down.

```
S1# show etherchannel summary
Flags: D - down          P - bundled in port-channel
       I - stand-alone  s - suspended
       H - Hot-standby (LACP only)
       R - Layer3       S - Layer2
       U - in use       N - not in use, no aggregation
       f - failed to allocate aggregator
       M - not in use, minimum links not met
       m - not in use, port not aggregated due to minimum links not met
       u - unsuitable for bundling
       w - waiting to be aggregated
       d - default port
       A - formed by Auto LAG
Number of channel-groups in use: 1
Number of aggregators:          1
Group  Port-channel  Protocol    Ports
-----+-----+-----+-----
1      Po1(SD)        -           Fa0/1(D)  Fa0/2(D)
```

S – L2, D - down

Troubleshoot EtherChannel Example (Cont.)

Step 2. View Port Channel Configuration: In the `show run | begin interface port-channel` output, more detailed output indicates that there are incompatible PAgP modes configured on S1 and S2.

```
S1# show run | begin interface port-channel
interface Port-channel1
  switchport trunk allowed vlan 1,2,20
  switchport mode trunk
!
interface FastEthernet0/1
  switchport trunk allowed vlan 1,2,20
  switchport mode trunk
  channel-group 1 mode on
!
interface FastEthernet0/2
  switchport trunk allowed vlan 1,2,20
  switchport mode trunk
  channel-group 1 mode on
!=====
S2# show run | begin interface port-channel
interface Port-channel1
  switchport trunk allowed vlan 1,2,20
  switchport mode trunk
!
interface FastEthernet0/1
  switchport trunk allowed vlan 1,2,20
  switchport mode trunk
  channel-group 1 mode desirable
!
interface FastEthernet0/2
  switchport trunk allowed vlan 1,2,20
  switchport mode trunk
  channel-group 1 mode desirable
```

Troubleshoot EtherChannel Example (Cont.)

Step 3: Correct the Misconfiguration: To correct the issue, the PAgP mode on the EtherChannel is changed to desirable.

Note: EtherChannel and STP must interoperate. For this reason, the order in which EtherChannel-related commands are entered is important, which is why you see interface Port-Channel 1 removed and then re-added with the **channel-group** command, as opposed to directly changed. **If one tries to change the configuration directly, STP errors cause the associated ports to go into blocking or errdisabled state.**

```
S1(config)# no interface port-channel 1
S1(config)# interface range fa0/1 - 2
S1(config-if-range)# channel-group 1 mode desirable
Creating a port-channel interface Port-channel 1
S1(config-if-range)# no shutdown
S1(config-if-range)# exit
S1(config)# interface range fa0/1 - 2
S1(config-if-range)# channel-group 1 mode desirable
S1(config-if-range)# no shutdown
S1(config-if-range)# interface port-channel 1
S1(config-if)# switchport mode trunk
S1(config-if)# end
S1#
```

Troubleshoot EtherChannel Example (Cont.)

Step 4. Verify EtherChannel is Operational: The EtherChannel is now active as verified by the output of the **show etherchannel summary** command.

```
S1# show etherchannel summary
Flags: D - down          P - bundled in port-channel
       I - stand-alone  s - suspended
       H - Hot-standby (LACP only)
       R - Layer3       S - Layer2
       U - in use       N - not in use, no aggregation
       f - failed to allocate aggregator
       M - not in use, minimum links not met
       m - not in use, port not aggregated due to minimum links not met
       u - unsuitable for bundling
       w - waiting to be aggregated
       d - default port
       A - formed by Auto LAG
Number of channel-groups in use: 1
Number of aggregators:          1
Group  Port-channel  Protocol    Ports
-----+-----+-----+-----
1      Po1(SU)        PAgP        Fa0/1(P)  Fa0/2(P)
```

Packet Tracer – Troubleshoot EtherChannel

In this Packet Tracer, you will complete the following:

- Examine the Physical Layer and Correct Switch Port Mode Issues
- Identify and Correct Port Channel Assignment Issues
- Identify and Correct Port Channel Assignment Issues

Příklad: Co uděláme jako první u load balancingu?

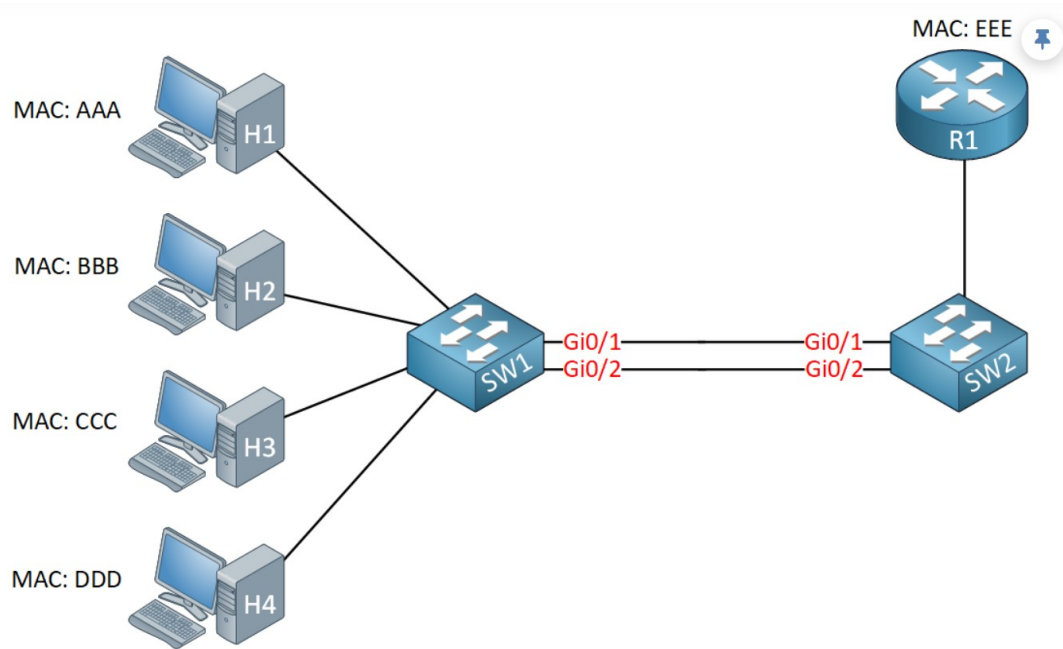

1.Koukneme se, co je default

```
SW1#show EtherChannel load-balance
```

```
EtherChannel Load-Balancing Configuration:
```

```
    src-mac
```

```
EtherChannel Load-Balancing Addresses Used Per-Protocol:
```

```
Non-IP: Source MAC address
```

```
  IPv4: Source MAC address
```

```
  IPv6: Source MAC address
```

Je to pro tento typický případ dobrá volba?

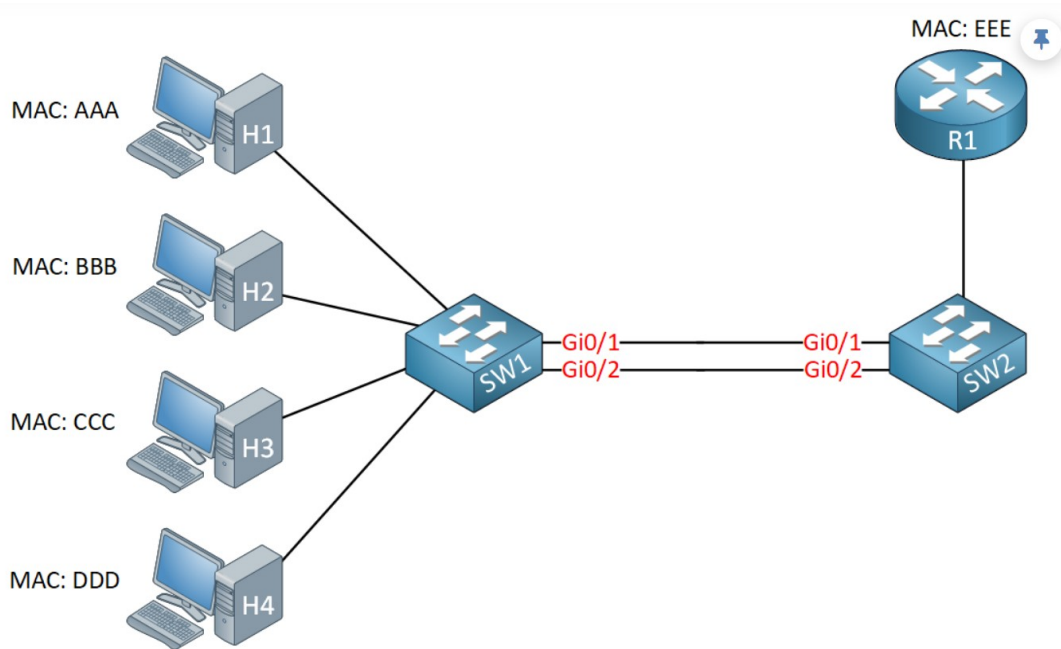

Směrem k serveru je to fajn, ale zpětně ne

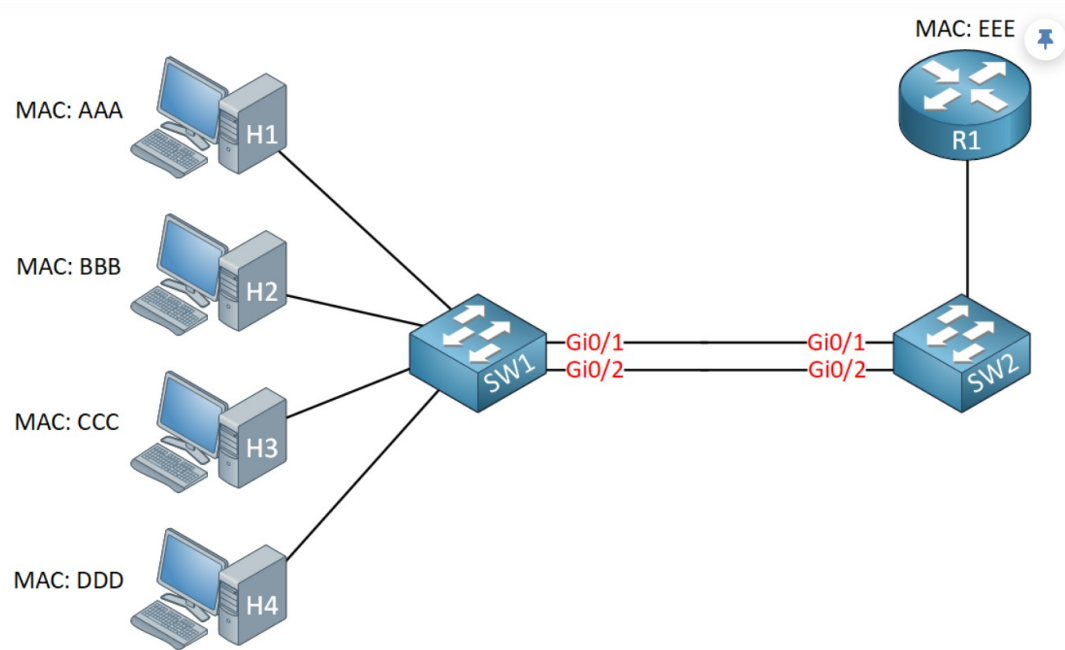

2. Zvážím proto další možnosti

```
SW1(config)#port-channel load-balance ?
```

```
dst-ip      Dst IP Addr
```

```
dst-mac     Dst Mac Addr
```

```
src-dst-ip  Src XOR Dst IP Addr
```

```
src-dst-mac Src XOR Dst Mac Addr
```

```
src-ip      Src IP Addr
```

```
src-mac     Src Mac Addr
```

```
SW2(config)#port-channel load-balance dst-mac
```

Troubleshooting: špatný mód

<https://networklessons.com/switching/troubleshooting-etherchannel>

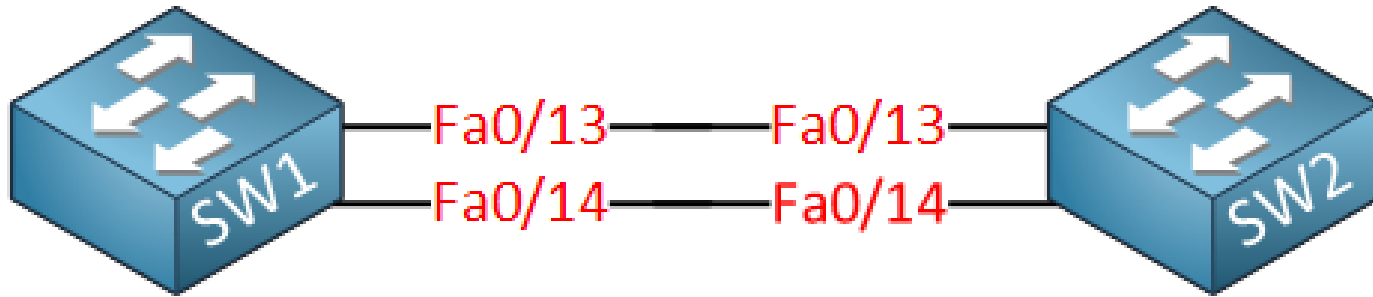

Module 6: Testovací otázky

Téma 6.1

Jaký je účel protokolů pro vyjednávání EtherChannel?

Jaký je rozdíl mezi LACP a PAgP, pokud jde o počet rozhraní, která mohou být seskupena do skupiny?

Téma 6.2

Jakou instanci byste mohli nakonfigurovat bundle EtherChannel v režimu access?

Proč si myslíte, že u stávajících skupin portů a kanálů je nutné provést změny konfigurace pod port-channel groups?

Téma 6.3

Jak mohou být zaměněny protokoly DTP a EtherChannel?

Uveďte konfigurace, která by mohla způsobit, že skupina kanálů nebude úspěšně přijata?

6.4 Module Practice and Quiz

Packet Tracer – Implement EtherChannel

In this Packet Tracer, you will complete the following:

- Build the Network
- Configure EtherChannel

Lab – Implement EtherChannel

In this lab, you will complete the following objectives:

- Part 1: Build the Network and Configure Basic Device Settings
- Part 2: Create VLANs and Assign Switch Ports
- Part 3: Configure 802.1Q Trunks between the Switches
- Part 4: Implement and Verify an EtherChannel between the switches

What Did I Learn In This Module?

- To increase bandwidth or redundancy, multiple links could be connected between devices. However, STP will block redundant links to prevent switching loops. EtherChannel is a link aggregation technology that allows redundant links between devices that will not be blocked by STP.
- EtherChannel groups multiple physical Ethernet links together into one single logical link. It provides fault-tolerance, load sharing, increased bandwidth, and redundancy between switches, routers, and servers.
- When an EtherChannel is configured, the resulting virtual interface is called a port channel.
- EtherChannels can be formed through negotiation using one of two protocols, PAgP or LACP. These protocols allow ports with similar characteristics to form a channel through dynamic negotiation with adjoining switches.
- When an EtherChannel link is configured using Cisco-proprietary PAgP, PAgP packets are sent between EtherChannel-capable ports to negotiate the forming of a channel. Modes for PAgP are On, PAgP desirable, and PAgP auto.
- LACP performs a function similar to PAgP with Cisco EtherChannel. Because LACP is an IEEE standard, it can be used to facilitate EtherChannels in multivendor environments. Modes for LACP are On, LACP active, and LACP passive.

Co jste se naučili 1 z 3

Aby se zvýšila šířka pásma nebo redundance, mohlo být mezi zařízeními připojeno více kabelů. STP však zablokuje redundantní odkazy, aby se zabránilo smyčkám. EtherChannel je technologie agregace odkazů, která umožňuje redundantní propojení mezi zařízeními, která nebudou blokována STP.

EtherChannel seskupuje více fyzických ethernet. linek do jednoho logického spojení. Poskytuje odolnost proti chybám, sdílení zátěže, větší šířku pásma a redundanci mezi přepínači, směrovači a servery.

Když je nakonfigurován EtherChannel, výsledné virtuální rozhraní se nazývá port channel.

EtherChannels lze vytvořit vyjednáváním pomocí jednoho ze dvou protokolů, PAgP nebo LACP. Tyto protokoly umožňují portům s podobnými charakteristikami vytvořit kanál pomocí dynamického vyjednávání se sousedními přepínači.

Když je propojení EtherChannel konfigurováno pomocí proprietárního PAgP, pakety PAgP jsou odesílány mezi porty podporujícími EtherChannel, aby bylo možné vyjednat vytvoření kanálu. Režimy pro PAgP jsou On, PAgP desirable (žádoucí) a PAgP auto.

LACP vykonává funkci podobnou PAgP s Cisco EtherChannel. Protože LACP je standard IEEE, lze jej použít k vytvoření EtherChannels v prostředích více dodavatelů. Režimy pro LACP jsou On, LACP active a LACP passive.

What Did I Learn In This Module? (Cont.)

- The following guidelines and restrictions are useful for configuring EtherChannel:
 - All Ethernet interfaces on all modules must support EtherChannel with no requirement that interfaces be physically contiguous, or on the same module.
 - Configure all interfaces in an EtherChannel to operate at the same speed and in the same duplex mode.
 - All interfaces in the EtherChannel bundle must be assigned to the same VLAN or be configured as a trunk.
 - An EtherChannel supports the same allowed range of VLANs on all the interfaces in a trunking EtherChannel.
- Configuring EtherChannel with LACP requires three steps:
 - Step 1. Specify the interfaces that compose the EtherChannel group using the **interface range *interface*** global configuration mode command.
 - Step 2. Create the port channel interface with the **channel-group *identifier* mode active** command in interface range configuration mode.
 - Step 3. To change Layer 2 settings on the port channel interface, enter port channel interface configuration mode using the **interface port-channel** command, followed by the interface identifier.

Co jste se naučili 2 z 3

Následující pokyny a omezení jsou užitečné pro konfiguraci EtherChannel:

- Všechna ethernetová rozhraní na všech modulech musí podporovat EtherChannel bez požadavku na fyzickou souvislost rozhraní nebo na stejném modulu.
- Nakonfigurujte všechna rozhraní v EtherChannel tak, aby fungovala stejnou rychlostí a ve stejném duplexním režimu.
- Všechna rozhraní ve svazku EtherChannel musí být přiřazena ke stejné síti VLAN nebo musí být nakonfigurována jako trunk.
- EtherChannel podporuje stejný povolený rozsah VLAN na všech rozhraních v kanálu EtherChannel.

Konfigurace EtherChannel s LACP vyžaduje tři kroky:

- Krok 1. Určete rozhraní, která tvoří skupinu EtherChannel, pomocí příkazu režimu globální konfigurace rozhraní rozsahu rozhraní.
- Krok 2. Vytvořte rozhraní kanálu kanálů s aktivním příkazem režimu identifikátoru skupiny kanálů v režimu konfigurace rozsahu rozhraní.
- Krok 3. Chcete-li změnit nastavení vrstvy 2 na rozhraní kanálu kanálu, přejděte do režimu konfigurace rozhraní kanálu pomocí příkazu rozhraní port-kanál a poté identifikátoru rozhraní.

What Did I Learn In This Module? (Cont.)

- There are a number of commands to verify an EtherChannel configuration including **show interfaces port-channel**, **show etherchannel summary**, **show etherchannel port-channel**, and **show interfaces etherchannel**.
- Common EtherChannel issues include the following:
 - Assigned ports in the EtherChannel are not part of the same VLAN, or not configured as trunks.
 - Ports with different native VLANs cannot form an EtherChannel.
 - Trunking was configured on some of the ports that make up the EtherChannel, but not all of them.
 - If the allowed range of VLANs is not the same, the ports do not form an EtherChannel even when PAgP is set to the auto or desirable mode.
 - The dynamic negotiation options for PAgP and LACP are not compatibly configured on both ends of the EtherChannel.

Co jste se naučili 3 z 3

Existuje řada příkazů k ověření konfigurace EtherChannel, včetně

show interfaces port-channel

show etherchannel summary

show etherchannel port-channel

show interfaces etherchannel

Mezi běžné problémy EtherChannel patří následující:

- Přiřazené porty v EtherChannel nejsou součástí stejné VLAN nebo nejsou nakonfigurovány jako trunky.
- Porty s různými nativními VLAN nemohou tvořit EtherChannel.
- Trunking byl nakonfigurován na některých portech, které tvoří EtherChannel, ale ne na všech.
- Pokud povolený rozsah VLAN není stejný, porty netvoří EtherChannel, i když je PAgP nastaven na auto nebo desirable režim.
- Možnosti dynamického vyjednávání pro PAgP a LACP nejsou kompatibilní na obou koncích EtherChannel.

