

# **European Expansion:** Europeanization of the International Economy and Industrial Revolution

Europe in World Economy 2017

# International trade

- **Opportunities beyond limits of domestic market and agricultural productivity** – international **division of labor** (A. Smith: DoL - extent M);
- IT – **most dynamic element** of early modern European **economy**;
  - i.e. **Holland** – **shift** towards **livestock** and dairy, **fishing, urban expansion**;
  - Shift of **basic agriculture** into **Eastern Europe** (intensifying feudal methods of exploitation there);
- Initially little to do with **free markets** (FM) – **governments** trying to **force competing** nations **out** of markets;
  - **Mercantilism**: nations' **wealth** grows by achieving favorable **balance of trade**; **exclusion** of foreign **competitors** rather than attempt to gain **competitive strength**;
  - **Primary** economic **aim** of merchants and conquerors was to **create protected niche** in world market **without competition** from **other Europeans** (Estado da India, EIC, VOC);







*Table 1.4 Estimates of the size and regional distribution of the European merchant fleet 1500–1780*

	Total fleet size (000 tons)	Capacity per 1000 inhabitants (tons)	Regional shares in European fleet capacity				
			Southern Europe	Netherlands	Great Britain	France	Hansa
1500	200–250	3.2–4.0	40	16	10–12	?	20
1600	600–700	7.7–9.0	25	33	10	12	15
1670	1000–1100	12.8–14.1	20	40	12	8–14	10
1780	3372	30.7	15	12	26	22	4

*Sources:* Romano (1962), Vogel (1915), Lane (1966, 5–20) Van Zanden (1987, 587), Wilson (1977, 129).

**Table 2–15. Carrying Capacity of Dutch and Other European Merchant Fleets, 1470–1824**  
(metric tons)

	<b>1470</b>	<b>1570</b>	<b>1670</b>	<b>1780</b>	<b>1824</b>
Netherlands	60 000	232 000	568 000	450 000	140 000
Germany	60 000	110 000	104 000	155 000	
Britain	n.a.	51 000	260 000	1 000 000	
France	n.a.	80 000	80 000	700 000	
Italy, Portugal, Spain	n.a.	n.a.	250 000	546 000	
Denmark, Norway and Sweden				555 000 <sup>a</sup>	
North America				450 000	

Table 2–18a. **Dutch Involvement in European Military Conflicts, 1560s–1815**

***Wars with Spain to establish  
and guarantee Independence***

1560s–1609  
1621–48

***Wars of commercial  
interest with England***

1652–4  
1665–7  
1672–4  
1780–3

***Wars over European  
balance of power,  
territory & religion***

1618–48: 30 Years War  
1688–97: War of League of Augsburg  
1701–13: War of Spanish Succession  
1756–63: Seven Years War  
1795–1815: Revolutionary & Napoleonic Wars



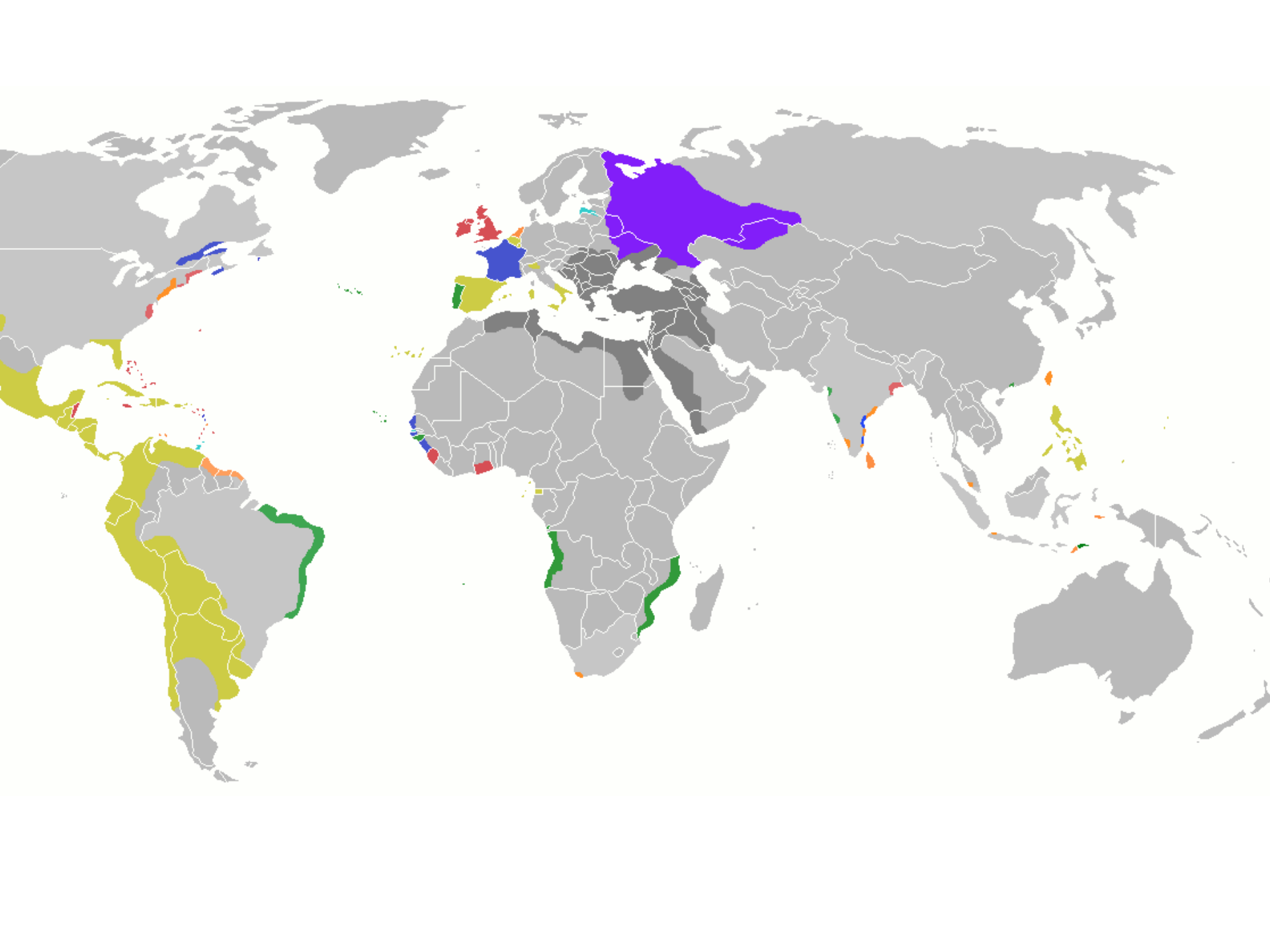

# The Struggle for Colonial Dominion, 1700—1763.



Table 2–20. **Commodity Composition of European Exports from Asia to Europe, 1513–1780**

Portugal (Estado da India — state trading, headquarters Goa)  
(per cent by weight)

	<b>1513–19</b>	<b>1608–10</b>
Pepper	80.0	69.0
Moluccan Spices	9.0	0.03
Other Spices	9.4	10.9
Textiles	0.2	7.8
Indigo	0.0	7.7
Other	1.4	4.6

Dutch East India Company (VOC corporate monopoly, headquarters Batavia)  
(per cent by value)

	<b>1619–21</b>	<b>1778–80</b>
Pepper	56.4	11.0
Other Spices	17.6	24.4
Textiles & Raw Silk	16.1	32.7
Coffee & Tea	0.0	22.9
Other	9.9	9.0

English East India Company (EIC corporate monopoly operating  
mainly from Bombay, Calcutta and Madras)  
(per cent by value)

	<b>1668–70</b>	<b>1758–60</b>
Pepper	25.3	4.4
Textiles	56.6	53.5
Raw Silk	0.6	12.3
Tea	0.03	25.3
Other	17.5	4.5



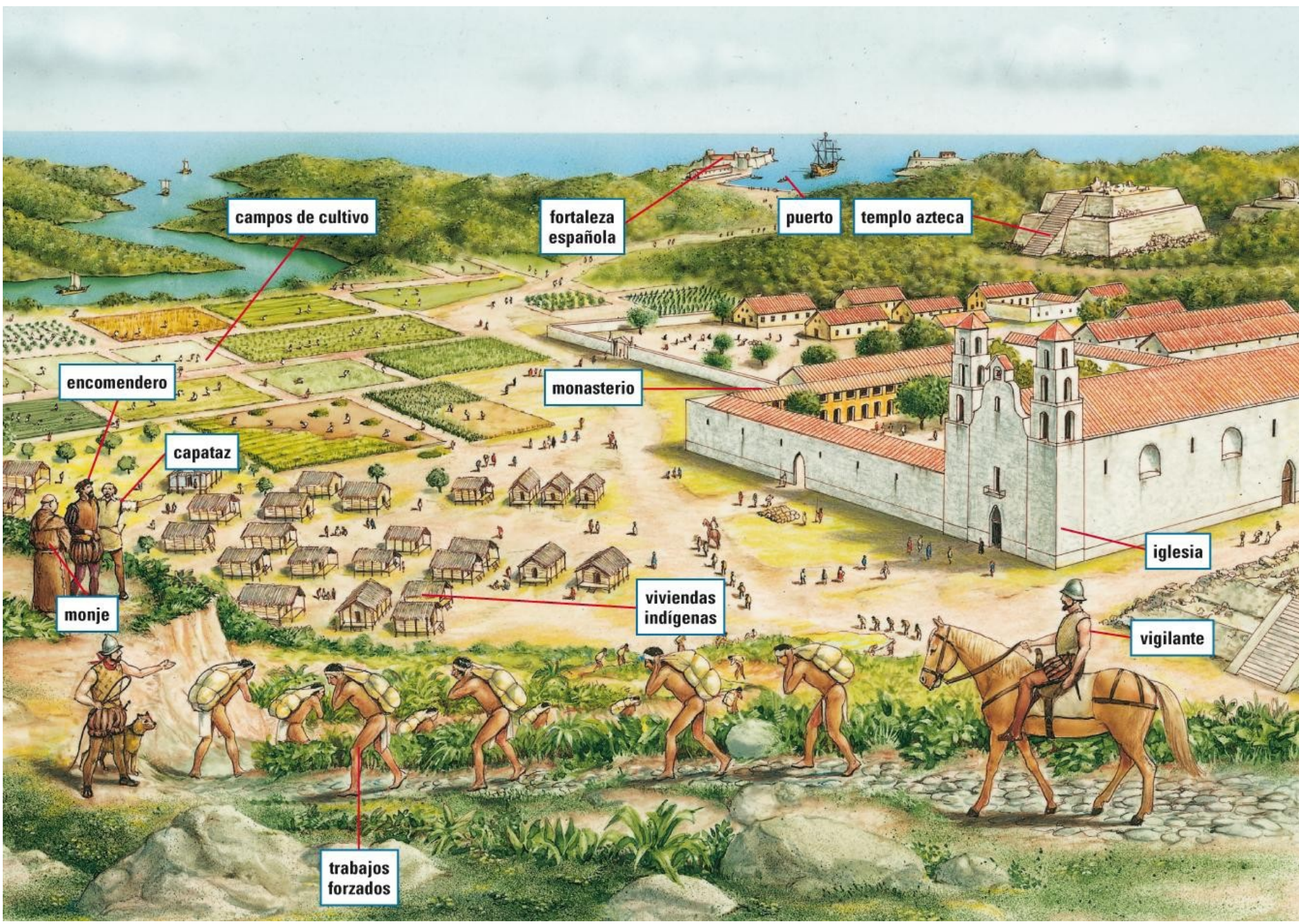

campos de cultivo

fortaleza española

puerto

templo azteca

encomendero

monasterio

capataz

iglesia

monje

viviendas indígenas

vigilante

trabajos forzados

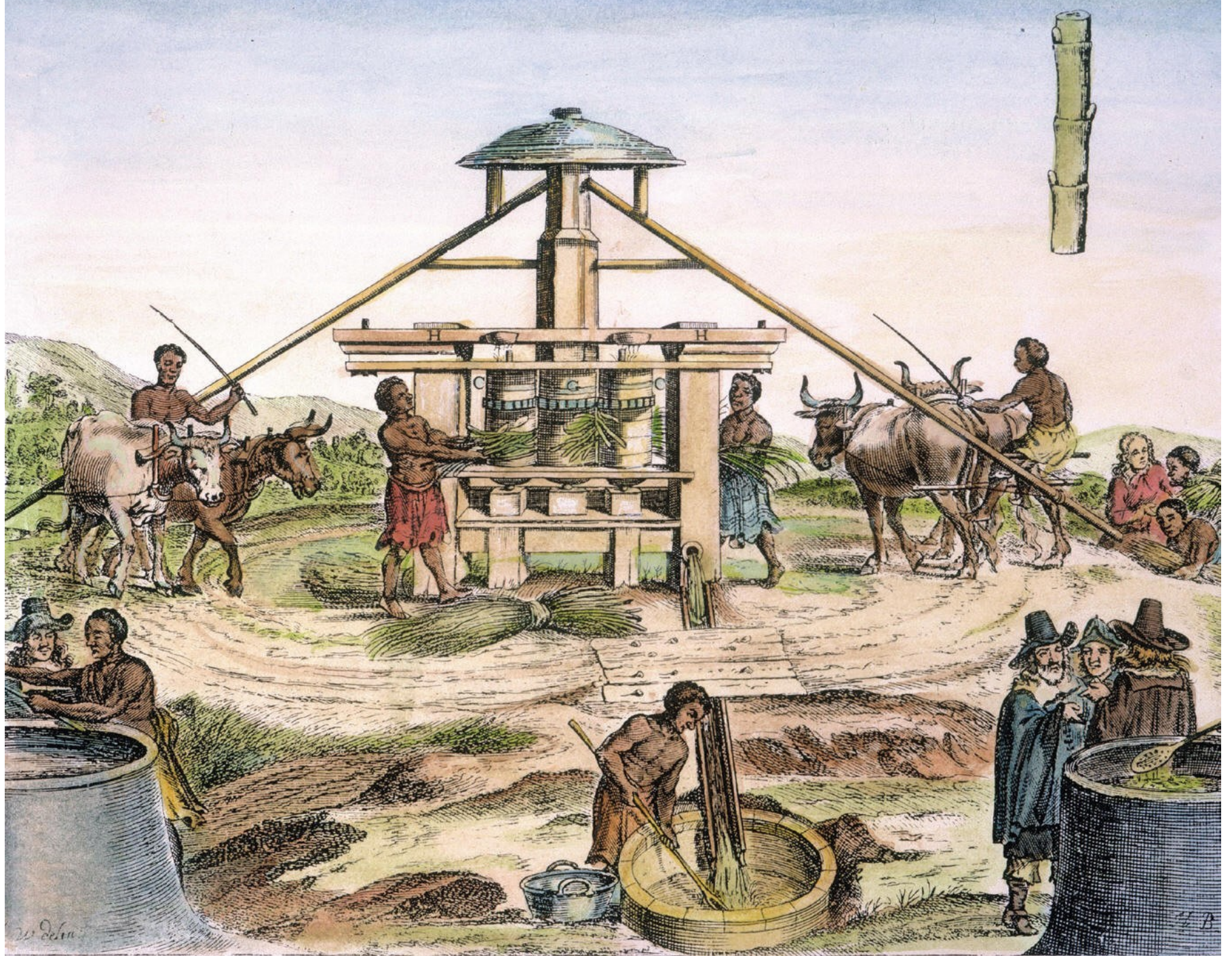

W. Dehn

48



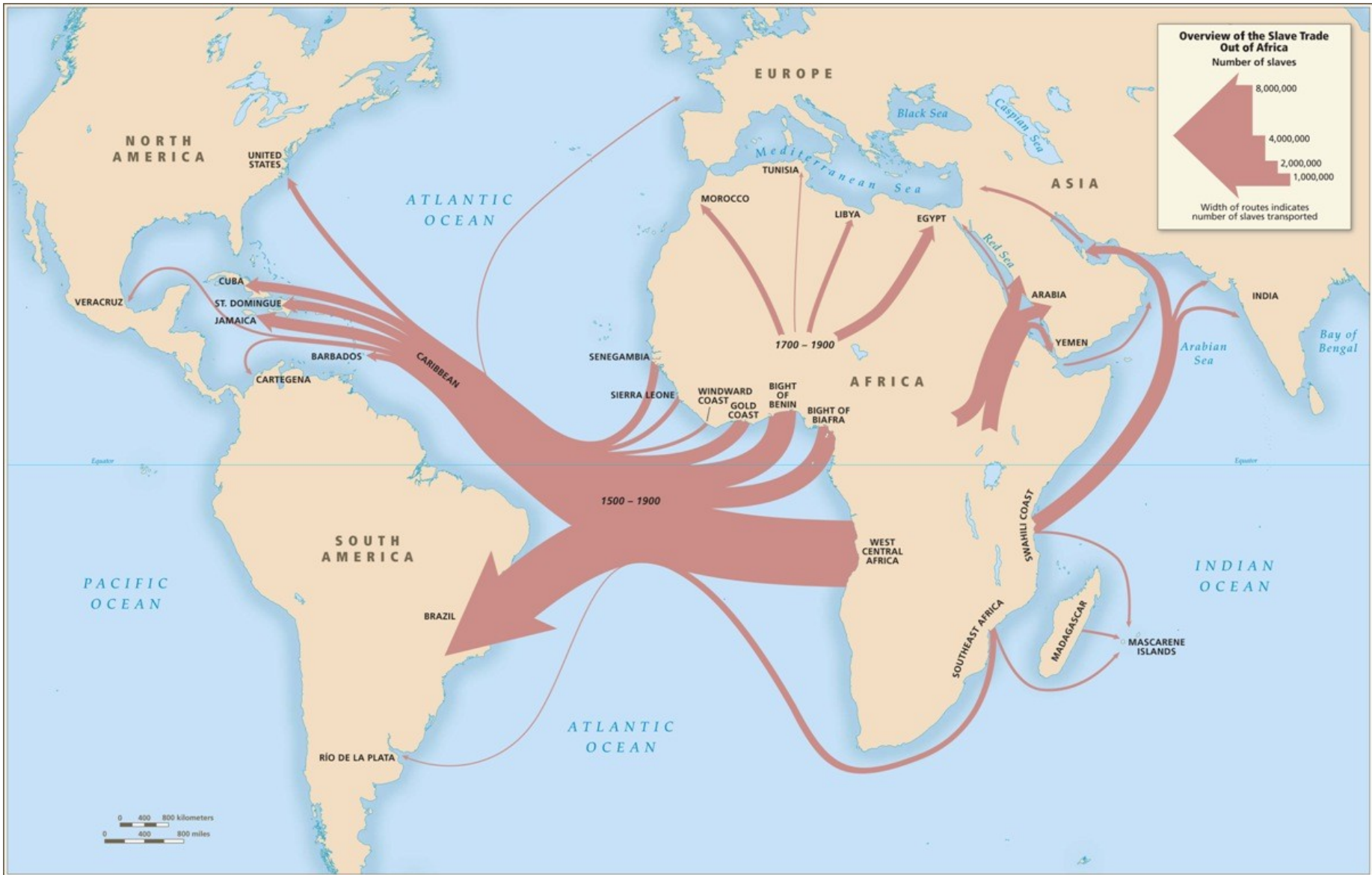

**Overview of the Slave Trade Out of Africa**  
 Number of slaves

8,000,000  
 4,000,000  
 2,000,000  
 1,000,000

Width of routes indicates number of slaves transported

1500 - 1900

1700 - 1900

0 400 800 kilometers  
 0 400 800 miles



**Table 2–5. Atlantic Slave Shipments by Portugal and Its Competitors, 1701–1800**  
(000)

England	2 532	North America	194
Portugal	1 796	Denmark	74
France	1 180	Other	5
Netherlands	351	Total	6 132

Source: Lovejoy (1982), p. 483.

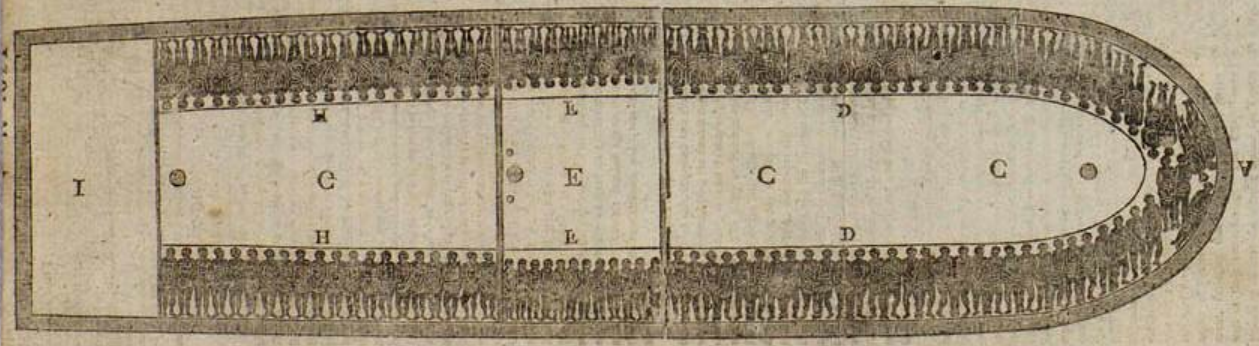
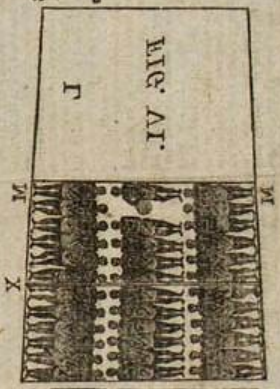
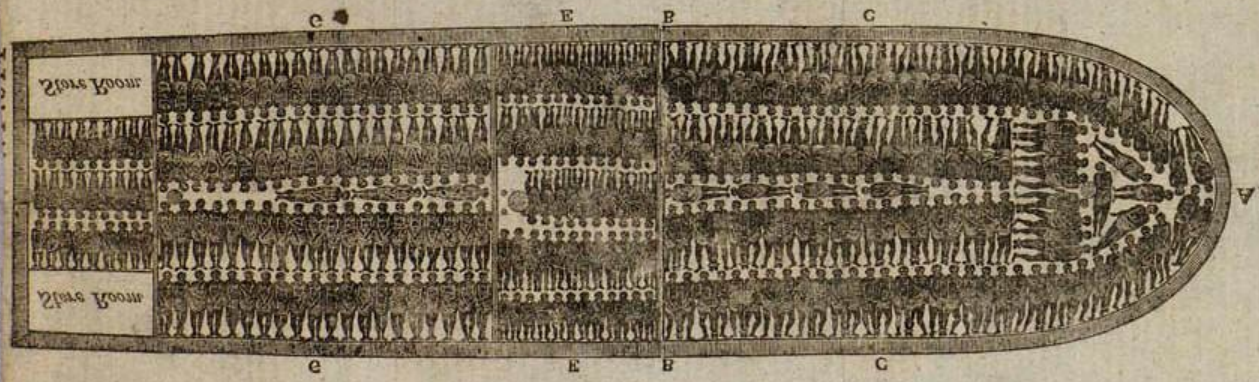
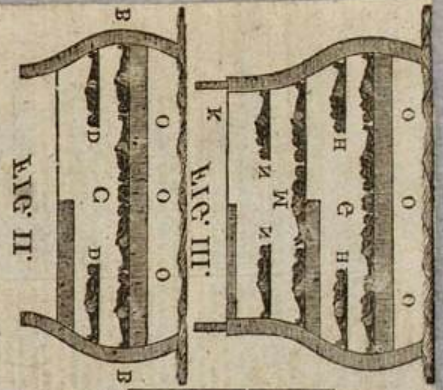
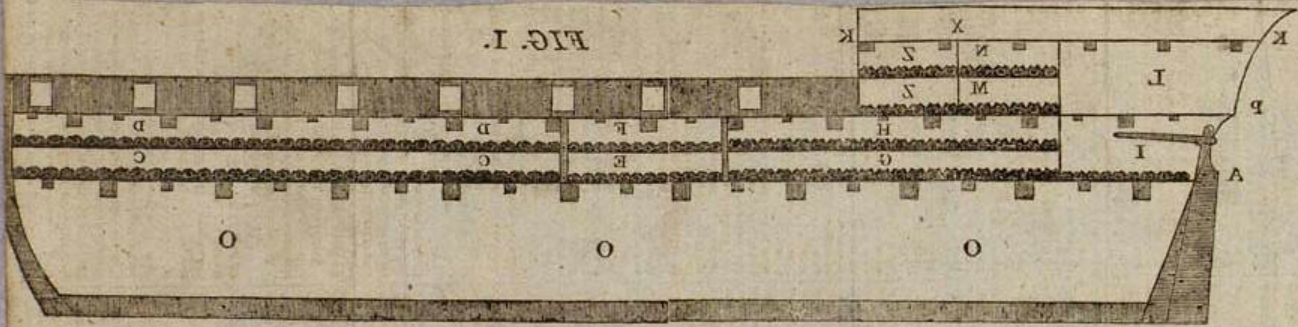

ISFSA85

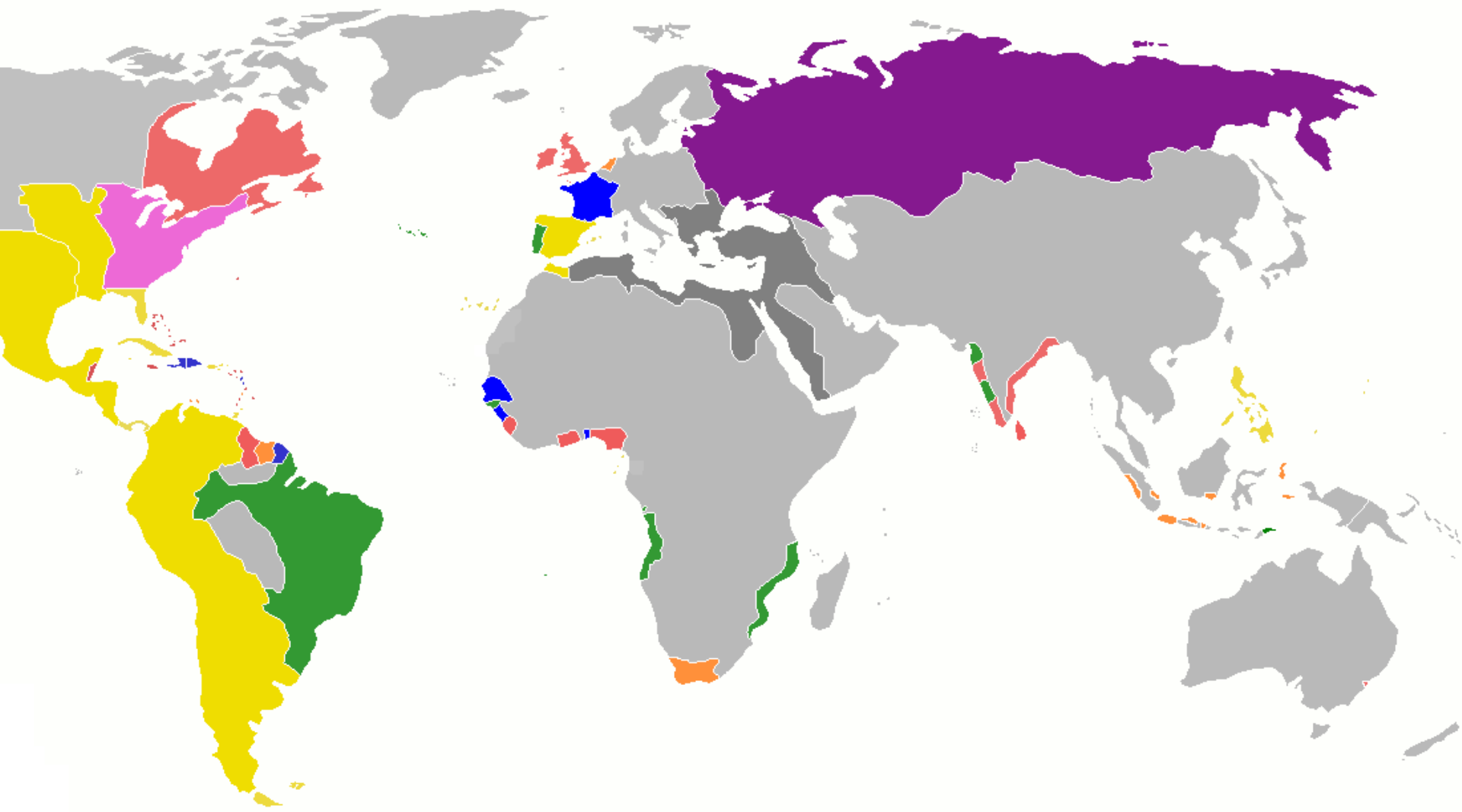

# Industrial Revolution

- **18<sup>th</sup> cent. series of inventions transformed the British cotton manufacture: new mode of production – the factory system;**
- **Principles: (*Landes*)**
  - The **substitution** of machines (rapid, regular, precise, tireless) **for human skill and effort (converting heat into work)**;
  - Use of **new** and more abundant raw materials (substitution of **coal for wood and animal**);
- **In past – better living standards had always been followed by a rise in population-> eventually consumed the gains (Malthusian trap) (*Clark*);**
- **IR: for the first time in history – both the economy and knowledge were growing fast enough to generate a continuing flow of improvements -> considerably rising standard of living;**



*(Landes)*

- **14<sup>th</sup> Italy** –water powered **silk spinning**– industry prospered for centuries;
- **England** built a large **water powered mill** employing hundreds workers;
  - comparable to the **cotton mills** of later era (late 18th century);
  - more than **enough** to accommodate England’s **demand** for silk yarn – costly material, small clientele;
  - **No industrial revolution** of silk;
- **Wool** much more important in Europe - **role of cotton** accident;
  - Wool industry protected by prohibition of imports of Indian calicoes (British capital and labor would be hurt);
  - Factory (power machinery) industry production: raw cotton -> cotton yarn (fustian, flax)... British capital and labor is promoted);
  - Deindustrialization of Asia;

- System of **rural manufactures** (dispersion of activity - **costs** of distribution and collection);
  - **Idea of large workshops** where spinners and weavers under **supervision**;
- Manufacturers had to **pay to persuade people out of cottages** and into mills –
  - So long as the **equipment** in the **mill** was the **same** as in the cottage, mill **production cost more**;
- It took **power machinery** to **make the factory competitive**
  - In spite higher wages mills still seemed a prison;
  - Where to **get labor force**? **Children**, often conscripted from the poorhouses and **woman**, especially unmarried;
- **Wool fibers troublesome** - **cotton docile**, investor turned attention;

## Steam power (*Landes; Cameron, Neal*)

- **Vacuum pump** (*Savery* 1698);
- First **steam engine** *Newcomen* (1705);
- *Watt* (1768) engine with separated **condenser** (profitable **away** from the **mines**);
- 15 years to adapt for **rotary motions**;
- **High pressure** engines more compact and used to drive **ships** and land **vehicles** (another 25 years);
- *Parsons* (1884) replacing the piston with a **steam turbine**;
- *Darby* (1709) **coke smelt** of iron;
- **Cast iron** → pots and pans, pipes; **moving parts** - require resilience and elasticity - **steel**;
- **Cheap steel** – *Bessemer* 1856;
  - transformed industry and transportation (**arms**, razors vs. rails and **ships**);
- **Powered machinery**
  - **Device to move a tool** – to do the work of the hand;
  - **Enhance speed** and **force** (printing press, drill, spinning wheel);
  - **Battery** of tools – multiply the work performed by a single motion;
- Next step – simplifying by dividing, **breaking up the task** into a succession of **repeatable processes**;



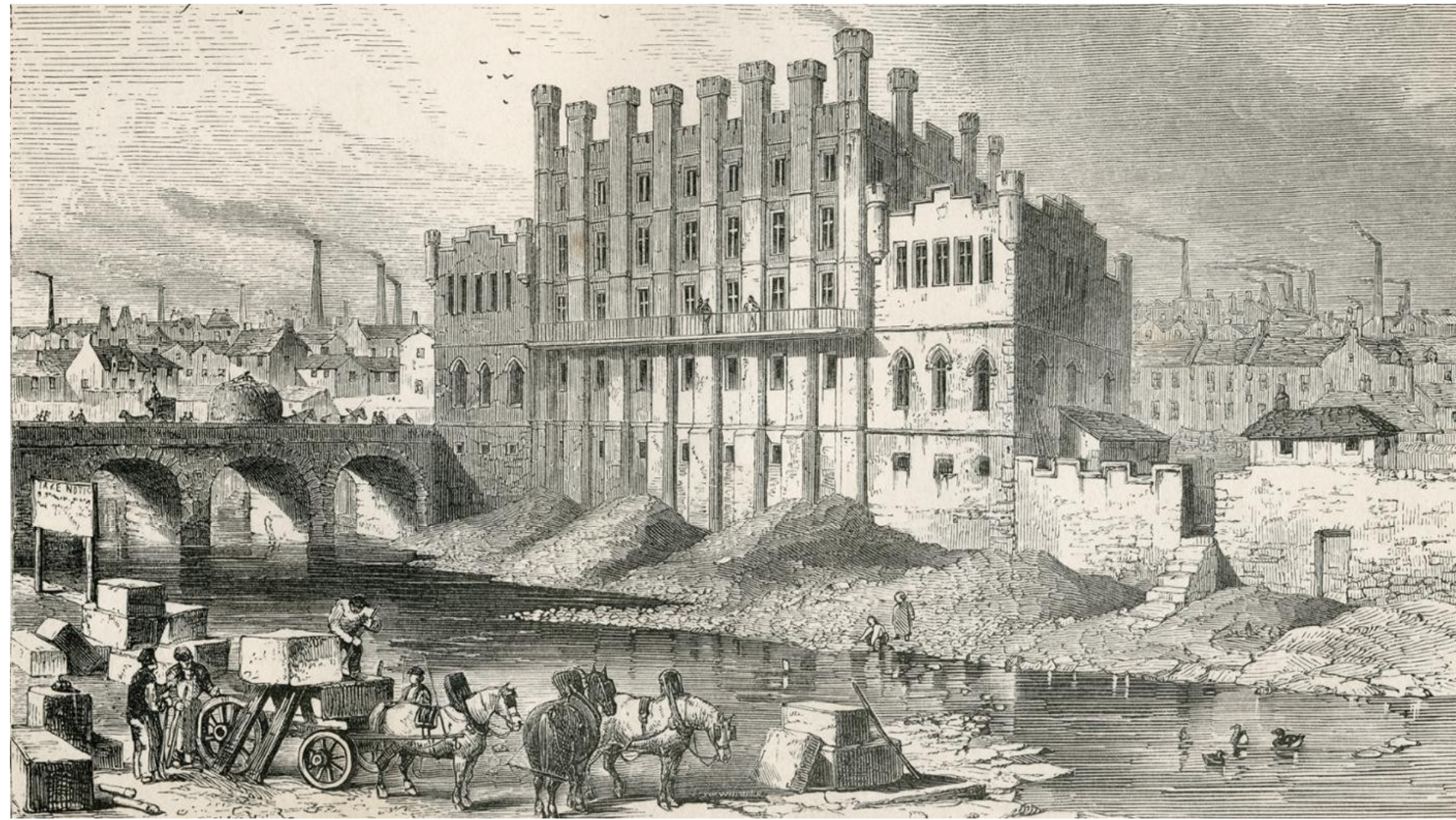

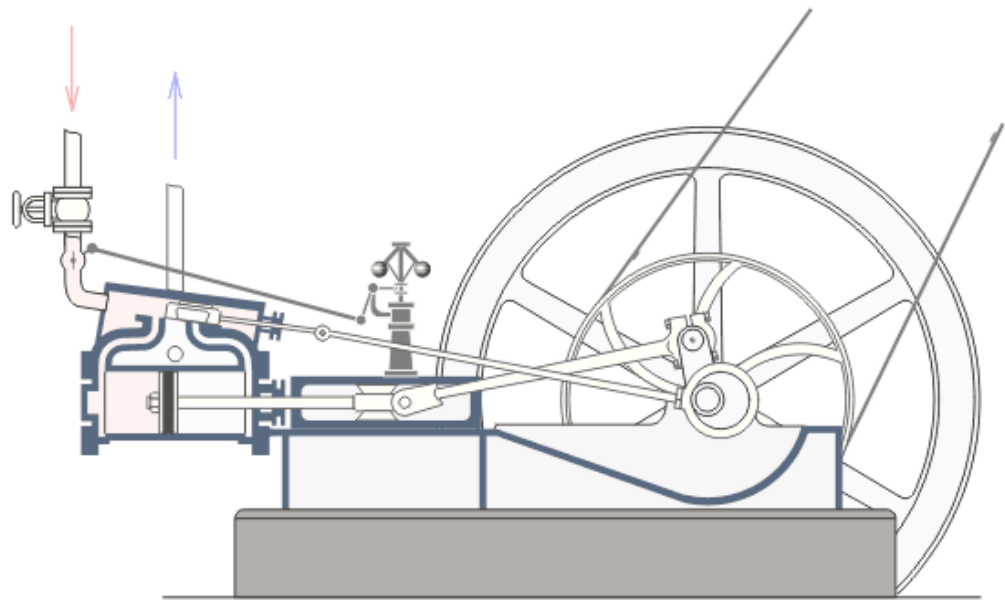
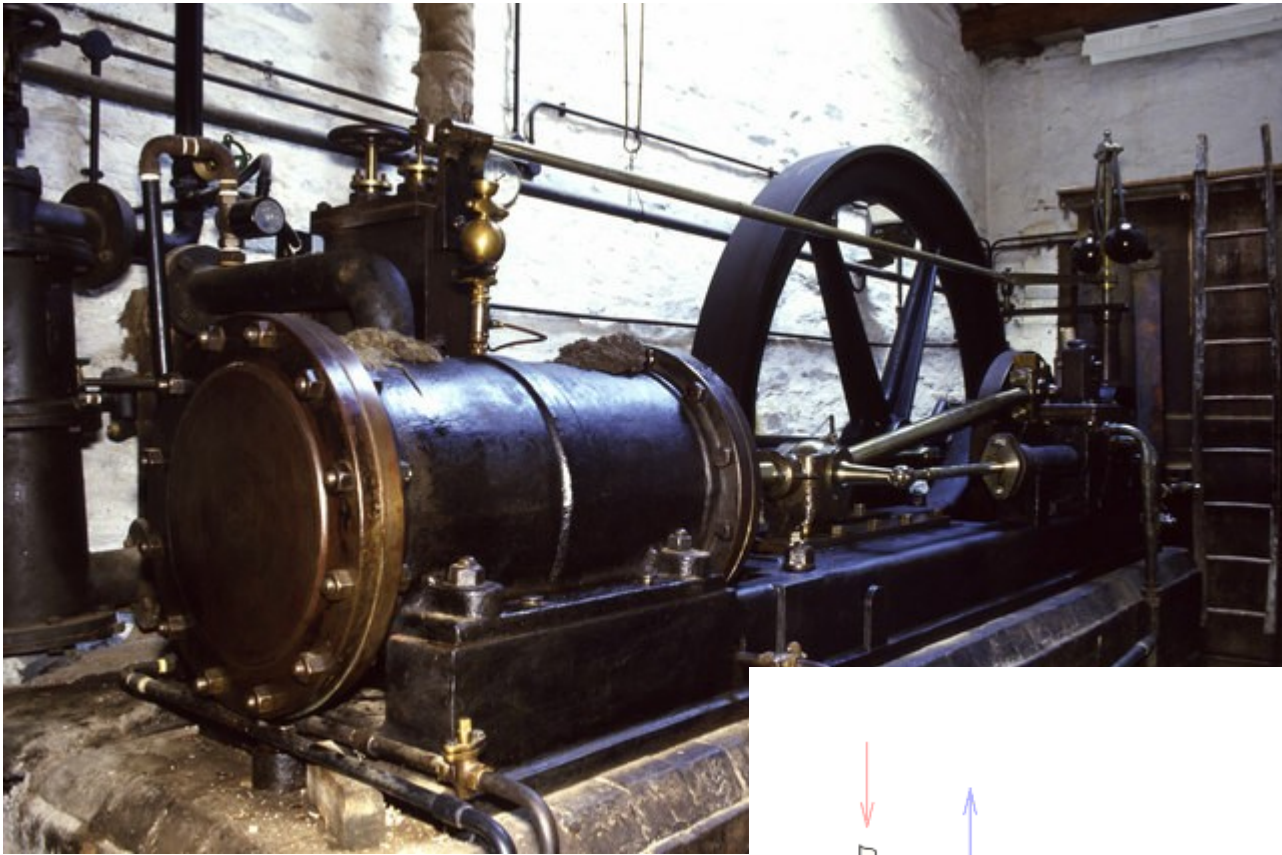

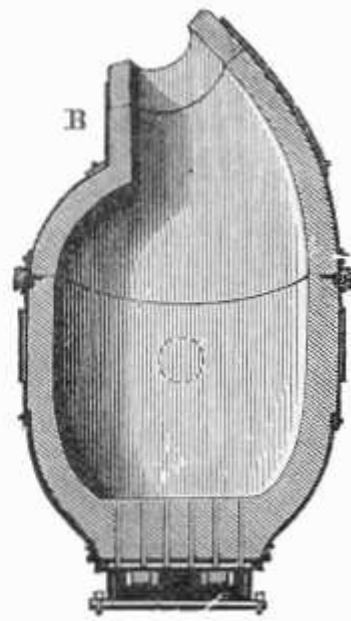
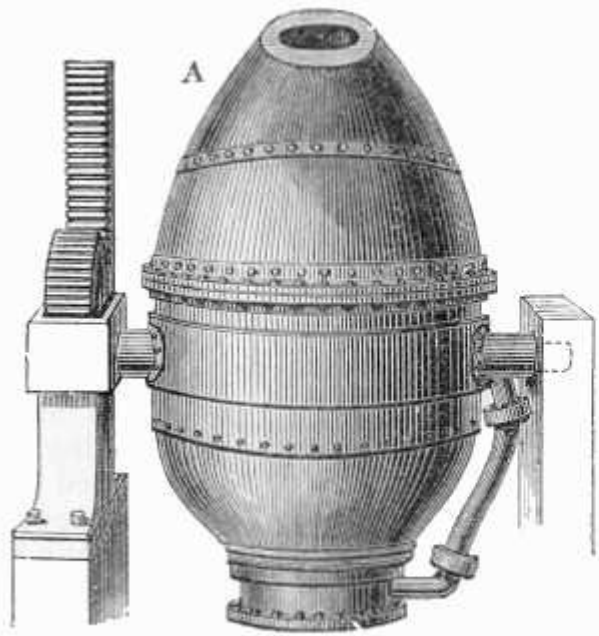

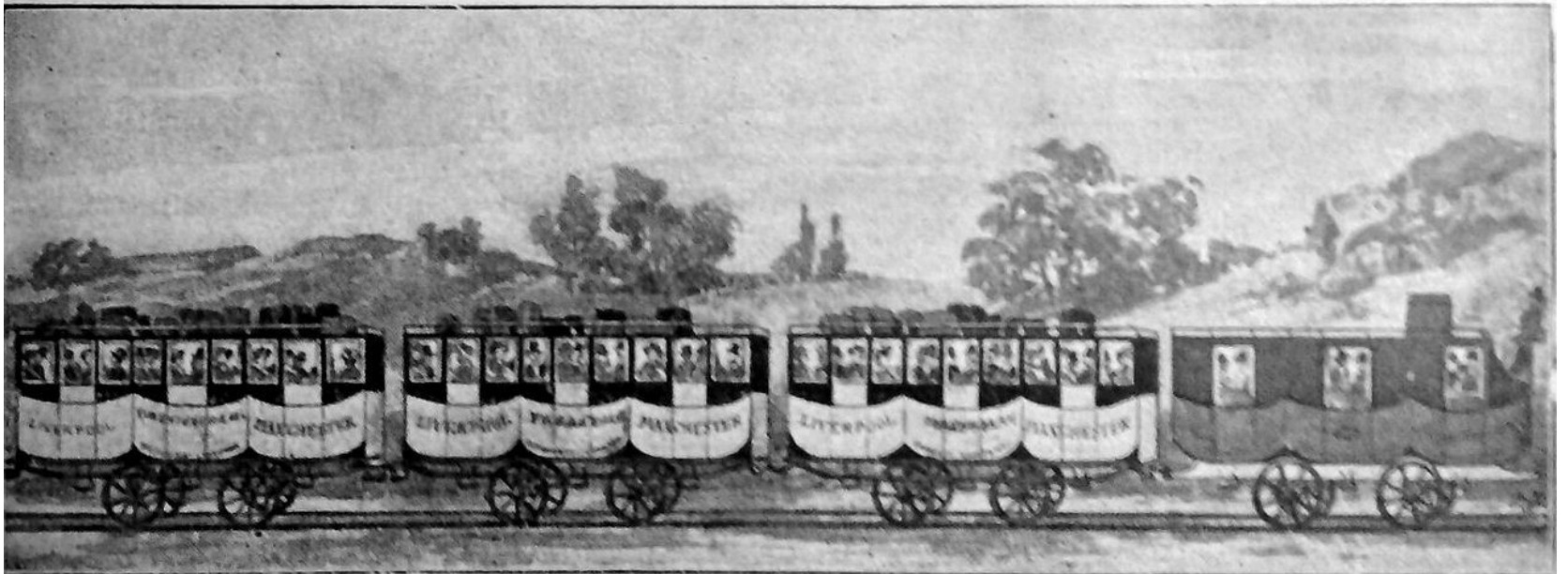
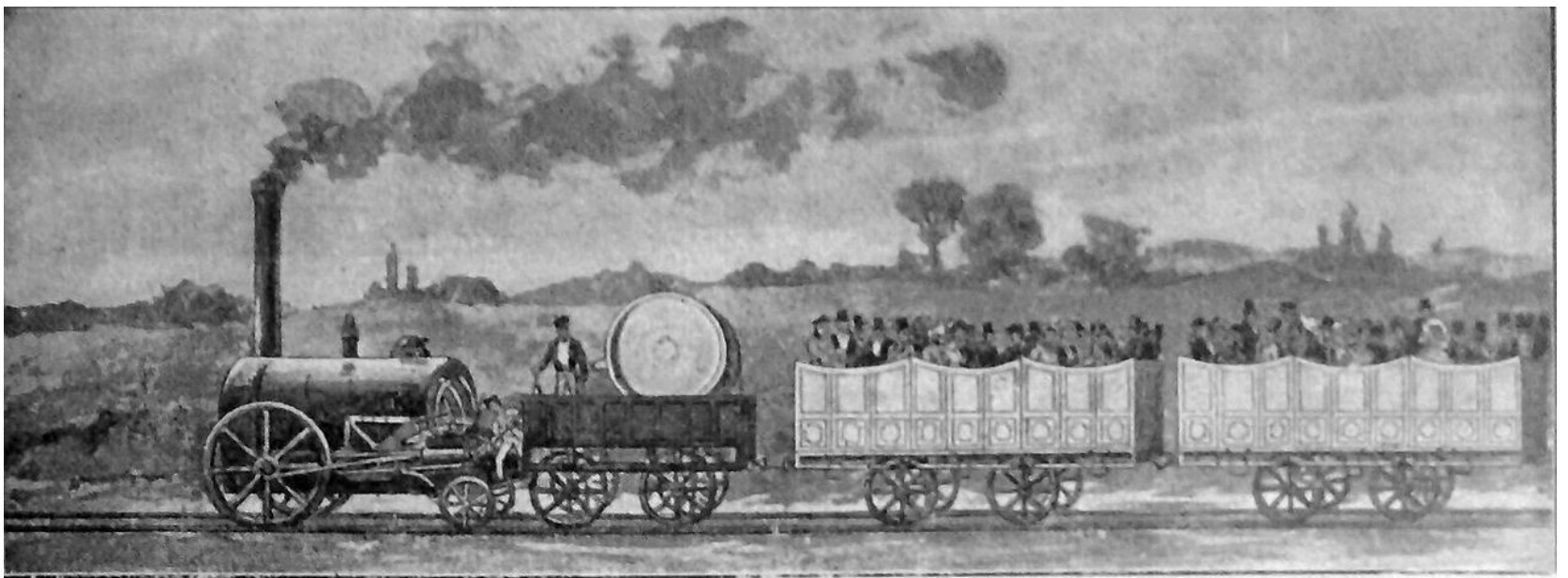

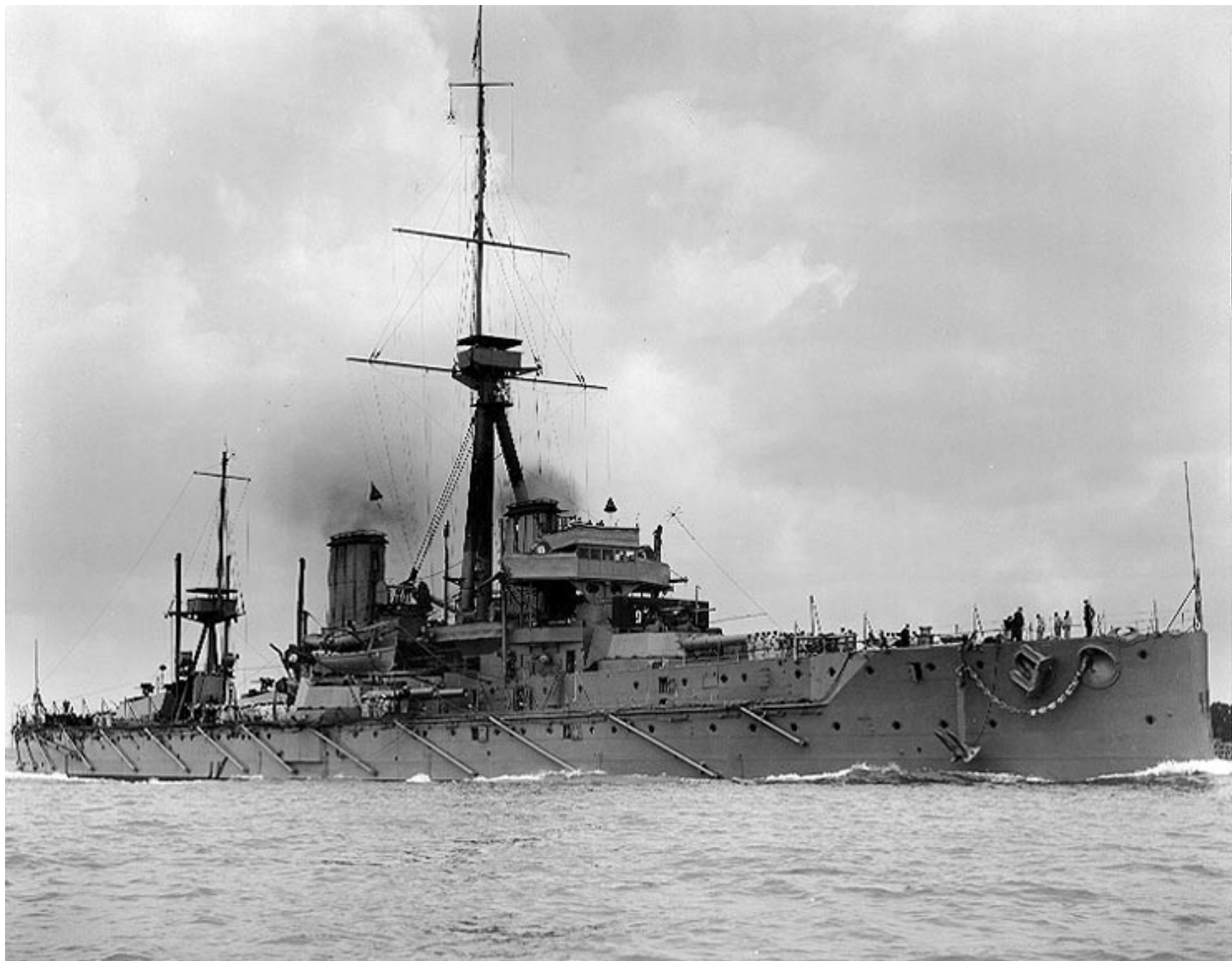

# Great Britain – early being nation

- Purchasing power of the **lower classes** → **ability to buy beyond necessities**
  - great English **middle class** – merchants, shopkeepers, manufacturers, bankers, men of law;
- **Mechanization** → higher **productivity** → higher **wages** → increased **demand** (for manufactures) → **larger market and specialization...**
  - English have **grown rich by consuming** – ran against the folk wisdom – thrift and abstemiousness („habit of French peasants“, *Aldcroft*); (*Calicoes, Corn Laws*);
- Result: **aimed** at a large **national and international market** and **focused** on **standardized** (manu) **goods** of **moderate prices** – the kind that lent themselves to **machine production**;

*Table 1.5 Estimates of the development of GDP per capita at constant prices in six European countries 1500–1820 (UK 1820 = 100)*

	1500	1570	1650	1700	1750	1820
UK	45–49 <sup>a</sup>	45 <sup>a</sup>	54 <sup>a</sup>	68	81	100
Netherlands	60	60	98	97	95	89
Belgium	55	65	63	66	72	74
Italy	75–76 <sup>a</sup>	62–66	71	71	62–66	62
Spain	0	55–61	49–62	50–56 <sup>a</sup>	51–53	61
Poland	51–60	48–56	48–55	40–46	34–37	46
Unweighted average	57–60	55–58	63–67	65–67	66–67	72
Coefficient of variation	0.17 <sup>b</sup>	0.14	0.25	0.25	0.29	0.26

*Notes:*

<sup>a</sup> Intrapolated.

<sup>b</sup> Excluding Spain.

Italy – first estimates date from 1380 and 1450.

*Source:* Van Zanden (1997).

*Table 2.3 British share of some European products (per cent)*

	1800	1830	1870
Pig iron production	29	45	58
Raw cotton consumption	65	66	57
Coal production	85	78	63
Railway mileage open	—	90	24

*Source:* Bairoch (1976a, 129).



*Table 2.4 Regional percentages of total trade 1830–60*

	Europe	North America	Exports to South America	Asia	Africa	Oceania
<b>1830</b>						
from UK	46.7	25.5	11.5	12.8	2.5	1.0
from continent	82.0	6.6	6.3	3.8	1.3	—
<b>1860</b>						
from UK	34.3	16.6	12.0	25.7	3.2	8.2
from continent	82.0	5.8	5.8	3.1	3.2	0.1

*Source:* Bairoch (1976a, 88).

## France – strongest on the continent...

- 1815 **lost sugar colonies** (Caribbean), prosperity of **Atlantic ports undermined**;
- **Markets for cheap machine** produced goods **dominated by GB**;
- Large **peasant class, rooted** to land;
- New industries: **lacked coal; transportation** underdeveloped;
- **Slow to adopt** the **new cost-reducing technology** or expand into new product markets;
- Alternative explanation (*Aldcroft*) - **Different route**;
  - **Less necessary to sell goods abroad** to feed population;
  - **GB preempted overseas markets** for cheap mass production – **France** did well to concentrate on **quality goods** (skills, taste, designs – edge);
  - Much **slower population growth**;
  - Industrial **labor** more **productive** than in **GB**: high-quality production; low productivity **agriculture** kept down overall figures;
- **Quality engineering, construction and architecture, road system** and canal network;
- **Railway building** on large scale since 1840s (1850: 2,5k km, 1870: 17,5 k) – helped develop iron and engineering industries, investment banking skills
- **Outside Europe very minor role** compared to GB;

## Germany

- Soon to grow into leading **industrial** power – until 1870 collection of independent states (**Custom Union**);
- Overseas trade through NED;
- GER territories in terms of **modern industrial sector** overtaking France **1850-1870** (2x coal, iron 1,1; steel 1,8x); large scale **state intervention**;
- **Railway building**: leading sector – outperformed FRA (1851-1869 10-20% of total investment) – creating engineering industry out of nothing;
- Despite expanding mercantile fleet, **foreign trade played a lesser** part (92% exports to Europe);
- Major source of overseas **emigration** from 1840 onwards;

## Belgium

- **Resembled GB most closely**: tradition in **metallurgy** and **textile**, plenty of coal, iron, easy international transport (+ early rail), GB example, neighboring FRA and GER – government inclined to favor business;
- First install **coke smelting**, paper, glass, output coal, iron, machinery...
- Railway network closest to GB level; **export** per head even higher;

# Switzerland

- **No coal**, no iron ore, no access to the sea, surrounded by large protectionist countries;
  - Assets: **skilled** educated **labor force**, some capital accumulations, plenty of **water power**, **trading tradition** (could not feed itself in grain; city belt);
  - **Cotton spindles** (10x 1814-1870), machine building and engineering next;
  - **Conquered** foreign **markets with high quality products** (cotton, embroidered goods, lace, silk, watches);
  - High degree of **division of labor** (decentralized production) - **instead of a factory**;
- Unique – **concentration** on **overseas markets** (**neighbors** unstable and **protectionist**); 1845 **64% went overseas** (**US main** market), only 36% to Europe;
  - **Free trade drive** in **Europe** since **1860** (still 37% extra Europe);
  - Per head export greatly exceeded GB, BEL;

# United States

- Starting as a **colonial** type **economy** -> expanding **primary exports** at a fast rate -> **1870** major **industrial power** (inward oriented);
- **1870** – still essentially **agrarian state**, but shrinking employment and output - > **manufacturing**;
- **Leading industry: Cotton textile** (value added 16k USD in 1805 -> 930k in 1820 -> 48,4mil in 1860), coal, iron mining;
  - Using **GB technology** first – **innovations**, different form of **factory organization**;
- US technology leading in wood-working machinery, high-pressure steam engines,
  - **American system of manufacture** – the **mass production** of **composite articles** using **interchangeable** parts;
- By 1870 US 23% of world industrial output (despite civil war);
- Rich in **land** and other NR as well as in **capital** – but **short of labor**:
  - Tend to **go for innovations** - saving labor, **capital** (physical, human) intensive economy;
- **Europe (FT window)** main market for US **primary product exports**, creating **ELG** in critical period.



**A VIEW** of the **BOMBARDMENT** of Fort M<sup>c</sup>Henry, near Baltimore, by the British fleet taken from the Observatory, under the Command of Admirals Cochrane & Cockburn on the morning of the 13<sup>th</sup> Sep<sup>r</sup> 1814 which lasted 24 hours, & thrown from 1500 to 1600 shells in the Night attempted to land by forcing a passage up the ferry branch but were repulsed with great loss.

- (References)*
- A. Fort M<sup>c</sup>Henry
  - B. Linnæus
  - C. Admirals fleet
  - D. British ship "Oriskany"
  - E. Ferry and fort.

**Table 2–24. Structure of Employment in the Netherlands, the United Kingdom and the United States, 1700–1998**  
(per cent of total employment)

		<i>Netherlands</i>	<i>United Kingdom</i>	<i>United States</i>
1700	Agriculture	40	56	n.a.
	Industry	33	22	n.a.
	Services	27	22	n.a.
1820	Agriculture	43 <sup>a</sup>	37	70
	Industry	26 <sup>a</sup>	33	15
	Services	31 <sup>a</sup>	30	15
1890	Agriculture	36 <sup>b</sup>	16	38
	Industry	32 <sup>b</sup>	43	24
	Services	32 <sup>b</sup>	41	38
1998	Agriculture	3	2	3
	Industry	22	26	23
	Services	75	72	74

a) 1807; b) 1889

**Source:** Maddison (1991a), p. 32 for 1700; Maddison (1995a), p. 253 for the United Kingdom and the United States 1820–90; Netherlands 1807 and 1889 from Smits, Horlings and van Zanden (2000), p. 19; 1998 from OECD, *Labour Force Statistics 1978–1998*. Agriculture includes forestry and fishing; industry includes mining, manufacturing, electricity, gas, water and construction; services is a residual including all other activity, private and governmental (including military).