



Regional currencies

Schumacher College,
Dipl.-Kfm. Ralf Becker

www.regiogeld.de
[ralf.becker\(at\)regiogeld.de](mailto:ralf.becker(at)regiogeld.de)



Overview

1. Money and Sustainability
2. Complementary currencies
3. Instruments of interest reduction
4. Regional currencies

The Club-of-Rome-Report



Our Future Economy:
Money and Sustainability
– The Missing Link

Club-of-Rome-Bericht 2009

Our Future Economy:

Money and Sustainability – the Missing Link

CHAPTER 1: SUSTAINABILITY AND MONEY SYSTEMS

CHAPTER 2: SCENARIOS AND PERSPECTIVES

CHAPTER 3: IS OUR CURRENT MONETARY SYSTEM SUSTAINABLE?

CHAPTER 4: COMPLEMENTARY CURRENCY INNOVATIONS

Rethinking Money

Complementarity and Money

The Terra: A Trade Reference Currency

Social Complementary Currencies

CHAPTER 5: MONETARY REFORM OPTIONS

CHAPTER 6: A TIME FOR ACTION

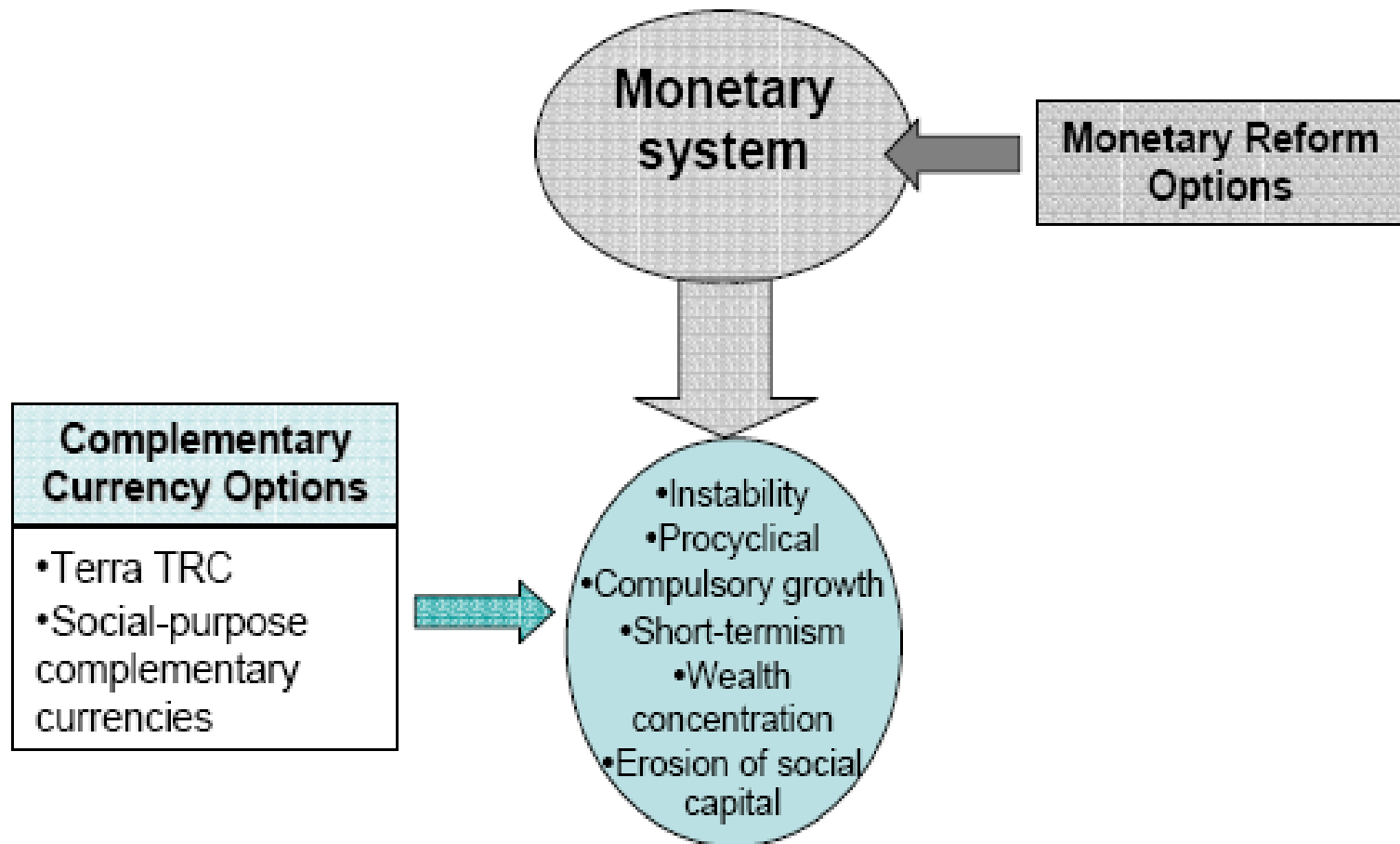

Figure 4.1 Comparative Role of Complementary Currency Options vs. Monetary Reform Options.

Money and Sustainability

Stefan Brunnhuber | Harald Klimenta



REDLINE WIRTSCHAFT
bei unbarbarer

Wie wir wirtschaften werden

Szenarien und Gestaltungsmöglichkeiten
für zukunftsfähige Finanzmärkte



Europäische Akademie der
Wissenschaften und Künste

Five effects of
money on
sustainability

- Growing instability
- Compulsory growth-pressure
- Short-term orientation
- Unrelenting concentration of wealth
- Devaluation of social capital

Growing instability

Hypo Real Estate GROUP



Growing instability

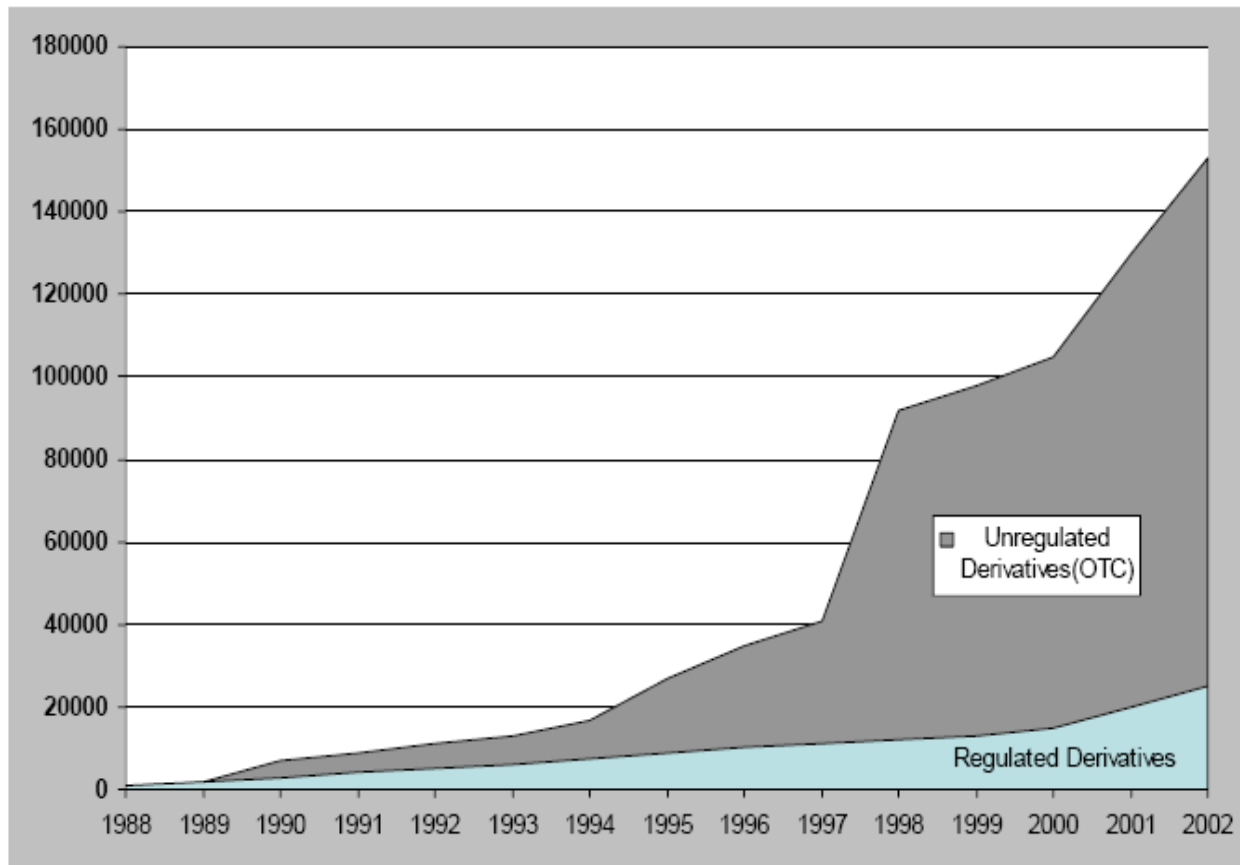
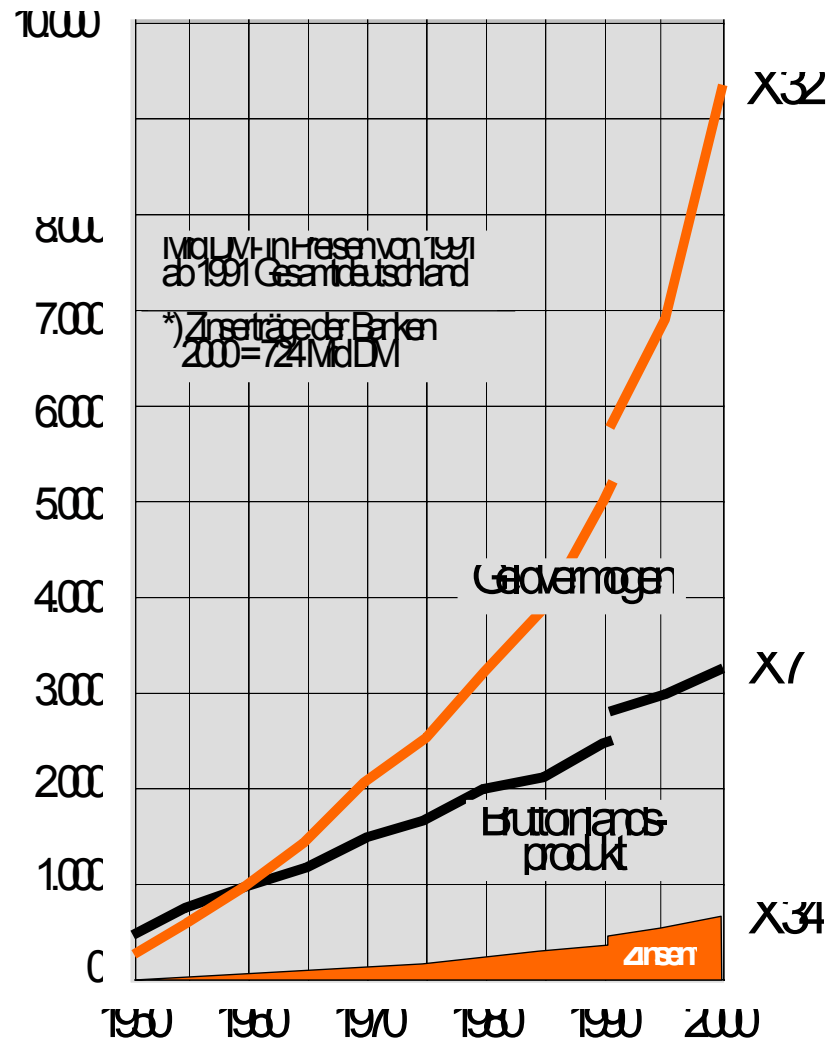

Figure 1.3 Volume of derivatives (open positions at year end), in billions of US\$ 1988-2002

Inflation of assets



Money assets

GDP

Compulsary growth pressure

Compound interest

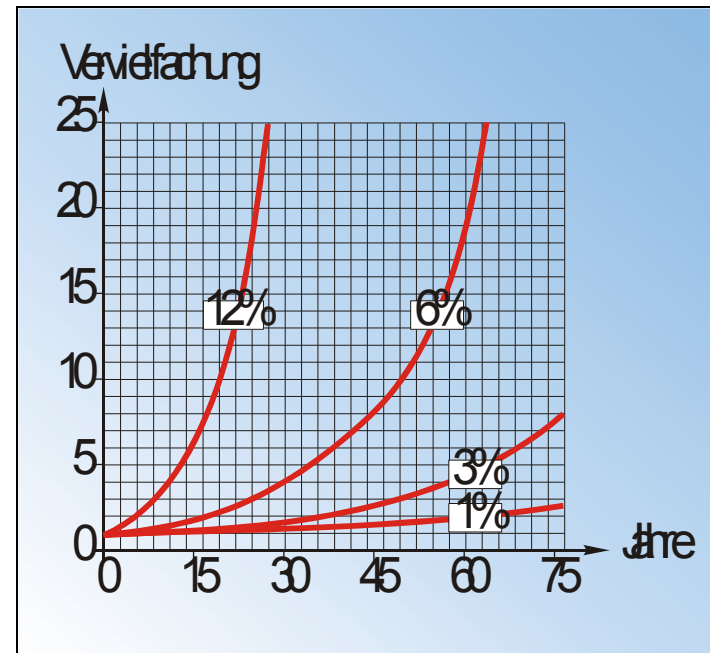
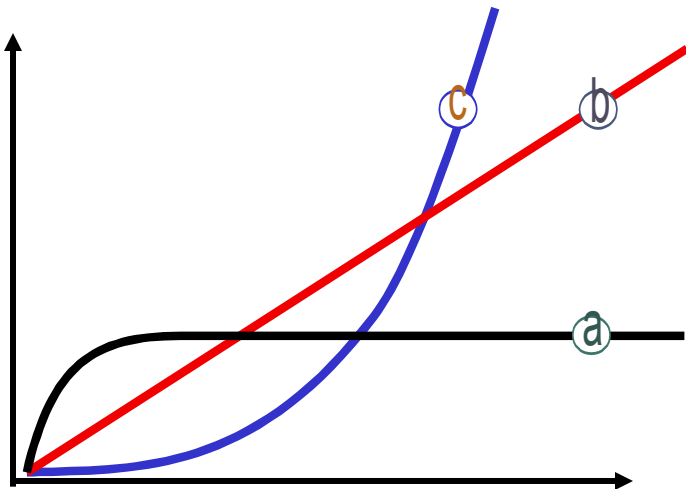

Growth of interest and GDP

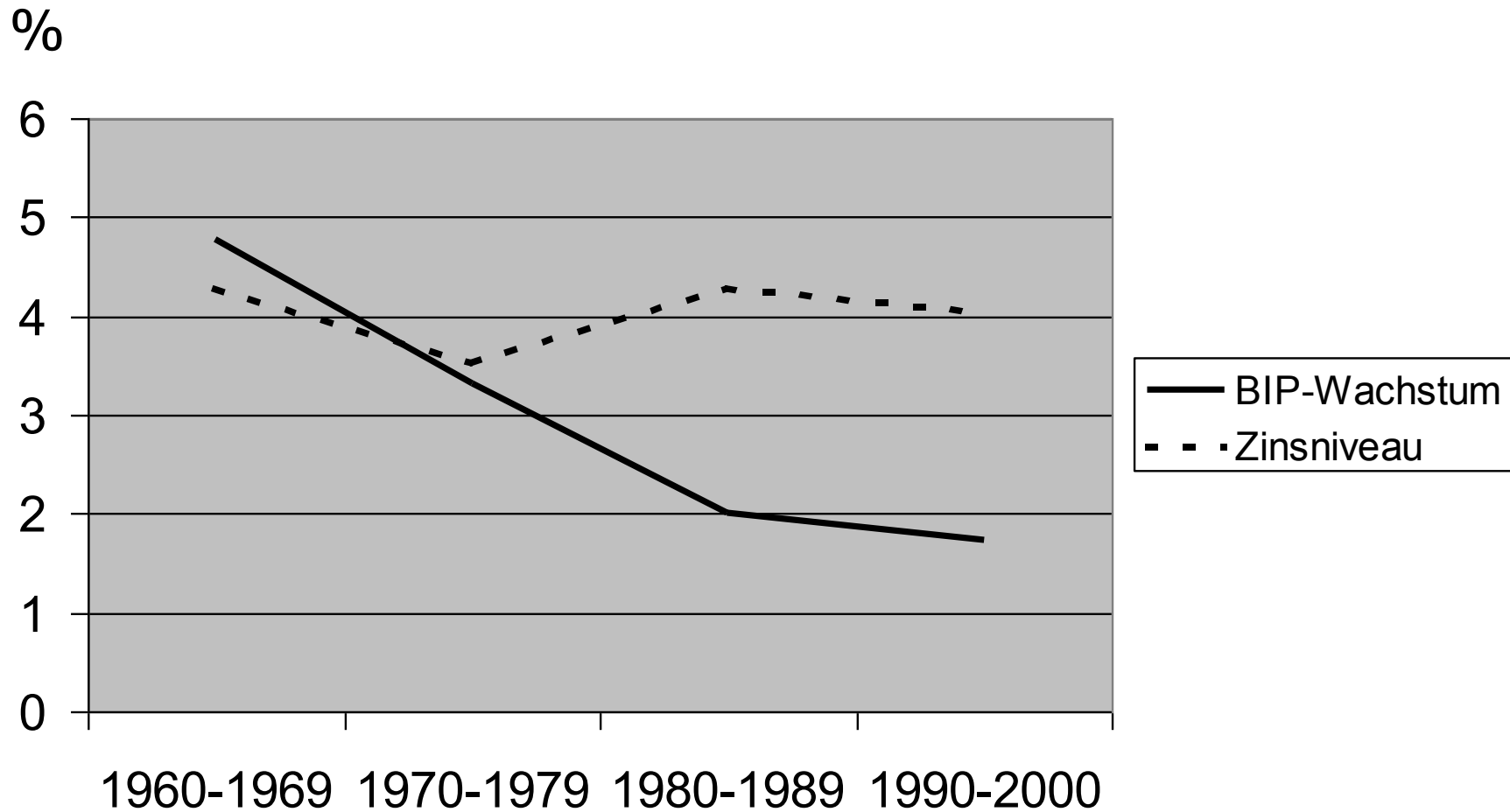

Compulsatory growth pressure

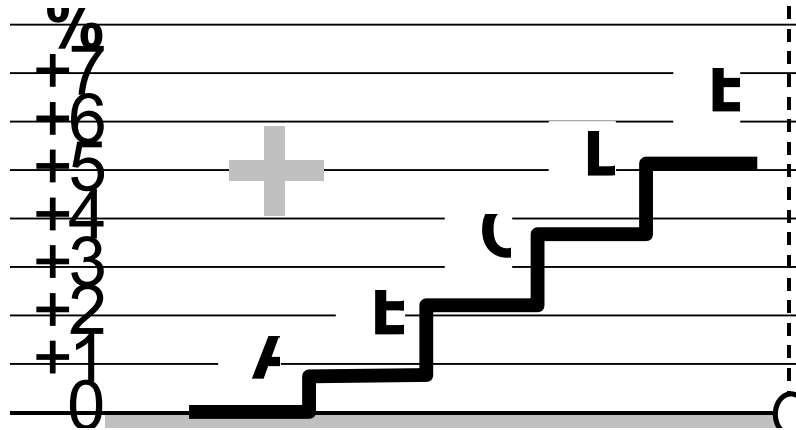

- Banks receive only giro transfer money without positive interest for long-time deposits.

A=Bargeld / B=Sichtguthaben / C=kurzfristige, D=mittelfristige, E=langfristige Einlagen

Short-term orientation

Where should I invest?



Interest rate

• 3 %

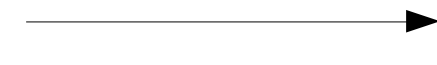

100€



4,37€



• 5 %

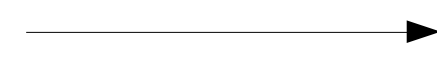

56€



0,10€



Privatvermögen in Deutschland – Stand 1993

Verteilung auf die Haushalte in Tsd. DM

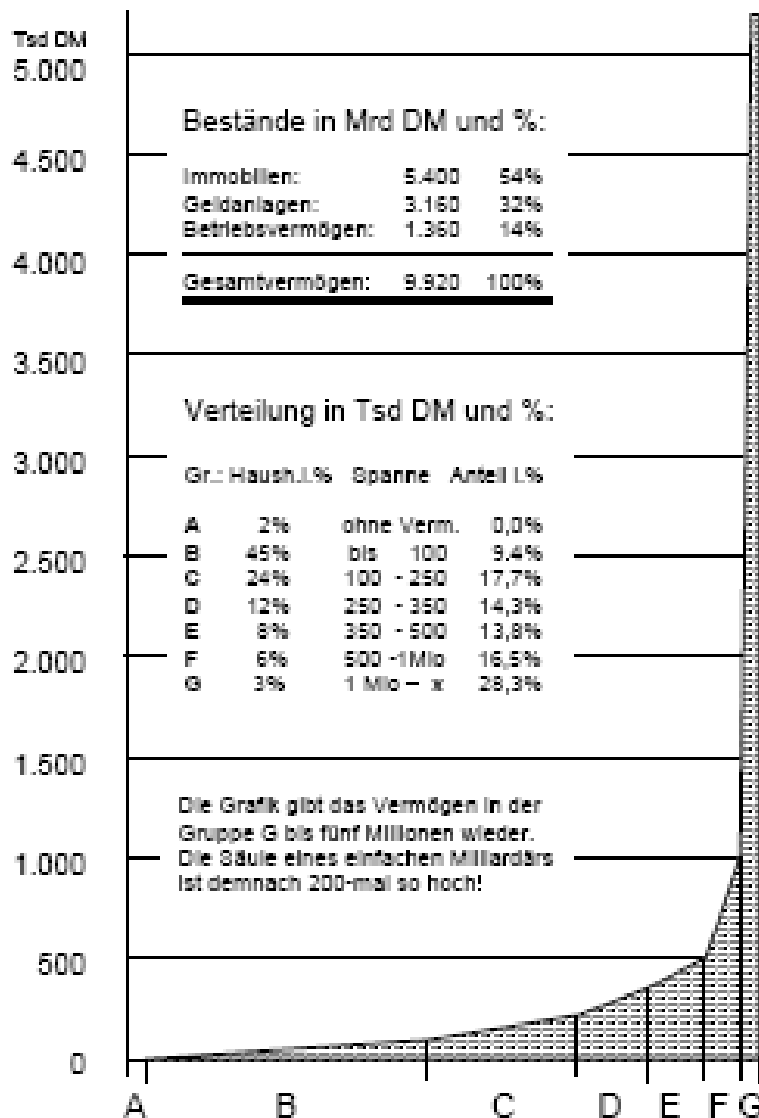

Concentration
of wealth

Interest as wealth distributor

Percent of interest
in the rent

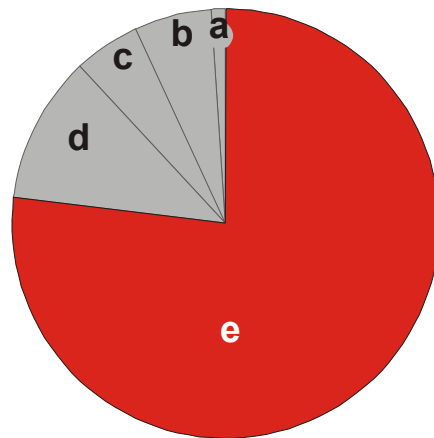

77 %

Interest payed and gained

Zinslasten und Zinserträge nach Haushaltsdezilen in Deutschland 2001

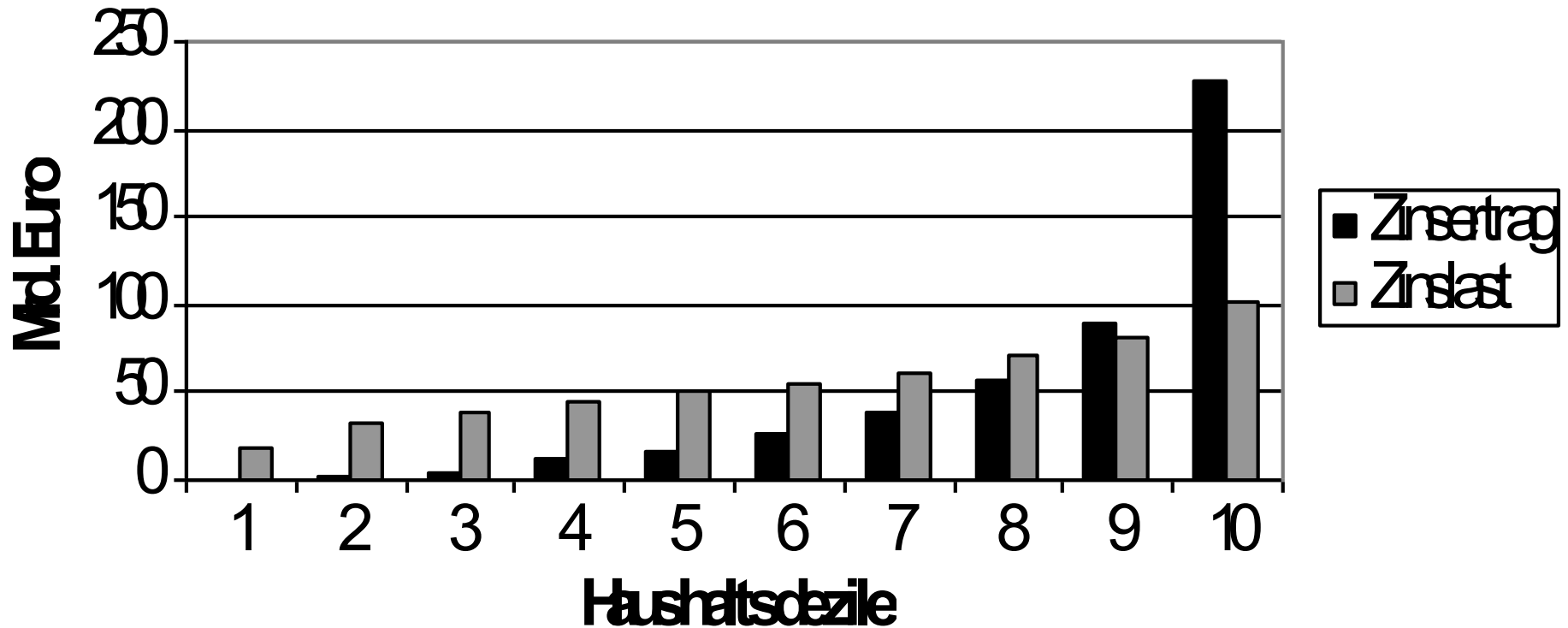

Overview

1. Money and Sustainability

2. Complementary currencies

3. Instruments of interest reduction

4. Regional currencies

Complementary currencies

- ✓ are supplied and accepted as a medium of exchange additional to the legal currency
- ✓ are instruments to serve regions (geographically limited) or sectors (theme-limited) socially and economically by spending additional liquidity
- ✓ are normally interest-free or enable a reduction of interest levels to zero

Complementary currencies

✓ Argentina: The mutual currency Credito was used by over 6.5 million people during the crash of the legal currency in 2002

✓ Miles and More, bonuscard- and citycard-systems

✓ Sectoral currencies: Saber,
Furreai Kippu, Health-Coin-Community

✓ Time banks, senior cooperatives and regional currency initiatives

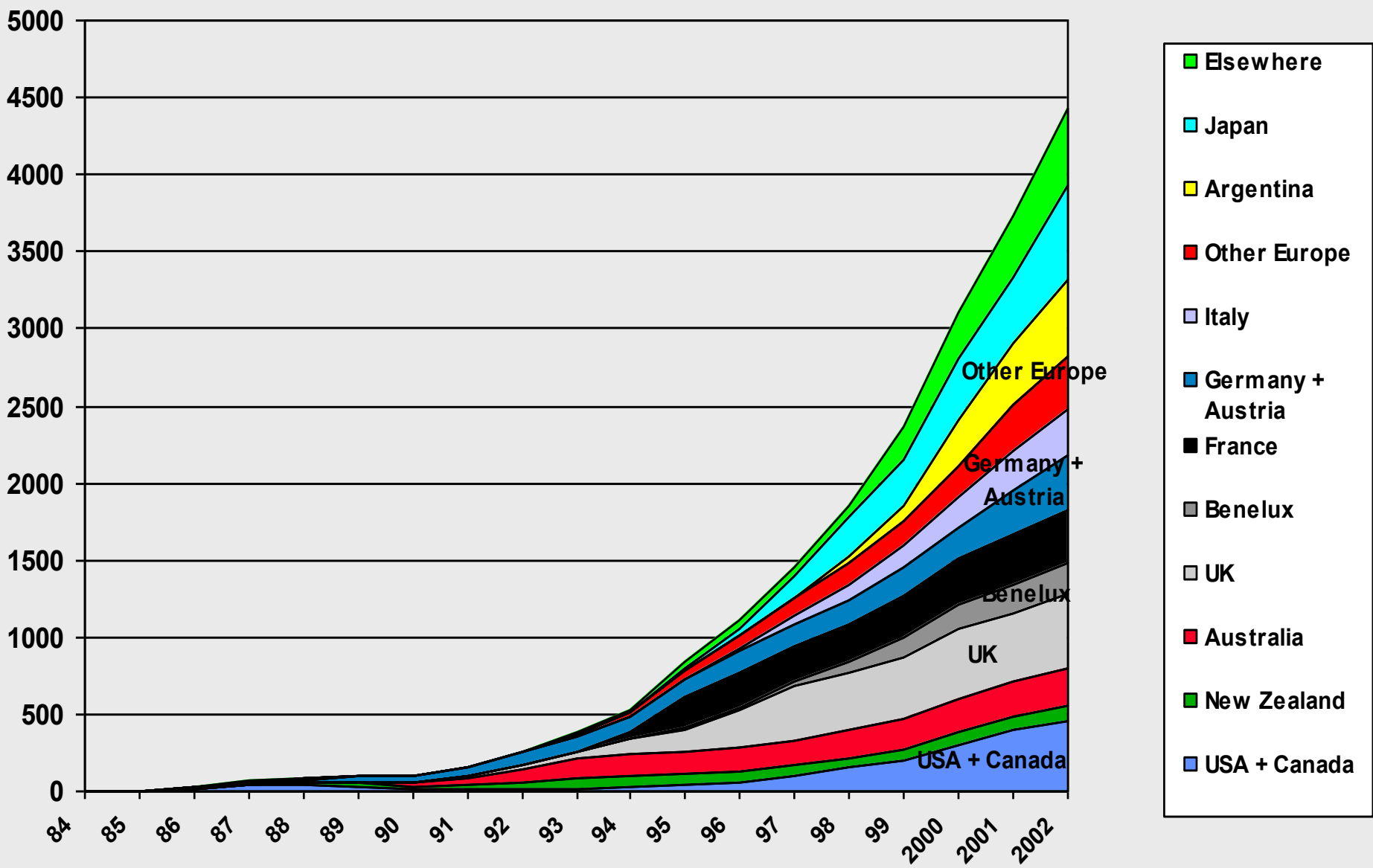

- Elsewhere
- Japan
- Argentina
- Other Europe
- Italy
- Germany + Austria
- France
- Benelux
- UK
- Australia
- New Zealand
- USA + Canada



Switzerland

started
1934



60.000 SMB

Bartering with own currency
WIR-Franken (CHW)
without interest

loans in WIR-Franken + Euro



Regional currencies in German-speaking area

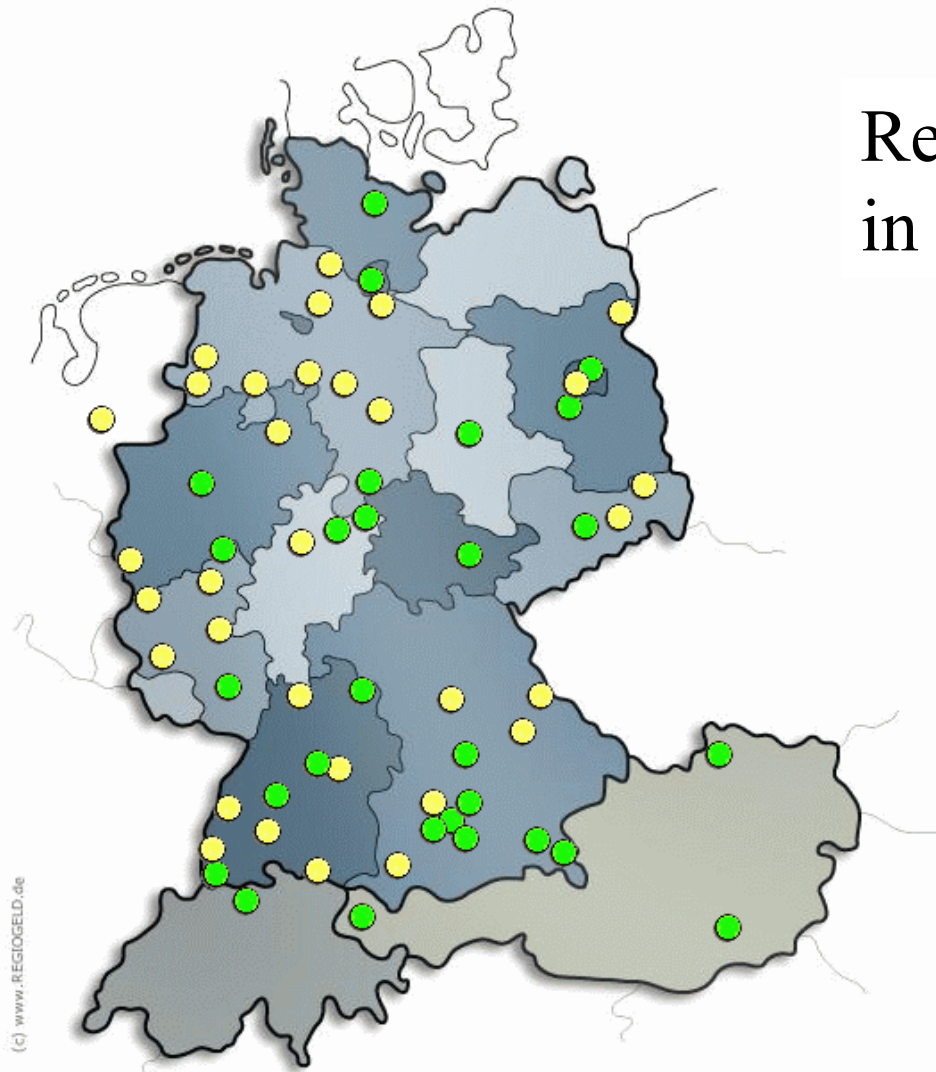

- Regio im Umlauf
- Regio in Vorbereitung

(c) www.REGIOGELD.de

● in Vorbereitung (32)
● aktiv (28)

Overview

1. Money and Sustainability
2. Complementary currencies
3. Instruments of interest reduction
4. Regional currencies

Instruments of interest-reduction

- ✓ Time banks are serving all participants interest-free loans just from the beginning
- ✓ Regional currencies work like bigger time banks or introduce a carry tax enabling a market-conform reduction of long-time-deposit-interests to zero
- ✓ Sectoral currencies are working like time banks and regional currencies

A further reduction of the interest level is enabled by introducing a carry tax

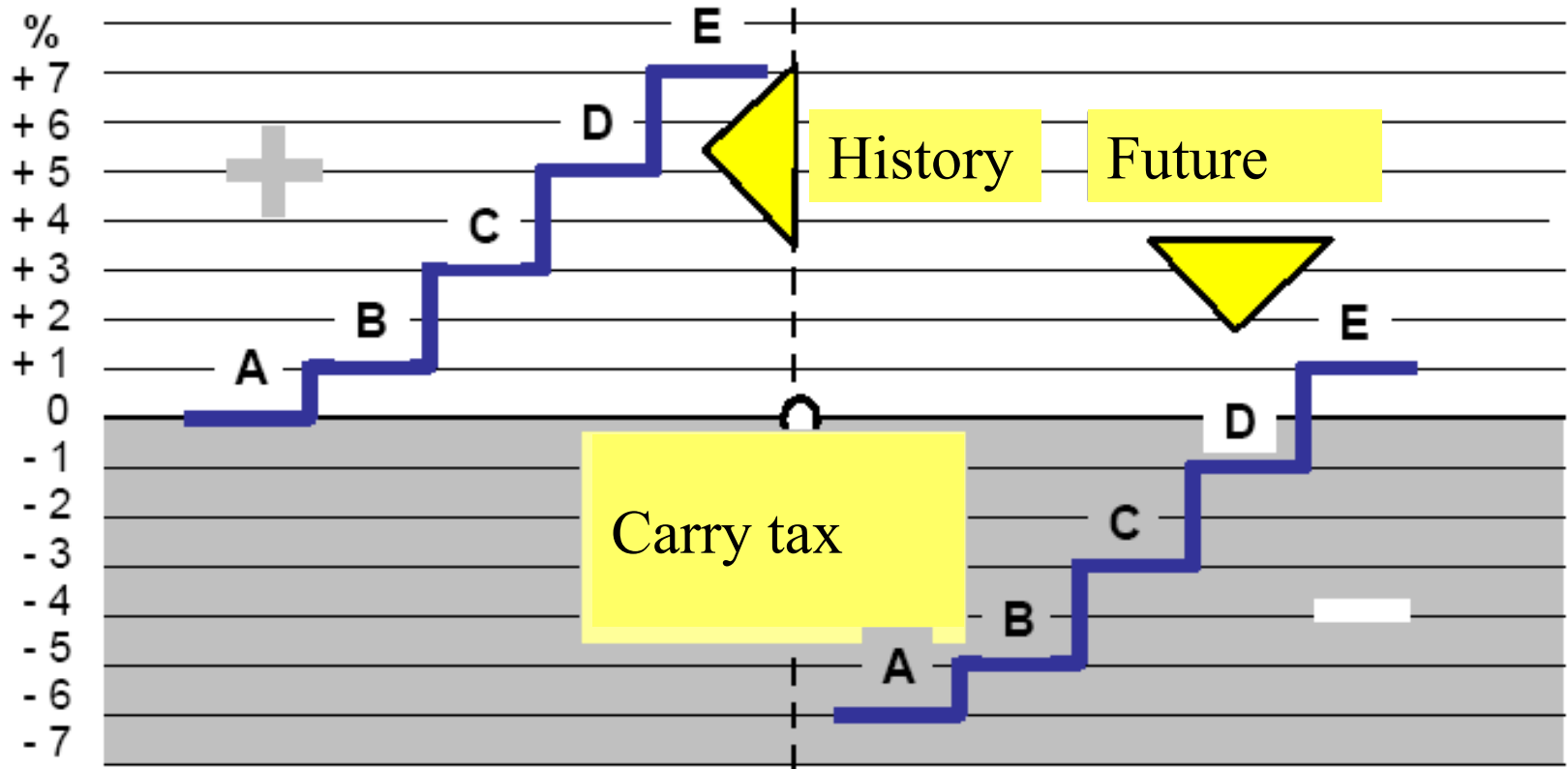

Overview

1. Money and Sustainability
2. Complementary currencies
3. Instruments of interest reduction
4. Regional currencies

Regiogeld

*Regional
circle of economy*

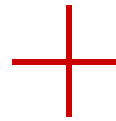



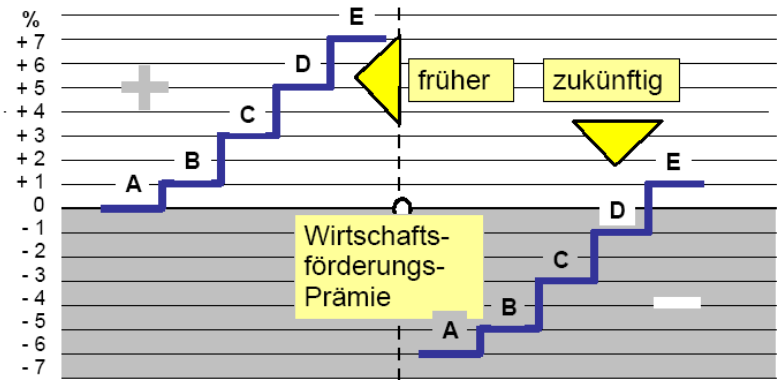
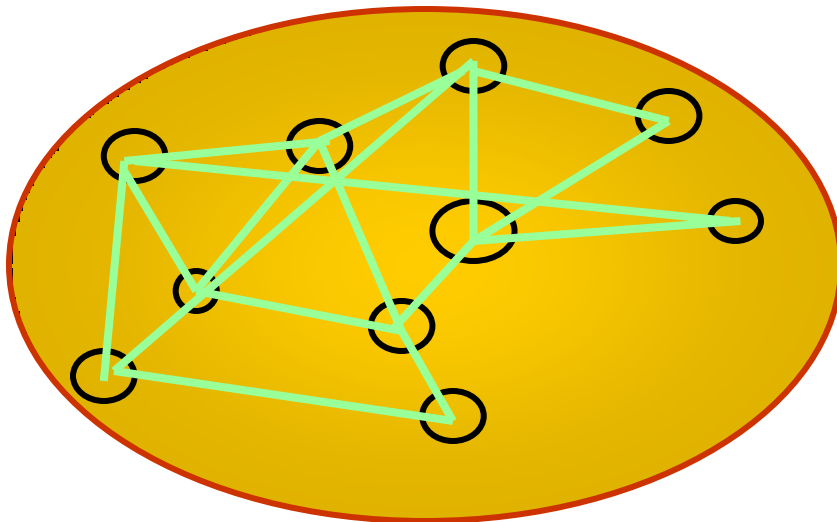

*Reduction
of interest*



Regiogeld in Deutschland - 3

Verschiedenen Systemvarianten von Regiogeldern

Systemvarianten

-  eurogedecktes System
-  leistungsgedecktes System
-  parallel 2 Medien mit verschiedener Deckung
-  zunächst eurogedeckt, später leistungsgedeckte Variante
-  zeitweise anteilige Leistungsdeckung

Regiogeldsysteme mit Eurodeckung:

Das Geld gelangt in Umlauf durch den Kauf gegen Euro. Der Eurobetrag liegt als Deckung auf einem Vereins- oder Genossenschaftseigenen Bankkonto. In der Regel ist in diesem System die Möglichkeit für Unternehmer gegeben (unter Abzug einer Rücktauschgebühr, auch Regionalbeitrag genannt) Regio auch wieder in Euro zurückzutauschen.

Regiogeldsystem mit Leistungsdeckung:

Man könnte auch von einer Kreditdeckung reden. Anstelle eines Eurorücklagenkontos werden die umlaufenden Scheine hier durch Leistungsversprechen der Teilnehmer gedeckt. Die teilnehmenden Unternehmen erhalten ein ihrer Leistungsfähigkeit angemessenes Kontingent zur freien Verfügung und verpflichten sich im Gegenzug es mindestens in gleichem Umfang als Zahlungsmittel zu akzeptieren. Ein Rücktausch in Euro ist in diesen Systemen nicht möglich.

Systeme mit gemischter Deckung:

Elemente beider voran genannten Varianten werden kombiniert. Entweder indem eine Initiativen mehrere Medien (Gutscheine oder Schecks) verwendet, oder auch, indem beim Umtausch (eigentlich Euro in Regio) ein gewisser "Leistungsanteil" (beispielsweise in Form von Talenten, der Zeitwährung von Tauschringen) erlaubt ist.

 Postleitzahlgebiete mit Regiogeld-Akzeptanzstellen

 Staats- und Ländergrenzen

Urstromtaler Name einer Initiative

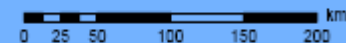
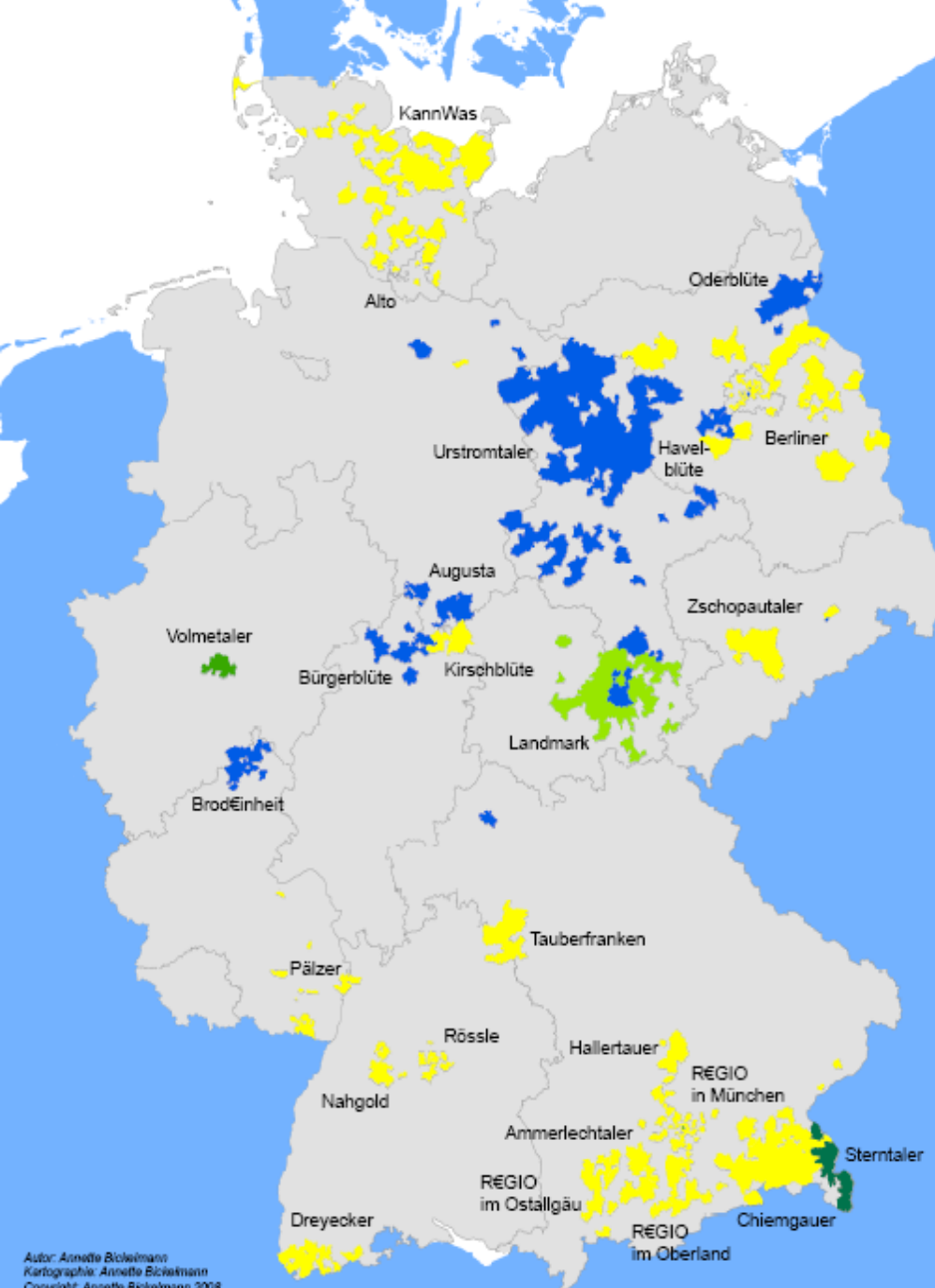

Support of sustainability



✓ Increased use of regional products and services
– you can force the next to buy regionally, too

✓ Network-building leads to regional identification

✓ Added value and surpluses remain in the region

✓ Community-building

Support of sustainability



- ✓ Support of small and medium-sized companies (75 % of working and apprenticeship places)
- ✓ Reducing need for transport and energy
- ✓ Closer links between producer and consumer
- ✓ Increase of regional created value



Prien

CHIEMGAUER REGIONAL e.V.
für nachhaltiges Wirtschaften



2000 members
637 shops

official regional
Local agenda project

started
2003

- + Raiffeisenbank
- + savings bank
- + parliament of donors



Sterntaler -
Berchtesgaden

started
2004

600 members
170 shops

Time bank +
Sterntaler-regional currency + Euro

Entrepreneurs opinion

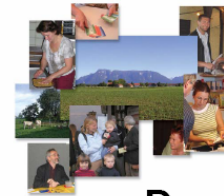

STAR-Partner
Befragung
Januar – März 2006

Der Sterntaler –
ein Plus für die
regionale Wirtschaft!

Franz Galler, 1. Vorsitzender, STAR e.V.
im Vorstand Regiogeld e.V.



Initiative
Sterntaler *aus der Region
für die Region*



133 of 151
entrepreneurs
interviewed:

Entrepreneurs opinion

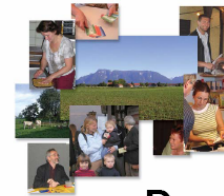

STAR-Partner
Befragung
Januar – März 2006

Der Sterntaler –
ein Plus für die
regionale Wirtschaft!



The regional currency

- brought me new customers (72 %)
- is a fantastic instrument to bind customers (68%)
- strenghtens my position in the globalized market (60 %)
- is a surplus for the regional economy (96 %)

Rules



- ✓ Supply-backed: starter kit 1000 x
employees x quote of acceptance x factor
- ✓ 5 % or 10 % plus when bought with Euro
- ✓ No re-barter

- Regio-cash
- Regiocard for exchange
- Regiocard for payment
- Regio transfer accounts
- Regio saving accounts
- Regio loans/investments
- Regio foundations



Quality standards of the Regiogeld-association

- ✓ Public-interest-orientated
- ✓ Creating regional circles of economy
- ✓ Sustainability-compatible
- ✓ Transparent for all users
- ✓ Democratic organization

Further information

www.regiogeld.de
www.margritkennedy.de

