

Foundations *for* Sustainability

Foundations *for* Sustainability

A Coherent Framework of Life–Environment Relations

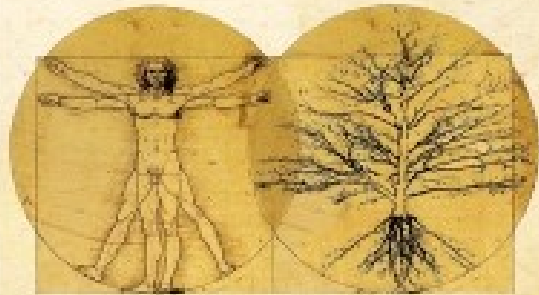

Daniel A. Fiscus, Brian D. Fath



Brian D. Fath & Dan Fiscus

Fulbright Distinguished Chair, Masaryk University, Brno, Czech Republic

Professor, Towson University, Maryland, USA

Senior Research Scholar, International Institute for Applied Systems Analysis,
Austria

Chapter 3: Holistic science of Life–Environment

Your reaction

- 1) What is meant by conbiotic?
- 2) Which of the win-win examples do you think is most convincing? Why?
- 3) What part was most confusing or most difficult to understand?

a new paradigm

Environmental concerns have become of paramount importance.

Certain global problems may soon be *irreversible* (e.g., deforestation, extinction, soil loss, climate change).

These are *systemic problems* that cannot be understood in isolation but rather are interconnected and interdependent.

Solutions may be simple but will require a radical shift in our perceptions, our thinking, and our values.

Humans unwittingly express
and incorporate their
paradigmatic priorities – their
societal organizing principles –
in their surroundings



Medieval cities dominated by churches

19th and early 20 century cities dominated by governance



21st century cities dominated by business



A new paradigm that includes ecological principles and livability?



Dominant paradigms in science

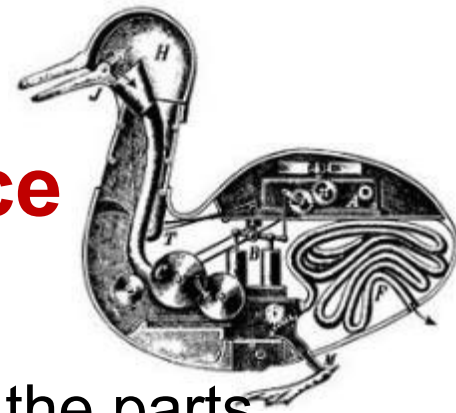

Reductionism (analysis) taking apart to see the parts

- domains - atmosphere, lithosphere, hydrosphere, biosphere
- disciplines - ecology, economics, politics, sociology, etc.

Holism (synthesis) - putting the pieces back together again

Aside on holism/reductionism

Gödel, Escher, Bach

Douglas Hofstadter

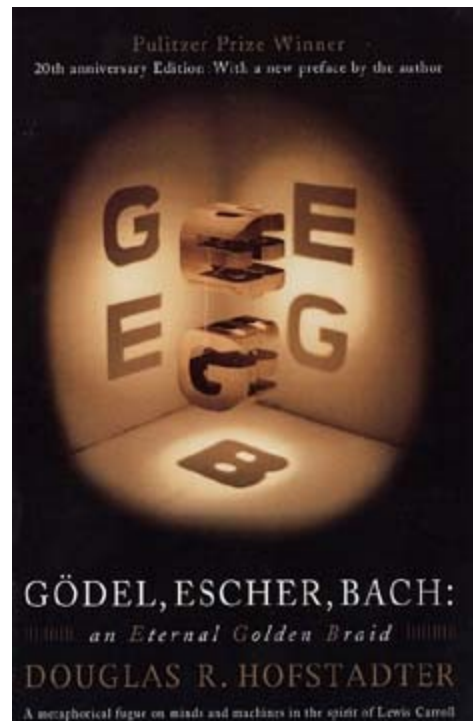

mechanism and reductionism

Cartesian mechanism – study of phenomena that could be measured and quantified

Analytic thinking – breaking up complex phenomena into pieces to understand the behavior of the whole from the properties of the parts.

VERY SUCCESSFUL APPROACH!!

...but

Fragmentation

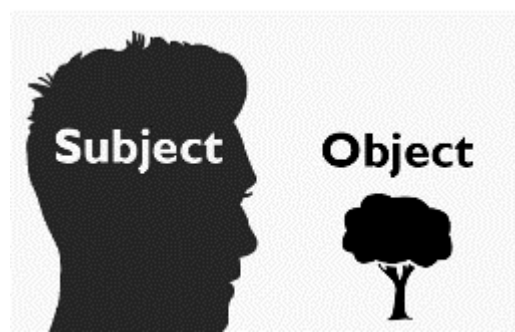

“A minor problem, perhaps, is the tendency of materialism to objectify the world, dividing it from the ‘objective observer’ who studies it. The world thus becomes ‘the environment,’ . . . which means ‘surroundings,’ *a place that one is in but not of*. The question raised by this objectifying procedure and its vocabulary is whether the problems of conservation can be accurately defined by an objective observer who observes at an intellectual remove, forgetting that he eats, drinks, and breathes the so-called environment.”

Berry (2001, pp. 25-26)

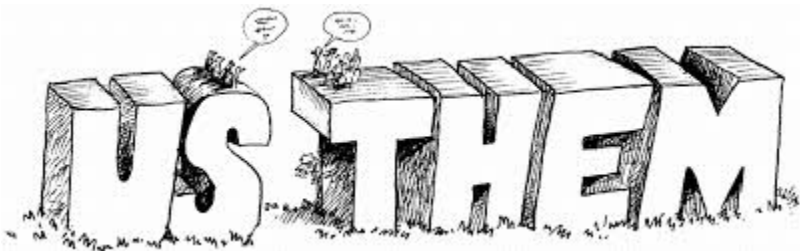

In 1920s (biology, gestalt psychology, quantum physics)

Holism

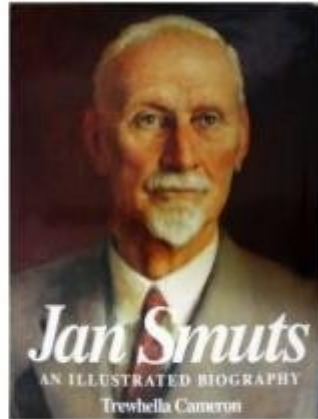

"The tendency in nature to form wholes that are greater than the sum of the parts through creative evolution"

- Jan Smuts, *Holism and Evolution*, 1926



Premature, no tools to formulate and investigate wholeness – Systems analysis and networks

New norm? – lesson from holism

- Fundamental, net human–environment relation is mutualistic or win-win
- A scientific theory is declared invalid only if an alternative candidate is available to take its place



Part of that change is recognition that environment is foundation for all aspects, others are subsets

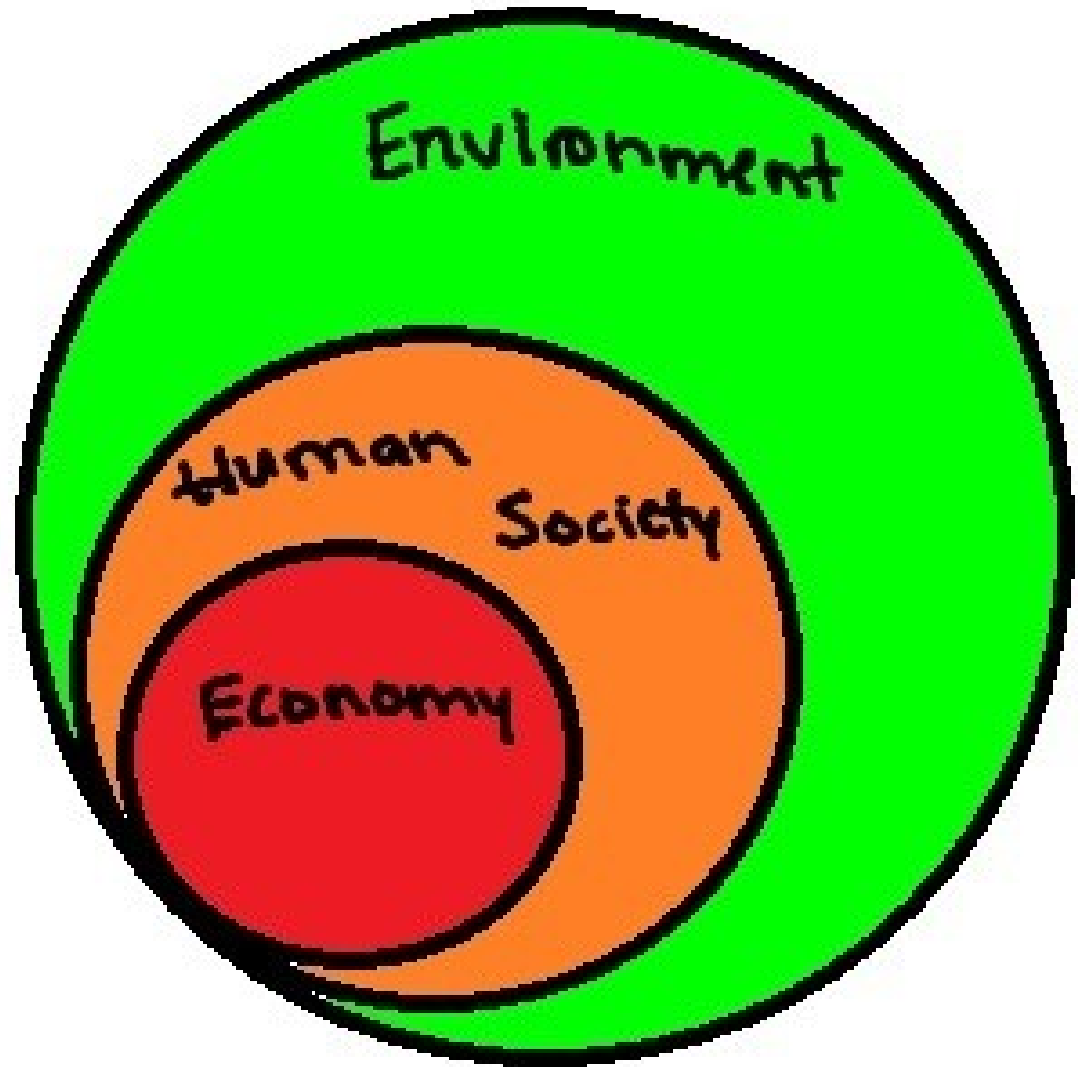

Evidence of directional change in ecosystems (p. 57)

- Ecological goal functions to measure
 - Diversity
 - Energy density
 - Structural complexity
 - Functional complexity
 - Total energy flowing
 - Total energy stored



Trends to be expected in ecosystem development (Odum 1969)

Ecosystem Attribute

Developmental Stage Mature Stage

Community energetics

Gross production/community respiration (P/R ratio)

>1

~1

Gross Production/standing crop biomass (P/B ratio)

high

low

Biomass supported/unit energy flow (B/E ratio)

low

high

Food chains

linear

weblike

Nutrient cycling

Mineral cycles

open

closed

Nutrient exchange rate

rapid

slow

Nutrient conservation

poor

good

Overall homeostasis

Stability (resistance to external perturbations)

poor

good

Entropy

high

low

Information

low

high

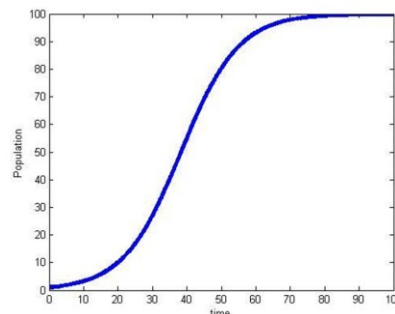

History of Life on Earth

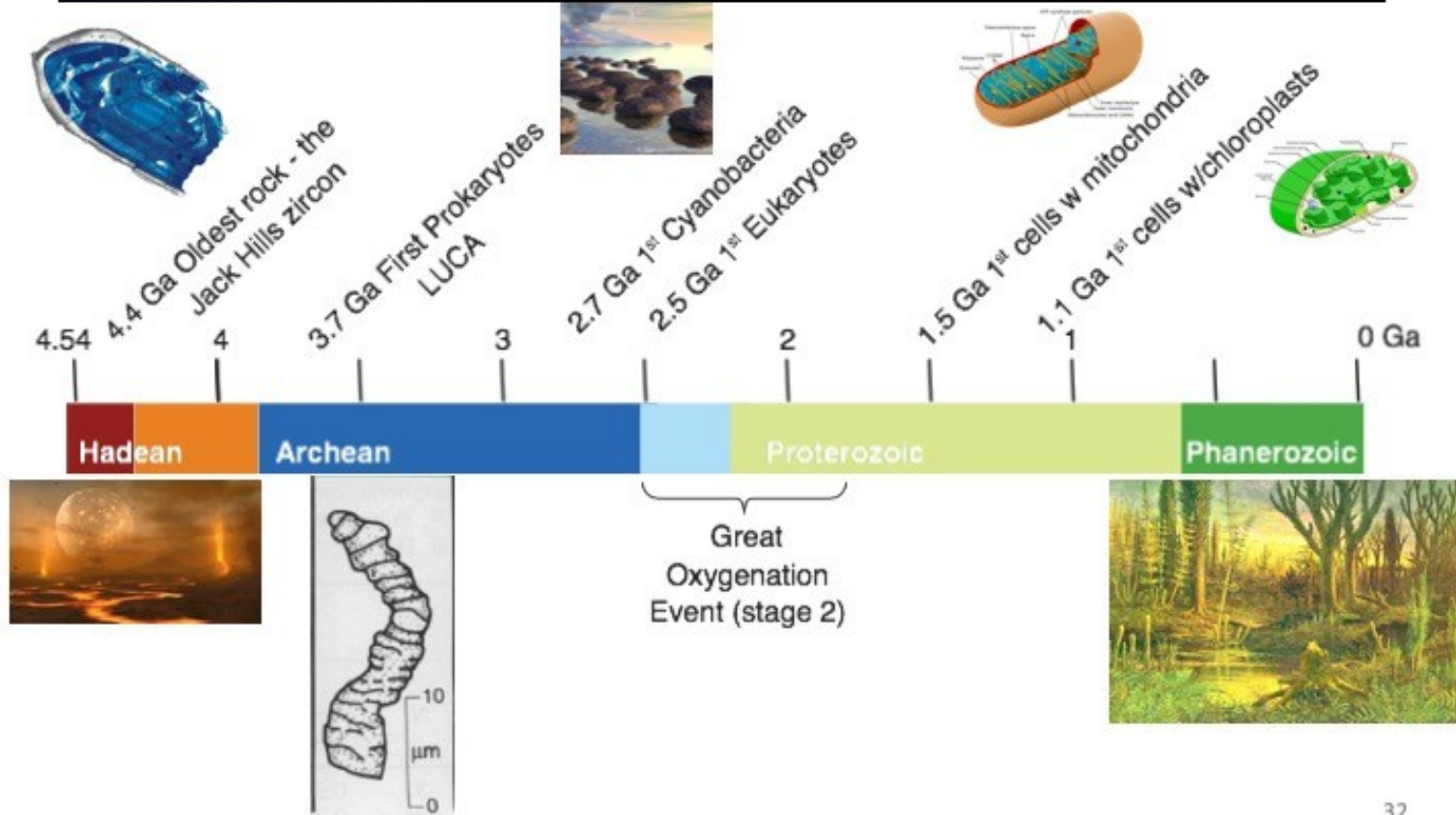

Origins of life covered in Chapter 4; brief intro here for win-win examples

Life impacts the atmosphere

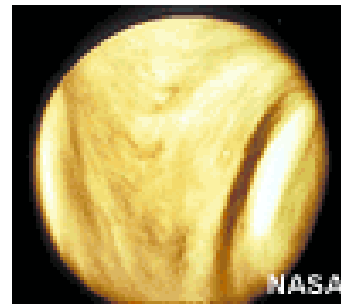

Venus

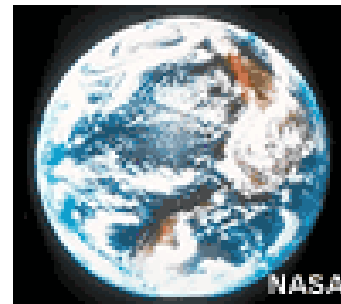

Earth

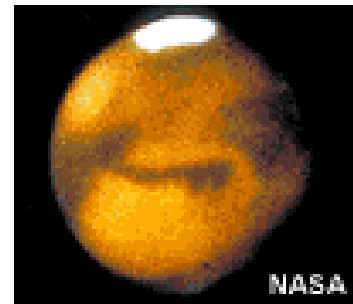

Mars

Carbon Dioxide (CO ₂)	96.5%	0.03%	95%
Nitrogen (N ₂)	3.5%	78%	2.7%
Oxygen (O ₂)	Trace	21%	0.13%
Argon (Ar)	0.007%	0.9%	1.6%
Methane (CH ₄)	0	0.002%	0

"molecular currency" of intracellular energy transfer: **ATP**

- **ATP** (Adenosine triphosphate) is able to store and transport chemical energy within cells.

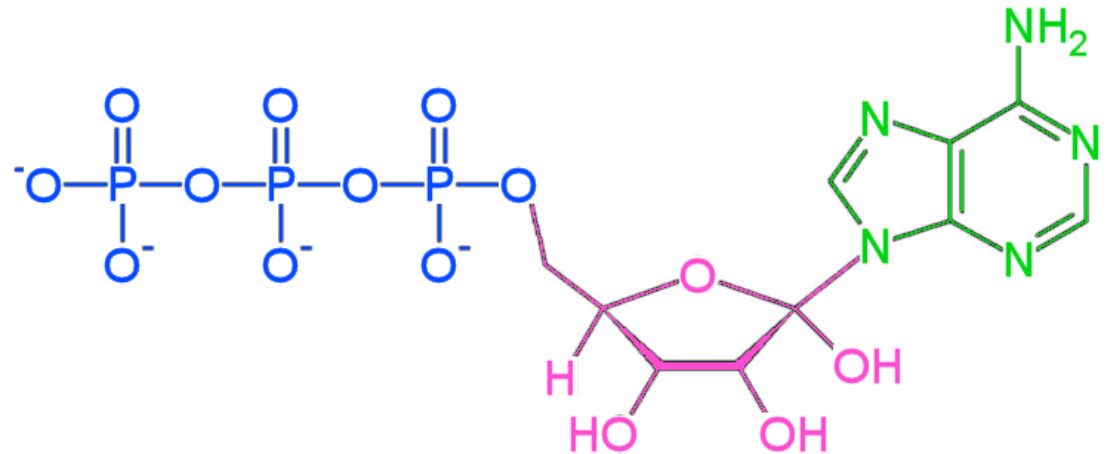

Without oxygen

- **Glycolysis** produces 2 ATP, 2 NADH, and 2 pyruvate molecules

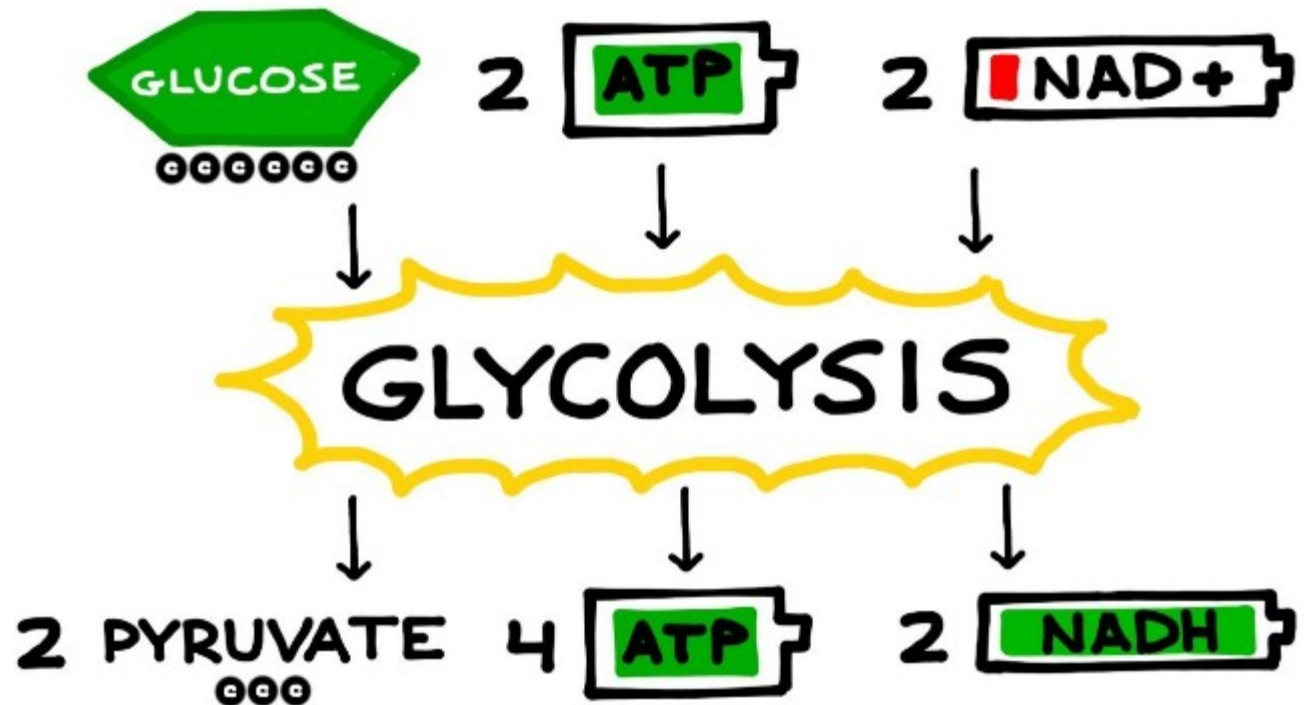

CELLULAR RESPIRATION

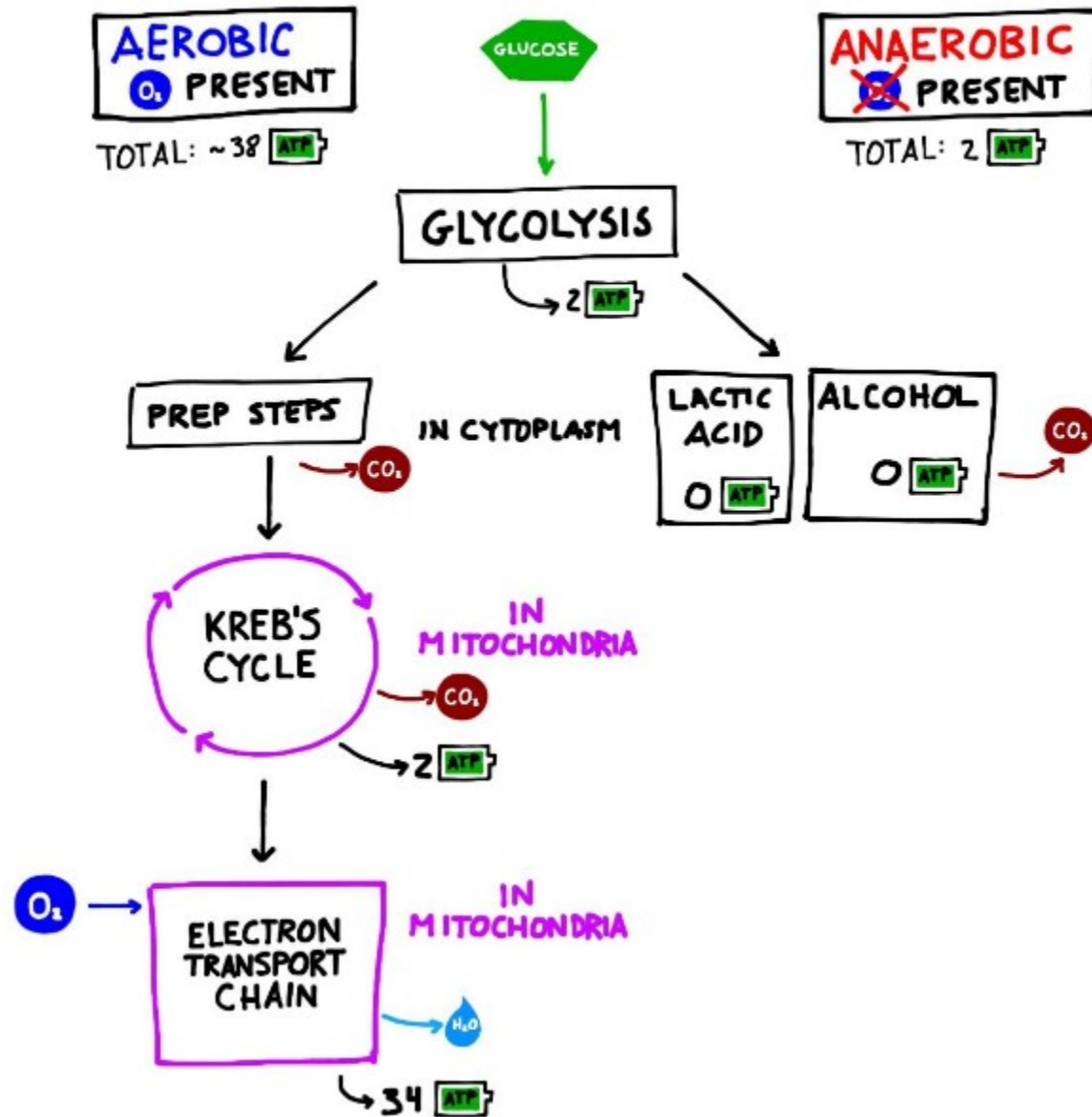

Oxygen in the atmosphere leads to the ozone layer

Stratospheric Ozone Production

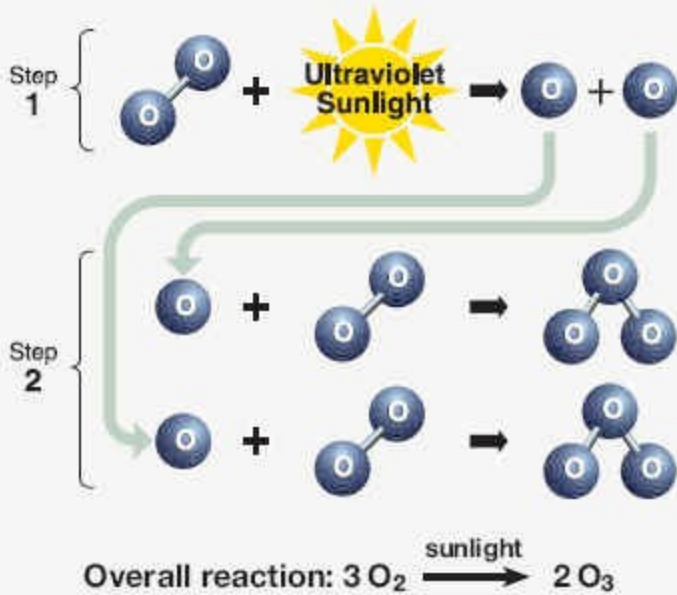
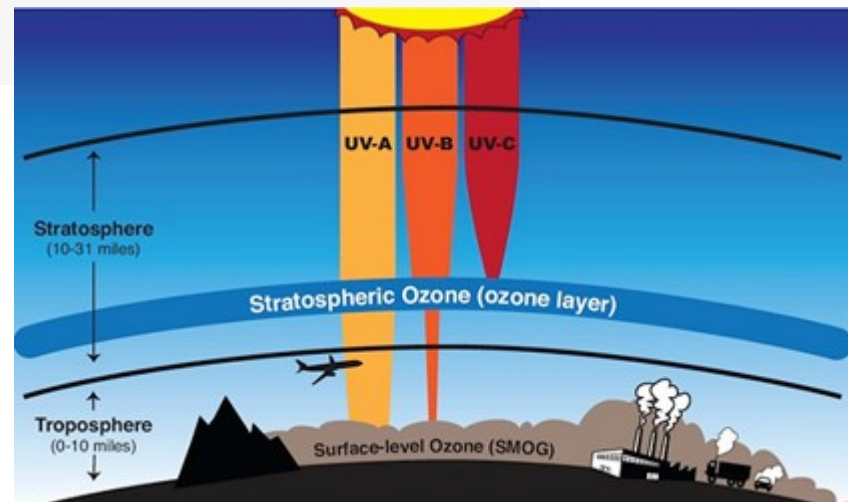
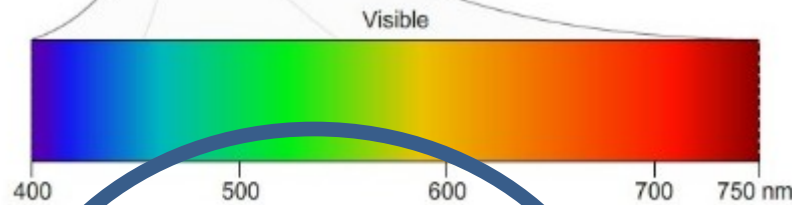
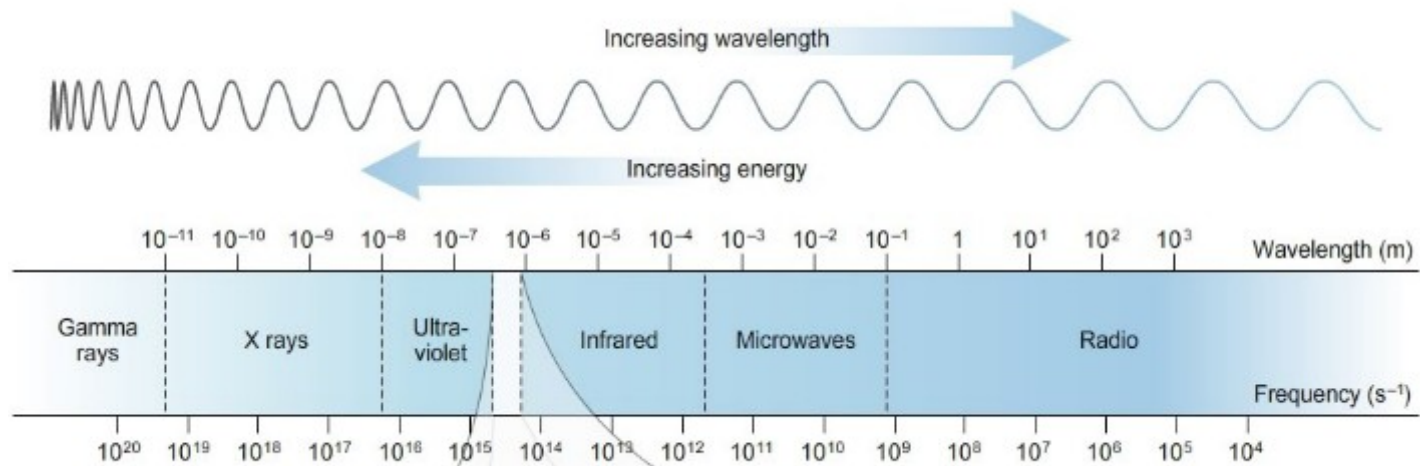

Figure Q2-1. Stratospheric ozone production. Ozone is naturally produced in the stratosphere by a two-step reactive process. In the first step, solar ultraviolet radiation (sunlight) breaks apart an oxygen molecule to form two separate oxygen atoms. In the second step, each atom then undergoes a binding collision with another oxygen molecule to form an ozone molecule. In the overall process, three oxygen molecules plus sunlight react to form two ozone molecules.



Electromagnetic spectrum



© Sapling Learning

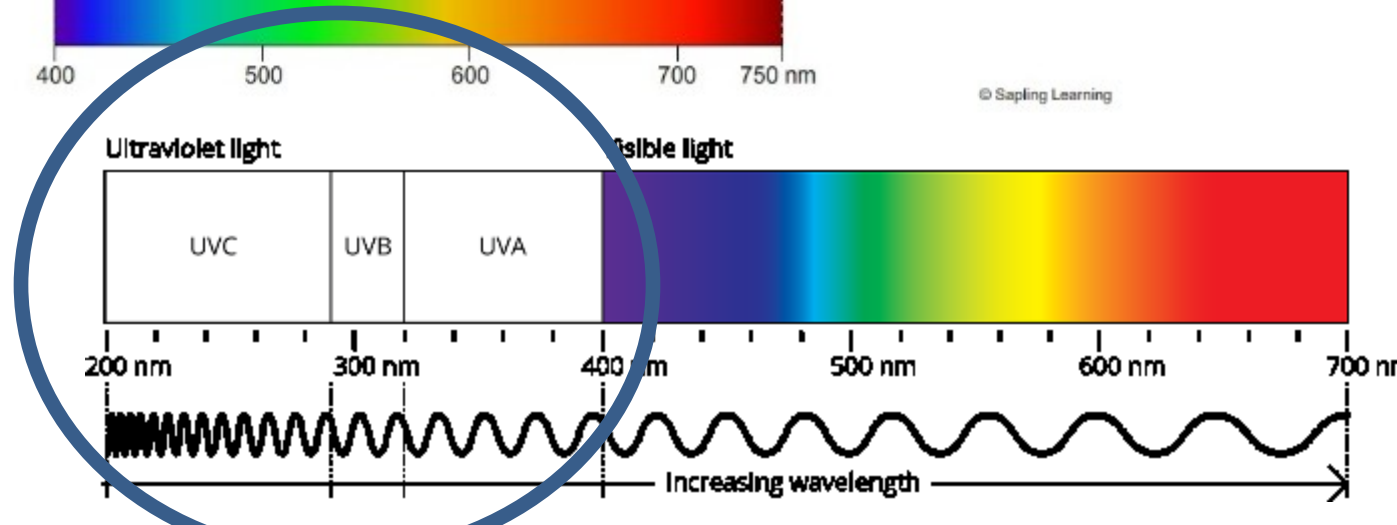

SOLAR UVA,UVB&UVC RAYS

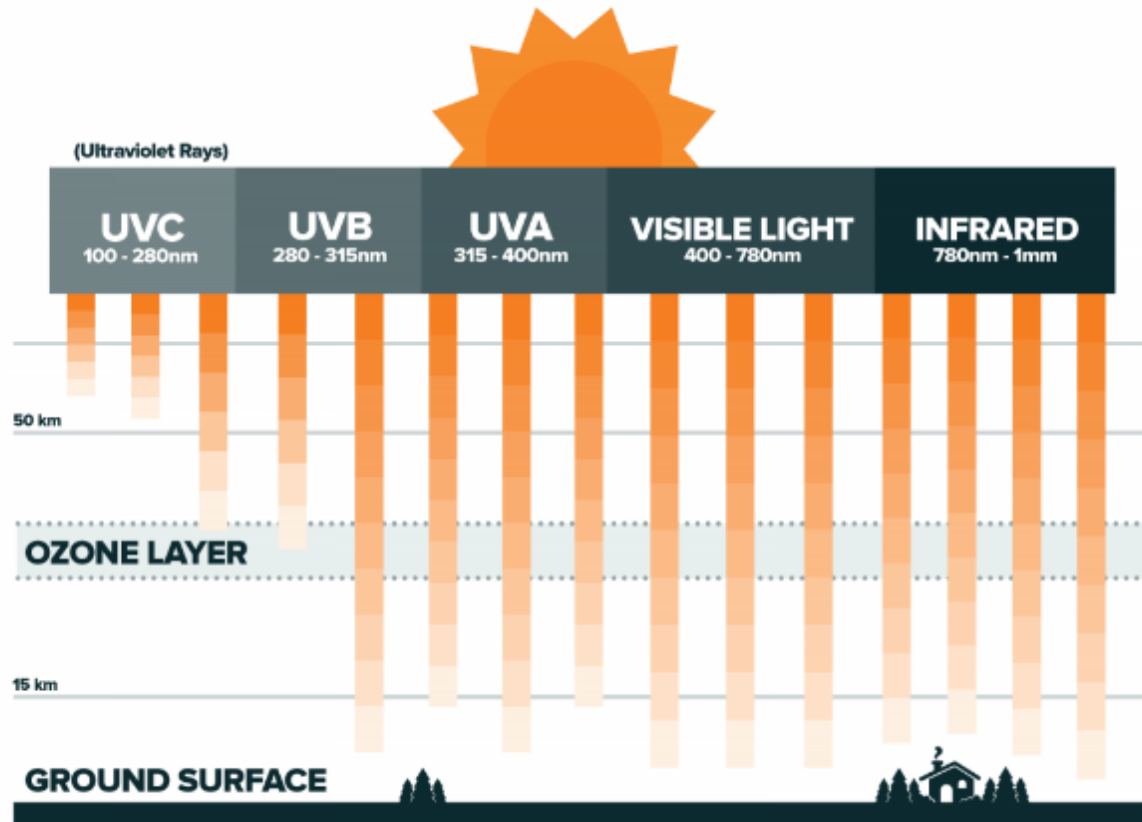

The ozone layer

- Protected life to move from the seas and colonize land around 600M years ago



History of Life on Earth

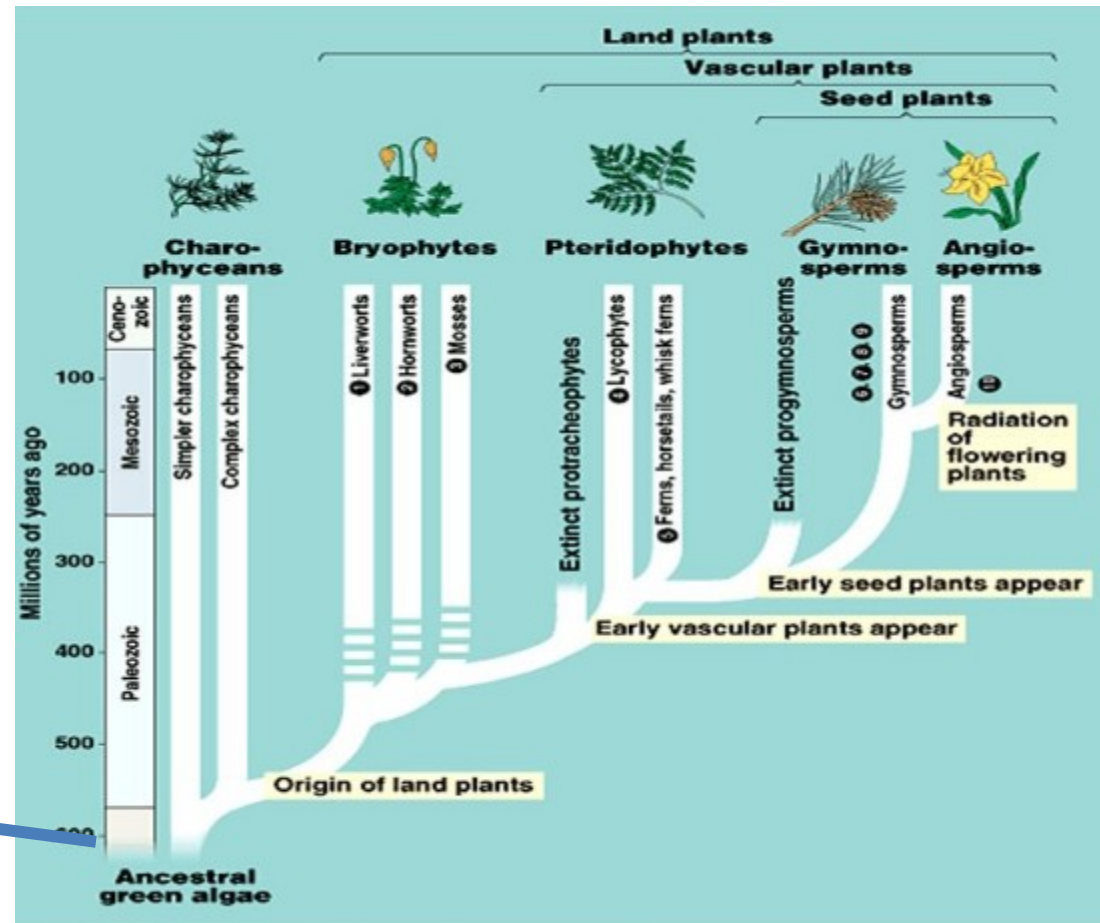
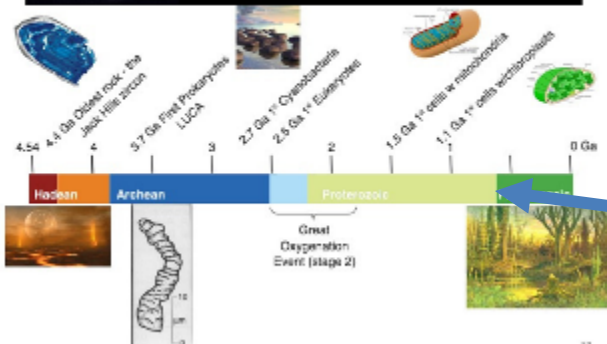

Other theories of land colonization

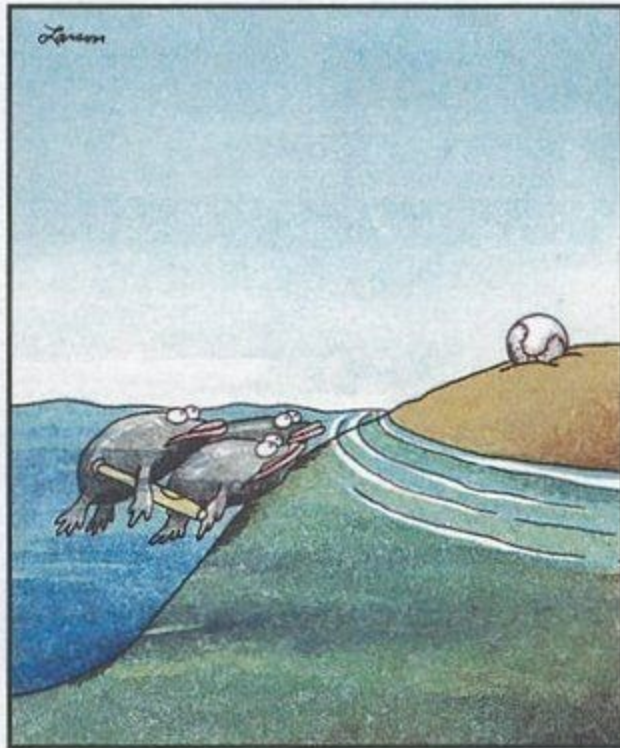

Great moments in evolution

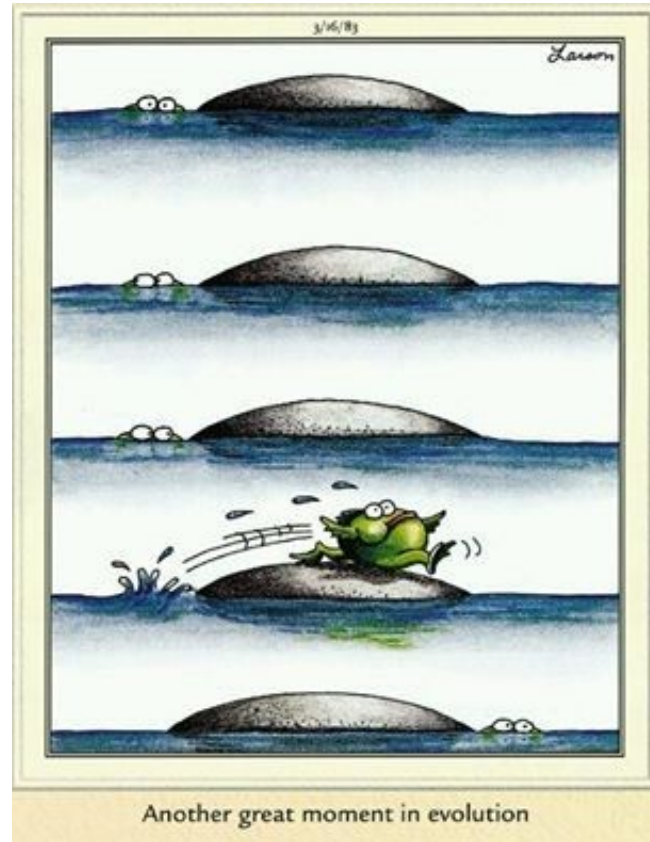

Another great moment in evolution

Homage to Gary Larson

Soil formation

Organisms



Topography



Time



Climate



Parent Material

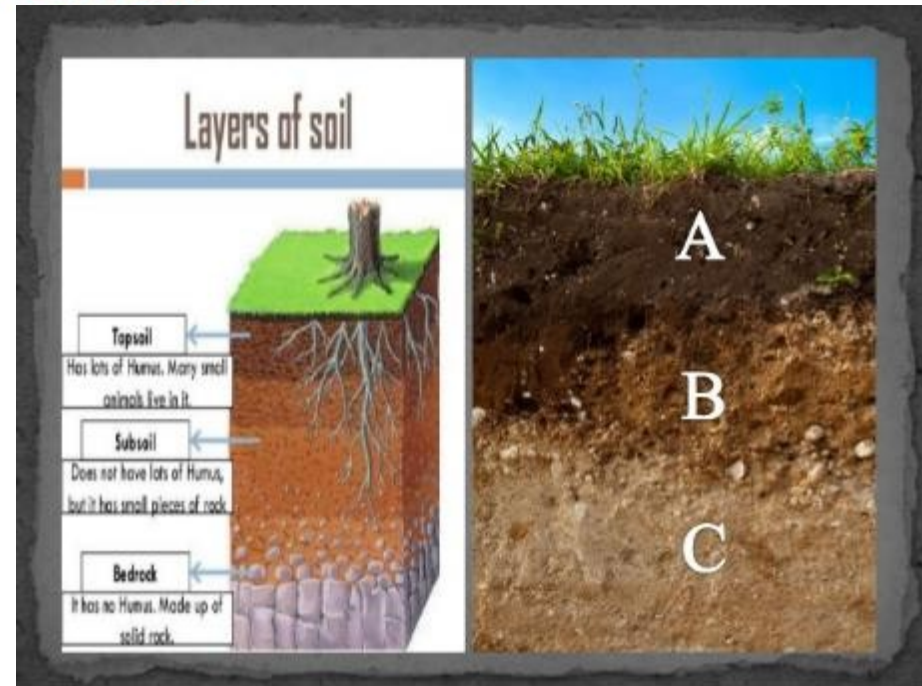

how Soil is formed



Soils are a key element of every landscape



Soils around the world are very diverse

Soils

1. absorb, store, and release water in ways that aid plant, animal, and microbial life locally;
2. play a role in the purification of water and the global hydrological cycle;
3. absorb, store, and release organic and inorganic nutrients aiding myriad life forms locally;
4. play significant roles in global carbon, nitrogen, and other elemental cycles;
5. recycle wastes and dead organisms and regenerate key inorganic nutrients via decomposers;
6. provide habitat for diverse biotic organisms; and
7. provide a physical basis for anchoring plants, particularly large trees.



We live in a world full of life.

Nothing on Earth is entirely abiotic

Rather it is

With Life –
conbiotic



What is environment?

- Before Darwin (1859) environment was considered an organic whole. Everything in it made some contribution and had some meaning with respect to everything else. Darwin subscribed to this view, but his emphasis, and that of his followers, on the evolving organism struggling to survive, suppressed the exploration of holistic aspects of the origin of species that might have been developed.
- After Darwin, the organism came into great focus.
- The result was two distinct things (dualism), organism and environment, supplanting the original organism-environment whole (synergism).

Autocatalysis

- Increase in the activity of any participant will tend to increase the activities of all the others as well.

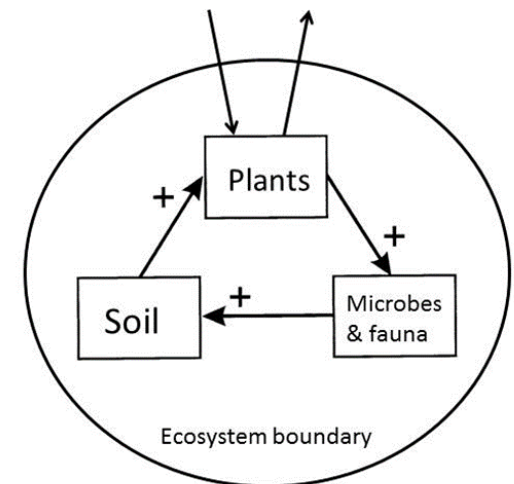
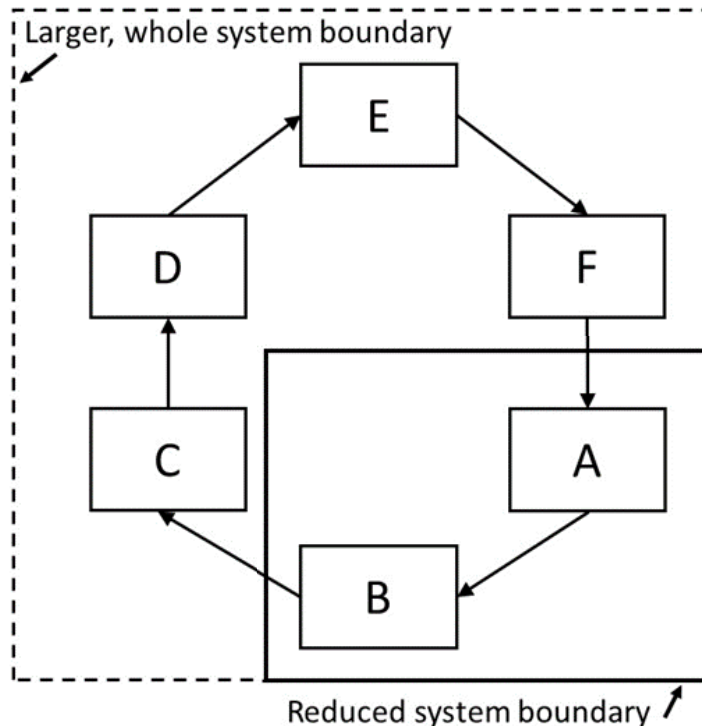

Coherence

- “Each center is (recursively) dependent on other coherent centers for its own coherence”
Alexander (2012) referring to urban planning



Spiral up

Spiral down – lack of coherence



Coupled transformers

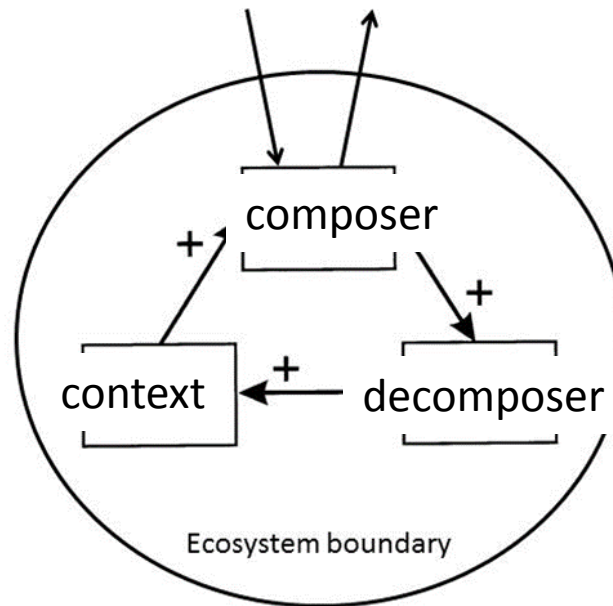

Most basic sustainable system requires a producer/composer and consumer/decomposer in an autocatalytic process



“It may be that all self-sustaining systems are reciprocating”

Jacobs, 1969, p. 126

Kafka ecosystem... Hmm

Kafka Connectors and Streams

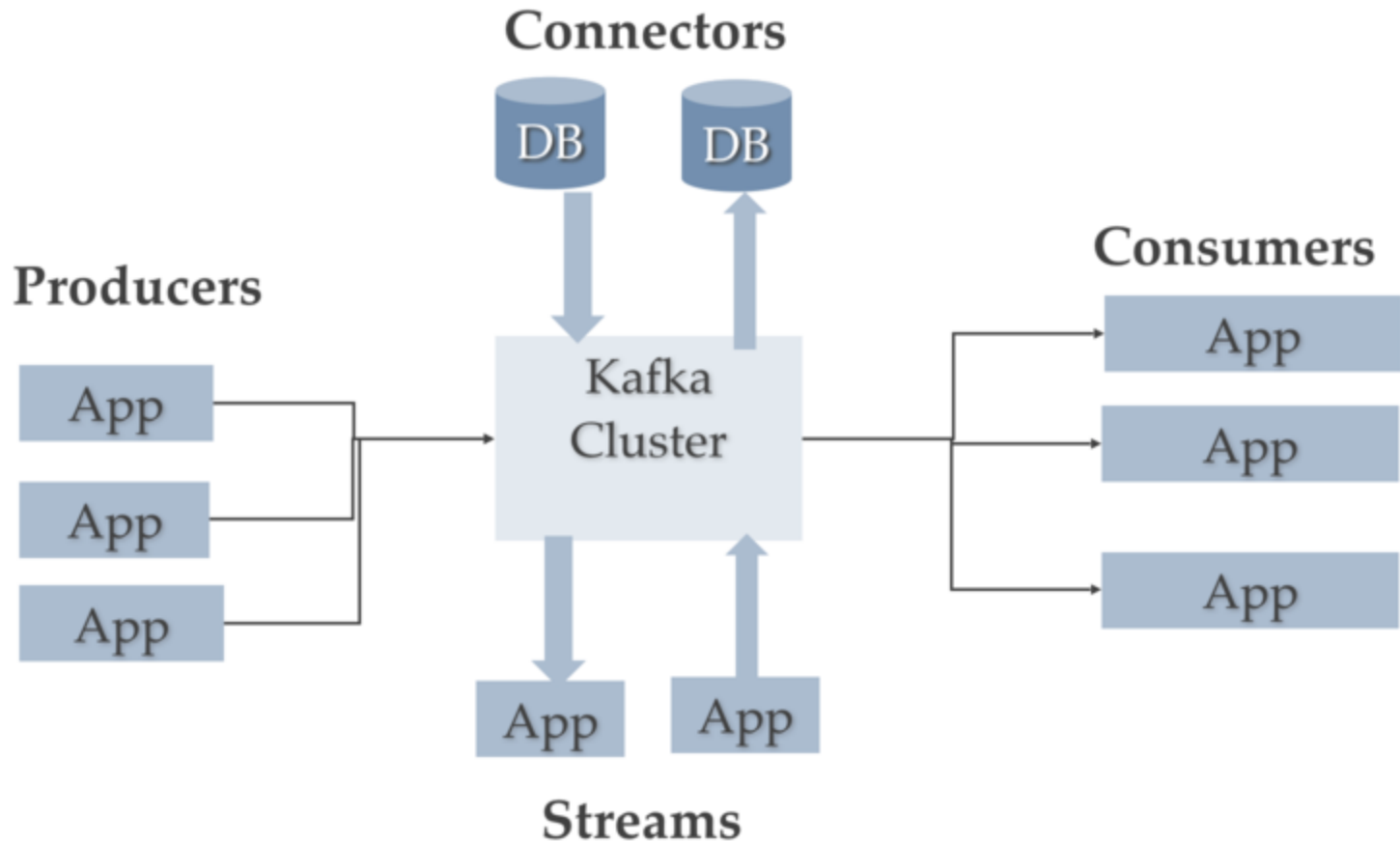

Discussion questions

- What is something that is not conbiotic?
- Can we be truly objective/separate from any experiment or observation?
 - Why do we believe that we can be?
- What are the advantages of “failure to last”?
- How does autocatalysis induce competition?

As the community assembly process forms a food web, it selects only species that fit into the existing web

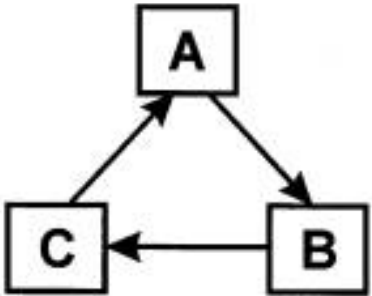

(a)

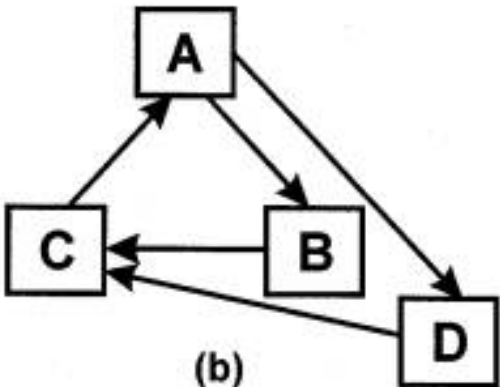

(b)

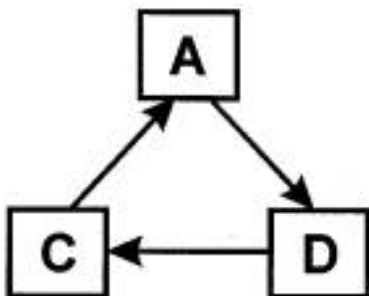

(c)

Discussion questions

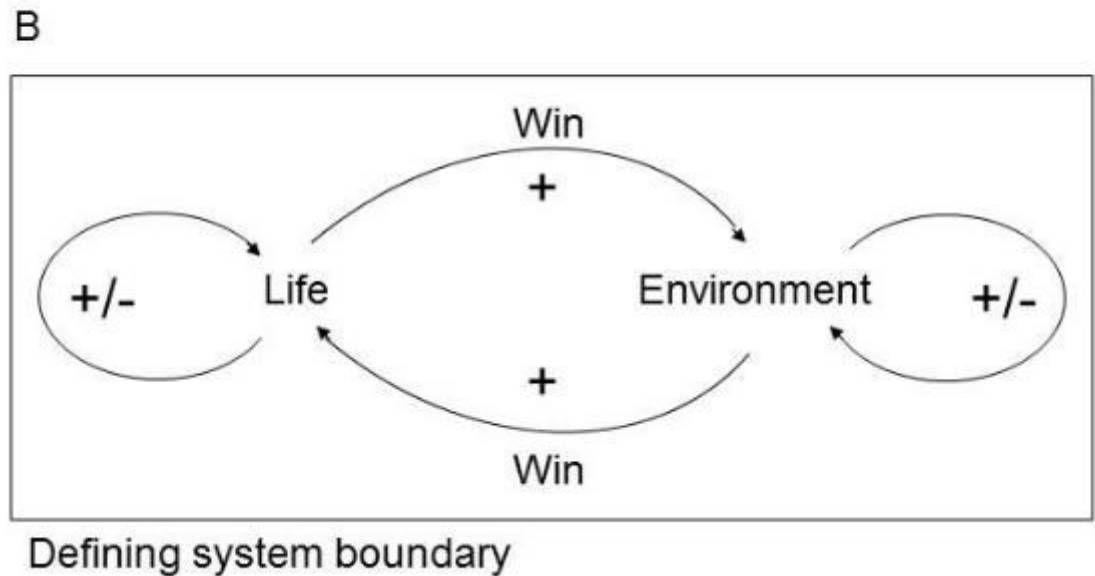
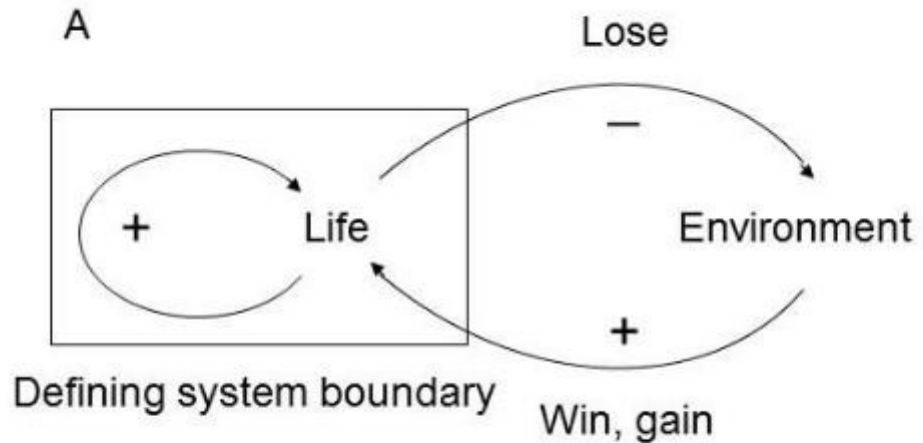

Is this too simplistic?

Which one fits your dissertation?

- 1. Your mission is to make an incremental advance in scientific understanding of life and/or environmental process and to produce a pragmatic” (as based on social norms) contribution to science in the short term.
- 2. Your mission is to synthesize existing knowledge and to make an anticipatory contribution to science that has the potential to yield true human environmental sustainability in the long term.