



ANDREA DEPLAZES (ED.)

BIRKHÄUSER

**CONSTRUCTING ARCHITECTURE**  
MATERIALS PROCESSES STRUCTURES  
**A HANDBOOK**

DARCH **ETH**

Dependence 2008, Switzerland, Birkhäuser Verlag  
© Swiss Federal Institute of Technology Zurich

# **CONSTRUCTING ARCHITECTURE**



ANDREA DEPLAZES (ED.)

BIRKHÄUSER

**CONSTRUCTING ARCHITECTURE**  
**MATERIALS PROCESSES STRUCTURES**  
**A HANDBOOK**

---

## Credits

Swiss Federal Institute of Technology, Zurich  
Faculty of Architecture  
Chair of Architecture and Technology I/II  
Prof. Andrea Deplazes  
[www.deplazes.arch.ethz.ch](http://www.deplazes.arch.ethz.ch)

*Editing, concept and layout*

Prof. Andrea Deplazes, Christoph Elsener, Sascha Roesler, Cordula Seger, Tobias Siegrist

*Picture editors*

Julia Buse, Janet Schacke

*Cover photo*

Ruckstuhl AG carpet factory  
St. Urbanstrasse 21  
4901 Langenthal  
Switzerland  
[www.ruckstuhl.com](http://www.ruckstuhl.com)

*Collaborators since 1997*

Patric Allemann, Oya Atalay Franck, Marcel Baumgartner, Nik Biedermann, Matthias Blass, Tamara Bonzi, Sian Brehler, Gisela Brüllmann Roth, Kamenko Bucher, Ramun Capaul, Maud Châtelet, Franca Comalini, Katja Dambacher, Natalina Di Iorio, Alois Diethelm, Christoph Elsener, Christine Enzmann, Serge Fayet Hemmi, Lukas Felder, Eva Geering, Lorenzo Giuliani, Jasmin Grego, Daniel Gut, Martina Hauser, Christian Hönger, Simone Hübscher, Marius Hug, Tibor Joanelly, Dimitri Kaden, Roger Kästle, Sergej Klammer, David Leuthold, Thomas Melliger, Urs Meister, Maria Mohl Rodríguez, Susanne Müller, Mauro Pausa, Sascha Roesler, Martin Saarinen, Cordula Seger, Tobias Siegrist, Patrik Seiler, Roman Singer, Susanne Stacher, Katharina Stehrenberger, Mark van Kleef, Christoph Wieser, Barbara Wiskemann, Raphael Zuber

*Assistants since 1997*

Thomas Allemann, Hanna Åkerström, Christof Ansoerge, Tamara Bonzi, Bettina Baumberger, Michael Bösch, Martin Bucher, Andreas Buschmann, Julia Buse, Corina Cadosch, Borl Csicsely, Ueli Degen, Angela Deuber, Christiane Felber, Adrienne Fonyo, Simon Frommenwiler, Silvan Furger, Jean Lucien Gay, Jörg Grabfelder, Pedja Hadzimanovic, Valerie Heider, Nadja Hutter, Harris Iliadis, Steffen Jürgensen, Ariane Komeda, Philipp Lehmann, Matthias Lehner, Mikael Ljunggren, Carmelia Maissen, Sebastian Müller, Lisa Nestler, Anastasia Paschon, Ana Prikic, Jonas Ringli, Elisabeth Rutz, Gian Salis, Janet Schacke, Florian Schätz, Sara Schibler, Julian Schramek, Cindy Schwenke, Eckart Schwerdtfeger, Christa Vogt, Claudia Vosti, Karen Wassung, Thomas Wirz

*Translation into English*

Gerd H. Söffker, Philip Thrift (assistants: Carola Loth, Eva Rühle)

This book is also available in German:

*Softcover:*

ISBN-10: 7643-7313-X  
ISBN-13: 978-3-7643-7313-9

*Hardcover:*

ISBN-10: 7643-7312-1  
ISBN-13: 978-3-7643-7312-2

A CIP catalogue record for this book is available from the Library of Congress, Washington, D.C., USA

Bibliographic information published by Die Deutsche Bibliothek

Die Deutsche Bibliothek lists this publication in the Deutsche Nationalbibliografie; detailed bibliographic data is available in the internet at <http://dnb.ddb.de>.

This work is subject to copyright. All rights are reserved, whether the whole or part of the material is concerned, specifically the rights of translation, reprinting, re-use of illustrations, recitation, broadcasting, reproduction on microfilms or in other ways, and storage in data banks. For any kind of use, permission of the copyright owner must be obtained.

© 2005 Birkhäuser – Publishers for Architecture

P.O. Box 133, 4010 Basel, Switzerland  
Part of Springer Science+Business Media

Printed on acid-free paper produced from chlorine-free pulp. TCF ∞

Printed in Germany

*Softcover:*

ISBN-10: 3-7643-7189-7  
ISBN-13: 978-3-7643-7189-0

*Hardcover:*

ISBN-10: 3-7643-7190-0  
ISBN-13: 978-3-7643-7190-6

9 8 7 6 5 4 3 2

<http://www.birkhauser.ch>

## Contents

### **Introduction**

Preface	10
How to use this book	11
Solid and filigree construction	<b>13</b>

### **MATERIALS – MODULES**

Introduction	
Properties of materials	
Example	

### **Modules**

The importance of the material	<b>19</b>
The perception of architectural space	20
The longevity of materials	21
Plastic	22

### **Masonry**

Introduction	
Properties of materials	
Systems	
Systems in architecture	

The pathos of masonry	<b>23</b>
The materials	32
Swiss clay bricks and blocks	33
Masonry terminology	35
Design and construction	36
Masonry bonds	38
Tying and reinforcing double-leaf masonry walls	42
The skill of masonry construction	43
Types of construction	49
Prefabrication	52

### **Concrete**

Introduction	
Properties of materials	
Systems	
Systems in architecture	

On the metaphysics of exposed concrete	<b>56</b>
The materials	60
The concreting process	63
10 rules for the production of concrete	66
Exposed concrete surfaces	67
Floor supports, exposed concrete with internal insulation	69
The fixing of heavy external cladding (concrete)	70
The fixing of heavy external cladding (stone)	71
Chart for establishing preliminary size of reinforced concrete slabs	72
Linear structural members	73
Systems with linear members	74
Planar structural members	75
Systems with planar structural members	76

### **Timber**

Introduction	
Properties of materials	
Systems	
Examples	

Wood: indifferent, synthetic, abstract – plastic	<b>77</b>
The materials	82
Wood-based products – Overview	84
Wood-based products – Layered products	85
Wood-based products – Particleboards	87
Wood-based products – Fibreboards	88
Important panel and prefabricated systems – Overview	89
Panel construction – Current developments	94
Timber construction systems – Overview	96
Platform frame construction – Construction principle	99
Chart for establishing preliminary size of timber beams	103
Conversion of a trunk in traditional Japanese timber building culture	104
The threads of the net	106

## Contents

---

	<b>Steel</b>	
Introduction	Why steel?	<b>113</b>
Properties of materials	Sections – forms and applications	120
	Fire protection	122
	Potential applications for structural steelwork	123
Systems	Connections – A selection	124
	Structures – frame with cantilevering beams	126
	Structures – frame with continuous columns	128
	Structures – two-way frame	130
	Chart for establishing preliminary size of steel beams	132
Systems in architecture	Folding and bending	133
	Frames	134
	Girder, lattice beam and facade	135
	Space frames	136
	Diamonds and diagonals	137
	Canopy structures	138
	<b>Insulation</b>	
Introduction	The “invisible” building material	<b>139</b>
Properties of materials	Transparent thermal insulation	143
	Thermal insulation materials and their applications	144
Systems	Thermal insulation systems – Overview	146
	<b>Glass</b>	
Introduction	Glass – crystalline, amorphous	<b>147</b>
	<b>ELEMENTS</b>	
	<b>Foundation – Plinth</b>	
Introduction	Building underground	<b>153</b>
Processes	Site preparation – Surveying work	161
	Site preparation – Earthworks	162
	Foundations	163
Systems	Foundation schemes – Loadbearing layer inside	164
	Foundation schemes – Loadbearing layer outside	165
Systems in architecture	The basis for plinths	166
Building performance issues	External wall below ground – Influences on the building envelope	169
	<b>Wall</b>	
Introduction	The wall	<b>170</b>
	<b>Opening</b>	
Introduction	For and against the long window – The Perret – Le Corbusier controversy	<b>175</b>
Systems	The window – opening package	184
	Position of window, opening rebate forms	185
	The window as a component – frame sections	186
	The window as a component – glass	187
	Window – horizontal section, 1:1	188
	Window – vertical section, 1:1	190
Systems in architecture	The opening as a hole	192
	The opening as a horizontal strip	193
	The opening as a joint	194
	The opening as a transparent wall	195

Introduction	About the door	196
Systems	Doors – types of opening	197
	Doors – types of door stop	198
	Doors – hardware	199
Building performance issues	Wall – opening – Influences on the building envelope	200
	Cutting out sunlight and glare	201

## Floor

Introduction	The doubling of the sky	205
--------------	-------------------------	-----

## Roof

Introduction	The roof	211
Systems	Pitched roof – Functions of layers	213
	Flat roof – Functions of layers	214
	Flat roof – Warm deck – conventional systems	215
	Flat roof – Warm deck – special systems	216
	Flat roof – Upside-down roof	217
	Flat roof – Cold deck	218
	Systems in architecture	Pitched roof
	Flat roof	220
	The roof as a folded plate	221
	Barrel-vault roof and shell roof	222
Building performance issues	Criteria and relationships	223
	Flat roof – Pitched roof – Repercussions for the building envelope	224

## Stairs, lifts

Introduction	Flights of fancy	225
Systems	Excerpt from the <i>Bauentwurfslehre</i> by Ernst Neufert	230
	The geometry of stair transitions	232
	Balustrades and spandrel panels – Extract from SIA 358	233
	Lifts	234
Systems in architecture	The staircase as an assembly of simply-supported beams	236
	The staircase as a monolithic, organic form	237
	The staircase as a space frame	238
	The staircase as a solid timber construction	239

## STRUCTURES

### Forms of construction

Introduction	An attempt to classify horizontal and vertical space development	243
Concepts	Vertical loadbearing structures in solid construction – Cross-section concepts	251
	Vertical loadbearing structures in solid construction – Plan concepts	252
	Vaulted loadbearing structures in solid construction – Compression structures	253
Examples	Of heavy mass and apparent heaviness	255
	Ksar Ferich – A fortified storehouse in southern Tunisia	258
	Sculpted architecture – The Scottish tower house	263
Processes	Provision of services during planning work	271
	The sequence of building operations	272
Systems	Compartmentation	273
	Box frame construction	274
	Frame construction	275
	Column-and-slab systems	276
	Single-storey shed forms	277
Systems in architecture	Prefabrication – System building	278

	<b>Building performance, energy</b>	
Introduction	Sustainability – Fundamentals of architecture	282
Concepts	The problem of heat flow and vapour diffusion	286
	Insulation concepts – Diagram of layers	287
	Insulation concepts – Complementary systems, loadb. layer inside	288
	Insulation concepts – Complementary systems, loadb. layer outside	289
	Seven rules for the design of a low-energy house	290
Example	Low-tech – high tectonics	291

## **BUILDINGS Selected projects**

Introduction	Structural issues – The relationship between interior structure, loadbearing structure, and infrastructure	295
Examples	Apartment blocks, Martinsbergstr., Baden: Burkard Meyer + Partner	303
	Gallery for Contemporary Art, Marktoberdorf: Bearth + Deplazes	313
	Detached family home, Grabs: Peter Märkli	322
	Paspels School: Valerio Olgiati	332
	Volta School: Miller + Maranta	341
	Sihlhof School, Zurich: Giuliani + Hönger	350
	“Im Birch” School, Zurich: Peter Märkli	361
	Chur Teacher Training College, science wing: Bearth + Deplazes	374
	Swiss School of Engineering for the Wood Industry, Biel: Meili + Peter	383
	Private house, Sevgein: Bearth + Deplazes	394

## **COMPONENTS Drawings**

	Preparation of drawings for buildings	
	Extract from Swiss standard SIA 400:2000	401
	Presentation on drawings –	
	Example: timber platform frame construction	407
	Symbols – Legend for the catalogue of components	409

### **Foundation – Plinth**

	Single-leaf masonry	410
	Double-leaf masonry, rendered	411
	Facing masonry	412
	Fair-face concrete with internal insulation	413
	External insulation, rendered	414
	External cladding, lightweight	415
	External cladding, heavyweight	416
	Timber platform frame construction	417
	Plinth – Roof: solid timber panel construction	418

### **Wall – Floor**

	Single-leaf masonry, rendered	420
	Double-leaf masonry, rendered	421
	Facing masonry	422
	Fair-face concrete with internal insulation	423
	External insulation, rendered	424
	External cladding, lightweight	425
	External cladding, heavyweight	426
	Non-loadbearing external wall	427
	Timber platform frame construction	428
	Solid timber panel construction	429

	<b>Opening</b>	
Windows	Single-leaf masonry	430
	Double-leaf masonry, rendered	432
	Facing masonry	434
	Fair-face concrete with internal insulation	436
	External cladding, lightweight	438
	External cladding, heavyweight	440
	External insulation, rendered	442
	Non-loadbearing external wall	444
	Timber platform frame construction	446
	Solid timber panel construction	448
Doors	Hinged door, external – wood	450
	Hinged door, external – wood/glass	451
	Sliding door, external – metal/glass	452
	Hinged door, internal – wood	453
	Sliding door, internal – wood	454

## **Floor**

	Hollow clay block floor	455
	Hourdis-type hollow clay block floor	456
	Solid concrete slab	457
	Ribbed concrete slab	458
	Concrete waffle slab	459
	Hollow-core concrete slab	460
	Composite slab, profiled metal sheeting–concrete	461
	Solid timber floor	462
	Timber joist floor	463
	Timber box element floor	464
	Steel floor	465

## **Roof – Parapet**

	Pitched roof – warm deck – Fibre-cement, external cladding, lightweight	466
	Pitched roof – warm deck, monopitch roof – Fibre-cement – facing masonry	467
	Pitched roof – cold deck – Roof tiles, masonry in brickwork bond	468
	Pitched roof – cold deck – Sheet metal, single-leaf masonry	469
	Flat roof – warm deck – Bitumen, double-leaf masonry, rendered	470
	Flat roof – warm deck – Bitumen, fair-face concrete with internal insulation	471
	Flat roof – warm deck – Plastics, external cladding, heavyweight	472
	Flat roof – warm deck – Bitumen, non-loadbearing external wall	473
	Flat roof – upside-down roof – Bitumen, external insulation, rendered	474
	Flat roof – cold deck, uncoated roof – Bitumen, timber platform frame construction	475
	Flat roof – warm deck, suitable/unsuitable for foot traffic	476
	Flat roof – cold deck	478
	Flat roof – upside-down roof, with rooftop planting	480

## **APPENDIX**

	Further reading	485
	Picture credits	486
	Index	500
	Thanks	508

## Preface

*Andrea Deplazes*

“Constructing Architecture” describes that architectural position of architects which makes it possible for them to forge links between the planning of a project and its realisation, the competence to create coherence regarding content and subject. During the planning of a project this is reflected in the clarification and development of a design objective, and in the physical implementation becoming increasingly more clearly defined. When, for example, a literary work is translated into another language the use of the correct grammar or syntax is merely a technical prerequisite – a *conditio sine qua non*. The important thing is to reflect coherently the sense and the atmosphere of the original text, which in certain circumstances may itself have a specific influence on grammar and syntax. Architecture is similar: although it is not a language consisting of sounds, words or texts, it has a material vocabulary (modules), a constructive grammar (elements) and a structural syntax (structures). They are the fundamental prerequisites, a kind of “mechanics of architecture”. This also includes the technical and structural basics which establish a set of rules and regulations of construction principles and know-how that can be learned and which are wholly independent of any particular design or construction project. Although these tools are logical in themselves they remain fragmentary, unrelated and therefore “senseless” until they are incorporated into a project.

Only in conjunction with a concept does a vigorous design process ensue in which the initially isolated technical and structural fragments are at once arranged to fill a consummate, architectural body. The fragments and the whole complement and influence each other. This is the step from construction to architecture, from assembly to tectonics.

Tectonics always incorporates all three components: the conceptual connection of the physical assembly and the metaphysical, architectural space, and all the mutually interacting, transforming and influencing aspects, which, in the end, are specific and also exemplary.

The best that a university can achieve is to teach its students to teach themselves. This includes: independent establishment of basic premises, critical analysis and intensive research, advancing hypotheses and working out syntheses. Many topics in the basic courses are theses that do not have to be true just because they appear in this book in black and white. Nor does this book replace the subject material taught in the lectures. Instead, this book should be seen as a provisional compendium of known and current architectural and technological issues, as a foundation that allows us to think about the complex *métier* of architecture.

Zurich, April 2005





The section entitled “Building performance issues” presents insights into the relationships between the construction and the performance of the building envelope.

The appendix contains a series of drawings, scale 1:20, which illustrate the complex build-up of layers in contemporary building envelopes. Plinths, wall and floor junctions, openings (doors and windows), as well as the roof, are still core areas in the realm of architectural construction. The construction forms presented are bound by a certain architectural concept and may not be generalised without prior examination.

Subjects vary here as to the amount of material each is afforded. This is not due to any particular value being

implied but reflects a working method focused on teaching. This publication does not claim to be exhaustive, although its form as a printed book might suggest this! It is rather a collection of diverse basic principles which were worked out at the Professorial Chair of Architecture and Construction at the ETH Zurich. Some of the contributions have been kindly made available to us by outside authors; only a few stem from standard works.

Finally, we have to point out that liability claims or any other types of claim are entirely excluded. The reasonable use of the content of this book is the responsibility of the user and not the authors of this publication.

### The sequence of architectural construction as an additive chain from small to large



**Fig. 2: Earth**  
Mixing with cob and sand



**Fig. 3: Clay bricks**  
Production, natural drying (in the air), Pakistan



**Fig. 4: Wall**  
Rediscovered remains of a house, Lebanon



**Fig. 5: Structural shell**  
Masonry building, under construction



**Fig. 6: Structure**  
Hans Kollhoff, KNSM-Eiland housing development, Amsterdam

#### 1. Raw materials

According to Gottfried Semper the raw materials available as potential building materials prior to the first stage of processing can be classified into the following four categories according to their properties:

1. Flexible, tough, resistant to fracture, high absolute strength
2. Soft, plastic, capable of hardening, easy to join and retaining their given form in the hardened state
3. Linear forms, elastic, primarily *relatively* high resistance, i.e., to forces acting perpendicular to their length
4. Solid, dense, resistant to crushing and buckling, suitable for processing and for assembling to form solid systems

Owing to their properties, each of these four materials categories belongs, according to Semper, to a certain technical skill or category: textile art, ceramic art, tectonics (carpentry) or stereotomy (masonry).

This is based on the idea of “every technique has, so to speak, its own certain principal material which offers the most convenient means of producing the forms belonging to its original domains”.

The raw material, however, remains “meaningless” in the architectural sense as long as it is “unreflected”, i.e. its potential for cognition remains concealed.

The “selection” process itself (e.g. from undressed stones) in the form of a collection of modules, but also the preparatory work prior to building already form a planned stage of the work and consequently part of the first stage of production (“preparation”).

#### 2. Modules

The “building blocks” or “workpieces” form the smallest basic components intended for the construction. They are the result of a finishing process – a more or less complex and time-consuming production process:

- Dressed masonry units (blocks, slabs, squared and rough-hewn stones) are produced from irregular stones.
- Moulded and “cast” earths (clay bricks, ceramic tiles, air-dried, fired) or processed earths (cement, concrete) are produced from earths, sands and gravels (e.g. cob, clay).
- Prepared timber members (debarked logs, squared members, joists, boards, battens) are produced from linear, form-stable or elastic modules consisting of organic fibres (e.g. tree trunks, rods, branches).

All these modules exhibit their own inherent “tectonics”, their own inherent jointing principles which are present in the second production stage: layering, interlocking, weaving, plastic formation (“modelling”), moulding, etc.

#### 3. Elements

“Components” consisting of modules represent in a certain way the semi-finished goods of the second production stage (masonry walls and plates; walls; vaults and shells; floors and roofs).

Stability problems become evident during production and also during the ongoing assembly of the elements; these problems can be solved with the following measures:

- horizontal developments such as folds, corrugations, ribs
- vertical gradations with increasing height/depth
- formation of frames through the provision of stiffeners (diagonal stiffeners, supports as auxiliary constructions, corner stiffeners)

#### 4. Structures

The third stage of production forms a “component fabric” whose subcomponents can be described as follows:

##### A. Loadbearing structure:

Precondition for the building structure. Only the elements necessary for the loadbearing functions (supporting, stabilising) are considered.

##### B. Building structure:

This is the interaction of all the elements required for the structure (supporting, separating for the purpose of creating spaces), sometimes also called “structural shell”.

##### C. Interior layout structure:

This contains the realisation of a more or less complex sequence of internal spaces. The relationship between loadbearing structure, building structure and interior layout structure allows us to derive a “tectonics model”. Tectonics in this sense is the physically visible part of this “higher bonding”, the fabric of the architectural concept for the purpose of creating internal spaces.

##### D. Infrastructure:

All the permanently installed supply and disposal facilities necessary in a building. The relationship between the infrastructure and the building structure frequently results in conflicts.

##### E. Access structure:

Horizontal and vertical circulation routes and spaces. These include stairs and ramps plus the entrances to a building.

#### 5. The structure

The structure is generated by: *Structure and process*

##### Building – spaces – loadbearing structure

- tectonics
- “material fabric”
- loadbearing structure
- finishings and fittings
- infrastructure

##### Plan

- conception (“idea”)
- draft design
- interpretation (significance)
- building documentation
- exchange of information (notation)
- chronology of actions

and

##### Production

- chronology of production stages
- logistics
- operative sequence
- jointing principles

#### Further reading

- Kenneth Frampton: *Studies in Tectonic Culture*, Cambridge (MA), 2001.
- Fritz Neumeyer: *Nachdenken über Architektur, Quellentexte zur Architekturtheorie*, Munich, 2002.
- Gottfried Semper: *Der Stil in den technischen und tektonischen Künsten oder praktische Ästhetik*, vol. I, Frankfurt a. M. 1863 / Munich, 1860 – English translation: *Style: Style in the Technical and Tectonic Arts; Practical Aesthetics*, Harry Francis Mallgrave (ed.), Los Angeles, 2004.

## Solid and filigree construction

Christoph Wieser, Andrea Deplazes

On the occasion of a lecture on the “morphology of the architectural” at the ETH Zurich architecture theorist Kenneth Frampton drew on the works of Eugène Viollet-le-Duc and Gottfried Semper, who together pioneered the theory of architecture, to distinguish between the development of architectural forms from their origins as “earthworks” and “roofworks”, or with the terms stereotomy (solid construction) and tectonics (filigree construction) that are used in architecture theory. While the term “earthwork” includes all the building techniques of solid wall construction (cob, pisé and adobe, clay-and-stone masonry, etc. and their stereotomic forms such as walls, arches, vaults and domes), the open “roofwork” encompasses all structures with linear and rodlike members – textile-like woven structures which span open spaces as “covers”, forming the “roof”, the overhead boundary to the space below. Timber engineering, with its layered, interwoven assembly, belongs to this category, as does industrialised steelwork from about 1800 onwards.

The principles of the structural formation in filigree construction were not new. They were known to us through anonymous and traditional timber buildings: conical and spherical domes made from straight and curved individual linear members, vertical solid timber construction, two- and three-dimensional frameworks (timber frames, timber studding), horizontal joist floors and roofs, and roof constructions (purlin and couple roofs, trussed frames) were the carpenter’s daily bread. They were used principally wherever wood was readily available and a lightweight building material for medium spans was required. It was accepted that wood, in contrast to solid construction, was organic and hence not everlasting (fungal attack, rot, fire). For these reasons timber engineering has never seriously rivalled stereotomic solid construction nor superseded it.

Only after industrialised steel building technology was well established were questions raised about the hitherto undisputed tectonic principles of Western architecture. While in the case of solid construction the massiveness of the earth material finds its architectural expression in the archaic, and occasionally monumental character of stereotomy, the almost complete resolving of mass and massiveness (so-called sublimation) into the barely tangible skeleton or lattice framework of an ethereal phantom volume – the abstract Cartesian grid of a filigree construction – is drawn in space.<sup>1</sup>

### Construction archetypes

In 1964 Sigfried Giedion was still maintaining that the issue of the origin of architecture was “very complex”, as he writes in his book *The Eternal Present. A Contribution to Constancy and Change*. This is why – despite the tempting title – he does not explore this matter in detail.<sup>2</sup> Instead, he confines himself to presenting the principal evolution, the content of which is backed up by later

research. This evolution, in essence, extends from the simplest round or oval huts to rectangular shelters. According to Giedion, “this regular rectangular house which has remained even to this day the standard form for a dwelling, had evolved only after centuries of experimentation with innumerable variants.” His underlying weighting of this can be plainly heard.<sup>3</sup> The rejection of round buildings in the course of the evolution of civilisation may well have been for primarily practical reasons – rectangular buildings can be more readily, i.e., more economically, subdivided and extended, and are easier to group together into settlements. The triumph of the rectangular building coincides with the onset of the establishment of permanent settlements; compact settlement forms are, at best, of only minor importance to nomadic peoples.

At the dawn of history, whether a building was rounded or angular was not only a question of practical needs but also an expression of spiritual ideals. According to Norberg-Schulz in the earliest cultures it is impossible “to distinguish between the practical and the religious (magical)”.<sup>4</sup> The architectural forms and elements at this stage have both practical and symbolic significance – an interpretation that lives on in the tepees of the North American Indians and the yurts of nomadic Asian tribes. For their occupants these portable one-room homes symbolise the entire cosmos and their interior layout follows ancient rules that prescribe a certain place for every object and every occupant.

At this point, however, it is not the evolution of human shelters that we wish to place in the foreground but rather the characterisation of the two archetypal forms of construction – filigree construction<sup>5</sup> and solid construction. But here, too, the transition from a nomadic to a sedentary lifestyle played a crucial role. If we assume that the early, ephemeral shelters were filigree constructions, i.e., lightweight, frame-like constructions, then the Mesopotamian courtyard house of c. 2500 BC is the first pioneering example of a shelter in solid construction. The historical development is reflected in the terminology: only with the development of permanent settlements do we first speak of architecture.<sup>6</sup> The Greek word *tekton* (carpenter) – whom we shall take as representing filigree construction – later led to the word *architekton*, our master builder, the architect.<sup>7</sup> Nevertheless, filigree construction should not be regarded merely as the forerunner of solid construction, as having lost its justification in the meantime. For in the end the construction systems depend on which natural resources are available locally and what importance is granted to the durability of a structure. Accordingly, the two archetypal construction systems are embodied differently yet equally in filigree construction and solid construction.

The first filigree constructions were variations on lightweight, initially wall-less shelters. In terms of their construction these consisted of a framework of branches, rods or bones covered with a protective roof of leaves, animal skins or woven mats. According to Hans Soeder we can distinguish between three different types of house: “Round domed structures (like those of Euro-African hunter cultures), the round tepee-type houses or conical tents of the Arctic and Antarctic regions, and – in regions with a hot or temperate climate – rectangular, inclined windbreaks”.<sup>8</sup> Besides the climatic conditions, the first shelters were characterised by the local availability of organic or animal-based materials. This is an assumption because, naturally, no corresponding remains have been found. Gradually, inorganic materials started to be employed for housebuilding as well – in a sense the first optimisation attempts. They were more durable, could withstand the weather better and presupposed a high level of cultural development. One such optimisation is, for example, the covering of a framework of rods with cob.

The term “filigree construction” refers directly to the way in which these forms of construction are put together. Since the 17th century the noun “filigree” (alternative spelling “filagree”) has denoted an ornamental work of fine (usually gold or silver) wire, twisted, plaited and soldered into a delicate openwork design. This word is a variation on “filigreen”, itself a variation of “filigrane”, derived from the Latin words *filum* (thread) and *granum* (seed),<sup>9</sup> from which we can infer the roughness of the metal surfaces. A filigree construction is thus a structure of slender members, a weave of straight or rodlike elements assembled to form a planar or spatial lattice in which the loadbearing and separating functions are fulfilled by different elements. But this static framework contains many “voids”, and to create an architecturally defined space we need to carry out one further step – to close this open framework or – according to Semper – to “clothe” it. The relationship between the interior and exterior of a building is thus achieved via secondary elements and not by the loadbearing structure itself. Openings appropriate to the system are consequently structural openings, the size of which is matched to the divisibility of the framework. The reference to Semper is therefore also interesting because in his book *Der Stil*, he designates textile art as an “original art”, the earliest of the four “original techniques” from which he derives his four elements of architecture. He therefore describes the tectonic principle of filigree construction – weaving, knotting and braiding – as the earliest of mankind’s skills.<sup>10</sup>

Prime features of solid construction are, as the term suggests, heaviness and compactness, in contrast to filigree construction. Its primary element is a massive, three-dimensional wall made up of layers of stones or modular prefabricated materials, or by casting in a mould

a material that solidifies upon drying. The jointing principle of solid construction could be described then by means of the techniques of casting and layering. The latter also results from the importance of the architectural theory equivalent of solid construction – stereotomy, the art of cutting stone into measured forms such that in the ideal case the simple layering of dressed stones and the pull of gravity are sufficient for the stability of the building, without the use of any additional media such as mortar etc. It becomes clear from this that solid constructions can only accommodate compressive forces and – unlike filigree constructions – cannot handle tensile forces. One example of the principle of “dry walling”, loaded exclusively in compression, is provided by the all-stone buildings of the “Village des Bories” (borie = dry-stone hut) in the French town of Gordes, with their self-supporting pyramidal roofs.<sup>11</sup>

In solid construction the erection of walls creates interior spaces directly because the loadbearing and enclosing functions are identical. Consequently, the extent of the structural shell often corresponds to that of the final construction, with secondary elements being, in principle, superfluous. The sizes of openings in the walls are limited because these weaken the loadbearing behaviour of the wall. This type of construction is founded on the individual cell and groups of rooms are created by adding cells together or subdividing individual cells. As in the simplest case all walls have loadbearing and separating functions, there is no structural hierarchy. All parts tend to be of equal importance.

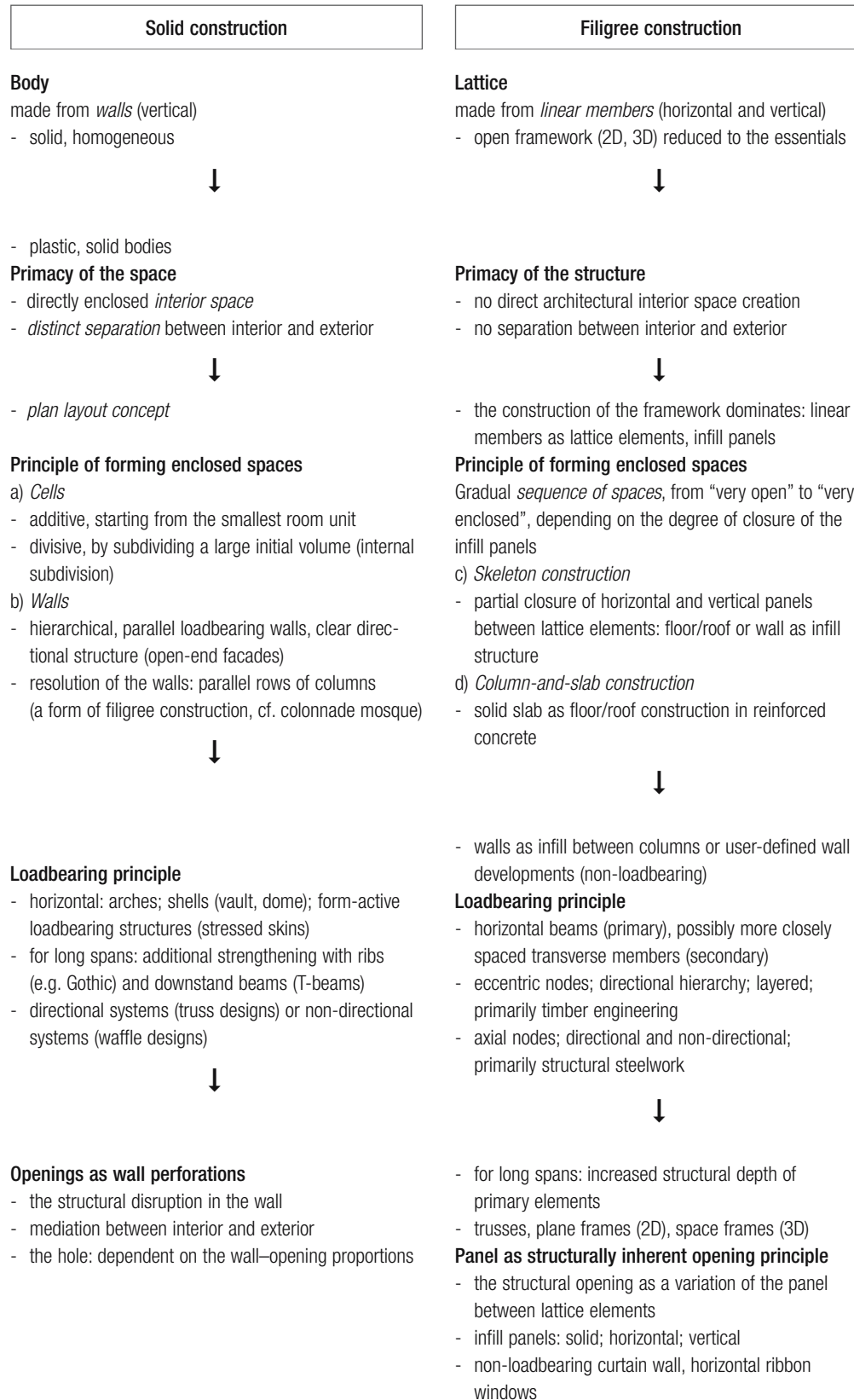
This pair of concepts – solid construction (stereotomy) and filigree construction (tectonics) – designates the two archetypal construction systems. All the subsequent forms of construction can be derived from these two, even though their origins are still considerably blurred. Today, the array of architectural design forms is less clearly defined than ever before. Everything is feasible, everything is available. From a technical viewpoint at least there seem to be no boundaries anymore. The often new and surprising utilisation of high-tech materials and complex system components leads to an ever greater blurring of the original boundaries between construction systems. Solid and filigree construction in their true character have long since been unable to do justice to new demands and new options; composite forms prevail.

The distinction between solid and filigree construction as pure constructions is interesting insofar as they illustrate the “how” and “why” of building. They provide a means of analysis which permits comparisons between contemporary systems and also renders their historical evolution legible. This whets our appetite for the specific and simultaneously creates their boundaries.

## Notes

- <sup>1</sup> For example, the structures of the World Expositions of the 19th century, like the Crystal Palace in London or the Eiffel Tower in Paris. For details of the latter, see Roland Barthes, *The Eiffel Tower, and Other Mythologies*, transl. Richard Howard, New York, c. 1979.
- <sup>2</sup> Sigfried Giedion: *The Eternal Present. A Contribution to Constancy and Change*. The National Gallery of Art, Washington, 1964, p. 177.
- <sup>3</sup> *ibid.*, p. 177.
- <sup>4</sup> Christian Norberg-Schulz: *Logik der Baukunst (Bauwelt Fundamente 15)*, Gütersloh, Berlin, Munich, 1968, p. 109.
- <sup>5</sup> Of all the known terms, filigree construction appears to be the most precise and most comprehensive in order to study the essence of the construction tectonics principle. In contrast to this, the term skeleton (or frame) construction, frequently regarded as a synonym, seems to draw unavoidable parallels with plant or animal structures and hence a reference to an “organic” architectural interpretation, which as such has nothing to do with the form of construction. The term lightweight construction is similarly restrictive because not only does it – unreasonably – tend to reduce filigree construction to a form of building “light in weight” but also – indirectly – tends to favour certain materials at the expense of others.
- <sup>6</sup> Markus Dröge, Raimund Holubek: “Der rechte Winkel. Das Einsetzen des rektangulären Bauprinzips”; in: Andreas Brandt: *Elementare Bauten. Zur Theorie des Archetypus, Urformen weltweiten, elementaren Bauens in einer Zusammenschau*, Darmstadt, 1997, pp. 499–508, p. 501.
- <sup>7</sup> Kenneth Frampton: *Studies in Tectonic Culture*, Cambridge, 1995, p. 3.
- <sup>8</sup> Hans Soeder: *Urformen der abendländischen Baukunst in Italien und dem Alpenraum (Du-Mont Documents)*, Cologne, 1964, p. 19.
- <sup>9</sup> Oxford English Dictionary.
- <sup>10</sup> cf. Gottfried Semper: *Der Stil in den technischen und tectonischen Künsten oder praktische Ästhetik*, vol. 1: *Die textile Kunst*, Frankfurt a. M., 1860, p. 13.
- <sup>11</sup> Werner Blaser: *Elementare Bauformen*, Düsseldorf, 1982, pp. 31–43.

Comparing the relationship between structure and space  
solid construction – filigree construction



# MATERIALS – MODULES

	Modules	Masonry	Concrete	Timber	Steel	Insulation	Glass
Introduction	<a href="#">The importance of the material</a>	<a href="#">The pathos of masonry</a>	<a href="#">On the metaphysics of exposed concrete</a>	<a href="#">Wood: indifferent, synthetic, abstract – plastic</a>	<a href="#">Why steel?</a>	<a href="#">The “invisible” building material</a>	<a href="#">Glass – crystalline, amorphous</a>
Properties of materials	<a href="#">The perception of architectural space</a> <a href="#">The longevity of materials</a>	<a href="#">The materials Swiss clay bricks and blocks</a>	<a href="#">The materials The concreting process</a> <a href="#">10 rules for the production of concrete</a> <a href="#">Exposed concrete surfaces</a>	<a href="#">The materials Wood-based products – Overview</a> <a href="#">Wood-based products Layered products</a> <a href="#">Wood-based products Particleboards</a> <a href="#">Wood-based products Fibreboards</a> <a href="#">Important panel and prefabricated systems – Overview</a> <a href="#">Panel construction – Current developments</a>	<a href="#">Sections – forms and applications</a> <a href="#">Fire protection</a> <a href="#">Potential applications for structural steelwork</a>	<a href="#">Transparent thermal insulation</a> <a href="#">Thermal insulation materials and their applications</a>	
Systems		<a href="#">Masonry terminology</a> <a href="#">Design and construction with internal Masonry bonds</a> <a href="#">Tying and reinforcing double-leaf masonry walls</a>	<a href="#">Floor supports, exposed concrete with internal insulation</a> <a href="#">The fixing of heavy external cladding (concrete)</a> <a href="#">The fixing of heavy external cladding (stone)</a> <a href="#">Chart for establishing preliminary size of reinforced concrete slabs</a>	<a href="#">Timber construction systems – Overview</a> <a href="#">Platform frame construction – Construction principle</a> <a href="#">Chart for establishing preliminary size of timber beams</a>	<a href="#">Steel connections – A selection</a> <a href="#">Structures – frame with cantilevering beams</a> <a href="#">Structures – frame with continuous columns</a> <a href="#">Structures – two-way frame</a> <a href="#">Chart for establishing preliminary size of steel beams</a>	<a href="#">Thermal insulation systems – Overview</a>	
Systems in architecture		<a href="#">The skill of masonry construction</a> <a href="#">Types of construction</a> <a href="#">Prefabrication</a>	<a href="#">Linear structural members</a> <a href="#">Systems with linear members</a> <a href="#">Planar structural members</a> <a href="#">Systems with planar structural members</a>		<a href="#">Folding and bending Frames</a> <a href="#">Girder, lattice beam and facade</a> <a href="#">Space frames</a> <a href="#">Diamonds and diagonals</a> <a href="#">Canopy structures</a>		
Examples	<a href="#">Plastic</a>			<a href="#">Conversion of a trunk in traditional Japanese timber building culture</a> <a href="#">The threads of the net</a>			



## The importance of the material

Andrea Deplazes

For me, designing and constructing is the same thing. I like the idea that form is the result of construction; and material, well, that's something finite. Nevertheless, confining myself to this formula would be a mechanistic reduction because the shape of the form, deliberate or not, bears – beyond its material or constructional component – information, an intent. Yes, even the absence of intent is information (which has been sufficiently well demonstrated by functionalism). Consequently, the separation between designing and constructing made by the teachers is a didactic strategy to create thematic focal points, which can be explained beautifully by the metaphor of the potter and his wheel. The potter models a vessel with both hands by applying force from outside with one hand and from inside with the other hand (in opposite directions) in order to reshape the mass of clay into a hollow space. A “vessel that holds space” is produced. At best these forces complement each other, or at least affect each other, as a result of which the didactics sometimes becomes the methodology of the work and, moreover, becomes the design process as such. This process advances from both directions: from outside in the classical way from the urbane to the architectural project, and from inside by means of the spatial and constructional fabric, the tectonics – and both lead from the abstract to the concrete.

Between them lies the architectural matter. It stands as the boundary and transition zone between the inside and the outside and unites in itself all architectural, cultural and atmospheric factors, which are broadcast into the space. This is the paradox of architecture: although “space” is its first and highest objective, architecture occupies itself with “non-space”, with the material limiting the space, which influences the space outwards as well as inwards. Architecture obtains its *memoria*, its spatial power and its character from this material. As Martin Heidegger expresses it, “The boundary is not the point where something ends but, as the Greeks recognised, the point at which something begins its existence.” From this point of view architects are metaphysicists who would not exist without the physicists (technicians, engineers, designers), or even more like Janus with his two faces on one head: the presence of space (antimatter) and the presence of matter are mutually interlinked and influence each other unceasingly.

Conceiving and designing space or space complexes in advance or reconstructing it/them subsequently are only possible when I know the conditions of realisation and can master them as well.

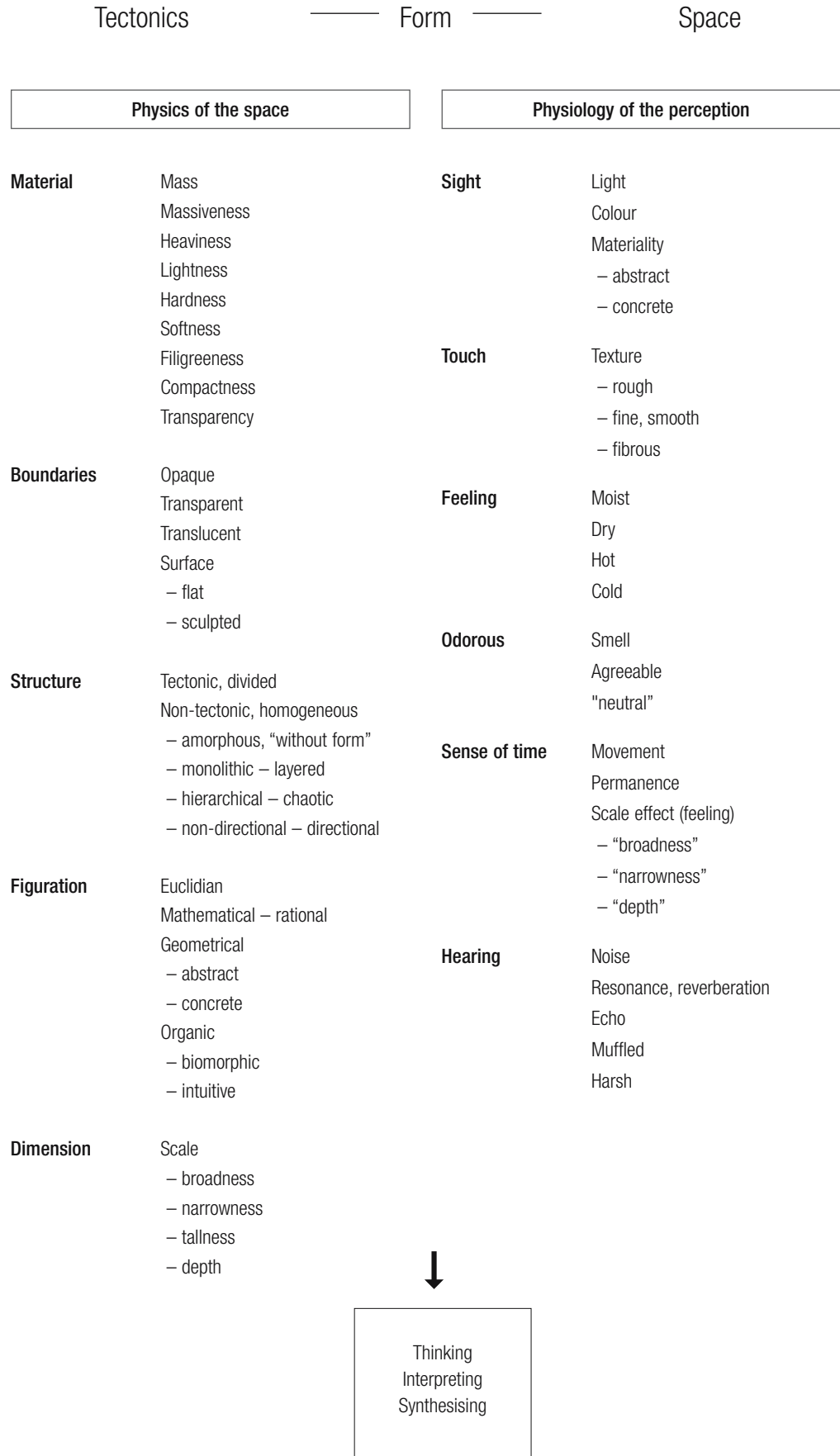
Consequently, the architect is a “professional dilettante”, a kind of alchemist who tries to generate a complex whole, a synthesis from most diverse conditions and requirements of dissimilar priority which have to be appraised specifically every single time.

The character of the architectural space therefore depends on *how* things are done and for that reason it is determined by the technical realisation and by the structural composition of the substances and building materials used. In this respect a remark by Manfred Sack is very instructive: “Again and again there is the sensuality of the material – how it feels, what it looks like: does it look dull, does it shimmer or sparkle? Its smell. Is it hard or soft, flexible, cold or warm, smooth or rough? What colour is it and which structures does it reveal on its surface?”

Sack observes that architectural space is perceptible first and foremost in a physical-sensual way. By striding through it and hearing the echo of my steps I estimate and sound out its dimensions in advance. Later, these dimensions are confirmed by the duration of my striding and the tone of the echo gives me a feeling of the haptic properties of the boundaries to the space, which can be decoded by touching the surfaces of the walls and, perhaps, by the smell of the room too, originating from different things. So only by means of these sensual experiences do I realise what I later believe I can comprehend with one single glance. Vision is obviously something like a pictorial memory of earlier physical-sensual experiences which responds to surface stimuli. I also like the idea of “which structures does it reveal on its surface?” Under the surface lies a hidden secret, which means the surface depends on a concealed structure which existed before the surface, which created the surface, and in a certain way the surface is a plane imprint of this structure. In architecture the line and the two-dimensional area do not exist – they are mathematical abstractions. Architecture is always three-dimensional – even in a micro-thin layer of paint – and thus plastic and material. As an example we can consider the distinction between colour as colouring material and colour as a certain shade of colour, keeping in mind that the latter may be used to generate the impression of two-dimensional areas. This notion makes it easy for me to understand construction not only as a question of technique or technology, but as *tekhne* (Greek: art, craft), as the urge to create, which needs the presence of an artistic or creative, human expression of will or intent, which is the starting point for the creation of every artefact. “Understanding” construction means to grasp it intellectually after grasping it materially, with all our senses.

Extract from introductory lecture, ETH Zurich, 15 January 1999

The perception of architectural space





## The longevity of materials

Usage	Years	Usage	Years
<b>1. Floor coverings</b>		<b>6. Sanitary fittings</b>	
1.1 Textile floor coverings (needle felt + carpeting) Price category 1, medium quality, laid, SFr 30–65/m <sup>2</sup>	10	Bath, shower tray, cast, steel	50
Price category 2, hard-wearing quality, laid, SFr 66–140/m <sup>2</sup>	12	Bath, shower tray, enamel	20
Natural fibre carpet (sisal-coconut), laid, SFr 80–110/m <sup>2</sup>	12	Bath, shower tray, acrylic	40
1.2 Ceramic floor coverings		Shower tray, ceramic	50
Plain clay tiles	25	Lavatory, pan without cistern, bidet	50
Ceramic tiles	40	“Closomat” (shower-toilet)	20
Hard-fired bricks, unglazed	50	Mirror cabinet, plastic	15
Reconstituted stone flags	50	Mirror cabinet, aluminium	25
Slate flags	30	Fittings for kitchen, bath, shower or WC	20
Granite flags	50	Washing machine and tumble drier in tenant's flat	15
1.3 Other floor coverings		Hot-water boiler in tenant's flat	15
Seamless cushioned vinyl	20	<b>7. Heating, flue, heat recovery system</b>	
Plastic floor coverings (inlaid, PVC)	25	Thermostat radiator valves	15
Linoleum	25	Standard radiator valves	20
Cork	25	Electronic heat and flow counter	15
Parquet flooring	40	Mechanical evaporimeter	15
		Electronic evaporimeter	30
<b>2. Plastering, painting and wallpapering</b>		Plant for hot-air flue/heat recovery	20
Plastic grit, Chloster-style plaster	10	Fan for smoke extraction	20
Dispersion paint, matt paint	10	Log-burning stove (with flue)	25
Blanc fixe, whitened	10		
Woodwork (windows, doors) painted with oil-based or synthetic paint	20	<b>8. Sunshading</b>	
Radiators, painted with synthetic paint	20	Sunblind, synthetic fabric	12
Wallpaper, hard-wearing, very good quality	15	Louvres, plastic	15
		Louvres, metal	25
<b>3. Wood and plastic materials</b>		Plastic roller shutter	20
Wood panelling, glazed	20	Wooden roller shutter	25
Wood panelling, untreated	40	Metal roller shutter	30
Skirting boards, plastic	20	Operating cords for sunblinds and roller shutters	7
Skirting boards, beech or oak	40	<b>9. Locks</b>	
		Automatic door locking system	20
<b>4. Ceramic and stone tiles</b>		Lock to apartment door	20
Ceramic tiles in wet areas	40	Lock to internal door	40
Stone tiles in wet areas	40	<b>10. Reduction in longevity for commercial use</b>	
<b>5. Kitchen fittings</b>		Manufacturing	25%
Electric hob, conventional	12	Retail	25%
Ceramic hob	15	Restaurants	50%
Cooker, stove and oven, incl. baking sheet	20	Offices	20%
Microwave	15		
Refrigerator	12		
Freezer (upright or chest)	15		
Dishwasher	15		
Extractor, fan	15		

**Source**  
Schweizerische Vereinigung kantonaler Grundstückbewertungsexperten  
(Swiss Association of Cantonal Real Estate Valuation Experts) SVKG+SEK/SVIT:  
“Schätzerhandbuch, Bewertung von Immobilien”, 2000.

## Plastic

Roland Barthes

Although the names of some plastics (polystyrene, polyvinyl, polyethylene) might remind us more of a one-eyed Greek shepherd, plastic is essentially an alchemistic substance. Recently, there was an exhibition dedicated to the whole gamut of plastic products. At the entrance the visitors waited patiently in a long queue to view the magic process *par excellence*, the remodelling of matter. An ultimate machine, an elongated arrangement with a large number of tubes (an ideal form to bear witness to the mysteriousness of a long journey), easily turned out glossy, fluted bowls from a pile of greenish crystals. On one side the tellurium material – on the other side the perfect artefact. And between the two extremes: nothing. Nothing but a journey, supervised by an employee wearing a peaked cap – half god, half robot.

Plastic is not so much a substance as the notion of infinite remodelling. It is, like its ordinary name indicates, the omnipresence that has been rendered visible. And that is exactly why it is a truly miraculous substance – the miracle being a sudden conversion of nature every time. And plastic is infused with this astonishment: it is not so much an item as the trace of a movement.

Since this movement here is almost infinite and converts the original crystals into a quantity of ever more surprising objects, plastic is basically a spectacle that has to be deciphered: the spectacle of its final products. Looking at all the different final shapes (a suitcase, a brush, a car body, a toy, fabrics, tubes, bowls or plastic film), the matter presents itself unceasingly as a picture puzzle in the mind of the observer. This is due to the total versatility of plastic: we can use it to form buckets as well as pieces of jewellery. That's why we are constantly astonished by and are constantly dreaming of the proliferation of the material, in view of the connections we are amazed to discover between the single source and the multiplicity of its effects. It is a happy astonishment since mankind measures its power by the range of possible conversions, and plastic bestows on us the euphoria of an enchanting glide through nature.

But there is a price to be paid for this, and that is that plastic, sublimated as a movement, hardly exists as a substance. Its constitution is negative: it is neither hard nor deep. In spite of its usefulness it has to be content with a neutral quality of substance: resistance – a condition that demands infallibility. It is not fully accepted within the order of the "big" substances: lost between the elasticity of rubber and the hardness of metal it does not attain one of the true products of the mineral order: foam, fibre, plates. It is a congealed substance. Regardless of its particular state it keeps its flaky appearance, something vague, creamy and solidified – an inability to attain the triumphant smoothness of nature. But above all it gives itself away by the noise it makes, that hollow, weak tone. Its sound destroys it; just like its colours, for it seems only

to be able to retain the markedly chemical ones: yellow, red, green, and it keeps only the aggressive side of them. It uses them just like a name which is only in the position to show shades of colours.

The popularity of plastic bears witness to a development regarding the myth of imitation. As is well known, imitations are – from the historical point of view – a middle-class tradition (the first clothing imitations date from the early years of capitalism). Up to now, however, imitation was always pretentious, was part of the world of simulation, not application. Imitation aims to reproduce cheaply the most precious substances: precious stones, silk, feathers, fur, silver – all the world's luxurious glory. Plastic does without this, it is a household substance. It is the first magic matter that is ready for ordinariness, and it is ready because it is precisely this ordinariness that is its triumphant reason for existence. For the first time the artificial aims at the ordinary, not the extraordinary. At the same time the ancient function of nature has been modified: nature is no longer the idea, the pure substance that has to be rediscovered or has to be imitated; an artificial substance, more abundant than all the world's deposits of raw materials, plastic replaces them all, even determines the invention of shapes. A luxury item is always linked with the earth and always reminds us in an especially precious way of its mineral or animal origin, of the natural subject of which it is only a topical image. Plastic exists for being used. Only in very rare cases are items invented just for the pleasure of using plastic. The hierarchy of substances has been destroyed – a single one replaces them all. The whole world could be plasticised and even living matter itself – for it seems that plastic aortas are already being produced.

"Plastic" (1957)  
Excerpt from: Roland Barthes, transl. after: Mythologies, Paris, 1957.

## The pathos of masonry

Ákos Moravánszky



Fig. 1: The intermeshing of nature and the built environment in the image of ruined masonry  
Mario Ricci: "Capriccio" style with ancient ruins, pyramid and decoration

### Layers

Pathos is "in" – despite its bad reputation for being "hollow", a reputation that, shadowlike, accompanies every emotional expression. Region, identity, space – terms that formerly were used with care – now take on an excessive force, probably in order to become points of reference in a rather uninteresting situation, or just to cause a sensation. And in architecture what could be more emotional than masonry? Where masonry is concerned we think of a figure with characteristics that tie the masonry to a certain place; characteristics like material, colour, weight, permanence. It is the artistic characteristic of masonry that provides the ethical and aesthetic resonance that legitimises many things. A wall with a coat of plaster or render is not necessarily masonry, regardless of how well it is built and coated. Masonry is "a structure that remains visible in its surface and works through it"<sup>1</sup> – regardless of the material used: natural stone or man-made bricks or blocks.

The relationship between nature and the built environment, as it was represented in the ruined masonry of the late Renaissance "Capriccio" genre, was intended to demonstrate the vanity of building and the corrupting power of death. In the end nature is waiting to take revenge for its violation "as if the artistic shaping was only an act of violence of the spirit".<sup>2</sup>

But the connection between masonry and nature can also be looked at from a less melancholy standpoint. Rudolf Schwarz described in his book *Von der Bebauung der Erde* (Of the Development of the Earth), published in 1949, the material structure of the Earth as masonry built layer by layer, starting with the seam "made from wafer-thin membranes of the universal material", from precipitation and sedimentation.<sup>3</sup>

Viewed by an unprejudiced onlooker the masonry itself should appear as a rather commonplace product when compared with the complex structures of high-tech industry. However, we sense the pathos quite clearly when masonry becomes the symbol for the building of the Earth, for the creation – or for homeliness as a contrast to modernisation. Brick-effect wallpaper, which decorates many basement night-clubs and discotheques, shows the sentimental meaning that attaches to masonry.

There are at least two debates about masonry: one about its surface as a medium for meaning and a boundary, the other about its mass as a product of manual work. Although both debates overlap constantly, I shall deal with them separately here.

### The lightness: the wall, the art

No other theoretical study has formulated more new ideas regarding the double identity of masonry (and inspired a lot more) than the two volumes of Gottfried Semper's *Style in the Technical and Tectonic Arts: or, Practical Aesthetics*. The basis of Semper's system is the typology of human production methods: weaving, pottery, tectonics (construction in timber) and stereotomy (construction in stone). These four types of production correspond to the four original elements of architecture: wall, stove, roof and substructure (earth fill, terrace). What is important here is the ontological dimension of this breakdown: those four elements are not formally defined, but rather are aspects of human existence. It is remarkable to witness the flexibility that the seemingly rigid breakdown of architectural techniques allows with regard to the determination of its components. Even a mere sketch would be beyond the scope of this article. At this point it is important to establish that masonry artefacts could be products of the two "original techniques" – weaving and stereotomy. Tectonics, "the art of joining rigid, linear parts"<sup>4</sup> (an example of this is the roof framework), is alien to masonry.

Semper's observations were influenced by the remains of walls discovered during excavations in the Assyrian capital Nineveh, which he saw in 1849 when he visited the Louvre. In his opinion these masonry fragments confirmed his clothing theory: the wall as boundary is the primary element, the wall as a load-carrying element in the construction is of secondary importance. The stones forming the surface of the Assyrian masonry (the remains at least) were assembled horizontally on the ground, painted, enamelled, baked and only then erected. In his manuscript *Vergleichende Baulehre* (Comparative Building Method) Semper wrote: "It is obvious that clay brick building, although already well established in Assyrian times, was not focused on construction. Its ornamentation was not a product of its construction but was borrowed from other materials."<sup>5</sup> This theory still provokes – and inspires – us today because of its apparent reversal of



Fig. 2: The wall as a boundary element is the primary function, the masonry as loadbearing element the secondary function.  
Nineveh, excavations of town walls between 1899 and 1917

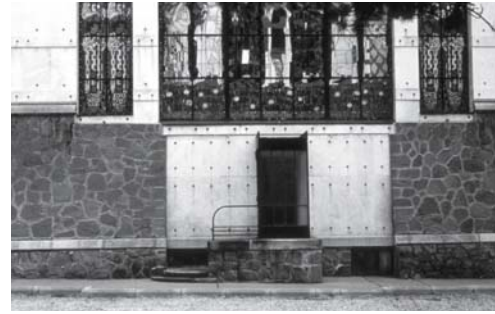


Fig. 4: Stereotomy and marble-clad masonry  
Otto Wagner: Steinhof Church, Vienna (A), 1907



Fig. 3: Lightweight rendered facade over heavyweight masonry  
Jože Plečnik: Sacred Heart of Jesus Church, Prague (CZ), 1939

cause and effect. It is the appearance of the masonry, its wickerwork-like surface, that determined the technique, and not vice versa. Semper states that the knot is “the oldest technical symbol and . . . the expression of the earliest cosmogonic ideas”,<sup>6</sup> i.e. the prime motif of human *tekhnē*, because a structural necessity (the connection of two elements) becomes an aesthetic, meaningful image. The effect of an oriental carpet is based on the rhythmic repetition of its knots; the whole surface is processed uniformly. Art is always a kind of wickerwork: a painter – no matter if he or she is a landscape painter of the 19th century or an “action painter” like Jackson Pollock working in the 1950s – works uniformly over the whole of the canvas, instead of placing coloured details onto a white surface. Only this calligraphy allows us to experience masonry. “The mesh of joints that covers everything, lends . . . the surface not only colour and life in a general way but stamps a sharply defined scale onto it and thereby connects it directly with the imagination of human beings”, wrote Fritz Schumacher in 1920.<sup>7</sup>

Although Semper’s theory regarding the textile origin of the wall has its roots in historicism and has been misunderstood and criticised by many representatives of the modern theory of material authenticity, it still influenced the aesthetics of masonry in the 20th century. Naturally, this fact cannot always be attributed to the direct influence of Semper’s theory. But in the architecture of Vienna the acceptance of Semper’s ideas is unmistakable and even today architects like Boris Podrecca still feel bound by this tradition. Above all, it was the group led by Otto Wagner who interpreted Semper’s theses early on in an innovative way. The facades of the Steinhof Church (1905–07) and the Post Office Savings Bank (1904–06) in Vienna are structured according to Semper’s distinction between lower, stereotomic and upper, textile bays.

A pupil of Wagner, the Slovene Jože Plečnik interpreted these themes in a new way, as can be seen in his works in Vienna, Prague, and Ljubljana. “New” here means that he integrated his knowledge about ancient forms with virtuoso competence: distortions, alienations, borrowed

and invented elements balance each other. The facade of the Sacred Heart of Jesus Church in Prague, built (1932–39) according to Plečnik’s plans, is clearly divided into lower, brick-faced and upper, white-rendered zones with granite blocks projecting from the dark brick facing. The facade of the library of the university of Ljubljana (1936–41) is also a membrane of stone and brick. In this case the combination probably symbolises Slovenia’s twofold bond with Germanic and Mediterranean building cultures.

Louis Henry Sullivan compared the effect of facades built with bricks made from coarse-grained clay to the soft sheen of old Anatolian carpets: “a texture giving innumerable highlights and shadows, and a mosslike appearance”.<sup>8</sup>



Fig. 5: A weave of natural stone and clay bricks  
Jože Plečnik: University Library, Ljubljana (SLO), 1941



As its name alone indicates, Frank Lloyd Wright's invention, "textile block" construction, tries to achieve the fabric-like effect of precast blocks made of lightweight concrete. In 1932 he wrote an article in which – distancing himself from the sculptor-architects – he called himself a "weaver" when describing the facades of his buildings in California, e.g. La Miniatura or Storer Residence (1923): "The blocks began to reach the sunlight and to crawl up between the eucalyptus trees. The 'weaver' dreamed of their impression. They became visions of a new architecture for a new life... The standardisation indeed was the soul of the machine and here the architect used it as a principle and 'knitted' with it. Yes, he crocheted a free wall fabric that bore a great variety of architectural beauty...



**Fig. 6: Decorated brickwork**  
Louis Henry Sullivan: National Farmers' Bank, Owatonna (USA), 1908

Palladio! Bramante! Sansovino! Sculptors, all of them! But there was I – the 'weaver'."<sup>9</sup>

Ancient and Byzantine masonry and the religious architecture of the Balkans show in many different examples how the surface of the masonry becomes a robe when decorations are used instead of a structural configuration with pilaster or column orders, e.g. by inserting glazed ceramic pins or small stones into the mortar joints. These buildings manage without a facade formulated with the aid of openings and sculptural em-



**Fig. 7: Wright's second "textile block" house in Los Angeles**  
Frank Lloyd Wright: Storer Residence, Hollywood (USA), 1923

bellishments and instead favour the homogeneous impression of the masonry fabric. In the late 1950s the Greek architect Dimitris Pikionis designed the external works to a small Byzantine church on Philopappos hill,

near the Acropolis in Athens. His plans included a footpath, an entrance gate and other small structures. Here, Dimitris worked, even more than Wright, as a "weaver", knitting together landscape, existing and new elements to form a colourful story.

Carlo Scarpa created a similar work with historic wall fragments and new layers at the Castelvecchio in Verona. Dominikus Böhm, Rudolf Schwarz and Heinz Bienefeld also used decorative masonry "clothing", often with inclined courses, brick-on-edge courses and lintels in order to illustrate that the shell is independent of the foundation. The facades to the Markus Church in Björkhagen (1956–60) designed by Sigurd Lewerentz demonstrate yet another strategy: the horizontal bed joints are as high as the masonry courses themselves. For this reason the brick wall exudes a "calm" expression, as if it was made of a completely different material to that used for the construction of, for example, the Monadnock Building in Chicago – an ancient skyscraper which, in the era of frame construction, was built in brickwork at the request of the building owner. In this building the enormous compressive load could be visually expressed.

The textile skin corresponds to the idea of the "decorated shed" propagated by the American architect Robert Venturi. The Venturi practice, an imaginative workshop of



**Fig. 8: The interweaving of the structure and its surroundings**  
Dimitris Pikionis: Landscaping and refurbishment of St Dimitris Lumbardiaris Church, Philopappos hill, Athens (GR), 1957

post-Modernism, strives for a rational (according to American billboard culture) separation between the building and the medium conveying the meaning. The facades of many buildings designed by this practice employ large-format panels covered with a floral pattern that leave a naive, ironical impression. The decorative brick facades of the Texan architectural practice of Cesar Pelli also underline that the outer skin is a shell – like almost all masonry, at least since the oil crisis, when the new thermal insulation regulations made solid masonry quite uneconomic.

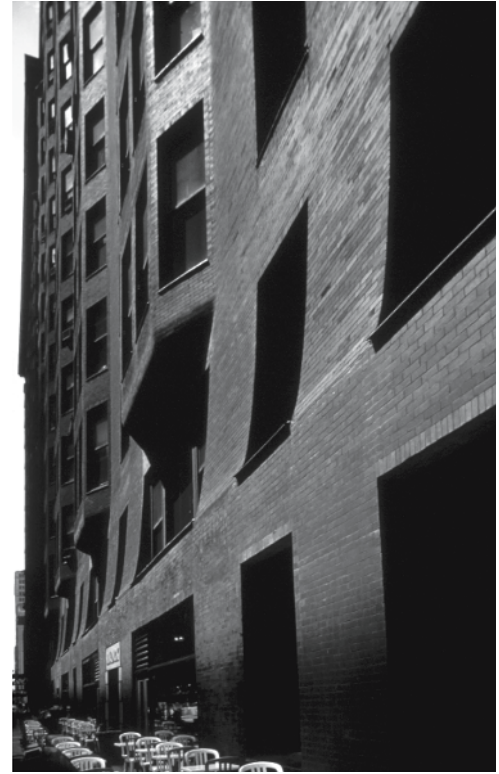
In the works of SITE, the architecture and environmental arts organisation led by James Wines, masonry as a kind of shell becomes a symbol for the consumer society; its character as a false, glued-on decorative layer



**Fig. 9: Historical wall fragments, new layers**  
Carlo Scarpa: Reconstruction of the Castelvecchio,  
Verona (I), 1958–74



**Fig. 10: Bed joint widths approaching the  
height of an individual brick**  
Sigurd Lewerentz: Markus Church, Björkhagen near  
Stockholm (S), 1960



**Fig. 11: The world's tallest self-supporting brick facade**  
Burnham & Root: Monadnock Building, Chicago (USA), 1884–91, extension: Holabird  
and Roche, 1893

peeling away from the substrate was featured in several department store projects. Such preparatory work was obviously necessary in order to pave the way for dropping all moralising about clothing as an illusion, about masonry as a mask. In today's architecture the material authenticity of masonry is often perceived as a myth – in keeping with SITE ideals, just a bit less pithy. The Swisscom headquarters in Winterthur (1999) by Urs Burkhard and Adrian Meyer asks whether a facade system, a product of industrial technology and consisting of prefabricated masonry panels, still needs the pathos of manual skills, or – perhaps on closer inspection and thanks to the unusual precision and the joints between the panels – whether it comes closer to the modern ideal of brick as a material that has freed itself from manufacture (according to Ernst Neufert). The loadbearing structure of the apartment block in Baden designed by Urs Burkard and Adrian Meyer (2000) consists of the masonry of the facades, the concrete service tower and the in situ concrete floors. The distinctive floor edges allow for the stacking of the individual storeys, which is done by displacing the plain masonry panels and large window openings in successive storeys.





**Fig. 12: Brick wall as peel-off skin!**  
SITE: Peeling Project (Best department store),  
Richmond, Virginia (USA), 1971–72



**Fig. 13: Prefabricated brickwork panels**  
Urs Burkhard, Adrian Meyer: Swisscom head-  
quarters, Winterthur (CH), 1999



**Fig. 14: Colossal masonry wall**  
Giovanni Battista Piranesi: Masonry foundation to  
the Theatre vin Marellus in Rome

### Massiveness: the wall, the craft

In Semper's system of original techniques stereotomy is an ancient element. The weighty earth embankments and terraces do not have the anthropomorphic, organic traits of the other components of the building, but rather an inanimate, mineral quality that is, at best, rhythmically subdivided. Stereotomy works with materials "that, owing to their solid, dense, and homogenous state, render strong resistance to crushing and buckling, i.e. are of important retroactive consistency, and which through the removal of pieces from the bulk and working them into any form and bonding such regular pieces form a solid system, whereby the retroactive consistency is the most important principle of the construction."<sup>10</sup> The ancient function of stereotomy is the representation of the "solid ashlar masonry of the Earth", an artificial elevation that serves as a place of consecration where we can erect an altar. The symbol of stereotomic masonry is the "most primitive and simplest construction", the "grass-covered and, as such, fortified mound".<sup>11</sup> It is about hollow bodies, "cell structures" – Semper emphasises that the root of the word construct, *struere*, implies the filling in of hollow spaces.<sup>12</sup> Giovanni Battista Piranesi dedicated the four volumes of his *Antichità Romane* to the overwhelming effect of the colossal masonry walls of his "Carceri d'invenzione". Since then masonry architecture has been associated with the underground atmosphere of dungeons. This also correlates with the method of construction of the fortress. Masonry construction was in that sense originally the filling of the fortress walls; in contrast to wattling walls it meant heavy, physical labour that was definitely intended for strong male labourers, as opposed to the art of weaving and wattling.

In his book *Das Wesen des Neuzeitlichen Backsteinbaues* Fritz Schumacher actually speaks about two worlds of masonry, a Western and an Eastern model of masonry: "The main difference therein is that in contrast to our structural way of formation the superficial ornamentation is the focal point and depicts the brilliant achievement of the Islamic masonry culture. In the light of the carpet design fantasies of Eastern artists, this is no surprise".<sup>13</sup>

Correspondingly, in "structural", massive masonry the joints, the "weakest" element in the masonry, are also interpreted differently. In Semper's concept the network of joints is the image of the rhythmic rows of the knots of the carpets or wattling. Rudolf Schwarz, in his book quoted above, associates the joints with the cosmic process of the Earth's creation: "A superstructure has horizontal layers and continuous joints and vertical fibres. The joints form the layers and together they provide the structure. The joint is the spaceless place where one layer abutting another starts a third".<sup>14</sup>

The pathos of masonry as a consequence of honest craftsmanship in the service of a national ideology cries

out of every line of the book *Mauerwerk* (Masonry) by Werner Linde and Friedrich Tamms. "We have learned to master nature's powers but have lost our reverence for it," the authors claim in order to formulate their aims clearly; "The development of the masonry trade shows the



**Fig. 15: Rubble stone wall**  
Ancient Temple of Apollo, Delphi

way the entire culture will travel".<sup>15</sup> An aesthetic claim is not intended here but rather an indispensable cultivation of attitude. "When such an attitude is awoken again and fortified even in the humblest tradesman it will fill him with the true joy of labour; then the labourer and his work will be one again. And that is needed!"<sup>16</sup> Lindner and Tamms begin their narrative with the retaining walls of terraced vineyards along the Rhine to show the beginnings of "a power of form that advanced to the ultimate consummation" – which then collapsed in the 19th century. The "desire to return to the fundamentals of all good design" makes it important to compare good and bad examples of masonry with the proven "home defence" pattern of Paul Schultze-Naumburg's cultural works.

We can follow these arguments back to the idea of material truth. John Ruskin compounded in his various writings the demand for morality with aesthetic expression. In the American architecture of the late 19th century bulky masonry arose out of granite and brick as the first results of the search for a national building style that could be called "American", expressing traits of originality, raw power, or a bond with nature. The first influential examples in this direction in the United States are the buildings

of Henry Hobson Richardson such as Ames Gate House, North Easton (1880–81), and Allegheny County Courthouse, Pittsburgh (1883–88).

The modern conception of the true identity of material, the determining character of masonry, has increasingly suppressed Semper's clothing aesthetic. The question of why a brick facing is celebrated as material truth, but render is rejected as a deception, has not been put forward. One problem, however, was quickly recognised: the industrial mass production of bricks eliminated every individual irregularity of the masonry that had always been a characteristic of "honest" handiwork. Architects contemplated (as Ruskin did earlier) "the quest for exactness" as "the source of evil", as the cause behind monotony and tediousness in masonry architecture at the turn of the century. Justice and honesty vis-à-vis the material were nothing more than the code-words of those who intended to conceal nostalgia.

"Brick boredom" was recognised around the turn of the century as a consequence of technical perfection, the quest for purity. Many architects proposed the subsequent manual working of masonry. The advantage of this method according to Walter Curt Behrendt is that the "original workmanship" would be preserved which would guarantee the finished building a certain freshness. According to Behrendt the brickwork gains an artistic expressiveness when its surface is processed afterwards. The production of brick profiles on site – a proposal that suggests sculptors on scaffolding chiselling ornamentation into the facade – means that the building process should not be rationalised and industrialised but rather should remain an individual, creative act. In this sense the brick facades of the Ledigenheim in Munich (1925–27) by Theodor Fischer were "individualised" with sculptured figures.

Fritz Schumacher, on the other hand, expected the answer to come from the material itself: for him the brick was an individual, a teacher who – unlike rendered and plastered forms that willingly accommodate "all lustful instincts of inability and arrogance" – does not allow immature whims to be given shape. "It is not very easy to get it [brick] to do just what you want it to, its earnest countenance is averse to prostitution, and so it has an inherent natural barrier against the effervescence of misconstrued or hackneyed entrepreneurial fantasies."<sup>17</sup>

Schumacher's buildings are today being investigated primarily from the perspective of the turn-of-the-century reform movement, and that is the reason why his early decorative brick facades especially are reproduced, although his school buildings constructed between 1928 and 1930 (Wendenstrasse School, Hamburg-Hammerbrook, 1928–29) are outstanding examples of modern brickwork. Stone and brick masonry were the stepchildren of Modernism; too many courses, which linked the pure



**Fig. 16: Masonry in Berlin (1937)**  
A comparison of masonry by Werner Lindner and Friedrich Tamms



**Fig. 17: The search for a national building style for the USA**  
Henry Hobson Richardson: Ames Gate House, North Easton (USA), 1881



**Fig. 18: Rusticated ashlar masonry as a symbol of the power of the state**  
Henry Hobson Richardson: Courthouse and prison, Allegheny County, Pittsburgh (USA), 1888

surface with country, region, time or work, have contaminated the purity of the International Style. Time is not to be understood here as a stylistic epoch. It is present in the form of sediments and pollution which could enrich the surface of traditional masonry or destroy the purism of classical Modernism.

And yet architects of classical Modernism such as Hugo Häring, Ludwig Mies van der Rohe or Alvar Aalto have also constructed buildings of brick or stone masonry. The brick masonry walls of Mies van der Rohe, e.g. those illustrated in the well-known publications of Werner Blaser, are suitable for conveying precision as a sublime quality, even as drawings. In the case of Aalto it is another issue entirely. As he had pursued the idea of "flexible standards", which, like the cells of a living organism, allows a variety of forms,





Fig. 19: Decoration cut into brickwork after erection  
Theodor Fischer: Ledigenheim, Munich (D), 1927

he found brick to be a common denominator, comprising not only the values of mass production and industrialisation but also the warmth and identification, signs for a “new humanism”.

The new humanism of the postwar period was also sought by Louis Kahn and Eero Saarinen. Kahn’s library for the Phillips Academy in Exeter, New Hampshire (1965–72) is a compromise. Originally, he visualised massive brick walls with arched openings; however, a concrete core with brick facing was implemented. The government buildings in Dhaka (1973–76) deliberately sought the connection to a Piranesian style for ancient engineering structures. In an interview Kahn emphasised the sought-after contrast between the coarseness of “viaduct architecture” and the fineness of the structures of human institutions.<sup>18</sup> This aesthetic and at the same time social vision was also a theme in many American student accommodation projects of the postwar period. Eero Saarinen wanted to suggest the atmosphere of a fortified city on the campus of Yale University; the buildings of Ezra Stiles College and Morse College (1960) are concrete walls with large natural pieces of stone “floating” in the aggregate. Saarinen reckoned that one of the reasons why modern architecture does not use masonry is the anachronism of the manual implementation: “...we found a new technological method for making these walls: these are ‘modern’ masonry walls made without masons.”<sup>19</sup>

In comparison with concrete or even stone, brickwork is not a suitable material for roofing over interior spaces. The small format of the brick makes either the use of brick

vaulting or additional strengthening in the form of metal ties or concrete ribs essential. According to his conviction that it is precisely the weaknesses that challenge the performance, Schumacher is of the opinion that from an aesthetics standpoint the art of envelope design is surely “the pinnacle of all possibilities” possessed by masonry construction.<sup>20</sup> Without doubt the works of the Uruguayan architect Eladio Dieste, whose design concepts follow in the footsteps of Antoni Gaudí’s, belongs to the zenith of the envelope design. Dieste used freestanding brick walls with conoid surfaces in double curvature (church in Atlántida, 1960). He developed a vocabulary of structural forms of masonry that was rational but likewise highly expressive like Gaudí’s designs. He thus challenged the prevailing attitude of the large firms where rationalisation and efficiency meant nothing more than routine, bureaucracy and the inflexible application of predictable solutions. According to Dieste it is accumulation of capital and not efficiency that drives such organisations. This is why he chose the other way, and used an ancient material with constructive intelligence instead of the newest developments from materials research as a thin covering, a “vener”.



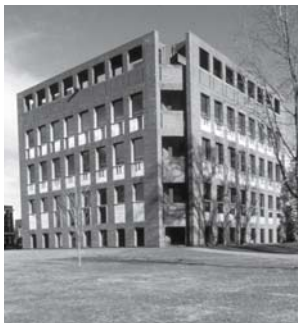
Fig. 20: Example of a modern building using facing masonry  
Fritz Schumacher: Wendenstrasse School, Hamburg-Hammerbrook (D), 1929

### The restrained resistance of masonry

The purely decorative use of brick walls can always be defended with historical associations. For an artist like Per Kirkeby, who builds masonry objects as works of art, it is even more difficult – the work must exist in

itself, even as a fragment it must be convincing and self-reliant. The brickwork in its double entity of structural purity and craftlike stigma opens up vast historical perspectives. An artist like Per Kirkeby finds his identity precisely through this: "The brick and its rules, in other words the bond and whatever else belongs to this thousand-year-old handicraft, form a pure structure corresponding to everything one could call conceptual vision. And on the other hand brickwork was full of associations and clues to the great historical architecture with its ruins and other set pieces, the wafts of mist and the moonlight. And for me full of childhood connotations in the shadow of overpowering boulders of Gothic brickwork".<sup>21</sup>

An early attempt to link the idea of standardisation with an intensified material presence was Baker House, the student accommodation by Alvar Aalto on the campus of the Massachusetts Institute of Technology (1946–49).



**Fig. 21: Maximum openness...**  
Louis I. Kahn: Library of the Phillips Academy, Exeter (USA), 1972



**Fig. 22: ...versus the "bricked-up" appearance of a fortification**  
Louis I. Kahn: Government buildings in Dhaka (Bangladesh), 1976

Aalto pointed out that standardisation is evident even in nature "in the smallest units, the cells". According to Aalto: "This results in millions of elastic joints in which no type of formalism is to be found. This also results in the wealth



**Fig. 23: Unconventional masonry**  
Eero Saarinen: Ezra Stiles College and Morse College, Yale University (USA), 1960



**Fig. 24: Curving brickwork shells**  
Eladio Dieste: Church in Atlántida (Uruguay), 1960

of and never-ending change among organically growing forms. This is the very same path that architectural standardisation must follow."<sup>22</sup>

How can a brick possibly have the same "elastic soul" as an amoeba? Aalto's decision to use distorted, scorched bricks is rather a metaphorical statement of the problem than a solution. He uses this as a reference to ancient forms of brick architecture, to massive walls constructed from amorphous, air-dried clay lumps. The bricks of Baker House – in his words, the "lousiest bricks in the world" – are elements of this alchemistic process, with the vulgar and worthless playing a crucial role in the longed-for harmony. Aalto avoided an either-or approach for the newest or most ancient; architecture joins the two and is neither of them. A crucial aspect is that his work did not remain an individual protest. Siegfried Giedion reacted immediately in his historiography of Modernism by adding "irrationalism" to his vocabulary.<sup>23</sup> The materiality of the facade exercises a restrained resistance in the face of the threat to resolve architecture into the all-embracing spatial grid proposed by Ernst Neufert. This resistance of the material made it possible for Aalto to conceive his idea of standardisation as opposition to the complete availability of architecture in the service of technicised demands.

At first glance Baker House, with the powerful effect of the material of its facade, appears to be related to modern struggles to create a setting for materiality. On the other hand we sense that the aura of the sacred, these days frequently the outcome of semantic cleansing attempts, does not surround Aalto's student accommodation. The "lousiest bricks in the world" give the masonry bond so much local earth that every dream of retreat to a pure state must remain an illusion.

Another, serious alternative today is the change in the situation that came about with the new thermal insula-



Fig. 25: Organic form making use of the identical, smallest "cell"  
Alvar Aalto: Baker House, Massachusetts Institute of Technology, Cambridge (USA), 1954

#### References

- <sup>1</sup> Werner Lindner, Friedrich Tamms: *Masonry*, Berlin, 1937, p. 8.
- <sup>2</sup> Georg Simmel: "Die Ruine", idem., *Philosophische Kultur*, Berlin, 1998, p. 119.
- <sup>3</sup> Rudolf Schwarz: *Von der Bebauung der Erde*, Heidelberg, 1949, pp. 22–23.
- <sup>4</sup> Gottfried Semper: *Der Stil in den technischen und tektonischen Künsten oder praktische Ästhetik* (...) Bd. II, p. 209.  
– English translation: Gottfried Semper: *Style in the Technical and Tectonic Arts: or, Practical Aesthetics*, vol. II.
- <sup>5</sup> Gottfried Semper: Vergleichende Baulehre, in: Wolfgang Herrmann: *Gottfried Semper – Theoretischer Nachlass an der ETH Zurich. Katalog und Kommentare*, Basel, 1981, p. 199, ref.
- <sup>6</sup> Gottfried Semper: *Der Stil*, Bd. I, p. 180.  
– English translation: Gottfried Semper: *Style in the Technical and Tectonic Arts: or, Practical Aesthetics*, vol. I.
- <sup>7</sup> Fritz Schumacher: *Das Wesen des neuzeitlichen Backsteinbaus*, Munich, 1920, p. 19.
- <sup>8</sup> Louis Henry Sullivan: "Artistic Brick", in: Robert Twombly (ed.), *Louis Sullivan, The Public Papers*, Chicago and London. The University of Chicago Press, 1988, p. 202.
- <sup>9</sup> Frank Lloyd Wright: "La Miniatura", idem.: *Schriften und Bauten*, Munich/Vienna, 1963, p. 164.
- <sup>10</sup> Semper: *Der Stil*, Bd. II, p. 351.  
– English translation: Semper: *Style in the Technical and Tectonic Arts: or, Practical Aesthetics*, vol. II.
- <sup>11</sup> Ibid., p. 378.
- <sup>12</sup> Ibid., p. 381, ref.
- <sup>13</sup> Schumacher: *ibid.*, p. 116.
- <sup>14</sup> Schwarz: *ibid.*, p. 24.
- <sup>15</sup> Lindner/Tamms: *ibid.*, p. 8.
- <sup>16</sup> Lindner/Tamms: *ibid.*, p. 8.
- <sup>17</sup> Schumacher: *ibid.*, p. 46.
- <sup>18</sup> "...contrast of the toughness of the viaduct architecture and the gossamer delicacy of the buildings of the institutions of man", in John Peter: *The Oral History of Modern Architecture*, New York/Abrams, 1994, p. 220.
- <sup>19</sup> *Eero Saarinen on his Work*, New Haven/London: Yale University Press, 1962, p. 84.
- <sup>20</sup> Schumacher: *ibid.* p. 105.
- <sup>21</sup> Per Kirkeby: *Backsteinskulpturen*, idem.: *Kristallgesicht*, Bern/Berlin, 1990, p. 180.
- <sup>22</sup> Alvar Aalto: "Die Entwicklung von Konstruktion und Material...", idem., *Synopsis: Painting, Architecture, Sculpture*, Basel/Boston, Stuttgart, 1980, p. 29.
- <sup>23</sup> Sigfried Giedion: *Raum, Zeit, Architektur. Die Entstehung einer neuen Tradition*, 4. Auflage Zurich, München 1989, p. 376 f.  
– English translation: Sigfried Giedion: *Space, Time and Architecture: The Growth of a New Tradition*, 4th ed., Zurich/Munich, 1989.

tion standards introduced after the oil crisis. The use of solid masonry walls with a high heat capacity, combined with appropriate heating systems that exploit precisely this property of masonry, can make solid masonry walls useful again. The Art Gallery in Marktdorf, Bavaria (Bearth & Deplazes, 2001) consists of – just like the systems of medieval dungeons and city walls – hall-type rooms and peripheral rooms. The latter are stairs and intermediate spaces located on the periphery of the building which Kahn used to achieve his longed-for separation of "servant" and "served".

So the pathos of masonry must not lead inevitably to the reinstatement of metaphorical qualities such as craftsmanship, regionalism, or heaviness – the latter understood as an answer to the increasing media compatibility of architecture. The accurate and correct questions address the use and fabrication from the perspective of rationality, not romanticism. If convenient conventions do not form a barrier to our thinking, then from a metaphorical presentation of the questions, masonry will be the right answer.



Fig. 26: The presence of the material is strengthened by using distorted, "reject" bricks. Alvar Aalto: Baker House, Massachusetts Institute of Technology, Cambridge (USA), 1954



## The materials

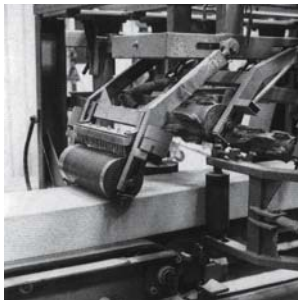


Fig. 27: Clay brick production  
Extrusion

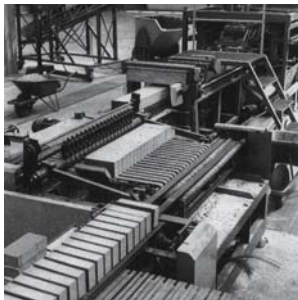


Fig. 28: Clay brick production  
Automatic cutting to size

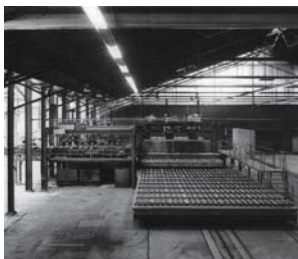


Fig. 29: Clay brick production  
"Green bricks" on traversers prior to drying and firing

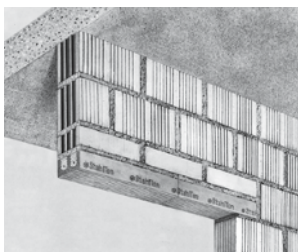


Fig. 30: Solid lintel element ("Stahlton")  
Prestressed shallow lintel with make-up units to maintain the masonry courses

### Masonry units

The building blocks of masonry are essentially:

- stone
- clay
- calcium silicate
- cement
- clay units with special properties

### Stone

Natural stone is available with the most diverse range of properties and qualities. Its weather and fading resistance depend not only on the type of stone and place of origin but also on its position in the quarry.

### Clay

Fired clay masonry units are available in a wide range of forms (facing bricks, hard-fired bricks, etc.). The raw materials for their production are natural loams and clays. The properties of the loams and clays vary depending on the content of clay minerals, lime, and iron oxide, and these in turn influence the colour and structure of the finished product.

After extraction, the loam is mixed, crushed, and sent for intermediate storage. The action of water and steam turns the loam into a kneadable, plastic mass which is then extruded to form a ribbon with a suitable cross-section (solid/voids). The ribbon is cut into bricks or blocks, which are then dried and finally fired at temperatures around 1000°C. This temperature is just below the melting point of the most important components and brings about a sintering of the grains and hence solidification. Depending on the raw material used the colour of clay masonry units varies from yellow (due to the lime content) to dark red (owing to the iron oxide content).

Besides the sizes of any voids, the firing temperature, too, has a decisive influence on the properties of the final clay masonry unit. The higher the firing temperature, the more pronounced is the sintering action. During sintering the pores close up. This reduction in the air inclusions within the masonry unit decreases the thermal storage capacity but increases the compressive strength and the resistance to moisture and frost.

### Facing bricks

Facing bricks are masonry units specially produced for masonry that is to remain exposed. Their colours and surface textures vary depending on the supplier. The surface finish of facing bricks can be smooth, granular or rough.

Facing bricks with three good faces (one stretcher and two headers) or even four good faces (two stretchers and two headers) can also be supplied. The facing side makes the brick frost resistant and hence suitable for exposure to the weather. We can deduce from this that standard bricks are less suitable for exposed situations.

### Calcium silicate

Calcium silicate masonry units are produced from lime and quartz sand and are hardened autoclaves. Compared to the fired masonry units, calcium silicate units exhibit excellent dimensional accuracy and are therefore ideal for use in facing masonry applications. Their standard colour is grey but they can be produced in a whole assortment of colours. In facing masonry made from calcium silicate units, special attention must be given to the quality of the edges.

### Cement

Cement masonry units are made from cement with a sand aggregate and exhibit a somewhat higher strength. They are significantly more resistant to aggressive water than calcium silicate units and are used primarily in civil engineering works (e.g. cable ducts).

### Clay units with special properties

Besides the customary masonry units there are also units with properties achieved through special methods of manufacture and/or shaping. These special masonry units include:

- thermal insulation units
- sound insulation units
- high-strength units
- facing bricks

### Components

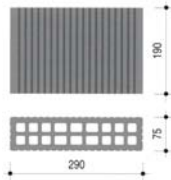
There are many products that can be added to masonry elements where this is necessary for structural or building performance reasons. Such products include, for example, hollow and solid lintels for spanning openings, thermally insulated masonry base elements, clay insulating tiles, etc.

### The "SwissModul" brick

"SwissModul" is a system of standards used by the Swiss brickmaking industry. Such bricks have modular or sub-modular dimensions and are designed for masonry which is to be plastered/rendered later. The bricks are grooved to provide a good key for the plaster/render and may be used without plaster/render only after consultation with the supplier. Masonry units with a rough or granular surface finish can be supplied by the brick manufacturers for facing masonry applications.

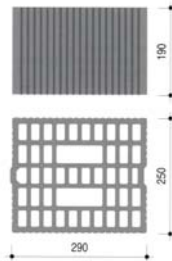
The brick manufacturers may introduce defined, small differences in the form of the brick or block, e.g. in the arrangement of the perforations. The various products from the individual plants are optimised depending on local raw materials and production methods. As the product ranges available can change rapidly, the masonry units shown here can be regarded only as examples.

Swiss clay bricks and blocks



**SwissModul® brick 75 mm**

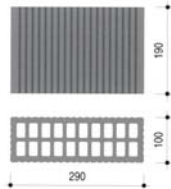
Basic format	Make-up units	L x W x H mm	Weight approx. kg
B 7.5/19		290 / 75 / 190	4.5
	B 7.5/14	290 / 75 / 140	3.3
	B 7.5/9	290 / 75 / 90	2.1
	B 7.5/6.5	290 / 75 / 65	1.5



**SwissModul® brick 250 mm**

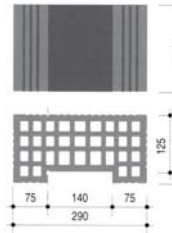
Basic format	Make-up units	L x W x H mm	Weight approx. kg
B 25/19		290 / 250 / 190	12.6
	B 25/14	290 / 250 / 140	9.3
	B 25/9*	290 / 250 / 90	6.0
	B 25/6.5*	290 / 250 / 65	4.3

\*) on request



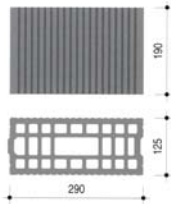
**SwissModul® brick 100 mm**

Basic format	Make-up units	L x W x H mm	Weight approx. kg
B 10/19		290 / 100 / 190	5.6
	B 10/14	290 / 100 / 140	4.2
	B 10/9	290 / 100 / 90	2.7
	B 10/6.5	290 / 100 / 65	1.9



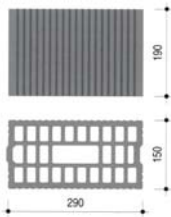
**Reveal bricks (suitable for cutting) 125 mm**

Basic format	L x W x H mm	Weight approx. kg
B 15/19 reveal brick	290 / 150 / 190	7.9
B 15/14 reveal brick	290 / 150 / 140	5.8
B 16.5/19 reveal brick	290 / 165 / 190	8.4
B 16.5/14 reveal brick	290 / 165 / 140	6.2
B 17.5/19 reveal brick	290 / 175 / 190	8.7
B 17.5/14 reveal brick	290 / 175 / 140	6.4
B 19.5/19 reveal brick	290 / 195 / 190	9.3
B 19.5/14 reveal brick	290 / 195 / 140	6.9
B 20/19 reveal brick	290 / 200 / 190	9.3
B 20/14 reveal brick	290 / 200 / 140	6.9
B 25/19 reveal brick	290 / 250 / 190	10.1
B 25/14 reveal brick	290 / 250 / 140	7.5



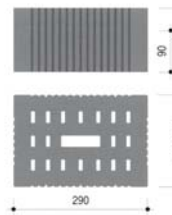
**SwissModul® brick 125 mm**

Basic format	Make-up units	L x W x H mm	Weight approx. kg
B 12.5/19		290 / 125 / 190	6.9
	B 12.5/14	290 / 125 / 140	5.1
	B 12.5/9	290 / 125 / 90	3.3
	B 12.5/6.5	290 / 125 / 65	2.4



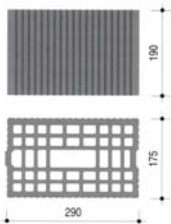
**SwissModul® brick 150 mm**

Basic format	Make-up units	L x W x H mm	Weight approx. kg
B 15/19		290 / 150 / 190	8.2
	B 15/14	290 / 150 / 140	6.0
	B 15/9	290 / 150 / 90	3.9
	B 15/6.5	290 / 150 / 65	2.8



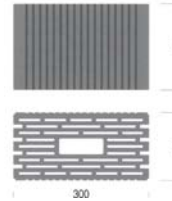
**CALMO® sound insulation bricks**

Basic format	L x W x H mm	Weight approx. kg
B 12.5/9 CALMO	290 / 125 / 90	4.6
B 12.5/14 CALMO	290 / 125 / 140	7.1
B 15/9 CALMO	290 / 150 / 90	5.5
B 15/14 CALMO	290 / 150 / 140	8.6
B 17.5/9 CALMO	290 / 175 / 90	6.4
B 17.5/14 CALMO	290 / 175 / 140	10.0
B 20/9 CALMO	290 / 200 / 90	7.4
B 20/14 CALMO	290 / 200 / 140	11.5



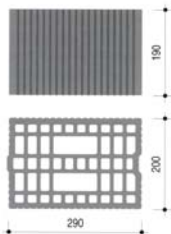
**SwissModul® brick 175 mm**

Basic format	Make-up units	L x W x H mm	Weight approx. kg
B 17.5/19		290 / 175 / 190	9.4
	B 17.5/14	290 / 175 / 140	6.9
	B 17.5/9	290 / 175 / 90	4.5
	B 17.5/6.5	290 / 175 / 65	3.2



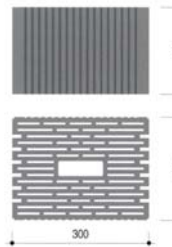
**OPTITHERM® brick 150 mm**

Basic format	Make-up units	L x W x H mm	Weight approx. kg
BL 15/19 OPTI		300 / 150 / 190	8.6
	BL 15/14 OPTI	300 / 150 / 140	6.3
	BL 15/9 OPTI	300 / 150 / 90	4.1
	BL 15/6.5 OPTI	300 / 150 / 65	3.0



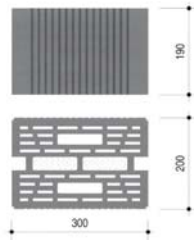
**SwissModul® brick 200 mm**

Basic format	Make-up units	L x W x H mm	Weight approx. kg
B 20/19		290 / 200 / 190	10.5
	B 20/14	290 / 200 / 140	7.7
	B 20/9	290 / 200 / 90	5.0
	B 20/6.5	290 / 200 / 65	3.6



**OPTITHERM® brick 225 mm**

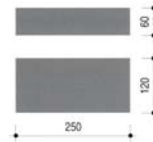
Basic format	Make-up units	L x W x H mm	Weight approx. kg
BL 22.5/19 OPTI		300 / 225 / 190	12.5
	BL 22.5/14 OPTI	300 / 225 / 140	9.2
	BL 22.5/9 OPTI	300 / 225 / 90	6.0
	BL 22.5/6.5 OPTI	300 / 225 / 65	4.3



**ISOMODUL® brick Super**

Basic format	L x W x H mm	Weight approx. kg
BL 20/19 ISO	300 / 200 / 190	10.0
BL 20/14 ISO*	300 / 200 / 140	7.4
BL 20/9 ISO*	300 / 200 / 90	4.7
BL 20/6.5 ISO*	300 / 200 / 65	3.4

\*) on request

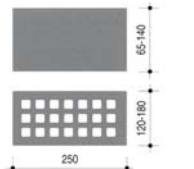


**Kemano® facing bricks (solid)**

Designation	L x W x H mm	Weight approx. kg
BV 25/12/6	250 / 120 / 60	3.1

Surface finishes  
rustic

Colours  
red, salmon, brown, white



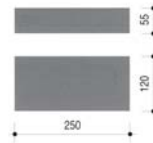
**Facing bricks**

Designation	L x W x H mm	Weight approx. kg
B 12/ 6.5 S	250 / 120 / 65	2.2
B 12/9 S	250 / 120 / 90	3.1
B 12/14 S	250 / 120 / 140	4.7
B 15/14 S	250 / 150 / 140	5.7
B 18/14 S	250 / 180 / 140	6.5
B 14/6.5 S	290 / 140 / 65	3.0
B 14/9 S	290 / 140 / 90	4.0
B 14/14 S	290 / 140 / 140	6.4

Surface finishes

MP (pressed)	smooth surface
OP (unpressed)	rough surface

Colours  
red, light red, pale red, salmon, salmon red, brown, white, Bahia white

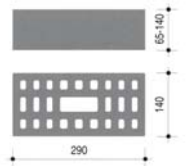


**Kemano® Ticino facing bricks (solid)**

Designation	L x W x H mm	Weight approx. kg
BV 25/12/5.5	250 / 120 / 55	3.0

Surface finishes  
rustic, sanded

Colours  
red, salmon, white



**Kelesto® facing bricks**

Designation	L x W x H mm	Weight approx. kg
Quality to SIA 177 & DIN 105		
VHLZ 25/12/6.5 S	250 / 120 / 65	2.4
VHLZ 25/12/9 S	250 / 120 / 90	3.3
VHLZ 25/12/14 S	250 / 120 / 140	5.2
VHLZ 29/14/6.5 S	290 / 140 / 65	5.3
VHLZ 29/14/9 S	290 / 140 / 90	4.5
VHLZ 29/14/14 S	290 / 140 / 140	7.0

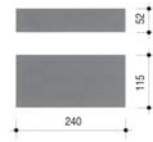
Facing bricks with vertical perforations to DIN 105

VHLZ DF	thin format	240 / 115 / 52	1.9
VHLZ NF	standard format	240 / 115 / 71	2.6
VHLZ 2DF	double-thin format	240 / 115 / 113	4.5

Surface finishes

MP (pressed)	smooth surface
OP (unpressed)	rough surface
GP (granular, pressed)	granular surface

Colours  
red, pale red, salmon, brown, pearl grey, white  
to order: sienna red, pale brown, fawn, silver, platinum

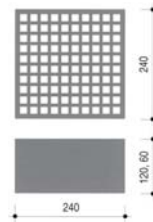
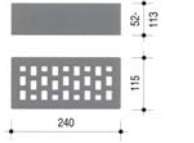
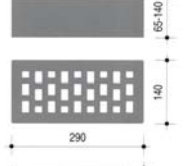
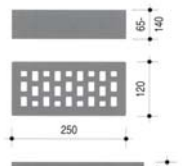


**Kemano® hard-fired facing bricks (solid)**

Designation	L x W x H mm	Weight approx. kg	
Quality to DIN 105			
KMZ DF	thin format	240 / 115 / 52	2.9

Surface finishes  
rustic

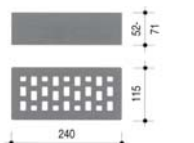
Colours  
brick red, Sahara, Jura



**Acoustic facing bricks**

Designation	L x W x H mm	Weight approx. kg
1/1 brick	240 / 240 / 120	8.7
1/1 brick	240 / 240 / 60	4.3
1/2 brick	240 / 115 / 120	4.2
1/2 brick	240 / 115 / 60	2.1
25/18 1/1 brick	250 / 180 / 120	6.9
25/18 1/2 brick	250 / 180 / 60	3.4

Perforated side ground  
Colours: red, salmon, brown



**Kelesto® hard-fired bricks**

Designation	L x W x H mm	Weight approx. kg	
Quality to DIN 105			
KHLZ DF	thin format	240 / 115 / 52	2.2
KHLZ NF	standard format	240 / 115 / 71	2.9

Surface finishes

MP (pressed) smooth surface

Colours

Standard firing: brick red, Tuscan, Sahara, earth brown, Jura  
Special firing: variegated brick red, variegated Tuscan, variegated Sahara, variegated earth brown, variegated Jura

Fig. 31: Note

For details of current products see [www.swissbrick.com](http://www.swissbrick.com).  
For details of a comparable selection of clay bricks and blocks as available on the German market see [www.ziegel.de](http://www.ziegel.de) (German Brickmaking Industry Association).

## Masonry terminology



Fig. 32: Irregular or rustic bond

### Definitions

excerpted from *Wasmuths Lexikon der Baukunst*, with borrowings from the *Penguin Dictionary of Building* and *British Standard 6100*.

**Clay masonry unit.** A brick or block made from loam or clay and hardened by means of firing. Available in various forms and sizes. See “Clay brick” below for more information.

**Clay brick, clay block.** A man-made building component made from clay, loam or clayey substances – sometimes with the addition of sand, quartz fragments, dried clay dust or fired clay – dried in the air or fired in a kiln. If they are fired, we obtain the familiar clay brick commonly used in building. They are generally prismatic in shape but there are regional variations in the dimensions which have also changed over the course of time.

**Hard-fired bricks.** Clay bricks fired up to the point of sintering, and with a surface which is already lightly vitrified. Such bricks are used for facing masonry applications. One stretcher and one header face are fired to “facing quality”.

**Bed joint.** A horizontal mortar joint in brickwork or blockwork. In arches and vaulting the bed joints run between the arching/vaulting courses.

**Perpend.** The vertical mortar joint (1 cm wide on average) between bricks or blocks in the same course of brickwork or blockwork, which shows as an upright face joint. In arches and vaulting the perpend are the joints between the masonry units of one and the same course.

**Stretcher.** A brick, block or stone laid lengthwise in a wall to form part of a bond.

**Header.** A brick or block laid across a wall to bond together its two sides.

**Course.** A parallel layer of bricks or blocks, usually in a horizontal row of uniform format, including any mortar laid with them. Depending on the arrangement of the masonry units we distinguish between various types of course (see fig. 33).

**Bonding dimension.** In a masonry bond this is the dimension by which the masonry units in one course overlap those of the course below.

**Bond.** A regular arrangement of masonry units so that the vertical joints of one course do not coincide with those of the courses immediately above and below. To create a proper masonry bond, the length of a masonry unit must be equal to twice its width plus one perpend.

**Masonry.** A construction of stones, bricks or blocks.

**Wall.** Generally, a building component constructed using stones, bricks, blocks or other materials with or without a bonding agent. Walls in which there is no mortar in the joints, merely moss, felt, lead, or similar, are known as dry walls.

Depending on height and function, we distinguish between foundation, plinth, storey and dwarf walls. These expressions are self-explanatory, as are the distinctions between enclosing or external walls, and internal walls or partitions. If walls support the loads of joists, beams, etc., they are known as loadbearing walls. If they have to withstand lateral pressures, they are known as retaining walls.

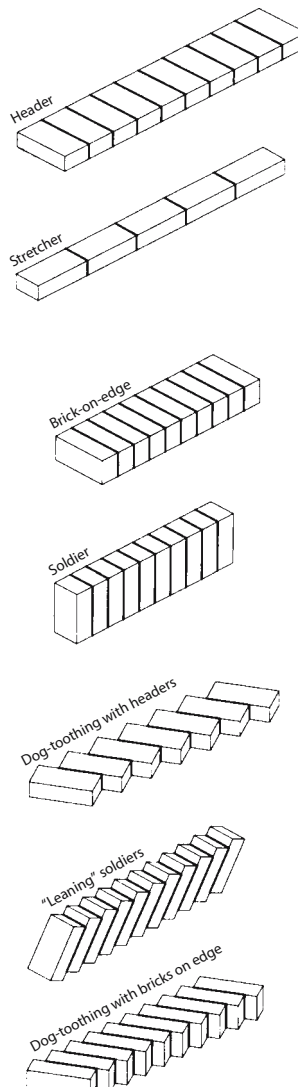


Fig. 33: Different types of course

### Further reading

- *Wasmuths Lexikon der Baukunst*, Berlin, 1931.
- Günter Pfeifer, Rolf Ramcke et al.: *Masonry Construction Manual*, Basel/Boston/Berlin, 2001.
- Fritz Schumacher: *Das Wesen des neuzeitlichen Backsteinbaues*, Munich, 1985.
- Fleischinger/Becker: *Die Mauer-Verbände*, Hannover, 1993.
- Ludwig Debo: *Lehrbuch der Mauerwerks-Konstruktionen*, Hannover, 1901.
- Heinz Ronner: *Wand + Mauer*, Basel, 1991.
- Plumridge/Meulenkamp: *Ziegel in der Architektur*, Stuttgart, 1996.



## Design and construction

### Masonry components

Masonry components comprise masonry units joined with mortar. The complete assembly then exhibits certain properties, which are discussed below.

### Masonry bonds

#### Half- and one-brick walls

The thickness of the wall is equal to either the width of the masonry unit (half-brick wall) or its length (one-brick wall). The following terms describe the arrangement of the masonry units:

- stretcher bond – a half-brick wall with the masonry units laid lengthwise along the wall
- header bond – a one-brick wall with the masonry units laid across the wall
- header bond with brick-on-edge courses

#### Bonded masonry

The width of the thickness of the wall is greater than the length of one masonry unit. A great variety of masonry bonds can be produced through different combinations of stretcher and header courses. The dimension of such bonds are the result of the particular sizes of the masonry units and the joints. Building with masonry units involves working with a relatively small-format, industrially produced building material – the bricks and blocks – in conjunction with mortar to form a bonded, larger construction element. The masonry bond is characteristic of masonry construction, and critical to its strength. In order to create interlocking corners, intersections, and junctions, the bond must continue uninterrupted at such details. To achieve this, the ratio of length to width of the units was originally an even number. The length of a standard-format masonry unit is therefore twice its width.

Apart from decorative walls with no loadbearing functions, the courses are always built with their vertical joints offset so that successive courses overlap. This overlapping should be equal to about one-third of the height of the masonry unit. It is recommended to take the following bonding dimensions as an absolute minimum:

Half- and one-brick walls: min.  $1/5$  x length of unit (= 6 cm) in the longitudinal direction

Bonded masonry: min. 6 cm in the longitudinal direction, min. 4 cm transverse (theoretical)

For reasons of stability, single-leaf walls consisting of one vertical layer must be  $\geq 12$  cm thick, but  $\geq 15$  cm when using aerated concrete units. The load-carrying capacity of single-leaf walls, especially slender walls, is primarily limited by the risk of buckling.

Double-leaf walls consist of an inner and outer leaf, with possibly a layer of thermal insulation and/or air cavity in between. The inner, loadbearing leaf should be 12–15 cm thick, whereas the outer, weatherproof leaf should be  $\geq 12$  cm thick.

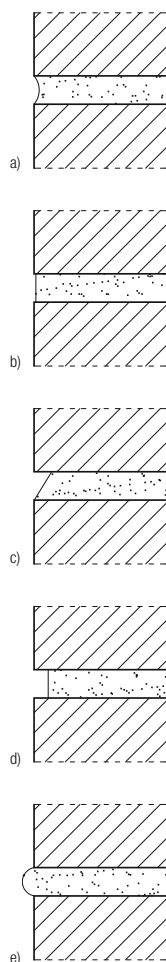


Fig. 34: Examples of jointing

- a) Bucket handle
- b) Flush
- c) Weathered  
(non-facing side of masonry partially exposed to weather)
- d) Recessed  
(non-facing side of masonry partially exposed to weather)
- e) Protruding  
(joint material severely exposed to weather)

### Joints

We distinguish between bed joints and perpends – the horizontal and vertical layers of mortar that bind together the individual masonry units. Masonry can be regarded as a composite building material consisting of mortar and bricks, blocks, or stones. From the structural viewpoint, the perpends are much less significant than the bed joints because they do not contribute to resisting tension and compression stresses. In terms of strength and movements, the mortar joints behave somewhat differently to the masonry units and this leads to shear stresses developing between the units and the mortar. It is generally true to say that the joints (the mortar component) should be kept as thin or as small as possible. On the other hand, a certain joint thickness is necessary in order to compensate for the tolerances of the units themselves. Therefore, bed joints with normal mortar should be 8–12 mm thick.

As the wall is built, the mortar bulges out on both sides of the joints (especially the bed joints). This excess mate-

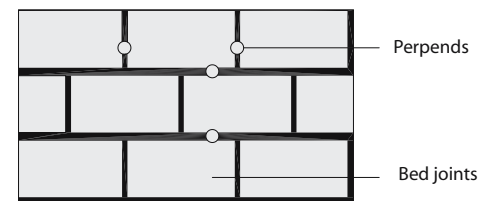


Fig. 35: Joint definitions

rial is normally struck off, which, however, is not always possible on the side facing away from the bricklayer when building a double-leaf wall. This can lead to the (already) narrow air cavity between the two leaves of masonry becoming obstructed or blocked altogether. To be on the safe side, bulging of 2–3 cm should be allowed for.

Depending on the desired appearance of the structure, the joints can be finished in different ways: flush, recessed, etc. (see fig. 34). In masonry that has to satisfy a demanding specification, e.g. special acoustic, seismic or architectural requirements, the mortar in the perpends is crucial to achieving the desired properties. On the other hand, masonry that does not have to satisfy any special demands can even be constructed with brick-to-brick perpends (i.e. no mortar in the vertical joints).

### Dimensional coordination

Every structure, facing masonry in particular, should take account of dimensional coordination in order to rationalise the design and construction. This is understood to be a system of principal dimensions that can be combined to derive the individual dimensions of building components. The application of dimensional coordination results in components (walls, doors, windows, etc.) that are harmonised with each other in such a way that they can be assembled without having to cut the masonry units.



The nominal dimensions are even multiples of the basic module. They represent the coordinating dimensions for the design. Manufacturers subtract the joint dimension from these to arrive at a work size for each component.

The design team must specify whether the masonry concerned is normal masonry left exposed (e.g. in a basement), a faced external wall, or internal facing masonry. The requirements placed on the surface finish of the bricks or blocks, the jointing, and the quality of workmanship increase accordingly.

#### *Thickness of wall*

The thickness of the masonry in a half- or one-brick wall corresponds to the width or length of the unit respectively, and thicker walls depend on the bricks/blocks used and the bond chosen.

#### *Length of wall*

A wall may be any length. Any necessary adjustments and sufficient interlocking within the masonry bond are achieved by cutting/sawing the bricks or blocks. Short sections of wall, columns, and piers should preferably be of such a size that whole bricks or blocks can be used. In facing masonry the dimensions must be chosen to suit the desired appearance of the masonry bond.

Factory-produced cut bricks (called bats) for adjusting wall lengths are available for facing masonry only. As a rule, the bricks or blocks are cut/sawn on site when the masonry is to be plastered or rendered subsequently, or to suit non-standard dimensions.

#### *Height of wall*

Clay bricks and blocks should not be cut within their height. Coordination between the courses and the overall height of the wall is therefore essential. Various make-up units (called tiles) are available, and by combining these any desired overall height can be achieved. However, it is advantageous to choose the height such that make-up units are reduced to a minimum, if possible to just one size. A change in the normal bed joint thickness should normally be reserved for compensating for unevenness and tolerances.

#### **Nominal dimensions**

Single-leaf loadbearing walls must be  $\geq 12$  cm thick, but  $\geq 15$  cm when using aerated concrete units. In double-leaf walls the inner, loadbearing leaf should be 12–15 cm thick, whereas the outer, non-loadbearing leaf should be  $\geq 12$  cm thick for reasons of stability. The stability of slender walls is primarily limited by the risk of buckling, i.e. transverse tensile stresses can no longer be resisted without a large compression load.

## Masonry bonds

### “Exposing the invisible”

A thorough understanding of the way that masonry works and the manner in which many historic buildings were assembled are intrinsic to our knowledge about the various types of masonry bond. This also forms the foundation for the design and arrangement of facing masonry structures.

According to the definition in *Wasmuths Lexikon der Baukunst*, a masonry bond is the “proper assembly (bonding) of natural or man-made stones” in order to guarantee the even distribution of the loads throughout the masonry body and an interlock between the individual masonry units in three dimensions.

To achieve proper bonding and interlocking at corners, terminations, and intersections, special arrangements of the respective bonds are necessary. These are governed by rules based on centuries of experience.

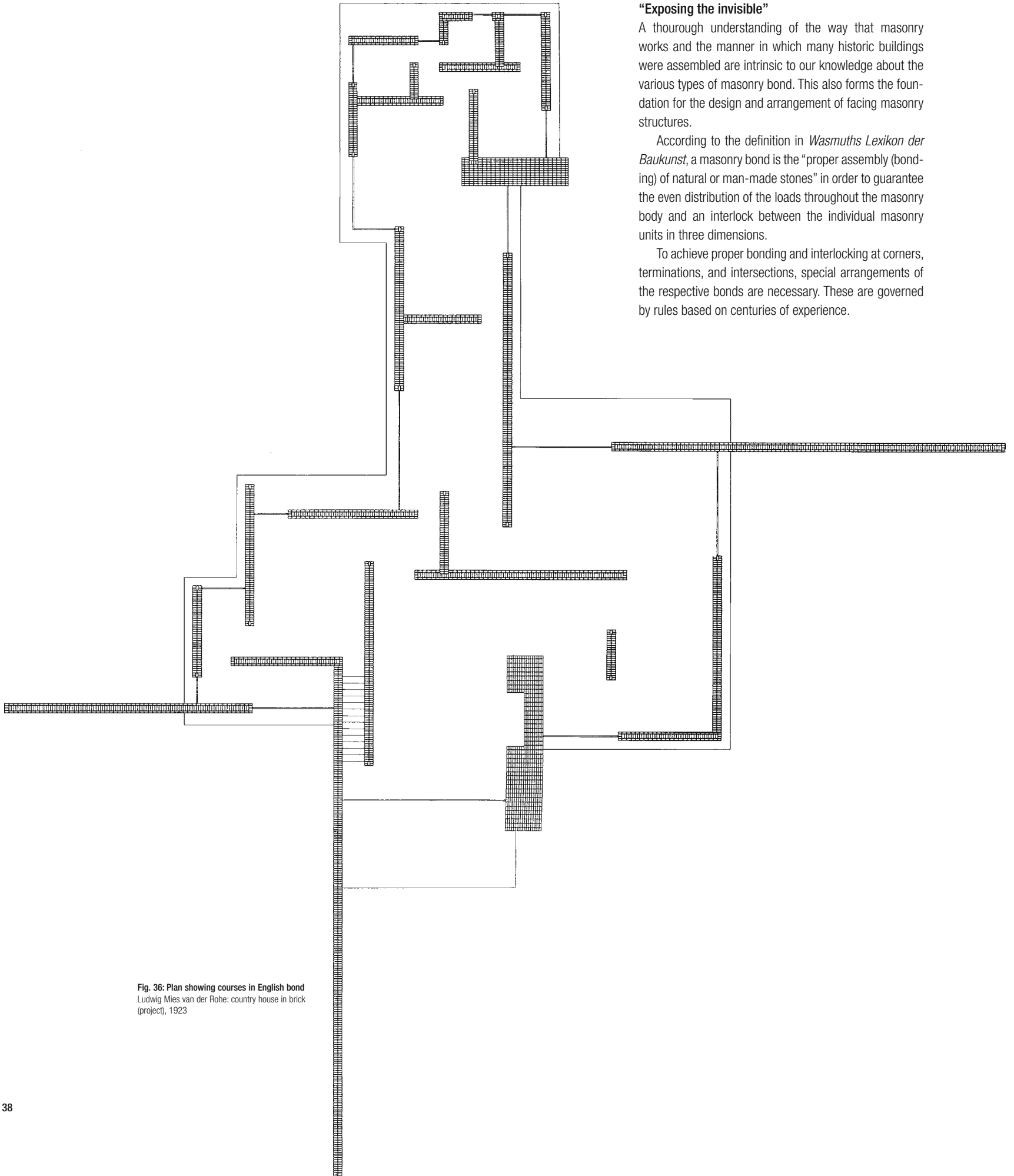


Fig. 36: Plan showing courses in English bond  
Ludwig Mies van der Rohe: country house in brick  
(project), 1923

### The principles of masonry bonds

#### using English bond as an example

This applies only to a bond consisting of man-made masonry units (i.e. clay, calcium silicate, concrete bricks, or blocks).

1. Exactly horizontal courses of masonry units are the prerequisite for a proper masonry bond.
2. Stretcher and header courses should alternate regularly on elevation.
3. There should be as many headers as possible in the core of every course.

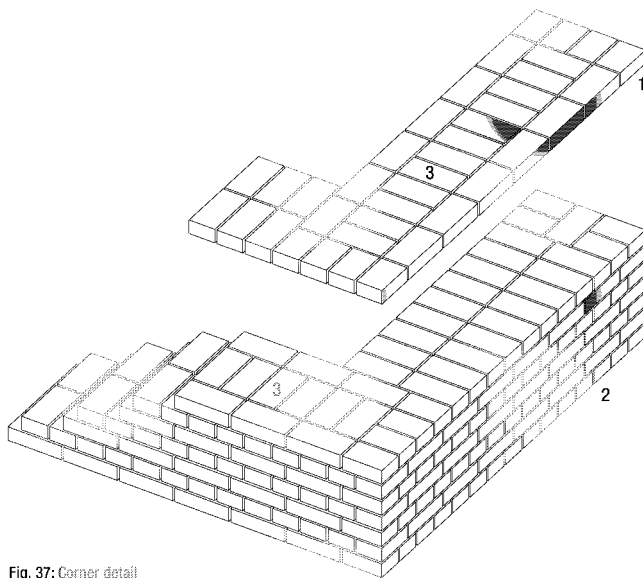


Fig. 37: Corner detail

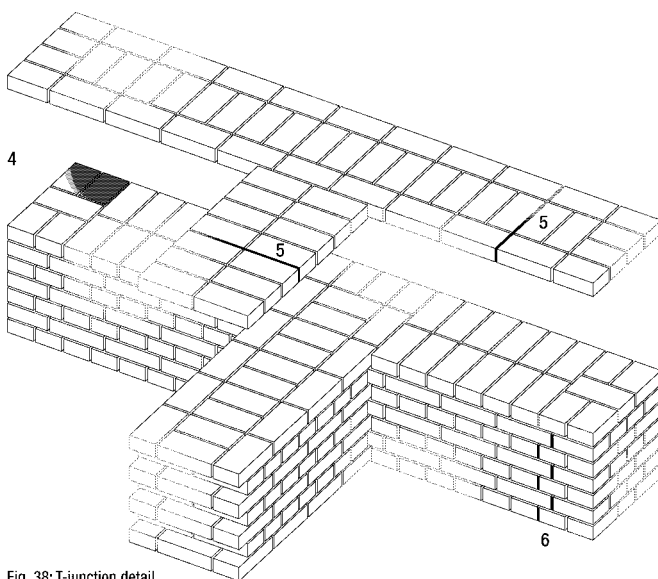


Fig. 38: T-junction detail

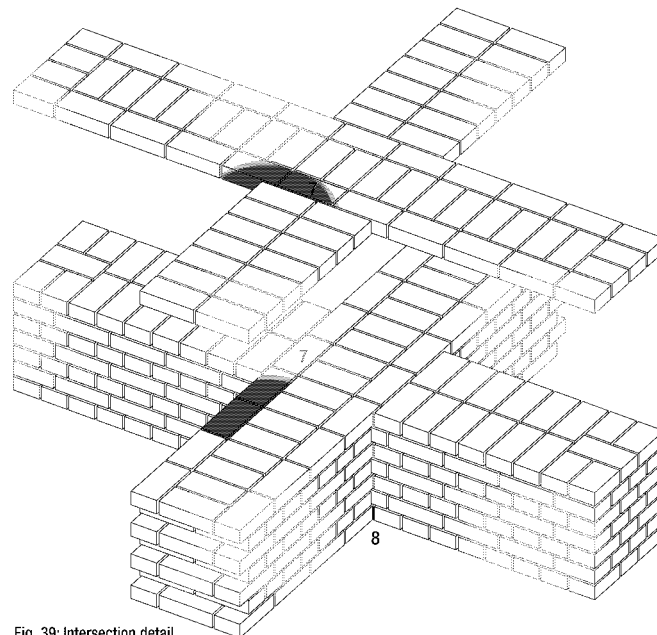
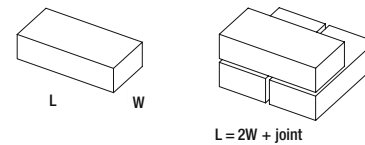


Fig. 39: Intersection detail

4. There should be as many whole bricks or blocks as possible and only as many bats as necessary to produce the bond (3/4 bats at corners and ends to avoid continuous vertical joints).
5. As far as possible, the perpend in each course should continue straight through the full thickness of the masonry.
6. The perpend of two successive courses should be offset by 1/4 to 1/2 of the length of a masonry unit and should never coincide.
7. At the corners, intersections, and butt joints of masonry components the stretcher courses should always continue through uninterrupted, whereas the header courses can form a straight joint.
8. At an internal corner the perpend in successive courses must be offset.



Numerous variations can be produced according to the principles of masonry bonds, indeed as interesting derivations based on the following logic: the length of a masonry unit is equal to twice its width plus one perpend (e.g.  $29 = 14 + 14 + 1$ ).

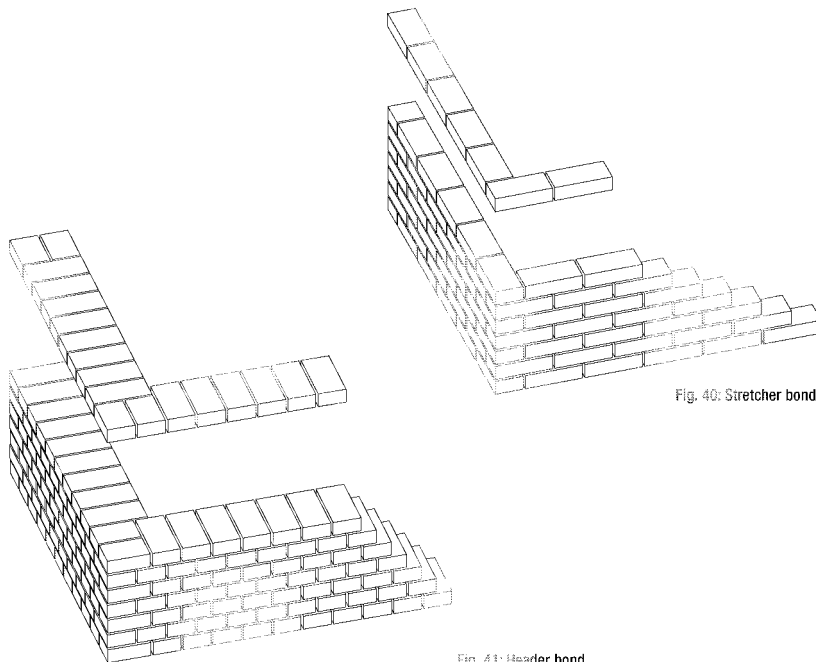


Fig. 40: Stretcher bond

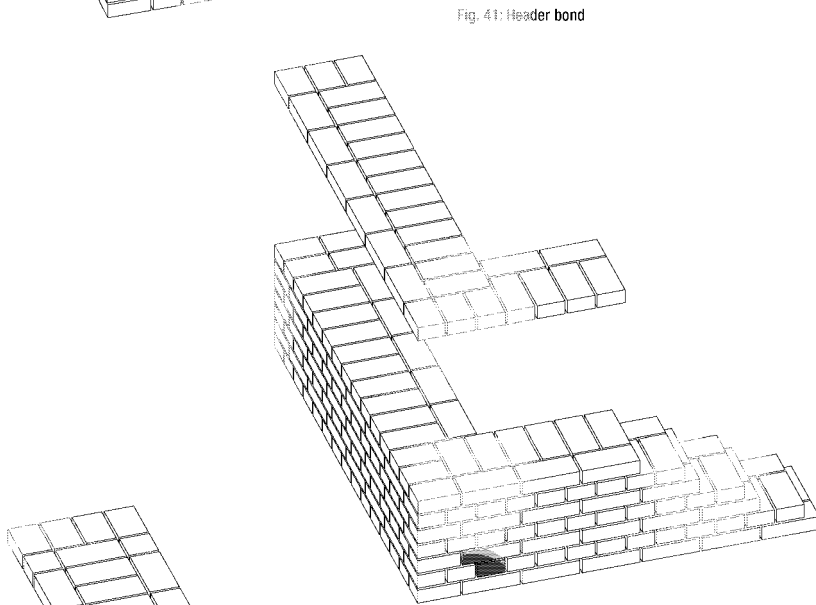


Fig. 41: Header bond

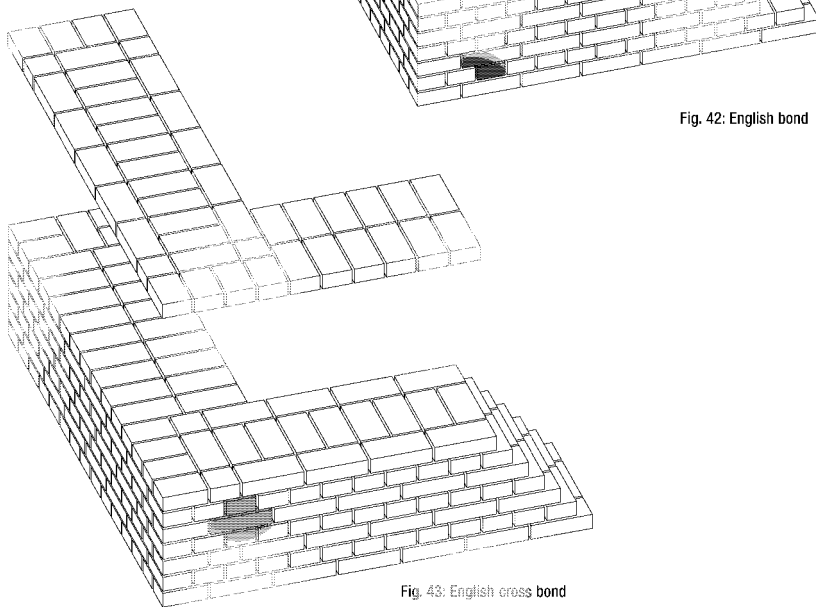


Fig. 42: English bond

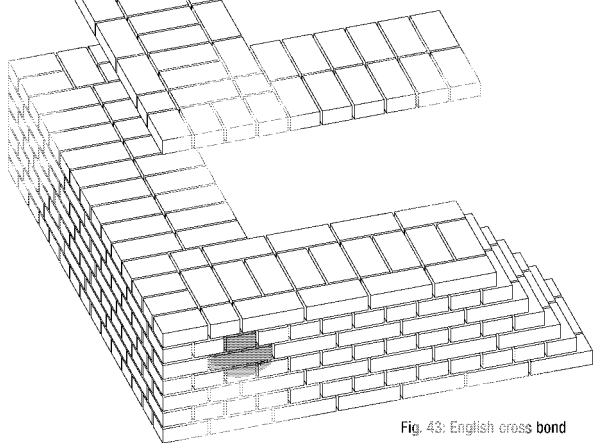


Fig. 43: English cross bond

### The principal or trainee bonds

We distinguish between half-, one-brick, and bonded masonry. In half- and one-brick walls the width of the courses is limited to one half or the whole length of a masonry unit respectively, whereas in bonded masonry the bond can extend over more than one brick or block within the depth of the wall.

### Half- and one-brick walls

#### *Stretcher bond (common bond)*

All courses consist exclusively of stretchers. Owing to the bonding dimension, which is normally half the length of a masonry unit, this bond results in masonry with good tensile and compressive strength. Stretcher bond is suitable for half-brick walls only. It is therefore employed for internal partitions, facing leaves and walls made from insulating bricks/blocks. The bonding dimension can vary, but must be at least  $1/4$  x length of masonry unit.

#### *Header bond*

As all courses consist exclusively of headers, this bond is primarily suited to one-brick walls. Successive courses are offset by  $1/4$  x length of masonry unit. This is a bond with a very high compressive strength which in the past was frequently used for foundations, too. Owing to the short bonding dimension, however, header bond is susceptible to diagonal cracking following the line of the joints.



Fig. 44: Stretcher bond



Fig. 45: Header bond

### Bonded masonry

#### *English bond*

This bond, with its alternating courses of headers and stretchers, is very widespread. The perpend of all header courses line up, likewise those of all stretcher courses.

#### *English cross bond (St Andrew's bond)*

In contrast to English bond, in English cross bond every second stretcher course is offset by half the length of a brick, which on elevation results in innumerable interlaced "crosses". This produces a regular stepwise sequence of joints which improves the bond and therefore improves the strength over English bond.



Fig. 46: English bond



Fig. 47: English cross bond

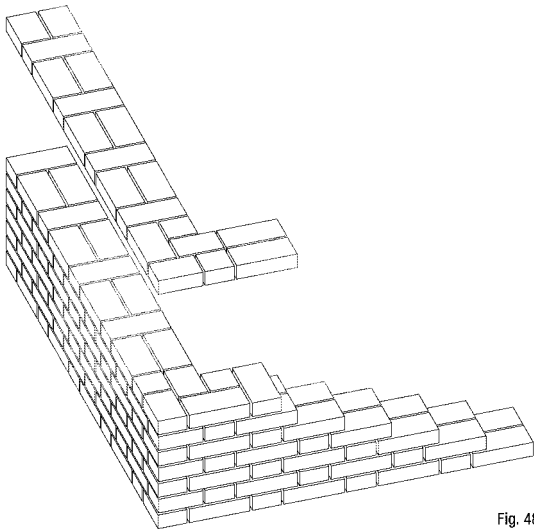


Fig. 48: Flemish bond

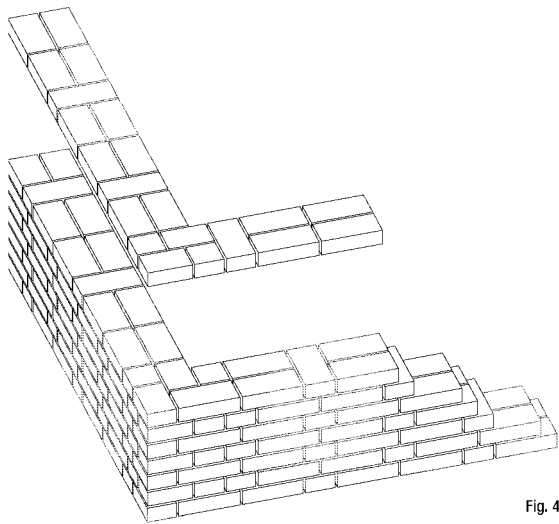


Fig. 49: Monk bond

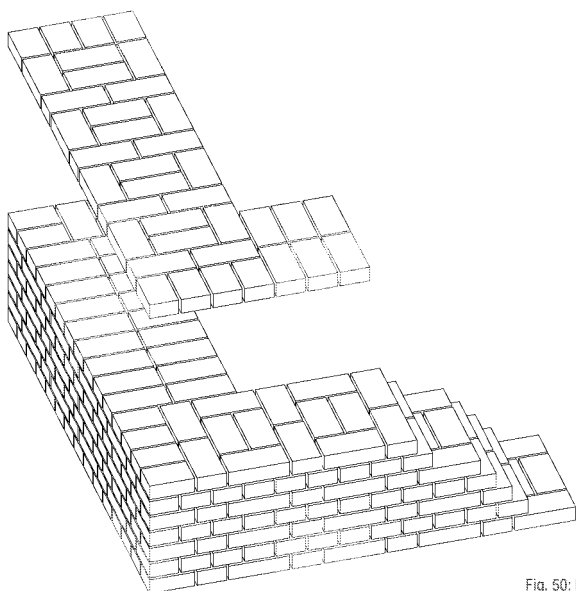


Fig. 50: Dutch bond

**Variations on English bond**

*Flemish bond*

In Flemish bond stretchers and headers alternate in every course. The headers are always positioned centrally above the stretchers in the course below. It is also possible, in one-brick walls only, to omit the headers and thus create a honeycomb wall. Flemish bond has often been used for faced walls, i.e. walls with the core filled with various masonry units grouted solid with mortar, because the alternating headers in every course guarantee a good interlock with the filling.



Fig. 51: Flemish bond



Fig. 52: Flemish bond, filled

*Monk bond (flying bond, Yorkshire bond)*

Similar to Flemish bond, in monk bond there are two stretchers between each header, and the headers in successive courses are offset by the length of one brick.

**Variation on English cross bond**

*Dutch bond*

This bond is distinguished from English cross bond by the fact that it alternates between courses of headers and courses of alternating headers and stretchers. But as in English cross bond the stretchers line up.



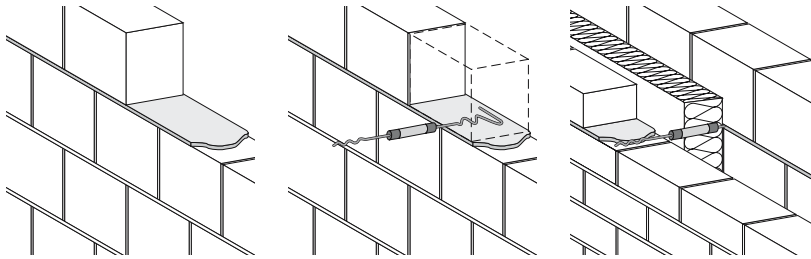
Fig. 53: Monk bond



Fig. 54: Dutch bond

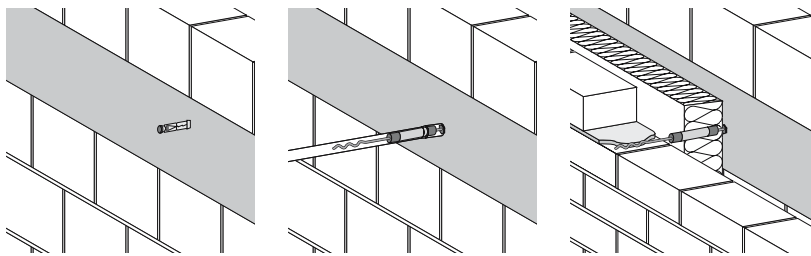


## Tying and reinforcing double-leaf masonry walls



**Fig. 55: Installation sequence, wall tie in mortar joint**

- Spread mortar.
- Place wall tie in mortar and lay masonry unit on top.
- Push insulation over wall tie, cast tie into bed joint of second (facing) leaf.

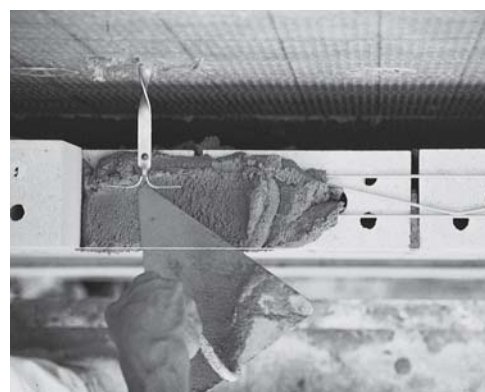
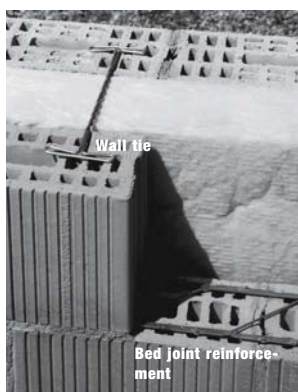


**Fig. 56: Installation sequence, wall tie in concrete**

- Drill hole in concrete and insert metal anchor.
- Screw in wall tie.
- Push insulation over wall tie, cast tie into bed joint of second (facing) leaf.



**Fig. 57: Wall ties**  
for bed joints, for concrete and masonry



### Wall ties and reinforcement

The wall ties of stainless steel or plastic must be able to transfer tensile and compressive forces perpendicular to the plane of the masonry. The behaviour of the two leaves varies. Owing to the fluctuating temperature effects, the outer leaf moves mainly within its plane. But the inner floor and wall constructions behave differently – deforming due to loads, shrinkage, and creep. Wall ties must be able to track these different movements elastically. For practical reasons the wall ties are fixed in horizontal rows, generally two or three rows per storey, at a spacing of 80–100 cm. It is fair to assume roughly one wall tie per square metre.

As each row of wall ties effectively creates a horizontal loadbearing strip, it is recommended to include bed joint reinforcement, either in the bed joint above or below the row of wall ties, or in both of these bed joints.

### Reinforced masonry for controlling cracking

Most cracks are caused by restricting load-related movements, e.g. shrinkage, and/or temperature stresses. Such cracks can be prevented, or at least minimised, through the skilful inclusion of reinforcement. The number of pieces or layers are calculated in conjunction with the bricks/blocks supplier or the structural engineer depending on the stresses anticipated and the complexity of the external wall.

Furthermore, it should be remembered that expansion (movement) joints must be provided at corners and in sections of wall exceeding 12 m in length.

### Other measures

In order to avoid stress cracking in masonry, other measures may be necessary at eaves, lintels, transfer structures, etc., e.g. cast-in rails with dovetail anchors, support brackets, expansion joints, etc.

**Fig. 58: Building up the outer leaf**  
View from the side (left) and from above (right)

## The skill of masonry construction

Katja Dambacher, Christoph  
Elsener, David Leuthold



Figure 59: Masonry units!



Figure 60: Masonry wall

### Morphology

“Masonry is a building component made from bricks and blocks that are joined by mortar and therefore function as a coherent unit.”<sup>1</sup> Well, that’s the definition – which could hardly be briefer – by the Swiss standards authority. But from this constrained condition a whole host of applications have developed.

We understand masonry to be a single- or multi-layer component assembled from natural or man-made stones that interlock with each other and are completed with mortar as the adhesive or filler.

Masonry components can be constructed from quarry or river-bed stones, dressed stones, man-made moulded, fired or unfired bricks and blocks, a mixture of the foregoing (e.g. in a faced wall), or cast and compacted masses such as cob, concrete, or reinforced concrete.

We distinguish masonry according to the method of construction and whether it is solid or contains voids.<sup>2</sup>

### Art history aspects

In cultural terms masonry represents a constant value – neither its functions nor its significance have changed substantially over the course of time. Acknowledged as a craft tradition in all cultures of the world, it is always based on the same principle despite the huge number of different architectural forms. And owing to its strength, its massiveness, and its stability it presumably represents the same values of safety, security, durability, and continuity – in other words tradition – as well as discipline and simplicity always and everywhere. Distinct levels of importance are achieved through choice of material and surface finish. For instance, structures of dressed stones exude monumentality and durability (e.g. the pyramids of Egypt). Contrasting with this, the clay brick is an inexpensive, ordinary building material which is used primarily for housebuilding and utility structures (e.g. for Roman aqueducts, as the cheap industrial material of the 19th century).

Masonry has undergone continuous change due to technical progress. Throughout the history of architecture the response to mass-produced industrial articles has always given rise to different strategies. The Expressionist buildings of Germany were using hard-fired bricks in the sense of a pointed continuation of the northern tradition of facing masonry at the same time as most of the brickwork of white Modernism was being coated with plaster and render to diminish the differentiation.

### Facing masonry

What masonry shows us is the materials, the building technology and the process-related quality of the jointing and coursing. Various elements determine the architectural expression of a wall of facing bricks. “First, the unit surface – its colours created by fire, shine, cinder holes,

blisters, tears, and grooves; next, the joint – its colour, surface and relief; and finally the bond – its horizontal, vertical and diagonal relationships and interactions as visible reminders of invisible deeds.”<sup>3</sup>

If we speak of solid facing masonry, it seems sensible to differentiate between facing and core. The hidden core of the wall can be filled with (relatively) unworked, inexpensive stones or bricks in such a way that it forms an effective bond with the facing. The design of the facing, the surface of the wall with its structural, plastic, material, coloured and haptic properties, embodies the relationship and link with the masonry body.

### Module

“Like all simple devices or tools, the masonry unit is an ingenious element of everyday life.”<sup>4</sup>

The shape and size of the individual masonry unit are part of a system of governing dimensions; the part – frequently designated the first standardised building element – is a substantial part of the whole. The individual masonry unit determines the laws of masonry building, i.e. the bonding, the bond for its part enables the regular distribution of the joints. As soon as we choose our individual brick or block, with its defined ratio of length to width to height, we establish an inevitable, prevailing system of dimensional coordination for every design, which leads to a prevailing relationship among the parts. Masonry thickness, length, height, right up to positions and dimensions of openings are defined as a consequence of multiples of the basic module.

### Format

Masonry units are usually in the form of rectangular prisms, although the actual dimensions have varied from region to region over time. However, their production has remained virtually identical throughout history. And history shows us that the fired masonry unit has seldom exceeded a length and width of 35 cm or a height of 11 cm in order to guarantee proper firing of the units and prevent excessive distortion during firing. The construction of a complex masonry bond (see “Masonry bonds”) generally requires a masonry unit whose length is equal to twice its width plus one joint. However, many different dimensions are available today (see “Swiss clay bricks and blocks”) because many walls are now executed in stretcher bond to satisfy building performance requirements and structural principles dictate other dimensions (e.g. half- and one-brick walls).

In addition, masonry units must be (relatively) easy to handle so that the bricklayer can lift and lay a unit with one hand. Apart from a few exceptions, this rule still applies today. The factory production of bricks has led a standard size of approx. 25 x 12 x 6.5 cm becoming established for facing bricks, although different specifications as well

as regional differences among the raw materials and production techniques still guarantee a wealth of different masonry units with diverse shapes, sizes, colours, surface textures, and properties. The various – larger and smaller – formats render a subtle, individual approach to the desired appearance or character of a structure possible. However, besides aesthetic necessities there are also practical reasons behind the various masonry unit formats. It is precisely the small formats that lead to greater freedom in the design of relatively small surfaces, thereby making it easier to overcome the rigidity inherent in the, initially, fixed form of the brick or block. The choice of a particular masonry unit, its format and appearance, therefore proves to be a very fundamental decision.

#### *Colours and surface finishes*

The colours of bricks and blocks are influenced by the chemical composition of the raw material (clay) plus the firing temperature and firing process. These conditions lead to a wide range of colours and lend the masonry a direct vividness and very specific quality. To use the words of Fritz Schumacher, every brick is highly individual thanks to its “corporeal” as opposed to its “non-corporeal” colour. “For in the actual material the colour is not merely a shade, but rather this shade has its own life. We feel that it exudes from inside the material, is not adhering to the outside like a skin, and that gives it extra strength.”<sup>5</sup> The term “colour” differentiates between colour as material and colour as a shade.

So no brick is exactly like any other. And it is precisely this lack of an absolutely perfect, smooth, sharp-edged, right-angled, dimensionally accurate and identically coloured brick, whose standard size, form and quality are merely approximate, that gives masonry its overwhelming fascination. The objective modularity of an individual masonry unit is balanced by the subjective composition within the masonry structure.

One traditional form of surface treatment and improvement for bricks and blocks is glazing, which can be applied when firing the unit itself or in a second firing process.

#### *Bond*

The erection of a wall is carried out according to a basic conception intrinsic to masonry: the bond. The bond is a system of rules with which a “readable, but largely invisible composition”<sup>6</sup> is produced. The heart of this process is “exposing the invisible”.<sup>7</sup>

The art of facing masonry lies in combining relatively small units by means of a solid, mass-forming but also artistic interlocking arrangement to form a structure such that the vertical joints of successive courses do not coincide. Every brick or block must be linked to its neighbours above and below in order to achieve masonry with maxi-

mum stability and consistency. This applies, above all, to the “core” of the wall which is later hidden. The masonry units interlock, carrying each other.

The arrangements of stretchers and headers create patterns stretching over several courses (rapport), and their repetition becomes a crucial design element, determining the character of the resulting surface. And the “weave” of the masonry units in every course determines whether this regular repetition takes place after two or three or, at the latest, after four courses, thus creating our stretcher bond, header bond, English bond, English cross bond, Flemish bond, etc. (see “Masonry bonds”).

#### *Strength through the bond*

Masonry is a composite material – bricks/blocks plus mortar – with high compressive and low tensile strength. The load-carrying capacity is due to the bond which interlocks the wall in three dimensions. When applying a compression load to a masonry body held at top and bottom it is the bond in conjunction with regular mortar joints that ensures an even distribution of the compressive stresses. The mortar cannot resist any tensile stresses. This therefore restricts the load-carrying capacity of masonry and hence the height of masonry structures. The highest masonry building constructed to date, the Monadnock Building in Chicago, has merely 16 storeys and measures 60 m in height. (Prior to that the tallest masonry structures had just 10 storeys.) Correspondingly, the ground floor walls of this “ancient skyscraper” (Á. Moravánsky) are two metres thick.



Figure 61: Various formats, colours and surface textures  
Alvar Aalto: experimental house, Muuratsalo (FIN), 1954

### Ornamentation

The effects of the various masonry bonds vary in their character. The choice of bond together with the material's character and the surface characteristics complement each other and determine the appearance of the facing masonry – but to differing degrees, depending on the observer's distance from the wall.

The brick itself creates the scale for the size of the ornamentation, and the pattern can be developed out of the module itself. The ornamentation created by the rapport is the outcome and also the expression of the production and jointing process; it is, as it were, itself inherent in the principle of the masonry wall.

Fritz Schumacher, for example, relies in his designs exclusively on the effect of attractive hard-fired materials in skilfully constructed walls. His ornamentation is purely superficial, the result of the alternating positions and interweaving of the bricks. However, ornamentation can also take on the form of subtly protruding individual bricks or courses, or make use of special forms such as brick-on-edge topmost courses.

Fritz Höger, the architect behind the famous Chile House in Hamburg, regards brickwork as a material with which he can achieve outstanding large-scale ornamentation by allowing individual bricks to protrude over whole surfaces to achieve extraordinary plays of light and shadow. His masonry surfaces employ relief, are even sculpted.

### Joint

In facing masonry the significance of the joint is frequently underestimated. The joint reveals the connection, “the bond”, as the true concept of the masonry. Mortar and bricks are the materials of a wall; but joint and bond determine their nature. The joints cover the surface like a dense network and give it scale. According to Gottfried Semper's “clothing theory” it is the appearance of masonry that determines its technology, and not the other way round (see “The pathos of masonry”).

Without joints, masonry would be inconceivable. The joint and the masonry material enjoy a fundamental but variable relationship with each other, each influencing the other. The network of joints can be designed in terms of dimensions, colouring, and form; the relationship between joints and masonry units determines the strength of a masonry construction and also its architectural expression. But the strength of masonry depends essentially on the thickness of the joints; the masonry units are generally more efficient than the mortar, meaning that wide joints, in principle, can reduce the overall strength of a masonry construction.

Emphasising the joints to a greater or lesser degree gives us the opportunity to harmonise the effect of the surface in terms of colouring and vividness. Identical

bricks can look totally different with the joints in a different colour. Furthermore, the variable position of the joint surface with respect to the visible surface of the brick, i.e. whether the joints are finished flush, recessed or projecting, has a critical influence on the appearance of a masonry surface. Joints struck off flush in a wall of bricks with irregular edges, for example, can conceal the irregularities and make the pattern of the joints even more conspicuous. One special way of emphasising the joints is to recess them to create regular, delicate lines of shadow.

Summing up, we can say that the joint pattern is a significant component in the masonry surface and its three-dimensional quality, either highlighting the structure of the masonry bond or giving it a homogeneous effect.

### The opening

The solid and protective shell of a masonry wall initially forms a hard boundary separating interior from exterior. Mediation takes place via perforations punched through the fabric of the wall. Their form, size, and positioning is directly related to the individual module and is consequently embedded in the strict, geometrical, modular whole. Every opening must fit into the scale prescribed by the masonry shell, and requires a careful consideration of the surfaces within the depth of the wall (head, reveals, sill, threshold); in other words, the opening is a hole in a fabric which must be “bordered”. Wall and opening form an indivisible, interrelated pair in which the former must express its inner consistency and corporeality by – of all things – an “empty space” within the masonry structure,

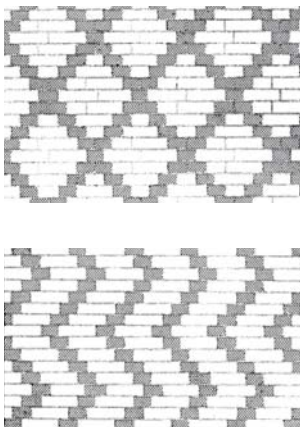


Figure 62: Ornamentation through the bond after Fritz Schumacher



Figure 63: Ornamentation through relief (bricks offset within depth of wall) Hild & K: Wolf House, Aggstaff (D), 2000





Figure 64: Expressively sculpted facade  
Fritz Höger: *Hannoverscher Anzeiger* newspaper  
building, Hannover (D), 1928

whereas the dimensions of the opening, primarily height and depth, but also the width, will always be bound by the modularity of the masonry bond. On the other hand, the opening represents a disruption in the masonry, and the wider it is, the more permanent it seems to be. Although the opening itself is dimensionless, it is still subject to the laws of gravity because it has to be bridged by a loadbearing structure spanning its width.

Openings in masonry for windows, doors, or other large apertures are spanned by lintels or arches.

Openings up to about 1.5 m can be achieved without any additional means of support, simply by wedging the smallest units against inclined abutments. This produces an extremely shallow, cambered arch.

Horizontal lintels can be provided in the form of small beams of clay or concrete, with either prestressed or conventional reinforcement. Clay lintels enable openings to be spanned with little extra work and in the same material as the rest of the wall.

The arch, on the other hand, is without doubt *the* typical solution for solid and masonry construction when it is necessary to span larger openings or topographical features. The phenomenon of the mass and weight of the building material plus the physical principle of gravity



Figure 65: Joint and bond used to create an autonomous image  
Sigurd Lewerentz: St Peter's Church, Klippan (S), 1966

are superimposed here to generate strength and stability at the macro-level (building element “arch”); the arch is a structure purely in compression. At the micro-level the inherent strength, as already mentioned, is achieved through interlocking and hence the frictional resistance between brick and mortar (“adhesion effect”).

Horizontal lintels over larger openings are built exclusively with steel or reinforced concrete beams. In his brick houses Mies van der Rohe was using concealed steel beams with a cladding of, as it were, “levitating bricks” as early as the 1920s in order to achieve window openings of maximum width and with minimum disruption to the horizontal coursing of the masonry units.

The position of the window within the depth of the wall represents another important element in the overall effect of a masonry structure. Whether the theme of the “wall”

or that of the “masonry” becomes noticeable at the design stage depends essentially on the extreme positions of windows fitted flush with the inside or outside face, indeed depends on any of the intermediate positions and possibilities within the depth of the opening. Basically, a “neutral statement” on this theme is impossible.

### Layers

#### “Monolithic masonry”

“If walls are not to express any of their own weight, if we cannot see their mass, if mass only suggests stability, then those are not walls for me. One cannot ignore the powerful impression of the loadbearing force.”<sup>8</sup> That was the view once expressed by German architect Heinz Bienefeld. (Note: He means “masonry”, the term “walls” is misleading here.)

Solid brick walls are fascinating not only in the sense of being building elements with a homogeneous structure in which the bricks are interlocked with each other in three dimensions, but also because they can take on all the functions of separating, supporting, insulating, and protecting, even storing thermal energy. The mighty masonry wall regulates the humidity in the interior and achieves a balanced internal climate. Compared with the ongoing breakdown of the double-leaf wall construction into highly specialised but monofunctional components, this multiple functionality proves to be particularly topical and up to date. This enables the development of new design strategies that look beyond the technical, constructional, and building performance issues.

The impressive, homogeneous masonry wall guarantees an imposing separating element between interior and exterior spaces. Windows positioned deep within the openings and powerful reveals divulge the massiveness of the material, which provides opportunities for plastic modulation but also the inclusion of spaces.

The insulation standards for the building envelope that have been demanded since the late 1970s have made traditional, solid, facing masonry practically impossible, and so this form has almost disappeared. The problem of thermal insulation is solved with pragmatic systems, e.g. half- and one-brick walls composed of perforated masonry units built up in a synthetic, polyfunctional layer that favours exclusively the aspect of good insulation. This is at the expense of the visual quality of the masonry bond: for reasons of vapour diffusion and weather protection, half- and one-brick walls must always be rendered outside and plastered inside, and the maximum size of opening is restricted, too.

#### Double-leaf masonry walls

Building performance requirements simply put an end to the facade as we knew it and divided our monolithic masonry into layers. In the course of the European oil crisis



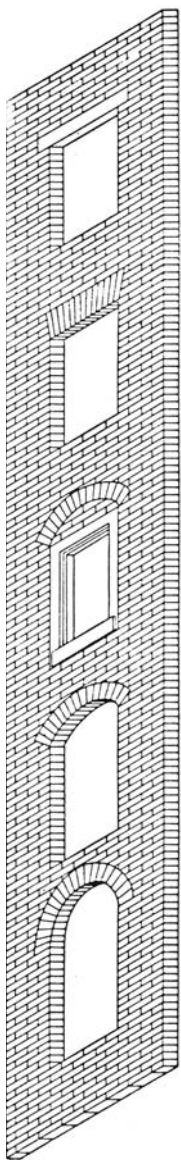


Figure 66: Lintels

of the 1970s and the subsequent demands for masonry constructions with a better thermal insulation performance double-leaf masonry walls, which were originally devised to protect against driving rain, experienced a growth in popularity. Double-leaf masonry walls have several distinct layers separated strictly according to function and this optimises the performance of individual aspects, e.g. improved insulation and sealing, more slender leaves and better economy. Both leaves, inner and outer, are generally half or one brick thick. The originally homogenous building component, the external wall, with its inherent laws stemming from the material properties and methods of working, has been resolved into discrete parts. The outer, visible leaf has been relieved of loadbearing functions and has assumed the role of a protective cladding for the insulating and loadbearing layers. Consequently, the double-leaf system has a structure that comprises mutually complementary, monofunctional layers: loadbearing, insulating, and protective.

That results in new material- and construction-related design options. In particular, the thin, outer masonry leaf with its exclusively cladding function can be featured architecturally. Expansion joints separate the wall divided into bays, whereas the lack of columns is a direct indication that the outer leaf has been relieved of heavy building loads. The original interwoven whole has been resolved into its parts.

Double-leaf constructions can be especially interesting when the independent development of the slender masonry leaves gives rise to new spaces with specific architectural qualities. In climatic terms such included spaces form intermediate zones which, quite naturally, can assume the function of a heat buffer.

Pragmatic optimisation has brought about “external insulation”. The external leaf of masonry is omitted and replaced by a layer of render.

#### *Bonds for double-leaf masonry walls*

A wall split into two, usually thin, leaves for economic reasons is unsuitable for many masonry bonds; the half-brick-thick facing leaf is built in stretcher bond – the simplest and most obvious solution. What that means for modern multi-storey buildings with facing masonry is that they can no longer have a solid, continuous, loadbearing external wall. On the other hand, solid, bonded masonry (see fig. 63, house by Hild & K) is still possible for single-storey buildings (internal insulation). And there is the option of building the external leaf not in a masonry bond – which is always three-dimensional – but emulating this and hence forming a reference to the idea of a solid wall (see fig. 69).



Figure 67: Whitewashed masonry  
Heinz Bienefeld: Schütte House, Cologne (D), 1980

#### *Facing masonry and modern energy economy standards*

The characteristics of solid masonry can be resolved into layers only to a limited extent. Expansion joints divide the non-loadbearing external leaf into segments and the deception of the solid outer wall (which is non-loadbearing) is usually unsatisfactory. In recent years we have therefore seen the development of new strategies to build solid facing masonry.

One approach is to combine the characteristics of facing, bonded masonry with the advantages of thermally optimised half- and one-brick walls (see “Buildings – Selected projects” – “Apartment blocks, Martinsbergstrasse, Baden; Burkard, Meyer + Partner”). This approach is currently very labour-intensive because two different brick formats have to be combined in one bond and adjusted to suit.

Another strategy exploits the solid masonry wall as a heat storage element and integrates the heating pipes directly into the base of the walls. This enables the construction of uninsulated facing masonry (see “Buildings – Selected projects” – “Gallery for Contemporary Art, Marktoberdorf; Bearth + Deplazes”).

#### **Design potential and design strategy**

Both the office-based design team and the site-based construction team must exercise great care when handling exposed concrete. Every whim, every irregularity is betrayed with ruthless transparency and cannot be disguised. Designing and constructing with facing bricks therefore calls for a precise architectural concept in which the artistic and constructional possibilities of the material



Figure 68: Solid masonry without additional layer of insulation  
 Bearth & Deplazes: Gallery for Contemporary Art, Marktoberdorf (D), 2001

plus its sound, craft-like workmanship form a substantial part of the design process from the very beginning.

Initially, it would seem that the means available are limited, but the major design potential lies in the patient clarification of the interrelationships of the parts within a structured, inseparable whole. The brick module as a generator implies a obligatory logic and leads to a governing dimensional relationship between the parts.

The work does not evolve from the mass but rather assembles this mass in the sense of an “additive building process” from the small units of the adjacent, stacked modules. A great richness can therefore be developed on the basis of a precise geometrical definition, a richness whose sensual quality is closely linked with the production and the traces of manual craftsmanship. Fritz Schumacher expressed this as follows: “The brick does not tolerate any abstract existence and is unceasing in its demand for appropriate consideration and action. Those involved with bricks will always have the feeling of being directly present on the building site.”<sup>9</sup>

The effect of the material as a surface opens up many opportunities. Tranquil, coherent surfaces and masses help the relief of the masonry to achieve its full effect, an expression of heaviness, stability, massiveness, but also permanence and durability. By contrast, the network of joints conveys the image of a small-format ornamental structure, a fabric which certainly lends the masonry “textile qualities”.

#### The part within the whole

Bricks and blocks can look back on a long tradition citing the virtues of self-discipline and thriftiness – and architecture of materiality and durability. The structure of facing masonry reveals a system of lucid and rational rules based on a stable foundation of knowledge and experience.

The image of the brick wall is the image of its production and its direct link with the precise rhythm of brick and joints. The relatively small brick is a winner thanks to its universal functionality: it can assume not only a separating, supporting, or protective role, but also structuring

and ornamentation. Facades come alive thanks to the age and ageing resistance of masonry materials, their manual working, and the relationship between the masonry body with its legitimate openings.

A wall of facing masonry is a work indicating structure, assembly, and fabric. The face of the architecture almost “speaks” with its own voice and enables us to decipher the logic and the animated, but also complex, interplay in the assembly of the fabric. It is precisely the limits of this material that embody its potential and hence the success of masonry over the millennia.

In conclusion, we would gladly echo here the confession Mies van der Rohe once made: “We can also learn from brick. How sensible is this small handy shape, so useful for every purpose! What logic in its bonding, pattern and texture! What richness in the simplest wall surface! But what discipline this material imposes!”<sup>10</sup>

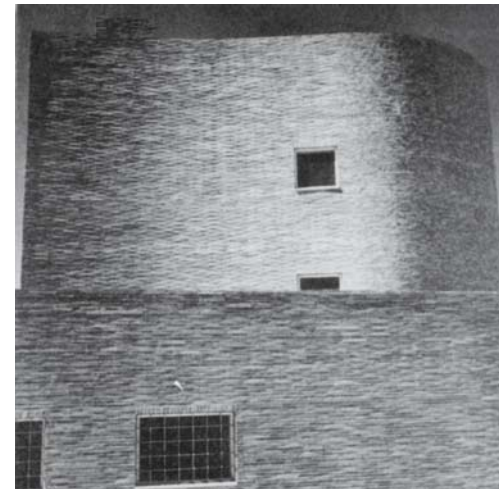


Figure 70: The plastic effect of the surface  
 Alejandro de la Sota: Casa Calle Doctor Arce, Madrid (E), 1955



Figure 69: The pattern of English cross bond in double-leaf masonry  
 Hans Kollhoff and Helga Timmermann:  
 Kindergarten, Frankfurt-Ostend (D), 1994

#### Notes

- <sup>1</sup> Swiss standard SIA V177, *Masonry*, 1995 ed., corresponds to new SIA 266:2003, 266/1:2003; see also: DIN V105 pt 1 & 2, 2002 ed., and DIN 105 pt 3-5, 1984 ed.
- <sup>2</sup> *Wasmuths Lexikon der Baukunst*, Berlin, 1931.
- <sup>3</sup> Rolf Ramcke: “Masonry in architecture”, in: *Masonry Construction Manual*, Basel/Boston/Berlin, 2001.
- <sup>4</sup> Rolf Ramcke, *ibid.*
- <sup>5</sup> Fritz Schumacher: *Zeitfragen der Architektur*, Jena, 1929.
- <sup>6</sup> Rolf Ramcke, *ibid.*
- <sup>7</sup> Rolf Ramcke, *ibid.*
- <sup>8</sup> Wolfgang Voigt: *Heinz Bienenfeld 1926–1995*, Tübingen, 1999.
- <sup>9</sup> Fritz Schumacher: *Das Wesen des neuzeitlichen Backsteinbaues*, Munich, 1985.
- <sup>10</sup> Excerpt from his inaugural speech as Director of the Faculty of Architecture at the IIT Chicago.

## Types of construction

### Compartmentation

The building of compartments is a typical trait of masonry construction. By compartments we mean a system of interlinked, fully enclosed spaces whose connections with one another and to the outside consist only of individual openings (windows, doors). The outward appearance is, for a whole host of reasons, “compartment-like”. However, at least this type of construction does present a self-contained building form with simple, cubelike outlines. The compartment system uses the possibilities of the masonry to the full. All the walls can be loaded equally and can stabilise each other, and hence their dimensions (insofar as they are derived from the loadbearing function) can be minimised. The plan layout options are, however, limited.

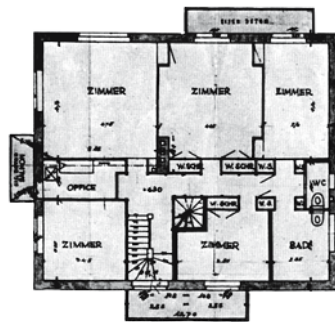


Fig. 71: Compartmentation as a principle: elevation (top) and plan of upper floor (right)  
Adolf Loos: Moller House, Vienna (A), 1928

Of the categories presented here, compartmentation is the oldest type of construction. Constraints were imposed naturally by the materials available – apart from the frame we are aware of coursed masonry and, for floors and roofs, timber joists as valid precepts up until the 19th century. Over centuries these constraints led to the development and establishment of this form of construction in the respective architectural context. In fact, in the past the possibilities of one-way-spanning floor systems (timber joist floors) were not fully exploited. Today, the reinforced concrete slab, which normally spans in two directions, presents us with optimum utilisation options.

The following criteria have considerable influence on the order and discipline of an architectural design:

- the need to limit the depth and orientation of the plans;
- and together with this the independence of horizontal loadbearing systems (timber joists span approx. 4.5 m) at least in one direction;
- and together with this the restriction on the covered areas principally to a few space relationships and layouts;
- openings in loadbearing walls are positioned not at random but rather limited and arranged to suit the loadbearing structure.

Although today we are not necessarily restricted in our choice of materials (because sheer unlimited constructional possibilities are available), economic considerations frequently force similar decisions.

But as long as the range of conditions for compartmentation are related to the construction itself, the buildings are distinguished by a remarkable clarity in their internal organisation and outward appearance. Looked at positively, if we regard the provisional end of compact compartment construction as being in the 1930s (ignoring developments since 1945), it is possible to find good examples, primarily among the residential buildings of that time. After the war, developments led to variations on this theme. The compartmentation principle was solved three-dimensionally and is, in combination with small and mini forms, quite suitable for masonry; through experimentation, however, it would eventually become alienated into a hybrid form, mixed with other types of construction.

### Box frame construction

This is the provision of several or many loadbearing walls in a parallel arrangement enclosing a large number of boxlike spaces subject to identical conditions. The intention behind this form of construction might be, for instance, to create repetitive spaces or buildings facing

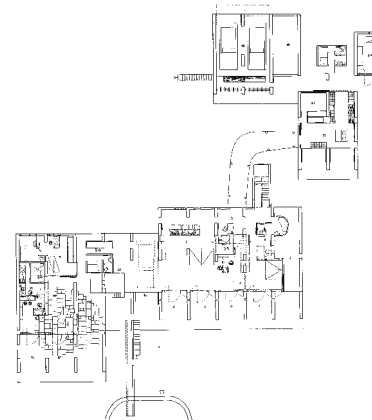


Fig. 72: Box frames as a governing design principle  
Le Corbusier: private house (Sarabhai), Ahmedabad (India), 1955



in a principal direction for reasons of sunlight or the view, or simply the growing need for buildings – linked with the attempt to reach an aesthetic but likewise economical and technically simple basic form. In fact, box frame construction does present an appearance of conformity. After all, a row is without doubt an aesthetic principle which is acknowledged as such.

In terms of construction, a box frame is a series of loadbearing walls transverse to the longitudinal axis of a building, which are joined by the floors to longitudinal walls which stabilise the whole structure. To a certain extent, a true box frame is not possible owing to the need for stability in the longitudinal direction, which is laid down in numerous standards. Therefore, box frame construction is frequently used in conjunction with other categories (compartmentation and plates). The following criteria pre-ordain box frame construction for certain building tasks and restrict its degree of usefulness:

- Restrictions to width of rooms and building by spans that are prescribed in terms of materials, economy, etc. (e.g. one-way-spanning floors).
- Heavy – because they are loadbearing – partitions with correspondingly good insulation properties (“screening” against the neighbours).
- External walls without restrictions on their construction, with maximum light admittance, option of deep plans and favourable facade–plan area ratios.

The first examples of true box frames originated on the drawing boards of architects who wanted to distance themselves from such primary arguments; the large residential estates of the 1920s designed by Taut, Wagner, and May, influenced by industrial methods of manufacture.

### Plates

In contrast to the parallel accumulation of boxes, we assume that plates enable an unrestricted positioning of walls beneath a horizontal loadbearing structure (floor or roof).

So, provided these plates do not surround spaces (too) completely – i.e. do not form compartments – we can create spaces that are demarcated partly by loadbearing

walls (plates) and partly by non-loadbearing elements (e.g. glass partitions). This presupposes the availability of horizontal loadbearing elements which comply with these various conditions in the sense of load relief and transfer of horizontal forces.

We therefore have essentially two criteria:

- A type of spatial (fluid) connection and opening, the likes of which are not possible in the rigid box frame system, but especially in compartmentation.
- The technical restrictions with respect to the suitability of this arrangement for masonry materials; inevitably, the random positioning of walls leads to problems of bearing pressure at the ends of such wall plates or at individual points where concentrated loads from the horizontal elements have to be carried.

Only in special cases will it therefore be possible to create such an unrestricted system from homogeneous masonry (using the option of varying the thickness of the walls or columns).

Nevertheless, we wish to have the option of regarding buildings not as self-contained entities but rather as sequences of spaces and connections from inside and outside. As the wall is, in principle, unprejudiced with regard to functional conditions and design intentions, the various characteristics of the wall can be traced back to the beginnings of modern building.

The catalyst for this development was indubitably Frank Lloyd Wright, who with his “prairie houses”, as he called the first examples, understood how to set standards. The interior spaces intersect, low and broad, and terraces and gardens merge into one.

Mies van der Rohe’s design for a country house in brickwork (1923) is a good example (see “Masonry; Masonry bonds”). Here, he combines the flexible rules of composition with Frank Lloyd Wright’s organic building principles, the fusion with the landscape.

The plan layout is derived exclusively from the functions. The rooms are bounded by plain, straight, and right-angled, intersecting walls, which are elevated to design elements and by extending far into the gardens link the house with its surroundings. Instead of the window apertures so typical of compartmentation, complete wall sections are omitted here to create the openings.

Richard Neutra and Marcel Breuer, representing the International Style, provide further typical examples. The sublimation of the wall to a planar, loadbearing element that completely fulfils an enclosing function as well as is both modern and ancient.

We have to admit that pure forms, like those used by the protagonists of modern building, are on the decline. Combinations of systems are both normal and valid. A chamber can have a stiffening, stabilising effect in the sense of a compartment (this may well be functional if indeed not physical).



Fig. 73: Uninterrupted space continuum  
Marcel Breuer: Robinson House, Williamstown  
(USA), 1948

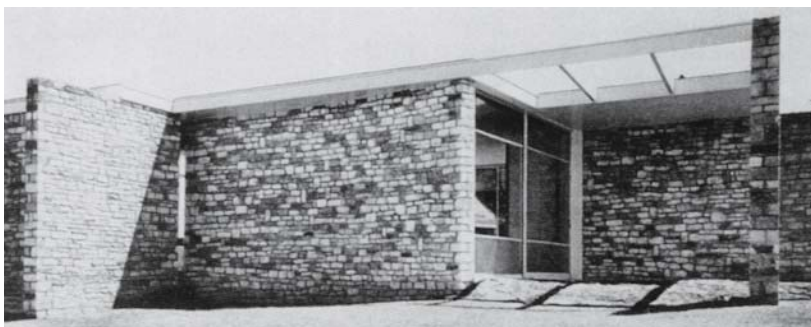
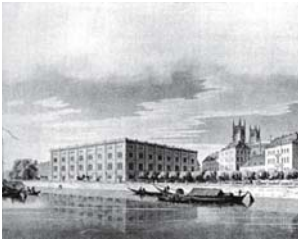


Fig. 74: The openings lend structure to and result from the arrangement of the plates  
Marcel Breuer: Gane's Pavilion, Bristol (GB), 1936

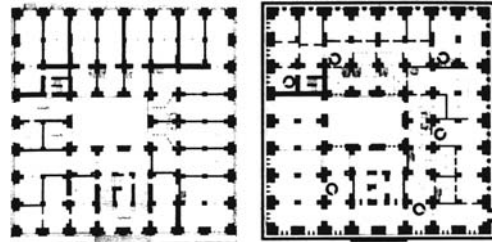
The box frame can be employed to form identical interior spaces. And the straight or right-angled plate permits user-defined elements right up to intervention in the external spaces.

### Schinkel's Academy of Architecture: an example of a grid layout

A close study of the plan layouts of the (no longer existent) Academy of Architecture in Berlin reveals how Schinkel was tied to the column grid when trying to realise the actual internal layout requirements. The possibility of creating interiors without intervening columns, as he had seen and marvelled at on his trip to England in 1826, was not available to him for reasons of cost. The factories in Prussia could not supply any construction systems that



**Fig. 75: Reduction of the structure**  
Karl Friedrich Schinkel: Academy of Architecture (destroyed), Berlin (D), 1836



permitted multi-storey buildings with large-span floors. He therefore had to be content with a system of masonry piers and shallow vaults (jack arches).

The Academy of Architecture was based on a 5.50 x 5.50 m grid. The intersections of the grid lines were marked by masonry columns which, as was customary at the time, narrowed stepwise as they rose through the building, the steps being used to support the floors. Some of these columns were only as high as the vaulting on shallow transverse arches provided for reasons of fire protection. The continuity of the masonry columns was visible only on the external walls. This was a building without loadbearing walls. It would have been extremely enlightening to have been able to return this building to its structural elements just once. It must have had fantastic lines!

The building was braced by wrought iron ties and masonry transverse arches in all directions, joining the columns. A frame was certainly apparent but was not properly realised. At the same time, in his Academy of Architecture Schinkel exploited to the full the opportunities of building with bricks; for compared with modern frame construction, which can make use of mouldable, synthetic and tensile bending-resistant materials (reinforced concrete, steel, timber and wood-based products), the possibilities of masonry units are extremely limited. Schinkel managed to coax the utmost out of the traditional clay brickwork and accomplished an incredible clarity and unity on an architectural, spatial, and building technology level.

Owing to the faulted subsoil, the chosen form of construction led to major settlement problems because the columns had to carry different compression loads. Flaminius described the problems that occurred: "There are no long, continuous walls with small or even no openings on which the total load of the building can be supported and where the cohesion of the masonry transfers such a significant moment to balance the low horizontal thrust that every small opening generates; instead, the whole load is distributed over a system of columns which stand on a comparatively small plan area and at the various points within their height are subjected to a number of significant compression loads acting in the most diverse directions... Only after the columns collect the total vertical load they should carry and, with their maximum height, have been given a significant degree of strength should the windows with their arches, lintels, and spandrel panels be gradually added and the entire finer cladding material for cornices and ornaments incorporated. Only in this way is it possible, if not to avoid totally the settlement of the building or individual parts of the same, but to at least divert it from those parts that suffer most from unequal compression and in which the effects of the same are most conspicuous."



## Prefabrication

Barbara Wiskemann

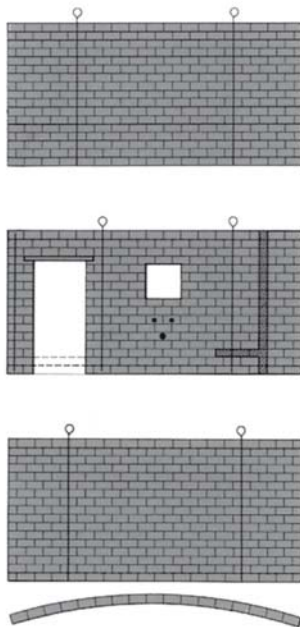


Fig. 76: Proposals (schematic) for various masonry elements  
Examples from a Swiss manufacturer: "preton" element catalogue

### Rationalisation in the craftsman-like tradition

Factory prefabrication in the brickmaking industry has been driven in recent years primarily by economic considerations. The aim is to ensure that the traditional, time-consuming method of masonry construction, the nature of which consists of labour-intensive manual work on the building site, remains competitive with other methods of building. Apart from that, the quality of a masonry element has always been heavily dependent on the quality of workmanship and the weather. There are companies that can supply industrially prefabricated, custom-made masonry walls to suit individual projects. Such elements include reinforcement to cope with the stresses of transport to the building site and on-site handling by crane (e.g. "preton" elements), and can be ordered complete with all openings and slots for services etc.

This form of construction renders possible accurate scheduling of building operations, reduces the cost of erection and speeds up progress (making the whole procedure less susceptible to the vagaries of the weather). In addition, the components can be delivered without any construction moisture. On the other hand, they call for very precise advance planning and heavy lifting equipment on site. Another disadvantage is that there is little leeway for subsequent alterations, and none at all once the elements have arrived on site.

Such prefabricated masonry elements can be produced in different ways. One method is to construct them vertically from bricks and mortar (i.e. normally), but they can also be laid horizontally in a form, reinforced and provided with a concrete backing. Some bricks are produced with perforations for reinforcing bars. Furthermore, masonry handling plant has been developed in order to minimise the manual work in the factory.

It is also possible to combine conventional, in situ work with prefabricated elements; for example, the reveal to a circular opening, or an arched lintel – factory prefabricated – can be inserted into a wall built in the conventional manner.

On the whole it is reasonable to say that owing to the high cost of the detailed, manual jointing of masonry units to form a masonry bond such work can be replaced by erecting large-format, heavy, prefabricated masonry elements. Of course, the aim is to limit the variation between elements and to produce a large number of identical elements. Consequently, there is a high degree of standardisation. And a new problem arises: the horizontal and vertical joints between the prefabricated wall elements.



Fig. 77: Examples from a Swiss manufacturer: "preton" element catalogue  
Masonry elements being erected at the Swisscom headquarters by Burkard, Meyer in Winterthur





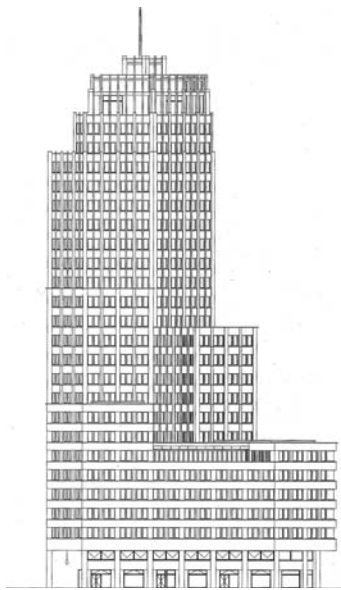


Fig. 82: West elevation, divided vertically into five segments: plinth, block, middle, tower, apex  
Hans Kollhoff: high-rise block, Potsdamer Platz, Berlin (D), 1999

*Hans Kollhoff: high-rise block, Potsdamer Platz, Berlin*

The original plan was to construct a 100-m-high brick wall in Gothic bond. To do this, every bricklayer would have needed several stacks of bricks in various colours, plus specials, within reach on a 100-m-high scaffold. Owing to the load of the bricks, the hoists for the materials and the safety requirements, a very substantial, very expensive scaffold would have been needed for the entire duration of the project. In the light of the enormous size of the building and the complex logistics on the confined site in the centre of Berlin, the architects decided to use prefabricated components for the cladding. The industrially prefabricated facade elements were erected after the layer of insulation had been attached to the conventional loadbearing in situ concrete frame. The windows were installed last.

Individual parts such as spandrel panels, column cladding, lesenes, and mullions make up the tectonic fabric of the facade. Their depth and (partial) profiling result in a

massive, sculpted overall effect that evokes a masonry building. The principle of facade relief is employed elegantly here in the form of overlapping elements in order to conceal the unavoidable joints with their permanently elastic filling. As, on the one hand, the building does not have a rectangular footprint and, on the other, the facade is divided into five different sections (plinth, block, middle, tower, and apex), there are very many different facade elements.

The production of the prefabricated elements was a complex process. Steel forms were used to minimise the tolerances. Rubber dies were laid in these with accurate three-dimensional joint layouts. This enabled the hard-fired bricks (the outermost layer of the element), cut lengthwise, to be laid precisely in the form. The next stage involved filling the joints with a concrete mix coloured with a dark pigment. The reinforcement was then placed on this external, still not fully stable facing and the form filled with normal-weight concrete. The porous surface of the hard-fired bricks resulted in an inseparable bond between the protective brick facing and the stabilising concrete backing. To create the (intended) impression of solid brickwork, specials were used at all edges and corners instead of the halved bricks.

The hard-fired bricks therefore assume no loadbearing functions and instead merely form a protective layer over the concrete. On the other hand, it is precisely the use of such bricks that promote the idea of the tower, i.e. mankind's presumption to want to build a skyscraper from thousands of tiny bricks. (Is that perhaps the reason behind the Gothic bond?) And in addition they paradoxically stand for the image of supporting and loading as well; in the plasticity of the facade they in no way appear to be merely "wallpaper".

As masonry materials have only a limited compressive strength, their use for high-rise loadbearing structures is limited – the tallest self-supporting clay brickwork building is the Monadnock Building in Chicago (18 storeys and external walls 2 m thick at ground-floor level!). Prefabricated facades therefore represent a satisfactory solution for high-rise buildings.

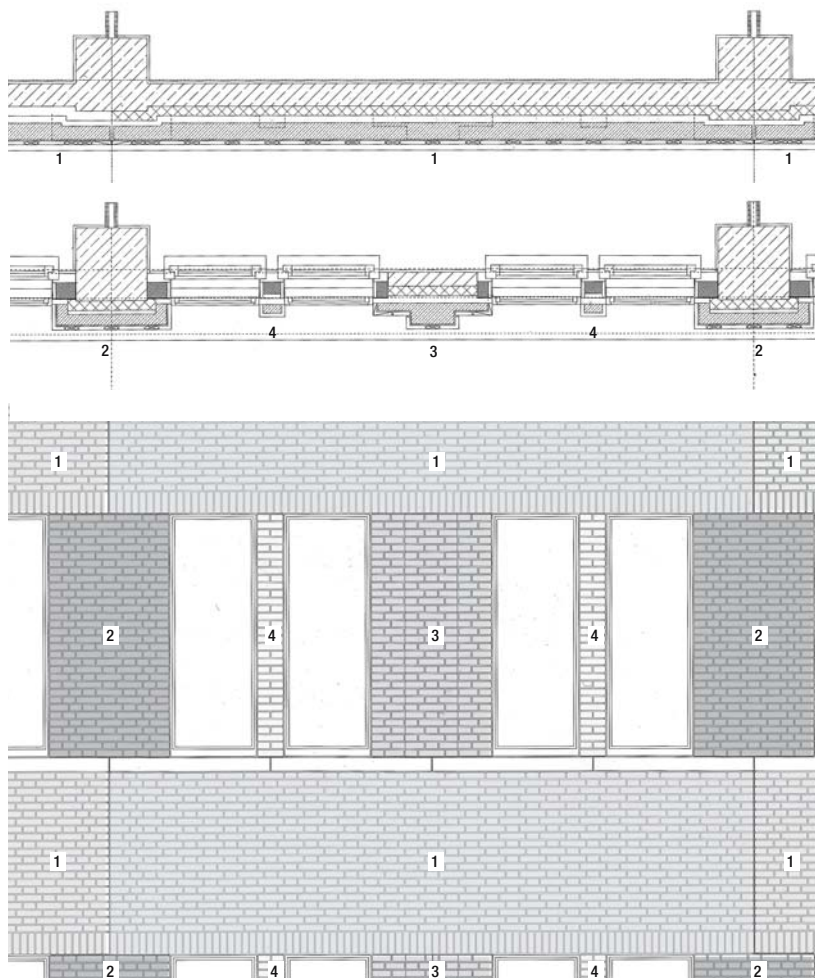


Fig. 83: Details of facade cladding to block: horizontal section through spandrel panel, horizontal section through windows, and elevation on windows and spandrel panel showing individual prefabricated parts and joints: 1 spandrel panel element, 2 column cladding, 3 lesene, 4 mullion

Hans Kollhoff: high-rise block, Potsdamer Platz, Berlin (D), 1999

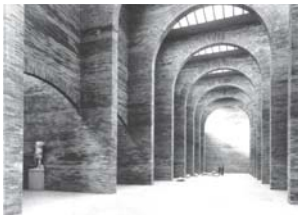


Fig. 84: Interior view  
Rafael Moneo: Museo de Arte Romano, Mérida (E), 1986

### Prefabrication and *opus caementitium*

The impressive building housing the Museum of Roman Art in Mérida, which is built on part of the largest Roman settlement in Spain, Augusta Emerita, consists of a series of massive arches and flying buttresses plus solid walls. In the early 1980s during the construction of the museum the architect, Rafael Moneo, explained in a lecture at the ETH Zurich how he had managed to combine modern prefabrication and Roman building techniques in this project. The enormous arches, columns, and walls were prefabricated using an ingenious method allied to the Roman technique of *opus caementitium*. (see “On the metaphysics of exposed concrete”). In the end, this represents a successful attempt to use an old method satisfactorily.

The concrete was poured between two slender leaves of hard-fired bricks with a very flat format; the finished wall thickness is equal to twice the brick (i.e. leaf) width plus the distance between the leaves. The concrete forms the core of the wall and binds the two leaves together. For their part, these leaves form the “attractive” surface and can be regarded as permanent formwork, which has to withstand the pressure of the wet concrete during casting and provide stability. But without the concrete core the masonry would be totally inadequate for the structural requirements of this building. In the Mérida project the clay bricks, which owing to their very flat format are reminiscent of Roman bricks, form the visible part of the loadbearing structure internally and externally. The concrete is used like a loose-fill material, which is why it is not reinforced. Together with the bricks it forms a compression-resistant element. The design of the loadbearing

structure is such that all forces can be carried without the need for reinforcement. Masonry arches or exposed concrete lintels are incorporated over openings. The prefabricated components, e.g. for walls and columns, were incorporated in the form of “clay pipes”, which were assembled with a crane to form storey-high walls that were filled with concrete section by section.

As the external walls are not insulated, the prefabricated units produced in this way needed only minimal butt

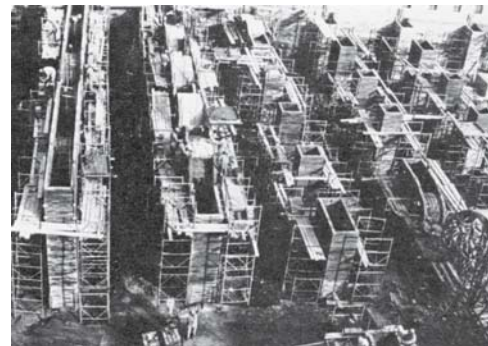


Fig. 86: View during construction showing the “clay pipes”  
Rafael Moneo: Museo de Arte Romano, Mérida (E), 1986

joints, which are lost within the pattern of the brickwork. There are two options for the vertical joints: the hard-fired bricks can either be interlocked with each other (which would, however, mean high wastage), or the prefabricated units can be erected to leave a gap which is filled with masonry by hand (“zip” principle) and the concrete core cast later.

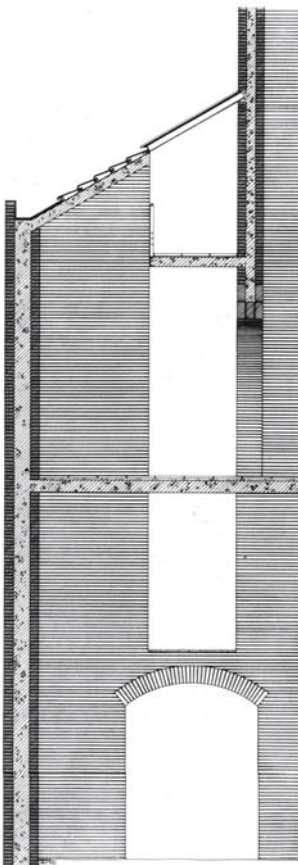
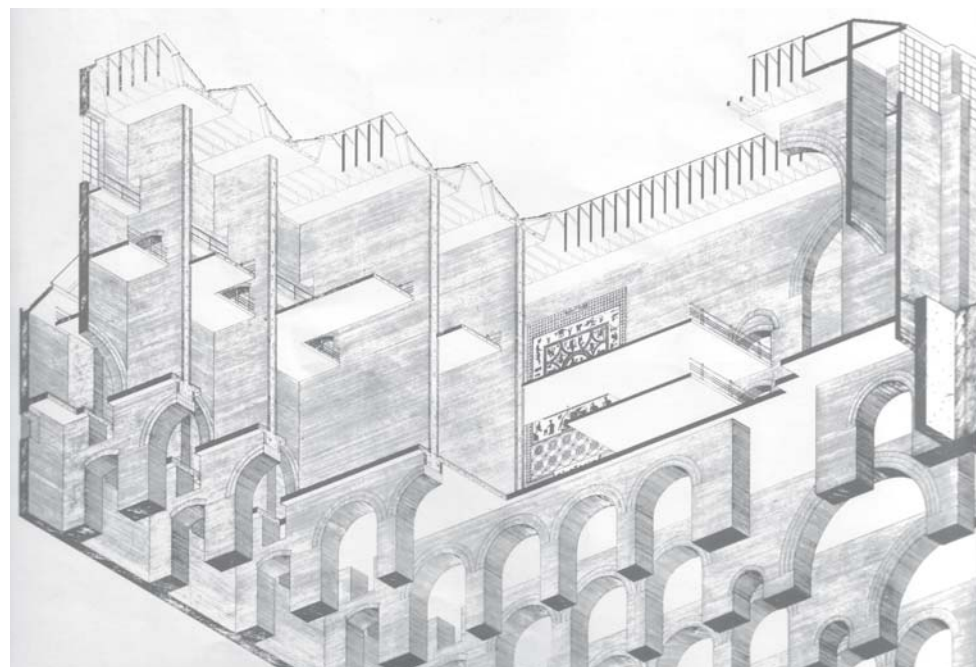


Fig. 85: Top: section through *opus caementitium* wall; right: axonometric view of structure  
Rafael Moneo: Museo de Arte Romano, Mérida (E), 1986





## On the metaphysics of exposed concrete

Andrea Deplazes



Fig. 1: Formwork “fingerprint”  
Rough-sawn boards

Loadbearing structures made of reinforced concrete characterise everyday urban life. Whenever possible, the construction industry employs this material. It is relatively inexpensive in comparison with other building materials – as work on the building site progresses swiftly and (seemingly) no highly qualified specialists are required to install it. Reinforced concrete has simply become the 20th century’s building material of choice – and the symbol of unbridled building activity. The “concreting of the environment” is a proverbial invective denouncing the destruction of landscape, nature and habitats.

However, the less visible reinforced concrete is – if it only serves as a “constructional means to an end” in the true sense of the word, i.e., for engineering purposes or the structural shell, and is later plastered or rendered –, the more acceptable it seems to be (whether out of resignation or disinterest does not matter, as often there seems to be no competitive alternative to concrete). It’s a completely different story with reinforced concrete designed to be openly visible, with so-called fair-face concrete. In order to recognise the characteristics of exposed concrete we have to distance ourselves from today’s pragmatic approach. The term “exposed concrete” itself makes us sit up. If there is no invisible concrete, what is it that makes concrete become exposed? And if reinforced concrete is not used visibly, but as a “constructional means to an end”, how does it influence the development and design of form?

### Surface

With exposed concrete, what is visible is the concrete surface. This seemingly unspectacular observation becomes significant when we draw comparisons with facing masonry. Facing masonry demonstrates the order and logic of its bonded texture and jointing as well as the precision and the course of the building operations. The brickwork bond is therefore more than the sum of its parts, its structure is perceived as an aesthetic ornamentation, fixing or depicting a “true state of affairs”. Louis Kahn argued that ornamentation – unlike decoration, which is applied, is a “foreign” addition – always develops from tectonic interfaces up to the point of independence (through the transformation of materials and the emancipation of originally constructional functions). Against the background of such a cultural view, aesthetics means: “Beauty is the splendour of the truth” (Mies van der Rohe’s interpretation of St Augustine applied to modern building culture).

In contrast to this, exposed concrete – or rather the cement “skin” two or three millimetres thick – hides its internal composite nature. Exposed concrete does not disclose its inner workings, but instead hides its basic structure under an extremely thin outer layer. This surface layer formalises and withholds what our senses could perceive: an understanding of the concrete’s composition and “how it works”. And this is why concrete is not perceived as the natural building material it really is, but rather as an “artificial, contaminated conglomerate”.



### Formwork

But although no visible “powers of design” from inside the concrete conglomerate penetrate the thin outer layer, the surface still exhibits texture – traces of a structure that no longer exists: the formwork. All that can still be detected on exposed concrete are “fingerprints”. The term “texture” stems from the same origin as “text” or “textile” – meaning fabric – and thus immediately hints at what earlier on has been dubbed “filigree construction”. The formwork, made of timber or steel, belongs to this category of tectonics. Especially in the early stages of reinforced concrete technology, it was an autonomous, usually quite artful – albeit temporary – work of carpentry (e.g. Richard Coray’s bridge centering). Formwork and concrete form a seemingly inseparable package.

As the concrete has to be poured into formwork in order to take on the desired form, three questions arise: Isn’t every type of concrete in the end exposed concrete? (That is, how do we classify the quality of the concrete surface?) Which criteria apply to the design of the formwork? (That is, how do the materials and techniques of formwork construction influence the moulding of the concrete?) Isn’t it odd that an ephemeral structure (filigree construction) is set up in order to generate another, monolithic one (solid construction)? (That is, what are the characteristics that tie concrete to its formwork?)

### Incrustation

The Roman builders tried to counteract this metamorphic inconceivability by “exposing” the concrete’s inner structure, while concealing its practical component – this unspectacular mixture of gravel, sand and cement. *Opus caementitium* is a composite of permanent stone or brick formwork with a “loose-fill” core of concrete. The concrete comprises the same materials as the “formwork” – in various grain sizes mixed with water and appropriate binding agents like hydrated lime or cement and worked into a pulp.

It’s obvious that this – just like building with cob – is one of the most original creations of earthworks; the shapeless earthen pulp proves its worth in coursed masonry. This kind of exposed concrete construction has been preserved to this day, e.g. in the viaducts of the Rhätische railway line. It lends visible structure and expression to a mixture of materials that on its own has no quality of form, in the sense of a “reading” of the concrete sediment through the technique of incrustation: a kind of “permanent formwork” made of stone or brickwork, which at the same time forms a characterising crust on its visible surface.

### Transformation

The other line of development, the “strategy of formwork construction” mentioned above, leads through timber

construction and carpentry, hence through tectonics, which has its own laws of construction and thus already influences the form-finding process of the concrete pour. Moreover, wood has a transitory and provisional character, which seems to predestine its use for formwork. It seems that within our image of the world, our ethical and religious understanding of nature and life, durability can only be achieved through transitoriness and constant renewal (optimisation).

This triggers – consciously or unconsciously – a process of transformation; for the transfer of timber to stone construction is another fundamental topic within the morphological development of Western architecture. Although – as with ancient temples – the laws of stone construction are applied, the original timber structures remain visible as ornamental, stylistic elements. In other words, technological immanence, advancing incessantly, stands face to face with recalcitrant cultural permanence.

It is the same with exposed concrete, where through the simple act of filling the formwork with concrete the underlying timber manifests itself, even though the concrete pulp, now hardened within the formwork, has nothing to do with timber and is anything but ephemeral.

Is this a clear contradiction to the plastic-cubic shape of a concrete block, which moreover has the appearance of being cast in stone?

### Monolith

The monolithic appearance of exposed concrete makes a building look like a processed blank or sculpture, a workpiece created by removing material from a block. This is especially successful if the traces of the concreting work – the lifts, the pours – are suppressed or obscured by the thickly textured traces of the formwork. In reality, however, this character is the result of several cumulative operations!

The quality of the formwork, its make-up, plays a significant role in moulding a building’s character. Sometimes it is coarse, lumpy, with leaking joints and honeycombing. As a result the conglomerate structure of a sedimentary rock and the metaphor of an archaic foundling can sometimes still be felt, e.g. in Rudolf Olgiati’s Allemann House, set amid a precarious topography. At other times the formwork boasts skin-like smoothness, with formwork joints looking like the seams of a tent, which lends the exposed concrete a visual quality devoid of any “heaviness”. This is the case with Koshino House by Tadao Ando. Here, the formwork is so smooth that, together with the concrete’s tiny height differences, it lends the walls a textile materiality or even “ceramic fragility” when viewed with the light shining across its surface.



Fig. 2: Tadao Ando  
Koshino House, Ashiya (J), 1980



Fig. 3: Rudolf Olgiati  
House for Dr Allemann, Wildhaus (CH), 1968

### Hybrid

Having based our evaluations on pragmatic working methods, we find an unexpectedly complex result: the building as a heavy, monolithic edifice represents the dialectal pole of our observations by establishing the significant characteristics of exposed concrete's earthen component: mass, weight, plasticity, body, density, pressure. Consequently, we assume the other pole has to be derived from the filigree construction, which would allow one to deduce new form-finding criteria. The combination of concrete and steel basically creates a unique hybrid material, within which the concrete guarantees compressive strength. The steel, for its part, provides the tensile strength in the form of a reinforcing mesh, a tension net created from a minimum of material. Reinforced concrete is the only building material that possesses this perfect bi-polar quality. The term "hybrid", however, has to be defined more precisely: the two morphologic components exist and complement each other on different "levels of consciousness" – constantly interacting and shifting from one system to the other, from the consciously perceivable to the subconscious and vice versa. This is in contrast to structural steelwork, for example, where one and the same member can resist both compressive and tensile forces.) The outer form of the hardened concrete is physically perceptible (visually, sense of touch, acoustically, etc.), and has completely shed the dull metaphysical quality it possessed in its original form, its embryonic state as an earthen pulp. Its Cartesian network of reinforcement, however, lies dormant within, although altogether invisible to the eye. On the outside, its existence manifests itself only indirectly. It can only be divined and "sensed", with the most delicate of all loadbearing structures in exposed concrete seemingly defying all the laws of physics. The formerly heavy, solid monolith loses its ground-based nature and is transformed into the opposite, e.g. a space frame of linear members, a leaf-like shell, a vertical stack of thin slabs and supporting rods, etc.

In his theory of architecture, Carl Bötticher defines these two "levels of consciousness" as an "art form" (external, possessing a cultural connotation, tectonics) and a "core form" (internal, function, Newtonian physics). As a design rule Bötticher required that both forms correspond logically in the best possible way, with the "core" – as "true fact", reflecting from inside to outside – merging into one with its artfully fashioned envelope or surface, pupating in it and thus taking on a visible form (iconography).

This theory and the circumstance that concrete depends on the rational availability of formwork correspond with the scientific, engineering view of the energy flow deep below the surface. This is actually – for technological reasons! – an intensification of formerly visible tectonic form criteria (e.g. the visualisation of load and column present in the orders of ancient temple-building). It



Fig. 4: Outer form and inner life

is an inversion of outer form and core, smoothing and thus formalising the outer form. (Example: the morphology of the column.) The formerly visible tectonic balance of power apparent in the outer form is now turned inside out like a glove and rationalised after the model of three-dimensional tension trajectories, a model which the accumulation and bundling of the reinforcement seeks to follow and correspond with as closely as possible.

### Skeleton structures

Here lies the source of an agreement that engineers speaking on form-finding for loadbearing structures, e.g. for bridges or tunnels, like to refer to when they present the complex logic of energy flows as "the motor that powers form". More often than not, however, the outer form develops in accordance with the critical cross-section of a structural component and the most economic formwork material available. Over time this material has developed from a one-off to a reusable one. Through distinct stages of formwork construction, the building process has become more organised, and the construction itself now shows traces of the modularity of the formwork layout and the large sheet steel prefabricated formwork panels. The flow of forces, however, is organised according to the actual energy concentration through bundling and distributing the reinforcement deep inside the concrete, and this seldom influences the external form.

The delicate constructions resulting from this approach seem to originate from pure science, powered by the spirit of rationalism, operating with analysis, geometry, order and abstraction. Consequently, we try to rid the exposed concrete of all "worldly" traces, to achieve its transition from a primitive past as an "earthwork" to a smooth, seamless artefact, unsoiled by any working process.

Equally telling is the expression "skeleton structure", which I heard being used by several engineers explaining the character of their bridge designs. One described a complete, elementary de-emotionalisation "from inside to outside", which only manifested itself through utmost abstraction of form and a reduction to the naked loadbearing structure in the form of simple geometrical elements. Another described a biomorphic analogy with a skeleton. A natural skeleton structure, however, develops in a self-organised way along a network of tension trajectories. Its form is the immediate result of this network taking into account the position of its parts within the static and dynamic conditions of the skeleton as a whole. For the reasons mentioned earlier, such congruencies of cause and effect, energy and form are not feasible and seldom advisable.



Fig. 5: The skeletal frame

### Liberated concrete

Another idiosyncrasy has to be discussed. Concrete, being a blend (amalgam), does not have any implicit form – it can be moulded into any shape imaginable. In the same way the steel mesh making up the reinforcement does not have any preconfigured limitations, no “boundary”. This implies the possibility of a free, biomorphic workability of reinforced concrete – comparable to the process of modelling a lump of clay in the hand. In reality, however, the inflexibility of the formwork, its characteristic tectonic rigidity, must be overcome. This is possible with the help of the adhesives of modern timber engineering (moulded plywood) or synthetic fibres, but such solutions are difficult to justify economically. (Example: “Einstein Tower” Observatory by Erich Mendelsohn, planned in reinforced concrete but finally built in rendered brickwork). The only way out would be to release the concrete from its formwork – that tectonic, technological and iconographic corset! This can be done by using a flexible but relatively stable reinforcing mesh and sprayed concrete (e.g. Gunit, Shotcrete). So far, this technology in exposed concrete construction has left no noteworthy traces in architecture – except for the pitiful interior decoration found at some provincial dancehalls. Sadly, the liberated exposed concrete of such examples is only reduced to its primitive origins – the metaphor of a dull, platonic earthen cavern.

### Conclusion

1. Despite the fact that exposed concrete is designed and developed according to rational and technical arguments, seemingly irrational construction processes abound.

2. Exposed concrete represents the outcome of various transformation processes and metamorphoses that have left their mark (a kind of “memory” of or former states).

3. A precarious congruency exists between outer form and “inner life”. The thin surface layer of exposed concrete seldom plays the role of the iconographic mediator.

4. The quality of the concrete surface characterises the building as a whole within its architectural theme. It tends towards either the archaic or the abstract.

5. Form is defined as the pre-effected synthesis of various influencing factors, with technological immanence rarely correlating with cultural permanence.

6. The concrete form is relative to the internal flow of forces. This flow is interpreted either as a system in equilibrium based on constructional and spiritual factors, or as a stress model with foundations in natural science and reality.

7. Every kind of concrete shows a face.



Fig. 6: Erich Mendelsohn  
“Einstein Tower” Observatory, Potsdam (D), 1914

### Further reading

- Carl Bötticher: *Die Tektonik der Hellenen*, Potsdam, 1852.
- Louis I. Kahn: *Die Architektur und die Stille. Gespräche und Feststellungen*, Basel, 1993.
- Fritz Neumeyer: *Ludwig Mies van der Rohe. Das Kunstlose Wort. Gedanken zur Baukunst*, Berlin, 1986.
- Werner Oechslin: *Stilhölse und Kern: Otto Wagner, Adolf Loos und der evolutionäre Weg zur modernen Architektur*, Zurich, 1994.
- Gottfried Semper: *Der Stil in den technischen und tektonischen Künsten ...*, vol. I, Frankfurt a. M., 1860, vol. II, Munich, 1863.  
– English translation: Gottfried Semper: *Style, in the Technical and Tectonic Arts; or, Practical Aesthetics*, Los Angeles, 2004.
- Eugène Viollet-le-Duc: *Definitionen. Sieben Stichworte aus dem Dictionnaire raisonné de l'architecture*, Basel, 1993.  
– English translation: Eugène Viollet-le-Duc: *The Foundations of Architecture: Selections from the Dictionnaire raisonné*, Basel 1993.
- Urs Widmer: *5 Schweizer Brückenbauer: Othmar H. Ammann, Richard Coray, Guillaume-Henri Dufour, Hans Ulrich Grubenmann, Robert Maillart*, Zurich, 1985.
- Roland Barthes: *The Eiffel Tower and Other Mythologies*, trans. Richard Howard, New York, c 1978.

## The materials

Normal-weight concrete (density 2400–2550 kg/m<sup>3</sup>) is generally produced by mixing together cement, water, fine and coarse aggregates (sand and gravel respectively) in the following ratios:

- aggregates, grain size 0–32 mm    2000 kg/m<sup>3</sup>
- Portland cement                      250–400 kg/m<sup>3</sup>
- water                                      150 kg/m<sup>3</sup>

Depending on the desired properties this ratio can be varied both during production and after hardening.

Wet concrete should exhibit the following properties:

- easy workability – good compactability
- plastic consistency – easy mouldability
- good cohesion – low segregation tendency
- good water-retention capacity – no tendency to “bleed” (water seeping from the wet concrete)

The requirements for hardened concrete are as follows:

- good strength
- homogeneous, dense and consistent concrete micro-structure
- uniform surface structure without blowholes
- resistance to the weather and external influences

The wet concrete properties given above are closely related to the proportions of aggregates, ultra-fine particles, cement, water and cement paste. Changing any one of these variables can also change the properties of the wet and/or hardened concrete.

### Composition of concrete

In terms of its weight and its volume, concrete consists primarily of aggregate. But the situation is somewhat different if we consider the internal surface area, i.e. the cumulative surface areas of all the constituents of the concrete. In this case the cement proportion is by far the largest. And because of its ability to react with water, the cement is also the sole constituent that causes the concrete to set.

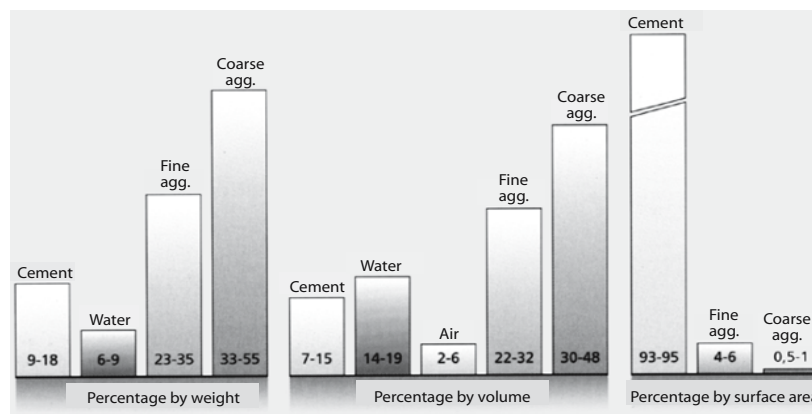


Fig. 7: Composition of concrete

### Concrete mixes

When deciding on the composition of the concrete, the concrete mix, the prime aim is to optimise

- the workability of the concrete,
- its strength,
- its durability,
- the cost of its production.

### Cement

Cement is a hydraulic binder, i.e. a substance which after mixing with water sets both in air and also underwater.

### Production

The production of cement involves preparing the raw material in terms of its grain size and composition, heating this until sintering takes place and finally crushing the heated product to form a fine, mixable and reactive cement powder. Basically, the production of cement involves four production stages:

#### 1. Extraction and breaking-up of the raw material

One tonne of Portland cement requires 1.5 tonnes of raw material in the form of limestone and marl or clay because carbon dioxide and water are driven off during the heating process. The rocks are first broken down to fist size at the quarry.

#### 2. Mixing and crushing the raw material to form a dust

At this stage the various raw materials are mixed together to achieve the correct chemical composition. The rocks are crushed in ballmills and dried at the same time. They leave the mill as a fine dust which is thoroughly mixed in large homogenisation silos to achieve better consistency.

#### 3. Heating the dust to produce clinker

The heating process (approx. 1450°C) is a key operation in the production of cement. Before the dust is fed into the rotary kiln, it flows through the heat exchanger tower where it is preheated to nearly 1000°C. After heating, the red-hot clinker leaves the kiln and is cooled quickly with air. Coal, oil, natural gas and, increasingly, alternatives such as scrap wood or dried sewage sludge are used as the fuel.

#### 4. Grinding the clinker with gypsum and additives to form cement

In order to produce a reactive product from the clinker, it is ground in a ballmill together with a little gypsum as a setting regulator. Depending on the type of cement required, some of the clinker is mixed with mineral substances (limestone, silica dust, cinder sand [granulated blast furnace slag], pulverised fuel ash) during grinding, thereby producing other types of Portland cement.

### Water

This is not just the potable water added during the mixing process but instead, the entire quantity of water contained in wet concrete; this total amount must be taken into

account when determining the water/cement ratio. The water in the concrete is made up of:

- the water for mixing
- the surface moisture of the aggregates, if applicable, the water content of concrete additives and admixtures

The total water content has two concrete technology functions. Firstly, to achieve hydration of the cement; secondly, to create a plastic, easily compacted concrete.

### Aggregates

The term aggregates normally covers a mixture of (finer) sand and (coarser) gravel with a range of grain sizes. This blend of individual components forms the framework for the concrete and should be assembled with a minimum of voids. The aggregates influence most of the properties of concrete, but generally not to the extent we might assume given their volumetric proportion in the concrete. A good-quality aggregate has various advantages over the surrounding, binding, hydrated cement:

- normally a higher strength
- better durability
- no change in volume due to moisture, hence a reduction in the shrinkage mass of the concrete
- absorbs the heat of hydration and hence exercises an attenuating effect during the curing process

The most important properties of aggregates are:

- density
- bulk density
- moisture content
- quality of stone, grain form and surface characteristics
- cleanliness

### Grading

Porous and excessively soft materials impair the quality of the concrete. The grain form, but mainly its grading and the surface characteristics determine the compactability and water requirement.

Practical experience has shown that all-in aggregates with exclusively angular grains are serviceable. Angular aggregates can improve the compressive strength, tensile strength and abrasion resistance of the concrete, but do impair its workability. Owing to the limited number of workable deposits of gravel still available in Switzerland, angular and recycled aggregates will have to be employed more and more in future.

The water requirement, and hence one of the most important properties of an aggregate, is governed by grading, the surface characteristics, the specific surface area and the form of the individual grains. The grading must guarantee a blend with minimum voids and optimum

compactability (high density = good quality characteristics).

The grading of an all-in aggregate is determined by the ratios of the proportions of the individual grain sizes. Sieving the mixture with standardised mesh and square-hole sieves results in a certain amount being retained on every sieve. These amounts are weighed separately and plotted (cumulatively) on a graph against the sieve size in percentage by weight of the mixture to produce the grading curve of the aggregate (see fig. 12).

According to Swiss standard SIA 162, 5 14 24, the grading for a rounded gravel/sand material must lie within the shaded area of the grading curve unless a different grading curve is established beforehand by trials.



Fig. 8: Natural/rounded cubical grains Fig. 9: Angular cubical grains

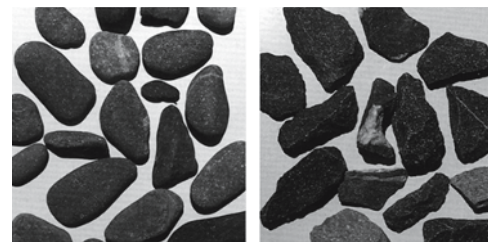


Fig. 10: Natural elongated grains Fig. 11: Angular elongated grains

### Concrete admixtures

#### Definition and classification

Concrete admixtures are solutions or suspensions of substances in water that are mixed into the concrete in order to change the properties of the wet and/or hardened concrete, e.g. workability, curing, hardening or frost resistance, by means of a chemical and/or physical action.

The modern building chemicals industry has developed a whole series of admixtures for influencing the properties of the concrete:

- Plasticisers: These achieve better workability, easier placing, etc. for the same water/cement ratio. So they enable the use of low water/cement ratios, which benefits the strength.
- Thickeners: These prevent premature segregation and improve the consistency. Particularly useful for fair-face concrete.
- Retarders: By delaying the reaction these products ensure that the wet concrete can still be compacted



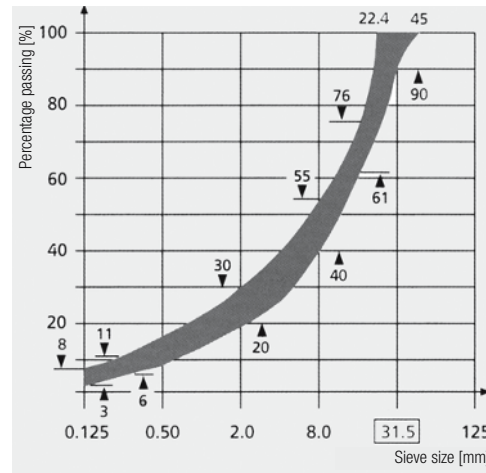


Fig. 12: Grading curve

many hours after being placed. Construction joints can thus be avoided. They are primarily used for large mass concrete and waterproof concrete components.

- Accelerators: Through more rapid hydration these encourage faster setting. This may be desirable for timetable reasons (faster progress) or for special applications, e.g. sprayed concrete.
- Air entrainers: These create air-filled micropores (~0.3 mm). Such pores interrupt the capillaries and thus enhance the frost resistance.

The use of admixtures requires careful clarification and planning. Excessive amounts can lead to segregation, severe shrinkage, loss of strength, etc.

There are economic and technical reasons for using concrete admixtures. They can lower the cost of labour and materials. Their application can save energy and simplify concreting operations. Indeed, certain properties of the wet and hardened concrete can be achieved only through the use of concrete admixtures.

However, in the relevant Swiss standards concrete admixtures are not dealt with in detail. Indeed, often no distinction is made between a concrete admixture and a concrete additive.

### Concrete additives

Concrete additives are very fine substances that influence certain properties of the concrete, primarily the workability of the wet concrete and the strength and density of the hardened concrete. In contrast to concrete admixtures, all the additives are generally added in such large quantities that their proportion must be taken into account in the volume calculations.

In Switzerland the common concrete additives in use are:

- Inert additives (do not react with cement and water): inorganic pigments, used to colour concrete and mortar; fibrous materials, especially steel and synthetics, seldom glass fibres.
- Pozzolanic additives (react with substances released during hydration): contribute to developing strength and improving the density of the hydrated cement.

## The concreting process

### Reinforcement

Reinforced concrete is a composite material consisting of concrete and steel. The interaction of these two materials – the reinforcement resisting the tensile stresses, the concrete resisting the compressive stresses – is not an additive process, but rather leads to a new loadbearing quality. The size of the reinforcement is determined in a structural analysis which takes into account the internal forces. To simplify the process the main reinforcement is positioned at the most important sections to suit the maximum bending moments. Apart from the structural require-

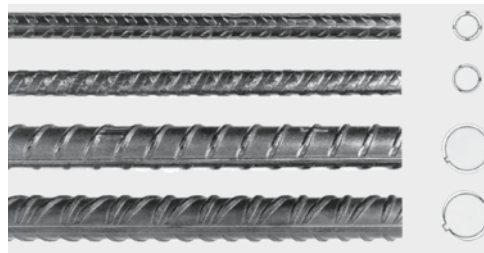


Fig. 13: Profiles of reinforcing bars

ments, the arrangement and spacing of reinforcing bars and meshes also has to take account of optimum compaction; a poker vibrator must be able to pass through the cage of reinforcement.

Great attention must be paid to ensuring that the reinforcement has adequate concrete cover. Almost all damage to reinforced concrete structures can be attributed to insufficient concrete cover and not settlement or a lack of reinforcement. Sections with inadequate concrete cover are potential weak spots and invite corrosion of the reinforcing bars. The oxide crystals of the rust require more volume than the steel, and the ensuing bursting action results in the concrete cover cracking, thus allowing further corroding influences (moisture, air) even easier access to the steel, which can, in the end, impair the load-carrying capacity of the member. The concrete cover, i.e. the distance between the concrete surface (or the surface of the formwork) and the nearest reinforcing bars, depends on various factors but should not be less than 3 cm.



Fig. 14: Timber formwork with formwork ties

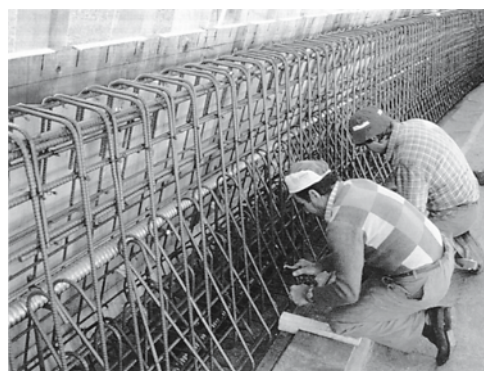


Fig. 15: Steelfixers at work

### Formwork

In order to achieve the desired final form, concrete is cast in formwork.

Concrete cast in formwork on the building site is known as *in situ concrete*. The concrete cast in a factory, to produce *prefabricated components*, is known as *precast concrete*.

The building of formwork for concrete sometimes calls for excellent carpentry skills. The formwork material itself must be of sufficient strength and must represent a stable assembly propped and stiffened so that it remains dimensionally accurate (no distortion) during placing and compaction of the concrete.

All butt and construction joints must be sealed with appropriate materials, and the formwork must be leak-proof on all sides to prevent cement paste from escaping during compaction.

Formwork for concrete surfaces that are to remain exposed in the finished building can make use of a number of materials depending on the type of surface required, e.g. timber boards, wood-based panels, sheet steel; even fibre-cement, corrugated sheet metal, glass, rubber or plastic inlays are used on occasions.

### Timber formwork

#### Boards

In Switzerland the timber boards used for formwork are mainly indigenous species such as spruce or pine. The selection and assembly of the boards presumes a certain level of knowledge and experience. Boards of the same age having the same density and same resin content will exhibit similar absorption behaviour; boards with a high or low resin content can be seen to behave differently as soon as the release agent (oil, wax emulsion) is applied. Concrete surfaces cast against new, highly absorbent boards will have a lighter colour than those cast against old or reused boards.

Format: The dimensions are governed by the possibilities for solid timber. The boards should not distort when in contact with water or moisture. Max. width: approx. 30 cm; max. length: approx. 500–600 cm; customary width: 10–15 cm; customary length: up to 300 cm.

#### Panels

Compared with timber boards, formwork panels made from wood-based materials have considerable advantages. They are lighter in weight and can be assembled faster (50–70% of the erection costs can be saved when using panels instead of boards). In addition, they last longer because the synthetic resin lacquer which is normally used to coat such panels detaches more readily from the concrete when striking the formwork. Format: Formwork panels are available in the most

diverse sizes with the maximum dimensions depending on the conditions on site. In Switzerland the formats 50 x 200 cm and 50 x 250 cm, for example, are widely used.

#### *Modular formwork, table forms, wall forms*

Industry can now supply a highly varied range of formwork systems that enable large areas to be set up and taken down quickly: modular elements for walls, floor formwork with appropriate propping, self-supporting climbing and sliding formwork, etc.

In order to combine the economic advantages of modular formwork with the aesthetic qualities of other types of formwork, modular formwork is these days often used merely to support “traditional” boards and panels.

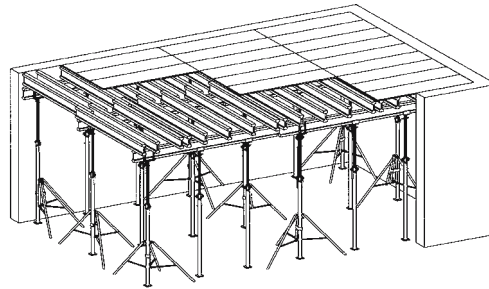


Fig. 16: Table form for floor slab

#### *Steel formwork*

Forms made from sheet steel are used both for in situ and precast concrete. The higher capital cost of such formwork is usually offset by the high number of reuses possible.

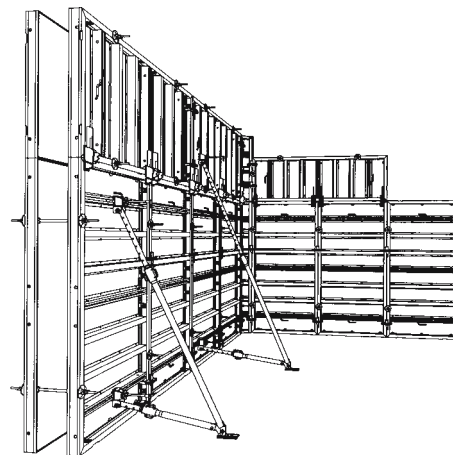


Fig. 17: Steel wall forms

#### *Formwork surfaces*

The formwork material (timber, wood-based panel, plywood, hardboard, fibre-cement, steel, plastic, etc.) and its surface finish (rough, planed, smooth, plastic-coated, etc.) determine the surface texture of the exposed concrete.

The smoothness or roughness of the formwork can influence the shade of the exposed concrete surface. For instance, completely smooth formwork results in an exposed concrete surface with a lighter colour than one produced with rough formwork.

#### *Release agents*

These are oil, wax, paste and emulsion products applied to the contact faces between the formwork material and the concrete to enable easier separation of formwork and concrete surface – without damage – when striking the forms. In addition, they help to create a consistent surface finish on the concrete and protect the formwork material, helping to ensure that it can be reused.

The suitability of a particular release agent depends on the material of the formwork (timber, plywood, hardboard, fibre-cement, steel, plastic, etc.).

#### **Placing and compacting the concrete**

Good-quality exposed concrete surfaces call for a completely homogeneous, dense concrete structure. The wet concrete must be placed in the concrete without undergoing any changes, i.e. segregation, and then evenly compacted in situ.

#### *Compacting*

The purpose of compacting the concrete is not only to ensure that the formwork is completely filled, but rather to dissipate trapped pockets of air, distribute the cement paste evenly and ensure that the aggregates are densely packed without any voids. In addition, compaction guarantees that the concrete forms a dense boundary layer at the surface and thus fully surrounds the reinforcement.

#### *Methods of compaction*

- |                |   |
|----------------|---|
| Punning:       | with rods or bars   |
| Tapping forms: | for low formwork heights  |
| Vibrating:     | standard method on building sites                                   |
|                | <i>immersion (poker) vibrators</i> are immersed in the wet concrete |
|                | <i>external vibrators</i> vibrate the formwork from outside         |
| Tamping:       | in the past the customary method of compaction                      |



Fig. 18: Compacting the concrete

### Vibrating

A poker vibrator should be quickly immersed to the necessary depth and then pulled out slowly so that the concrete flows together again behind the tip of the poker.

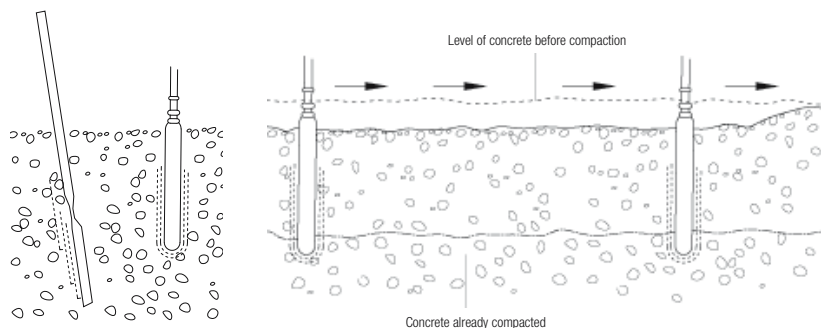
Vibrators should not be used to spread the concrete because this can lead to segregation. If segregation does occur during compaction, the result is clearly recognisable differences in the structure of the concrete, possibly even honeycombing on the surface.

The depth of concrete placed in one operation should be limited. The weight of the wet concrete can be so great that pockets of air cannot escape to the surface.

### Curing

The hardening, or setting, of the concrete is not the result of it drying out. If we allow concrete to dry out too quickly, this leads to shrinkage cracks because the tensile strength is too low. And if we sprinkle the concrete with water, efflorescence (lime deposits on the surface) will almost certainly be the outcome. The answer is to allow the concrete to retain its own moisture for as long as possible, which is best achieved by covering it with waterproof sheeting. These must be positioned as close to the concrete surface as possible but without touching it because otherwise they may cause blemishes.

Such methods are labour-intensive but indispensable for exposed – especially fair-face – concrete surfaces.



Figs 19 and 20: Compacting with a rod (punning) (left) and a poker vibrator (right)

Compaction procedure

### Construction joints

When working with in situ concrete, joints between earlier and later pours are almost inevitable. The strength of the formwork required to resist the pressure of the wet concrete also places a limit on the quantity of concrete that can be economically placed in one operation. Concreting operations must therefore be planned in stages and separated by joints.

The location and form of these construction joints are determined by the architect and the structural engineer together. Given the fact that it is impossible to conceal such joints, it is advisable to plan them very carefully.

If new concrete is to be cast against an existing concrete surface (a construction joint), the concrete surface at the point of contact must be thoroughly roughened and cleaned, and prior to pouring the wet concrete wetted as well. And if such a construction joint must be watertight, it is advisable to use a richer mix at the junction with the existing concrete or to coat it first with a layer of cement mortar. It is also possible to add a retarder to the last section prior to the construction joint so that the concrete at the intended joint position does not set immediately and the following concrete can then be cast against this “still wet” concrete.

## 10 rules for the production of concrete



Fig. 21: Placing concrete by crane skip

**1** Concrete is produced by mixing together cement, *coarse and fine aggregates* (gravel and sand respectively) and water. Normally, 1 m<sup>3</sup> of concrete contains 300–350 kg cement, approx. 2000 kg aggregates and 130–200 l water. Depending on the intended use of the concrete, additives and/or admixtures can be mixed in (admixture: approx. 0.5–10 kg/m<sup>3</sup>; additive: approx. 5–50 kg/m<sup>3</sup>). After mixing, the concrete must be placed and compacted as soon as possible.

After mixing, the concrete must be placed and compacted as soon as possible.

**2** Together, the *cement* and the water form the paste which sets to form hydrated cement and binds together the aggregates. The cement is supplied as a powder and is therefore added to the fine/coarse aggregate blend based on weight.

Stored in the dry, cement can be kept for months. But as soon as it becomes moist, it forms lumps and is then unusable.

**3** Aggregates must be washed clean. Contaminated, greasy and incrustated aggregates are unsuitable for use in concrete. Slate-like and marlaceous constituents or mica also impair the quality of concrete.

The aggregates must exhibit an appropriate *grading* that is as consistent as possible. The maximum grain size is usually 32 mm.

**4** The water content has a crucial influence on the quality of the concrete: less water means fewer pores and hence a concrete with improved strength, density and durability.

The water content is specified by the *water/cement ratio* (w/c ratio). This ratio is calculated by dividing the weight of water (moisture in aggregate plus mixing water) by the weight of cement.

Good concrete requires a w/c ratio between 0.45 and 0.55; w/c ratios > 0.60 should be avoided. A concrete with a high sand content requires more water than one with coarser-grained aggregate. Good-quality concrete therefore contains more coarse than fine aggregate.

**5** *Admixtures and/or additives* can be mixed into the concrete in order to modify certain properties of the wet and/or hardened concrete. The most important of these are:

- Plasticisers: to improve the workability of the concrete or enable the water content to be reduced and hence achieve a better quality concrete.
- Accelerators and retarders: to influence the onset and duration of the curing process.
- Air entrainers: to improve the frost resistance – essential when the concrete will be exposed to de-icing salts, but micro hollow beads are often more advantageous for very stiff wet concrete.
- Additives: fillers and fly ash can replace ultra-fine particles – but not the cement – and improve the workability;

hydraulic lime is also used as an additive; pigments can be added to produce coloured concrete.

**6** The *formwork* should be thoroughly cleaned out prior to concreting. Water in the formwork, excessive release agent, sawdust and any form of soiling can impair the appearance of the concrete. The formwork should be leakproof. The distance between reinforcement and formwork must be correct and the reinforcement must be secured to prevent displacement.

**7** Proper *mixing* of the concrete is vital for its quality and workability. The optimum mixing time is > 1 min. Prolonging the mixing time improves the workability and has a favourable effect on exposed surfaces. Insufficient mixing is not beneficial to the properties of the wet or hardened concrete.

**8** When using ready-mixed concrete it must be ensured that the loss of water during transport is kept to a minimum. Concrete transported in open vehicles must be covered. During periods of hot weather the available working time on the *building site* can be severely shortened due to the effects of the heat during transport. Adding water on site to “dilute” the concrete impairs the quality of the concrete.

Ready-mixed concrete must be ordered in good time and specified in full.

**9** Concrete should be *placed* in even, horizontal layers. The concrete should not be tipped in piles and then spread with a poker vibrator because this can result in segregation (honeycombing).

Every layer must be compacted immediately after being placed until all the air has escaped. The distance between successive immersion points for the poker vibrator is 25–70 cm depending on the diameter of the vibrator.

Excessive *vibration* causes segregation of the concrete because the large constituents sink to the bottom and the cement slurry and water rise to the top. On exposed concrete surfaces such segregation causes permanent blemishes. A stiff mix lowers the risk of segregation.

**10** *Curing* is an essential part of concreting because it prevents premature drying-out of the concrete. Exposed concrete surfaces should be covered or continuously sprinkled with water for at least four days after being placed, especially if exposed to draughts or direct sunlight.

During cold weather, freshly placed concrete must be protected against freezing by covering it and, if necessary, by heating.

Source: *Cementbulletin*, April 1987.



## Exposed concrete surfaces



Fig. 22: Timber boards and honeycombing result in rough surfaces  
Rudolf Olgiati: house for Dr G. Olgiati, Flims-Waldhaus (CH), 1964–65

### Characteristics of concrete surfaces cast against formwork

The appearance of the struck concrete is determined mainly by the surface texture of the formwork material but also by the joints in the formwork and the formwork ties. This aspect calls for meticulous planning of all joints and ties plus subsequent rigorous inspections during the work on site, or a tolerant attitude towards the quality of the concrete surfaces.

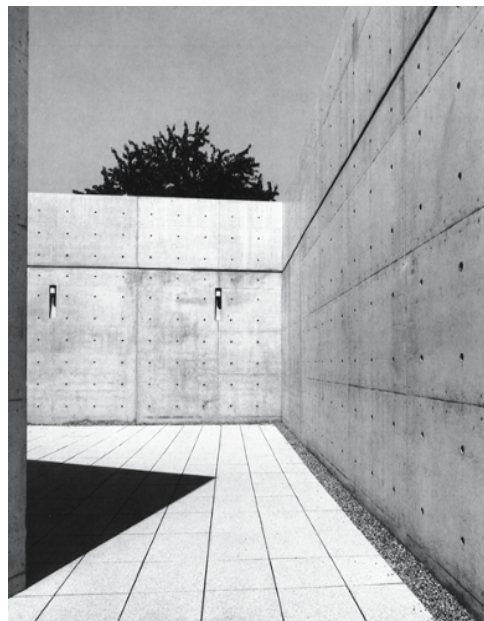


Fig. 23: Courtyard wall in in situ concrete, constructed with formwork panels the size of tatami mats (91 x 182 cm), courtyard floor finished with precast concrete flags  
Tadao Ando: Vitra conference pavilion, Weil am Rhein (D), 1993

### Exposed concrete

Basically, we distinguish between two types of exposed concrete depending on whether the outermost, thin layer of cement directly adjacent to the surface of the formwork is retained or removed.

#### *Cement “skin” retained*

The pattern of the formwork and the formwork ties determine the appearance. Joints in the formwork can be dealt with in various ways – from the simple “butt joint” to the “open joint” to covering the joints with various strips and tapes.

The holes created by formwork ties are either filled with concrete subsequently, left open or plugged.

#### *Cement “skin” removed*

The outermost, thin layer of cement can be modified or completely removed by using various manual or technical treatments. The cement “skin”, the surface layer, is worked or treated to reveal the aggregate.

#### Manual treatments

- Bossing
- Point tooling
- Bush hammering
- Comb chiselling

#### Technical treatments (exposing the grains of aggregate)

- Blasting (sand, steel shot, corundum, water/sand mixture)
- Flame cleaning
- Brushing and washing
- Acid etching

#### Mechanical treatments (surface only)

- Grinding
- Polishing

### Characteristics of concrete surfaces not cast against formwork

These surfaces (floors and tops of walls) can also be worked with the above treatments once the concrete has hardened.

But before such surfaces have hardened, they can also be treated with a diverse range of tools.

### Colour

The colour of the concrete is determined by the quality of the concrete mix (coarse aggregate and cement quality plus any pigments added) and the formwork (new or used formwork, also quality and quantity of release agent).

Surface characteristics of concrete cast against formwork		Surface characteristics of concrete not cast against formwork
<p><b>Type 1: Normal concrete surface</b> Surfaces without special requirements: with any surface texture without subsequent working of fins and differences in level</p> <p><b>Type 2: Concrete surface with uniform texture</b> Surfaces with the following requirements: uniform surface texture board or panel size not specified subsequent working of fins and differences in level</p> <p><b>Type 3: Exposed concrete surfaces with board texture</b> Surfaces that remain exposed with the following requirements: – uniform surface texture without differences in level, fins and porous areas, a moderate number of blowholes caused by air pockets is permissible – more or less even colouring – constant board width, joints between boards not specified – uniform board direction and parallel with larger dimension of surface – smooth boards</p> <p><b>Enhanced requirements are to be specified as follows</b></p> <ol style="list-style-type: none"> <li>1. Sealed joints</li> <li>2. Offset joints</li> <li>3. Uniform board direction and perpendicular to larger dimension of surface</li> <li>4. Pattern according to detailed drawing of surface</li> <li>5. Use of rough-sawn boards</li> </ol>	<p><b>Type 4: Exposed concrete surfaces with panel texture</b> Surfaces that remain exposed with the following requirements: – uniform surface texture without differences in level, fins and porous areas – a moderate number of blowholes caused by air pockets is permissible – more or less even colouring – constant panel size, joints between panels not specified – uniform panel direction and parallel with larger dimension of surface</p> <p><b>Enhanced requirements are to be specified as follows</b></p> <ol style="list-style-type: none"> <li>1. Sealed joints</li> <li>2. Offset joints</li> <li>3. Uniform panel direction and perpendicular to larger dimension of surface</li> <li>4. Pattern according to detailed drawing of surface</li> </ol>	<p>Treatments to not fully hardened concrete:</p> <ol style="list-style-type: none"> <li>1 <i>Roughly levelled</i> e.g. with timber board</li> <li>2 <i>Roughened</i> with brushes or rakes</li> <li>3 <i>Floated</i> without addition of mortar</li> <li>4 <i>Floated</i> with addition of mortar</li> <li>5 <i>Trowelled</i> smooth, flat surface without blowholes</li> <li>6 <i>Grooved</i> parallel grooves of equal width and depth</li> <li>7 <i>Brushed</i> rough surface with vertical, horizontal or herringbone pattern</li> <li>8 <i>Vacuum-dewatered</i> lowering of water/cement ratio in concrete already placed by means of special equipment</li> </ol> <p>Treatments to hardened concrete:</p> <ol style="list-style-type: none"> <li>1 <i>Washing and brushing</i> washing out the fine particles in the surface layer to reveal the coarse aggregate</li> <li>2 <i>Sandblasting</i> mechanical roughening to produce a matt surface in the colour of the underlying material</li> <li>3 <i>Jetting</i> sprayed with compressed-air water jet</li> <li>4 <i>Acid etching</i> chemical treatment to remove the lime component and reveal the colour of the underlying material</li> <li>4 <i>Bush hammering</i> hammering the concrete surface with special, manual or power-driven tools to a depth of about 5 mm</li> <li>6 <i>Grinding</i> surface ground manually or by machine to remove all blowholes, subsequently treated with fluate, including wetting</li> <li>7 <i>Polishing</i> surface ground to achieve a high sheen, blowholes filled and reground</li> <li>8 <i>Sealing</i> colourless water-repellent seal applied to surface</li> </ol>

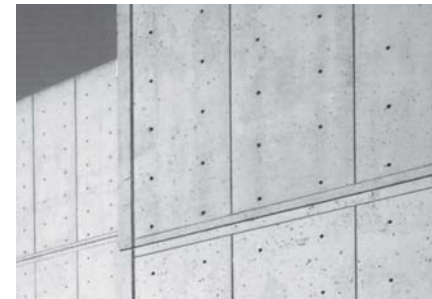
Formwork qualities to Swiss standard SIA 118/262:2004  
see also DIN 18217, 1981 ed., DIN 18331, 2002 ed., DIN 68791, 1979 ed.



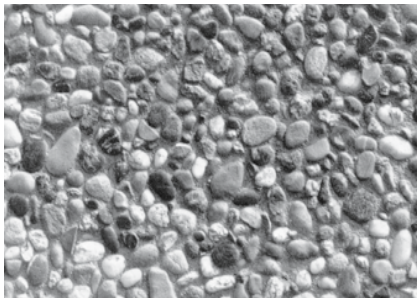
**Fig. 24: Horizontal timber boards**  
Formwork made from 3 cm thick Douglas fir boards, straight edges, butt joints between boards.



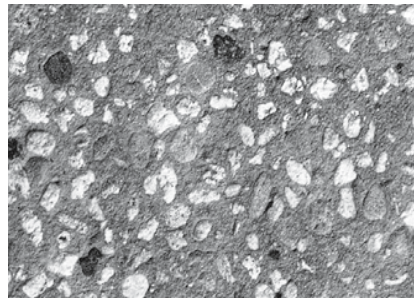
**Fig. 25: Horizontal timber boards**  
Formwork made from 18 cm wide, 3 cm thick Douglas fir boards, chamfered edges, tight butt joints between boards. Characteristic, projecting concrete fins are the result.



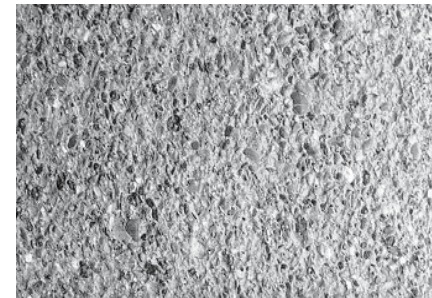
**Fig. 26: Vertical panel formwork, panels coated with synthetic resin lacquer**  
Louis I. Kahn: Salk Institute, La Jolla (Cal, USA), 1959–65



**Fig. 27: Concrete with exposed aggregate finish**  
Aggregate revealed by jetting



**Fig. 28: Sandblasted surface**  
Aggregate revealed by blasting



**Fig. 29: Point-tooled surface**  
Medium-coarse quality

## Floor supports, exposed concrete with internal insulation

### Causes of thermal bridges

The connection between wall and floor, or floor support, leads to a thermal bridge problem (heat losses) when using exposed concrete in conjunction with internal insulation. This problem can be solved properly only in single-storey,

self-contained buildings where there are no intermediate or other floors to interrupt the layer of insulation. There are two potential solutions for all other cases, but both must be considered in conjunction with the structural concept.

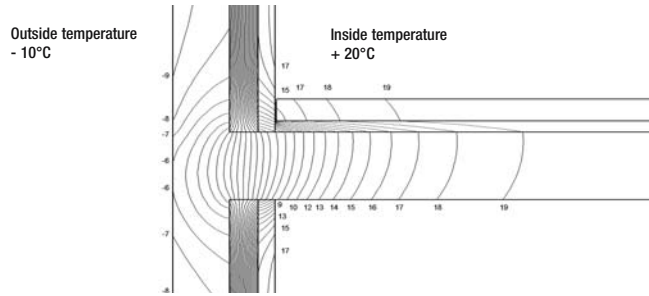


Fig. 30: Isotherms diagram

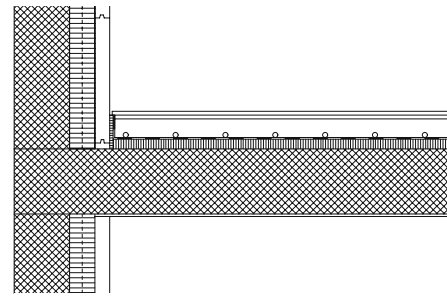


Fig. 36: Construction detail



Fig. 31: Insulation to the soffit along the perimeter concealed behind timber cladding  
Bünzli & Courvoisier: Linde school, Niederhasli (CH), 2003

### Solution 1: Strip of insulation in soffit

The inclusion of insulation around the perimeter of the floor, at its junction with the external wall, maintains the structurally compact connection between wall and floor but does not solve the heat loss problem, the temperature drop at the surface of the concrete, entirely. Above all, it is the surface temperature at the base of the wall

that remains critical. Furthermore, the layer of insulation disturbs the appearance of the soffit. If the soffit is plastered, it must be remembered that a crack could develop at the insulation-soffit interface.

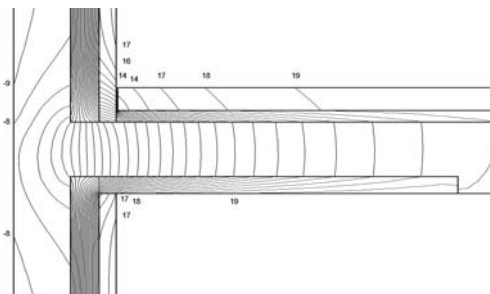


Fig. 32: Isotherms diagram

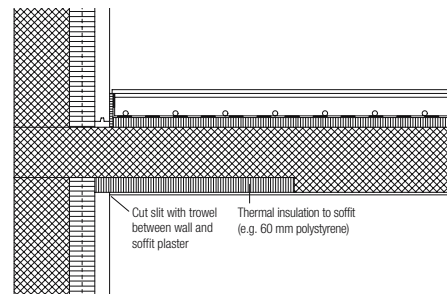


Fig. 37: Construction detail



Fig. 33: Example of insulated reinforcement being installed

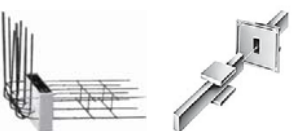


Fig. 34: Insulated reinforcement Shear stud

### Solution 2: Separation between floor and wall

The development of various special insulated reinforcement products mean that it is now possible to achieve "partial" separation between floor and wall. This has a detrimental effect on the compact connection between floor and wall. Additional expansion joints must be provided (at projecting and re-entrant corners). The temperature at the base of the wall is higher than that in solution 1.

### Insulated reinforcement and shear studs

Numerous variations on these two products are available. The shear studs can resist shear forces only, whereas the insulated reinforcement products can accommodate bending moments as well. The advantage of the shear studs over the insulated reinforcement is that they can accommodate a certain amount of movement (egg-shaped sleeve).

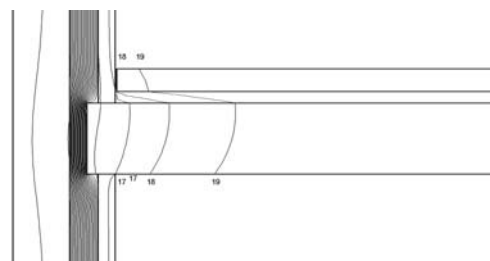


Fig. 35: Isotherms diagram

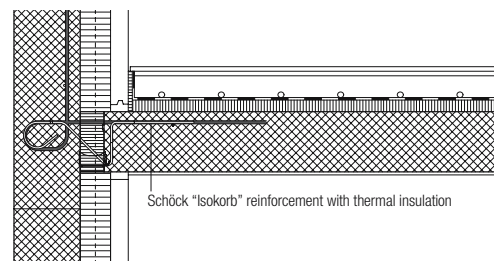
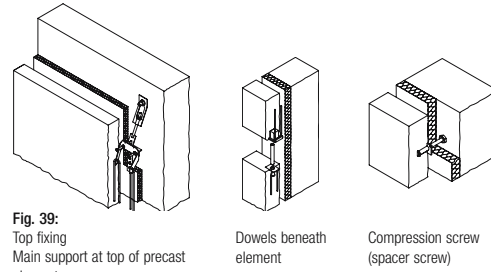


Fig. 38: Construction detail



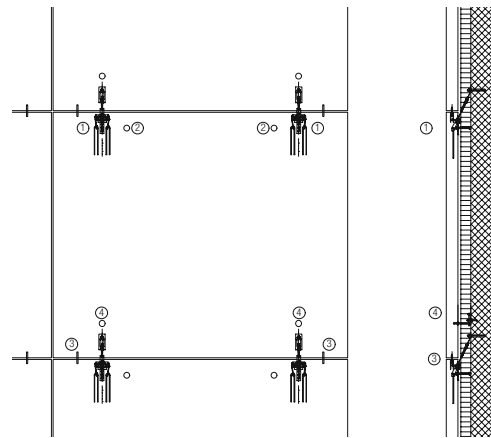
## The fixing of heavy external cladding (concrete)



**Fig. 39:**  
Top fixing  
Main support at top of precast element

Dowels beneath element

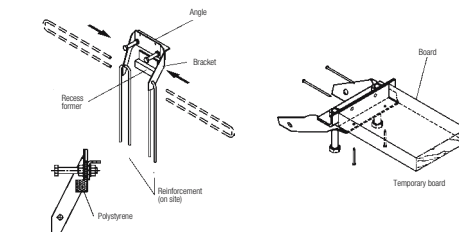
Compression screw (spacer screw)



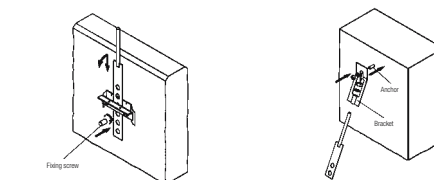
**Fig. 40:** Cladding panel fixing system: elevation (above) and section (right)



**Fig. 43:** Heavy external cladding



**Fig. 41:** A Installation work in the factory, temporary fittings in the form



**Fig. 42:** B Installation work on site

### Fixing heavy cladding elements

The fixings for large, precast concrete cladding panels depend on the weight of the element. The high demands placed on fasteners mean that two fixings are usually necessary for storey-high panels. In order to accommodate tolerances, or to enable alignment of the elements, the fasteners must permit adjustment in three directions. Such fasteners represent discrete thermal bridges and this fact must be accepted. All fixings must be made of stainless steel (rustproof). The clearance between the in situ concrete structure and the precast elements can lie between 0 and 14 cm, and in special cases may even be greater. Wind pressure and wind suction effects must be taken into account.

Facade fixing systems consist of:

- 1 Top fastener (loadbearing fixing) with height-adjustable threaded bar
- 2 Spacer screw for adjusting position of cladding panel relative to structure
- 3 Dowels for locating the elements with respect to each other
- 4 If required, compression screws, depending on loading case (wind pressure or suction)

Facade fixings are installed at the same distance from the panel's centroidal axis. This ensures that every fixing carries half the self-weight of the facade element. The joints between individual facade elements should be sufficiently large (15 mm) to ensure that no additional loads (e.g. due to expansion) are placed on the elements.

### Installation

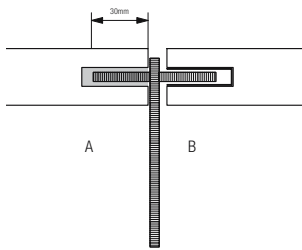
A Place the top fastener (loadbearing fixing) in the formwork for the facade element at the precasting works and integrate it into the reinforcement. Place a polystyrene block (removed on site, see below) between bracket and angle. The timber board shown here serves only as an aid during casting (enabling fixing to facade element formwork).

B Positioning and attaching the supporting bracket on the structure

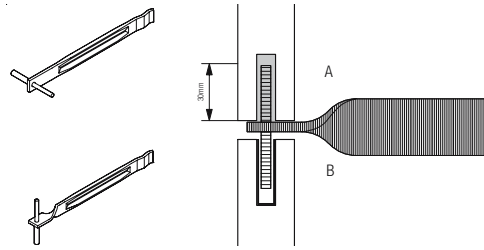
- Remove polystyrene.
- Insert perforated strip between bracket and angle.
- Secure perforated strip with screws.
- Apply "Loctite" or similar to the screw and fit finished component to supporting bracket.



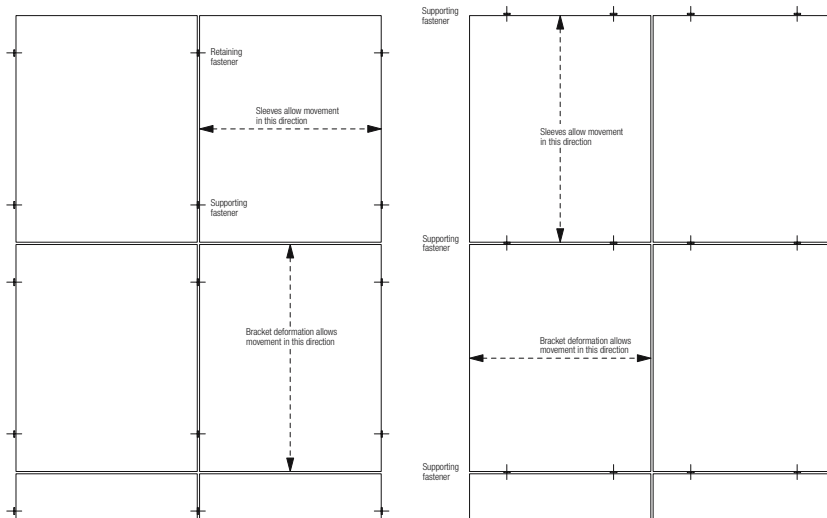
## The fixing of heavy external cladding (stone)



**Fig. 44: Cast-in dowel in vertical joint**  
A Dowel cast in  
B Dowel in plastic sleeve (to allow movement)



**Fig. 45: Cast-in dowel in horizontal joint**



**Fig. 46: Elevation on panels**

### Fixing stone cladding

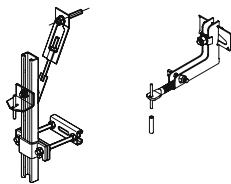
Such cladding panels are usually suspended in front of the structure, and connected to it with various fasteners. These fasteners bridge the distance between the panel and the structure and hence create a space for thermal insulation and air circulation. Stone cladding panels are fixed with supporting and retaining fasteners located in the vertical and/or horizontal joints (four fixings are necessary). Besides carrying the self-weight of the panel, the fasteners must also resist wind pressure and wind suction forces. Many different fasteners are available on the market. And various loadbearing framing systems are available for the case of insufficient or even a total lack of suitable fixing options on the loadbearing structure. We distinguish between the following fastening systems:

- cast-in dowels
- bolts and brackets
- special brackets, metal subframes

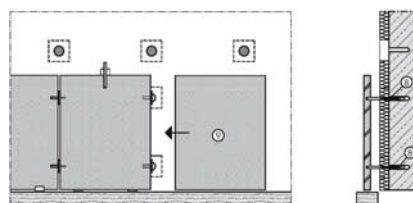
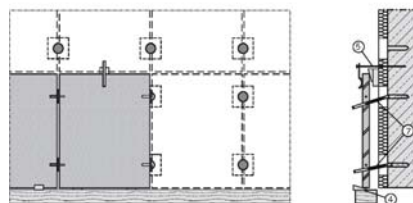
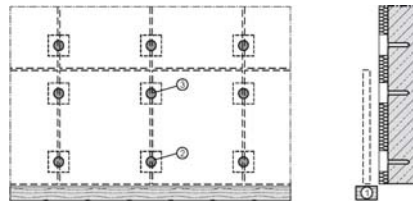
The most popular form of support is the cast-in dowel shown here (figs 44 and 45).

### Cast-in dowels

These must be of stainless steel. They penetrate approx. 30 mm into the hole drilled in the edge of the panel. The diameter of the hole should be approx. 3 mm larger than that of the dowel. The standard distance from corner of panel to centre of dowel hole should be 2.5 times the thickness of the panel. The minimum panel thickness is 30 mm.



**Fig. 47: Brackets for cast-in rail system**



**Fig. 48: Installation of cast-in dowels**

- 1 Align erection jig to exact height for bottom row of panels.
- 2 Cut out thermal insulation locally to facilitate drilling of holes.
- 3 Drill holes for anchors, ensuring that reinforcing bars are not drilled through; blow holes clean.
- 4 Set up stone panels to correct height.
- 5 Align top edge of panel and wedge at correct distance from structure.
- 6 Moisten holes for anchors, fill with grout and compact.
- 7 Insert anchors into grout and align; slide in dowel.
- 8 Compact grout again and strike off excess, replace thermal insulation around anchor, slide in next panel.

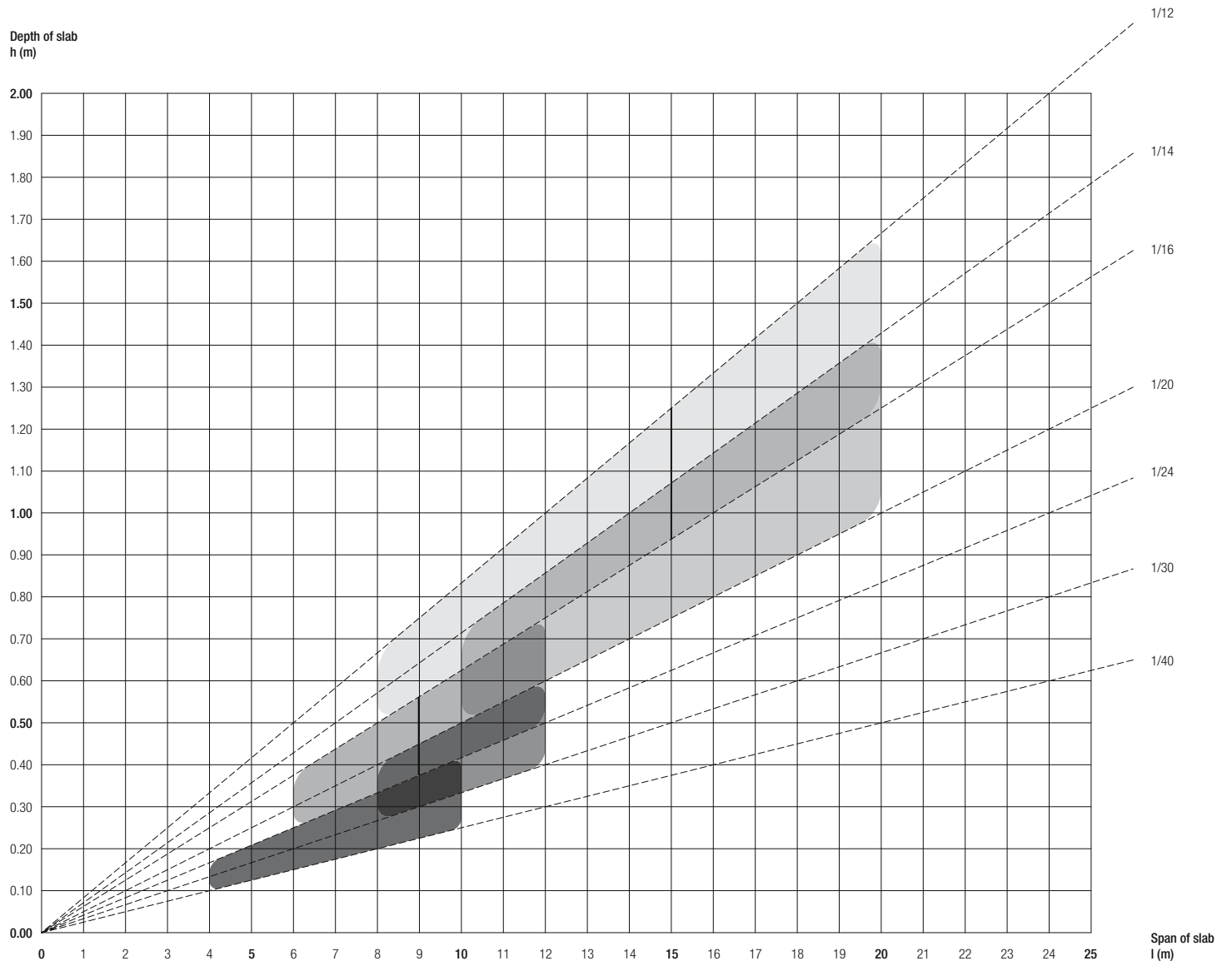







**Fig. 49: Stone facade**  
Fixed with cast-in dowels

### Installation of cast-in dowels

These must be fixed to a loadbearing substrate (concrete or masonry) with an adequate depth of penetration. The fixing to a loadbearing component should not weaken its cross-section excessively. The thermal insulation should be cut back prior to drilling the hole and should be replaced once the dowel has been fitted. The fastener is aligned as the mortar hardens (cures).

**Chart for establishing preliminary size of reinforced concrete slabs**  
Initial size estimate at design stage



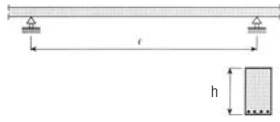
Element (loadbearing)	Span l (m)	h*/l
 Slab on walls	– 10 m	1/24 – 1/40
 Flat slab on columns, conventional reinforcement	6 – 12 m	1/16 – 1/24
 Flat slab with flared column heads	8 – 12 m	1/20 – 1/30
 Slab with downstand beams, conventional reinforcement	8 – 20 m	1/12 – 1/16
 Waffle slab	10 – 20 m	1/14 – 1/20

**Fig. 50: Notes for using this chart**  
With a high load (dead and imposed loads) use the maximum value for the slab depth as proposed by the chart – vice versa for a low load. The sizes and relationships shown cannot be verified scientifically. The shaded areas are supposed to be slightly "indefinite". In the interest of the rational use of a loadbearing element, the "edges" of this chart should be avoided.

Source: M. Dietrich, Burgdorf School of Engineering, 1990

\*Prestressing can reduce the structural depth of the slab by up to about 30%.

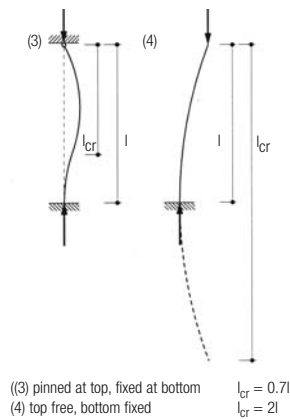
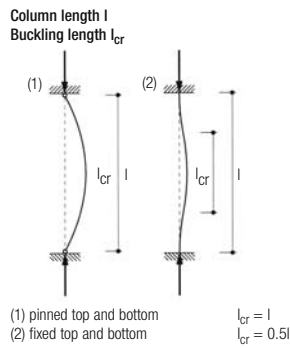
## Linear structural members



**Fig. 51:**  
Dimensions of cross-sections for customary spacings and loads in buildings (approximation):

Beam depth h	
simply supported beam	$h/l = 1/11$ to $1/13$
simply supported T-beam	$h/l = 1/13$ to $1/15$
continuous beam (end span)	$h/l = 1/12$ to $1/15$
continuous beam (other spans)	$h/l = 1/15$ to $1/18$

Beam width b	
min. b	180 mm
min. b for $l = 5$ to $8$ m	200 mm
min. b for $l = 8$ to $12$ m	300 mm
min. b for $l = 12$ to $15$ m	400 mm



**Column dimension b**  
 $b =$  smaller dimension of column cross-section

Rectangular cross-section	$b = l_{cr}/14$ (valid as approximation if buckling is not critical)
min. dimension for in situ concrete	$b > 200$ mm
min. dimension for precast concrete	$b > 150$ mm

**Column dimension for multi-storey column**  
column grid  $7.5 \times 7.5$  m, storey height  $3.60$  m  
(normal loading, e.g. offices)

1 floor above column:	$b = 250$ mm
2 floors above column:	$b = 350$ mm
3 floors above column:	$b = 400$ mm
4 floors above column:	$b = 450$ mm

### Beams

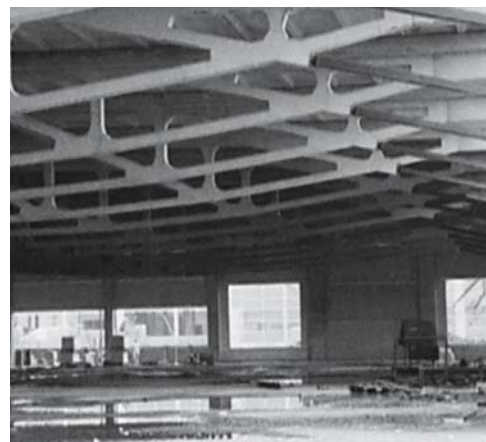
Beams are structural members primarily loaded in bending. The magnitude of the bending moments influences the dimensions (depth, slenderness, shape of cross-section) and the type of reinforcement (conventional or prestressed). Structural beams occur in various forms – with ends fixed, simply-supported, continuous, above the floor (upstand), below the floor (downstand) and in frames.

The conventional rectangular beam is rather rare in in situ concrete because it is frequently cast monolithically with a floor slab (T- or L-beam) and then functions together with this. If the compression zone in such a beam is wholly within the slab, the depth of the beam is less than that of a standard rectangular member.



**Abb. 52:** Precast concrete beams in a framed building  
Angelo Mangiarotti: industrial building, Bussolengo (Brescia), 1982

Owing to the cost of formwork, adjusting the beam sizes to suit the loads exactly is only advisable in precasting works, where forms can be reused economically. For example, the depth of a beam can be designed to track the bending moment diagram, the width can be varied in line with the shear force diagram. On large spans the cross-section can therefore be optimised to save material



**Abb. 53:** Trussed beams  
Factory building, Lustenau (A)

and hence weight and the beam constructed as a girder or trussed beam (trussing above or below).

### Columns

The function of a column is to transfer the vertical loads to the foundation. Carrying horizontal loads simultaneously (shear forces due to wind, earthquakes) calls for correspondingly large cross-sections.

Thanks to the mouldability of concrete, the shape of the cross-section can be chosen virtually at will, but the cost of the formwork and the fixing of the reinforcement place practical limits on this. The “perfect” form is circular because the flexural strength is the same in all directions. However, in situ concrete columns are frequently square or rectangular to make the formwork easier and less costly. An in situ column must be at least  $200$  mm wide, a precast column  $150$  mm. The latter are cast horizontally, the surfaces are trowelled smooth or given subsequent treatment depending on the quality required. Spin-casting can be used for both square and round precast concrete columns. In this method the form is filled, closed and rotated to compact the concrete. This results in an absolutely smooth and consistent surface finish.

Slender columns loaded in compression are at risk of buckling; in other words, the more slender a column is, the lower is its permissible load (buckling load). The length of a column is therefore governed by its relationship to its smallest cross-section dimension. The buckling length depends on the type of support at each end, and maybe shorter (= high buckling load) or longer (= low buckling load) than the actual length of the column. Normally, however, columns with pinned ends are met with in superstructure works.



**Abb. 54:** Spun-concrete columns, connected to reinforced concrete roof via steel web plates.  
Axel Schultes: art gallery, Bonn (D), 1992

## Systems with linear members

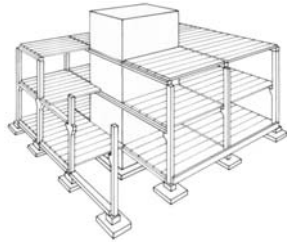


Fig. 55: Principle of a multi-storey framed building using precast concrete columns, beams and floor elements. The in situ concrete core stabilises the building by resisting the horizontal forces.

### Arches

The arch is a curved linear member. Irrespective of the loading, the arch is subject to axial compression and bending. But if the arch has an accordingly favourable form, it can carry a uniformly distributed load exclusively by way of axial compression (no bending). The “perfect” form for an arch is the inverse of a spanned rope, which deforms only under the action of its own weight (catenary curve).

In reinforced concrete construction the arch is frequently used as the loadbearing element for long-span bridges. Whereas in times gone by – when the relationship between cost of labour and cost of materials was totally different – in situ concrete arches were also used in buildings for spanning over large areas (e.g. single-storey sheds), they are seldom met with today and then only in precast form.



Abb. 56: Fixed-based arch  
Stuttgart Building Department (F. Fischle, F. Cloos): swimming pool, Heselach (D), 1929

### Portal frames

Connecting horizontal and vertical linear members together rigidly produces a portal frame. The vertical members are sometimes known as legs, the horizontal ones as rafters. Owing to the bending moments at the corners it should be ensured that the cross-section of the legs is greater than that of conventional columns carrying concentric loads.

The portal frame represents a braced, stable system in the plane of the frame which can carry both vertical and horizontal loads and thus assume the function of a bracing “plate” in a building. Inherently stable portal frame systems are particularly economic in single- and two-storey buildings, but plates in the form of slabs and walls are the preferred form of bracing in multi-storey buildings.

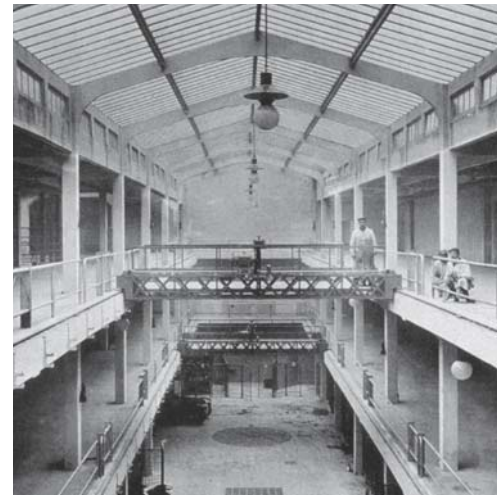


Abb. 57: Fixed-based portal frame  
Auguste + Gustave Perret: Ponthieu garage, Paris (F), 1906

### Frames

Frames consist of prefabricated loadbearing elements such as columns, beams and floor slabs. In conjunction with fixed columns, such systems can form a rigid framework.

Horizontal forces are resisted by fixed columns (acting as vertical cantilevers) in single- and two-storey buildings, whereas in multi-storey structures the horizontal loads are transferred to the foundations by vertical wall plates (shear walls).

A frame provides maximum flexibility with respect to utilisation requirements because the loadbearing function is essentially separate from the other building functions.

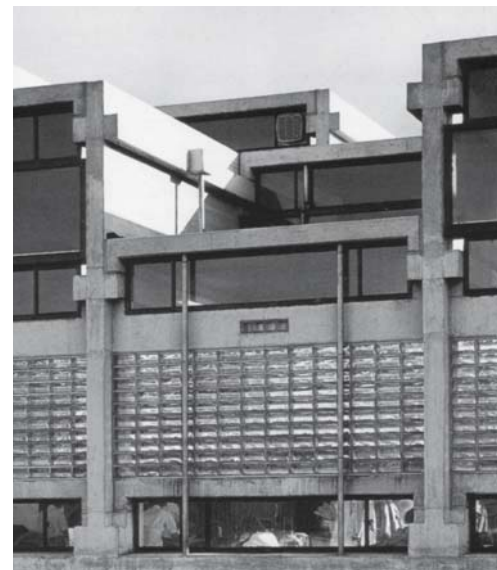


Abb. 58: Use of precast concrete elements and glass  
Hermann Hertzberger: extension to LinMij plant building, Amsterdam (NL), 1964



## Planar structural members

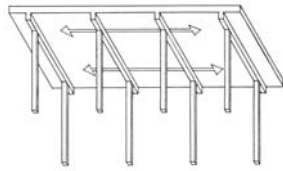


Fig. 59: One-way-spanning continuous slab

### Slab depth for one-way span:

cantilever slab:  $h/l = 1/12$   
 simply-supported slab:  $h/l = 1/25$

continuous slab (end span):  $h/l = 1/30$   
 continuous slab (other spans):  $h/l = 1/35$

### Slab depth for two-way span:

simply-supported slab:  $h/l = 1/30$   
 continuous slab (corner span):  $h/l = 1/40$   
 continuous slab (other spans):  $h/l = 1/45$

min. slab thickness (h) 180 to 200 mm  
 (fire protection and sound insulation)

### Economic spans:

one-way-span slabs:  $l < 6$  to  $7$  m  
 two-way-span slabs:  $l < 8$



Fig. 60: Ribbed slab

### Structural depth of ribbed slabs:

overall depth (h)  $h = l/20$  to  $l/35$   
 clear spacing of ribs (s)  $s < 2h$   
 slab depth ( $h_p$ )  $h_p > 50$ – $80$  mm  
 or  $0.1 \times$  rib spacing (centre-to-centre)

### Economic spans:

ribbed slab  $l = 7$  to  $12$  m  
 prefabricated, prestressed  $l =$  up to  $18$  m



Fig. 61: Flat slab

### Structural depth of flat slabs:

rectangular slab (one-way span):  $h/l = 1/30$   
 square slab (two-way span):  $h/l = 1/35$

min. slab depth (h) 200 mm  
 (fire protection and sound insulation)

### Economic spans:

flat slab  $l \leq 8$  m

## Slabs

Concrete slabs are loadbearing elements loaded perpendicular to their plane and primarily subjected to bending. We distinguish between one-way-spanning and two-way-spanning slabs. Examples of one-way-span slabs are cantilever slabs or those spanning between two walls placed opposite each other. The ideal two-way-span slab is square on plan and supported on all four sides. The loads are carried in (at least) two directions and the structural depth of the slab can be reduced accordingly. The ratio of slab depth to span depends on the form of support (cantilever, simply-supported, continuous).

On longer spans the slabs would be so heavy that they are resolved into lighter flooring systems. Flooring systems for buildings are divided into those with linear supports such as ribbed slabs (one-way span) and waffle slabs (two-way span), and those with discrete supports such as flat slabs (with or without column heads).

Compared with solid slabs, ribbed slabs and waffle slabs supported on walls or downstand beams have the advantage of being much lighter (reduction of material in tension zone), but their formwork is more elaborate (prefabricated formwork elements are essential).

Slabs supported on individual columns carry the loads entirely by means of the slab alone, without any beams or ribs. The high stresses around the columns calls for appropriate reinforcement or additional strengthening in



Fig. 62: Basement garage, c. 1960  
 Ribbed slab

the form of (flared) column heads. The structural depth of a flat slab is small compared to the resolved flooring systems. But concentrating the bending moments and shear forces around the columns does bring with it the risk of punching shear. Increasing the bearing area and the thickness of the slab at this point and including reinforcement or steel “studrails” to withstand the punching shear will guarantee the load-carrying capacity around the columns. Today, the flared column heads and columns are usually produced in precast concrete to optimise operations on site.



Abb. 63: Flared column heads transfer the loads from the upper floors into the columns.

Robert Maillart: warehouse, Giesshübelstrasse, Zurich (CH), 1910

## Plates

Plates are used in buildings in the form of walls. They function as loadbearing and/or enclosing components. In contrast to a slab, which is primarily subjected to bending, a plate carries forces in its plane and therefore has to resist axial forces.

We distinguish between plates supported along their full length (linear supports), which can transfer the vertical loads directly, and those supported at individual points similar to beams, which transfer the loads to these supports (deep beams).

Owing to their high stiffness, plates are used for resisting horizontal forces (bracing) and as transfer structures.



Abb. 64: Model of loadbearing structure with shear walls offset or rotated through 90°

Morger & Degelo: Reinach community centre, Basel (CH), 1997–2000

## Systems with planar structural members

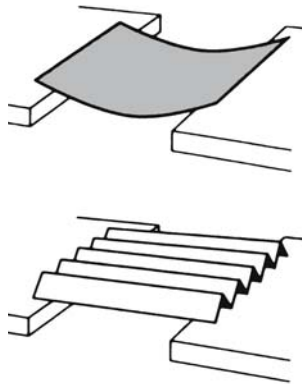


Fig. 65: Stiffening a piece of paper by folding it – the principle of the folded plate

### Folded plates

If you place two pieces of paper on two supports, fold one concertina fashion and leave the other unfolded, you will notice that the unfolded sheet deforms under its own weight, but the folded piece remain stable. This is the principle of the folded plate.

Folded plates are inclined, flat surfaces with shear-resistant connections along the edges (the “folds”). The forces are carried by slab and plate action. Whereas slabs are loaded perpendicular to their plane and primarily in bending, the considerably stiffer plate with its higher load-carrying capacity can accommodate forces in its plane and transfer these to the supports.

Folded plates therefore enable large areas to be spanned without intermediate columns; they are used mainly for long-span roof structures.



Abb. 68: Folded plate roof supported on Y-columns  
Hans Hofmann: waterworks, Birsfelden, Basel (CH), 1953/54



Fig. 66: Forms with single curvature

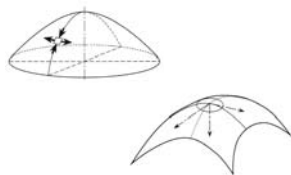


Fig. 67: Forms with double curvature

### Shells

Shells are three-dimensional, thin-wall structures. Owing to the mouldability of reinforced concrete and prestressed concrete, the majority of shells have been built in these materials.

The form not only governs the architectural appearance but also determines the loadbearing behaviour. Like with an arch there is also a “perfect” form for a shell structure. This is the case when, subject only to self-weight, the so-called membrane tension state is reached, i.e. exclusively axial and shear forces in the plane of the shell throughout. Consequently, a shell



Abb. 69: Shell designed with perfect form (parabola), shell thickness approx. 6 cm. Robert Maillart: Cement Industry Pavilion for Swiss National Exhibition, 1939



Abb. 70: Shell designed as a fluid form  
Heinz Isler (with P. Wirz, architect): Kilcher factory, Recherswil (CH), 1965

structure can have a slenderness ratio (ratio of span to depth) of 500 or more.

The structural engineer Heinz Isler developed three form-finding principles by means of various experiments:

- membrane form: subject to compression from inside
- suspended form: hanging fabric subject to self-weight (free forms)
- fluid form: escaping, solidified foam

The formwork requirements for a shell structure are relatively high. Three different methods of construction are available for reinforced concrete shells:

- concreting over centering
- the use of precast elements
- the use of pneumatic formwork

Of these three, centering is the one most widely used in practice.

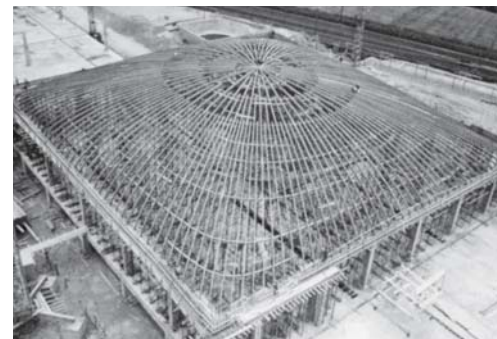


Abb. 71: Shell designed as membrane form, built over centering  
Heinz Isler (with VSK and Frei Architekten): COOP warehouse, Olten (CH), 1960

## Wood: indifferent, synthetic, abstract – plastic

### Prefabrication technology in timber construction

Andrea Deplazes

Over the past ten years we have seen developments in systems and semi-finished products that have replaced everything that hitherto had been considered as standard practice for the tectonic fundamentals of timber construction. In fact, the “traditional platform frame construction of the 1990s”, which promised the emergence of an “unconstrained”, non-modular domain of prefabricated timber construction, is already an anachronism today.

It is surely no mere coincidence that the latest forms of timber construction have appeared in central Europe and Scandinavia, in other words in countries that rely on industry that promotes wood as a resource. To be able to overcome the stagnation in traditional timber building, such countries are dependent on innovations that can attract further market share away from the solid construction sector. Huge quantities of unused wood from storm-damaged trees in forests flattened by gusts of hurricane force exacerbate the situation and provoke a predatory battle which, for the first time in the history of building, is taking place in the other direction, i.e. from solid construction to timber construction.

#### Fundamental manual skills

A whole series of old carpentry techniques found favour again in the “traditional platform frame construction of the 1990s”. For example, the jointing of squared sections to form plane frames with top and bottom members, or covering the frame with boards or planks to provide the stability and rigidity necessary for a construction element (wall or floor) to become a structurally effective plate. An opening in such an element always represents a disruption, which must be “trimmed” properly.

#### Complementary layers in platform frame construction

The tectonic goal appears to coincide with building performance objectives: the frame of squared sections carries the load, the inner sheathing provides the rigidity, and the outer sheathing closes off the frame, in which the thermal insulation is embedded, and thus holds the complete sandwich together. Finally, on the outside another layer (on battens to create a cavity for air circulation) protects the sandwich from the weather, and inside in similar fashion the visible wall surface is completed with the desired quality, concealing a void for the installation of services. The layer-type construction of such a facade element in platform frame construction is thus complementary, i.e. built up in such a way that the layers supplement each other, with each individual layer performing essentially just one function. The composition and the quality of the materials of the components in a platform frame system are largely defined by the supplier of the system. The architect no longer has to consider or draw the inner workings of such a package. He or she determines merely the aesthetic quality of the outer, visible surfaces.

#### Shaping deficit of new technologies

The growing interest in new timber construction technologies would seem to support the view that, for the first time in the history of architecture there would seem to be a trend away from solid to timber construction, which belongs to the category of filigree construction (tectonics). Gottfried Semper’s “theory of metabolism” is a good example. It is less concerned with building technology itself and more concerned with consequences for architectural expression at the point of transition from tectonics to stereotomy, a sort of transfer of timber construction to solid construction. (I call this conflict “technological immanence versus cultural permanence”.) We also have the first reinforced concrete structures of François Hennebique, which still adhered to the tectonic fabric of timber structures, with a hierarchical arrangement of posts, primary beams and secondary joists. And only after a certain period of acclimatisation did Robert Maillart manage to establish the intrinsic principles of reinforced concrete construction: columns with column heads that merge with flat slabs and in doing so create something like a hybrid plastic node at the column head in which the reinforcement – later no longer visible – is placed.

An inversion of the “art form” into the “core form” (Carl Bötticher) thus takes place, with the force indicated only through the concentration and grouping of the steel reinforcement before the concrete is poured. Through these observations we arrive at the following conclusion: the shaping criteria of the new technologies intrinsic to the system appear only after overcoming permanent cultural images (stereotypes).

#### The search for adequate structure and form

If traditional prefabricated platform frame construction with its studs internally and sheathing to both sides represents an interim form that is still clearly based on handed-down carpentry techniques and the strict, tectonic rules of timber construction, what structure and form can we expect to be inherent in and adequate for current timber construction technology?

To look for an answer to this question we must first study the way in which timber is processed these days. The operations involved in manufacturing the semi-finished products are characterised by a descending sequence. In a first operation sawn timber of high and medium quality, e.g. planks, squared sections and boards, are produced for traditional methods of working. Glued laminated timber (glulam) is one of the most important semi-finished products. The cuts become ever finer, the sections ever smaller. The second operation produces strips, battens and laminations, which are processed to form multi-ply boards, solid timber panels, etc. The “waste” from these operations is cut into even finer pieces: sliced or peeled veneers are the outcome, e.g. for high-strength parallel



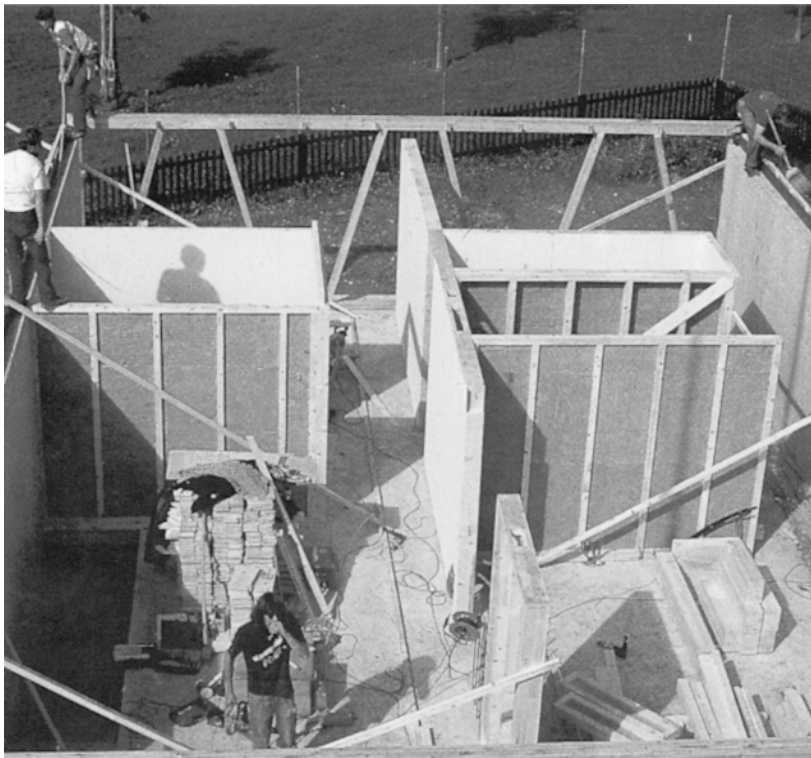


Fig. 1: Timber platform frame building during construction  
 Bearth & Deplazes: private house (Hirsbrunner), Scharans (CH), 1995

strand lumber (PSL) or chipboard. Afterwards, the fine waste, e.g. sawdust, is used and in the final operation boiled to form a fibrous pulp: the wood is separated into its fibres and its own fluid (lignin) and pressed to form boards like hardboard, medium density fibreboard (MDF) and softboard to round off the whole spectrum of products.

Every stage in the sublimation process is the antithesis of the assembly, the re-formation, mainly in the form of slabs and plates. And gluing is the jointing, re-forming technology. This is the reason why the subsequent processing of the semi-finished products, the “refining” and the further processing towards prefabrication for building works, gives rise to an astounding suppleness in the material, allowing every shaping intervention – the CNC-controlled milling cutter, the robot machining – virtually without resistance. The term “modelling” is certainly apt here because not only complex patterns but also plastic shaping such as profiling and even three-dimensional workpieces are produced whose surface developments can be defined numerically before machining.

#### CAD – CAM – Roboting

Within this production method wood takes on the character of a readily modelled and hence indifferent raw material. It is easy to imagine which options could emerge; in the production line from the architect’s CAD system to the CAM and CNC roboting of the fabricator it is certainly

realistic to order a “one-off” copy of a highly complicated carpentry joint, e.g. from a Japanese Shinto shrine, even for a relatively moderate price. That could be the beginning of a limited batch of architectural rarities (like in the world of fashion or cars), affordable for an eminent, selected clientele.

This fantasising leads us back to the starting point of a project, the design.

Today, planning with CAD software is standard practice in architectural design offices. The data line fits seamlessly into this so that the way in which the drawings are produced on the screen, irrespective of the traditional building technology, e.g. timber construction, must have a retroactive effect on the production and the tectonics of the structure. Non-modular, project-specific components are generated. Or in other words, the defined architectural project is broken down into manageable elements (plates, slabs and leaves), sent for production via the data line, and reassembled into a structure on the building site. This form of slab tectonics and the constructional fabric of layers of storeys, stacks of elements has long since become the norm in solid construction. But in timber construction it encourages new methods of design and construction. In addition, technological developments lead to ever stronger materials and, consequently, to ever thinner components.

#### Cardboard model on the scale of a structure

The “basic element” of modern timber construction is therefore the slab, and no longer the linear member. The slab consists of three or more layers (plies) of sawn timber, e.g. laminations or strips obtained from a relatively low-quality wood (formerly offcuts and waste), glued together with adjacent plies at right-angles to each other. This “cross-worked interweaving” produces a slab with high strength and good rigidity which can be used as a structural plate. Just like a textile, the length and width of our homogeneous slab without a recognisable internal hierarchy can be extended seemingly without limit (the only restrictions being the size of the presses and the road vehicles necessary to transport such elements), and in terms of thickness can be layered (specific slab thickness depending on loading case and stresses). Even the quality of the strips of softwood or hardwood or mixtures thereof – the “threads fabric” – can be optimised to suit the intended application. The direction of our slab is therefore irrelevant, our slab is isotropic, “indifferent” to the direction in which it has to span.

Theoretically, it can be produced as an endless band, but in practice the maximum dimensions are limited by transport. Both conditions have an effect on current timber construction. Slab tectonics and thin-wall plates (e.g. solid timber panels) behave, at full size, like cardboard packaging, as if a cardboard model the size of a real building had to be transported. This concerns not only



the physical perception. It becomes more obvious when dealing with openings. Seemingly punched through or cut out of the plates at random, like cutting cardboard with a knife, the incredible resistance of slab tectonics becomes visible in the structure. A similar behaviour is evident in the American balloon frame, the assembly with the nailing gun in which it is easily possible to cut away a whole corner of a building after erection without the entire construction collapsing because the whole structure is well oversized. (Such an approach would be unthinkable in Eu-

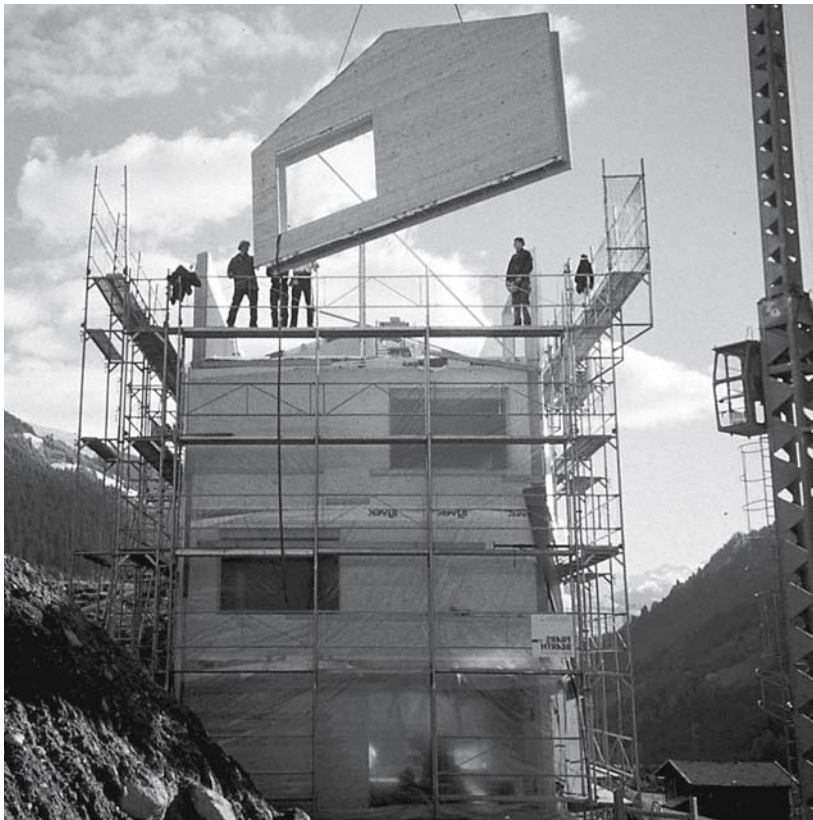


Fig. 2: Solid timber panel building during construction  
Bearth & Deplazes: private house (Bearth-Candinas), Sumvitg (CH), 1998

ropean platform frame construction!) However, compared with current European slab tectonics, the American balloon frame method seems old-fashioned, even “casual”, with the need to replace insulation and sheathing again on site.

#### Forecast: compact systems

The state of European slab tectonics allows us to make the following predictions for its development. Only those systems with a compact solution for the loadbearing–building performance–weather protection issue (sandwich facade elements, so-called compact systems) and simplified layering of the element, i.e. fewer layers, will prove worthwhile. I will call these complex synthetic systems consisting of multifunctional components. The total breakdown

of the facade into countless layers began in the 1970s, as the building performance aspect started to accrue new significance due to the oil crisis. The construction was divided into individual functions which intelligent synthesis measures are now reassembling into fewer components. This also corresponds to a trend in solid construction in which new single-leaf loadbearing and insulating materials are being used as a reaction to the design-related complications and problematic guarantee pledges of the ever more complex specifications required by multi-layer, monofunctional complementary systems (double-leaf masonry etc.).

A synthetic facade element might then have the following make-up: a basic element consisting of a thin-wall ribbed slab, e.g. a solid timber panel 3.5 cm thick, with 20 cm deep transverse ribs in the same material glued on to provide buckling resistance, and the intervening spaces filled with thermal insulation. This basic element with its flat side on the inside functions as a loadbearing plate (supporting, stiffening, bracing), as a framework for the thermal insulation and as a vapour barrier (the adhesive within the solid timber panel guarantees this property). The homogeneous, internal wall surface can be subsequently worked simply and directly, e.g. painted or wallpapered. It is unnecessary to attach sheathing on the inside clear of the core element when there are no electric cables to be fitted (and hidden) on the internal face development. Simple timber boards fitted to the ribs on the outside close off the wall sandwich and function as a substrate for the external skin. In the house for Bearth-Candinas, which is described in more detail below, the larch shingles are nailed directly to the boarding without an air cavity in between.

The thin-wall ribbed panels represent a form of construction that is related to automobile and aircraft construction, where the thin loadbearing membrane of lightweight metal and plastic, stiffened with ribs, has to withstand very high stresses; optimum rigidity and stability coupled with minimum use of material. Whereas in aircraft design it is mainly the weight of the assembly that is critical, in the slab tectonics of current timber construction it is primarily the compactness of synthetic elements and, at the same time, their ability to perform several functions.

A comparison with the platform frame construction mentioned above illustrates the fine “revaluation” at once. Whereas the inner sheathing of the frame is merely the bracing and the vertical studs are clearly loadbearing posts, the ribbed slab, apparently similar in terms of architecture and engineering, is a reversal of this system. The thin slab – just 3.5 cm – is loadbearing, braced by fine transverse ribs. However, this analytical approach must be corrected immediately. The two components (slab and ribs) form an indispensable, compact, synthetic package

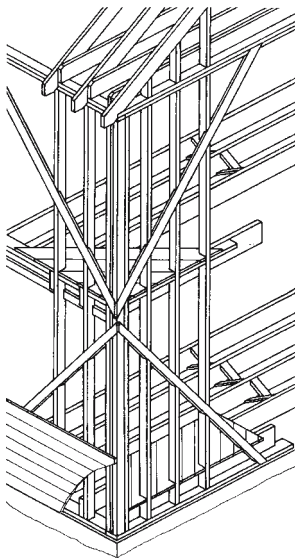


Fig. 3: Balloon frame method  
Multistorey, continuous timber studding

(thanks to the structural adhesive) in which loadbearing structure (supporting, bracing) and building performance (vapour diffusion), constructional internal workings and visible surfaces are merged and every component assumes multiple functions in conjunction with all the other components. In current timber construction we therefore speak of compact systems.

In the vertical direction, as a succession of stacked facade elements, it is evident that the loadbearing and insulating layers continue without interruption because the floors are supported only on the 3.5 cm thick solid timber panel. The situation is different in platform frame construction with top and bottom members, where the facade construction is completely interrupted to support the floors; the only way of preventing this is to build in supports in the form of projecting steel angles (Z-sections). I shall explain this by means of an actual example.

#### Example: stretch pullover over slab tectonics

The house for Bearth-Candinas, a slim, four-storey “tower house”, stands on the edge of the village of Sumvitg. The plan layout is a simple rectangle divided on the long side by a loadbearing central partition. That creates two elongated rooms per storey which could serve any type of function because they can be further subdivided depending on the needs of the occupants. As the quantity of run-off water on the slope is considerable, the house was built without a cellar. On entering the house we must first pass through a glazed hall (winter storage for plants and play area for the children) in order to reach the actual entrance door to the living quarters above. As all timber building systems have little heat storage capacity and therefore tend to adhere to the insulation concept of achieving a low thermal balance, the windows can be found in all facades, facing in every direction to ensure that there is no overheating in summer. In winter the solar radiation heats up the glazed entrance hall, and the heat rises and spreads through the living quarters and bedrooms above.

Without any finishes the surfaces of the solid timber wall panels would appear rather coarse, but – to return to our theme – they are painted white and lemon yellow so that the butt joints between facade elements and loadbearing walls are disguised and the interior appears homogeneous. The impression of a “wooden house” is relegated to the background in favour of a delicate, almost paper-like construction whose rooms appear to have been wallpapered. (A close inspection reveals thousands of fine, regularly spaced cracks in the walls, a true “cultivation of the crack”, which will never again give cause for clients to complain!) As the only shingle-maker in Grisons is based in the village, it seemed an excellent opportunity to clad the facade in wooden shingles. The shingles cover the building like a tight-fitting stretch pullover, lending it a uniform external appearance and concealing the slab tec-

tonics. This building therefore benefits from a seamless interaction of industrial high-tech production and tried-and-tested craft skills plus expertise.

#### Abandoning the wooden paragons

If we continue to pursue slab tectonics and the option of a facade skin without a ventilation cavity, we inevitably discover that current timber construction is no longer bound to its “wooden paragons”. This is due to two reasons:

Firstly, these days a whole spectrum of non-wooden facade sheathing systems are available, e.g. sheet metal, glass, plastic panels, even plastic film, expanded metal for render, fibre-cement sheets and corrugated metal sheets. The latter characterise the architecture of Reykjavik, the capital of Iceland, in an extraordinary way. One result of the American–Icelandic economic development programme “sheep for sheets” (Iceland has no trees) is that the strip-like profiling of the colourfully painted facades turn out to be not timber boards with strips covering the joints – totally in keeping with Mr Semper’s ideas. Or looked at in a more general sense: the modern timber buildings are hidden behind other, non-wooden materials whose advantages are lightness, thinness and large, sealed areas with few joints. Of course, the possibility of using the substrate for the protective sheathing as the protection itself in order to achieve the most compact facade element construction has been considered. However, the problem of the butt joints between elements and the network of joints then becomes more acute, as we know all too well from the heavyweight panel construction of the planned economies of the former Warsaw Pact countries.

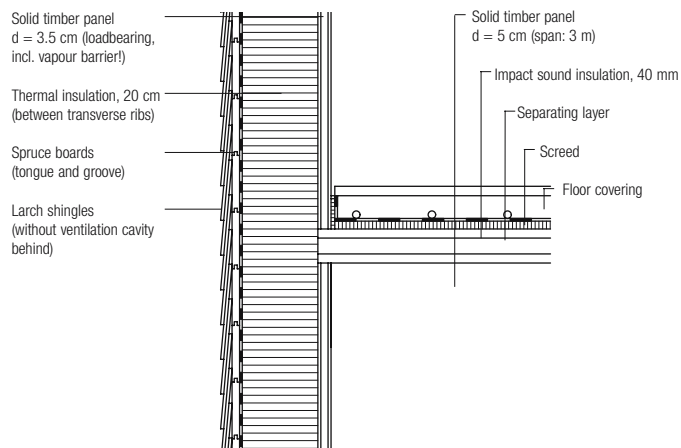
The second tendency is, in my opinion, even more interesting. The slab tectonics of current timber construction are interpreted exclusively in structural and not material terms like conventional timber building. What was earlier described as cardboard packaging – as a technology-related process for working large panels of thin-wall ribbed slabs in solid timber, but also the thick-layer slabs – will have architectural consequences. Timber will be regarded as “synthetic” – above all when it is neutralised inside and outside with a coat of paint – and will take on a similar standing to monolithic concrete in solid construction, which in structural terms can take over all the tectonic elements of a building without ever allowing the material to express itself. (We sense, at best, that certain cantilevers, layouts and large spaces are only feasible thanks to the “invisible concrete”.) In fact, the architectural theme of abstraction is enriched by the concept of cardboard packaging thanks to the phenomenon of “white blocks”, which create maximum plasticity with thin-wall elements (comparable with the art works of Absalon). On the other hand, the simple method of fretsaw-like cutting of panels with openings sawn (almost) at random and the model-like assembly of the walls and floors promote do-it-your-

self construction methods so typical of modern American balloon-frame architecture, and which, apart from that, are reflected in the building instructions of the Dutch artist Joep van Lieshout as a noble handicrafts workshop.

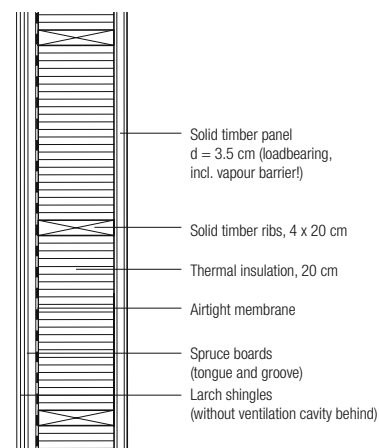
### Professionalism in architecture

Owing to the growing interest in performance, ecological and biological issues in building, current timber construction will gain more significance. Only compact, multi-functional solutions will prove competitive, but the experts in the synthesis of the most diverse requirements will not restrict themselves to developing and mastering technological know-how. In the first place the experts will prove themselves in intelligent and competent architectural design strategies – the sole guarantor for professionalism and hence “sustainability” in architecture. It is therefore not the timber specialists, timber technologists, biologists or performance specialists who are being put to the test here, but instead, first and foremost, the architects.

Excerpt from: *bauen + wohnen*, 1/2 (2001), pp. 10–17



**Fig. 4: Section through wall–floor junction**  
Bearth & Deplazes: private house (Bearth-Candinas), Sumvitg (CH), 1998



**Fig. 5: Horizontal section through wall**  
Bearth & Deplazes: private house (Bearth-Candinas), Sumvitg (CH), 1998

## The materials

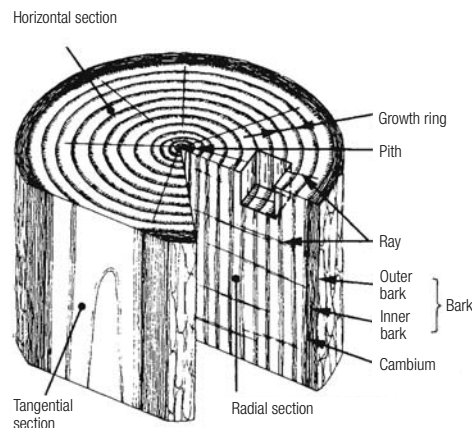


Fig. 6: Section through tree trunk

### The structure of wood

The porous structure of wood is due to the cells and vessels which provide the tree with water and nutrients. Deciduous trees, in phylogenetic terms the older variety, exhibit three different types of cells – for support, conduction and storage. Coniferous trees, however, have just one type of cell, which supports, conducts and stores all in one, and this fact increases the elasticity of this type of wood considerably.

At the very centre of the trunk we find the pith. This is the oldest part of the trunk around which the wood cells grow. The pith is usually dry and does not contribute to the provision of water and nutrients. A cross-section through the tree trunk reveals the radial rays. These, together with the colour and the growth rings, and in some species of wood the resin pockets as well, determine the characteristic appearance (figure) of the wood, and provide clues to age and diseases.

The structure of the growth rings is connected to varying phases of growth corresponding to the respective climate zones. In the temperate climate of Central Europe the growth phase begins in April/May and ends in August/September. In spring therefore we see a layer of large-pore, thin-wall early-wood cells which promote rapid transmission of water and nutrients, and in autumn the formation of the thick-wall late-wood cells that give the tree strength. The cambium is the layer below the bark; cell division here creates bark on the outside and wood cells on the inside.

### Heartwood, sapwood and ripewood trees

The colouring of some species of wood is uniform, while the colour of others varies within the trunk cross-section. The inner, dark growth rings are surrounded by the sapwood (xylem) with its lighter colour. The sapwood contains the active, living wood cells, those in the heartwood are mostly dead. The heartwood starts to form once the tree reaches an age of between 20 and 40 years (depending on the species), once sufficient sapwood is available to

transmit water and nutrients. The inner heartwood then no longer needs to fulfil this function and its channels are blocked chemically. Deposits of tanning substances and pigments, resins and fats darken the middle of the trunk, the strength and resistance to pests increase.

#### Heartwood trees

Heartwood and sapwood exhibit different colouring  
pine, larch, oak, cherry, robinia, ash

#### Ripewood trees

Heartwood has lower water content than sapwood  
fir, spruce, copper beech

#### Sapwood trees

Heartwood dies after a delay or when tree has reached an advanced age  
birch, alder, maple, poplar, hornbeam

### Properties of wood

The main physical properties of wood depend on its density; this ranges from 0.1 to 1.2 g/cm<sup>3</sup> depending on the species of wood and even fluctuates considerably within the trunk owing to the anisotropic nature of wood. Furthermore, the density also depends on the moisture content of the wood, which is why density figures must always be accompanied by the relevant moisture content.

Owing to its fine-pore structure, wood is a relatively good insulating material. The thermal conductivity of wood is around 0.13 W/mK for softwood and 0.20 W/mK for hardwood; this compares with figures of 0.44 W/mK for clay bricks and 1.80 W/mK for concrete. In comparison with steel or concrete the thermal expansion of wood is so small that it is irrelevant in building.

Parallel with the grain wood can carry tensile and compressive stresses with ease, but perpendicular to the grain it has a lower compressive strength. The main constituent of wood is cellulose (max. 40-50%), which is responsible for its tensile strength. Some max. 20-30% of the wood consists of hemicellulose, fillers and propolis which improve the compressive strength. Lignin or urea, which also have an influence on the compressive strength, make up another max. 20-30% of the wood. Further constituents are resins, fats and waxes, tanning substances and pigments, proteins, carbohydrates and mineral salts, which are responsible for giving the wood its colour and smell, and contribute to its resistance and strength. Softwood comes from fast-growing, hardwood from slow-growing trees.

In contrast to steel or concrete, wood remains unaffected by a wide range of pH values. Overall, working the material saves energy, partly because of its recyclability. There are about 40 000 species of tree, some 600 of which are used commercially.



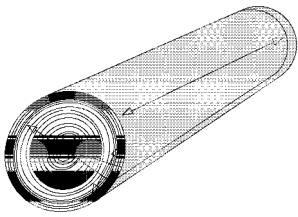


Fig. 7: Shrinkage and swelling of a trunk

**Moisture content of wood**

Owing to its hygroscopic nature, the moisture content of wood changes depending on the level of moisture in the surrounding air. If moisture is absorbed, the wood swells (absorption), if moisture is released the wood shrinks (desorption). Freshly felled timber has a moisture content of about 60%. The fibre saturation point lies around 30%, and a further drop in the moisture content then leads to shrinkage.

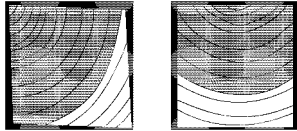


Fig. 8: Distortion of squared sections during drying

In principle, timber for building work should be dry; a high moisture content reduces the strength and influences dimensional accuracy and form stability. Timber with a high moisture content is also at risk of being attacked by insects or fungi. And in order to prevent rot, the form of construction must ensure that the timber components remain well ventilated. Air-dried timber for external works should have a moisture content of 15–18%, for internal works 9–12%. Further drying-out leads to fissures and renders the timber unusable. Pieces of timber cut from the trunk cross-section may distort as they dry out. This is caused by the different moisture contents of the heartwood and sapwood. Fissures often form in round and sawn sections, and although such defects do not impair the loadbearing behaviour, the change in shape must be taken into account at joints and when accuracy is important.

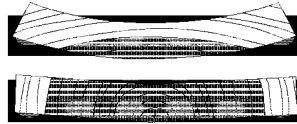
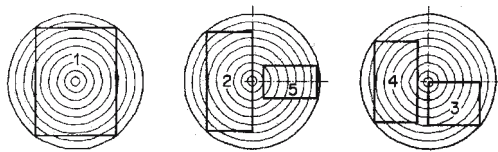


Fig. 9: Distortion of boards during drying



- 1 Squared log (boxed heart)
- 2 Heart section (exposed pith on face)
- 3 Heart section (exposed pith on arsis)
- 4 Side section
- 5 Centre section

Fig. 10: Conversion options for squared sections and battens  
(to Swiss standard SIA 256/1 5.3.6.1: Timber construction – supplementary provisions)

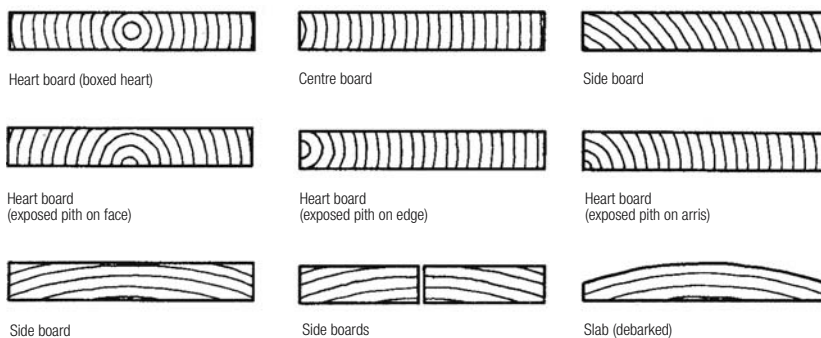


Fig. in 11: Conversion options for boards  
(to Swiss standard SIA 265/1 5.3.6.2: Timber construction – supplementary provisions)

**Round sections**

These are essentially logs – tree trunks with all branches and bark removed – which are mostly used without needing any form of working, e.g. for scaffolds and bridges, piles, masts and propping. Round-section timber members exhibit a high strength because the natural course of the grain has not been disturbed.

**Sawn timber**

Generally, the method of sawing (converting) the tree trunk does not have a serious effect on the strength. However, it is important in the following instances:

*Shrinkage and swelling:* The distortion of the cross-sections as the moisture content changes depends on the position of the growth rings within the section.

*Fissures that form as the wood dries:* The shear strength can be impaired in sections containing the pith.

*Compression perpendicular to the grain:* The compressive strength perpendicular to the grain depends on the alignment of the growth rings within the section. However, this aspect is not normally relevant.

*Biological resistance:* Enhanced resistance can be achieved by using sections without sapwood.

**Squared sections**

The standard dimensions (in cm), in 2 cm gradations, at the time of conversion:

- 6 x 14...6 x 20, 8 x 12...8 x 24, 10 x 10...10 x 28,
- 12 x 12...12 x 28, 14 x 14...14 x 28, 16 x 16...16 x 28,
- 18 x 18...18 x 28

**Battens**

The standard dimensions (in mm), rough-sawn, air-dried:  
24 x 30, 24 x 48, 27 x 35\*, 27 x 40\*, 27 x 50\*, 27 x 60\*,  
30 x 48, 30 x 60, 50 x 50, 60 x 60, 60 x 80, 60 x 100,  
60 x 120, 80 x 80, 80 x 100

\*Western Switzerland

**Boards**

The standard thicknesses (in mm), rough-sawn, air-dried:

- 12, 15, 18, 21, 24, 27, 30, 33, 36, 40, 42\*, 45, 50, 55,
- 60, 65, 70, 80

\*Western Switzerland

(to Swiss standards SIA 265:2003 and 265/1:2003)

## Wood-based products

### Overview



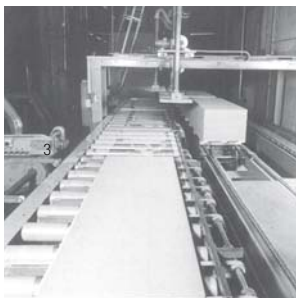
1



2



3



4

**Fig. 12: Production of wood fibre boards**

- 1 Timber from sawmill
- 2 Conveying the chips
- 3 Fibrous pulp on forming machine
- 4 Final processing

The question for the future is how to satisfy the increasing demand for timber in light of dwindling resources and poor quality (fast-growing wood). The answer is that wood-based products will increase in significance. The economic use of wood, or rather the use of the “waste” generated during its processing, has led to the development of numerous new wood-based products.

Wood-based products are manufactured by pressing together wood particles of various sizes, e.g. boards, strips, veneers, veneer strips, chips and fibres, with synthetic resin adhesives or mineral binders. In some cases wood’s own binder (lignin) is activated. Besides larger pieces of wood, even residues and/or waste products from the processing of wood can be used. The manufacturing process clearly brings about a full exploitation of the raw material; and the process also homogenises the irregular properties of wood. Wood grows naturally and as a result contains unavoidable irregularities such as knots, fissures and interlocked grain, which can reduce the strength of the wood. However, these irregularities play only a minor role, if at all, in wood-based products because they are more or less neutralised by neighbouring particles. As a result, the structural properties of a wood-based product exhibit comparatively little scatter, which results in the very favourable 5% fractile to help establish the permissible stresses.

It is possible to influence the load-carrying capacity in a certain direction through the deliberate arrangement of the individual particles. Swelling and shrinkage of wood-based products is generally less than that of solid timber. Another advantage of slab-like wood-based products is the possibility of producing boards or beams in (theoretically) unlimited sizes, the only limits being those imposed by the machinery and transport. All wood-based products are available and/or produced with standard dimensions, a fact which is very useful for planning and stockpiling.

The range of products fulfils the demands of the most diverse applications. Furthermore, almost all products are easy to work with. As the range of wood-based products has in the meantime become very extensive and is undergoing continuous development, the following list cannot claim to be exhaustive, merely representative of the most common products currently available. These products are described in detail on the following pages.

#### *Layered products*

- Glued laminated timber (glulam)
- Plywood
- Veneer plywood
- Wood-based core plywood
- Multi-ply boards
- 3- and 5-ply core plywood
- Solid timber panels

#### *Particleboards*

- Chipboard
- Flakeboard
- Oriented strand board (OSB)

#### *Fibreboards*

- Bitumen-impregnated wood fibre insulating board
- Medium density fibreboard (MDF)

#### **Wood-based products with inorganic binders**

Gypsum or cement can be used as a binder in the manufacture of wood-based products. The wood fibres embedded in the mass of gypsum or cement function as reinforcement. Such products are popular for thermal and sound insulation, fire protection, also for loadbearing and bracing applications. These products are not dealt with further in this book.

## Wood-based products

### Layered products

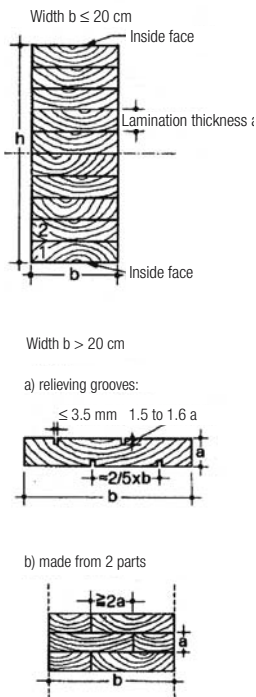


Fig. 13: Lay-up of glued laminated timber (glulam)

### Glued laminated timber (glulam)

#### Structure and manufacture

Glued laminated timber consists of three or more individual boards, or laminations, stacked horizontally and glued together across their width. The thickness of the laminations should generally not exceed 30 mm, although in straight components this can be increased to 40 mm if drying and selection of the wood is carried out particularly carefully and the components are not exposed to any extreme climatic fluctuations in the finished building. As a rule, the planed laminations up to 20 cm wide are glued together in such a way that in each case only “outside” (i.e. furthest from pith) and “inside” (i.e. nearest to pith) faces are glued together but with only “inside” faces on the outer faces (see fig. 13) of the member. Such an arrangement (lay-up) is necessary in order to minimise any transverse tensile stresses in the adhesive joints and in the wood caused by changing climatic conditions. For widths exceeding 20 cm it is necessary to use at least two boards adjacent to each other in every lamination and to offset the joints in successive laminations by at least two times the thickness of the lamination (see fig. 13b). Individual boards exceeding 20 cm in width must include two continuous longitudinal relieving grooves on both sides of the board (see fig. 13a).

Glued laminated timber members can be manufactured in practically any length and depth. The length is limited only by the available space in the works, the gluing table and/or the transport possibilities, the depth by the working width of the planing machines available. However, dimensions exceeding those of such machines (approx. 2.00 to 2.30 m) have been achieved in the past by gluing together two part-sections. Generally, lengths of 30–35 m and depths of up to 2.20 m are possible.

Glued laminated timber members may only be manufactured by companies possessing the necessary equipment and fabrication facilities in which the humidity of the air remains more or less constant during the work and where the temperature favours the gluing process.

The glues used depend on the climatic conditions to which the finished component will be subjected. Filled synthetic resins based on urea or resorcinol are employed, spread by the gluing machinery on both sides of the planed and finger-jointed boards with a certain moisture content. The boards are assembled on the gluing table to form rectangular sections and pressed together with the prescribed pressure for the prescribed time. Once the glue has cured sufficiently, the section is planed on two or four sides and drilled or otherwise machined as required. The moisture content of the wood at the time of gluing is especially relevant to the resistance of the finished, glued assembly and its freedom from cracks.

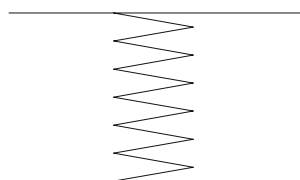


Fig. 14: Finger joint wedged and glued joint

#### Cross-sections and shaping

Glued laminated timber sections for columns, beams and frames are generally produced with a rectangular cross-sections. The depth-to-width of ratio for beams in bending usually lies between three and eight and should not exceed ten. In exceptional cases it is also possible to produce I- and box sections, which do save material but are more expensive to produce. However, this is often made up for by the better buckling and overturning resistance.

As wood is easily worked, members with straight sides can be produced in many forms. It is easy to discontinue certain laminations in order to vary the depth of the cross-section, but the slope must be relatively shallow in order to limit the transverse and axial stresses in the extreme fibres. Applying a gentle camber to the boards prior to gluing enables the production of curved glulam beams.

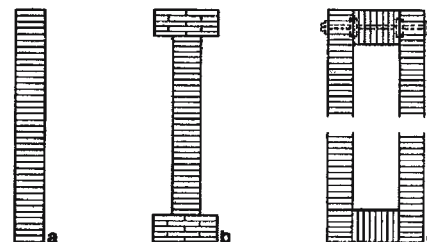
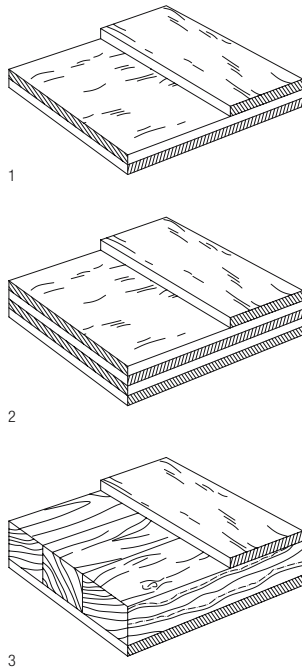


Fig. 15: Cross-sections in glued laminated timber  
a Rectangular  
b I-section  
c Box section, doweled or glued



**Fig. 16: Surface (peeled) of plywood**

The trunk is clamped in position and unrolled in order to produce veneers. This produces a relatively homogeneous surface with low contrast and irregular figure.



**Fig. 17: Lay-up of plywood**

1: 3-ply plywood  
2: 5-ply plywood  
3: Wood-based core plywood

### Plywood

Plywood is made from at least three cross-banded plies (i.e. grain of adjacent plies at approx. 90° to each other). The plies are glued together with waterproof phenolic resin glue with the help of pressure and heat. After pressing, the edges are trimmed and the surface(s) sanded or otherwise processed. Plywood can also be moulded into virtually any shape by applying pressure, heat and moisture (moulded plywood).

Plywood is suitable for many applications. For example, it can be used as a bracing facade cladding, as roof decking, as wall sheathing or in interior fitting-out work.

Plywood absorbs moisture and swells in the plane of the board as well as in its thickness. If the material is left untreated, ultraviolet radiation and driving rain will turn it a grey colour, which can be very irregular on the side exposed to the weather in particular. A facade of plywood can be protected by a coat of diffusion-permeable, water-repellent paint. The edges especially must be sealed with a good-quality water-repellent paint.

### Veneer plywood

Veneer plywood is manufactured from several cross-banded veneer plies (i.e. thin sheets produced by a rotary cutting, slicing or sawing) pressed together. In comparison to other wood-based products, this material is ideal for loadbearing constructions because its very high modulus of elasticity and high strength make it suitable for situations with high stresses.

### Wood-based core plywood

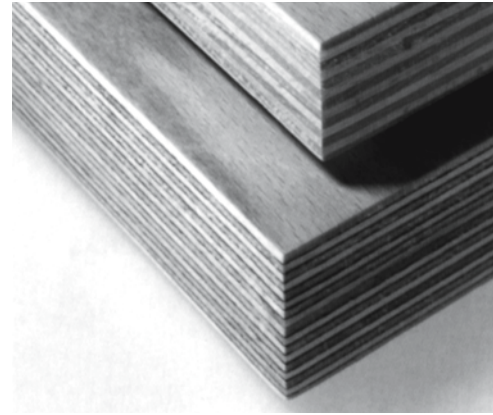
This is a type of plywood with a central core of timber strips, known as blockboard, laminboard or battenboard depending on the width of the strips used.

### Multi-ply boards

Plywood with at least five cross-banded plies and a ply thickness of 0.8–2.5 mm is often known as multi-ply board. Multi-ply boards can be used for external cladding, even in severe weather conditions, or internal linings. The high load-carrying capacity of such boards makes them suitable for loadbearing applications as well.

### 3- and 5-ply core plywood

A 3- or 5-ply core plywood consists of cross-banded plies with thicknesses between 4 and 50 mm. These boards



**Fig. 18: Close-up of edges of multi-ply boards**

are primarily used as loadbearing and bracing sheathing in timber buildings, and as formwork for concrete.

### Solid timber panels

Three or more cross-banded layers of strips without any outer sheathing. These can be used as loadbearing plates, but must be protected from the weather.



**Fig. 19: Surface (sliced) and edges of 3- and 5-ply core plywood**

In contrast to peeled veneers, the production of sliced veneers involves cutting the trunk into thin sheets.



## Wood-based products

### Particleboards

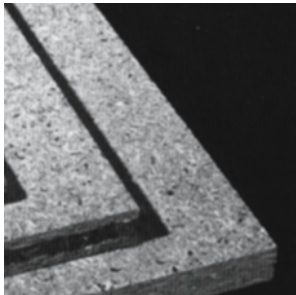


Fig. 20: Various edge profiles of chipboard

#### Chipboard

The residues from the forestry and woodworking industries form the raw material for the production of chipboard. The forest supplies deciduous and coniferous trees with diameters of about 8 cm and more in lengths from 1 to 6 m. The sawmills supply slabs and splinters, the so-called co-products resulting from the production of sawn goods, and the woodworking industry supplies offcuts, sawdust and shavings. Chipboard absorbs literally every last particle of the valuable resource wood. The particles of wood are mixed with organic binders and pressed together at high temperature to form the chipboard. However, particleboards can also be made by extrusion. In a pressed particleboard the chips lie essentially parallel with the plane of the board. They are produced with various particle arrangements within the thickness: single-layer (random distribution of particles) or multi-layer (three or more layers of particles of differing sizes), or as graded density chipboard in which the particles gradually decrease in size from the centre to the surfaces. Chipboard is usually supplied with its surfaces sanded but not further worked or finished. In extruded particleboard the chips lie mainly perpendicular to the plane of the board.

Chipboard is used for stiffening and covering floors and walls, for partitions and as sheathing. It is also suitable as a backing for veneers and coatings.

Chipboard generally exhibits a moderate strength. Its moisture resistance is lower than that of layered timber products and depends on the binder. However, special cement-bonded chipboards can be used in applications with a high moisture load or to meet demanding fire brigade stipulations.

#### Flakeboard

This is a particleboard made from thin, flat, wide and long particles of poplar measuring about 0.8 x 25 x 300 mm glued together at high temperature. The size of the shavings results in a higher strength.

#### Oriented strand board (OSB)

This is a three-layered board in which the grain of the particles in each of the layers is aligned, the orientation in the centre layer being across the board, while the grain of the particles in the surface layers lies parallel to the long axis of the board. These particles measure approx. 0.6 x 35 x 75 mm. OSB is primarily employed in the form of loadbearing and bracing sheathing. Owing to its low glue content its behaviour in the biological degradation process is practically identical with that of solid timber.

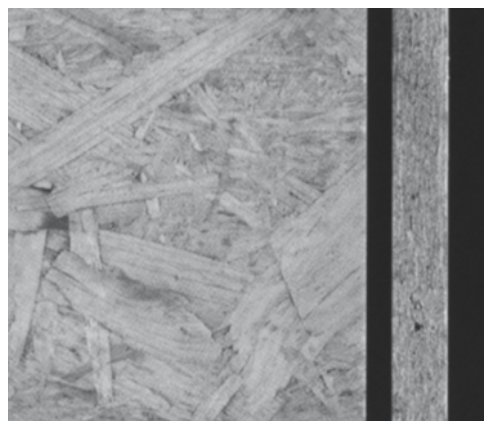


Fig. 21: Surface and edge of a flakeboard



Fig. 22: Surface and edge of oriented strand board (OSB)

## Wood-based products

### Fibreboards

#### Fibreboards

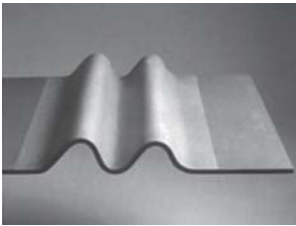
Fibreboards consist of a mixture of prepared long wood fibres (residues such as untreated sawmill waste and forestry thinnings, usually crushed softwood) and fillers that are pressed together with the help of water, pressure and heat without the need for any further binders. The structure of the wood is no longer recognisable. The strength of fibreboards varies from low to high depending on the degree of compaction.

The range of products on offer extends from soft insulating boards to medium-hard to hard boards. The latter are distinguished by their very hard surfaces and abrasion resistance; the soft insulating boards, on the other hand, exhibit high sorption and good heat storage capacity. Fibreboards are suitable for interior fitting-out works, roof decking, packaging, fillings and as sound and thermal insulation.

Fibreboards are produced using the wet method, which distinguishes them from a related type of board, the medium-density fibreboard (MDF). In the wet method the bonding forces inherent in the wood itself are used by employing a thermomechanical process to resolve the wood into its fibres; the resulting fibrous pulp is then bonded together under the action of pressure and heat. Therefore, no additional chemical binder is required.

#### Bitumen-impregnated wood fibre insulating board

A bitumen emulsion can be added during manufacture in order to make the board water-repellent. These boards are suitable for use as external insulation behind a ventilated timber leaf or facade, and also as impact sound insulation beneath floor finishes.



**Fig. 23: Shaped MDF**  
MDF (medium density fibreboard) can be shaped with templates under the action of heat and moisture

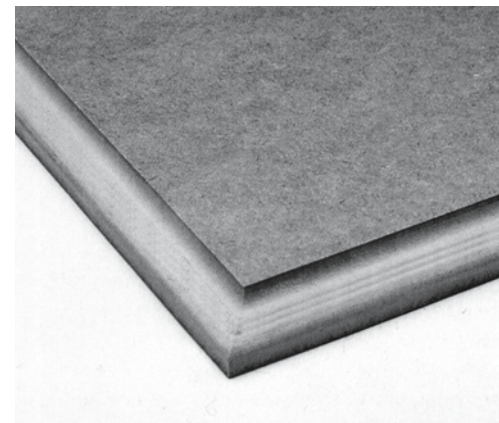
#### Medium density fibreboard (MDF)

MDF was first developed in the USA around 30 years ago. The dry method used for producing this type of board involves drying the fibres, spraying them with glue and subsequently pressing them together in a continuous process. Medium density fibreboards can be worked like solid timber. Three-dimensional profiling is possible with the thicker versions.

MDF is primarily used for furniture and fitting-out applications, also as a substrate for painting, veneer and coating work. Such boards are not stable at high moisture levels and should therefore not be used externally.



**Fig. 24: Wood fibre insulating boards**



**Fig. 25: Medium density fibreboard (MDF)**

## Important panel and prefabricated systems in Switzerland

### Overview

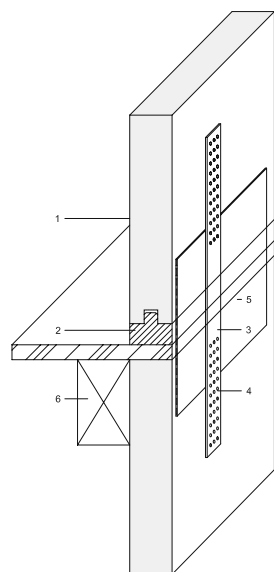


Fig. 26: Homogen80, detail of wall-floor junction

- 1) Homogen80 wall system
- 2) Timber sole plate
- 3) Nail plate
- 4) Annular-ringed shank nails
- 5) Seal in butt joint between panels
- 6) Edge beam

### Homogen80

#### Structure

Homogen80 is an 80 mm thick softwood chipboard. The board is made up of several layers which therefore achieve an independent mechanical strength. The surface layers also form a good base for direct surface finishes. The boards are produced in sizes up to max. 537 x 203 cm and can be fitted (glued) together to form larger panels by means of tongue-and-groove joints.

#### Design process

The design is not bound by any production-related module. The project can be designed as required and subsequently divided into elements in conjunction with the manufacturer. The stability and homogeneity of the raw material leaves plenty of scope for cutting elements to almost any size, with openings of virtually any shape.

The system is very similar to traditional solid construction, or rather “heavyweight prefabrication”, in respect of its structure, design options and building performance properties. The mass of the chipboard results in a heat storage capacity that creates similar interior climate conditions to a building of solid masonry or concrete.

*Loadbearing behaviour:* The direction of span is irrelevant.

*Shaping:* The material can be shaped during the production process.

*Applications:* The system must be combined with other systems at the floors and roof. The load-carrying capacity of the chipboard as a horizontal flooring element is inadequate over conventional spans.

*Facade:* It is possible to build a compact facade structure without adding a vapour barrier.

*Insulation:* The insulation is attached externally.

*Surface finish:* The surface of the chipboard is such that it can be rendered, plastered, wallpapered or tiled directly. The dimensionally accurate construction is beneficial to carrying out cutting work directly from the drawings.

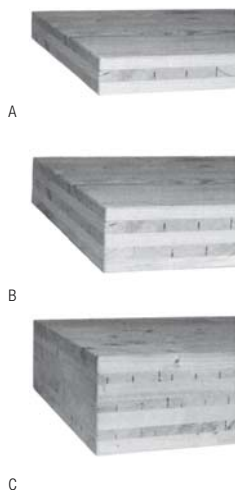


Fig. 27: LenoTec

- A) 3-ply, 81 mm B) 5-ply, 135 mm C) 7-ply, 216 mm

### Leno solid panels

#### Structure

The LenoTec wood-based product is a solid cross-laminated timber panel made from between three and eleven spruce plies glued together cross-wise. The resulting homogeneous, dimensionally stable and rigid component can be produced in sizes up to 4.8 x 20 m. Thicknesses of 50-300 mm are available depending on the number of plies.

#### Design process

The design is not bound by any production-related module. Ready-to-install components ready to erect are manufactured at the works. The machine-based assembly enables individual panel formats and shapes to be cut as required, with openings, slots and holes for the joints and electrical services. Curved elements with a minimum radius of 7 m are also possible.

*Loadbearing behaviour:* The direction of span is irrelevant.

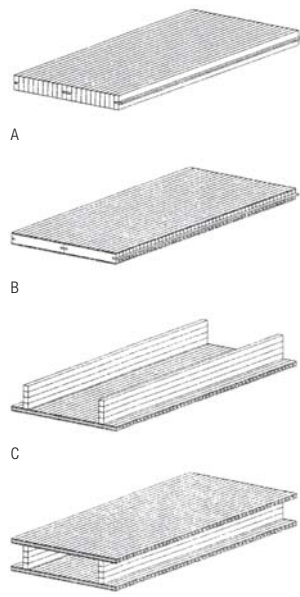
*Shaping:* Panels curved in one direction can be produced.

*Applications:* Walls, floors and roofs

*Facade:* It is possible to build a compact facade structure without adding a vapour barrier.

*Insulation:* The insulation is attached externally.

*Surface finish:* Available with industrial or fair-face finish. Facings with laminated veneer lumber (LVL) and special surface finishes are possible.



**Fig. 28: Schuler solid timber panel**  
 A) Single-ply panel  
 B) 3- and 5-ply panels  
 C) Ribbed panel  
 D) Box panel

### Schuler solid timber ribbed panels

#### Structure

A solid timber panel of short, cross-banded plies of spruce and fir side boards with a lamination width of 20 or 26 mm forms the basis for the Schuler ribbed panel. Panels measuring 3,00 x 9,00 m can be produced with between one and five plies in different thicknesses. The buckling resistance of these solid timber panels is then improved by gluing on transverse ribs made from the same material. This method allows the production of large elements. Box beams can be produced by gluing panels to both sides of the ribs.

#### Design process

The design is not bound by any production-related module. The project can be designed as required and subsequently divided into elements in conjunction with the manufacturer. Openings can be cut virtually anywhere in the panels. The stiffening ribs can function as supports for planking and cladding.

*Loadbearing behaviour:* The direction of span is irrelevant.

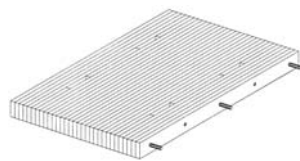
*Shaping:* The elements cannot be shaped.

*Applications:* Walls, floors and roofs

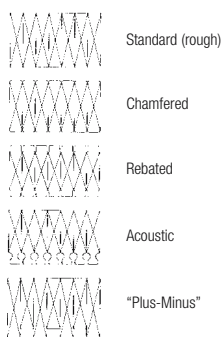
*Insulation:* Insulating material can be laid between the ribs.

*Facade:* It is possible to build a compact facade structure without adding a vapour barrier.

*Surface finish:* Available with rough-sawn standard, industrial and fair-face finishes. Finishes with facing-quality boards or laminated veneer lumber (LVL) are possible.



**Fig. 29: Bresta edge-fixed element**



**Fig. 30: Bresta edge-fixed elements**  
 Different types of section

### Bresta edge-fixed elements

#### Structure

Side boards 30 mm thick, a cheap (waste) material readily available from any sawmill, form the basis for these elements. The boards are placed on edge and joined with continuous dowels in a fully automatic production plant. The hardwood dowels hold together the "stack" of boards through a clamping effect. Neither glue nor mechanical fasteners are used. This method can produce one-way-spanning elements in any width with thicknesses between 8 and 12 cm for walls, and between 18 and 26 cm for floors, depending on the span. The dowels perpendicular to the direction of the boards ensure that the transverse shrinkage and swelling movements are reduced virtually to zero.

#### Design process

The design is not bound by any production-related module. The project can be designed as required and subsequently divided into elements in conjunction with the manufacturer. Openings can be cut virtually anywhere in the panels.

In comparison with lightweight construction, the mass of an edge-fixed element results in a higher heat storage capacity. Such elements are ideal for timber-concrete composite floors. Narrow elements (27 cm) can be supplied for conversion work where space is limited.

*Loadbearing behaviour:* Element spans in one direction.

*Shaping:* The elements can be bent transverse to the boards (barrel-vault roofs are possible).

*Applications:* Walls, floors and roofs

*Facade:* A compact facade structure requires the addition of a vapour barrier. If the inner surface is not lined, the vapour barrier can be fitted between the element and the insulation.

*Insulation:* The insulation is attached externally.

*Surface finish:* Rough-sawn boards are dowelled together if the surface is to be clad afterwards. On exposed surfaces the boards are planed on four sides. The dimensions of the boards can be varied to suit aesthetic and acoustic requirements (see fig. 30).



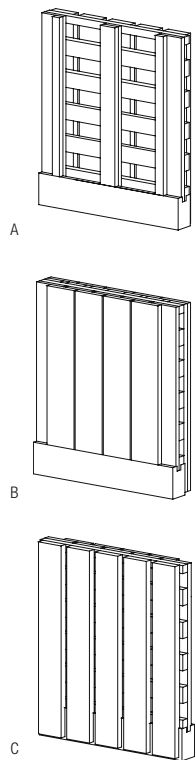


Fig. 31: Lignotrend wall elements

- A) Open both sides
- B) Closed on both sides
- C) Closed on one side

## Lignotrend

### Structure

Lignotrend consists of between three and seven cross-banded softwood plies, with gaps of several centimetres between the individual pieces of the inner plies. The raw material is exclusively side boards or low-strength wood. The wall elements are supplied in widths up to 62.5 cm and these elements can be joined together with timber plates and frames by woodworking firms to produce storey-high wall panels. Mechanical fasteners are used to join the individual elements together or to the floors above or below. The cross-banded arrangement of the plies results in very little shrinkage and swelling; movements are taken up in the joints.

### Design process

There is a production module of 12.5 cm but the design is not necessarily bound by this. The project can be designed more or less as required and subsequently divided into elements in conjunction with the manufacturer. Openings can be cut virtually anywhere in the panels. Floor and roof elements are available with a similar construction. Electric cables can be routed through the voids without having to cut or drill the panel itself.

*Loadbearing behaviour:* The direction of span is irrelevant.

*Shaping:* The elements cannot be shaped.

*Applications:* Walls, floors and roofs

*Facade:* A compact facade structure without an additional vapour barrier is possible, depending on the type of element chosen.

*Insulation:* The voids between the plies can be filled with insulating material. However, as this is very labour-intensive, corresponding tests have been cancelled.

*Surface finish:* A fair-face finish is available, depending on the type of element.



Fig. 32: Ligu timber element for walls, floors, roofs

## Ligu timber elements

### Structure

Ligu timber elements consist of several offset layers of solid timber laminations – side boards in various softwoods – glued together and additionally secured with hardwood dowels in the overlaps. This results in air-filled chambers and a box-like glued loadbearing construction. Like a glued laminated timber beam, such elements can span long distances. The elements are produced in thicknesses from 140 to 240 mm, i.e. seven to twelve plies, and in widths of 62.5, 41.6 and 20.8 cm. Loose timber tongues are used to join single elements to form larger ones. It is necessary to include a timber stud in the corners.

### Design process

It is advisable to adjust the design to suit the smallest element. Owing to the maximum element width of 62.5 cm, the openings should not lie within, but rather between the elements. Joints between elements cannot accommodate

any shear forces, which means that trimmers and lintels must be included.

*Loadbearing behaviour:* Element spans in one direction.

*Shaping:* The elements cannot be shaped.

*Applications:* Walls, floors and roofs

*Facade:* It is possible to build a compact facade structure without adding a vapour barrier.

*Insulation:* Depending on the thickness of the element, the enclosed air chambers (57% wood, 43% air) can provide adequate thermal resistance without the need for further insulation.

*Surface finish:* The elements must be clad.

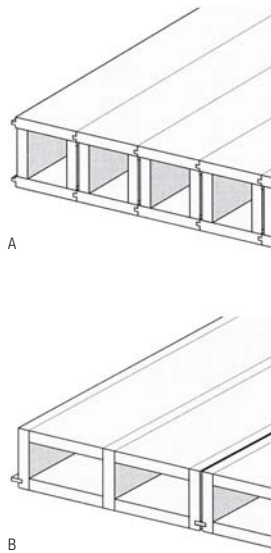


Fig. 33: Lignatur elements

A) Box element  
B) Planar element

### Lignatur box, panel and decking elements

#### Structure

Lignatur elements are hollow components produced industrially. They were developed for use as loadbearing floor and roof constructions. These modular elements are joined with double tongue-and-groove joints and can be pre-assembled in the works to form larger elements, the size of which is limited only by the restrictions imposed by transport. The box elements are produced with a cover width of 200 mm; the maximum length is generally 12 m, with longer lengths possible on request. The depth of the element can be chosen to suit the structural and building performance requirements.

Lignatur panels are produced in widths of 514 and 1000 mm as standard; the maximum length is 16 m. Lignatur decking elements are primarily intended for roofing applications.

#### Design process

The Lignatur elements are pre-assembled in the works to form larger elements. It is advantageous to base the design on the module given by the element width.

*Loadbearing behaviour:* Element spans in one direction.

*Shaping:* Individual Lignatur elements can be assembled to form curved roofs.

*Applications:* Floors and roofs

*Facade:* It is possible to build a compact facade structure without adding a vapour barrier.

*Insulation:* The voids in the elements can be filled with various insulating materials at the works.

*Surface finish:* Three surface finishes for the underside are available: industrial, normal and selected.

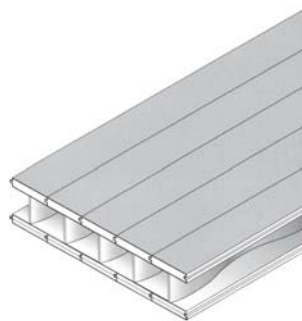


Fig. 34: Wellsteg hollow element

### Wellsteg hollow elements

#### Structure

The primary component of the Wellsteg hollow element is the sine wave-web beam measuring 16.6 cm wide and 19–51 cm deep. This consists of two solid timber (spruce/fir) tongue-and-groove flanges plus a sine-wave (birch) plywood web. A curved groove to receive the web is milled in the flanges in a special production plant. The plywood web, splayed scarf joints within its length, is cut to fit the groove and glued in place. Afterwards the beam is pressed together. Individual beams can be joined together with transverse timber pieces (fitted inside) to form larger panels.

#### Design process

It is advantageous to base the design on the module given by the beam width. The elements can be prefabricated in any size up to a length of 15 m. Pipes and cables are installed in the works. It is easy to drill holes through the web to accommodate services in the transverse direction. Wellsteg hollow elements have a low self-weight and are particularly suitable for adding floors to existing buildings. Compared with a reinforced concrete floor, the Wellsteg hollow element achieves a weight-saving of 7% for the same load, depth and span.

*Loadbearing behaviour:* Element essentially spans in one direction. However, the spacing between the flanges enables filler pieces to be inserted to enable the element to span in two directions. Openings can be cut in the floor at the works following the same principle.

*Shaping:* Sine wave-web beams can be assembled to form curved elements.

*Applications:* Walls, floors and roofs

*Facade:* A compact facade structure requires the addition of a vapour barrier.

*Insulation:* The voids in the elements can be filled with insulating material at the works.

*Surface finish:* Three surface finishes are available: industrial, fair-face and selected.

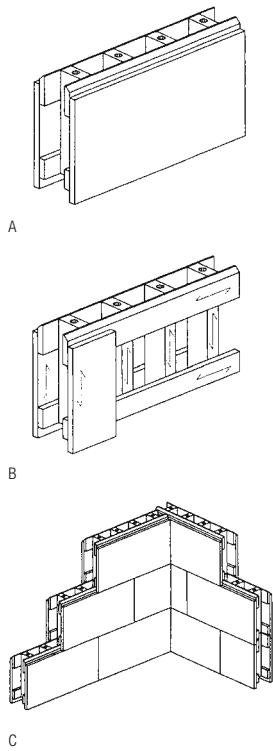


Fig. 35: Steko wall system

- A) Steko basic module  
 B) Structure of module and direction of grain  
 C) Wall corner detail

### Steko wall system

#### Structure

Steko is a modular system based on standardised, industrially produced solid timber modules. The individual modules are joined by means of a special clip-in arrangement which guarantees an optimum joint at corners and junctions with intermediate walls. Matching sill, lintel and jamb elements to suit the various openings round off the system. The compact modules consist of five plies of cross-banded solid timber. Used in a wall, the modules form a rigid, structural unit thanks to the clip-in connection.

#### Design process

The system is based on a primary module of 16 cm. The basic modular dimensions of 64/32/16 cm (length/height/thickness) also permit quarter, half and three-quarter formats within the 16 cm module. The depth module is 8 cm, which enables two finished depths of 32 and 24 cm to be achieved. Sole plates, head binders and lintel elements are coordinated with the modular dimensions. Hoses for services can be threaded through the modules. The Steko wall system can be combined with standard windows and doors, also conventional floor and roof systems.

*Loadbearing behaviour:* Element spans in one direction.

*Shaping:* The modules cannot be shaped.

*Applications:* Walls

*Facade:* It is possible to build a compact facade structure without adding a vapour barrier.

*Insulation:* The voids in the modules can be filled with a suitable insulating material after erection. Additional insulation can be attached to the outside if the building performance specification calls for this.

*Surface finish:* the modules are available with a facing in fair-face quality, either a vertical single-ply board or, on request, horizontal 3-core plywood.

## Panel construction

### Current developments

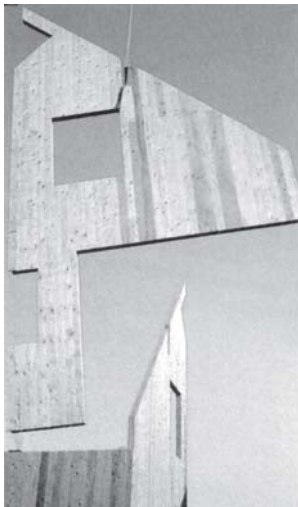


Fig. 36: Erecting a panel construction element  
LenoTec cross-laminated timber panel

The structural system of panel construction is determined by loadbearing slabs or panels, which are joined in a “slab tectonics” system to form a stable assembly. This distinguishes them from those sandwich constructions which, although prefabricated to form internally lined and externally clad frame constructions, still consist of linear members (the so-called black box). The planar nature of the isotropic loadbearing panel leads to completely new structural and design-related properties unusual in timber engineering. The grid of regularly spaced loadbearing elements so typical of traditional timber building is now superfluous, and openings can be cut almost anywhere in the surface.

#### Material conglomerates

Recent trends in the construction industry have led to changes in the design and building processes and hence the role of the architect. The diversity of the systems and materials on the market mean that the architect is increasingly reliant on the specific expertise of industry, which can offer ever more comprehensive end-to-end solutions and is therefore focusing the specialist knowledge and guarantee clauses on the side of the manufacturer.

Looking at *solid construction* it would seem that all innovations are concentrating exclusively on new cladding systems or surface finishes. The structural shell has hardly changed, hardly developed any further. In situ construction continues to prevail in Central Europe, despite the relatively high cost of labour and, sometimes, obvious deficiencies in the workflow. We could take electricians as an example: no sooner is the masonry wall built, do they begin to cut slots all over it for their cables and conduits! Multi-layer building component systems – hardly ever developed by the architect any more, but instead merely chosen out of a catalogue – clad our conventional structural shell something like a “camouflage strategy”.

Looking at *timber construction* we find that current developments and innovations are of a more fundamental nature. In this respect the timber building sector has assumed a special status within the construction industry. Here again, however, high-tech skills are being delegated to the specialists employed by the manufacturers. This eases the architect’s workload because he or she no longer has to consider the detailed inner workings of the construction. On the other hand, this competence is being lost from the architect’s range of skills.

#### Semi-finished products and the manufacture of wood-based products

In Central Europe and Scandinavia the movement in this sector was triggered by a crisis in the timber building industry. In order to regain market share from solid construction and to find a rapid use for wood from trees brought down in severe storms (“Vivian” in 1990 and “Lothar” in 1999) innovations were urgently required.

Such innovations initially focused on semi-finished goods and the manufacture of wood-based products. Traditional woodworking processes require timber cross-sections with a roughly consistent quality. This means that when cutting planks, squared sections and boards only healthy, straight trunks can be used and therefore offcuts and side boards of lower quality abound. Nowadays, these sections are used, cut down into smaller strips, battens and laminations. Chips and sawdust represent the end of this processing chain.

The process of breaking down into ever smaller parts is accompanied by a contrary process – assembly. The smaller the constituents in the assembled products, the more homogeneous are their physical properties and the easier it is to influence these properties through the type of assembly and the choice of chemical or mechanical binders. When using chips or sawdust, synthetic materials such as adhesive or cement are used, depending on the intended application. Semi-finished products made from strips or laminations are usually glued together, which increases their structural usefulness and opens up new options for construction.

The search for suitable connecting options and their ratio to the proportion of wood paves the way for semi-finished products in which the boundary between wood-based products and other materials, e.g. plastics, becomes vague as we try to achieve optimum properties. This is true of the current trials surrounding new connections, e.g. wood welding, where thermoplastic connecting materials are vibrated by ultrasonic energy and thus flow into the porous structure of the wood. Wood welding results in a stable connection that can be loaded immediately.

These developments in materials form the basis for new types of timber construction. The considerably more consistent physical properties (compared with natural wood), which are reaching hitherto unknown proportions, depending on the particular range of products, render new applications in timber engineering possible. It is therefore only a matter of time before the first timber building systems with completely new structural and building performance properties appear on the market.

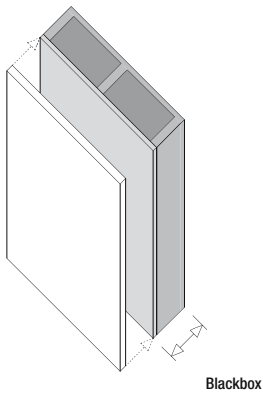
#### Custom prefabrication

The shift from production on site to production in the factory, where thanks to controlled conditions and workflows it is possible to achieve greater accuracy, enables timber building contractors to keep control of the majority of the production process. Almost all current timber building systems are flexible enough to be able to react to individual designs. Trying to keep the design within a module suitable for timber engineering is now a thing of the past. Only the maximum spans possible still influence the plan layout. The traditional design process for a timber building constructed by carpenters has therefore been reversed:



Fig. 37: Wood welding  
The application of ultrasonic energy causes the plastic to form a connection with the wood at the macroporous level.





**Fig. 38: The ribbed solid timber panel as an example of a black box system**  
Finished sandwich elements are delivered to site with their internal structure no longer visible.

the structure can be designed with a relatively high degree of freedom in order to be broken down into suitable individual parts or elements in the next stage of the design (custom prefabrication). At best, only transport restrictions impose limits here.

#### **Black box systems or sandwich systems**

Today, it is possible to request quotations from suppliers of different systems based on tender drawings at a scale of 1:200. The days in which the architect drew the entire loadbearing timber construction in great detail are now over. This work is carried out by the system supplier awarded the contract, who is also responsible for detailed design of the system and compliance with the building performance criteria. The details specific to the project are solved in cooperation with the architect, possibly with repercussions for the loadbearing system. The closed black box elements – fulfilling all requirements – are delivered to the building site and erected, an inner lining and/or external cladding being added if required, depending on the system. (The term “black box” is not specific to any form of construction and can be applied to panel construction or platform frame elements.)

#### **Panels indifferent to the direction of span**

One characteristic that determines the design in panel construction is whether the direction of the panels is relevant or irrelevant. Panels in which this aspect is irrelevant are those made from wood-based products whose structure within the plane of the panel is isotropic. As wood naturally has a directional – anisotropic – character, this distinction has only become possible thanks to progress in the manufacture of semi-finished and wood-based products, e.g. cross-banded plies of veneers or strips. Such panels exhibit high strength and rigidity. They achieve plate effects and can be assembled and cut almost like in modelmaking. This can be seen, for example, in the treatment of openings, which can be seemingly cut anywhere and do not even require a lintel, provided there is enough material above the opening.

## Timber construction systems

### Overview

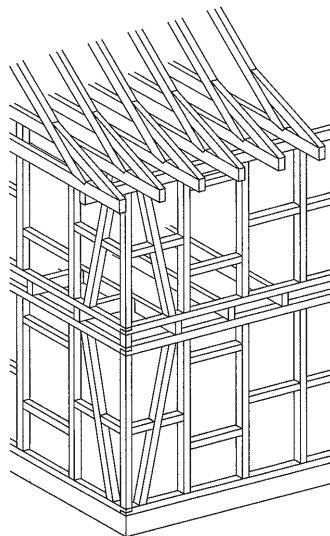


Fig. 39: Timber-frame construction

#### Timber frame construction

This traditional method of building with timber, seldom used today, is based on a relatively small module with diagonal braces in the plane of the walls. We see the first signs of prefabrication in this form of construction. The loadbearing and separating functions are united in the same plane within the wall. Assembly of the individual pieces takes place on site storey by storey. The spacing between the individual vertical members depends on the loadbearing capacity of the timber sections which, prior to industrialisation, were cut to size with simple means (saws, axes). The individual connections are not highly stressed and can be in the form of true wood joints (e.g. tenons, halving joints, oblique dados). Vertical loads are transferred directly via the contact faces between the various timber members.

As the cross-sections of the members are often not derived from a structural analysis, in older timber-frame buildings they tend to be too large and hence uneconomic, or are an inevitable consequence of the usually considerable weakening of the cross-section at the joints. Today, mechanical fasteners are therefore preferred in order to achieve a more economic sizing of the sections.

The infill panels of historical timber-frame buildings are usually of cob, wattle and daub or clay bricks, with masonry and render in later buildings. Today, the infilling is usually insulating materials with a weatherproof cladding.

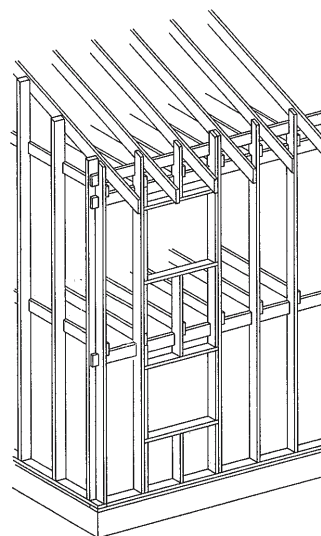


Fig. 40: Balloon frame construction, timber stud construction

#### Balloon frame construction, timber stud construction

The balloon frame system widespread in America consists of closely spaced squared sections of standard sizes based on a "2 x 8 inch" module (roughly 5 x 20 cm). When, as a result of a structural analysis, larger cross-sections are called for, these are made by simply nailing several smaller squared sections together. This timber stud construction is nailed together on site and usually extends over two or more storeys. Stability is assured by solid timber boarding or wood-based panels attached diagonally.

The simplicity of the system, in which additional members are often simply nailed to the main framework as required, enables rapid erection with unskilled labour, despite minimum prefabrication. The system is also characterised by a great degree of design freedom regarding plan layout, volume and positioning of openings. Indeed, openings can even be "cut out" subsequently because the construction is oversized. However, this oversizing is a disadvantage compared to newer systems because it leads to high material consumption.

In Europe *timber stud construction* is the equivalent of the American balloon frame. Timber stud construction also uses closely spaced squared sections of standard sizes extending over two or more storeys. However, there is less standardisation and the connections are not limited to nailing as in the balloon frame – tenons and halving joints are also used. Another aim is a more economic use of material.

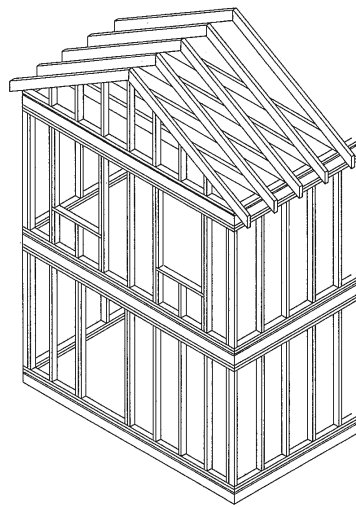


Fig. 41: Platform frame construction

#### Platform frame construction

Platform frame construction is a further development of timber stud construction. It is distinguished by a high degree of prefabrication and is therefore very popular these days. The loadbearing elements consist of storey-high pre-assembled frames of squared sections braced by flat cladding panels or diagonal boards. Platform frame construction is based on a small module, although the spacing can be varied as required, e.g. depending on the thermal insulation used (mats or loose fill). The individual loadbearing ribs are assembled in the works and transported to the building site as self-contained elements. On site they are merely erected and clad if necessary. The tectonic structure of platform frame construction is based on the principle of stacking storeys one upon the other.

The advantage of this form of construction is its versatility because it can respond to many different design specifications. Platform frame construction is straightforward and economic because it uses identical timber sections wherever possible, which thanks to their small size are easy and cheap to produce. The simple nailed and screwed connections are another advantage of this system.

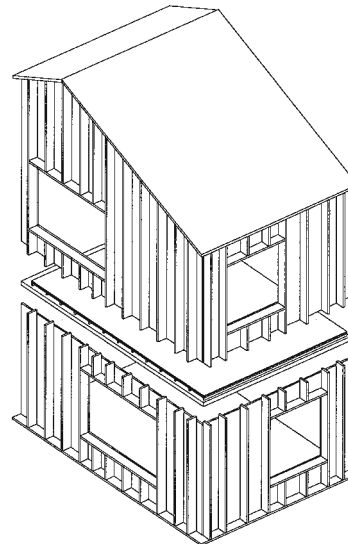


Fig. 42: Panel construction

#### Panel construction

The latest development in panel construction is leading to a reversal of the principle of platform frame construction. The loadbearing element is now a slab, no longer a linear member. This slab must exhibit high strength and rigidity in order to achieve a structural plate action. One answer to such requirements is the solid timber panel, which consists of cross-banded plies of sawn timber strips. The addition of transverse ribs made from the same material increases the buckling resistance of such panels. Insulation is placed between the ribs. The planar, non-directional nature of this loadbearing slab results in structural and architectural characteristics hitherto unknown in timber construction. The traditional grid or spacing of loadbearing elements is no longer necessary. Openings can be cut almost at random.

The construction principle results in a rationalisation of the layered assembly. Single components can play a multifunctional role, which reduces the number of layers and hence the additive character of the layered assembly. The loadbearing solid timber panel, for example, needs no further surface finish internally, apart from a coat of paint. If the building is to be clad with a uniform outer leaf, this can be attached directly to the sheathing of the wall element.

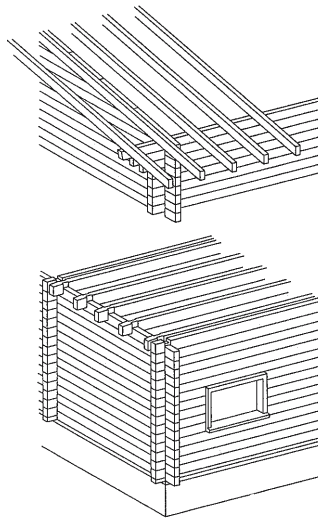


Fig. 43: Log construction

### Log construction

Traditional log construction is the only form of timber construction that also falls under the heading of “solid construction”. The building envelope consists of a single leaf of timber members – stacked horizontally and joined by means of cogged joints – that performs the cladding, space-enclosing and loadbearing functions simultaneously. Stability is achieved through the friction resistance in the bed joints, which leads to the solid timber wall acting as a plate, and through the cogged joints between the timber members at the corners. No mechanical fasteners are required. The possible spans depend on the timber members available, which do not usually exceed 4.5 m.

Log construction leads to substantial shrinkage and settlement movements because the timber members are loaded perpendicular to the grain. Settlement movements must be taken into account in the details, e.g. at window openings. The insulating value of a log building no longer meets modern requirements; contemporary log buildings must therefore be provided with extra insulation. This method of construction is only economic in places where the corresponding infrastructure (sawmill) and expertise (carpentry skills) are available.

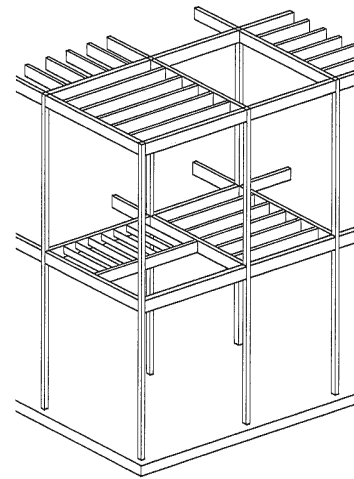


Fig. 44: Frame construction

### Frame construction

This is the most delicate form of construction in timber. Vertical columns and horizontal joist floors (“tie beams”) or “plates” form the loadbearing structure (similar to the column-and-slab principle of solid construction). The consistency of the materials used for the vertical and horizontal linear members (sawn timber or glued laminated timber) and the form of the joints determine the spans that can be achieved and the architectural appearance of the loadbearing construction. Besides solid timber, glued laminated timber and other glued structural elements are available these days. The joints usually employ mechanical fasteners such as gusset plates and dowels, the principle of which is similar to structural steelwork. True wood joints are hardly ever used in frame construction.

Stability is achieved through the inclusion of diagonal ties and struts, or wall plates, or solid cores that extend through all storeys.

Frame construction is distinguished from other forms of timber construction by the fact that the loadbearing structure functions completely independently of the enclosing elements such as partitions or facades (glazing is conceivable). This specialisation of the elements is not very economic in terms of material consumption, but does lead to good flexibility in the internal layout and design of the facade, and enables longer spans.



## Platform frame construction

### Construction principle



Fig. 45: Platform frame elements prior to erection  
Beার্থ & Deplazes: private house (Willimann), Sevgelin (CH), 1998

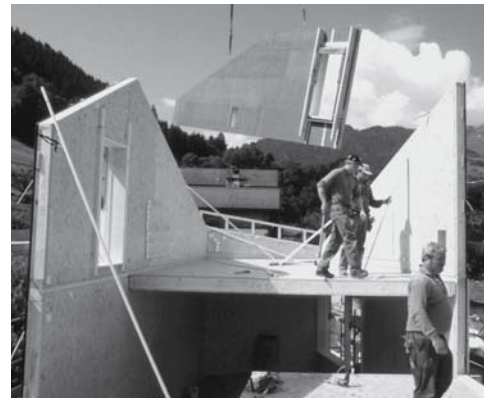


Fig. 47: Erection of platform frame elements with sheathing both sides  
Beার্থ & Deplazes: private house (Willimann), Sevgelin (CH), 1998

Platform frame construction is currently very popular in Switzerland. This is the outcome of marketing campaigns and engineering developments carried out by the timber building industry during the 1980s. The goal was to transform timber stud construction – which had been used widely since 1930 and itself had been inspired by the balloon frame system used in the USA and Canada – into a new building system. This new system had to exhibit a high degree of prefabrication and standardisation of the parts.

Consequently, platform frame construction is a further development of the tradition of improving timber buildings raised using traditional carpentry skills. The primary loadbearing system continues to rely on an arrangement of linear members which has been optimised and developed so that most of the work can be carried out in the factory. The degree of prefabrication has been gradually increased since the introduction of this system and has virtually reached the limits imposed by the system itself.

Thanks to its great flexibility and high degree of prefabrication, platform frame construction has been widely accepted by the building industry. However, it is itself now facing competition brought about by newly developed wood-based products which are tending to render the system of linear loadbearing members obsolete in favour of planar loadbearing elements (see “Panel construction – Current developments”).

The system is based on a close grid of loadbearing linear members whose spacing can be varied depending on the given geometry, the format of the insulating material between the members, and the loads expected. Timber members with the same cross-section are used for the vertical studs as well as the horizontal head binders and bottom plates; their arrangement enables them to fulfil almost all structural requirements. The inner layer of sheathing stiffens the whole frame and leads to the whole providing a plate effect. All connections are generally nailed, but if necessary (tension-resistant) screws can also be used.

The use of standardised building materials is one of the prime advantages of platform frame construction. The majority of buildings employ timber members with cross-sections between 60 x 120 mm and 60 x 200 mm. These relatively small sizes result in little waste when being cut to size and are easy to store; they are ideal for kiln-drying and machine-grading.

It is advisable to fix sheathing to the prepared frames (so-called black box). To do this, battens, if necessary also counter battens, are fixed inside and outside and the sheathing attached to this, creating a “sandwich”. The ensuing air cavities provide ventilation on the outside and space for services inside. The choice of material and surface finish is wide and only loosely dependent on the system.

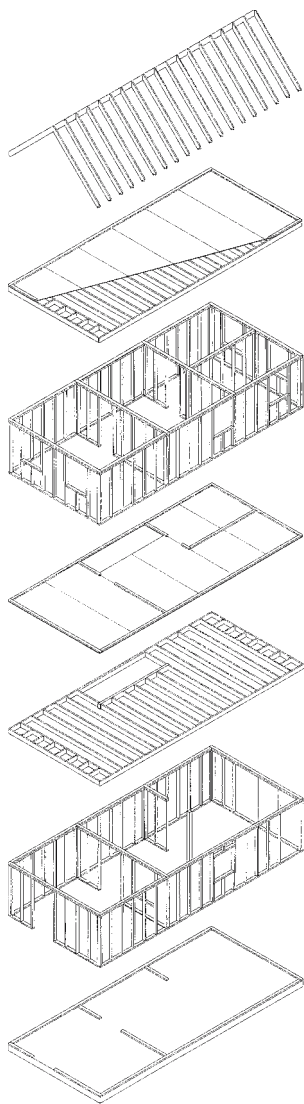


Fig. 46: In platform frame construction the elements are stacked storey by storey.



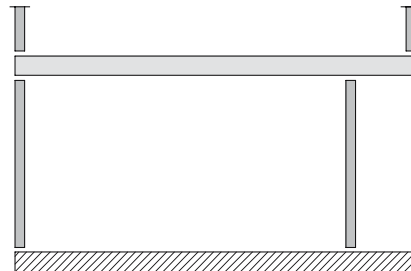
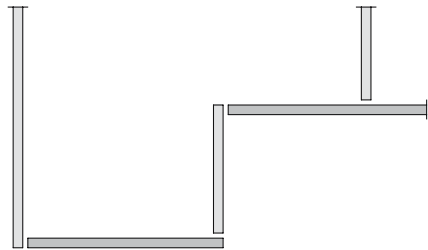
**Fig. 50: Custom prefabrication:**  
The design and construction sequence in timber platform frame construction

Schemes 1–4, plans

Schemes 1–4, sections

**Dividing a specific project into sensible “building units” made up of wall and floor elements**

Cooperation between architect, manufacturer and, possibly, engineer

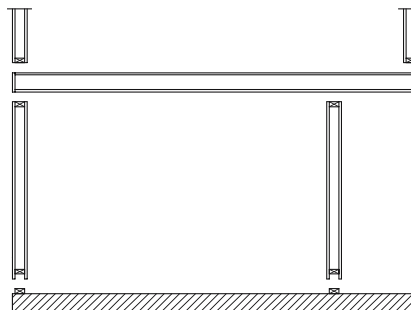
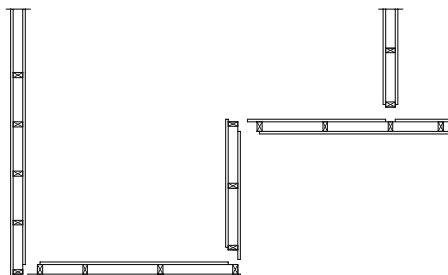


**Production of elements as self-contained “black box” assemblies in the factory**

Arrangement of linear members based on structural requirements and insulating material format (50 x 100 mm or 60 x 120 mm)

Sizing of linear members depends on thickness of integral thermal insulation (120–200 mm)

Joint design (butt joints with seals or overlapping as shown here)

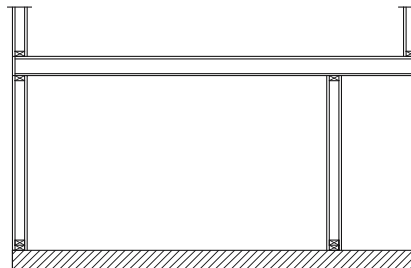
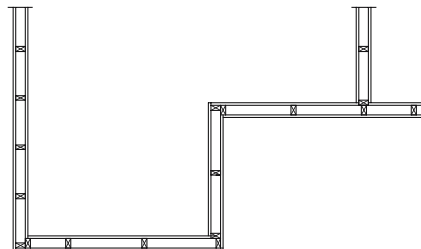


**Delivery of elements to building site and erection**

Plan: vertical butt joints nailed (for compression only) or screwed (also for tension)

Section: stacking the elements

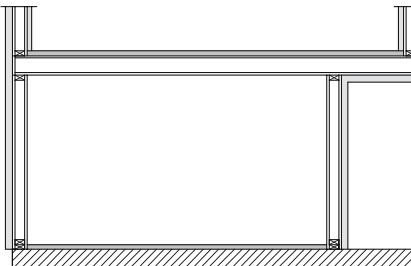
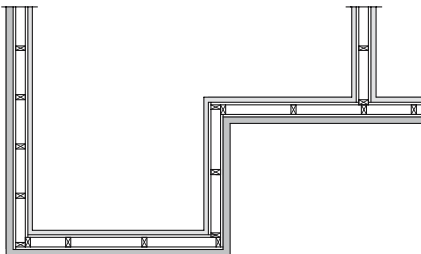
In order to guarantee the continuity of the vapour barrier, vertical and horizontal butt joints must be sealed accordingly.



**Attaching the external cladding (and internal lining)**

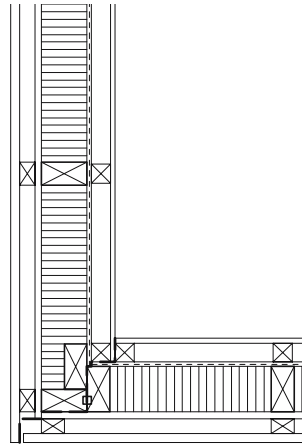
The external cladding must guarantee a circulation of air for the underlying timber construction.

The internal lining may be chosen to suit interior design requirements and can also conceal electric cables. There are no services (electrics, water, gas, waste water, etc.) in the platform frame elements themselves because otherwise they would have to penetrate the vapour barrier.

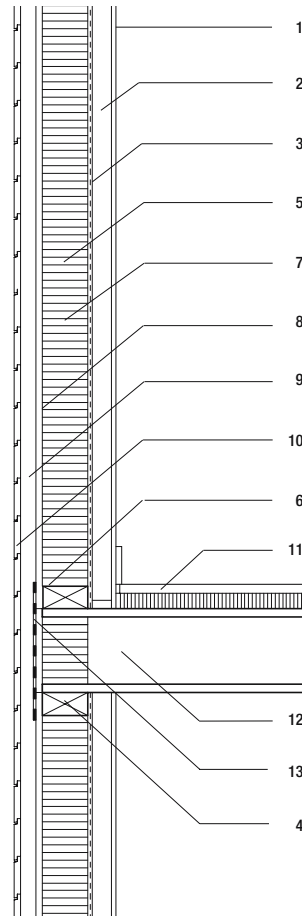


**Fig. 51: Timber platform frame element, layers and sheathing**

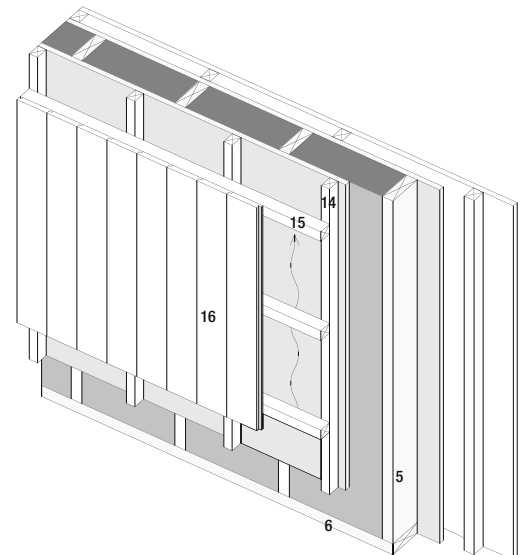
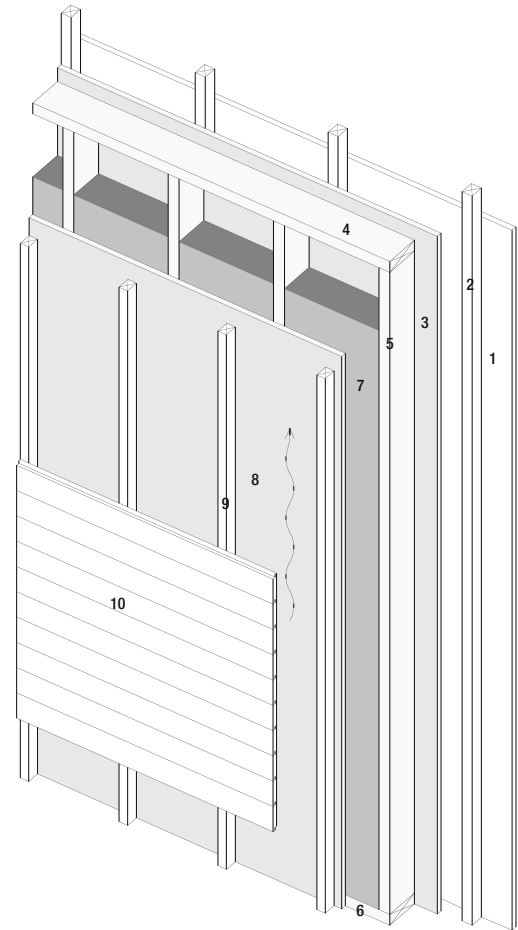
- 1 Internal lining, 12 mm
- 2 Vertical battens (services), 50 mm
- 3 Wood-based panel (vapour-tight), 12 mm
- 4 Frame: head binder, 60 x 120 mm to 60 x 200 mm
- 5 Frame: stud, 60 x 120 mm to 60 x 200 mm
- 6 Frame: bottom plate, 60 x 120 mm to 60 x 200 mm
- 7 Insulation, e.g. ISOFLOC, 120-200 mm
- 8 Bitumen-impregnated wood fibre insulating board, 18 mm (airtight)
- 9 Vertical battens, ventilation cavity, 40 mm
- 10 Horizontal sheathing, 24 mm
- 11 3-ply board with tongue and groove, impact sound insulation
- 12 LIGNATUR box element
- 13 Airtight membrane over butt joint
- 14 Counter battens, 40 mm (needed to guarantee vertical continuation of ventilation cavity)
- 15 Horizontal battens, 40 mm
- 16 Vertical sheathing, 24 mm



**Horizontal section through corner joint**  
Horizontal sheathing



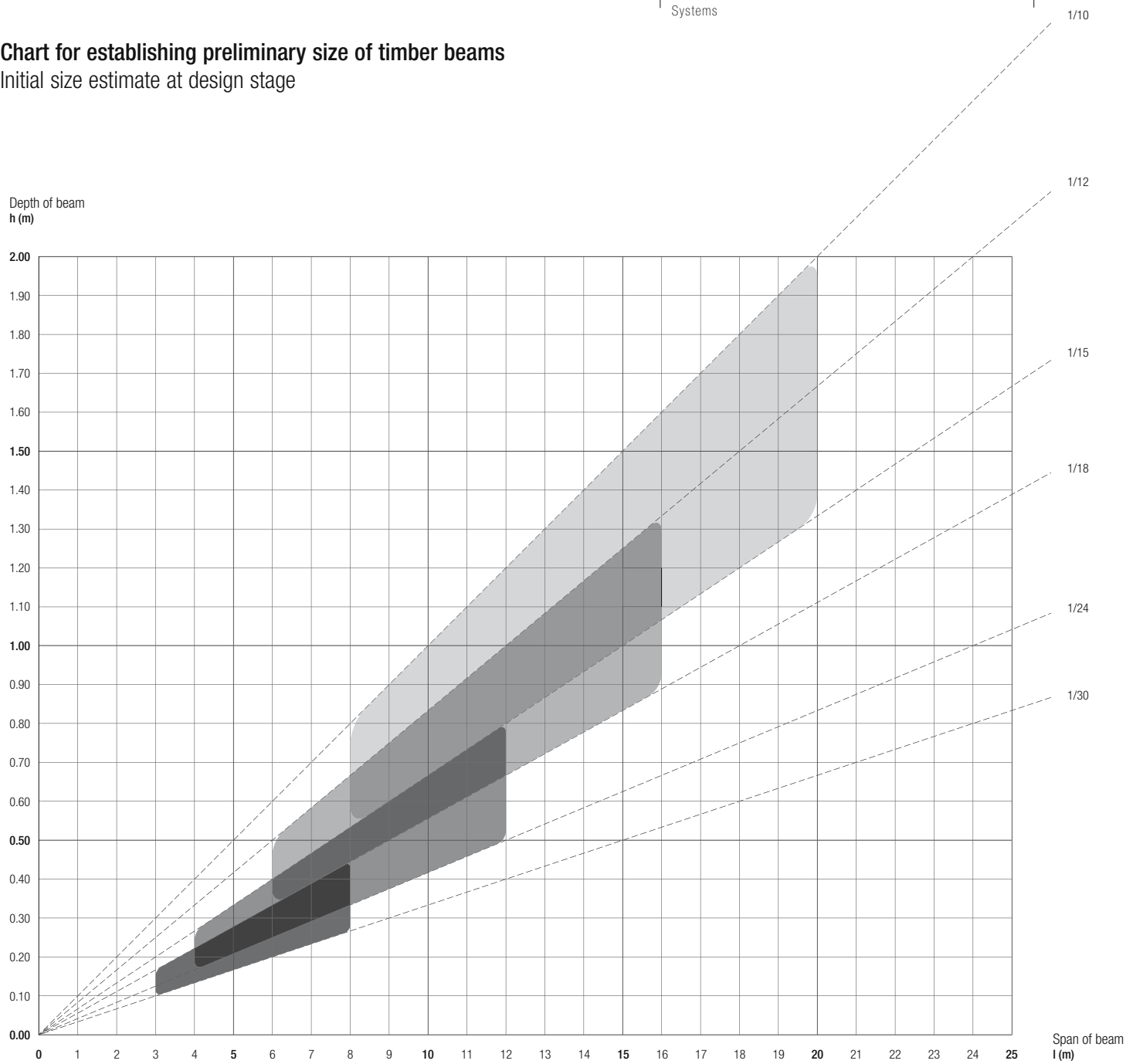
**Section through wall-floor junction**  
Horizontal sheathing



**Axonometric view of layers**  
Horizontal sheathing (top) and vertical sheathing (bottom)



**Chart for establishing preliminary size of timber beams**  
Initial size estimate at design stage



Element (loadbearing)	Span l (m)	h*/l
Rafter	– 8 m	1/18 – 1/30
Purlin, beam	4 – 12 m	1/15 – 1/24
Solid-web beam	6 – 16 m	1/12 – 1/18
Lattice beam	8 – 20 m	1/10 – 1/15

**Fig. 52: Notes for using this chart**  
With a high load (dead and imposed loads) use the maximum value for the member depth as proposed by the chart – vice versa for a low load.  
The sizes and relationships shown cannot be verified scientifically. The shaded areas are supposed to be slightly "indefinite". In the interest of the rational use of a loadbearing element, the "edges" of this chart should be avoided.

Source: M. Dietrich, Burgdorf School of Engineering, 1990

\*A beam cross-section (h/b = 2/1) can be used for the initial, rough sizing; Glulam beams are often more slender.

## Conversion of a trunk in traditional Japanese timber building culture

### The workshops at the Grand Shrine of Ise

Christoph Henrichsen

Thanks to the ritual of completely rebuilding the shrine every 20 years, a centuries-old tradition of conversion has been handed down to the present day in the workshops of the Grand Shrine of Ise. This bears witness to a profound knowledge of wood, and the procedures for cutting the wood illustrate the rules that must be observed when obtaining high-quality sawn timber sections from mature tree trunks in order to do justice to the individual characteristics of every trunk. Ise is certainly the only place in Japan where everything is in the hands of one master carpenter: forest husbandry, felling, conversion and final building work.



Fig. 53: Secondary shrine of Ise  
Contrast between old and new structures

#### Felling and storing the trunks

The trees intended for the shrine – these days hiba trees (from Northern Japan) which have virtually replaced cypresses for economic reasons – are felled in the winter, between October and February. Upon arrival in the store an inventory number is stamped into the crown end. Prior to conversion, the trunks are stored for up to three years in ponds. This avoids cracks due to drying, but also, allegedly, removes certain substance from the wood, and this leads to quicker drying after conversion. The trunks are lifted out of the water with a winch and taken to the sawmill on small rail-mounted trolleys. If required, they are cut to length first. The master carpenter then turns them to inspect them for damage and flaws. He works the crown end of each trunk with electric and hand planes because it is easier to perform the marking-out work on a smooth surface. The marking-out of the trunks (Japanese: *kidori*, to divide up the wood) always begins with a line through the heart (*shinzumi*) at the crown end (*sue-koguchi*). To do this, the master carpenter uses a plumb bob and a carpenter's try-square. The central mark is subsequently transferred to the stump end (*moto-koguchi*), whose diameter is normally some 10 cm larger, with a line (*mizuito*). If required, a mark can therefore be drawn slightly off-centre in order to avoid, for example, damage in the trunk. Prior to marking out the sections, as a precaution the master carpenter attaches further lines. In



Fig. 54: The master carpenter at work  
Marking the end of a trunk with a plumb line

this way he can be sure that even in the case of minimal crookedness the necessary sections can be cut from the trunk. The timber sections are marked out at the crown end. But here the master carpenter also includes all the information required to ensure that the sections end up at the right place in the building: building name, component name, component number, trunk number.

#### Marking-out

For marking-out the master carpenter uses a stick split from a piece of bamboo (*sumi-sashi*) one end of which is fanned out over a length of about 2 cm to form numerous narrow teeth, which he dips into the piece of cotton wool



Fig. 55: Three tree trunks marked ready for cutting in the sawmill  
Visible here are the marked-out sections plus additional information such as building name, component name, component number, and trunk number.

soaked in ink belonging to his snap line. The marking-out usually starts with the largest sections and the secondary parts are cut from the remainder of the trunk. The trunks are always marked out by the master carpenter of the workshop. He knows all the buildings and knows best which requirements will be placed on every single part. Besides the best possible use of the trunk, he must also ensure that every component is cut from that part of the trunk most suitable for that component. For example, slightly crooked trunks are preferred for beams, which are



Fig. 56: Boards stacked for weathering

then positioned so that the rounded side is on the top; trunks with a high resin content are turned into beams and purlins. The list of timber parts specifies quality grades for the components. The highest quality (*shihoake*), which is required for producing containers for storing holy objects and is used for only a few building components, must be absolutely free from flaws on all four sides. This quality grade is followed by parts which must be free from knots on two sides (*nihokoake*). Sound knots up to a diameter of about 2 cm are permitted in the quality grade for secondary and concealed parts (*jokobushi*). The list of timber parts also includes details of whether the converted section is to be cut to length afterwards or whether the parts are to be assembled to form a larger cross-section.

### Conversion and storage

The trunks are cut on a large log bandsaw section by section and have to be turned many times during the process. The daily quota lies between five and fifteen trunks. After-

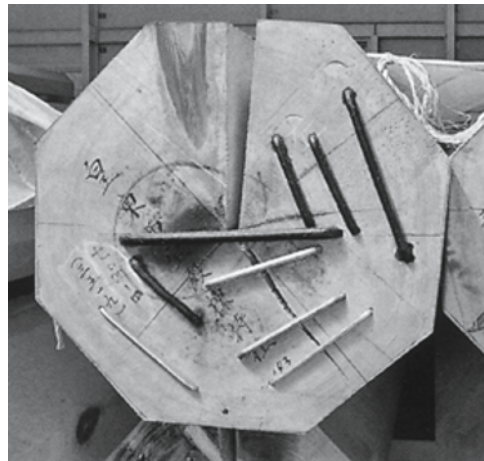


Fig. 57: End face of octagonal column

The end grain has been coated with a wax emulsion. Numerous cramps prevent uncontrolled cracking during drying. The sawcut down to the heart can be readily seen.

wards, they are loaded onto small rail-mounted trolleys which take them to one of the many storage sheds. Here, the end grain is painted with a wax emulsion. Cramps are also driven into the end grain to prevent cracks at the crown ends. The parts are sorted according to building and stacked for drying.

### Dealing with sections containing heart

Sections containing heart (*shinmochi*), which are required for posts, beams and purlins, for example, are given a sawcut down to the heart after conversion (*sowari*). Wedges are driven in immediately afterwards and these are re-driven every few weeks. If the sections concerned will remain exposed in the finished building or if they are in the immediate vicinity of the effigies, wedge-shaped strips are cut, glue applied to one side (*sewari wo umeru*), and the strips fitted into the sections and finished flush. This

elaborate treatment prevents the majority of uncontrolled drying cracks.



Fig. 58: Beams with heart cuts and wedges driven in

This text is an edited abridged version of an article entitled "The workshops at the Grand Shrine of Ise" by Christoph Henrichsen that appeared in *DETAIL* (10/2002).



## The threads of the net

*Urs Meister*



Fig. 59: View from access road  
Shin Takasuga: "Railway Sleeper House", house formerly belonging to the Seitogakushi School, Miyakejima (J), 1980

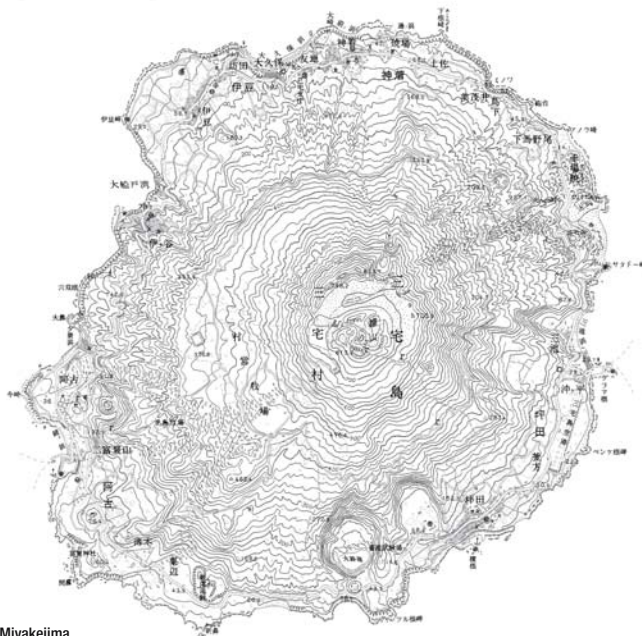


Fig. 60: Miyakejima  
Map of topography

In the 1970s Japanese architects were searching for independence. One example of this search between centuries-old tradition and rigid, unbridled Modernism is Shin Takasuga's "Railway Sleeper House", which has a contemporary look but in many respects is linked with Japanese cultural heritage.

The house is situated amidst a forest on the small island of Miyake in the Pacific Ocean. It was planned in the 1970s by students of the New Left and members of the Peace Movement as a communal residential building and place of retreat. Financial constraints meant that the inhabitants had to build the house themselves. Shin Takasuga's decision to use old, wooden railway sleepers resulted in a five-year construction time. But it was not the use of sleepers that was novel, rather the universal utilisation of one single type of construction element for the whole structure – walls, floors, columns, roof structure, the built-in furniture too.

The three-storey building is situated on a slope, raised clear of the ground on a concrete substructure. A skilful arrangement of the rooms characterises the compact lay-



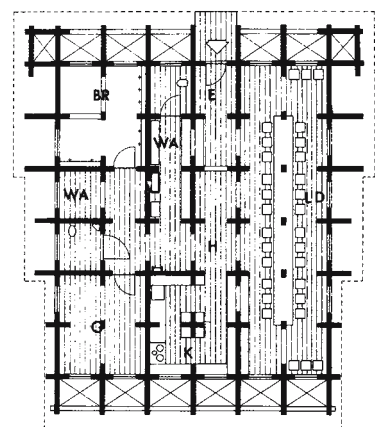
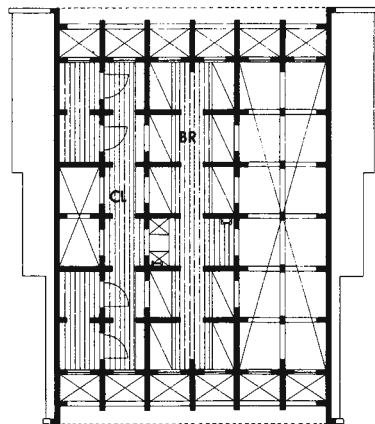
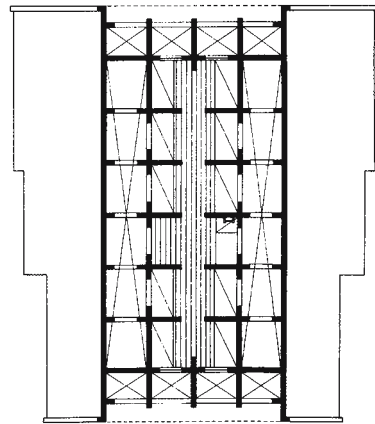


Fig. 61: Plans of roof void, upper floor and entrance floor  
Shin Takasuga: "Railway Sleeper House", Miyakejima (J), 1980

out. The public rooms can be found on the entrance floor: kitchen, bathrooms, an assembly room and a large dining hall, which extends the full internal height and therefore takes on the character of a main room. Bedrooms, ancillary rooms and the open, triangular roof void are in the upper storeys and can be reached only by ladders. The architect's decision to exclude conventional access elements, e.g. stairs, increases the degree of abstraction in the internal configuration and gives the impression of true room "stacking".

In trying to find the roots of traditional Japanese housebuilding and its specific method of construction you will come across a simple dwelling, the *tateana*. Four timber stakes are driven into the soil to carry four beams. Together with a number of poles arranged in a circle and a covering made from leaves, grass or straw this produces a tent-like shelter. Two basic architectural themes are already evident in this archetypal form, both of which characterised housebuilding and temple architecture from that time onwards. Indeed, they proved legitimate up to the last century and exercised a decisive influence on Takasuga's work: the house as roof and as structure.

#### The roof as a protective barrier

While Western architecture evolved on the basis of the wall and the facade<sup>1</sup>, in traditional Japan the roof assumed this important role. The house is first and foremost a roof, which is constructed immediately after the erection of the supporting structure, even before any interior walls are built. Oversailing eaves and canopies protect against

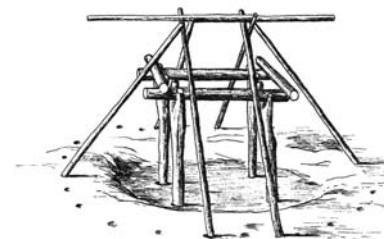


Fig. 62: *Tateana*, the Japanese "prehistoric shelter"  
Finished shelter (top), internal frame (bottom)



Fig. 63: Roof covering of wooden shingles  
Shin Takasuga: "Railway Sleeper House", Miyakejima (J), 1980

extreme weathers, and relegate the actual facade to the background. The significance of the roof as a protective barrier and the "compact darkness spreading beneath it" inspired the author Tanizaki Jun'ichiro to write about the aesthetics of shadow<sup>2</sup>, and until the last century women in the traditional Japanese house did indeed still blacken their teeth in order to control the light–shade contrast! The roof as an autonomous sculpture-like configuration was described impressively by Bruno Taut in his summary of his visit to Japan<sup>3</sup> – in addition to his deductions based on technical and constructional conditions – as a basic cultural phenomenon of Japan.

Moving closer to Shin Takasuga's building, which today is overgrown, the first thing you notice is the bright, reflective roof. It appears as an abstract surface and its gable line gives the impression of having been drawn with a thick pencil right through the vegetation. What is underneath cannot be readily seen and only by approaching nearer does the house reveal itself to be a solid, heavily subdivided timber structure. The roof covering of wood shingles imparts a great lightness, only the line of the ridge and the verges are highlighted with sleepers – as if the thin roof surface has to be protected against the wind. The delicate covering seems to be reduced to a minimum in order to balance the heaviness of the structure below, the sleeper construction.

**Mass and elasticity**

However, traditional Japanese houses often show a contradictory picture: the (usually) thick thatch coverings to their roofs contrast in a peculiar way with the delicate construction underneath them. The weight, raised clear of the ground on a fragile-looking arrangement of linear members, paradoxically guarantees the whole structure maximum elasticity – like a heavy table top resting on thin

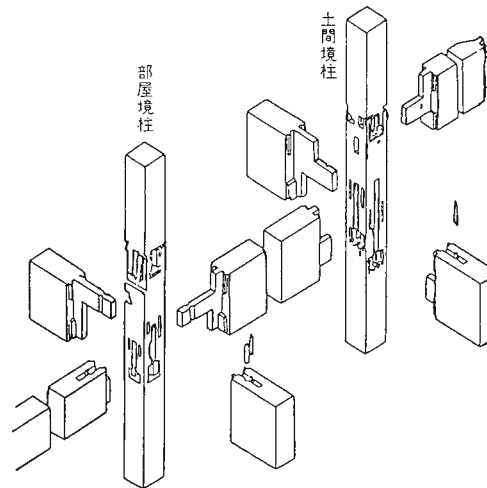


Fig. 64: Traditional Japanese house design  
Column–beam wood joint

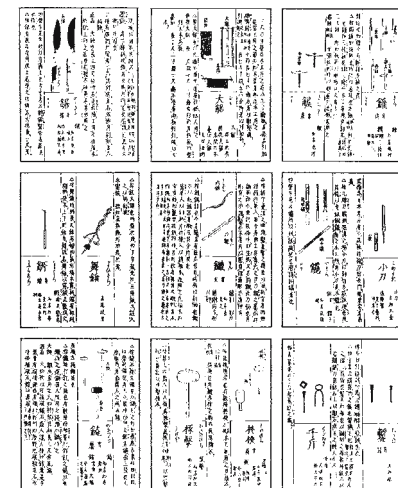


Fig. 65: Traditional Japanese carpentry tools  
Pages from an encyclopaedia dating from 1712

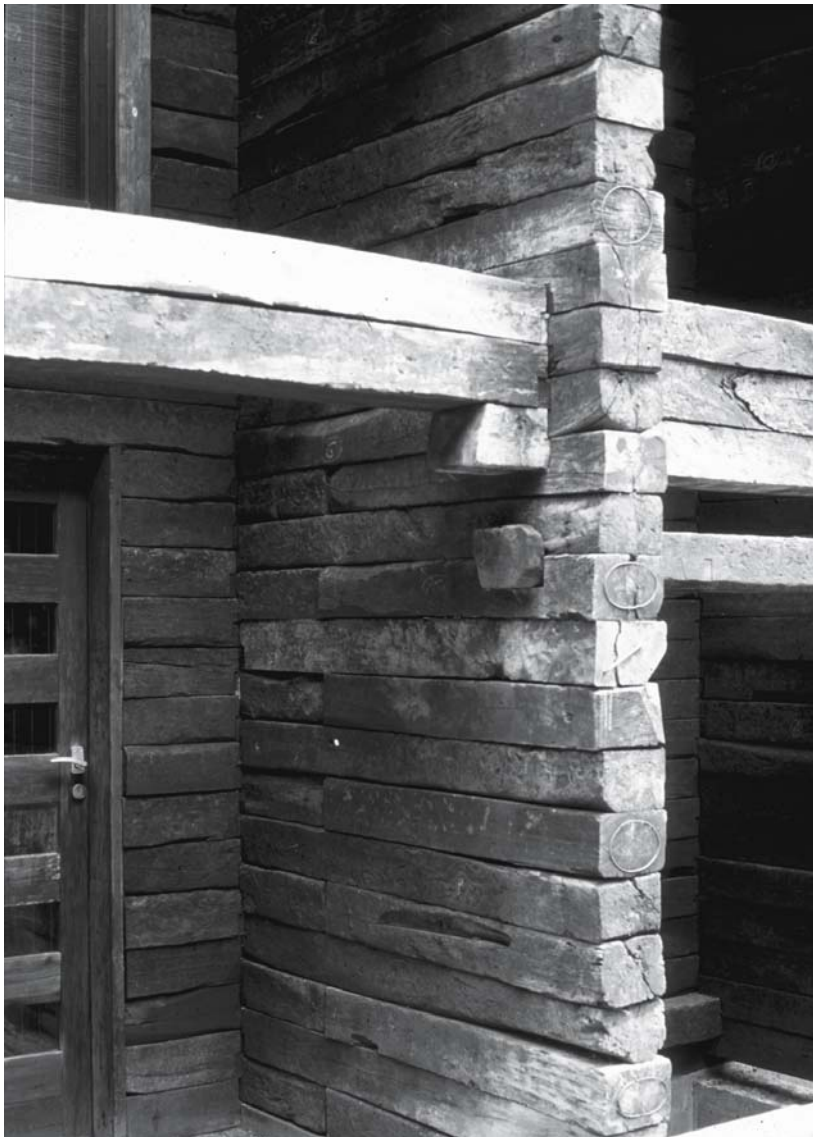


Fig. 66: Detail of jointing at projecting stack of sleepers on the entrance facade  
Shin Takasuga: "Railway Sleeper House", Miyakejima (J), 1980



Fig. 67: Treasure house of the Todai-ji in Nara  
View of corner

table legs. Due to the permanent danger of earthquakes in Japan elasticity is vital. The Western tradition of diagonal bracing is known to Japanese carpenters but does not correspond to their classical, aesthetic principles, and it would make the system more rigid and thus susceptible to seismic forces. In Japanese construction the stability of the connections, which is achieved through utmost jointing precision, guarantees the stability of the building as a whole, as well as the necessary freedom of movement for the structure.

Therefore, the sphere of activity of the carpenter in Japan is broader than that of his colleagues in Europe: he has to take on tasks normally performed by architects, along with cabinet-maker's jobs. Japanese carpenters are equipped with an incredible array of special tools and their work is distinguished by extreme intricacy and complexity, recognisable in the exploded views of timber joints. The carpenter's goal – to make the joint appear like a really simple connection – has resulted in a highly artistic technique of timber members intermeshing at a single point, often with a seemingly absurd sublimation of the cross-section. Despite maximum perforation of the members at the highly loaded joints, the connection itself gains stability due to the accurate fit and precise interlocking, and its characteristic elegance through elimination of all visible details.

In comparison with this, Japanese log construction – normally used only for storage buildings and treasure houses – contradicts the picture of the resulting timber constructions with their linear members. An impressive example of this is the treasure house of the Todai-ji in Nara, which stands out due to its mass, its self-contained nature and the elementary jointing technique. The unusual triangular shape of the logs, laid edgewise on top of each other, creates a three-dimensionally textured facade on the outside but a perfectly smooth wall surface on the inside. Although the edge-on-edge assembly of the joists does not seem sensible from the engineering point of view

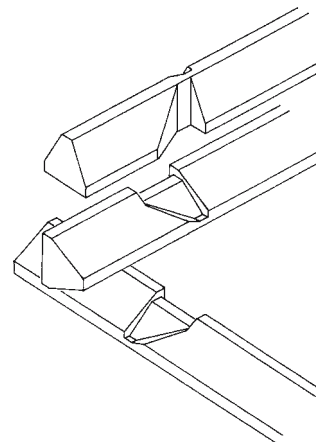


Fig. 68: Treasure house of the Todai-ji in Nara  
Detail of log construction joint



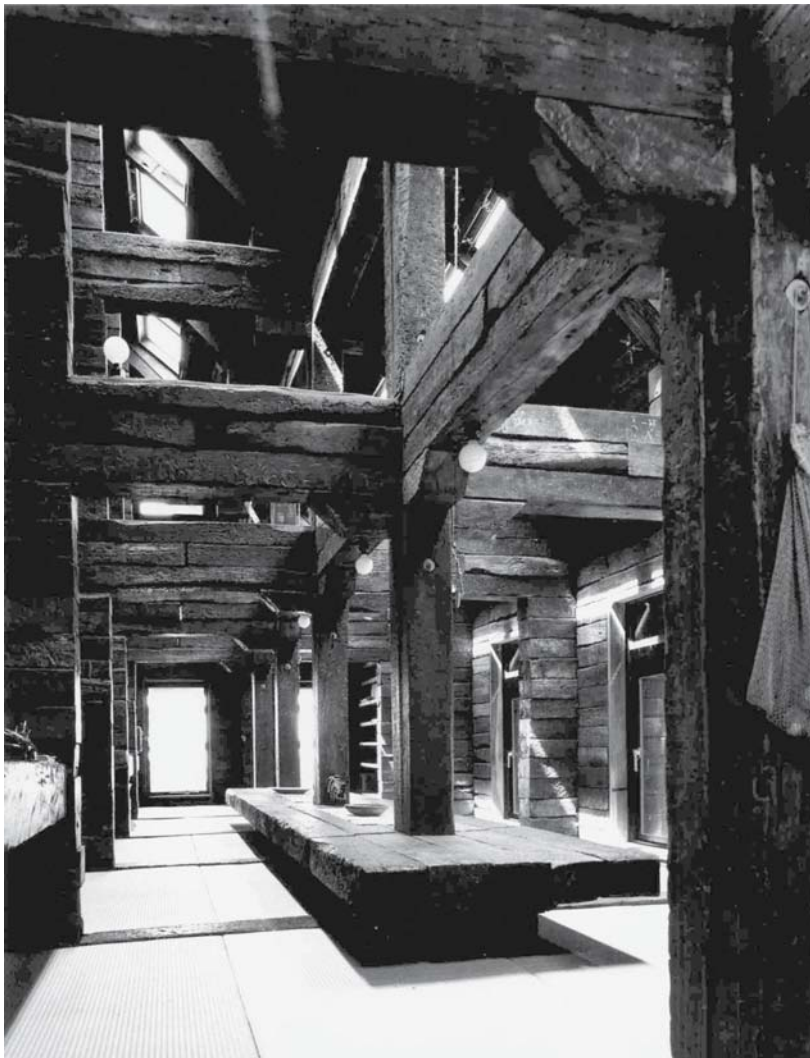


Fig. 69: The dining hall extends the full internal height of the building  
Shin Takasuga: "Railway Sleeper House", Miyakejima (J), 1980



Fig. 71: House in Takayama  
Interior with exposed roof structure

it has a certain purpose: in dry weather the wood shrinks and small gaps appear between the logs, allowing natural ventilation of the interior. In wet weather the wood swells and the gaps close, thus preventing moisture from entering the building.

**The house as a structure**

Log construction is characterised by intersecting corner joints that leave a short section of log projecting in both directions. By multiplying this corner detail Takasuga enhances the original planar character of this construction method, creating unsuspected spaciousness; and by letting the ends of the sleepers protrude at the gable facades he creates an abstract, three-dimensional composition. The stability of the protruding sleeper stacks is guaranteed with the aid of transverse sleepers, thus further balancing the horizontal-vertical arrangement of the entrance facade. In the large dining and communal room the same principle grows to nearly monumental proportions and the fragile equilibrium between the load-carrying and load-generating effects of the huge beams gives rise to an impressive three-dimensional sculpture.

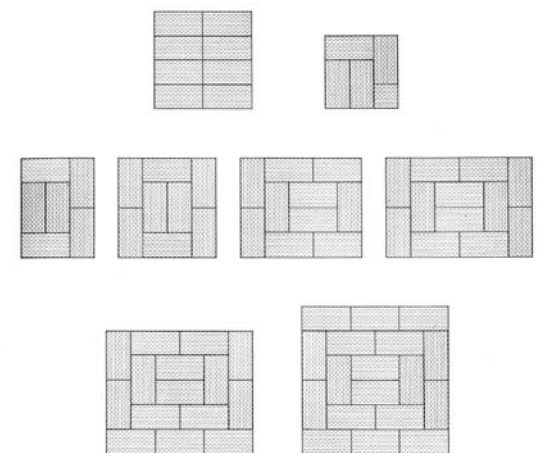


Fig. 70: Traditional *tatami* mat combinations  
Four lines intersecting to form a cross is usually avoided – the combination of eight mats (top left) is reserved for special purposes. The arrangement with four mats (top right) is used in rooms where the tea ceremony is held.





Fig. 72: The concrete substructure beneath the log construction superstructure  
Shin Takasuga: "Railway Sleeper House", Miyakejima (J), 1980

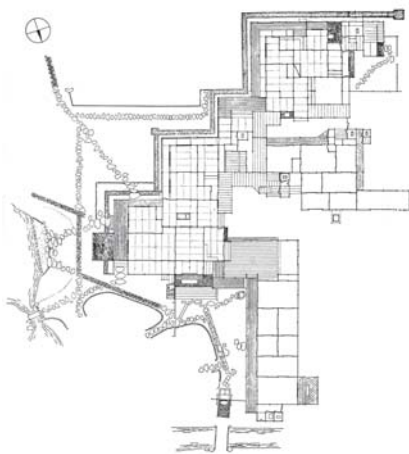


Fig. 73: The additive jointing principle of the rooms  
Katsura Imperial Villa



Fig. 74: Carl Andre  
"Shiloh", 1980, 91 x 563 x 563 cm

The "cage-like" clarity of horizontal and vertical elements, of heavy beams and slender columns placed on them characterises the open roof structure inside the Japanese house and gives the impression of a pick-up-sticks game suspended in mid-air. The aesthetic preference for open, exposed timber structures is just a part of the Japanese tradition as is the specific treatment of the surfaces. The warm, dark tint of the treated sleepers used for Takasuga's house reflects the classical colouration of wood, which in earlier times was generated inside the houses by the open charcoal fires and the facade outside was then tinted by applying soot or by singeing. The surfaces of the sleepers, branded by their previous utilisation in the form of notches, cracks and damaged edges, give the wood a raw and rough appearance but at the same time it seems to be coated with a kind of patina, as if every single sleeper has been evenly worn away and polished.

A rigid system of dimensions based on the *tatami* mat on the floor and the *shoji*, the paper-covered door, determines the Japanese house and controls the complex network of relationships between the different elements. Both plan and section show characteristics of this modular principle, which led to a "structural grammar" and reached its architectural zenith in the 17th century in the construction of the Katsura Imperial Villa in Kyoto. Apart from the dimensions and proportions of the individual rooms, the relationships and transitions between them are strictly controlled and form an additive plan layout with an especially open character, which anticipated the flexible layout of Modernism in the Western world.

So the Japanese house is an open, additive configuration of individual rooms and in the "Railway Sleeper House" we can identify a subtractive design principle: the rooms seem to have been hacked out of a closed, cruciform stack with a rigid outer shape. In this context the paradoxical statement of Takasuga – that this house did not have to be designed but that the use of railway sleepers generated the actual structure itself – sounds like an echo of the Minimal Art concepts of the 1960s. The visual power of the succession of the same basic elements and the fascination of the brutal rawness of the



Fig. 75: View of gable facade on valley side  
Shin Takasuga: "Railway Sleeper House", Miyakejima (J), 1980

timber members, laid on top of each other like in a children's game, reminds us of the disciplined tendencies of minimalist sculptures.

Far away from the sophisticated carpenter's techniques, Takasuga was able to create an ingenious work that by concentrating the means in many respects relies on Japanese traditions. At the fundamental figurative level – the house as a roof – as well as at the complex design level of space formation, the construction and the choice of materials – the house as a structure – in Takasuga's unique project the threads of the net<sup>4</sup> are woven in many different ways with Japanese architectural culture. However, the artistic radicalness of this project allows it to stand out from the conservative traditionalism which began to grow in Japan during the 1970s.

First published in *tec21*, No. 21, 25 May 2001

#### Further reading

- <sup>1</sup> Arthur Drexler: *The Architecture of Japan*, New York, 1955, p. 44.
- <sup>2</sup> Tanizaki Jun'ichiro: *Lob des Schattens*, Zurich 1987 (1933).  
– English translation: Tanizaki Jun'ichiro: *In Praise of Shadows*, 1988.
- <sup>3</sup> Bruno Taut: *Das japanische Haus und sein Leben*, Berlin 1998 (1937).  
– English translation: Bruno Taut: *The Japanese House*, 1998.
- <sup>4</sup> This is the title of a chapter in Taut's book.

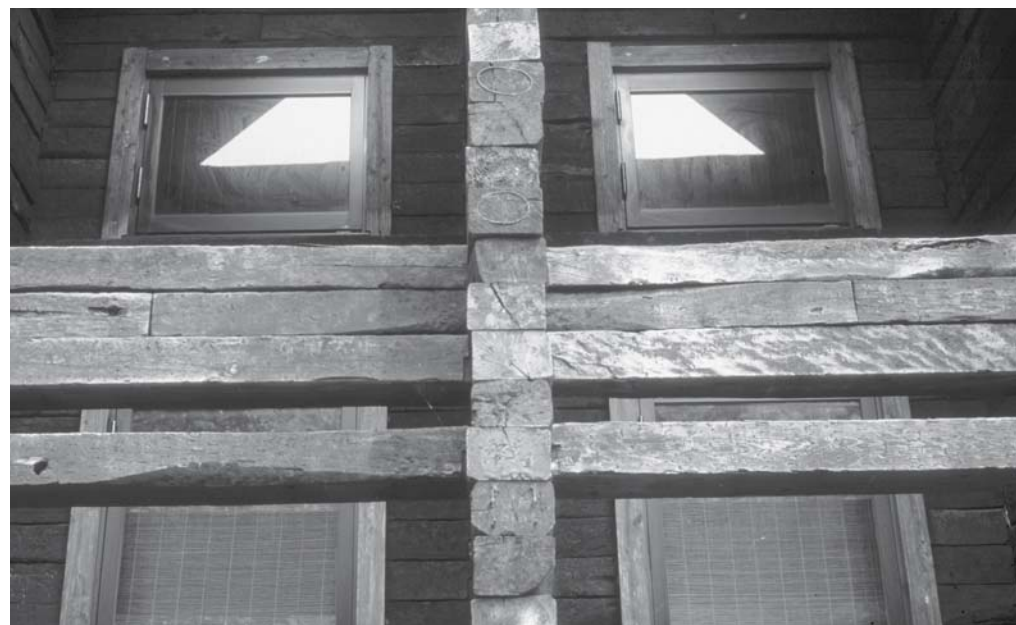


Fig. 76: Sleepers inserted into and cantilevering from the projecting stack provide stability  
Shin Takasuga: "Railway Sleeper House", Miyakejima (J), 1980



## Why steel?

Alois Diethelm

Steel has a problem. Once upon a time the product made from ore pointed the way to forms of architecture that had been inconceivable in the past, and during the 1920s it enjoyed the rank of a material preferred by the avant-garde. But the importance of steel in current architectural accomplishments leaves behind conflicting impressions. On the one hand, modern construction would hardly be conceivable without steel; on the other, the reasons for

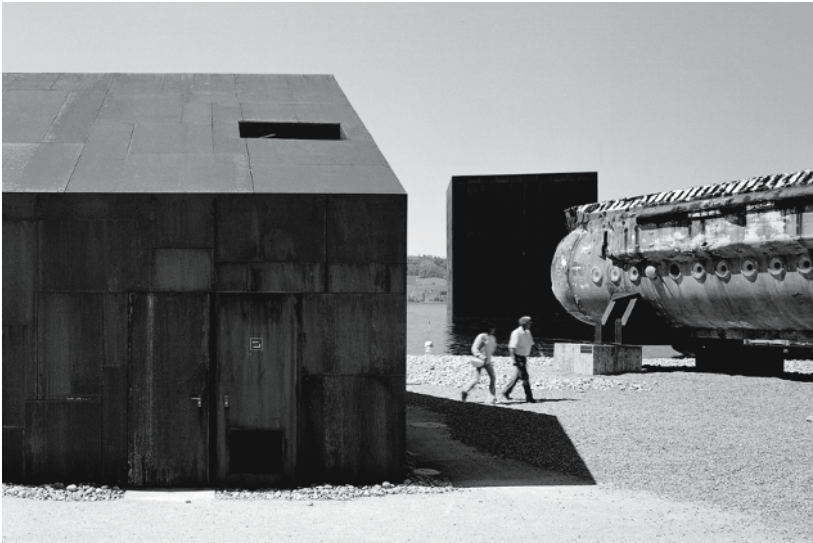


Fig. 1: Probably half of all the pavilions were made of steel.  
Swiss National Exhibition, Expo.02, Murten (CH), 2002

using steel – above all as the basis for a design – are not so obvious. The explanations for this might be that until a few years ago fire regulations specified that fire protection measures in multistorey steel structures could be achieved only by using cladding or thermal performance requirements that made it difficult to penetrate the climate boundary (facade) owing to the good thermal conductivity of metal. In addition, steel lacks attributes such as “natural”, “ecological”, or “homey” – attributes of, for example, timber building, which are so readily accepted by many groups of people. What is not widely known is that 90% of steel used in building work today is recycled from society’s scrap metal (cars, refrigerators, etc.).

Nevertheless, we saw at Expo.02 in Switzerland that presumably, half of all the exhibition pavilions were made of steel: from Jean Nouvel’s Monolith in Murten, to the “Cloud” (or “Blur Building”) by Diller & Scofidio in Yverdon, to the “Towers of Biel” by Coop Himmelb(l)au in Biel. And there is no stopping the flood of photographs of new airports from around the world, with their long-span roofs of steel lattice girders and steel columns reminiscent of trees. But the lion’s share of steel in building is visible only for a short time, while the building is under construction – and I don’t mean just the steel reinforcement in concrete.

### Material transformations

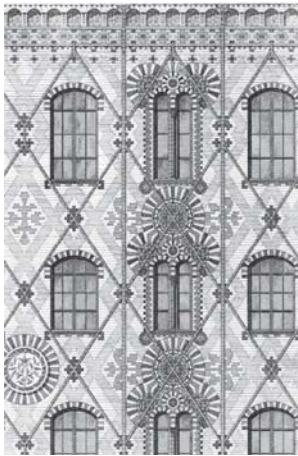
It is interesting that although steel, as a child of the Industrial Revolution, was taken up simultaneously in the building of machines, vehicles, and ships, the interdisciplinary “cultivation” of the new material hardly led to technological transfers among these disciplines. Apart from structural engineering, whose influence cannot be overestimated, the best examples are to be found in so-called machine aesthetics, but less in the context of a certain material usage and rather as a method of design which is based – primarily in the context of new building – on the ideal of an engineering logic reduced to the essentials. As Le Corbusier wrote in his *Towards a New Architecture* (1923): “Engineers create the architecture because they apply the calculations dictated by nature, and their works make us feel nature’s harmony.”

One explanation for the minimal mutual stimulation is the fact that housebuilding is only very rarely based on batch production. Even if the advocates of “Neues Bauen” did predict the industrial production of houses, the aspect of assembly and dismantling was secondary (or it is only now that this has become an important ecological criterion) and buildings are not associated with dynamic stresses.

This exclusivity of a single material, which characterises the production of machines and means of transport (metal replaced wood astonishingly quickly in those situations where form was not reliant on the new material) is alien to the construction industry. Solid and filigree construction, which became established as mankind built its very first shelters in the form of – depending on region and culture – caves and tents, still represent opposite poles marking the limits of the building industry’s playing field today. This traditional duality explains why new



Fig. 2: Steel frame concealed behind brick facade  
Diener & Diener: Vogesen School, Basel (CH), 1994



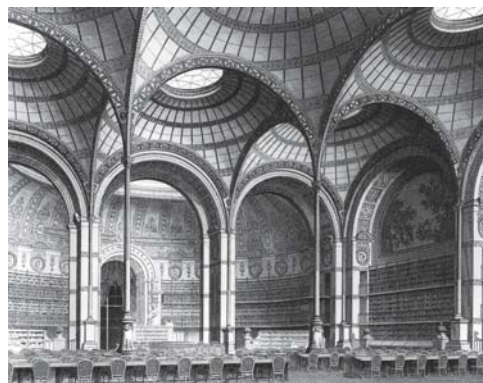
**Fig. 3: The relationship between steel and timber construction**  
Jules Saulnier: Menier chocolate factory, Noisiel-sur-Marne (F), 1872

materials never really unleash a genuine change, but instead lead to material transformations and hybrid forms. And steel was no different. In the same way that reinforced concrete first translated the principles of timber building (columns and beams) into concrete (cf. the Hennebique frame) before the flat slab appeared, Saunier's famous Menier chocolate factory (1871/72) was based on an iron truss whose only difference from a timber truss was the smaller cross-sections. And in Labrouste's Bibliothèque Nationale in Paris (1875) the ribs to the domes remind us of (Gothic) stone vaulting. In the tense span between solid and filigree construction, steel finally introduced a hybrid form in which the partner material was no longer "only" an infill without a structural function, as is the case with the infill panels to timber-frame buildings, but rather, in mutual dependency, becomes an integral component of the loadbearing construction. I am talking here about the combination of steel and concrete, of course, and that marriage in which steel continues to

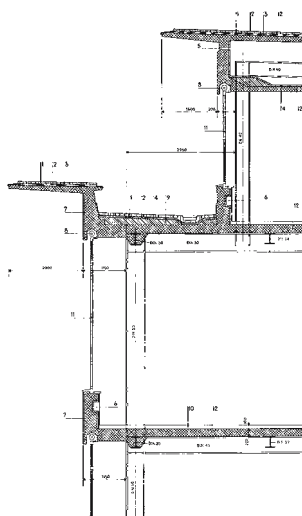
buildings, and highlights the spread of "impure" forms of construction. If we regard this hybrid approach as helpful, then that is a characteristic that designates a major strategy in the use of steel in architecture: the "hidden aid". Other categories are those structures that do not have to satisfy building performance measures (mostly temporary structures and small utility buildings) and engineering structures with large spans.

#### Large spans – substitute material

Even before the appearance of reinforced concrete, the outstanding structural properties of steel enabled the construction of larger buildings – buildings that, compared with those of stone or timber, could exceed previous building heights by, initially, a couple of storeys, later many storeys with the same or even fewer loadbearing components. Steel therefore created the foundation for a whole new type of building: the skyscraper, whose plan layout is characterised by the stairs and lifts needed to transport the larger number of users quickly to the corresponding floors. On the facade the use of steel meant larger spans and hence larger windows, a fact that was demonstrated impressively in Chicago in the late 19th century. Regardless of whether the steel frame was left exposed or concealed behind cladding, windows extending from floor to ceiling and from column to column indicated a structural steel frame. But there were also new buildings whose size alone pointed to the use of this new technology. Enclosed in a stone jacket perforated by small windows, the facades of these framed buildings were hardly distinguishable from those of solid construction. Coupled with a pragmatism fed by industrialisation, it was quickly realised that steel – particularly in high-rise buildings – could assume the role of a substitute structural material, as a replacement for stone and timber, whose load-carrying capacity above a certain height was no longer adequate, and, later, in some instances also as a replacement for concrete, with its intensive labour and material input and many separate operations (formwork, reinforcement, concrete). The fact that steel's significance as a substitute material has continued unabated is underscored by current developments in which steelwork and timber construction come into contact (again); for the transfer of the principles of timber platform frame construction (slender columns and stiffening sheathing) to structural steelwork is more widespread in those regions with minimal timber resources than elsewhere. In fact, systems with thin-wall sheet metal profiles exhibit unmistakable advantages over timber platform frame construction, e.g. no distortion, less weight. They are therefore predestined for adding floors to existing buildings, where saving weight is a prime criterion, but equally for new buildings. However, although the structural and tectonic logic of steelwork is identical with that of timber platform



**Fig. 4: Translation of a stone structure into cast iron**  
Henri Labrouste: Bibliothèque Nationale, Paris (F), 1875



**Fig. 5: Steel frame in conjunction with in situ concrete**  
Roland Rohn: BBC factory, Baden (CH), 1952

provide a frame of columns and beams but the stability is achieved only through composite action with the concrete. In this volatile relationship the two materials complement each other; for example, steel beams replace concrete downstand beams, and trapezoidal profile sheets function as permanent formwork and reinforcement for the floors. Good arguments in favour of composite construction, besides structural reasons, which in the case of the floors includes a more uniform distribution of the loads, involve building performance aspects (concrete introduces mass for good airborne sound insulation) and, above all, improved fire protection because the fire resistance of steel sections depends on the ratio of unprotected surface area (development) to cross-sectional area; accordingly, every steel surface in contact with concrete reduces the surface area exposed to the flames.

As a result of the above advantages and the rational form of building, steel–concrete composite construction has become a popular, common option in today's building industry, primarily for multistorey office and commercial



frame construction, the “steel platform frame” does not supply any of its own exclusive design criteria. It must therefore be considered as another partially synthetic system consisting of wall plates that provide supporting and insulating functions simultaneously.

It almost seems as though the technology transfer takes place in one direction only, i.e. from timber to steel. However, a look at contemporary timber engineering

– were then covered with render outside. Such buildings, often raised clear of the ground and with their windows fitted flush with the facade, appear as weightless, abstract objects. The steel frames to these “lightweight” buildings were seen, if at all, only at isolated points (where “lightweight” is to be understood both in physical – in the sense of optimisation of material – and visual terms). Steel was therefore regarded, on the one hand, as a means of achieving rationalisation in construction and, on the other, as a means of attaining a purist, essentially dematerialised architecture. The inherent relief of the steel sections with their webs and flanges and the principles of frame construction remained concealed behind the external cladding and the internal lining; the fact that this was a steel building was only divulged through the slenderness of the construction, a slenderness that, like the columns of Neutra’s Lovell Health House (1927-29), was hardly differentiated from the window frames and rendered possible an opening–wall ratio (large expanses of glass and long horizontal windows) that was no longer dictated by the positioning of the structural members.

Joseph Paxton’s Crystal Palace (1851) had already demonstrated that the combination with glass – at least in housebuilding – could become an outstanding feature of building with steel or iron. Backed up by knowledge gained in the building of palm houses and large greenhouses, the filigree beams resolved into girders and trusses and the panes of glass framed by the very thinnest of metal glazing bars resulted in a transparency that would have been unthinkable in a timber building. Now, 150 years later, the words “steel” and “glass” still conjure up images of interiors flooded with light (not only among the general public), which have become intrinsic to modern building. Indeed, the glass building, a category linked with certain materials like virtually no other, challenged the architects of the 20th century again and again; and if we take a look at the latest projects designed by architects from the most diverse camps it would seem as though glass, at the start of the 21st century, has freed itself from the ideological trench warfare of the 1990s (“stony Berlin”) and it no longer



Fig. 6: The opening–wall ratio points to a frame behind the facade.  
Louis Henry Sullivan: Schlesinger & Mayer department store, Chicago (USA), 1904

projects reveals that the types of joints between linear members and the bolted connections customary today have derived directly from structural steelwork.

Steel still plays an outstanding, almost singular, role in large spans. Long-span roofs over single-storey sheds, like those of aircraft hangars and exhibition buildings, are built almost exclusively in steel. This is where the fine lines of the loadbearing structure become the dominating interior motif and therefore generate a vocabulary that is exclusive to structural steelwork. And as these are single-storey buildings, fire-resistant cladding (which usually hinders the choice of steel as a construction material and certainly impairs the appearance of the finished construction) is unnecessary.

#### Small sections – paving the way for glass buildings

Whereas in high-rise buildings the sizes of the steel columns and beams were important from the point of view that, compared with stone or timber, they could *carry considerably more* or enable *longer spans*, the exponents of “Neues Bauen” saw in steel the means to create *more slender* constructions. Non-loadbearing lightweight panels were often used between the slender columns to save material and weight; these panels – and the columns too!



Fig. 7: Erecting a “steel platform frame”  
The similarity with timber building: sheet metal profiles instead of planks



Fig. 8: The steel columns are hardly distinguishable from the window frames.  
Richard Neutra: Lovell Health House, Los Angeles (USA), 1927–29

expresses a single architectural statement. Mies van der Rohe's design for a high-rise block on Friedrichstrasse in Berlin (1922) was just a vision, but not long afterwards the glass industry was already in the position to supply panes that could almost satisfy the desire for virtually dematerialised walls devoid of mullions or transoms. After the oil crisis of the 1970s and the growing environmental awareness of the 1980s, the view that the majority of glass buildings were only habitable in conjunction with costly air-conditioning and heating systems seemed to anticipate the demise of such buildings. But linked to alternative energy concepts in which glass is used to gain, to "focus", solar heat energy, and the willingness of architects to add external sunshades, buildings of glass (incorporating new types of glass with U-values as low as 0.4 W/m<sup>2</sup>K) are more topical than ever before. Insulating glass opened up



**Fig. 9: The loadbearing steel structure disappears behind the render.**  
Wassili and Hans Luckhardt: house on Rupenhorn, Berlin (D), 1928



**Fig. 10: Steel frame during construction**  
Wassili and Hans Luckhardt: house on Rupenhorn, Berlin (D), 1928

new opportunities – opportunities we thought had already been abandoned: the steel frame exposed internally and externally. The insulating layer is now draped around the building like a transparent veil and comes close to what Mies van der Rohe called "skin and bones" architecture but never quite attains this level of authenticity – the smooth membrane – owing to technological limits.

The topic of infilling, in which windows or panels, to save space, are positioned between the exposed columns (and which characterises Le Corbusier's "Maison Clarté" in Geneva as much as it does many of the industrialised buildings erected in the first half of the 20th century) is no longer in vogue these days owing to the stricter thermal insulation requirements. This is because, unlike timber, which is a relatively good heat insulator, steel acts as a conductor of heat. However, it should not be forgotten that exposed steel sections in the facades of old industrialised buildings are frequently part of a secondary framework that carries the external cladding only, e.g. a facing leaf of clay brickwork. In this sense the outer divisions reflect the loadbearing structure behind only indirectly. The distinction between infilling and cladding is also vague where the size of the glass elements coincides with the structural grid and, as a result, columns and beams are concealed



**Fig. 11: The glass house was a recurrent theme in the 20th century.**  
Ludwig Mies van der Rohe: Farnsworth House, Plano (USA), 1945–50

behind the frame of the element. This may even resemble parts of the structural frame and hence fulfil the expectation that the nature of the chosen form of construction – in this case a slender three-dimensional lattice – should be reflected in the appearance of the building.

#### Prefabrication and "anything goes"

More so than in timber construction, building with steel is characterised by prefabrication. The poor on-site welding conditions alone make this necessary, as well as the fact that adjustments during erection result in damage to the corrosion protection measures (zinc dust coating plus appropriate paint or hot-dip galvanising), which means that on-site connections are designed for bolting wherever possible. This form of construction also embodies simple dismantling, which may explain the widespread use of steel for exhibitions, like the aforementioned Expo.02 in Switzerland. However, the appearance of prefabrication affects both the loadbearing structure and the build-



**Fig. 12: Windows positioned as panels between steel frame members**  
Le Corbusier & Pierre Jeanneret: Maison Clarté, Geneva (CH), 1932



**Fig. 13: The exposed steel columns support the masonry only.**  
Ludwig Mies van der Rohe: Illinois Institute of Technology, Chicago (USA), 1940–50

ing envelope, which almost presupposes some form of prefabrication when using metal; for the potential of thin sheet metal is linked directly with the options of enhancing stability by way of folding and bending, a feature that can be achieved with other materials only through introducing supplementary ribs or supporting frameworks. Whether the panels visible on the facade are (sandwich) units delivered to site ready for use, or whether they are first assembled on site in the sense of partial prefabrication (prefabrication of individual layers), is less important here. Also of secondary importance is the fact that prefabrication simplifies transport, speeds up the work on site and enables the production of large batches. Folding the sheet metal is quite simply a machine process coupled with the factory and at most – e.g. in the production of waffle forms – involves additional operations such as welding and surface treatments like stove-enamelling or anodising.



**Fig. 14: Industrial manufacture of facade elements: single element**  
Jean Prouvé: CIMT, Paris (F), c. 1955



**Fig. 15: Industrial manufacture of facade elements: individual parts of element**  
Jean Prouvé: CIMT, Paris (F), c. 1955

If we are talking about building with steel – or better, with metal – then we can speak of exclusive factory production. Metalworking based its attempts at standardisation on this fact from an early stage – whether serving a single project or a building system (e.g. USM factory by Fritz Haller). Whereas in the former case inexpensive production is linked with repetition, building systems render the interchangeability of individual elements and seamless expansion possible. Furthermore, building systems are not linked to any specific type of building.

Steelwork is usually based on a sequential, orthogonal assembly, but it can translate any other form by using groups of linear members. Just like a line drawing, sculpted objects like those of Frank Gehry can be resolved into straight members, where concave and convex deformations plus twists and tapers are reduced to the simplest economic formula. As the linear members, which emulate the polymorphic form, do not correlate with the flow of forces everywhere, further ties and struts are added that mingle with the balloon frame like a handi-



**Fig. 16: MAXI building system by Fritz Haller**  
Fritz Haller: USM factory, Münsingen (CH), 1963–84 (extended in four phases)

crafts workshop behind a veil of uniform cladding. When considering economic criteria this would hardly be possible in any other material; just imagine the elaborate, one-off formwork required for such a structure in concrete! So steel becomes the material that makes anything and everything possible.

Or must the negatively charged undertone of enthusiasm be softened because steel – with the assistance of CAD and CAM – obviously renders possible a form of architecture that nullifies or at least broadens our usual understanding of sculpture and gravitation? The computer has cancelled orthogonality as the overriding criterion for economic loadbearing structures. The “new” spaces are affordable. But will they provide useful containers for functions other than museums and concert halls?



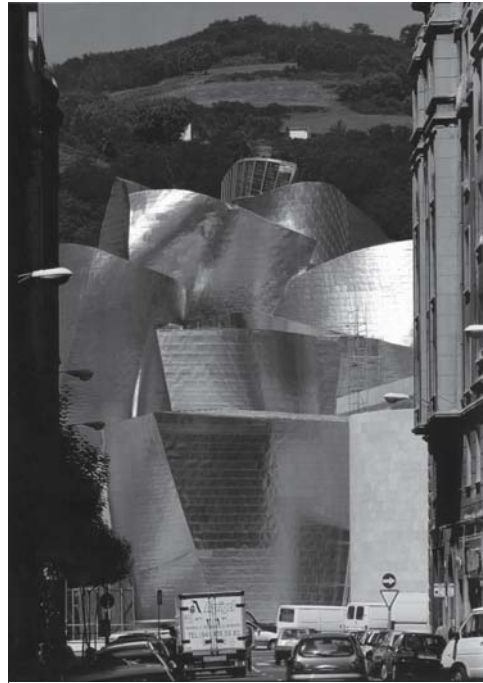


Fig. 17: There is a steel frame lurking behind the sculpted outer skin.  
Frank O. Gehry: Guggenheim Museum, Bilbao (E), 1997



Fig. 18: The dynamic forms were translated into linear lattice structures.  
Frank O. Gehry: Guggenheim Museum, Bilbao (E), 1997

### Constructional ornamentation

In the light of a series of recent buildings and some still under construction we must add a third form to playful plasticity and Cartesian coordination: the diagonal, or the raking column. The time for the rediscovery of the diagonal would seem to be not just coincidental. Following the profound minimalism of the 1990s and, after a sudden deliverance, an opulence tending to randomness, non-orthogonal loadbearing structures seem to unite objectivity and a newly discovered enthusiasm for ornamentation. Whereas structural steelwork once sported decoration in the form of rivets – accepted even by the purists because they were an engineering necessity –, structural steelwork and constructional ornamentation seem to have become bedfellows again at the start of the 21st century. The focus of our attention this time though is no longer the connections but rather the structures that deviate from the pre-eminence of the right-angle and are fabricated principally from steel for structural, economic, and/or architectural reasons (slenderness of the construction). Such structures do not need to demonstrate an ornamental character as loadbearing elements, but instead can inspire a detailed working of the fitting-out parts. What I mean here is the appropriation of a structure-related form that is perceived as an ornament through scaling and multiple repetition. In doing so, it may be our knowledge of the vocabulary of artistic decoration or faceted precious stones that allows us to assign undeniably ornamental qualities to the repetition of non-right-angled surfaces (triangles, hexagons, trapeziums, or rhombuses),

whereas in the case of rectangles we may need different colours, textures, or materials in order to be reminded of jewellery or decoration.

Two recently completed buildings provide good examples of this. Their facades have rhombus-shaped openings and raking loadbearing columns at acute angles. At first sight the close-mesh facades of these two buildings appear similar. But the facade of the Prada Epicenter Store coincides exactly with the loadbearing structure behind, whereas on the Swiss Re Tower it is a scaled image of the structure. And whereas in the former building each storey is equivalent to two rhombuses, in the latter it takes four storeys for the loadbearing structure to form even one rhombus. There are other differences, but what the two buildings do have in common is the fact that the facade lattice forms a rigid “corset”, which means that the service core no longer has to provide a bracing function, and that rhombuses are visible although triangles are formed. To do this, Norman Foster used black paint on his Swiss Re Tower in London (2004) in order to relegate the horizontal members to the background and by default highlight the white diagonals. Herzog & de Meuron, on the other hand, positioned the horizontal ties of their Prada Epicenter Store in Tokyo (2003) level with the floors. There is an attempt at disentanglement in both buildings – one using paint, the other careful positioning.





Fig. 19: Loadbearing structure and glazing bars coincide.  
Herzog & de Meuron: Prada Epicenter Store, Tokyo (J), 2001



Fig. 20: The rhombuses are bisected at the corners of the building.  
Herzog & de Meuron: Prada Epicenter Store, Tokyo (J), 2001

### Rhombus and building form

Besides the loadbearing behaviour of diagonal structures, we must also raise the question of their importance for the volume of the building. If we stick with these two examples, it seems that only in the Swiss Re Tower is there a connection between structure and form. In the case of the Prada Epicenter Store it seems that by choosing a rhombus-shaped lattice, which extends over the entire surface of the building, the architects created tectonic and formal continuity between the cranked sides of this prismatic object. If an arris is not parallel with the facade grid, the deviation is hardly noticeable within this envelope dominated by slanting lines.

From the mathematical viewpoint the rhombus belongs to the family of quadrilaterals and its potential lies in its formal transformation capability. Starting with a square standing on one of its corners, the proportions change almost unnoticeably through compressing and stretching the diagonals; other deformations lead to the parallelogram or the trapezium. In this category the right-angle is the exception and the acute angle the rule – a vocabulary that readily accepts even triangles – triangles that reproduce a structural function or have stereometric origins.

Rhombuses, even horizontal and/or vertical sequences, always form diagonal bands that make it difficult to assign a clear direction. This is totally different to the situ-

ation with orthogonal divisions, where the observer sees the fields in horizontal and vertical relationships only. The lattice structure of the Prada Epicenter Store therefore seems to have no hierarchy, to such an extent that it never enters into a conflict with the order of the building.

Irregular plasticity therefore does not necessarily need customised structures, which usually have structural frames that need some form of cladding.



Fig. 21: The size of the rhombuses matches the form of the building.  
Foster & Partners, Swiss Re Tower, London (GB), 2000–04

### Further reading

- Sigfried Giedion: *Bauen in Frankreich*, Berlin, 1928.
- Schweizer Stahlbauverband (ed.): *Bauen in Stahl*, Zurich, 1956.
- Kunstverein Solothurn (ed.): *Fritz Haller – Bauen und forschen*, Solothurn, 1988.
- Schultz, Sobek, Habermann: *Steel Construction Manual*, Basel, Boston, Berlin, 2000.
- Laurence Allégret, Valérie Vaudou (ed.): *Jean Prouvé et Paris*, Paris, 2001.
- Friedrich Grimm: *Konstruieren mit Walzprofilen*, Berlin, 2003.

## Sections – forms and applications

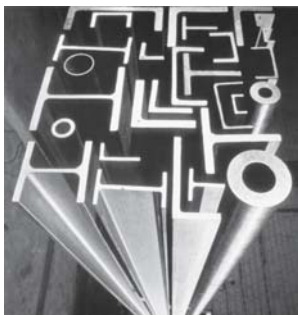


Fig. 22: Various sections

Designation	Smallest size (depth x width)			Largest size (depth x width)		
<i>Wide-flange beams</i>						
<b>HEA</b> light-duty series	HEA 100	(96 mm x 100 mm)	16.7 kg/m	HEA 1000	(990 mm x 300 mm)	272.0 kg/m
<b>HEB</b> standard series	HEB 100	(100 mm x 100 mm)	20.4 kg/m	HEB 1000	(1000 mm x 300 mm)	314.0 kg/m
<b>HEM</b> heavy-duty series	HEM 100	(120 mm x 106 mm)	41.8 kg/m	HEM 1000	(1008 mm x 302 mm)	349.0 kg/m
<i>Standard sections</i>						
<b>INP</b>	INP 80	(80 mm x 42 mm)	5.9 kg/m	INP 500	(500 mm x 185 mm)	141.0 kg/m
<b>UNP</b>	UNP 80	(80 mm x 45 mm)	8.6 kg/m	UNP 400	(400 mm x 110 mm)	71.8 kg/m
<i>Sections with parallel flanges</i>						
<b>IPE</b>	IPE 80	(80 mm x 46 mm)	6.0 kg/m	IPE 600	(600 mm x 220 mm)	122.0 kg/m
<b>IPET</b>	IPET 80	(40 mm x 46 mm)	3.0 kg/m	IPET 600	(300 mm x 220 mm)	61.2 kg/m
<b>UPE</b>	UPE 80	(80 mm x 50 mm)	7.9 kg/m	UPE 400	(400 mm x 115 mm)	72.2 kg/m
<b>UAP</b>	UAP 60 x 45	(60 mm x 45 mm)	8.4 kg/m	UAP 300 x 100	(300 mm x 100 mm)	46.0 kg/m
<i>Structural hollow sections</i>						
<b>RRW / RRK</b> square	RRW 40 x 40	(40 mm x 40 mm)	4.4 kg/m	RRW 400 x 400	(400 mm x 400 mm)	191.0 kg/m
<b>RRW / RRK</b> rectangular	RRW 50 x 30	(50 mm x 30 mm)	4.4 kg/m	RRW 400 x 200	(400 mm x 200 mm)	141.0 kg/m
<b>ROR</b> circular	ROR 38	( $\varnothing$ 38 mm)	2.0 kg/m	ROR 660	( $\varnothing$ 660 mm)	114.0 kg/m
<i>Solid round and square sections</i>						
<b>RND</b>	RND 5.5	( $\varnothing$ 5.5 mm)	0.2 kg/m	RND 400	( $\varnothing$ 400 mm)	986.4 kg/m
<b>VKT</b>	VKT 6	(6 mm x 6 mm)	0.3 kg/m	VKT 200	(200 mm x 200 mm)	314.0 kg/m

For details of national structural steelwork associations and further ranges of sections go to [www.steelconstruct.com](http://www.steelconstruct.com).

Type of section

Applications, remarks



Fig. 23: Wide-flange beams  
HEA, HEB and HEM

for heavy loads (columns and beams)  
Their wide flanges make these sections suitable for inclined loads as well.  
Note: Only in the HEB series does the section designation, e.g. HEB 200, correspond to the actual depth of the section.



Fig. 24: Standard sections  
INP and UNP

Standard sections are the less costly alternative to sections with parallel flanges. They are best suited to welded constructions. Owing to their tapering inner flanges, they are seldom used for bolted constructions.



Fig. 25: Sections with parallel flanges  
IPE, UAP and IPET

IPE sections are slender and therefore better suited to being used as beams (owing to the narrow flange they are less suitable as compression members).  
UPE and UAP sections are frequently compounded because the asymmetric shape permits only low loads.  
IPET sections (IPE sections halved by the fabricators) are used for trusses, girders and also as the glazing bars to glass roofs.



Fig. 26: Structural hollow sections  
Square, rectangular or circular

Primarily used as columns and for trusses and girders, ideal for concentric loading.  
Compared to HEA sections, structural hollow sections exhibit small surface development (less painting).  
The outside diameter remains the same for different wall thicknesses ("invisible" combinations).  
We distinguish between cold-rolled – RRK, lightweight and inexpensive – and hot-rolled – RRW, with good buckling resistance thanks to the upset corners.



Fig. 27: Solid round and square sections  
RND and VKT

Primarily used as hangers and ties.  
Larger cross-sections also suitable as compression members, e.g. in concrete-encased columns (for fire protection).

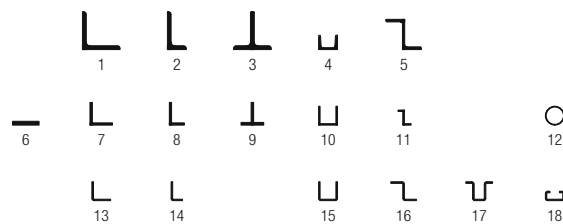


Fig. 28: Angle and small sections  
Common sections for general metalworking projects  
(balustrades, canopies, simple doors and windows, etc.)

- |                                       |                              |                                |
|---------------------------------------|------------------------------|--------------------------------|
| 1 Equal angle, rounded edges          | 7 Equal angle, sharp edges   | 13 Equal angle, cold-rolled    |
| 2 Unequal angle, rounded edges        | 8 Unequal angle, sharp edges | 14 Unequal angle, cold-rolled  |
| 3 Long-stalk T-section, rounded edges | 9 T-section, sharp edges     | 15 Channel, cold-rolled        |
| 4 Channel                             | 10 Channel                   | 16 Z-section, cold-rolled      |
| 5 Z-section, standard                 | 11 Z-section, sharp edges    | 17 Lipped channel, cold-rolled |
| 6 Flat                                | 12 Handrail tube             | 18 C-section, cold-rolled      |

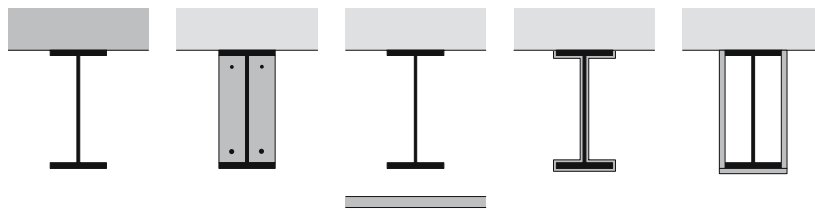
## Fire protection



**Fig. 29: Composite columns**

- a) Concrete-filled circular hollow section: during a fire the concrete core assumes the loadbearing function
- b) Steel core encased in concrete with steel jacket: the concrete protects the core against high temperatures
- c) Concrete-cased steel section without steel jacket

As in timber engineering, fire protection is also a key theme in structural steelwork; for although steel does not burn as such, the effects of heat change its microstructure and, consequently, its load-carrying ability. Therefore, if a loadbearing steel member has to withstand a fire for 60 minutes (F 60 fire resistance class), it must be suitably clad – a totally different situation to loadbearing structures of concrete or masonry. The question of which measures can be taken to reduce the technical fire protection requirements of the structure is more important in the design of steel structures than any other building material. The use of a building and the associated fire risk together with the occupancy, the type of space heating (open or enclosed) and the number of storeys form the heart of a specific project-related fire protection concept. For instance, minimal requirements will suffice for a single-storey industrial building because there are direct means of escape to the outside, the workers are familiar with their surroundings and, usually, will have taken part in a fire drill. The situation is totally different in a building to which the public has access, where the majority of the people using the building are not familiar with their surroundings. Furthermore, single-storey buildings and the topmost storey of multi-storey building are subject to less strict criteria because there are no rooms (or persons) above that can be endangered.



**Fig. 30: Passive fire protection measures**

- a) Unclad section in conjunction with concrete floor slab for fire resistance class up to F 30
- b) Section with concrete infill between the flanges
- c) Fire-resistant suspended ceiling
- d) Fire-resistant paint or plaster
- e) Fire-resistant cladding

Means of escape – saving lives – together with the way the building and its contents are protected – saving property – are the two fundamental objectives of every fire protection concept. In terms of saving lives, it should not be forgotten that suffocation caused by the smoke and fumes given off during a fire – and not collapsing building components, for instance – is the most frequent cause of fire-related deaths. The option of allowing smoke and heat to escape to the outside quickly – in addition to avoiding the inclusion of materials that generate extreme quantities of smoke and fumes – should not be underestimated. The installation of preventive measures and the use of fire alarm systems plus sprinkler systems are not only helpful in saving lives and protecting valuable contents, but also obviate the need to clad the

structural steelwork because there is little risk of a major fire developing in the first place. An aircraft hangar is a prime example: the cost of the aircraft parked inside is many times the cost of the building.

If the *active* fire protection measures (i.e. technical systems such as fire alarms, sprinklers, etc.) are not sufficient or the cost of such measures is deemed to be too high, the properties of the loadbearing structure must be such that it will remain intact for 30, 60 or 90 minutes should a major fire develop (with temperatures up to 1000°C). This is known as *passive* fire protection. The methods available for structural steelwork range from systems in which there is no change to the shape of the section (e.g. by “oversizing” the section or applying fire-resistant intumescent paint, which foams up during a fire), to applying cladding, which encloses the steel members directly or forms a void (e.g. for services) around them, to composite arrangements in which steel is partly or completely filled with or encased in concrete. This latter option also increases the load-carrying capacity of the member. In doing so, columns are frequently enclosed in a steel jacket that serves as permanent formwork for the concrete (see Swisscom headquarters by Burkard, Meyer & Partner, 1999). The enclosing concrete protects the steel section inside against excessive temperature increases and can itself still assume a loadbearing function. In the reverse situation, i.e. filling a structural hollow section with concrete, a transfer of the load takes place during a fire, and the concrete core takes over the loadbearing function exclusively.

### Further reading

- Eurofer Steel Promotion Committee (ed.): *Steel and Fire Safety – A Global Approach*, Brussels, 1993.
- Schweizerische Zentralstelle für Stahlbau (ed.): *Brandsichere Stahl-Beton-Verbundtragwerke*, Zurich, 1997.



Potential applications for structural steelwork





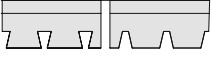


Steel exposed	Fire resistance class R30	Fire resistance class R60	Fire resistance class R90
Columns (1/2) 	SZS/EKS N° 89 (U/A < 50 m <sup>-1</sup> ) (3) ■ ● min. RND/VKT 80 ■ min. 60x120 + min. 150x150 I min. HHD 320x300	SZS/EKS N° 89 (U/A < 14 m <sup>-1</sup> ) (3) ■ ● min. RND/VKT 280 ■ min. 200x500 ■ min. 400x400 ● min. 320x320	none
Beams supporting floor slabs (2) 	SZS/EKS N° 89 min. HEM 300 I	SZS/EKS N° 89 solid steel min. FLB 150/300 ■	none
Constructions with intumescent paint (4)	I T C O all sections <a href="http://bsronline.vkf.ch">http://bsronline.vkf.ch</a>	I T C O all sections <a href="http://bsronline.vkf.ch">http://bsronline.vkf.ch</a>	not permitted
<b>Composite construction (steel/concrete)</b>			
Columns 	SZS C2.3, SZS C2.4, ECCS N° 55 min. HEA 160, RRK 140, ROR 139,7	SZS C2.3, SZS C2.4, ECCS N° 55 min. HEA 200, RRK 160, ROR 159	SZS C2.3, SZS C2.4, ECCS N° 55 min. HEA 240, RRK 180, ROR 177,8
Beams, with concrete infill between flanges, supporting floor slabs (> 120 mm) 	SZS C2.4 min. HEA 100, IPE 120	SZS C2.4 min. HEA 100, IPE 200	SZS C2.4 min. HEA 180, IPE 300
Profiled metal sheets with concrete infill/topping 	SZS C2.4, SZS E2 h <sub>eff</sub> ≥ 60 mm	SZS C2.4, SZS E2 h <sub>eff</sub> ≥ 80 mm	SZS C2.4, SZS E2 h <sub>eff</sub> ≥ 100 mm
<b>Clad steel sections (5)</b>			
Box-type fire-resistant boards  (e.g. columns)	SZS/EKS N° 89 <a href="http://bsronline.vkf.ch">http://bsronline.vkf.ch</a> all sections typical board thickness: approx. 15 mm	SZS/EKS N° 89 <a href="http://bsronline.vkf.ch">http://bsronline.vkf.ch</a> all sections typical board thickness: approx. 25 mm	SZS/EKS N° 89 <a href="http://bsronline.vkf.ch">http://bsronline.vkf.ch</a> all sections typical board thickness: approx. 35 mm
Spray-on protective coating  (e.g. beams)	SZS/EKS N° 89 <a href="http://bsronline.vkf.ch">http://bsronline.vkf.ch</a> alle Profile typical coat thickness: approx. 20 mm	SZS/EKS N° 89 <a href="http://bsronline.vkf.ch">http://bsronline.vkf.ch</a> alle Profile typical coat thickness: approx. 30 mm	SZS/EKS N° 89 <a href="http://bsronline.vkf.ch">http://bsronline.vkf.ch</a> alle Profile typical coat thickness: approx. 40 mm
<p>(1) Figures apply exactly to continuous columns for 3 m storey height (to Euro-nomogram ECCS No. 89).                  (2) Smaller dimensions possible when not fully utilised structurally (see Euro-nomogram ECCS No. 89).                  (3) Section factor U/A (or Am/V to Euro-nomogram).                  (4) Application must be approved for particular project by fire protection authorities (see VKF* fire protection memo 1008).                  (5) Cladding products to VKF* fire protection register, application and constructional boundary conditions as checked and approved (QS responsibility of site management).</p> <p>*Association of Cantonal Fire Insurers</p>			

Fig. 31: Potential applications for structural steelwork  
A design aid published by the Swiss Central office for Structural Steelwork (SZS), draft, 9 June 2004

**Connections**

A selection

**Column continuous**

pinned connections

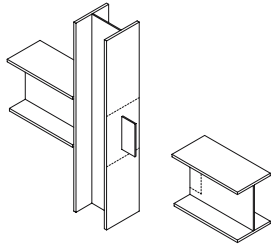
rigid connections

prefabricated nodes

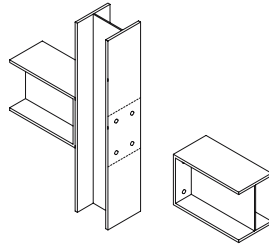
**Beam continuous**

rigid connections

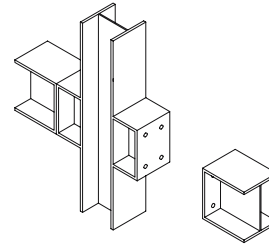
**2-D (x, z)**



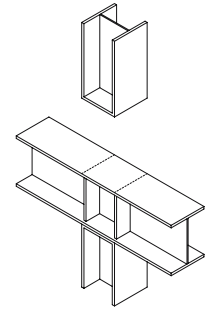
Bolted, cleat welded to column



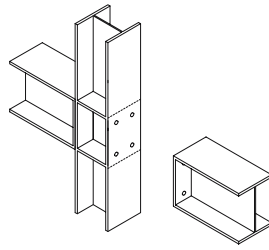
Bolted, end plate welded to beam



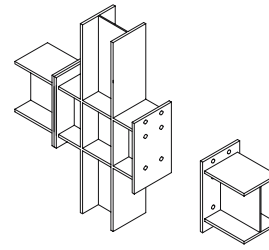
Bolted, end plates welded to column and beam



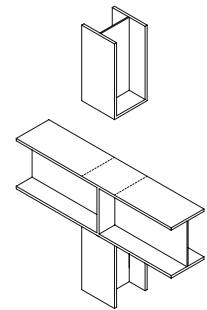
Bolted, stiffeners welded to beam below column flanges



Bolted, stiffeners welded to column in line with beam flanges

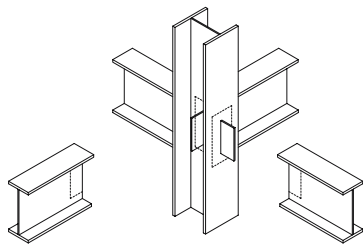


Bolted, with projecting end plates, stiffeners welded to column in line with beam flanges

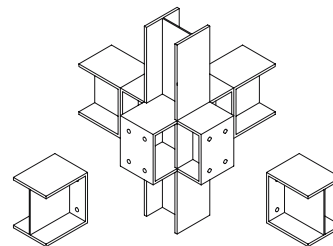


Bolted, stiffeners welded to beam below column web

**3-D (x, y, z)**



Bolted, cleats welded to column

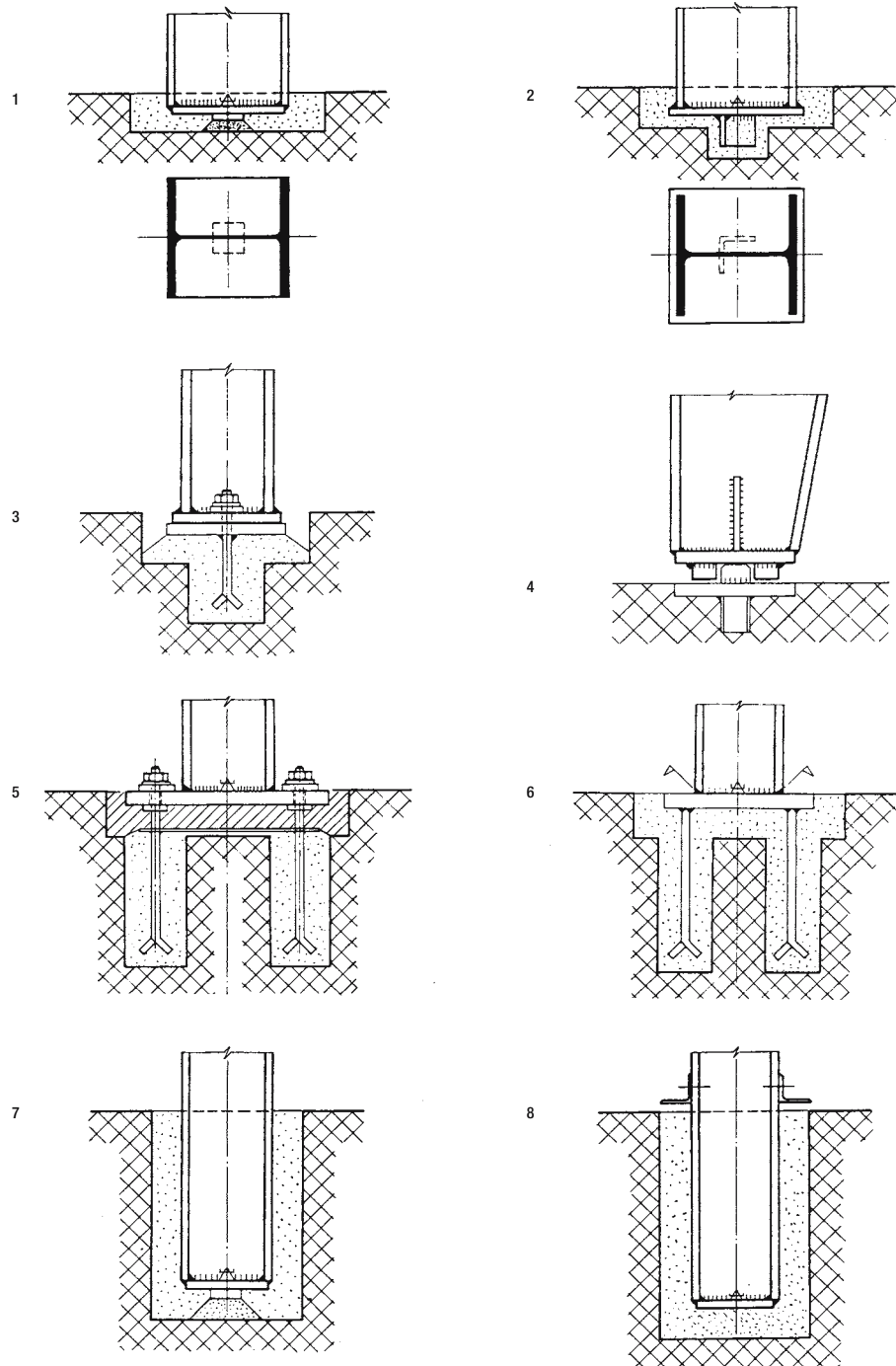


Bolted, end plates welded to column

Fig. 32: Steel connections, selection



Fig. 33: Erecting a steel column



**Base details for pinned-base columns**

- 1 no tension
- 2 no tension
- 3 for low tension, with lower base plate installed beforehand
- 4 no tension, with hinge

**Base details for fixed-base columns**

- 5 with threaded bars cast in beforehand
- 6 with base plate installed beforehand, column welded to base plate on site
- 7 column in pocket to accommodate large bending moments
- 8 column in pocket to accommodate large bending moments

Fig. 34

Source: Swiss Central office for Structural Steelwork (SZS) (ed.), C8 – Konstruktive Details in Stahlhochbau, Zurich, 1973

## Structures – frame with cantilevering beams

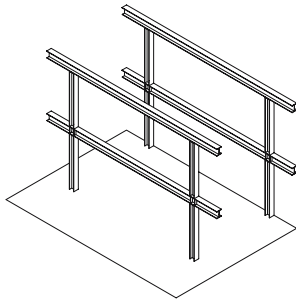


Fig. 35: Frame with cantilevering beams

The loadbearing structure consists of a series of frames with pairs of columns set back from the facade. As the columns are interrupted by the beams, stiffeners must be fitted between the beam flanges to transfer the vertical loads. The drawing shows three variations for the floor, all of which share the feature of being positioned above the main beams.

D1 makes use of a secondary construction of small beams or joists placed on top of the main beams. In contrast to secondary beams at the same level as the main beams, this arrangement allows services to be easily routed transverse to the frames. Depending on requirements, the floor itself could be simple wooden floorboards. D2 and D3 do not use any secondary beams or joists and rely on the trapezoidal profile metal sheets to carry the floor – in D2 merely as a support for a dry floor covering, but in D3 as permanent formwork for a reinforced concrete slab.

### Floor construction D1

Wooden floorboards	27 mm
Steel beams, IPE 160	160 mm
<i>Total</i>	<i>187 mm</i>

### Floor construction D2

Flooring panels	27 mm
Rubber separating layer	20 mm
Trapezoidal profile metal sheets	160 mm
<i>Total</i>	<i>207 mm</i>

### Floor construction D3

Reinforced concrete topping	120 mm
“Holorib” sheets	50 mm
<i>Total</i>	<i>170 mm</i>

**Legend**

- a) HEA 400, interrupted at every storey
- b) HEA 400, continuous beam
- c) Stiffeners below column flanges to carry vertical loads

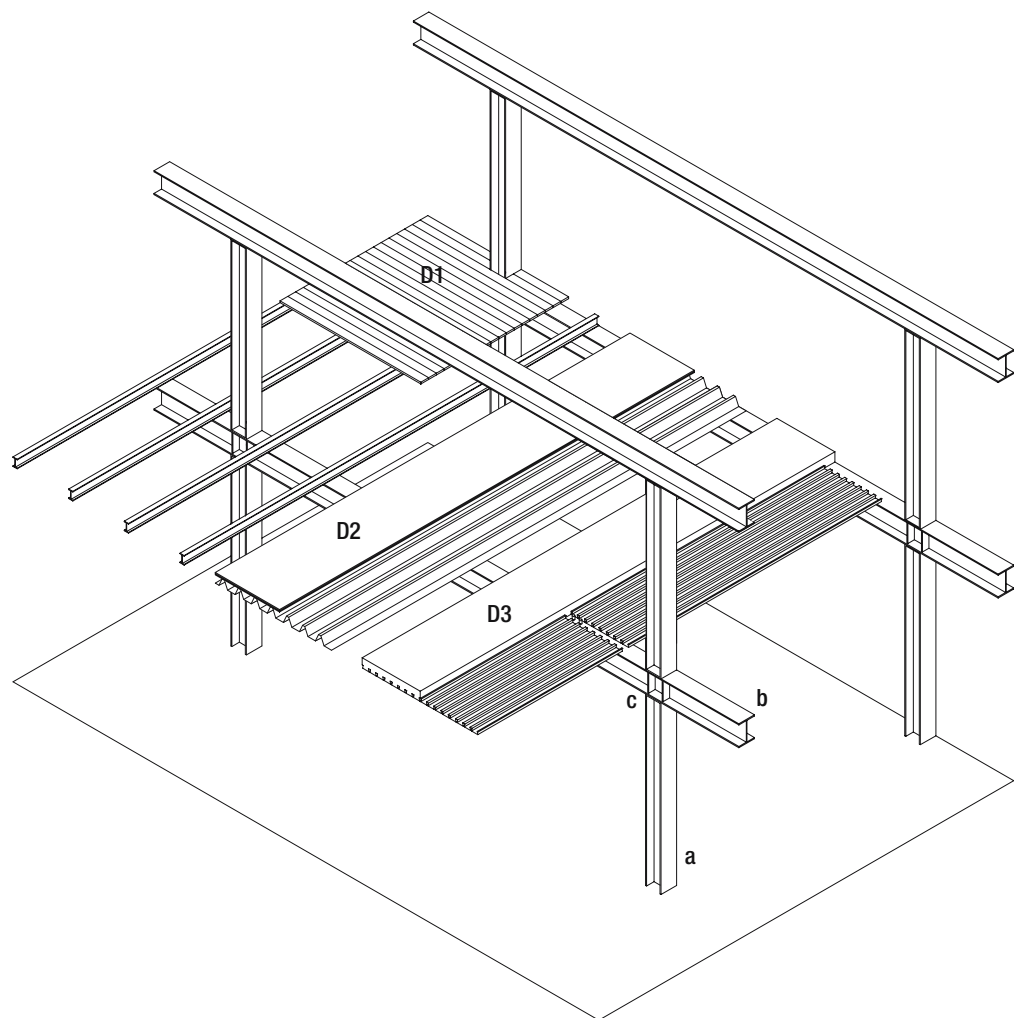


Fig. 36: Frame with continuous beams  
Shown here with floor constructions above level of primary structure



**Steel floors**

Steel floors consist of profiled metal sheets, 0.80–1.75 mm thick, with a filling/topping of concrete. The cross-section of the profiling is usually trapezoidal, produced by rolling. Additional ribs and folds are sometimes included to enhance the stiffness. The sheets are available in widths of 0.30–0.90 m. Some forms are known as cellular floor decks.

The sheets can be supplied with or without galvanising (25–30 µm). Non-galvanised sheets are given a coat of paint on the underside to prevent corrosion.

**Profiles**

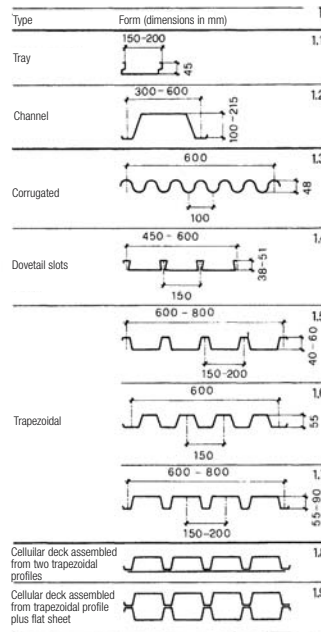
- 1 overview of common profiles:
- 1.1 and 1.2 single profiles
- 1.3 to 1.7 sheets
- 1.8 and 1.9 pre-assembled cellular floor decks

**Advantages of floors with profiled metal sheeting:**

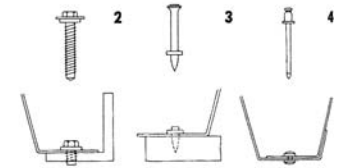
- low weight,
- fast erection,
- no formwork required for concrete,
- floors can support loads immediately after erection, and
- workers below protected against objects falling from above.

**Disadvantages of floors with profiled metal sheeting:**

- steel serves either as permanent formwork only, or
- if required to be loadbearing, the underside needs special fire protection measures, and
- compared with completely dry construction, the in situ concrete introduces a wet trade into the construction.



**Erection of floors with profiled metal sheets**  
The metal sheets are cut to length, packaged together and delivered according to the plan layout so that erection on site can proceed quickly and smoothly, directly after erection of the structural steelwork. Cutting is usually carried out with special cutters to suit the particular profile. Oblique cuts are carried out manually.



**The connections**

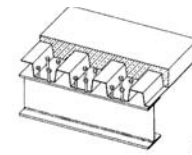
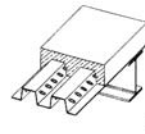
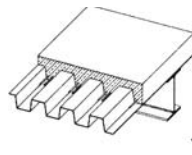
The profiled metal sheets can be connected to the steel beams by:

- welding, according to the instructions of the manufacturer,
- self-tapping screws (drawing 2),
- shot-fired pins (drawing 3).

The connections between the sheets themselves are by way of:

- blind rivets (drawing 4), which can be fitted from just one side without needing access to the other side, or
- punching and interlocking the edges with each other, according to the instructions of the manufacturer.

**Composite floor slabs**

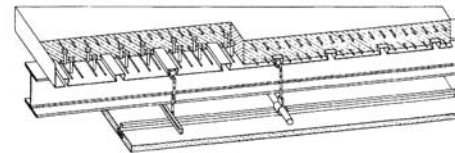


1 The profiled metal sheets are used only as permanent formwork to enable fast progress and immediate provision of floors. Reinforcement is in the form of round bars. The floor acts like a ribbed concrete slab. With sufficient concrete cover to the reinforcing bars, the floor slab is, however, fire resistant. The concrete slab acts as a horizontal plate resisting wind forces.

2 Composite action between sheet metal and concrete. The steel together with the concrete forms a composite cross-section. The sheet steel acts as the reinforcement for the concrete slab. Rolled spines or ribs in the sheet steel transfer the shear forces between concrete and steel. This floor slab requires fire protection to the soffit.

3 Composite action between concrete slab and steel beams. Studs are welded through the sheet steel to the top flange of each beam. In this case the concrete slab forms a composite cross-section with the steel beams. Only the concrete above the ribs is structurally effective. Very economic form of construction. The studs are welded on site according to special instructions.

4 "Holorib" is a steel sheet with rolled dovetail-shaped ribs. The concrete slab is self-supporting and must be reinforced accordingly. The sheet metal serves only as permanent formwork. Tests have shown that in this form of floor the adhesion between the sheet metal and the concrete is sufficient to generate a composite action between the metal and the concrete. The drawing shows shear studs, which create a composite effect between slab and steel beams. The dovetail-shaped ribs are useful for fixing suspended ceilings and services – very helpful in buildings with many services.



**Fig. 37: Composite floor construction**  
Profiled metal sheeting prior to concreting

**Fig. 38**  
Excerpt from Hart, Henn, Sontag: *Stahlbau Atlas* (1st ed.), Munich, 1982

## Structures – frame with continuous columns

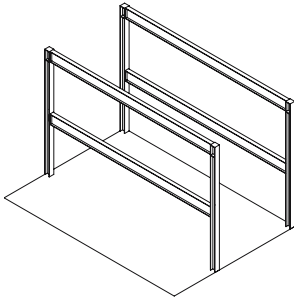


Fig. 39: Frame with continuous columns

The loadbearing structure consists of a series of frames with continuous columns. In this structure the columns are placed directly on the facade so they hardly intrude into the interior. If the plan area is the same as in the previous example, the beams must be larger because the span is greater.

The extra depth can be partly compensated for by positioning the secondary beams for the floor between the main beams. Floor D4, like D1, is based on a secondary construction of small beams or joists, but this time level with the top of the main beams. That means that holes will be required in the beams to accommodate services transverse to the frames. The services can be grouped together or distributed over the full length of the beam in the case of a castellated or cellular beam. Another advantage of such perforated beams is the saving in weight of up to 30%.

D5 is a ribbed slab comprising trapezoidal profile metal sheets suspended between the main beams plus

a concrete infill/topping. Studs welded to the beams beforehand guarantee the composite action between floor and primary structure. The metal sheets are supported on steel cleats (angles, 25 x 35 mm) welded to the beams at the steel fabrication works.

**Floor construction D4**

Glued laminated timber floor panels, e.g. bakelised	27 mm
Steel beams, IPE 160	160 mm
<i>Total</i>	<i>187 mm</i>

**Floor construction D5**

Reinforced concrete topping	120 mm
Trapezoidal profile metal sheets	200 mm
<i>Total</i>	<i>320 mm</i>

**Beams**  
a) HEA 200  
b) IPE 600, partly shown as cellular beam

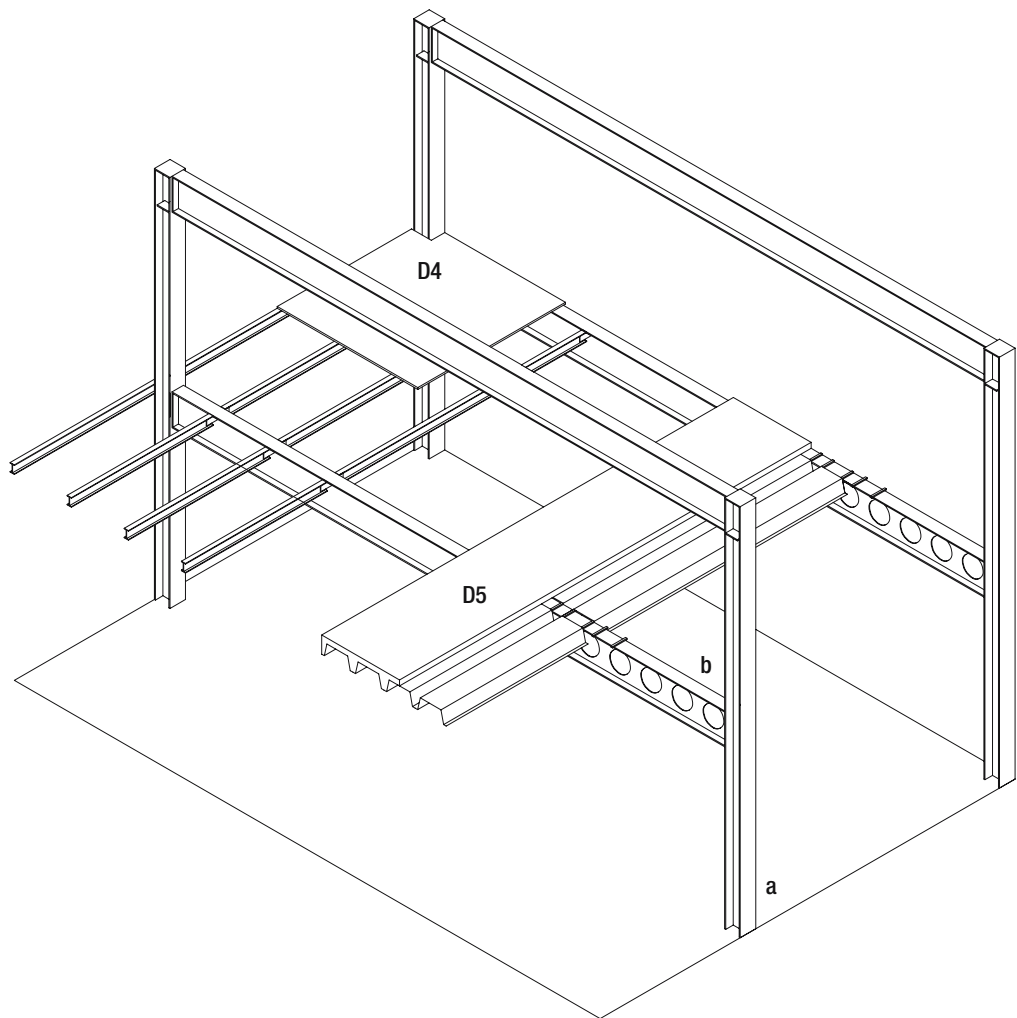


Fig. 40: Frame with continuous columns  
Shown here with floor constructions shallower than the beams

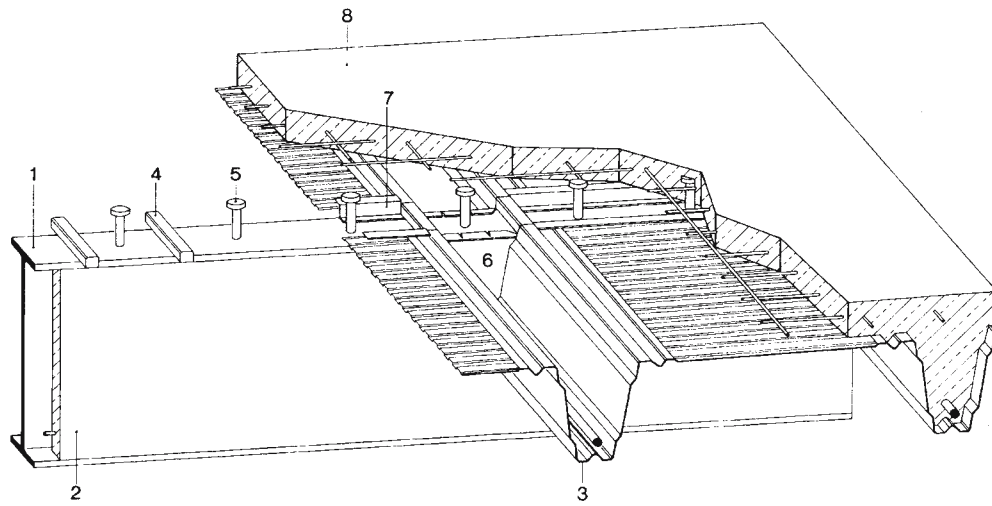


Fig. 41: Composite floor slab with deep trapezoidal sections

- 1 steel beam (acts compositely with slab)
- 2 concrete infill between flanges
- 3 steel trapezoidal section
- 4 steel cleat (25 x 35 mm)
- 5 shear stud
- 6 plastic profile filler
- 7 Z-section closer piece
- 8 reinforced concrete ribbed slab

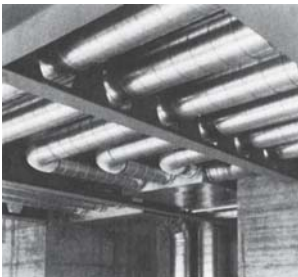


Fig. 42: Cellular beams showing holes being used for services

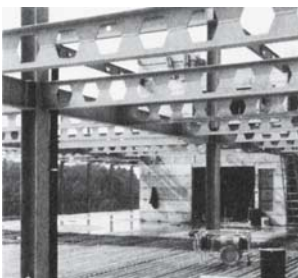


Fig. 43: Castellated beams

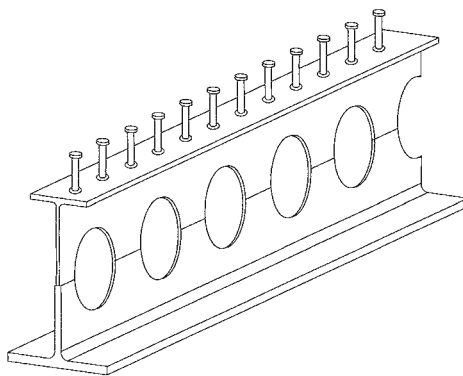


Fig. 44: Cellular beam Example with different top and bottom flanges to save weight

## Structures – two-way frame

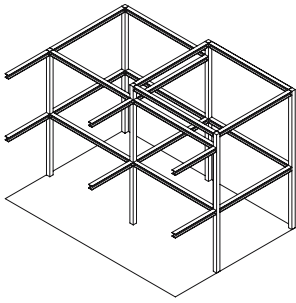


Fig. 45: Two-way frame

The loadbearing structure consists of a two-way frame with columns made from structural hollow sections which, in contrast to **I**-sections, present the same connection options on all sides. As the columns are continuous, beams can be connected at any height, which permits different ceiling heights in different bays. To ensure that all floor beams are loaded equally, the direction of span of the floors should change from bay to bay.

The flooring examples illustrate solutions in which the beams are the same depth as the floor (“Slimfloor”, “Integrated Floor Beam – IFB”, etc.). In both cases here a wider bottom flange plate is welded to the beams to support the floor. D6 is based on precast prestressed hollow-core floor planks which can span up to 12 m. The voids merely save weight; services must still be routed underneath the floor slabs. The great advantage is the dry form of construction. Like D5, D7 is a ribbed slab with, once again, trapezoidal profile metal sheets suspended between the main beams and a concrete infill/topping. Services can be routed

between the ribs. When constructed as a composite slab, the floor serves as a horizontal plate bracing the structure.

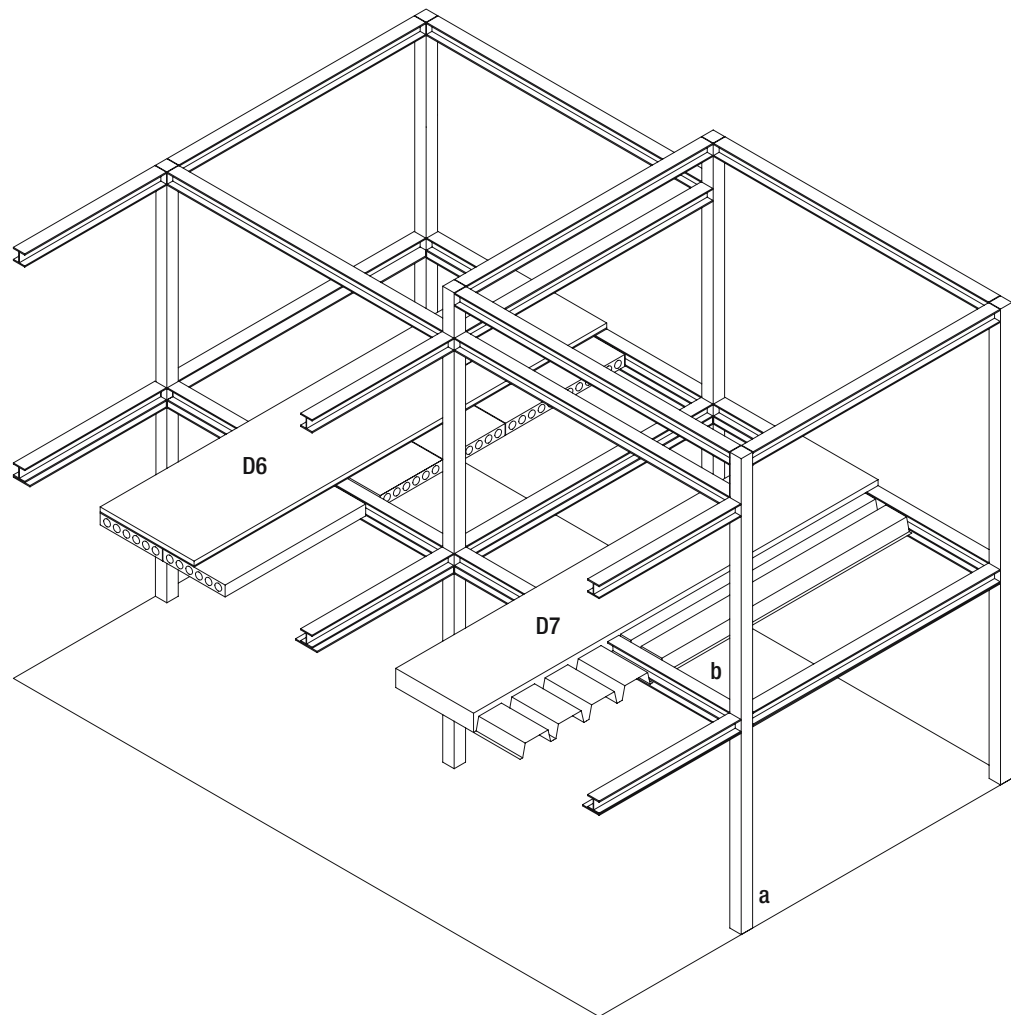
**Floor construction D6**

Cement screed	80 mm
Impact sound insulation	20 mm
Prestressed hollow-core floor planks	220 mm
<i>Total</i>	<i>320 mm</i>

**Floor construction D7**

Reinforced concrete topping	120 mm
Trapezoidal profile metal sheets	200 mm
<i>Total</i>	<i>320 mm</i>

**Beams:**  
a) RHS 200, continuous  
b) HEA 200



**Fig. 46: Frame with continuous columns**  
shown here with floor constructions equal to the beam depth (e.g. Slimfloor)



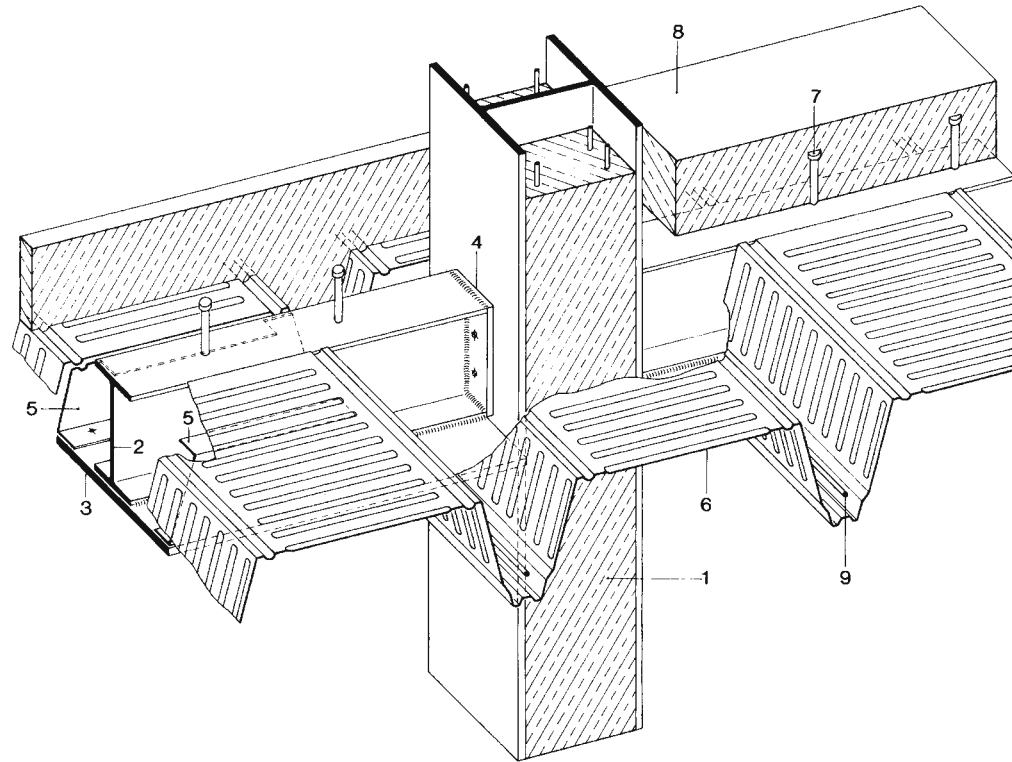


Fig. 47: Composite floor slab with deep trapezoidal sections

- 1 composite column (concrete infill between flanges)
- 2 steel beam
- 3 flange plate
- 4 end plate
- 5 closer plate
- 6 profiled sheet metal
- 7 shear studs
- 8 in situ concrete
- 9 longitudinal reinforcement in ribs

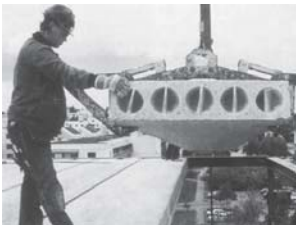


Fig. 48: Positioning a hollow-core floor plank

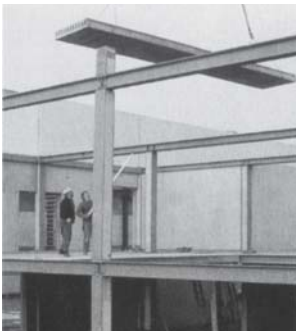


Fig. 49: Erecting a floor of hollow-core planks

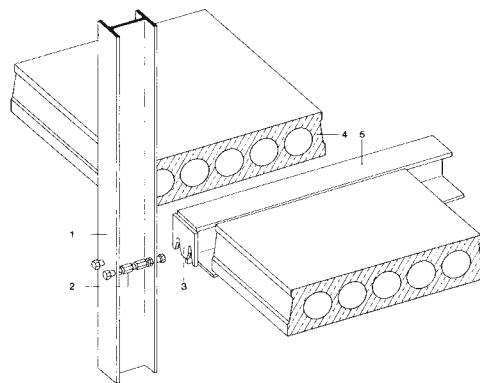
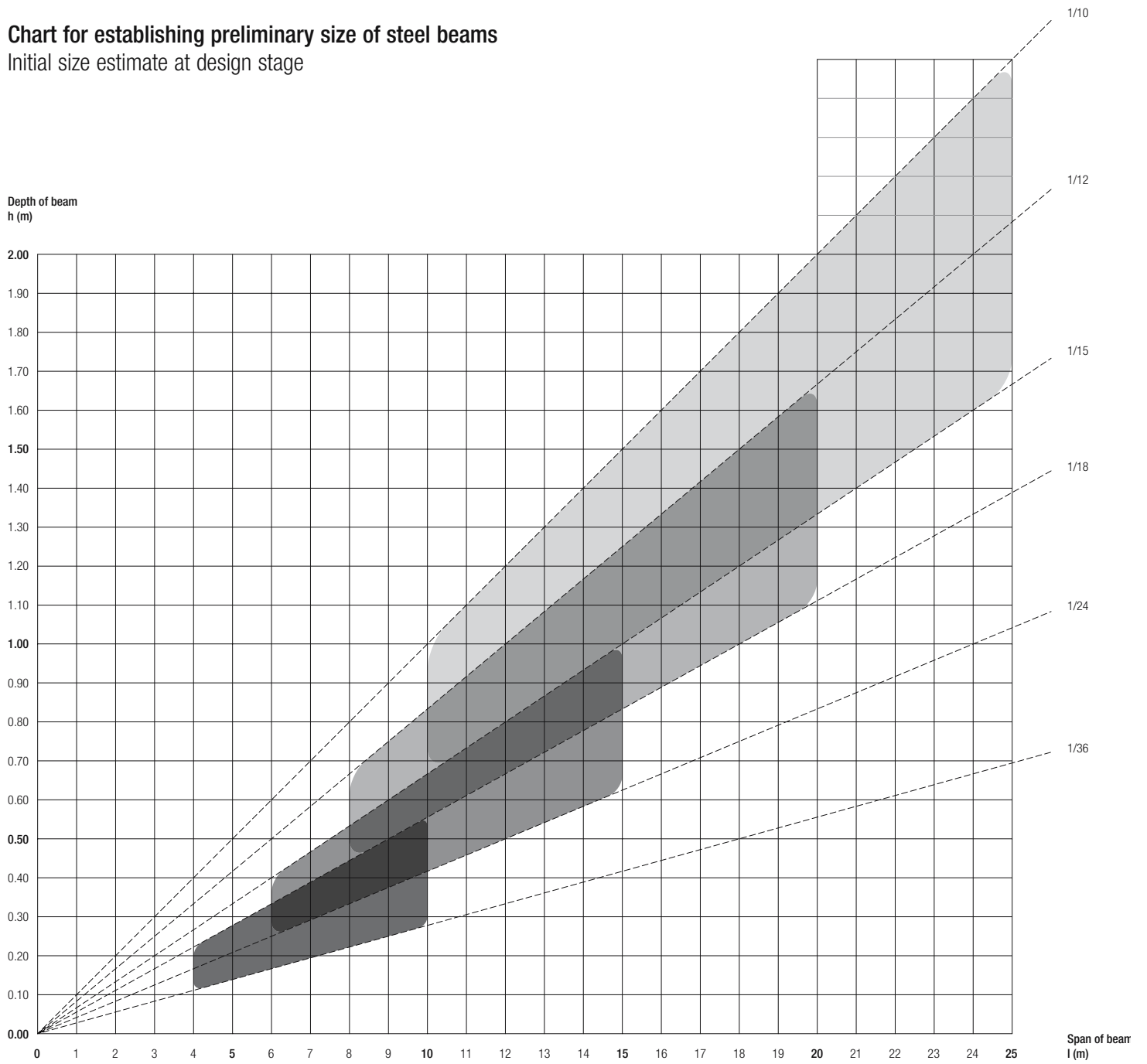


Fig. 50: Prestressed hollow-core planks

Steel beams have wider bottom flange to support floor planks

**Chart for establishing preliminary size of steel beams**  
Initial size estimate at design stage



Element (loadbearing)	Span l (m)	$h^*/l$
Roof purlin (I)	– 10 m	1/18 – 1/36
Floor beam (I)	6 – 15 m	1/15 – 1/24
Castellated beam (I)	8 – 20 m	1/12 – 1/18
Lattice beam	10 – 25 m	1/10 – 1/15

**Fig. 51: Notes for using this chart**  
With a high load (dead and imposed loads) use the maximum value for the member depth as proposed by the chart – vice versa for a low load. The sizes and relationships shown cannot be verified scientifically. The shaded areas are supposed to be slightly "indefinite". In the interest of the rational use of a loadbearing element, the "edges" of this chart should be avoided.

Source: M. Dietrich, *Burgdorf School of Engineering*, 1990

\*An HEA ( $h/b = 1/1$  to  $2/1$ ) or an IPE ( $h/b = 2/1$  to  $3/1$ ) can be used for the initial, rough sizing.

## Folding and bending



Fig. 52: Bent sheet steel ( $d = 12 \text{ mm}$ ) as a structural element (above); plan, scale approx. 1:140 (left)  
Hild und K: bus shelter, Landshut (D), 1999

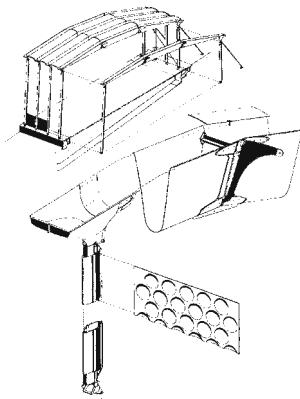


Fig. 53: Details of loadbearing construction  
Jean Prouvé: Pavillon du centenaire de l'aluminium, Paris (F), 1954

Folding is a fundamental metalworking technique and a whole industry has grown up around this process. Besides paper and cardboard, metal is the only material that allows this sort of deformation. The folding of spines and ribs enhances the stability of thin sheet metal, which enables large plates and sheets to be laid directly on the loadbearing structure without any further support. This is why corrugated sheet metal – and later trapezoidal profile sheets – has been so popular as a roofing material and also as a cladding for utility and industrial buildings since its invention in 1829.

The work of the French engineer Jean Prouvé (1901–84) went way beyond simply optimising the processes for cladding materials. Using his favourite material, aluminium, he devised entire loadbearing constructions based on folded sheet metal. His pavilion to celebrate the 100th anniversary of the industrial production of aluminium in 1954 is a good example. It demonstrated how aluminium could replace timber and steel, the traditional materials for exhibition structures. This 152 m long structure is based on 15 m long beams at 1.34 m centres with sheet aluminium suspended between in such a way that the



Fig. 54: Loadbearing structure and building envelope united in the form of semicircular, loadbearing sandwich elements, shown here almost complete.  
Jean Prouvé: La Méridienne de l'observatoire, Paris (F), 1951



Fig. 55: Erecting the sandwich elements  
Jean Prouvé: La Méridienne de l'observatoire, Paris (F), 1951

trough sections act as gutters. The beams themselves were made from three separate pieces first joined on site by means of cast connecting brackets. This is a clear reference to mechanical and automotive engineering.

While in the aluminium pavilion the loadbearing structure made use of linear members and its “column” and “beam” components obviously obeyed the principles of filigree construction, these elements were combined into self-supporting elements at Prouvé's observatory structure of 1951. The building has a parabolic cross-section formed by two half-shells that support each other. The curved form here is due to the rigid connection between the inner and outer aluminium sheets.

Released from building performance stipulations, Hild and K managed to fabricate the walls to their bus shelters

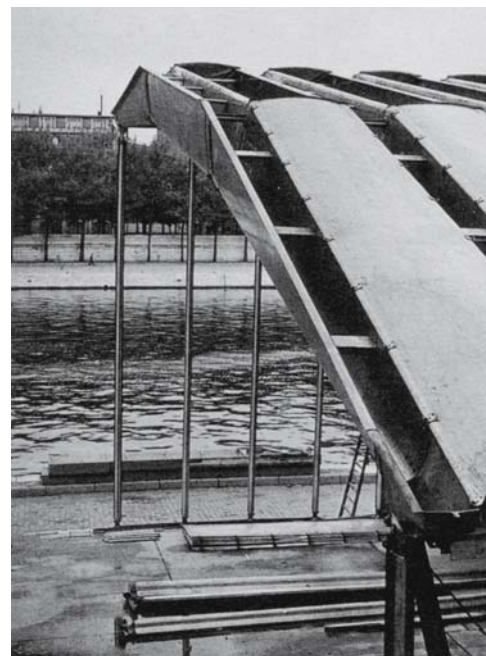
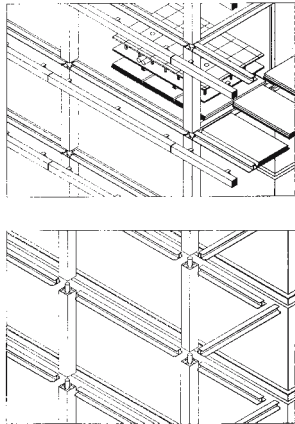


Fig. 56: The aluminium roof beams resemble a gutter in section.  
Jean Prouvé: Pavillon du centenaire de l'aluminium, Paris (F), 1954

in Landshut from thick sheet metal without any further supporting framework. The exposed feet were milled out of the 12 mm thick Cor-Ten (weathering) steel plate just like the ornamentation. On plan the shelter consists of two L-shaped plates.

## Frames



**Fig. 57: Steel frame with prefabricated floor elements and concrete topping**  
Burkard, Meyer Architekten: Swisscom headquarters, Winterthur (CH), 1999



**Fig. 58: On the facade the floor slab edges are the only visible part of the loadbearing structure.**  
Burkard, Meyer Architekten: Swisscom headquarters, Winterthur (CH), 1999

Apart from reinforcing bars in reinforced concrete, the majority of steel in buildings is to be found in the form of frames. The columns and beams form a framework of linear members with floors and non-loadbearing walls as the “infill” panels. Dry construction techniques can be used for the floors and walls, or the composite action of steel and concrete can be exploited. The steel frame is characterised by rational procedures.



**Fig. 59: The square grid visible on the facade is only a covering to the loadbearing elements behind.**  
Georg Marterer: teahouse in Neustift am Walde, Vienna (A), 1998

The Swisscom headquarters in Winterthur by Burkard, Meyer & Partner (1999) is a good example of a steel frame for a building of this size. Surrounding the solid, stiff core housing stairs, lifts and services are concrete-cased steel columns on a 5.6 x 5.6 m grid; these columns consist of a solid steel core and a sheet metal jacket (permanent formwork). Precast concrete floor elements are supported on the widened bottom flanges of the steel beams. A concrete topping is added to this to form a solid composite structure. The loadbearing structure is enclosed by the facade in such a way that the floor edges are the only visible part of this assembly.

At first sight the teahouse in Neustift am Walde (1998) by Georg Marterer seems to convey the impression that the grid outlines on the facade are the structural steel frame. But in reality these pieces are merely applied to cover the joints between the elements, although the visible grid does indeed correspond exactly with the loadbearing structure behind, on a square grid (2.46 x 2.46 m), which carries the fixed glazing, sliding windows and plain infill panels.



**Fig. 60: Steel frame and corrugated sheets left exposed internally**  
Lacaton & Vassal: holiday chalet, Lège Cap-Ferret (F), 1998

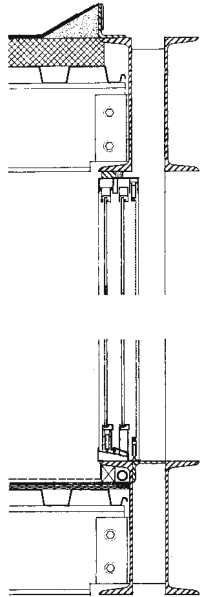
Like the holiday chalet by Lacaton & Vassal in Lège Cap-Ferret (1998), which was built around existing trees, the frame in the teahouse appears as sculpted relief in the interior.

Another similarity with the holiday chalet – and totally different to the Swisscom headquarters – is that this is a completely dry construction in which only the floor slab is made of concrete. The building’s stability is guaranteed by the diagonal X-bracing positioned behind the elements.

For further examples of frames, please refer to the chapter entitled “Structures”.



## Girder, lattice beam and facade



**Fig. 61: Two-part top and bottom chords enable posts and diagonals to be “clamped” between.**  
Craig Ellwood: holiday chalet, San Luis Obispo (Cal/USA), 1967/68

Once the span exceeds a certain distance, off-the-shelf rolled steel sections are no longer adequate. To save material and weight we truss the beam with ties underneath, use a castellated or cellular section, or provide a lattice beam or girder. Up until the mid-20th century the construction of loadbearing structures assembled from the most delicate sections was a daily occurrence – if not the only option for long spans. The welding together of individual members (top and bottom chords, struts and ties) is, however, very labour-intensive, which leads to plate girders with solid webs and flanges still being used despite the considerably higher material consumption.

Although the resolution of the loadbearing structure into a framework of linear members involves higher labour costs, the advantages are savings in weight, easier routing of services and transparency. This latter feature was exploited by Herzog & de Meuron in their locomotive depot “Auf dem Wolf” (1995), where the girders form lan-

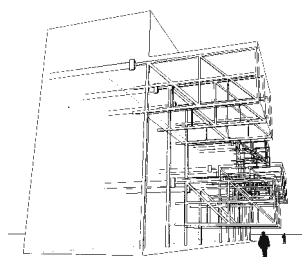


**Fig. 62: The lantern lights (clad with patterned glass) span from wall to wall.**  
Herzog & de Meuron: locomotive depot “Auf dem Wolf”, Basel (CH), 1995

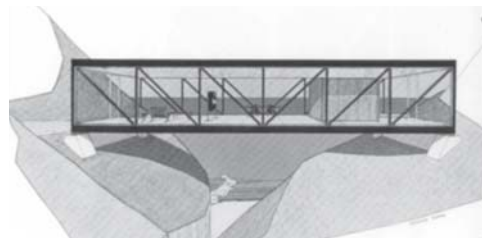
tern lights. The building comprises a concrete box frame with a steel roof construction. Supported on the concrete walls every 13 m are pairs of girders that form square tubes spanning distances of up to 40 m. Clad in patterned glass, these 3 m high tubes, from which the beams for the intermediate flat roofs are suspended, simultaneously act as lantern lights.

Whereas in the Herzog & de Meuron design the girders are used only on the roof, at Craig Ellwood’s holiday chalet in San Luis Obispo (1967/68) they are the primary loadbearing structure and, as such, the longitudinal facades of the house. Like a bridge, they form a long tube that spans an 18 m wide canyon. Each of the girders comprises pairs of channel sections (as top and bottom chords) with square hollow sections as the ties and struts in between. Floor and roof are supported on steel beams spanning the two girders at the same spacing as the vertical members of the girder.

In the above examples the structural steelwork characterises the architectural appearance of the building – the Ellwood design more so than the Herzog & de Meuron, where the steelwork is situated behind a semi-trans-



**Fig. 63: The windows are located between the posts and the diagonals.**  
MVRDV: senior citizens’ apartments, Amsterdam (NL), 1997



**Fig. 64: A house in the form of a bridge**  
Craig Ellwood: holiday chalet, San Luis Obispo (Cal/USA), 1967/68

parent veil. But the structural steelwork to the senior citizens’ home in Amsterdam by MVRDV (1997) is totally concealed, where the enormous length of the two-storey cantilevers is the only clue to the fact that a weight-saving design in structural steelwork lies behind the facades. This supposition is probably helped by the openings, whose positioning and maximum size is determined by the posts and diagonals.



**Fig. 65: Aerial view of site, the longest locomotive shed is not yet finished.**  
Herzog & de Meuron: locomotive depot “Auf dem Wolf”, Basel (CH), 1993



**Fig. 66: Steel frame concealed behind timber cladding**  
MVRDV: senior citizens’ apartments, Amsterdam (NL), 1997

## Space frames

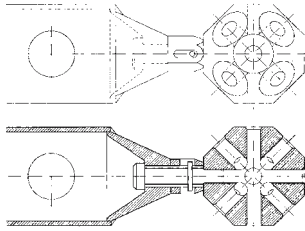


Fig. 67: "Mero" node with member attached  
Elevation and section



Fig. 68: Exposed corner  
Norman Foster: Sainsbury Centre for Visual Arts,  
Norwich (GB), 1978

Space frames consist of delicate linear members often joined via ball-like nodes with up to 18 connection options. Besides Konrad Wachsmann and Buckminster Fuller, who devoted themselves enthusiastically to the development of such lightweight structures for long-span roofs, Max Mengerhausen also played a significant role. It is his "Mero" node, a screwed connection invented in 1942, that is still used today. A space frame comprises top and bottom chord levels together with intermediate three-dimensional diagonals. Depending on whether the space frame is a combination of tetrahedra, octahedra and/or cuboctahedra, the upper and lower levels are either parallel with each other on plan or offset diagonally.

In Norman Foster's Sainsbury Centre for Visual Arts (1978) the space frame is resolved into individual trian-

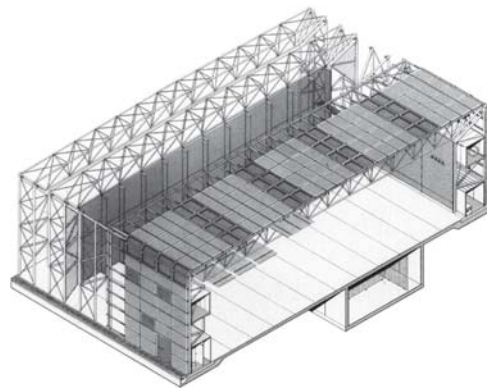


Fig. 69: Identical structure and building envelope for roof and walls, axonometric view of loadbearing construction with and without cladding  
Norman Foster: Sainsbury Centre for Visual Arts, Norwich (GB), 1978

gular girders (each of which is itself a pair of two lattice beams with a common bottom chord). It is interesting to note that the roof and the walls utilise the same structure and same building envelope. In the walls Foster uses the girder depth of about 3 m not only to integrate services but also to access corridors within the loadbearing level. The nodes of the girders are welded; only the diagonals between the girders were bolted in place on site to suit the erection procedure.

Buckminster Fuller's USA Pavilion for the 1967 World Exposition in Montreal managed to disintegrate entirely the boundary between wall and roof. The truncated sphere – with a diameter of 110 m at the base and an impressive 167 m at the "equator", all achieved with steel tubes having a maximum size of just 9 cm – formed a container for the USA's exhibits. Contrary to Foster's design, the building envelope here – hexagonal acrylic panels – was attached to the inside of the frame. The hexagonal panels matched the framing of the lower level (bottom chord), while the upper level (top chord) consisted of a triangular grid.

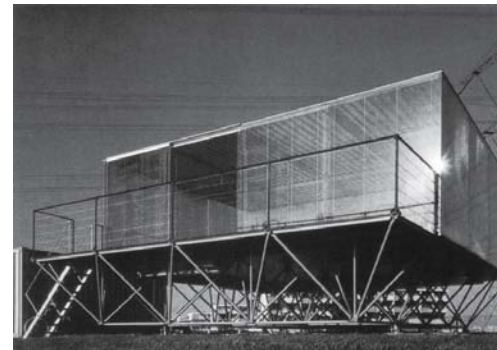


Fig. 70: The space frame distributes the loads of the building to four pad foundations.  
Bentham Crouwel: private house, Almere (NL), 1984

Space frames are generally associated with roofs, or rather long-span roofs; a space frame with a depth of, for example, 4 m, can span up to 70 m. The private house in Almere (NL) by Bentham Crouwel (1984) should therefore be regarded as an extension of the application without ignoring the principles of this form of construction completely. Poor subsoil conditions and the fact that this was originally intended to be a temporary structure – it is still standing and was in fact extended in 1991! – inspired the use of an easily dismantled space frame which distributes the load of the house to four pad foundations, which should be regarded as stub columns. Raising the ground floor above the level of the site also helps to protect the building against moisture from the ground.



Fig. 71: The truncated sphere has a base diameter of 110 m.  
Buckminster Fuller: USA Pavilion, EXPO 67, Montreal (CAN), 1967



## Diamonds and diagonals

The bracing diagonal is frequently an addition, an unavoidable solution inserted to complete the structural concept in those designs where bracing components such as rigid service cores and shear walls are lacking. But when used as a primary structural element they are very popular, as recent examples show – whether as a bundle of apparently random, raking columns (“pick-up-sticks” effect), or integrated into a regular lattice. In such cases the fascination is due to the fact that the vertical and horizontal loads can be accommodated with a single structure of linear members seemingly without any hierarchy, but equally because the network takes on an ornamental quality.



Fig. 72a: The four corner columns with intersecting linear members function in a similar way to Suchov's mast.  
Toyo Ito: Mediothek, Sendai (J), 2001



Fig. 72b: The corner columns house the stairs.  
Toyo Ito: Mediothek, Sendai (J), 2001



Fig. 73: Rhombus-shaped loadbearing structure to facade  
Herzog & de Meuron: Prada store, Tokyo (J), 2003

Early examples of non-orthogonal lattice structures are the towers of Vladimir Suchov, which originated out of a search for a form of water-tower construction that would save materials. A comparison between Suchov's radio mast in Moscow (1919-22) and the Eiffel Tower in Paris (1889) supplies impressive proof of the potential savings of a tower constructed exclusively of angle and channel sections. Whereas the Eiffel Tower is 305 m high and weighs 8850 tonnes, the radio mast is 350 m high and weighs just 2200 tonnes!

The hyperbolic form employed is based on two cylinders with straight members whose top and bottom rings are “rotated” in opposite directions to create a rhombus-shaped lattice structure. The intersections were riveted together and horizontal rings were attached inside to increase the stiffness, which resulted in the triangular look of the lattice.

A contemporary example that borrows the ideas of Suchov can be seen in Toyo Ito's Mediothek in Sendai (2001), where the four corner towers are constructed according to similar principles.



Fig. 74: Glazed barrel-vault roof based on triangular lattice  
Norman Foster: Faculty of Law, Cambridge (GB), 1995

Whereas the loadbearing members in the structures of Suchov and Ito adhere to a clear hierarchy, the diagonal and horizontal members of the barrel-vault roof to Norman Foster's Faculty of Law in Cambridge (spanning nearly 40 m) appear to be equals. The construction employs circular hollow sections with a diameter of 160 mm, with alternate ones braced together in pairs. It is interesting to note that the glazing is positioned a few centimetres in front of the loadbearing structure. Was this done merely to enable Foster to feature this membrane, or was there a more practical reason – the fact that the circular sections are unsuitable for fixing the glazing directly?

There is no such separation at the Prada Store in Tokyo by Herzog & de Meuron (2003). In this building the glazing is fixed directly to the lattice structure, which together with the three internal cores carries the vertical loads. This is an impressive demonstration of the structural potential of welding (at the nodes of the horizontal rhombuses); for the loading is considerably higher than with vertical rhombuses and therefore calls for rigid corner joints.

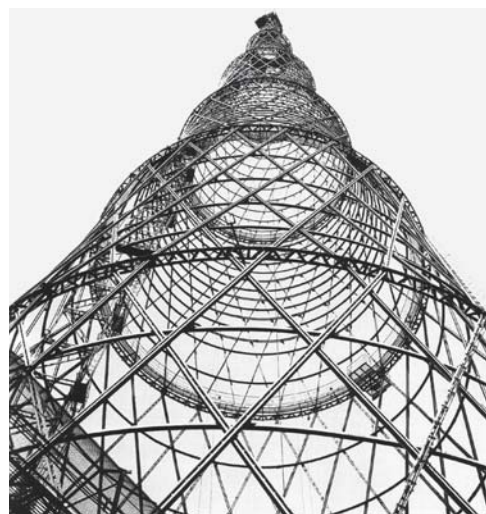


Fig. 75: Linear members consisting of two channels in a spiral form create a hyperbola.  
Vladimir G. Suchov: Sabolovka radio mast, Moscow (RUS), 1919–22

## Canopy structures

The majority of loadbearing structures are derived from basic units that can enclose spaces only through repetition. For example, a frame (two columns plus one beam) requires at least one other frame in order to generate an interior space. A canopy structure, on the other hand, can form an independent structure on its own, e.g. a petrol station forecourt, a bus shelter.



**Fig. 76a: Canopies under construction**  
Pier Luigi Nervi: Hall of Labour, Turin (I), 1961



**Fig. 76b: Canopies of concrete and steel, bay size 38 x 38 m**  
Pier Luigi Nervi: Hall of Labour, Turin (I), 1961

The independence of the individual canopy enables it to be erected in isolation. A narrow separation allows daylight to enter, a wide separation enables the roof module to be incorporated again but without the column. A representative of the former category is Nervi's "Hall of Labour" (1961) in which 16 canopies spaced 40 m apart cover a square main area flanked by two-storey ancillary buildings on each side. Each 20 m high canopy is supported on a concrete tower, the cross-section of which gradually transforms from a cruciform at the base to a circle at the top. The roof itself is supported on a steel drum from which 20 identical cantilevering, tapering beams radiate, the outer ends of which are connected by a perimeter member. The taper of the beams and the angled underside of the drum clearly illustrate the flow of the forces. As the facade is flush with the edges of the outer canopies, the construction can be properly perceived from the inside only.



**Fig. 77: "Trees" with 48 "branches"**  
von Gerkan, Marg & Partner: Stuttgart airport (D), 1990



**Fig. 78: The table-like construction lends texture to the trainshed roof.**  
Rafael Moneo: Atocha station, Madrid (E), 1984–92



**Fig. 79: Modular roof; a second element is suspended between the columns.**  
Norman Foster: Stansted airport, London (GB), 1991

Comparable with Nervi's design in every way is Atocha station in Madrid by Rafael Moneo (1984–92). He, too, uses concrete columns, but the roof beams follow a clear hierarchy: the underside is divided into four triangles containing beams perpendicular to the edges. Duo-pitch rooflights cover the slits between the canopies and therefore delineate the roof surface.

A totally different concept underlies the "tree" structures of Norman Foster's airport terminal at Stansted (1991). The canopies here are so far apart that another roof section with a side length of 18 m can be suspended between. There is also no difference between the materials of the roof and those of the supporting structure. Resolved into four circular hollow sections ( $d = 45$  cm), the central column beneath each canopy itself encloses space which is used for accommodating infrastructure components. The raking compression members seem to instill a merger between roof and structure, forming a three-dimensional edifice.

The term "tree structure" is even more apt at the airport terminal in Stuttgart (Gerkan, Marg & Partner, 1990). Starting from four circular hollow sections each 40 cm in diameter, the "trees" each divide into 48 "branches", the thinnest of which has a diameter of 16 cm.



**Fig. 80: The structure is legible both internally and externally.**  
Rafael Moneo: Atocha station, Madrid (E), 1984–92



## The “invisible” building material

Eva Geering, Andrea Deplazes

### Of concealment and exposure

The “multi-layer wall construction”, designed to satisfy the thermal performance requirements of a building, grew out of the oil crisis of the 1970s and the subsequent realisation that we must reduce our consumption of energy. The outermost layer in our wall – now resolved into layers – serves to protect the (usually) unstable insulation from the weather. The insulation in turn (usually) encloses the loadbearing structure for the whole building, to which it is fixed, like a wool coat. This technically obvious development raised new questions related to the architecture: What does an insulated wall look like? Could or should its form correspond to that of a monolithic wall? One obvious solution to this dilemma is to build the outer protective layer in the form of a self-supporting leaf of masonry or concrete. That enables our multi-layer wall to appear like a solid wall, almost as if there had never been an oil crisis. Even if the insulation is protected only by a thin layer of render in order to reduce the amount of work, our wall still appears to be a solid structure. At least so long as we do not actually touch it... Systems with ventilation cavities avoid these pretences and convey a more lightweight yet protective appearance, with a cladding of wood, sheet metal or slates. This arrangement also covers the inevitable layer of insulation and uses it only indirectly as a reason for altering the architecture. It is hardly surprising that in the 1970s, in contrast to the dogmas of Modernism, architecture again became a medium with meaning, and the clothing theory of Gottfried Semper again became topical.

In their Suva Building in Basel, Herzog & de Meuron pursued a strategy contrary to the concealment theory. As the insulation is protected by a transparent, glass skin, we get to see materials that were not actually intended to be visible. Although during the age of Modernism all decoration was renounced and the “truth of construction” proclaimed, revealing the insulation material in this instance is not concerned with a didactic derivation of constructional details. Instead, what we have here is the breaking of a taboo and the fascination with “ugly” materials. In particular, the use of unconventional materials raises probing questions of cultural conventions and reveals the beauty of their shabbiness. The tension between meaning and effect results in a poetry of the material: “How is poetry revealed? It is revealed by the fact that a word is recognised as a word and not as a mere substitute for something it designates.” (Roman Jakobson, *Questions de poésie*)

### Heat losses versus heat gains

Insulation protects against heat losses from the inside, but also against an excess of heat entering from the outside. One or the other of these effects is relevant depending on the climate; in the temperate climate of continental Europe

preserving heat *and* gaining heat are desirable, depending on the season. One attempt to deal with this paradox that is intrinsic to materials is the development of transparent thermal insulation. This type of insulation, comprising several components, does not block out the light and hence heat but rather allows it to penetrate and heat up a wall capable of storing this energy. Transparent thermal insulation is not only permeable to light and heat but is also transparent to visible light. This is especially obvious in the direct gain system in which the transparent thermal insulation is employed as an enclosing element without any wall behind it. The use of transparent thermal insulation in this way is similar to the use of a not completely transparent window. Not only the outer protective layer of this wall construction is transparent, as we can see on the Suva Building, the insulation itself is virtually invisible. It is, so to speak, non-existent and permits the illusion of being reckless with the building performance parameters (see “Transparent thermal insulating materials”, p. 145).

### Synthetic building materials

Whether visible or invisible, the forms of thermal insulation mentioned above are part of an elaborate system of complementary and interdependent layers.

Synthetic building materials such as masonry or concrete with insulating properties satisfy the desire for simple buildability. In the meantime, industry can offer a wide variety of building materials that provide both loadbearing and insulating functions. The key physical and structural

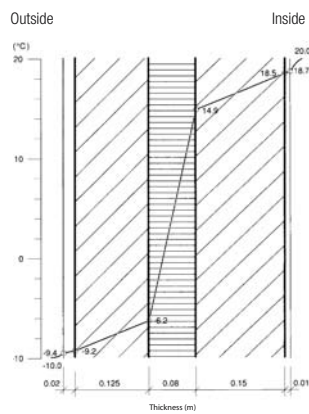


Fig. 1: Multi-layer wall construction  
Temperature gradient within the layers



Fig. 2: Existing and new buildings linked by insulating glass facade;  
top: straight on the road side; bottom: diagonally in the inner courtyard  
Herzog & de Meuron: Suva combined residential and commercial development,  
Basel (CH), 1988–93

issue is to be found in this duality. The loadbearing material is so permeated with air-filled pores that it just exhibits sufficient load-carrying capacity, while the air captured in the pores, with its poor conduction, provides an insulating effect. So the insulating function always weakens the loadbearing material, with the ratio of strength to insulation needing to be determined in each case. The blurred dividing line between a loadbearing material with insulating properties and a loadbearing insulation material characterises such materials. Synthetic building materials, especially porous and brittle insulating masonry units, call for careful workmanship on site and must always be protected against moisture. In order to guarantee the required protection from the weather, synthetic building materials must be rendered or treated with a water repellent.

### Polyurethane as a loadbearing shell

Another strategy comes to the fore in the example described below. The insulation is no longer applied to the loadbearing layer, nor does it imply it; instead, the layer of insulation *is* the loadbearing layer.

Rigid insulating materials with a good compressive strength have been developed for insulating components subjected to compression loads, e.g. flat roofs or parking decks for heavy-goods vehicles. Philip Johnson exploited this technical development for the architecture of Gate House in New Canaan (Massachusetts, USA).

Gate House (a visitors' pavilion for Johnson's "Glass House") was erected using a complementary method with the help of conventional materials: insulation, concrete, reinforcement. However, their interaction is not easy to decipher. The components do not simply complement each other in the finished building nor are they completely fused. The reinforced layer of insulation functions as permanent formwork for a thin strengthening and protective layer of concrete. The method of construction

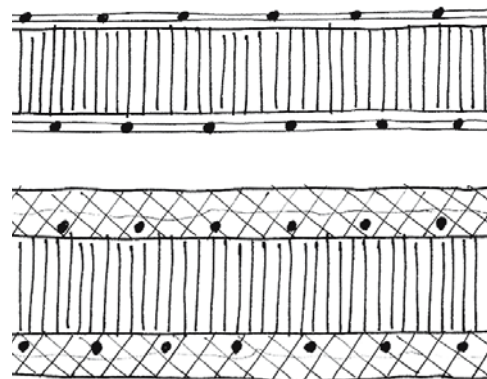


Fig. 3: Sketches of wall construction (horizontal sections)  
 Top: the rigid PU foam insulation between two layers of reinforcing mesh serves as permanent formwork. Bottom: rigid PU foam insulation panel covered with two coats of sprayed concrete both sides  
 Philip Johnson: Gate House, New Canaan (USA), 1995

used at Gate House is based on an Italian patent which Johnson's structural engineer, Ysrael A. Seinuk, brought to his attention. Normally, this method of construction – in the form of panels made from two parallel layers of reinforcing mesh and an intervening layer of insulation (rigid polyurethane foam), the whole covered with a thin layer of sprayed concrete – is used to construct cheap housing. Unlike conventional concreting no formwork is required. In order to erect the complex shapes required at Gate House the horizontal sections through the building were built as wooden templates and positioned with the help of a scaffold.

Using these as a guide, similar to the construction lines on a drawing, the building was assembled from the prefabricated rigid foam panels. The partly flat, partly convex, partly concave parts were joined together on site like the pieces of a puzzle. At this point the shape of the building could still be changed, a fact that Johnson made full use of; the opening for the door was cut out, the surfaces and edges given the correct form. The first layer of sprayed concrete stiffened the assembly of panels and enabled most of the templates and the scaffold to be removed. The second layer of concrete gave the wall the necessary thickness and provided the necessary cover to the reinforcement. The outcome of this reversal, in which the formwork is suddenly on the inside, is an apparently monolithic, thin-wall concrete shell. This method of construction in which the design can be manipulated during the building process renders possible the dream of plastically deformable, insulated concrete.

### Walls of straw

Straw is a pure insulating material. However, if you compress it, it can become a loadbearing material. Here again, it is the enclosed pockets of air, not the straw itself, that create the insulating effect. The development of straw bale presses began around 1800 in the USA. In those regions in which grains and cereals were cultivated the fields were literally covered in "oversized roofing tiles" following the harvest. It didn't take much fantasy to turn these elements into temporary shelters.

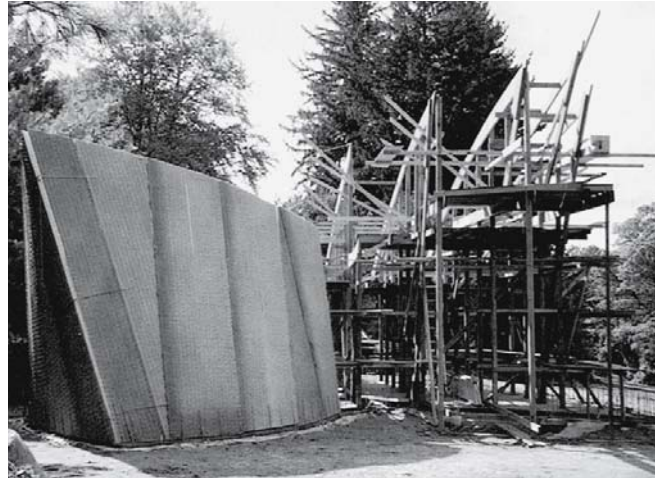
It transpired that these temporary buildings outlived their planned period of usefulness completely unscathed, indeed even thwarted the extreme summer and winter conditions of Nebraska, and that a comfortable climate prevailed inside throughout the year.

Today, this old strategy is gaining favour again, albeit in the guise of sustainable building, e.g. Tscheppa House in Disentis (GR) by Werner Schmidt. In order to prevent moisture problems, a concrete foundation is cast on which the bales of straw and the timber reveals to the openings are built. The bales of straw are assembled in a brick-like bond. Vertical straps, which have to be retightened several times during the brief period of erection, draw the straw





1 Horizontal wooden templates positioned and fixed with the help of a scaffold



2 Rigid foam panels already erected on the left



3 Finished assembly of rigid foam panels



4 Cut-out for large entrance opening (note the difference between this and photo 3). Edges reinforced with additional bars.

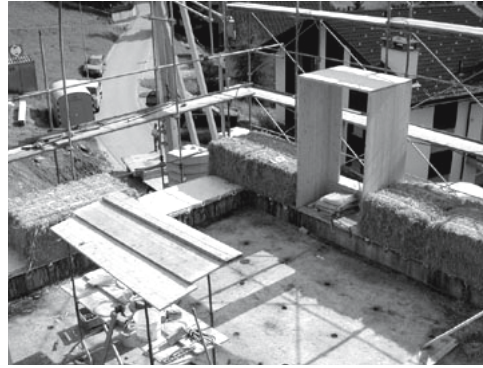


5 Building coated with the first layer of sprayed concrete



6 Gate House cleaned and prepared ready for painting

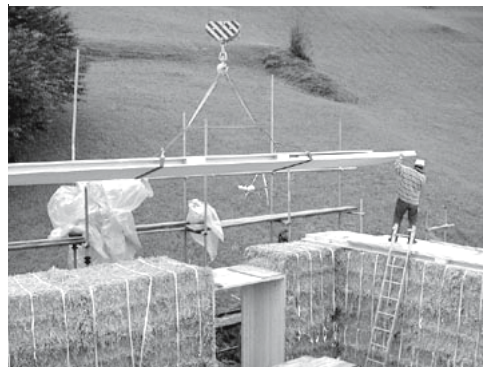
**Fig. 4: Progress on site**  
Philip Johnson: Gate House, New Canaan (USA), 1995



1 Reveals to openings mounted on concrete foundation; first course of straw bales in position



2 Building up the wall with straw bales in a "masonry bond"



3 Positioning the intermediate timber layer to act as a bearing for the floor and reveals of the upper storey; the vertical strapping is readily visible here



4 Structural shell almost complete, only the protective layer of render has yet to be applied

**Fig. 5: Progress on site**

Werner Schmidt: Tscheppa House, Disentis (GR), 2002



**Fig. 6: Built from bales of straw**  
Simonton House in Purdum, Nebraska (USA), 1908

bales tightly together and hence consolidate the walls to such an extent that even two-storey buildings are quite possible. Intermediate timber boards serve as bearings for the joists, beams and reveals of the upper storey. Once the straw house has finally settled, it can be rendered and hence protected from the ravages of the weather. Therefore, the inevitable form of construction results in a building with metre-thick, sculpted walls. The straw wall seems, quite by chance, to solve the dilemma sparked by

the oil crisis. What initially began as an ecological experiment, could lead to a new architectural style of "Baroque plasticity". The game has begun.

#### Further reading

- Gottfried Semper: *Style: Style in the Technical and Tectonic Arts; Or, Practical Aesthetics*, Harry Francis Mallgrave (ed.), Los Angeles, 2004
- Martin Steinmann: *Die Unterwäsche von Madonna*, lecture, 1996, published within the scope of the Alcopor Award 2000.
- Roman Jakobson: *Questions de poétique*, Paris, 1973. English translation: Roman Jakobson: *On Language*, Harvard, 1995.
- Jeffrey Kipnis, Philip Johnson: *Architectural Monographs No. 44*, London, 1996.
- Herbert Gruber and Astrid Gruber: *Bauen mit Stroh*, Staufen, 2000.
- *Die Südschweiz*, "Im Stroh schlafen", 27. 11. 2002, p. 19.



## Transparent thermal insulation



Fig. 7: Dietrich Schwarz: house in Domat/Ems (CH), 1996

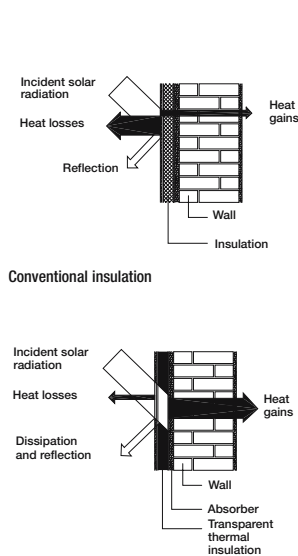


Fig. 8: Transparent thermal insulation



Fig. 9: Wall construction with transparent thermal insulation

### Definition

Transparent thermal insulation functions only in conjunction with glass, which protects the insulation from the weather and, thanks to its transparency, admits daylight and especially solar radiation. Inside the building the light is converted into heat and contributes to the space heating requirement. In addition, transparent thermal insulation reduces heat losses from inside to outside and therefore functions as a thermal insulation. In contrast to the majority of customary insulating products, this material also very frequently remains visible from the outside behind a pane of glass. Transparent thermal insulation elements are also permeable to wavelengths of the solar spectrum other than visible light and do not necessarily have to employ clear glass.

### Construction (from inside to outside):

- Protective layer of glass
- Layer of insulation comprising transparent thermal insulation elements (dense, honeycomb-like capillary structure of transparent plastic)
- Protective layer of glass or solid loadbearing layer, or rather absorber

### How transparent thermal insulation works

Three principal forms gradually appeared in the evolution of applications for transparent thermal insulation. These can be distinguished according to the way in which the solar energy is used.

### Direct gain system

The transparent thermal insulation is employed as an enclosing element without any wall behind. It is therefore similar to a light-permeable but not transparent window element or glass facade. The solar radiation passes through the transparent thermal insulation directly into the interior and is converted into heat at the various surfaces within the interior. The interior temperature changes almost simultaneously with the temperature of the surfaces. Therefore, in summer fixed or movable sunshades must be provided in order to prevent overheating in the interior.

### Solar wall

In the solar wall system the incident solar radiation is converted into heat on the outside face of a solid external wall. Controlled by the insulating effect of the transparent thermal insulation material, the heat energy flows through the wall to the inside face and is then radiated into the interior. Fluctuations in the outside temperature are tracked internally but with a delay. This delay can be influenced by the material and thickness of the wall.

### Thermally decoupled system

In the thermally decoupled system the incident solar radiation is converted into heat at an absorber surface isolated from the interior. The heat is fed either directly into the interior via a system of ducts, or into a heat storage medium, which can be part of the building itself (e.g. hollow floor slab or double-leaf wall), or part of the building services (e.g. pebble bed or water tank). With thermally isolated storage media the release of heat into the interior can be controlled irrespective of the absorber or storage temperature.

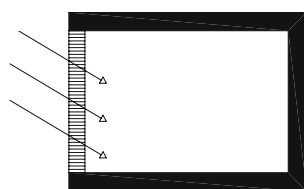


Fig. 10: Direct gain system

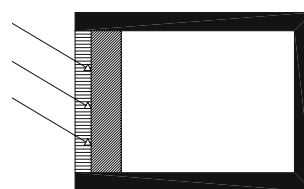


Fig. 11: Solar wall

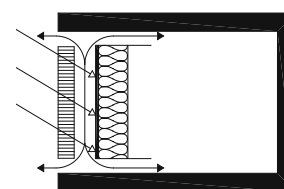


Fig. 12: Thermally decoupled system

Thermal insulation materials...

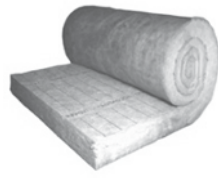


Fig. 13: Glass wool



Fig. 14: Cellular glass (foam glass)



Fig. 15: Extruded polystyrene (XPS)



Fig. 16: Wood fibres

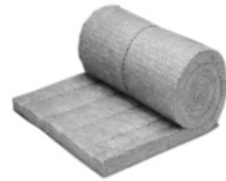


Fig. 17: Rockwool



Fig. 18: Expanded polystyrene (EPS)



Fig. 19: Rigid foam



Fig. 20: Cellulose fibres

	Insulating material	Name of typical product	Physical appearance	Diffusion resistance index [-] (*bonded joints)	Thermal conductance [W/mK]		
					0.06	0.09	0.12
Inorganic, synthetic raw materials	<b>Mineral fibre glass wool</b>	Isover	Yellow boards	Open to diffusion ( $\mu = 1$ )	■		
	<b>Mineral fibre rockwool</b>	Flumroc, Rockwool	Green-grey boards	Open to diffusion ( $\mu = 1-2$ )	■		
	<b>Cellular glass</b>	Foamglas	Black, hard boards	Vapourtight* ( $\mu = \infty$ )	■		
Inorganic, natural raw materials	<b>Expanded clay</b>	Leca	Brown granulate			■	
Organic, synthetic raw materials	<b>Expanded polystyrene (EPS)</b>	Styropor (BASF)	White, grainy boards	Vapourtight* ( $\mu = 40-100$ )	■		
	<b>Extruded polystyrene (XPS)</b>	Styrofoam	Light blue boards	Vapourtight* ( $\mu = 80-250$ )	■		
	<b>Rigid polyurethane foam</b>	Swisspor	White-yellow boards	Vapourtight* ( $\mu = 60-80$ )	■		
	<b>In situ polyurethane foam</b>		Yellow foam		■		
Organic, natural raw materials	<b>Wood fibres</b>	Pavatex	Medium brown, fibrous boards	Open to diffusion ( $\mu = 5$ )	■		
	<b>Cement-bonded wood-wool</b>	Herakliith, Schichtex	"Spaghetti boards"	Open to diffusion ( $\mu = 2-7$ )		■	
	<b>Cellulose fibres</b>	Isofloc	Usually newspaper flakes	Open to diffusion ( $\mu = 1-2$ )	■		
	<b>Sheep's wool</b>	doscha, isolena	Mats, fleece, felt, loose fill	Open to diffusion ( $\mu = 1-2$ )		■	
	<b>Flax, hemp</b>	Flachshaus	Boards, mats, loose fill	Open to diffusion ( $\mu = 1$ )		■	
	<b>Cork</b>		Brown, coarse-grained boards	Open to diffusion ( $\mu = 2-8$ )	■		

Fig. 21: The various insulating materials

...and their applications

Price category	Remarks	Thermal insulation material, not subject to compression, e.g. for walls, floors and ventilated roofs	Thermal insulation material, not subject to compression, e.g. for insulation between rafters and joists	Thermal insulation material, subject to compression, e.g. for casting against concrete as permanent formwork, for general use in floors and roofs	Thermal insulation material with defined compressive strength for use beneath floors distributing compression loads, e.g. industrial floors	Thermal insulation material with enhanced compressive strength for use beneath floors distributing compression loads, e.g. parking decks for heavy goods vehicles	Thermal insulation material able to withstand bending moments, e.g. for cladding timber-frame constructions subject to wind loads	Thermal insulation material able to withstand pull-off loads, e.g. for facades with mineral render	Impact sound insulation material	Impact sound insulation material, also suitable for use with defined low compressibility
inexpensive	The smallest fibres can be inhaled	■	■	■				■	■	
inexpensive	The smallest fibres can be inhaled	■	■	■				■	■	
expensive	Can be reused as road sub-base, raw material: scrap glass	■		■	■	■				■
	Incombustible insulating material	Loose fill								
inexpensive	Does not rot, ultraviolet radiation causes embrittlement, can be worked mechanically	■		■			■	■	■	■
moderate exp.	Does not rot, ultraviolet radiation causes embrittlement, can be worked mechanically	■		■					■	■
moderate exp.	Dust must not be inhaled, not resistant to ultraviolet radiation	■		■	■				■	■
		■		■	■				■	■
moderate	Fine dust during sawing, sheets can be reused	■	■	■				■	■	■
moderate	Fixed with nails, wall anchors, tile adhesive, suitable as substrate for plaster/render, ceramic products, plasterboard	■		■			■	■		
inexpensive	Loose fill (tipped or blown)	■	■							
moderate exp.	Formaldehyde catalyst, hence recommended for air hygiene aspects, easily reused	■	■						■	
inexpensive exp.	Easily reused (except facade panels), facade insulation panels readily available	■	■						■	
inexpensive exp.	Smell of material must be considered when used indoors	■		■	■				■	

Source: Reyer, Schild, Völkner: *Kompodium der Dämmstoffe*, Fraunhofer IRB Verlag, 2000

## Thermal insulation systems

### Overview

#### Complementary systems

The feature of the complementary system is its hierarchical functional breakdown into monofunctional components. The building envelope is divided into layers providing loadbearing, insulating and protection functions, whereby the development of the individual layers must be continuous. Drawing a diagram of the layers helps to analyse a structure and determine the key details.

Based on the position of the structural elements in relation to the layer of insulation, we distinguish between two different complementary systems:

#### *Loadbearing layer inside*

- Double-leaf construction in masonry and/or concrete (1)
- Ventilated construction with lightweight or heavy-weight cladding (2)
- Rendered external insulation (3)

#### Synthetic systems

In a synthetic system a single non-hierarchical element provides multiple functions, e.g. loadbearing and insulating, or insulating and protecting. The building envelope is either essentially homogeneous (e.g. single-leaf masonry) or in the form of a “black box” whose components form an inseparable composite (e.g. timber panel construction). Synthetic systems are often supplemented by complementary systems because certain details are otherwise impossible to solve properly (e.g. plinth and wall–roof junction in single-leaf masonry). It is therefore not helpful to draw a diagram of the layers.

Synthetic systems can be divided into two types:

#### *Compact systems*

- Single-leaf masonry with/without insulating render (5)
- Concrete with insulating properties

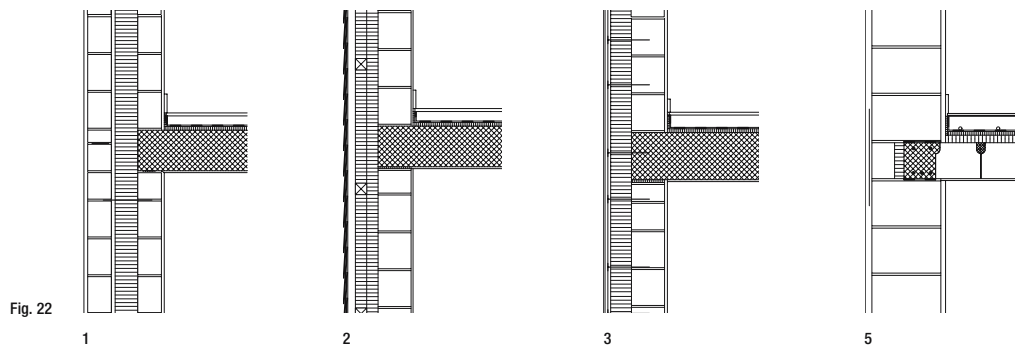


Fig. 22

#### *Loadbearing layer outside*

- Exposed concrete with monolithic or isolated floor junction (4)
- Facing masonry externally
- Solid timber construction with internal insulation

#### *Sandwich systems*

- Timber platform frame construction (6)
- Timber panel construction (7)

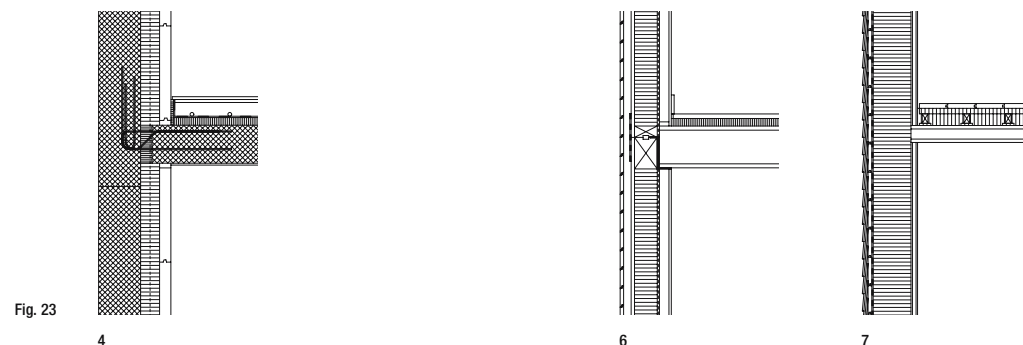


Fig. 23



## Glass – crystalline, amorphous

Tibor Joanelly

Glass is transparent, hard and precious. These properties clutter our view of a material that, on closer inspection, defies a clear physical and phenomenological description. And it is precisely in this obviously unfocused definition that glass reveals its own fascination.

The fact that we can see through glass sets it apart from other materials, makes it unusual and valuable. When we speak of glass we usually mean industrially manufactured glass in the form of vessels or windows. We forget that, for example, cellular glass loses its transparency and hence its “glassiness” during the foaming process. However, it remains a form of glass still produced – or better, recycled – in large quantities. Or glass fibres – this thread-like material developed to transmit light and data does not comply with our general idea of glass either.

Specific technical requirements have led to a huge variety of glass products. So the word glass more rightly describes a physical state rather than a clearly defined molecular material. However, in this chapter we shall speak of glass mainly in terms of the common understanding of this material and how this can be interesting for architecture.

Compared with its almost 5000-year-old history, the use of glass as a building material is a relatively recent development. The technology required to use glass in the building envelope in the form of small panes joined together was not available until the blowing iron was invented by the Romans. However, since that time glass has been available in two basic forms. The sheet glass we produce these days is based on the principle of drawing out a ribbon of molten glass. In both the ancient technique of blowing and turning the blowing iron, and today's method of levelling the glass on a bath of molten tin, the force of gravity makes a major contribution to giving the glass its form. The glass is drawn out like dough and then given its shape.

These technologies contrast with the ancient production of glass. Over many thousands of years the soft glass mass, only available in small amounts, was pressed into moulds. In order to produce hollow vessels, sand was placed in the mould and then, after the glass had solidified, scraped out again. Even today, glass objects are formed by pressing, or by pouring the molten material into moulds; the majority of glass vessels and – important for the development of modern architecture – glass bricks and blocks are produced in this way.

Astonishingly, the production of such a variety of different glass products is actually due to the structure of the material itself. In physical terms glass is in a solid state, but its structure is amorphous, not crystalline. We speak of a *liquid in a solid state*. At the molecular level a coherent crystal lattice is not evident; instead alternating groups of crystalline and non-crystalline molecules are seen. If we had to define the nature of glass, we would have to say

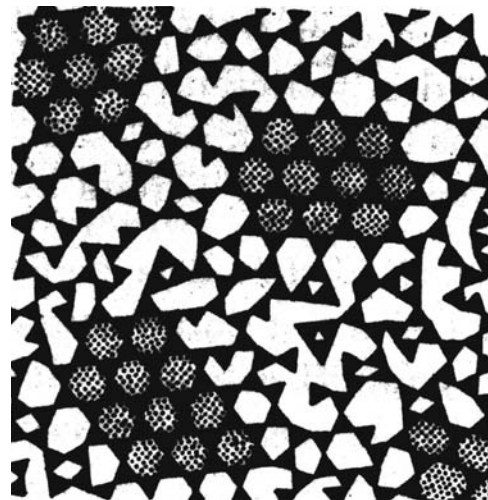


Fig. 2: Crystalline, amorphous – the microscopic structure of glass

that glass represents a dilemma. Accordingly, its use in our built environment is also Janus-like.

### Out of the earth into the fire

Glass in an amorphous state is the best way of looking at its origins. The essential components of glass are quartz sand, lime and potash or soda. The natural deposits of quartz sand appear to make the discovery by mankind as almost inevitable; but coincidence *must* have led to a mixture of the basic constituents in a fire which produced this valuable phenomena. Glass was born out of the earth through fire.

Helmut Federle, together with Gerold Wiederin, created a work in the form of the Pilgrim Chapel in Locherboden that, besides its religious significance, symbolises the origin of glass. In their monograph on this chapel, Jaques Herzog and Pierre de Meuron describe the seemingly raw glass fragments in the alcove in the rear wall as glass *in its original state*: “The pieces of glass light up in all colours: orange, green, violet, white and blue. Every fragment works as an individual lighting element. There are heavy pieces lying on top of one another, and small, delicate slivers like in diaphanous Gothic wall constructions with their intangible appearance. The light generated here is leaden and dark, light from the earth's core so to speak, from a cave, an underground gallery. Light, a blazing light, but one that is restrained with great vigour...”

The Expressionists of the early 20th century, who celebrated this new building material euphorically, promised us an all-embracing architecture with their pictorial reference to the rock crystal, an image that itself had been derived from the Gothic cathedral. Glass, as the ancient primeval material, was able to give substance to the light of the new age that was dawning.

The image of the Gothic cathedral is one of rising upwards from the earth towards God in Heaven, and the

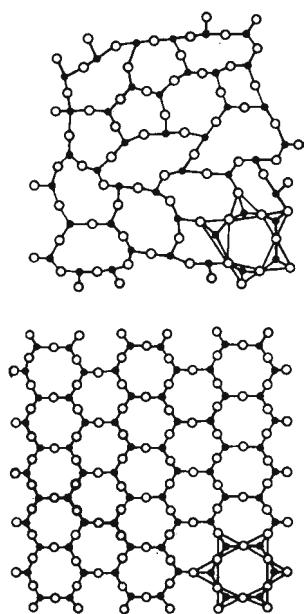


Fig. 1: Glass as a liquid in a solid state  
2D presentations of  $[\text{SiO}_4]_4$  tetrahedra in quartz glass (top) and rock crystal (bottom)



Fig. 3: Coloured glass fragments as glass "in its original state"  
Gerold Wiederin, Helmut Federle: Pilgrim Chapel, Locherboden (A), 1996

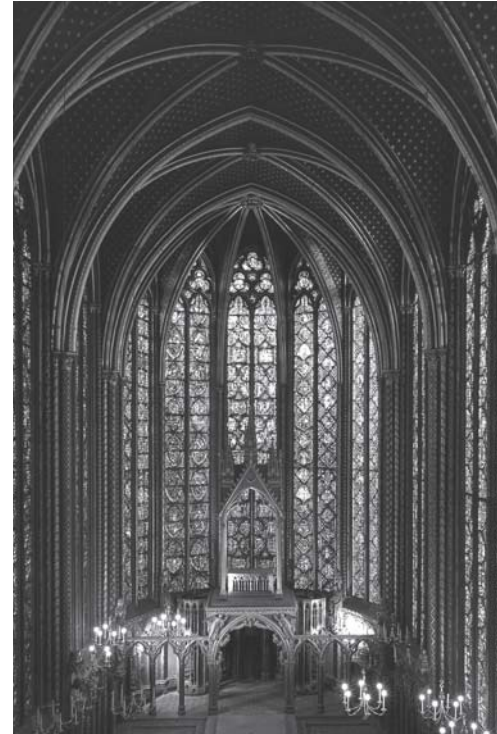


Fig. 5: Architectural use of glass  
Pierre de Montreuil (attributed): Sainte-Chapelle, Paris (F), consecrated in 1246

*architectural* use of glass is clearly visible here. The vertical sandstone structures are reduced to a minimum and the glazing gives the impression of a finer, crystallised image of the tracery framing it. We seem to be able to reach out and touch the light that penetrates the small panes of coloured glass, whereas the pointed arches of the stone structure almost crumble into the backlighting.

#### Glazed lattice, reflections

As described above, the use of glass in a church with Gothic tracery also represented an immense technological advance. Glass was being produced in huge quantities never envisaged before, and with the aid of a new technique, leaded lights, it could be made useful in the form of coherent panes. For the first time this valuable material, which so far had mainly been used as ornamentation, could establish itself as a veritable building material. The huge church windows also showed glass to be a *complementary building material* that gives the impression of a material counterweight to the massive wall. This led to the assumption that glass, like other building materials, is subject to the laws of *tectonics*. However, the tectonic relationship between the internal flow of forces and the external form, which is typical of most materials, cannot be proved to be similar in glass; for glass shows its inner workings *a priori*, or, in the words of Carl Bötticher: "The artificial shape is the core shape. This means nothing

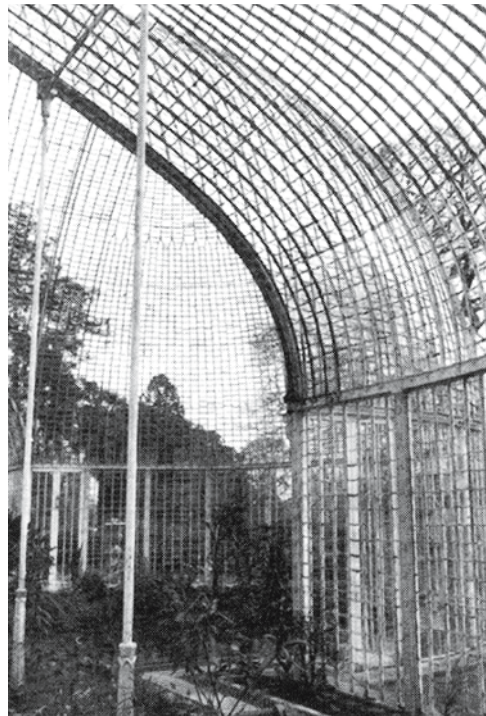
more than that glass generally adopts each shape given to it and this shape cannot be incompatible with its nature. For this reason every attempt to describe glass in tectonic terms remains metaphorical."

On a microscopic level the surface of glass is finely notched. Glass is therefore a very brittle material and can accommodate hardly any tension and due to this fact it was only used for closing openings until the advent of toughened glass after the First World War. Exceptions were the glasshouses of the 19th century, which were designed in such a way that the glass in connection with the steel structure had a *fake*, stiffening effect. Due to the fact that in the 20th century it became possible to produce larger and larger panes of glass (at first in the form of industrially produced plate glass and from the 1950s onwards float glass) the demand for large-format panes grew as well. Glass was used quasi-structurally, mainly to form huge facade areas. As a result of the increasing use of glass, the massive, architectural object started to break up and more and more its core could be enclosed by a thin, transparent skin. Architecture presented itself in a new way, in a play of sparkling surfaces.

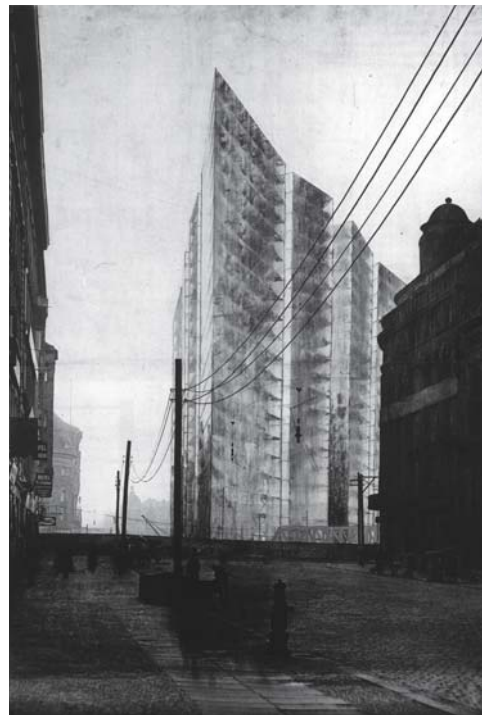
Very soon even the bracing elements of the glass facade were also made from glass. Italy, first and foremost, is famous for the huge expanses of glass that have become a popular means of expression in modern architecture. The architectural language that evolved incidentally



Fig. 4: Expressionism  
Bruno Taut: glass pavilion, Werkbund Exhibition, Cologne (D), 1914



**Fig. 6: Synthetic building envelope**  
Palm house, Bickton Gardens, Budeleigh Salterton (GB), c. 1843



**Fig. 7: Prismatic form and the play of reflections**  
Ludwig Mies van der Rohe: project for a high-rise building, Friedrichstrasse, Berlin (D), 1919

made use of tectonic metaphors. Giuseppe Terragni's draft for the *Danteum* in Rome established the – up to now still unfulfilled – ideal of a sublimated architecture: the columns of this paradise are made of glass and carry a lattice of glass downstand beams which reflect only the sky...

One characteristic becomes obvious here, the one that distinguishes glass from all other building materials. In addition to the fact that we can see through glass, the glass surface also reflects our world. Or the surface steps back from its own body and the material – despite its transparency – awakens the impression of mysterious depth. These two phenomena seem to make glass a material without characteristics.

### Science Fiction

Today, Terragni's ideal – a house made completely of glass – is conceivable from the technical point of view. Glass is no longer just for windows; it now can be produced and encoded according to specific requirements. It is quite probable that soon glass will become able to carry greater loads – through reinforcement with films or related technologies like *ceramising* – such that primary structural parts of buildings will become transparent. Since the 1950s this has been formulated and implemented on the scale of the pavilion. Taking into consideration the fact that facade technology has already formulated similar objectives, there is no obstacle to stop the construction of the

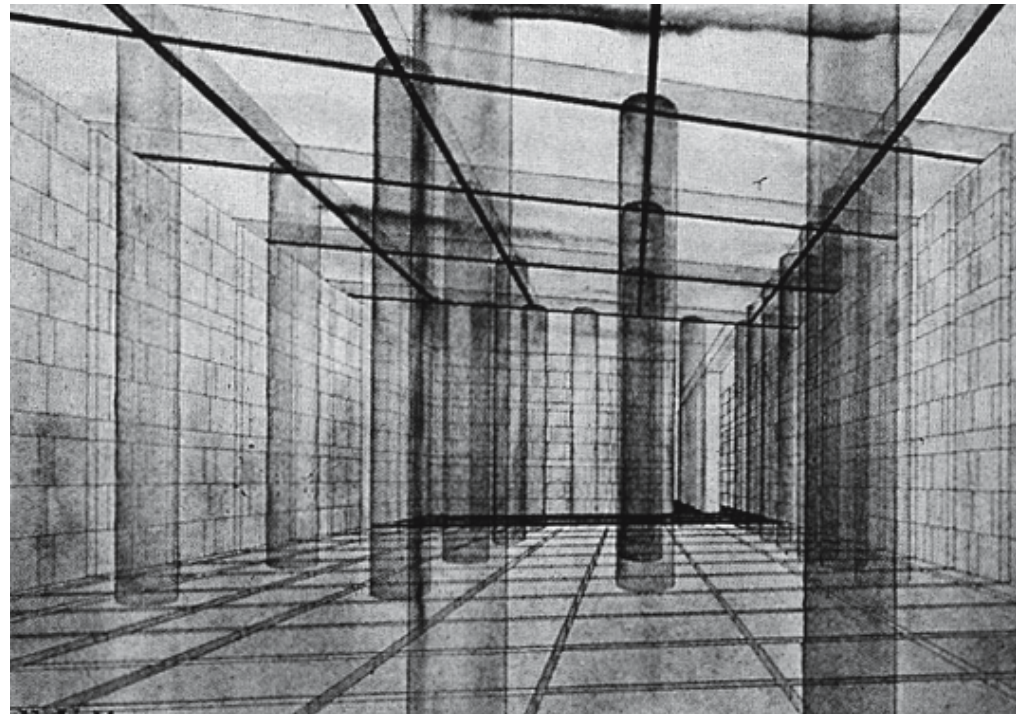
“all-glass” house. The sublimation of the building envelope will then be nearly complete. In this futuristic scenario it will be possible to realise every imaginable function of the facade with the aid of a sequence of different film layers. As glass can also direct light it might be possible to transform the building itself into an information medium, leading to a complete blurring of the boundaries between the virtual or media world and our physical world.

The total-media-experience glass building could transmit moods *unnoticed* through the optic nerve. But there is a problem: as in the movie “*The Matrix*” (1999) we would exist in a virtual space in which our needs would be seemingly satisfied while our physical environment could be truly miserable. If the “all-glass” building could be made *habitable*, e.g. by using carpets (which would be a real challenge for us architects), the futuristic scenario of total-media-experience architecture described above would itself become perverted because it would mark the end of architecture; we would be left solely with mood design, with synthetic films as information media. I can imagine a self-polymerising layer of synthetic material with corresponding optoelectronic characteristics which could be applied to any background in the form of a spray.

### The near future

Maybe there will be a new chance for the glass brick. Nowadays, glass is widely used as an insulating material in the form of glass wool or cellular (foam) glass. Thanks





**Fig. 8: Dematerialised lattice**  
Giuseppe Terragni: Danteum project, Rome (I), 1938–40



**Fig. 9: Just a pavilion!**  
Glasbau Hahn: Frankfurt (D), 1951

to modern production processes it is possible to manufacture complex building elements in several operations at acceptable prices – if architectural added-value can be marketed. So why should – from the technical point of view – a structural, insulating, shaped composite brick not be feasible?

#### Further reading

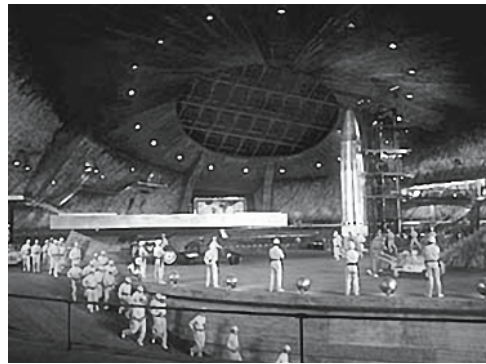
- *Archithese* 6/96 "In Glas", Zurich, 1996.
- Sophia Behling (ed.): *Glas, Konstruktion und Technologie in der Architektur*, Munich, 2000.
- Jan Hamm (dissertation): *Tragverhalten von Holz und Holzwerkstoffen im statischen Verbund mit Glas*, EPFL, Lausanne, 2000.
- Ulrich Knaack: *Konstruktiver Glasbau*, Cologne, 1998.
- Thomas Kretschmer, Jürgen Kohlhoff (ed.): *Neue Werkstoffe*, Berlin, 1995.
- Elena Re: *Transparenza al limite*, Florence, 1997.
- Spauszus / Schnapp: *Glas allgemeinverständlich*, Leipzig, 1977.
- Christian Schittich et al.: *Glass Construction Manual*, Basel, Boston, Berlin, 1999.
- Nicola Stattmann, Dieter Kretschmann (eds.): *Handbuch Material Technologie*, Ludwigsburg, 2000.
- Otto Vöckers: *Bauen mit Glas*, Stuttgart, 1948.
- Gerold Wiederin, Helmut Federle, Kunsthaus Bregenz (pub.): *Nachtwallfahrtskapelle Locherboden*, Stuttgart, 1997.
- Michael Wigginton: *Glas in der Architektur*, Stuttgart, 1996.
- English translation: Michael Wigginton: *Glass in Architecture*, London, 2002.



	<b>Foundation – Plinth</b>	<b>Wall</b>	<b>Opening</b>	<b>Floor</b>	<b>Roof</b>	<b>Stairs, lifts</b>
Introduction	Building underground	The wall	For and against the long window – The Perret – Le Corbusier controversy About the door	The doubling of the sky	The roof	Flights of fancy
Processes	Site preparation – Surveying work Site preparation – Earthworks Foundations					
Systems	Foundation schemes – Loadbearing layer inside Foundation schemes – Loadbearing layer outside		The window – opening package Position of window, opening rebate forms The window as a component – frame sections The window as a component – glass Window – horizontal section, 1:1 Window – vertical section, 1:1 Doors – types of opening Doors – types of door stop Doors – hardware		Pitched roof – Functions of layers Flat roof – Functions of layers Flat roof – Warm deck – conventional systems Flat roof – Warm deck – special systems Flat roof – Upside-down roof Flat roof – Cold deck	Excerpt from the <i>Bauelemente</i> by Ernst Neufert The geometry of stair transitions Balustrades and spandrel panels – Extract from SIA 358 Lifts
Systems in architecture	The basis for plinths		The opening as a hole The opening as a horizontal strip The opening as a joint The opening as a transparent wall		Pitched roof Flat roof The roof as a folded plate Barrel-vault roof and shell roof	The staircase as an assembly of simply-supported beams The staircase as a monolithic, organic form The staircase as a space frame The staircase as a solid timber construction
Building performance issues	External wall below ground – Influences on the building envelope		Wall – opening – Influences on the building envelope Cutting out sunlight and glare		Criteria and relationships Flat roof – Pitched roof – Repercussions for the building envelope	

## Building underground

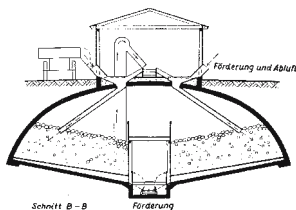
Alois Diethelm



**Fig. 1: A secret underground alternative world**  
Film set in "James Bond 007 – You Only Live Twice", 1967

Subterranean structures are all around us yet we hardly notice them – a situation that, depending on the circumstances, we find fascinating, matter-of-course or even objectionable. Because it is invisible, complete or partial lack of knowledge about an underground structure leads to suppositions about the actual conditions. We speculate about the city beneath the city as a living organism with the most diverse infrastructures, or in the form of traces of bygone times (e.g. Rome, as the result of destruction and reconstruction), and hope that "secret" structures such as fortifications and bunkers lie behind unassuming doors and hatches. At the same time, modern underground building work in Europe – and in Switzerland specifically – is an expression of a spatial expansion that attempts to preserve our familiar urban landscape. So in existing structures, whose architectural value is to be found not least in the interaction between the building and its external spaces, new space requirements are fulfilled with "invisible", i.e., subterranean, interventions. The same fate awaits those structures that are regarded by the general public as a "necessary evil", concessions to a modern way of life, e.g. basement garages.

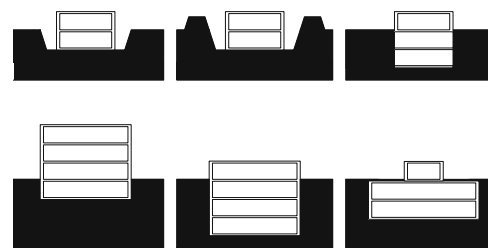
What I shall try to do here is to assign the characteristics of underground structures to various categories: on the one hand, in terms of their relationship with the topography, and, on the other, according to the applied principles of creating enclosed spaces. I shall deal with the specific conditions, options and restrictions that accompany building underground. I shall repeatedly pose the following questions: "How do we experience the subterranean world?" "Which concepts are intrinsic to this?" "Where are additional measures required?"



**Fig. 2: From outside there is no hint of the existence of a subterranean space – the vault as a structurally ideal form**  
Swedish-style potato storehouse

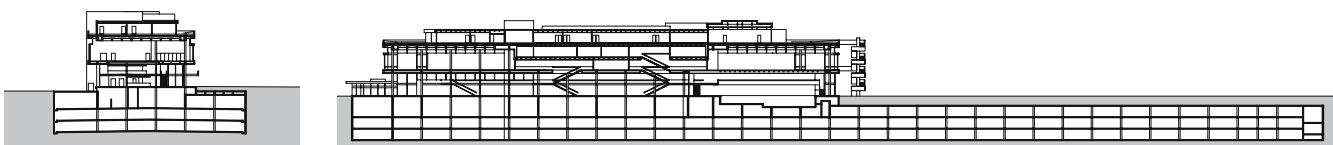
### The substructure in the superstructure

Today, in our latitudes every building activity, even those "purely" above ground, starts with an excavation. What we mean by doing this is to found the building on a frost-resistant material capable of carrying the weight of the construction. The easiest way of achieving this – and one which is linked with the advantage of creating additional space – is to provide a basement or a cellar. We dig out the ground to form a large pit and, in a first step, enable the construction of subterranean space according to the principles of building above ground. Effecting the design is the following distinction, whether the building fills the excavation completely, which means that of the sides of the excavation must be appropriately secured (e.g. timbering), or whether the building – even after completion – is positioned as an autonomous edifice



**Fig. 4: Underground building in superstructure style**  
Top (from left to right): the excavation that remains open – with the spoil used to form an enclosing wall – excavation backfilled  
Bottom: possible relationships between substructure and superstructure

detached from the sides of the excavation, and so the subsoil exerts no pressure on the walls. The latter approach enables an identical form of construction to be used for both substructure and superstructure, and simultaneously simplifies natural ventilation and daylighting issues. The substructure component in the superstructure still poses the question of the relationship between the parts above and below ground. And this concerns not only the vertical component, which manifests itself in the number of storeys above and/or below ground, but also the horizontal expansion. In other words, we have a structure that, depending on the "depth of penetration", exhibits more or fewer basement storeys, but also a basement extending over a larger area than the storeys above. What we see at ground level is therefore frequently only a fraction of the entire structure – as if it were a submarine at anchor with only the conning-tower protruding above



**Fig. 3: The internal layouts of substructure and superstructure have developed independently of each other but still use a common column grid.**  
Roland Rohn: Hoffmann-La Roche staff accommodation, Basel (CH), 1971



Fig. 5: Trees indicating the extent of the extension below ground  
Tadao Ando: Vitra Seminar House, Weil (D), 1993

the water. We can therefore assume that the majority of flat roofs are not be found on buildings but rather over apparently firm soil in the form of roads, plazas and gardens and in this way remain “invisible”.

#### The relationship with the “overworld”

Subterranean space quickly reminds us of damp grottoes with gloomy lighting conditions. But are such images still relevant today when we consider modern methods of construction and contemporary architectural briefs? Only a few forms of use that are met with underground really have to take place underground. The possible reasons for going below ground level were mentioned in the introduction; mostly, they reflect the external perception desired (streetscape/landscape). In such cases the interior gains nothing extra for being underground. On the contrary, the reduced options for admitting daylight are regarded as a disadvantage. As a result, the type of lighting and the degree of contact with the outside world, or rather the world above ground, the “overworld”, becomes a decisive criterion for contemporary subterranean structures.

Here, we see the contrast between overhead lighting through openings in the ceiling/floor above and lateral lighting through perforated walls. Interior spaces of any size may be positioned in front of these perforations – openings or walls completely “missing”. The spectrum ranges from lightwells with minimum dimensions to larger external spaces that frequently are also accessible. The relationship between these external spaces and the “overworld” fluctuates between a mere visual link and a physically usable space continuum. Points of reference such as buildings, trees and people situated within the field of vision help us to grasp the subterranean external space for what it is, whereas the physically usable connection between “overworld” and “underworld” generates an interweaving of spaces – either with the aim of bringing the surroundings down below ground, or taking the subterranean use upwards into the streetscape or landscape. In contrast to lightwells, which – as their name suggests – merely serve to admit daylight, patio-type external spaces also bring the weather below ground and counteract the feeling of confinement often associated with underground buildings. We therefore question another aspect of our experience of underground spaces: the isolation – when an interior space is perceived as being unaffected by the weather, the seasons or other events. A good example is a military bunker, whose independence is further emphasised by having its own power supply. Recording studios and rehearsal facilities that have to be cut off from the outside world acoustically, or wine cellars in which a constant climate is vital, provide further examples. The consequences of excluding the outside world are mechanical ventilation and artificial light; the latter – like the provision of rooflights – can also be regarded as intrinsic

to the nature of subterranean spaces. But this applies to enclosed spaces above ground too and, generally, to all introverted spaces, something that Pierre Zoelly demonstrates impressively with his modified sectional drawing of the Pantheon, where he continues the terrain up to the oculus. So do we need traces of incoming water on the walls in order to experience the space below ground as subterranean?



Fig. 8: A ramp links the underground entrance with the surrounding street level.  
Renzo Piano, Richard Rogers: Centre Pompidou, Paris (F), 1977

#### Topographical concepts

Detaching ourselves from aesthetic or, indeed, even ideological aspects, building underground – like any other form of building – has its origins in mankind’s need for shelter and protection. Protection from the vagaries of the weather (sunshine, rain, wind, etc.) or other people or animals. Starting with the actual relevance of these dangers and taking into account the given topographical and geological conditions, the possibilities range from caves (natural, reworked or man-made) to depressions to soil-covered elevations.

#### Caves – the solid prehistoric huts

Natural caves or crags were shelters for humans that did not require any special skills to render them habitable. The spatial experience of the solid construction was therefore a solution that was associated with the need for shelter and protection long before humans had learned to use tools to work stone. Closures made from animal skins and woven twigs and branches, frequently reusable furnishings among nomadic peoples, were additions whose technologies (e.g. woodworking) gradually evolved to become significant components of simple construction methods. If caves had to be hollowed out first, the builders chose geological situations that promised easy working, although these usually involved materials with a lower strength. Even today then in constructing galleries and in some cases caverns we still use methods in which timber or steel assemblies are inserted or slid forward in line with progress underground to support the remaining subsoil. In the simplest case this involves strengthening the surface to prevent collapse. However, in the case of loose or soft materials this can even become a temporary or permanent primary supporting structure which is

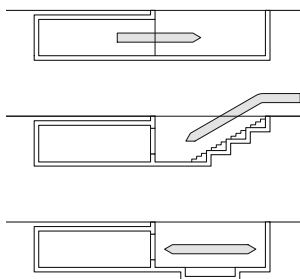


Fig. 6: Horizontal extensions  
Relationships (from top to bottom): inside-outside  
– outside-inside – centred

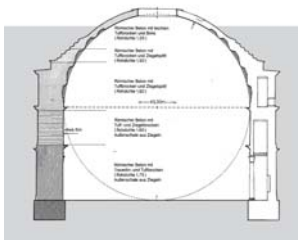


Fig. 7: Fictitious terrain build-up by Pierre Zoelly  
Pantheon, Rome (I), AD 118–28



Fig. 9: Exploiting the available topography  
Ancient amphitheatre in Stratos (GR), c. 500 BC.

replaced by or encased in a loadbearing concrete lining. Depending on the thickness of the material that separates the subterranean spaces from ground level, it is only a small step to open-cut or cut-and-cover working, in which a loadbearing structure is covered with soil only after being completed.

Basically, the cave represents that form of underground building for which the topography is only important in terms of access and, possibly, daylighting. It is frequently a by-product, e.g. in the extraction of natural resources, or is chosen because of climatic or acoustic conditions that are found only at a certain depth.

#### Depressions – a daylighting concept

Depressions can have connections to other spaces or form their own space. These latter spaces are those topographical depressions suitable for use as, for example, sleeping-places in the open air shielded from the wind – the most primitive form of human shelter. Amphitheatres, like the one in Stratos, exploit the natural, pitlike topography in order to create terracing for spectators with a minimum of reworking, with the floor of the “pit” becoming the stage, the arena. Man-made depressions

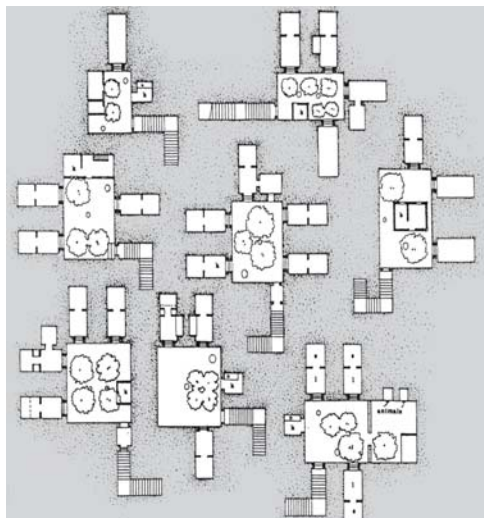


Fig. 10: Courtyards and stairs (1st floor)  
Typical village, Xi-an region, China

represent another concept for introducing light and air into adjoining subterranean interior spaces, in some cases also providing access to these. The settlements in the Xi-an region of China with their sunken courtyards are an ideal example of the multiple use of depressions: they form an entrance courtyard for the adjoining chambers, provide these with daylight and also serve as communal areas or living quarters. These generously sized, normally square depressions are, like galleries, the starting point for horizontal space development which, through further excavation, enables the creation of further rooms at any

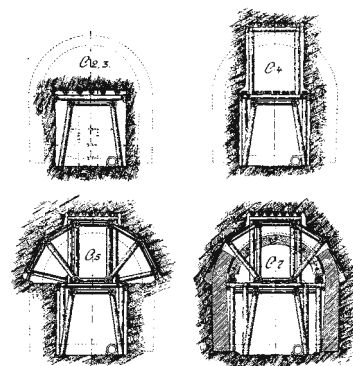


Fig. 11: Securing underground galleries with timber, enlarged upon provision of the lining

Tunnel cross-sections through Albula railway line

time. It is therefore conceivable that rooms are initially excavated on just two sides, with the other two sides being used only when the need for more space or a growing family makes this necessary.

Viewed from above, Bernard Zehrfuss' extension to the UNESCO complex in Paris is nothing other than one of these aforementioned Chinese villages. Looked at more closely, however, we can see that the principles he has employed follow different functional, structural and urban planning concepts. Whereas in China the depressions mark the start of the building process, in the Zehrfuss concept they are merely undeveloped “leftovers”. The UNESCO complex was built using conventional superstructure methods in a cut-and-cover procedure. If underground building is necessary for climatic reasons in some cases, in others it is the surrounding built environment that forces an “invisible” extension.



Fig. 12: Top: UNESCO main building, originally with an open plaza; bottom: later underground extension with courtyards

Marcel Breuer, Bernard Zehrfuss, Pier Luigi Nervi: UNESCO, Paris (F), 1958



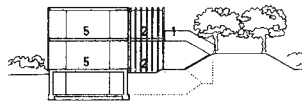


Fig. 13: Spoil used to form an embankment, as noise barrier and to provide access to upper floor  
Fritz Haller: Bellach School, Solothurn (CH), 1959

The main building, which Zehrfuss designed in 1958 with Breuer and Nervi, takes on a particular position within the urban environment: to the north it embraces the Place de Fontenay in highly contextual fashion, whereas to the east and west – adhering to the principles of Modernism – it leaves large open areas, the buildings on which form a sporadic, small-scale, random composition. The underground extension managed to preserve the volumetric relationships; however, the character of the external spaces underwent a major transformation. It is therefore wrong to say that subterranean interventions always allow the urban constellation to remain intact.

#### Elevations – man-made topography

In the examples up to now underground space was created by removing material: directly in the case of the cave, indirectly in the case of structures built in open excavations. Elevations, on the other hand, require the addition of material – in the ideal case spoil (excavated material) that is not removed from the site but instead retained for shaping the land.

Fritz Haller's Bellach School at Solothurn (1959–60) shows us the potential inherent in excavated material, not in the sense of underground building directly but rather in the form of a concept that can be applied to this. Alongside the school an embankment has been built which protects against noise and provides access to the upper floor of this building (which has no internal staircases).

A given topographical situation often invites the creation of subterranean spaces above ground level: an additional hill is added to an undulating landscape, or an existing elevation is raised. Military hospitals or reservoirs function in this way. In doing so, the reservoir, for instance, benefits from the elevated position (pressure), is less exposed to climate-related temperature fluctuations (owing to the enclosing earth embankment), and is less of a "disruption" in the surrounding rural or urban landscape. In both cases – military hospitals and reservoirs – a gently rolling meadow blurs the underlying geometry.

Besides the strategy of incoherence between inside and outside as a traditional form of camouflage, an alternating effect is desired in other cases: interior and exterior

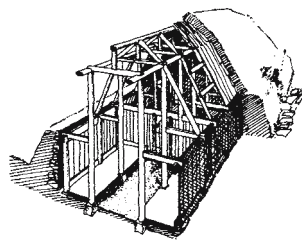


Fig. 14: Timber frame covered with peat  
Long house, Iceland



Fig. 15: The building becomes the topography.  
Bearth & Deplazes: Carmenna chair-lift, Arosa (CH), 2000



Fig. 16: Silhouette of folded roof against outline of mountains in background  
Bearth & Deplazes: Carmenna chair-lift, Arosa (CH), 2000

appearance have an impact on each other. This is very evident at the valley station of the Carmenna chair-lift in Arosa (Bearth & Deplazes). The gently undulating topography has been transformed into a folded roof form. On the entrance side the folds appear to mirror the outline of the mountain peaks in the distance. However, the longer the distance between the folds on the roof, the less distinctive is the separation between the man-made and the natural topography. The soil covering changes the folds into vaults, and on three sides the roof surfaces blend with the rising and falling terrain. On the mountain side the chair-lift itself and the opening through which it enters the interior of the "hill" are the only evidence of this artificial topography.



Fig. 17: The choice of materials and form allow the building to match the landscape.  
Skogar open air museum, Iceland

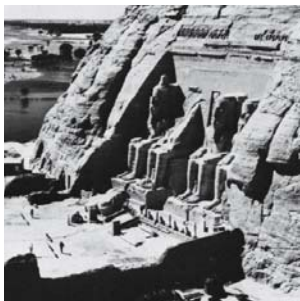
While in Arosa the fusion with the landscape was a key element in the designer's intentions, it is almost a by-product in the grass-covered peat buildings of Iceland. Owing to the lack of suitable clay for the production of roof tiles, roofs have been covered with peat since Iceland's settlement in the 9th century. Grass grows on the peat roofs and the ensuing dense network of roots forms an interwoven, water-repellent layer, which is adequate waterproofing in areas with low rainfall (approx. 500 mm p.a.). However, the durability of the waterproofing function is directly dependent on the pitch of the roof. If it is too steep, the rainwater drains too quickly, which means the peat dries out and develops cracks during periods of little rainfall. On the other hand, if the pitch is too shallow, the water seeps through. The peat also regulates the moisture level and assumes various storage functions. A simple timber roof structure (cf. steel frame to valley station in Arosa) serves as a supporting framework for the peat, which is prevented from sliding down the roof slope by the solid external walls. These "green" roofs among the gently undulating landscape look like knolls, whereas the moss-covered brown peat walls recall a geological fault. So the integration is not due to the fact that grass has been laid like a carpet over the structure, but rather through the adaptation of given conditions – the texture of the landscape as well as its rhythm. Examples can be seen in the villages in the valleys of Engadine or

Ticino, where the houses are built exclusively of stone. It is a local stone and forms, as monolithic rockface or loose boulders, the backdrop for the houses and retaining walls made from the very same stone; the transitions are fluid. The situation is very similar with Baiao House by Eduardo Souto de Moura, where the rubble stone facades on either side seem to become retaining walls for the neighbouring hillside, and the transition between roof and terrain is unnoticeable.



**Fig. 18: Interlacing of building and topography with (retaining) walls**  
Eduardo Souto de Moura: Baiao House, Baiao (P), 1991–93

If what we have here is the naturalness of man-made constructions, then it is the reverse in constructions like the Abu Simbel Temple, where at the entrance stand four figures 20 m high which were carved out of the rock, i.e., the artificiality of the natural.



**Fig. 19: The natural rockface was reworked here to create what appears to be a man-made block.**  
Abu Simbel Temple, Egypt

### Concepts for creating spaces

In the foregoing the actual construction process for subterranean structures was mentioned only as an aside. In the following I shall look at the principles for creating space – from the properties of the single room right up to the three-dimensional development of internal layouts – that arise owing to the special conditions and possibilities that building below ground level open up for us.

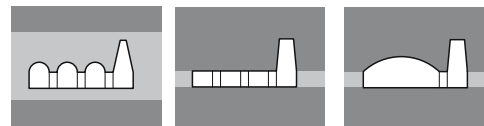
#### *Geological concepts*

The geological relationships influence the formation of space on various levels. For instance, the dissimilar properties of adjacent rock strata can steer the space develop-



**Fig. 20: Vaults in tuff stone, Naples**  
Trapezoidal (left) and elliptical (right) cross-sections as structurally ideal forms

ment in such a way that the chosen stratum is the one that can be worked more easily (e.g. soft sandstone instead of limestone). Consequently, the actual position of a space or a sequence of spaces can be defined by the economic aspects of the geology. In this case a change in the stratum may in the end form the boundary to our underground expansion; depending on the structure of the adjoining rock, however, the load-carrying capacity and the associated unsupported spans can also limit the dimensions of our underground rooms. In the simplest case we remove only that amount of the “soft” rock necessary to leave walls or pillars supporting the overlying, more or less horizontal rock strata exclusively in compression without any additional structural means. If the vertical distance between the hard strata is insufficient, we are forced to work the overlying rock into structurally beneficial shapes such as arch-shaped, trapezium-shaped or elliptical vaults or domes in order to create larger spans. Faced with the reverse situation (strata too far apart), the spatial development is subject only to the conditions of one type of rock. Of course, here again – within homogeneous geological conditions – larger spans are achieved by raising the roof.



**Fig. 21: Creating open space in solid rock**  
Left: soft rock – short spans with arches  
Centre: hard rock – short spans without arches  
Right: hard rock – large span with arch

So the architectural vocabulary can reflect the structural options, on the one hand, but can also, on the other, attest to the construction process. That might be drilled holes for jemmies, or rounded corners due to the circular movements of the human arm when removing material with a pickaxe.

The spread of “geological concepts” during the pre-industrial age was linked directly with rock properties such as ease of working and high strength. From that viewpoint, loess (a marlaceous sand) is ideal; indeed, it gave rise to a tradition of underground building in the Stone Age that is still found today, primarily in China (Henan valley). Other examples of this can be found in the Matmata region of Tunisia and in Gaudix (Granada province), Spain.

On the other hand, the creation of interior spaces within harder rock formations has only been possible with reasonable effort since the introduction of dynamite (1867) and mechanical mining methods. Admittedly, the Egyptians were constructing extensive rock tombs in the Valley of the Kings as long ago as about 1500 BC, and in the Middle Ages a number of churches were hewn completely out of rock in Ethiopia. This latter example extends

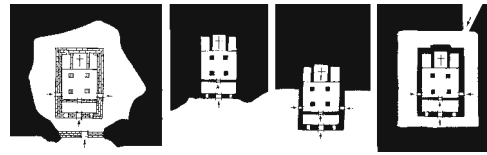


Fig. 22: Classification of Ethiopian rock-hewn churches  
From left to right: built-up cave church, rock-hewn cave church, rock-hewn monolithic church

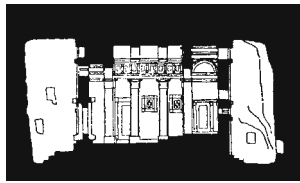
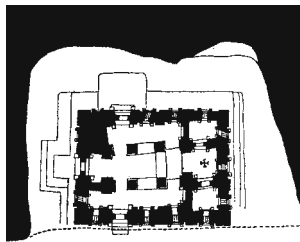
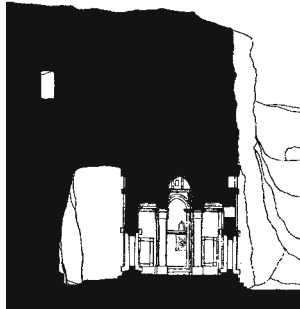


Fig. 23: A Lalibela Church, Ethiopia, c. 1400  
The rock has been worked on all sides to create monolithic walls and columns.

from hollowing out the interior to exposing the church on all sides, where the removal of material leaves monolithic walls standing which in turn support the overlying rock forming the roof. Protected by the enclosing rock formations, these churches are difficult to find, but nevertheless exhibit the sort of facades we would expect to see on free-standing churches.

Today, the working of coherent masses of rock is mainly carried out to extract the rock itself, to provide access to deposits of natural resources (e.g. coal, salt, etc.), or to remove obstacles (e.g. tunnel-building or conventional mining). Contemporary examples in which the specific properties of the rock are used directly are much rarer. One of these properties is the high storage capacity of rock; in combination with the underground location and hence the independence from the influences of daily and seasonal climatic variations this property offers temperature conditions that can be created and maintained with a minimum of technology.

This fact is exploited, for example, in the Great Midwest Underground (Kansas City, Missouri) – a subterranean cold store, warehouse and production facilities, with a floor area totalling nearly 300 000 m<sup>2</sup>. This example is mainly interesting because, in addition to the storage characteristics of the rock, its good load-carrying capacity was also exploited to the full. As with the aforementioned rock churches, the hollowing-out process produces a monolithic structure (a regular grid of pillars) that need no further strengthening.

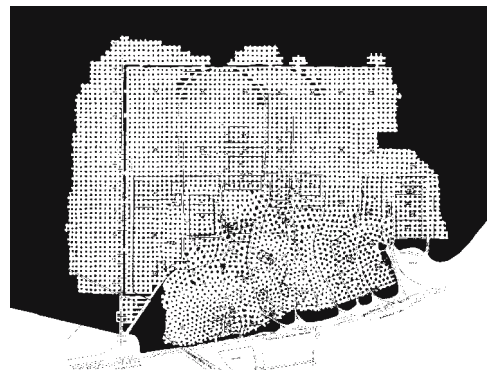


Fig. 24: Monolithic pillars measuring 7.50 x 7.50 m on 19.5 m grid  
Great Midwest Underground, started and continually expanded since 1940, Kansas City (Missouri, USA)

### Constructional concepts

One decisive factor – and herein lies a considerable difference to building above ground – is the earth pressure that acts on a substructure permanently and from several sides. In this context we can distinguish between two types of construction: autonomous systems, which can simply withstand the pressure, and complementary systems, which function only in the presence of external forces. This latter effect can be seen at the tombs in Monte Albán in south-eastern Mexico, where the slabs of rock forming the roof are not sufficiently stable without the load and the resistance of the overlying soil.

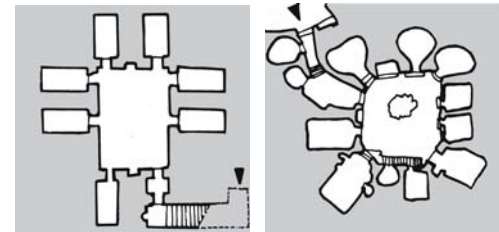


Fig. 25: The courtyard is a central element and can have almost any number of chambers on all sides.  
Left: Luoyang, Henan valley (China); right: Matmata (Tunisia)

We can divide autonomous systems further into those where the loadbearing elements have an active cross-section or active form. If the size of a component is such that it – obeying the laws of gravity – is itself stable and the horizontal forces present can be carried within its cross-section, we speak of an active cross-section. On the other hand, we can build a more slender structure when the shape of the loaded component corresponds to the flow of the internal forces (element with active form). From this point of view, vaults (cf. tunnels) are ideal structures, the principle of which can be turned through 90° to form an “arched” retaining wall. Like the wall to the tank compound at the aluminium works in Chippis, the plasticity of a series of curved shells allows us to deduce the forces that are at work. However, a shallow curvature



Fig. 26: Solid rock hollowed out to create a cold store and warehouse  
Great Midwest Underground, started in and continually expanded since 1940, Kansas City (Missouri, USA)



guarantees only their buckling resistance, not their stability. That would require additional ribs, an increase in the “rise” or a whole ring of shells. Structures with an active form are generally more labour-intensive, but require less material and render visible the forces within the structure, while structures with an active cross-section consume

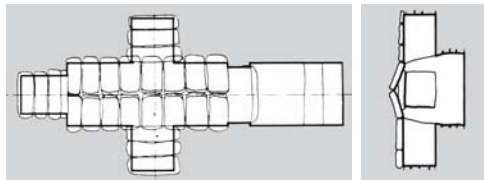


Fig. 27: Large-format stone slabs leaning against each other and wedged into the soil  
Tombs (plan and section) in Monte Albán, Mexico

more materials and “deny” the flow of the forces, but are usually easier – and hence cheaper – to construct.

Structures with an active cross-section also help to stabilise excavations, an aspect that is always relevant below a certain depth. If the area of the excavation is only small, it can be secured with a (welded) ring of walings. If the corner-to-corner distance is too great, the walings themselves must be braced. This can be done with ground anchors provided there are no adjacent buildings or underground services in the way. The walings can be omitted by increasing the number of anchors. But the reverse is also true: the anchors can be omitted if the building under construction is called upon to help stabilise the excavation. Christian Kerez's competition entry for the extension to the Freudenberg Canton School in Zurich-Enge demonstrates a very obvious concept – and one which applies generally to building underground. Initially, the plan layout seems to be rather random, but upon closer inspection we realise that this is the maximum usable area between existing structures and trees. The outline includes cranks and curved segments which appear to be elaborate and expensive. But the proposed wall of contiguous bored piles means that the geometry of the building is irrelevant because the connections between the piles always remain the same regardless of any change of direction. In other words, whether the wall is straight or curved is irrelevant to its construction.

Furthermore, walls of contiguous bored piles can carry vertical loads (in contrast to sheet piling), which means they can secure the sides of the excavation and also act as external walls in the finished structure. Kerez exploits this property and uses the main floor slab, carried by the piles, to brace the piles and thus eliminate the need for any ground anchors.



Fig. 28: Retaining wall with “arch” form to resist earth pressure  
Tank compound, aluminium works, Chippis (CH)

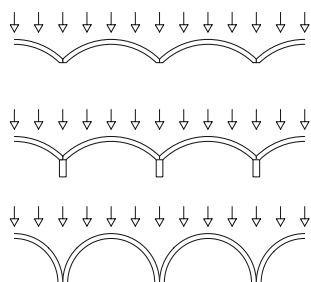


Fig. 29: Retaining wall with “arch” form  
Schematic plans (from top to bottom):  
- simple “arches”  
- additional ribs provide greater load-carrying capacity  
- a greater “rise” also improves the load-carrying capacity

### Informal concepts

Actually, building underground allows us to create “uncontrolled”, additive, rambling interior layouts because there is no visible external face. By this we mean the provision of rooms and spaces without the effects of the customary external “forces”. There is no urban planning context, which as a parameter influencing the form pre-defines a certain building shape to fit a certain plot, nor

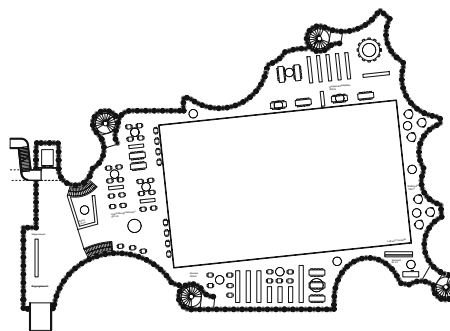


Fig. 30: A seemingly random form, but it reflects the trees and adjoining buildings above ground  
Christian Kerez: Freudenberg Canton School project, Zurich (CH), 2002

are aesthetic factors relevant, which have an influence on the three-dimensional manifestation of every project that develops from inside to outside. For there is no external form that has to be “attractive”. Despite this great design freedom, the majority of contemporary subterranean structures are simply “boxes”, and only forced to deviate from this by infrastructure (services), plot boundaries and geological conditions because economic parameters generally call for simple shapes. Projections and re-entrant corners only enlarge the building envelope and involve elaborate details. Merely in cross-section, where storey-high set-backs render a terraced excavation possible, the sides of which need not be secured against slippage (e.g. timbering, ground anchors), are such forms economic.

The term “informal concept” is an expression covering all those structures whose properties are due neither to geological nor technical/constructional parameters, but rather reflect the fact that we cannot see them. Compact boxes, rambling interiors (internal forces) and partly “distorted” containers (external forces) fall into this category. Frequently, the lack of rules is the sole rule – at least the absence of such rules that can be derived from building below ground.





## Site preparation

### Surveying work

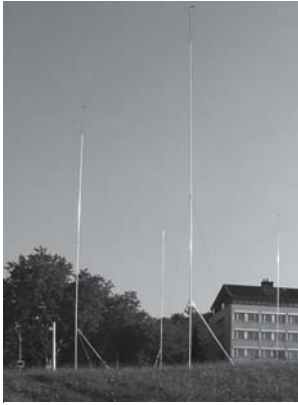


Fig. 33: Setting out a new building

#### Basic geographical data

In Switzerland digital data from the surveys done by state authorities is available for virtually the whole country. (Grid of X/Y coordinates, origin at Bern Observatory: 600 000 000 m/200 000 000 m.) Switzerland's state surveying authority bases its information on triangulation – a three-dimensional representation comprising a large number of adjacent triangular areas. The most important level of information gained from the official surveys is the real-estate details. These describe the network of parcels (plots of land). These plots are limited (surrounded) by boundary points. Boundary lines join the individual boundary points. Every element (permanent control point, boundary stone, Polygon point, anchor point, corner of building, ground cover, individual object, etc.) has been recorded numerically. This means that they are fixed using X/Y coordinates. For permanent control points the height above sea level Z is also known. The official surveys form the basis for the federal land registers.

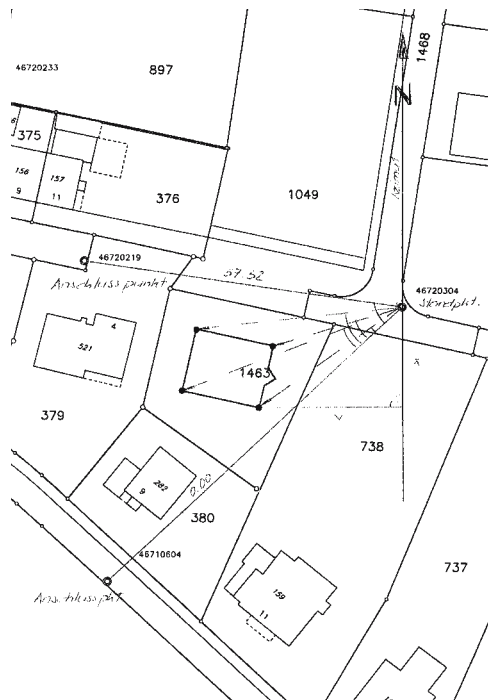


Fig. 34: Cadastral map (block plan showing parcels)  
Setting out a building with four local reference points

#### Setting-out

Once the design has been submitted to the authorities for approval, the new building must be marked out with special poles. The basic form of the building (including projections and re-entrant corners), the shape of the roof (indication of eaves at junction with facade) and, if required, the outline of any later landscaping must be readily visible.

The structure is set out starting from the boundary points (boundary lines) using the boundary clearance dimensions. A surveyor is usually called in for urban projects these days. He or she will set out the coordinates of the planned structure as calculated in the design office and drive pegs into the ground to indicate the intentions of the planners. This setting-out work takes place based on the permanent control points available from the official surveys.

The data prepared in the design office is loaded into the tacheometer (measuring instrument). The orientation on site depends on the local reference points or the church spires visible. The coordinates are called up on the tacheometer and converted into angles and distances. The tacheometer is set up at a suitable point on the site. At least two local reference points are required to complete the setting-out. The surveyor's assistant with the reflector (reflective staff, to measure distances) approaches the desired point until he or she is just a few centimetres from the target. Instead of the reflector, a peg is then driven into the ground.

GPS (Global Positioning System) methods may be used for setting-out if the horizon is relatively free of obstacles (trees, buildings). In order to calculate the exact lengths of the poles, the surveyor is appointed to determine the ground levels during the setting-out procedure. This normally represents only a little extra work. A height-above-sea-level reference in the vicinity of the new structure is helpful so that the contractor can establish the necessary levels at a later date.

Following the setting-out, the level of the base of the excavation and the angle of the sides of the excavation are determined. The edge of the excavation can be marked with loose gravel or spray paint. The contractor can then commence with the excavation work.



Fig. 35:  
Permanent control point



Fig. 36:  
Benchmark



Fig. 37:  
Boundary stone prior to installation



Fig. 38:  
Boundary stone installed

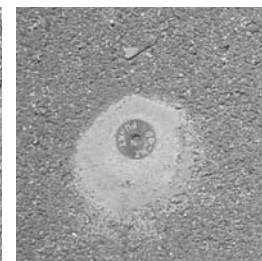


Fig. 39:  
Boundary point (pin) in pavement

## Site preparation

### Earthworks

#### Excavations

The movement of masses of soil is an activity that is difficult to predict, the details of which are normally planned by civil engineers and geologists. Using the results of a soil survey (boreholes), the anticipated quantity of material to be excavated and the strength of the subsoil can be determined. Afterwards, a decision can be made regarding the best type of foundation for the structure.

The earthworks contractor initially removes the uppermost layer of topsoil and vegetation (approx. 30 cm) with a tractor shovel and retains some of this material on site. Afterwards, the actual excavation work begins in stages. If there is room on the site or in the immediate vicinity, excavated material (spoil) is retained for backfilling at a later date because the transport of spoil is expensive and should be avoided wherever possible.

Working with the excavation plant (excavator, tractor shovel, etc.) is a skilled job; the operators have to work to an accuracy of a few centimetres.

Once the required depth has been achieved, the base of the excavation is covered with a blinding layer of lean concrete (grade PC 150, approx. 5 cm). The lean concrete provides a clean base on which to mark out underground services or the foundations. However, on rocky ground the layer of blinding may not be necessary.

The excavation should generally be about 60 cm larger than the outline of the building all round; 60 cm provides an adequate working space for the contractor. The angle of the sloping sides to the excavation (and if necessary stabilising measures) depends on the properties of the soil. The angle must also be chosen to rule out slippage or collapse and hence guarantee the safety of persons working in the excavation. Depending on the weather conditions and the hydrostatic pressure (slope run-off water or groundwater), any water must be drained away according to the regulations.

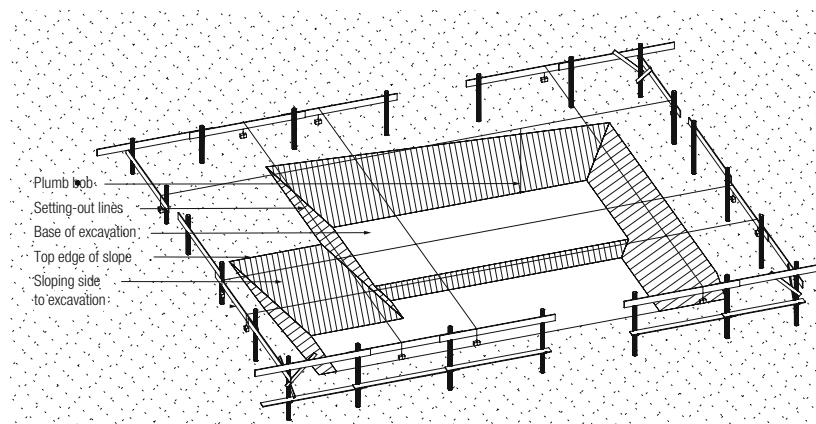


Fig. 40: Excavation with sloping sides

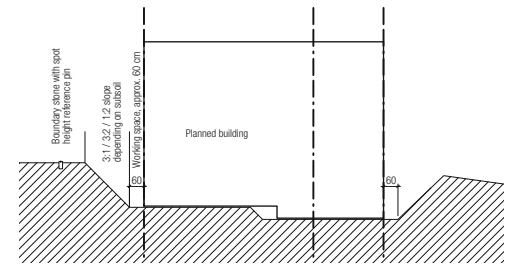


Fig. 41: Schematic section through excavation

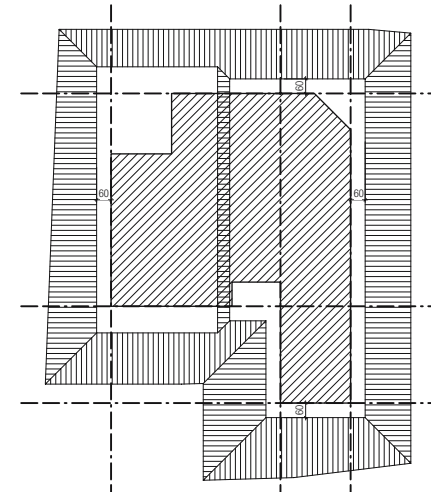


Fig. 42: Schematic plan of excavation (showing sloping sides)

#### Profile boards

Once the layer of blinding has been completed, the profile boards are set up. The main grid lines or outside faces of the structural shell are established with wires and bricks. The setting-out is the responsibility of the architect and is subsequently checked by the surveyor. By that, he or she refers once again to the existing permanent control points. The surveyor marks the building lines on the profile boards (tolerance  $\pm 5$  mm). With the help of plumb bobs the plan layout is projected onto the blinding layer of lean concrete. The location of the building is thus fixed. Work can now begin on the drains or the ground slab.



Fig. 43: Sloping sides stabilised with plastic film

## Foundations

**The brief**

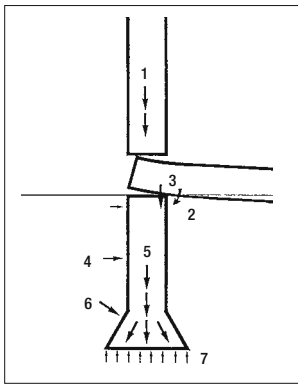
“The contact between the building and the ground determines both the transfer of loads into the subsoil and the interface with the topography... In the simplest case the foundation to a building is a direct consequence of the decisions that were invested in the constructional relationships above ground. But as soon as the terrain in the subsoil region presents difficulties due to its topography or geology, we must react to these circumstances.”

Extract from: Heinz Ronner, *Baukonstruktion im Kontext des architektonischen Entwerfens*, Haus-Sockel, Basel, 1991.

**Influences**

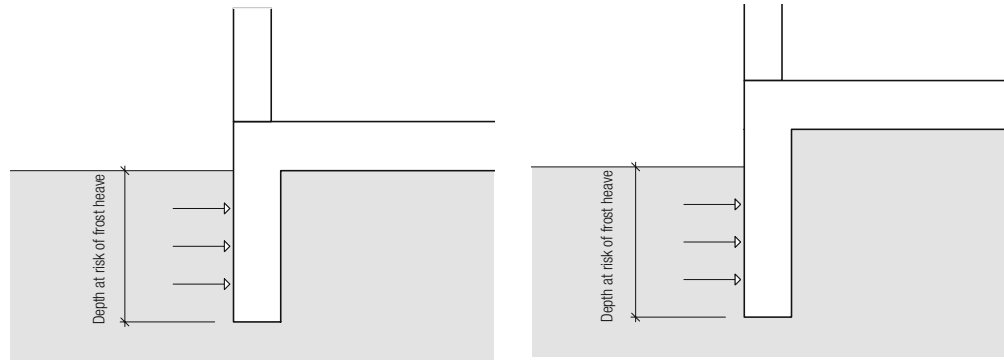
Mechanical, biological and chemical effects:

Loads	dead and imposed
Settlement	compression of the subsoil during and after the construction process
Earth pressure	forces acting (primarily horizontally) on the underground walls
Moisture	in the atmosphere (precipitation) on the ground (splashing) in the ground (moisture, frost, groundwater) in the building (vapour diffusion)



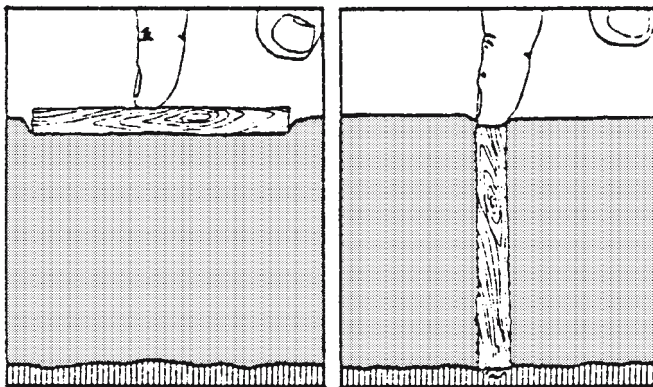
**Fig. 44: Load transfer**

- 1 Dead and imposed loads
- 2 Bending moment at floor support
- 3 Bearing pressure at support
- 4 Earth pressure, hydrostatic pressure
- 5 Foundation load
- 6 Spread of load
- 7 Ground pressure (underside of foundation)



**Fig. 45: Stem wall to provide frost protection**

No direct structural function; prevents water seeping below the ground slab within the depth subject to frost heave; up to 800 m above sea level frost line = 80 cm below surface; at higher altitudes 1/10 (i.e. 120 cm at 1200 m above sea level)

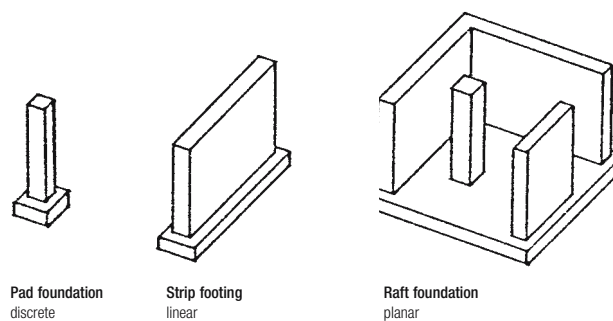


**Fig. 46: Shallow foundation**

Used when the load-carrying capacity of the subsoil is consistent; depth of foundation = “depth at risk of frost heave” (alternative: provide stem wall)

**Fig. 47: Deep foundation**

Used when the load-carrying capacity of the subsoil is inconsistent or inadequate near the surface; depth of foundation = depth of loadbearing stratum



**Pad foundation**  
discrete

**Strip footing**  
linear

**Raft foundation**  
planar

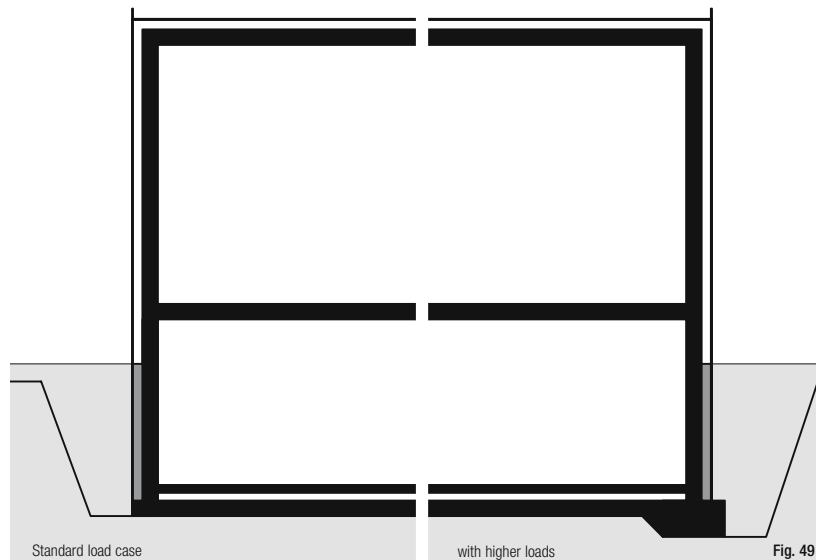
**Fig. 48: The foundations project beyond the rising structural member**

a) to spread the load  
b) to provide a firm, level base for formwork (components in contact with the soil are practically always in concrete these days)



## Foundation schemes

Loadbearing layer inside



Insulation on cold side, inner skin loadbearing (normal case)

As a rule, all “underground components” for foundations are constructed these days in reinforced concrete.

### Raft

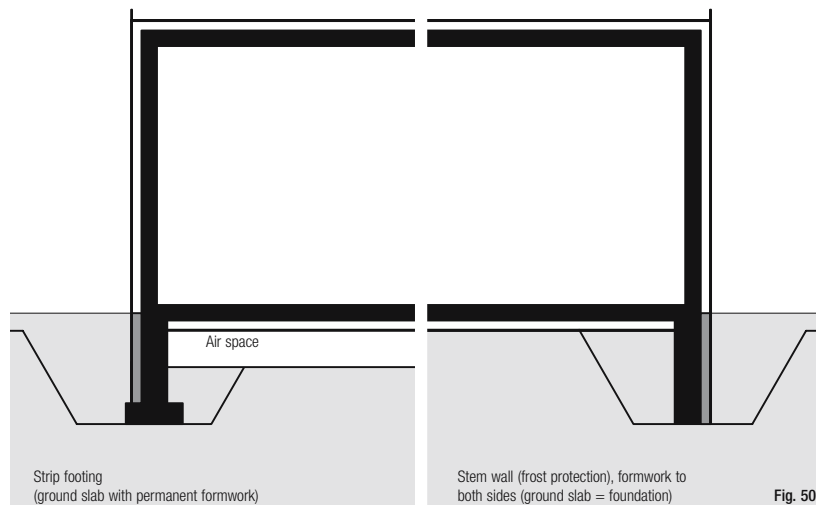
Building below ground level

Building supported on raft foundation

Thickening below walls with higher loads

Change of material from building to perimeter insulation

Problem at base of wall: thermal insulation interrupted (heated basement)



### Strip footing, stem wall (frost protection)

Building at ground level (= no basement)

Building supported on strip foundations in the case of:

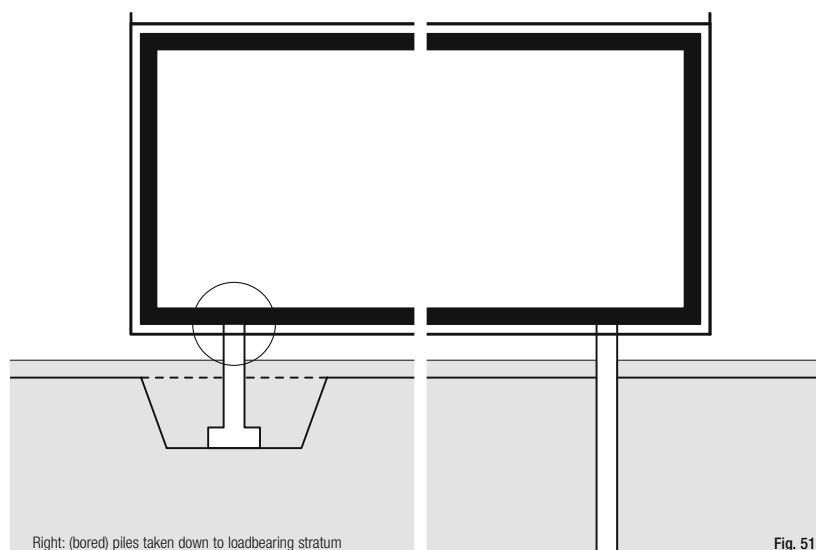
- a) loadbearing strata at lower level
- b) air space (enables floor construction without damp-proof membrane)

Underside of strip footing down to frost line

Stem wall necessary when building supported on ground slab

Change of material from building to perimeter insulation

Problem at base of wall: thermal insulation interrupted



### Individual foundations

Building above ground level

Lightweight, pragmatic architecture: e.g. protection against floods

(cf. Farnsworth House, Mies van der Rohe)

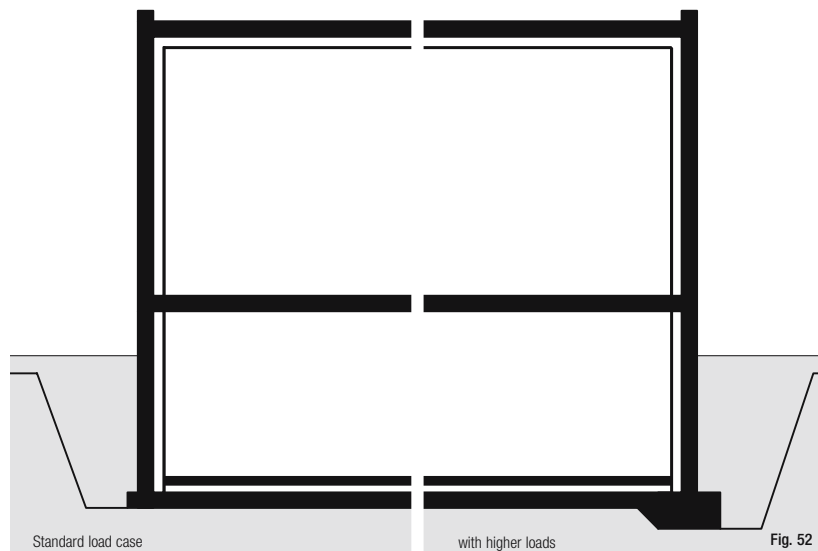
Underside of foundation down to frost line or loadbearing strata (piles)

Problem at column head: insulation penetrated

Lateral stability provided by fixity and/or wind bracing, depending on height of column

## Foundation schemes

Loadbearing layer outside

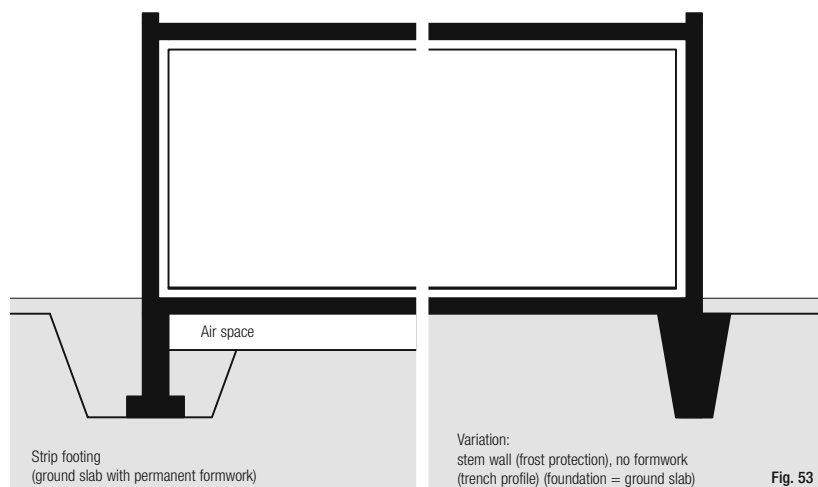


Insulation on warm side, inner skin non-loadbearing (special case in concrete or timber)

### Raft

Building below ground level

Building supported on raft foundation  
Thickening below walls with higher loads  
In concrete change of material not necessary at ground level  
Problem at floors: thermal insulation interrupted



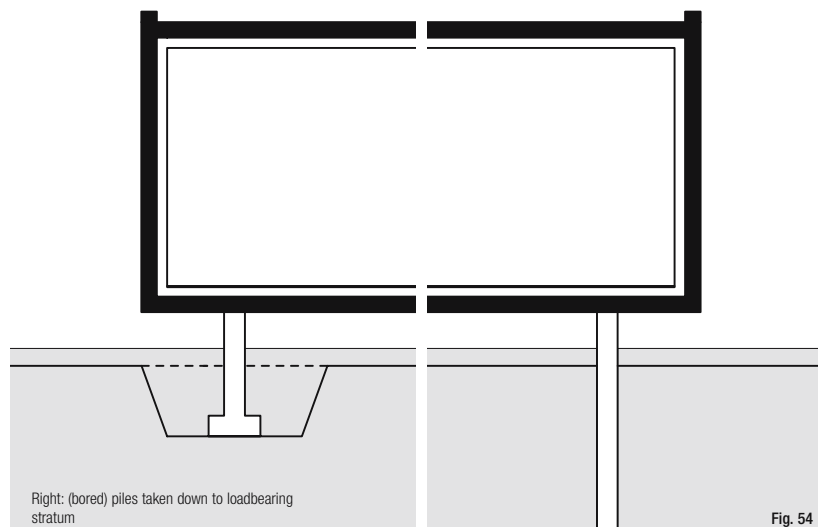
### Strip footing

Building at ground level (= no basement)

Building supported on strip foundations in the case of:  
a) loadbearing strata at lower level  
b) air space (enables floor construction without damp-proof membrane)

Underside of strip footing down to frost line  
Stem wall (frost protection) necessary when building supported on ground slab

Advantage: thermal insulation not interrupted/penetrated



### Individual foundations

Building above ground level

Building supported on columns, pilotis, piers, etc.  
Lightweight, pragmatic architecture: e.g. protection against floods

(cf. Farnsworth House, Mies van der Rohe)

Underside of foundation down to frost line

Advantage: thermal insulation not interrupted/penetrated  
Lateral stability provided by fixity and/or wind bracing, depending on height of column

## The basis for plinths

Alois Diethelm



Fig. 55: The plinth as a platform to prepare the site  
Greek temple, c. 500 BC

The “plinth” regulates the structure–terrain relationship. These days, when talking about a plinth we generally mean an independent building component with different properties to the facade, which either appears as cladding or a solid wall. But conversely we also speak about a “plinth detail” when referring to an interface with the ground “without a plinth”.

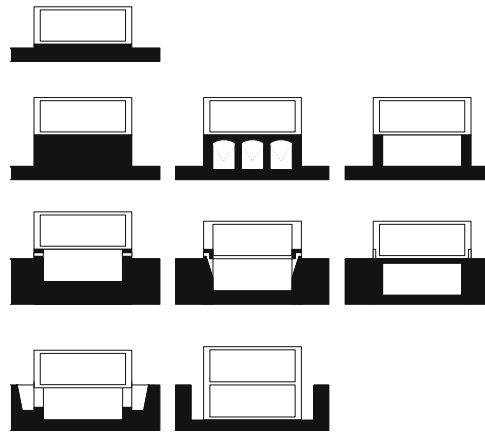


Fig. 56: Types of plinth  
From top to bottom: platform, “earth pile”, basement, box



Fig. 57: Substructure and superstructure as structurally independent constructions with the same use (residential)  
Philip Johnson: Wiley House, New Canaan (USA), 1953

### The plinth above ground

The historical development of the plinth extends from the pragmatic preparation of the building site to personal protection against external dangers (animals, weather, war, etc.), to the architectural, morphology-based apparition of post-Modernism. Hardly any other building component blends technical requirements and architectural intentions in such diverse ways, the origins of which are no longer distinct. Even in the Greek temple, whose platform is a result of the “cultivation” of the terrain, part of its power is derived from its accessibility and hence its three-dimensional conspicuousness. As it developed further, the “earth embankment” held in place by stones grew to the height of a complete storey (e.g. temple in Nîmes, 16 BC) and it was only a matter of time before this plinth was hollowed out to create usable space.

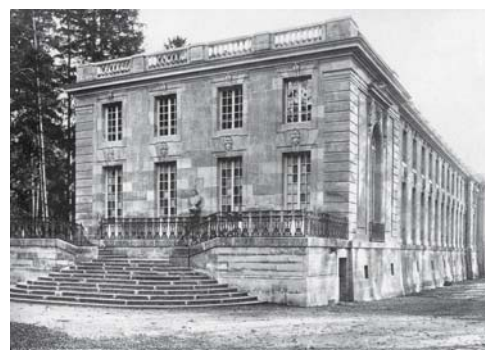


Fig. 58: Powerful structural link between substructure and superstructure with different uses (residential and prestigious versus basement)  
Hardouin-Mansart, de Cotte: Grand Trianon, Versailles (F), 1687

By the middle of the 19th century the plinth storey only remained a subject for palaces and villas, while all other buildings had normal ground floors indistinguishable from the upper floors (cf. housing in the Middle Ages). Regardless of its use (originally ancillary rooms, later also main rooms), the fortified and solid character continued up to the beginning of the 20th century, sometimes in stone (solid or just a facing) or with less expensive rendering.

### The plinth below ground

Other reasons for a visible plinth are underground rooms requiring natural ventilation options and the desire to minimise excavation, both of which led to the ground floor being raised. The basement walls grow out of the ground and appear as independent components because they generally have to satisfy different conditions from the facades above (resistance to moisture, earth pressure, etc.). Irrespective of the plinth question, the elevated ground floor is also a theme at the entrance, where the difference in levels that has to be overcome is accommodated either outside the building, within the depth of the facade, or first inside the building, in the lobby or hall. Basement walls hardly distinguishable externally are those that enclose rooms and extend above ground level regardless of the ground floor slab, and introduce light into the basement by way of hopper-shaped openings.

The lightwell functions similarly. Used as an intermittent means, the lightwell is not substantially different from the enclosing walls. To simplify construction, it is available as an add-on, prefabricated element in concrete or plastic, but the disadvantage is that the lightwell creates a hole in the paving, grass, etc., which has to be covered with a grating. Stretched to a linear element running along sections of the facade, the lightwell, provided it is sufficiently wide (1–2 m), is an excellent way of admitting daylight into basements. Basements are thus turned into habitable rooms, with the only difference being the lack of a view.



Fig. 59: A raised ground floor leaves room for a basement; natural ventilation and daylight for basement rooms, entrance formed by interruption in plinth  
Diener & Diener: Wartekhof, Basel (CH), 1993–96

### The “transferred” plinth

If the base of the lightwell drops to the level of the basement floor slab, this creates an accessible external space, an arrangement with a long tradition in Great Britain, for instance. Reached separately via an external stair, such basements are suitable as company flats or for use by small businesses. The requirements the “basement wall” has to meet are now no different from those of the facade above. With such an arrangement on all sides we obtain a “tank” in which the building stands untouched by the geological conditions and where all storeys can be constructed according to the same principles (e.g. timber engineering).



Fig. 60: Lightwell with fully habitable basement rooms  
Steger & Egender: Art School, Zurich (CH), 1933



Fig. 61: The “lightwell” here has been extended to form an accessible garden.  
Steger & Egender: Art School, Zurich (CH), 1933

### The suppressed plinth

In contemporary architecture the plinth theme is mainly relevant only on a constructional/technical level. If the topographical conditions are not conducive to the creation of, for example, a plinth storey, the structural arrangement is suppressed, sometimes at great expense. Increasingly, buildings are being seen more as (art-related) objects than as structures; but they are still built in the same way. We are mostly using the same methods as we did 50 years ago, at best with only minor modifications; the difference is that on the path to maximum formalisation they frequently ignore the “rules of architecture”.



Fig. 62: The lightwell as an indication of a basement  
Marques & Zurkirchen: Kraan-Lang House, Emmenbrücke (CH), 1994



Fig. 63: A container without an anchorage, “temporarily” parked on the grass  
Marques & Zurkirchen: Kraan-Lang House, Emmenbrücke (CH), 1994



Fig. 64: A building growing monolithically out of the hillside  
Valerio Olgiati: school, Paspels (CH), 1998

Regarding the building as an object emphasises three principles of the terrain–structure relationship: growing out of the terrain, placed on the terrain, and detached from the terrain. From the viewpoint of building technology, growing out of the terrain presents the greatest problems because the continuous, consistent “outer skin” is subjected to different requirements: weather resistance and protection against mechanical damage above ground level, moisture and earth pressure below. Homogeneous materials such as in situ concrete and render (waterproof render and/or moisture-resistant substrate) present few problems. Jointed constructions left exposed present many more difficulties: masonry, precast concrete elements and timber, sheet metal or other lightweight claddings. The weak spots are leaking joints but also the inadequate moisture resistance of the materials themselves (bleeding, rot, etc.).

On the other hand we can detach the building from the ground by employing a whole range of methods, from strip footings above ground to storey-high pilotis, and hence eliminate the “ground-related” effects. Between these two extremes we can place the building on the terrain, an arrangement which through the ground floor slab – and possibly even through a basement – clearly has the effect of anchoring the structure to the ground. However, the fact that the facade cladding stops short of the ground conveys the impression of an object placed on the ground.





Fig. 65: The difference in height on existing terrain is accommodated within the solid plinth for the timber structure above.  
Gion Caminada: factory, Vrin (CH), 1999



Fig. 68: The concrete plinth is the visible part of the excavation in which this timber building stands. Horizontal boards positioned at the steps in the concrete cover the concrete/timber junctions.  
Peter Zumthor: Gugelun House, Versam (CH), 1994



Fig. 66: Rendered thermal insulation with stone plinth  
Dolf Schnebli: apartment block, Baden (CH), 1990

### Our image of the plinth

The tendency towards a formalised object is not least a reaction to post-Modernism, the protagonists of which, with comparable technical means, attempted to create not formalisation but a nonexistent structural versatility in order to achieve the image of the traditional “building” (plinth, standard and attic storey, distinguished only by their surface textures).

Even if only in the form of cladding (just a few centimetres thick), this type of plinth is more than just a way of distinguishing the facade because such an arrangement protects the facade against soiling as well as mechanical damage.

### The unavoidable plinth

Ignoring architectural preferences, it may well be that the topography determines the need for a plinth, depending on

the type of construction. Whereas on flat ground it is still easy to suppress or reduce the plinth, on sloping ground we are immediately faced by the question of whether the difference in levels can be accommodated by forming a true plinth storey or whether the plinth should follow the line of the terrain. The former suggests storeys with different utilisation, while the latter raises structural issues: is the plinth the foundation for the facade above, and hence loadbearing, or is it a “protective screen” to ward off the problems of earth pressure and moisture?



Fig. 67: Painted concrete and ceramic tiles as protection against weather and soiling, and also providing a figurative plinth function  
Otto Rudolf Salvisberg: apartment block, Zurich (CH), 1936

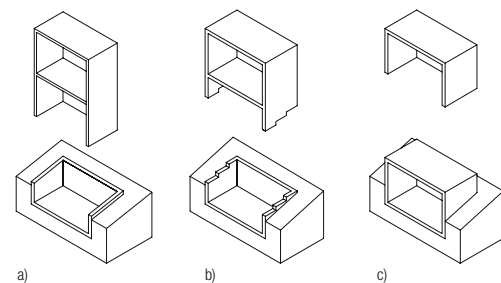


Fig. 69: Plinth forms for sloping sites

- a) Building in open excavation (“protective screen”)
- b) Building, or rather superstructure, supported on sides of excavation
- c) “Basement storey” supporting upper floor

## External wall below ground

### Influences on the building envelope

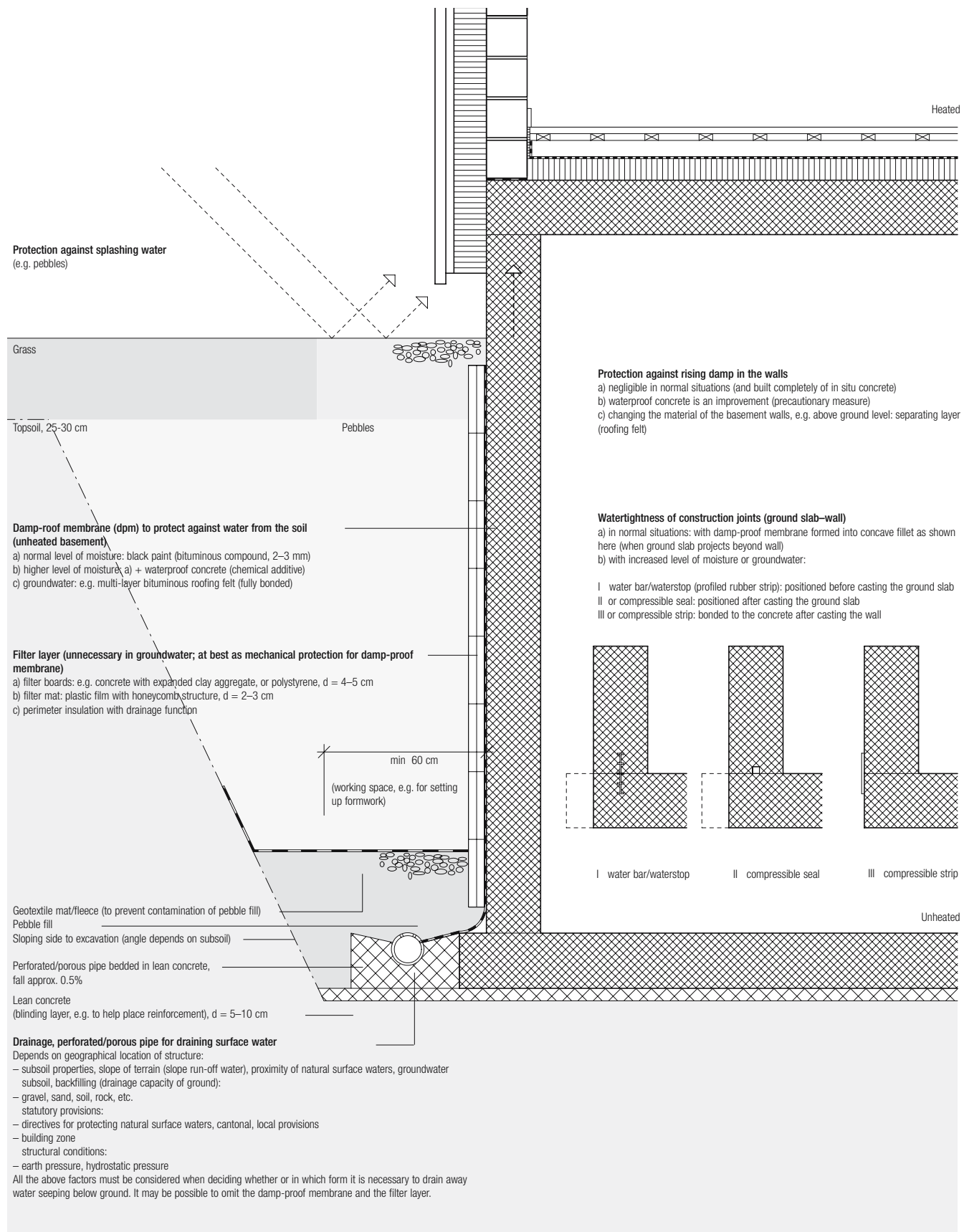


Fig. 70: External wall, scale 1:20

## The wall



Fig. 1: Erecting the original hut  
Excerpt from: Antonio Averlino Filarete: "Treatise on Architecture", Florence, Bibl. Naz., Cod. Magl. II, I, 140 fol. 5v

Cordula Seger

The wall is charged with cultural-historical significance. Popular sayings like "to stand with one's back to the wall" or "to bang one's head against a brick wall" testify to the wall being the visible boundary to a specific space, and the collective agreement to respect this artificial demarcation as binding and meaningful.

Terms are closely attached to language and can be defined only in the context of their boundaries. This means that a word's meaning is defined in context with and by being differentiated from other words and their material correlation. The wall to a room therefore is different from a piece of masonry; flat and thin, the wall possesses neither substance nor relief and thus creates no sense of depth. Contrary to this, masonry reacts on both of its sides and establishes both internal and external boundaries, here and there. As an independent architectural element it has the inherent capability to enclose and define – and thus create – space. A wall, however, is inevitably joined to a floor and a ceiling, or an underlying supporting construction, and in essence relies on the spatial transitions for its existence. In terms of these characteristics a wall belongs to the category of filigree construction (in traditional frame construction apparent as the infilling), whereas masonry is considered to be an element of solid construction. In the German language, the difference between filigree construction and solid construction, tectonics and stereotomy, is accentuated by a linguistic differentiation: "This tectonic/stereotomic distinction was reinforced in German by that language's differentiation between two classes of wall; between *die Wand*, indicating a screen-like partition such as we find in wattle and daub infill construction, and *die Mauer*, signifying massive fortification."<sup>1</sup>

According to Gottfried Semper's theory – developed in *Style in the Technical and Tectonic Arts; or, Practical Aesthetics* – the linguistic distinction between wall and masonry is of vital importance. Referring to etymology, Semper derives the German word *Wand* from *Gewand* (garment/vestment) and *winden* (to wind/coil). Semper's

classification of the arts is divided into four segments: textiles, ceramics, tectonics (according to Semper mainly apparent in timber construction) and stereotomy, and he lists the wall in the textile category. Within Semper's classification, word origin and ethnographical and developmental determinants are interdependent: "Here, once again, we find the remarkable case of ancient phonetics helping the arts by elucidating the symbols of grammar in their primitive appearance and by verifying the interpretation these symbols were given. In all Germanic languages the word *Wand* (of the same origin and basic meaning as the term *Gewand*) refers directly to the ancient origin and type of a *visibly* enclosed space."<sup>2</sup> This overlapping of language and art has significant consequences; as a basic line of reasoning it runs through Semper's whole theory. In 1860 Semper wrote of the imminence of a fruitful interaction of research into linguistic and artistic form. In Semper's opinion the term enables a more pointed discussion on what is real. In his reflections on architecture the writer Paul Valéry approaches this notion in poetical fashion, "Truly the word can build, as it is able to create, but it can also spoil."<sup>3</sup>

### Featuring the wall

Where exactly is the border between the masonry and the wall? As described above, there is a material difference between the masonry's thickness and the expanse of the wall's surface, between constructional autonomy and a corresponding dependency on other constructional elements. However, a transition of form is possible: the masonry can be transformed into the wall. This can be achieved through cladding or with a jointing technique that lends the wall a textile or at least flat appearance.<sup>4</sup> This, however, should not be understood as architectural amusement; the significance lies in the fact that a cladding of any kind generates meaning.

A thin coat of paint, for example, is all it takes to turn the masonry into the wall. In this context the discovery of the colourful Greek architecture in the second half of the 18th century had a significant impact on the architecture theory debate. It is more than the opposing camps of white elegance and restraint versus colourful exuberance. It stands for the transformation of a hitherto plastic concept into a textile one, the conversion from masonry to wall. In the first volume of their *Antiquities of Athens*, published in 1763, James Stuart and Nicholas Revett included drawings of the Palmette and the Lotus frieze they had discovered at the Ilissos Temple – both are brightly painted. In 1806 Quatremère de Quincy supported the new perception of Greek architecture in a widely acclaimed lecture. Consequently, Semper perceived<sup>5</sup> and recognised him as the initiator of this discourse.

Semper attributes the symbolic aspects of the creation of space to the wall. Visible from both inside and outside,

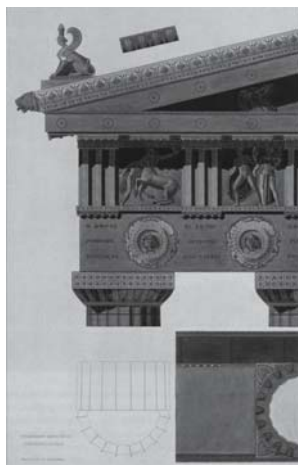


Fig. 2: Brightly painted beam in the Parthenon in Athens  
After Gottfried Semper: plate V from *Anwendung der Farben in der Architektur und Plastik*, Dresden, 1836





Fig. 3: The non-loadbearing columns are part of the wall design.

Karl Friedrich Schinkel: Friedrich Werdersche Church, Berlin (D), 1830

the ornamental envelope to a building carries and unveils the spatial and architectural expression of the construction as a whole. The wall, freed from its loadbearing function, defines the building and conveys meaning. The following quotation illuminates both the differentiation between and overlapping of masonry built for constructional purposes and a wall carrying a more symbolic meaning: "...even where solid walls are necessary, they are nothing more than the internal and invisible framework to the true and legitimate representation of the spatial idea, of the more or less artificially worked and woven assembly of textile walls".<sup>6</sup> In Friedrich Schinkel's Friedrich Werdersche Church in Berlin the symbolic aspect attributed to the wall becomes particularly obvious. The Gothic ribs visible in the nave do not have any loadbearing function, they do not meet at the centre of the vaulting, and where usually the boss should be, a gap hints at the absence of support. Here, the Gothic ribs are part of the wall lining, or rather its setting.

The central importance of the wall in the 19th century also unfolded against the background of a distinction John Ruskin established in 1849, the distinction between "building", the purely assembly aspect of construction, and "architecture", the decorative aspect.<sup>7</sup> This differentiation has its consequences. Architecture's symbolic and communicative claims are stressed as decorative added value in comparison to a solely technical implementation. Expressed more pointedly: cladding is the equivalent of architecture.

#### Of frames and the framed

In the middle of the 19th century Eugène Viollet-le-Duc developed a structural rationalism. It defined the constructional framework as a necessity. Viollet-le-Duc differentiated between primary and secondary elements: among the former, he lists the mechanics and structure of a building, whereas the latter, like walls and infilling, may be painted and decorated.<sup>8</sup> Such a differentiation incorporates architectural elements into a hierarchical structure – ornamentation and decoration are permissible only when devoid of any constructional function. Viollet-le-Duc's theory was demonstrated in a project for a house with an iron frame, whose loadbearing structure is openly visible, while the gaps are filled with enamelled clay bricks.<sup>9</sup> The topic of infilling appeared in a new light as around the turn of the last century the use of reinforced concrete in combination with a frame increased. This is the case with Auguste Perret and his pioneering use of reinforced concrete in an apartment block at 25 rue Franklin in Paris. Here, Perret formulated and demonstrated the idea of structure and infilling in the sense of frame and framed.



Fig. 4: View of building with iron frame  
Viollet-le-Duc: coloured plate from *Entretiens sur l'architecture*, 1812

It is quite telling that – according to Perret – the beginning of architecture is marked by the use of timber frames,<sup>10</sup> which in the early 20th century – thanks to the new building material reinforced concrete – was experiencing a contemporary reinterpretation. The frame defines and accentuates the framed and attributes true meaning to it. However, the frame to the rue Franklin building was not a naked concrete construction, it was also made explicit by cladding. In that respect the simple, smooth ceramic tiles were clearly distinguishable from the decorative floral motives of the infilling. The wall is given the significance of a picture enclosed in a constructional frame. It acts as a metaphor for the soft, interchangeable and perpetually changing medium in general. The infilling and its surrounding tectonic structure of construction elements are engaged in a dialogue. Only this dialogue and the discursive intensity of the discussion about the style reveals a building's character and its atmospheric intention. The dialogue defines the building's character – the richness of interrelated, interfering moods, which are able to go beyond a purely practical evaluation – and emphasises it with architecture. So the ceramic cladding enabled Perret to differentiate between the primary and secondary construction elements and at the same time accentuate the logical construction of the building as a whole. In this respect he satisfied both Semper's request for cladding that generates meaning and Viollet-le-Duc's aspirations to a hierarchic structure.



Fig. 5: Playing with variously decorated ceramic panels, view of upper storeys  
Auguste Perret: apartment block, 25 rue Franklin, Paris (F), 1903–04





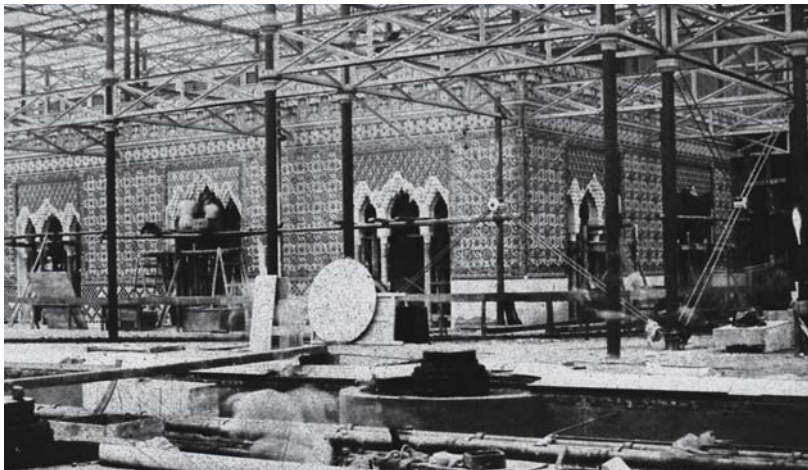
**Fig. 6: The central glass rosette above the entrance**  
 Auguste Perret: garage, Société Ponthieu-Automobiles de Paris, Paris (F), 1906–07

### The glass wall

Auguste Perret defined frame construction as a development of timber construction and tried to apply the same formula to utility buildings – as in the garage for the Société Ponthieu-Automobiles de Paris, where he, so to speak, aggrandised the principle of infilling and framing with the large central glass rosette. Contrary to this, Walter Gropius consciously tried to break away from the division into framing and infilling with his factory building for the Fagus company in Alfeld an der Leine (1911–14). Gropius placed a box-type facade of glass and steel in front of the line of the columns and – as an architectural quintessence – around the building’s corners, thus expressing the desire for transparency.

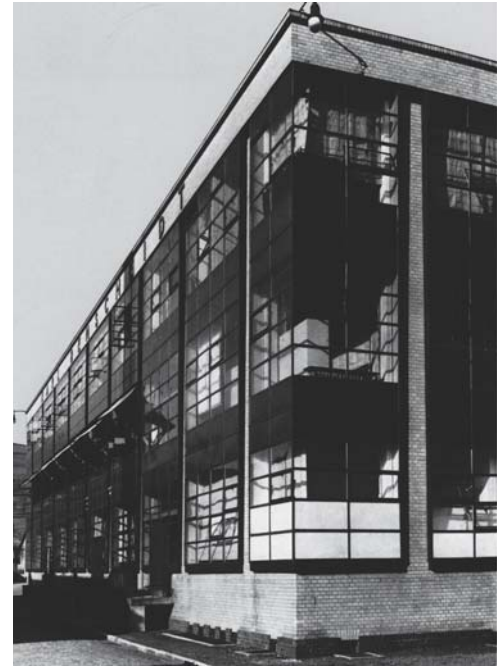
The glass wall, however, allowing an unobstructed view both of the inside from outside and vice versa, and letting the observer’s eye penetrate the surface, once more leads to the question of whether a surface can carry meaning. A transparent glass wall’s ability, or inability, to generate architectural meaning first became a relevant topic for discussion with the construction of the Crystal Palace in London in 1851. “Joseph Paxton, gardener and engineer, erected the envelope of iron and glass, whereas the decoration – in the primary colours red, yellow and blue – was contributed by the artist and architect Owen Jones. The decorative forms, and even just the coat of paint covering the iron frame, were intended – at least seemingly – to uphold the traditional functions of architecture as a symbolic expression of society as a whole.”<sup>11</sup> Interestingly, the glass infilling itself was not assigned any symbolic function – this had to be added by the architect.

The building as a container for displaying goods spectacularly – as emerged with the Crystal Palace – has continued in the form of the department store. In the years following the First World War, the use of glass curtain walls in the construction of commercial premises was developed in America. The technological prerequisite here was the



**Fig. 7: External view of Alhambra Courtyard – structure versus architecture**  
 Joseph Paxton: Crystal Palace, London (GB), 1851

development of toughened glass with better load-carrying capacities. As expressed in the term curtain wall, the glass elements hang like textiles from the edges of the concrete floors, which cantilever beyond the line of the columns. Seen from the outside, the glass facade surrounding the building is perceived as an independent skin and thus deviates from the traditional understanding of a wall existing only within a compound floor–ceiling structure.



**Fig. 8: The first curtain wall in Europe wraps around the corners to enclose the whole building.**

Walter Gropius: Fagus factory, Alfeld a. d. Leine (D), 1911–25;  
 view from south-east, condition after 1914

Viewed from the inside, the transparent glass wall virtually rescinds its ability to delimit a room not only in reality, but also symbolically. Wall and window blend into each other in the sense of a structured opening. What the contemporaries of historicism had perceived as a deficit in the Crystal Palace – that the glass envelope itself did not possess any expressive power – is seen as a quality by classical Modernism. It maintains that only “neutral” buildings allow their occupants a sufficient degree of freedom. However, classical Modernism does not refrain from charging the material with ideological meaning: glass stands for light and air, and thus for a positive openness towards the outside.

Economic interests were just as important in encouraging the use and development of the material. In the department store category, introduced at the end of the 19th century, the main issue is the visibility of the goods on display. The interior was systematically aligned towards the outside and acted as an information medium for passers-by and potential customers.

The curtain wall is exemplary for the alienation of what a wall traditionally should and must achieve. However, there were also other interesting approaches, like the effort prior to the First World War to use glass as a meaningful construction material and to intertwine the functions of wall and opening. Bruno Taut's "glass architecture", inspired by the writings and aphorisms of Paul Scheerbarth, made use of glass bricks, prisms, floor and wall tiles in order to create a differentiated interior atmosphere.

### The self-sufficient wall

In the 1920s the "De Stijl" architects amalgamated the principles of filigree and solid construction with the help of thin panels made of reinforced concrete, and elevated the wall plate to a constructional, space-generating and creative principle. Consequently, the hierarchy of primary and secondary building elements was abandoned visually.

When the wall plates are to be accentuated, colour plays a vital role: architects and artists from the "De Stijl" group painted entire walls, and the edges of the painted

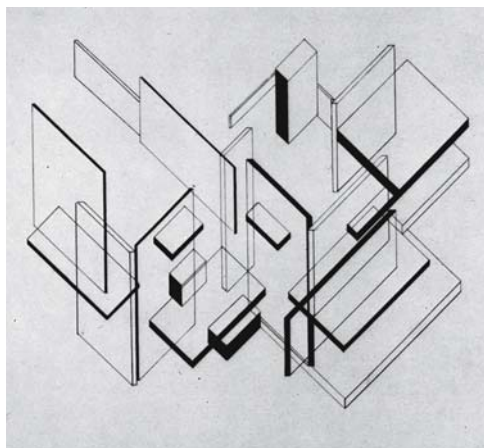


Fig. 9: The setting for the plate  
Theo van Doesburg, "Maison particulière" (in conjunction with C. van Eesteren),  
"counter construction" (*Analyse de l'architecture*), 1923, pencil and ink, 55 x 38 cm



Fig. 10: Roadside elevation showing the entrance at the side  
Gerrit Rietveld: Rietveld-Schröder House, Prins Hendrikklaan 50, Utrecht (NL), 1924

plates abutted in such a way that the volume of the building became secondary to the concept of a floating structural assemblage. Accordingly, Arthur Rüegg van Doesburg's "Maison particulière" comments: "Looking back, the use of colour, which suggests an open method of space creation, can be understood as progressive criticism of an architecture still defined by the traditional rules of structures and the enclosed room."<sup>12</sup> So while the tinted wall was designed to accentuate the abstract quality of the building and ostensibly denies its importance, it still becomes significant in a historical context through the attitude it conveys: traditional principles are undermined in order to communicate a new understanding of space.

### Intimacy and representation

The wall in the narrower sense of the word is conceived from the interior space. The one, specific space finds its delimitation here: "The wall is the one constructional element that defines the enclosed space as such, absolutely and without auxiliary explanation. The wall gives the enclosed room its presence and makes it visible to the eye."<sup>13</sup> The saying "within one's own four walls" illustrates the strong focus on the enclosed interior space.

As the influence of the middle classes started to grow in the 19th century, interiors gained increasing relevance as a venue for collective self-presentation. Walter Benjamin attributed the "enclosing" power – for which he created the figurative term "sheath" – to the lifestyle in the 19th century. The "dwelling" of a person, Benjamin writes, carries that person's "fingerprints" and can "in the most extreme case become a shell."<sup>14</sup> In the Art Nouveau period with its ideal of an interior designed coherently in all aspects, Benjamin saw a break with the idea of a room as an enclosing structure. "Art Nouveau is rocking the very foundations of the nature of housing."<sup>15</sup> Continuing this train of thought we note that Art Nouveau with its floral and organically curving motifs emphasises the flatness of the wall and directs our attention to visual effects and not to the atmosphere of the space. Accordingly, the interior was flattened to a film around 1900, and the mistress of the house, performing her duties of representation, merges, so to speak, into this surface of social projections. This interpretation is affirmed by a photograph of Maria Sèthes, who, wearing a dress designed by her husband Henry van de Valde, blends in with the room's interior, which was designed as a *Gesamtkunstwerk*. A merger between the wall decoration and the lady's housecoat takes place. Considered in a history of architecture context, this is taking Semper's clothing principle to the extreme. If the interior is perceived as a defined living space, however, the design principles of Art Nouveau are doubly restrictive towards women because the interior has been assigned as their central living space. Adolf Loos was strongly opposed to stylistic art – and he counted





**Fig. 11: The woman has been photographed in such a way that she seems to merge into the room.**

Photo of Viennese fashion designer Mathilde Fröge, c. 1905, with self-designed "Reform" dress. Ms Fröge is standing in front of a cabinet by Kolomann Moser and is wearing jewellery by Josef Hoffmann.



**Fig. 12: The clothes and wearer are part of a Gesamtkunstwerk setting.**

Maria Sèthe, wearing a dress designed by her husband, the architect Henry van de Velde, photographed in their house in Uccle near Brussels, c. 1898.

<sup>1</sup> Kenneth Frampton: *Studies in Tectonic Culture: The Poetics of Construction in 19th and 20th Century Architecture*, London, 1995, p. 5.

<sup>2</sup> Gottfried Semper: *Der Stil in den technischen und tektonischen Künsten*, vol. 1, Frankfurt/M. 1860, p. 229. – English translation: Gottfried Semper: *Style in the Technical and Tectonic Arts; or, Practical Aesthetics*, vol. 1, (Semper's emphasis).

<sup>3</sup> Paul Valéry: *Eupalinos*, Frankfurt/M., Leipzig, 1991, p. 78.

<sup>4</sup> See the essay "The pathos of masonry" by Ákos Moravánszky, pp. 23–31. The mixing of solid and filigree construction was initiated by Semper, who assumed that every well-built masonry wall represented a type of weaving due to its jointing principle.

<sup>5</sup> Gottfried Semper: *ibid.*, p. 218.

<sup>6</sup> *ibid.*, p. 229.

<sup>7</sup> The distinction between design and architecture also had repercussions for education around 1800. For example, in France the "Ecole Polytechnique", whose focus was applied technology, was founded in 1795. The growing specialisation provoked a separation between the disciplines, which has had a lasting effect on the understanding of design and architecture, and is only slowly moving towards the necessary union.

<sup>8</sup> Robin Middleton: "Farbe und Bekleidung im neunzehnten Jahrhundert"; in: *Daïdalos "In Farbe"*, No. 51, Berlin, 15 March 1994, pp. 88–89.

<sup>9</sup> See Eugène Emmanuel Viollet-le-Duc: *Entretiens sur l'architecture*, Atlas, Paris, 1864, PL. XXXVI.

<sup>10</sup> Auguste Perret: *Contribution à une théorie de l'architecture*, 1952, quoted by Frampton 1995, pp. 125–26.

<sup>11</sup> Susanne Deicher: "Polychromie in der englischen Architektur um die Mitte des 19. Jahrhunderts"; in: *Daïdalos*, *ibid.*, p. 91.

<sup>12</sup> Arthur Rüegg: "Farbkonzepte und Farbskalen in der Moderne"; in: *Daïdalos*, *ibid.*, p. 69.

<sup>13</sup> Gottfried Semper: *Der Stil in den technischen und tektonischen Künsten*, vol. I, Frankfurt/M. 1860, p. 227.

<sup>14</sup> Walter Benjamin: *Das Passagen-Werk*. Gesammelte Schriften Bd. V1. Frankfurt/M. 1982, p. 292. – English translation: Walter Benjamin: *The Arcades Project*, Cambridge, Mass., 1999.

<sup>15</sup> *ibid.*, p. 292.

<sup>16</sup> Hugo Koch: "Ausbildung der Wandflächen", in: idem: *Die Hochbaukonstruktionen. Des Handbuchs der Architektur dritter Teil*. Vol. 3, no. 3: Ausbildung der Fußboden-, Wand- und Deckenflächen, Stuttgart, 1903, pp. 101–22.

<sup>17</sup> Gottfried Semper: *ibid.*, p. 231, footnote 2.

the designs of Henry van de Velde, Secession and the Wiener Werkstätten among these. Loos harshly criticised Art Nouveau's dramatic elaborateness and promoted the idea that interior spaces have to reflect their occupant's personality and not express some arty architect's narcissistic self-complacency.

### From clothing to cladding and back

The wall's expressive powers today mostly appear to be reduced. The third volume of the *Handbuch der Architektur*,<sup>16</sup> published in 1903 in Stuttgart, dedicated individual chapters to various wall coverings – stone, paper, leather or woven fabrics – and to techniques like painting, wall-papering, incrustation, stucco, mosaics or wood panelling, and to "artistic painting". Contemporary works, however, concentrate mainly on what is intended to be hidden behind the wall.

This shift in the importance and perception of the wall is also reflected on a linguistic level: while the 1903 manual speaks – in line with Semper – of wall clothing, today only the term cladding is in use. The cladding refers to something that is meant to remain hidden or come to the surface in an altered state; thermal insulation, vapour check, air cavity, etc. occupy the space between wall and cladding.

Gottfried Semper loved role-playing, which serves as a binding convention and simplifies human interaction. To take part in a public debate he used coded gestures and images. "I believe that *dress-up* and *masquerade* are as old as human civilisation itself, and the pleasure in both is identical with the pleasure in all the activities that make humans become sculptors, painters, architects, poets, musicians, dramatists – in short: artists. Any kind of artistic creation on the one hand, and artistic enjoyment on the other, require a certain carnival spirit – if I may express it in modern terms. The smouldering of carnival candles is the true atmosphere of art. The destruction of reality, of the material, is necessary where form is to emerge as a meaningful symbol, as an independent creation of man."<sup>15</sup> Semper's fondness for carnival was countered by Modernism with its moral request for sincerity, which led to a decline in the fullness of expression. It was left to post-Modernism to rediscover the communicative potential of the wall and combine the principles of clothing and cladding.



**Fig. 13: Entrance beneath fascia of marble and grey granite. The motifs are reminiscent of the early Renaissance and emphasise the central transition to the building.**

Robert Venturi, John Rauch: Gordon Wu Hall, new common rooms for Butler College, Princeton University, New Jersey (USA), 1980

## For and against the long window

### The Perret – Le Corbusier controversy

Bruno Reichlin

“Mr Auguste Perret reports on the architectural section of the *Salon d’Automne*.” That was the headline used by the *Paris Journal*<sup>1</sup> for an interview with Auguste Perret on the section dedicated to “Architecture and Town Planning” at the *Salon d’Automne* (1 Nov to 16 Dec 1923). According to journalist Guillaume Baderre, this section in particular evoked great curiosity among the visitors: “Some people greeted our young architects’ bold designs with great enthusiasm, others were genuinely shocked, but nobody was indifferent... First and foremost, the numerous models<sup>2</sup> by Messieurs Le Corbusier and Jeanneret sparked off controversial debate. These architects employ a new and outstanding technique that throws all traditional rules overboard.”<sup>3</sup>

This interview gave Perret the opportunity to launch a direct and quite malicious attack on Loos, Le Corbusier, and Jeanneret. The arguments brought forward by “our avant-garde architects”, as Perret mockingly called

them, were redirected towards themselves. According to Perret they were cultivating a new formal academism that closely resembled the one they pretended to oppose and was likewise totally insensitive to the functional aspects of residential living. Perret contended that “for the benefit of volume and wall surface, these young architects repeat the very mistakes that in the recent past were made in favour of symmetry, the colonnade, or the arcade... They are bewitched by volume, it is the only issue on their minds, and suffering from a regrettable compulsion they insist on devising combinations of lines without paying attention to the rest.” Perret continued with his accusation thus: “These *faiseurs de volume* [creators of volume] reduce chimneys to pathetic fragments that no longer allow the fumes to disperse. They do not even refrain from eliminating the cornices and consequently subject the facades to exposure and rapid decay... This complete denial of all practical principles is simply amazing.” And this, Perret furiously concluded, “is especially obvious with Le Corbusier of all people, an architect representing the principle of practicability *par excellence* – or at least pretending to represent it.”

The criticism of Perret that sparked off the most far-reaching consequences was directed, as will soon be revealed, at the form of the openings in the wall surfaces. And it was this criticism that prompted a passionate response from Le Corbusier. In the course of the ensuing controversy between Perret and Le Corbusier, two diametrically opposed positions were defined.

In addition to the purely technical and aesthetic arguments, two contrasting conceptions of residential living came to be established – or even of two cultures, if the term culture is defined in its broadest, almost anthropological sense. But let us look at the contradictions in question – meticulously and chronologically. During the interview, Perret kept referring to the contradiction between form and function within Le Corbusier’s architectural framework of ideas: “The function necessitates the form, but the form must not supersede its function... However, we see in Le Corbusier’s work a tendency to use clusters of windows to achieve volume, which leaves large wall areas in between completely blank; or, on an artistic whim, he constructs awkward window shapes, windows with an excessive horizontal elongation. From the outside this may make an original impression, but I fear that from the inside the impression is much less original because the result is that at least half of the rooms are without any natural light, and I believe this is taking originality too far.”

This criticism cut Le Corbusier to the quick. Deeply insulted, he retaliated twice in the same *Paris Journal*: “A visit to Le Corbusier-Saugnier”, undertaken once more by Baderre (“the other side must also be heard”), published on 14 December 1923, gave him the first opportunity for a riposte:<sup>4</sup>



Fig. 1: Franz Louis Catel: Schinkel in Naples, 1824



Le Corbusier admitted that he was dismayed by Perret's lack of loyalty – a colleague after all – and accused him of publishing not only insulting but factually incorrect arguments against him. After cursorily touching on the criticism regarding chimneys and missing cornices, he directly addressed the question of the openings: “And here is the final insult from Mr Perret: my windows don't let in enough light. This accusation really infuriates me as its falseness is more than evident. What does he mean? I strive to create well-lit interiors..., this is my prime objective, and this is exactly why the external appearance of my facades might seem a little bizarre in the eyes of creatures of habit. Mr Perret upholds that I intentionally create bizarreness. Exactly –‘intentionally’. But this is not for the sake of the bizarre itself, but in order to allow a maximum of light and air into my houses. This so-called whim is nothing else than my wish to comply with the occupants' most elementary needs.”

In the *Paris Journal* of 28 December 1923, there was another contribution from Guillaume Baderre, entitled “Second visit to Le Corbusier”.<sup>5</sup> This time the journalist voiced his own opinion. He takes Le Corbusier's side and sums up all the arguments in favour of long windows, and anticipates all the papers and lectures that later made it popular. In short, the traditional vertical window is the result of outdated construction standards (stone and brick). These windows were limited in width and required massive walls. The enlargement of the window surfaces in prominent buildings thus necessitated a disproportionate increase in height – both for the openings and the rooms they serve. The use of reinforced concrete, however, allows for greater spans, wider clear openings, a significant reduction in the supporting elements – and thus the long window. “This [window] is much more practical,” Baderre wrote, “because it admits more light into a room even if its area is the same. In fact, its shape focuses all the incoming light at the occupant's eye level. With windows of the old type, about half of the light is lost. Of course a room's floor should be well-lit, but the greatest amount of light should occur in the middle of the room, in its most vivacious part, i.e. between the heads and feet of its occupants.”

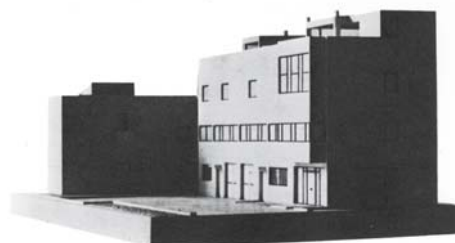


Fig. 2: Le Corbusier: La Roche-Jeanneret House, Paris (F), 1923

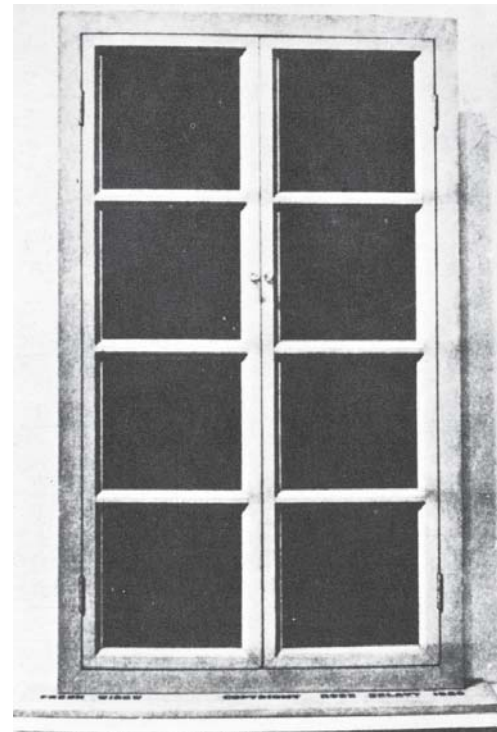


Fig. 3: Marcel Duchamp: “Fresh window”, assemblage, 1920

What made Baderre's article particularly significant, however, was the simultaneous publication of the first sketches – floor plans and general views – of the small villa in Corseaux on the banks of Lake Geneva, which Le Corbusier and Jeanneret designed for the architect's parents.<sup>6</sup> The plan for this little house was a real challenge for Perret. “Only one side of the house has a real window, but this window occupies the whole width of the facade.” Despite its being the only one, Baderre continued, the window sufficiently illuminates the whole living space because “not only its dimensions admit enough light, but at both ends it meets the adjoining side walls at a right-angle. These white walls direct the view straight towards the scenery outside, unobstructed by window reveals. They are truly flooded with light.”<sup>7</sup> Perret had hardly uttered his verdict – and through him as a mouthpiece the “institution” (“a true authority in the field of architecture”, Baderre had written in deferential regard, with Le Corbusier echoing ironically in a biting letter to Perret that “an Olympic god is about to speak”<sup>8</sup>) – when Le Corbusier reciprocated with a work that virtually lent the disputed object the character of a manifesto. Even in this booklet, published 30 years after the construction of the house on Lake Geneva, Le Corbusier did not hesitate to describe the long window as “the main protagonist of the house”, or even “the sole protagonist of the facade”.<sup>9</sup> Whereas, up until then, the discussion on the pros and cons of the long window seemed to revolve mainly around “technical” aspects – direction of the light, constructional

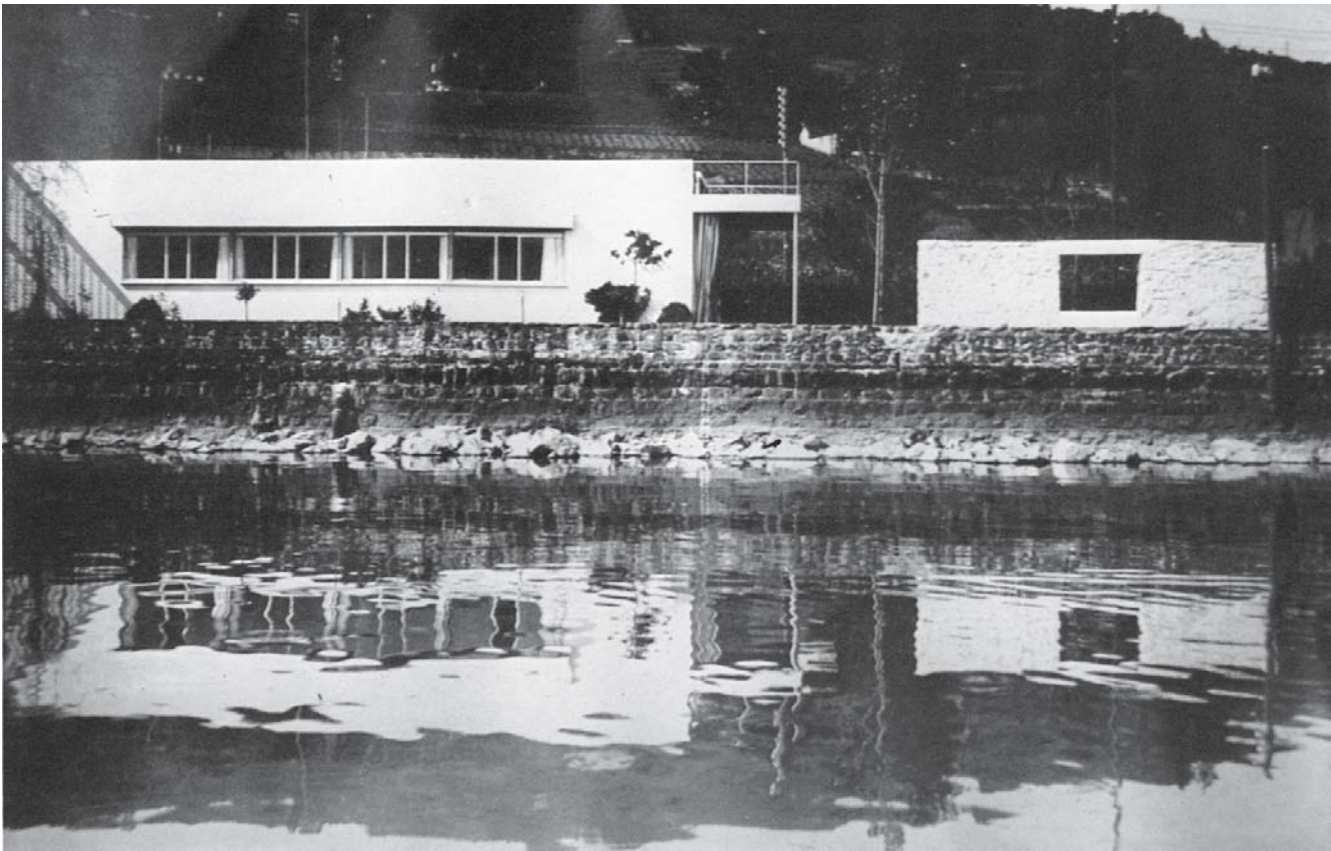


Fig. 4: Le Corbusier and Pierre Jeanneret: small house in Corseaux on Lake Geneva, Vevey (CH), 1923

options, savings in space – something quite different was now cooking in the pot: Le Corbusier's aim was to work the long window of the *petite maison* into his continuing controversy with Perret. And, not surprisingly, the discussion was rekindled six months later when Perret built his "Palais de Bois" art gallery. In the *Almanac*, Le Corbusier describes the *petite maison* and then once more returns to the dispute under the title "Brief contribution to the study of the modern window".

On two successive pages Le Corbusier juxtaposes a photograph showing a panoramic view of the lake as it can be enjoyed from the window and a sketch showing Perret seated in an armchair in front of the *fenêtre en longeur* which illuminates the bar of the "Palais de Bois". The sketch depicts the circumstances of an encounter between Perret, Jeanneret, and Le Corbusier. Perhaps out of spite the draughtsman shows the walking-stick of the venerable master pointing straight at the long window. Pleased about having "caught" Perret sitting peacefully in front of the building's sole long window, Le Corbusier congratulated him – "very pretty, your long windows" – and expressed satisfaction at the discovery that the old master, too, is employing this type of window. Perret, for his part, did not react to this humorous allusion, but returned to the attack: "Actually, the long window is not

a window at all. (Categorically): A window, that is man himself!" And when Jeanneret stated that the human eye can only capture a horizontal view, he dryly retorted: "I detest panoramas".<sup>11</sup>

When Perret claimed that a window was "like a human being" he did so because he recognised an anthropomorphic analogy. In his book on Perret, Marcel Zahar elaborated on this: "The vertical window gives man a frame in line with his silhouette...., the vertical is the line of the upright human being, it is the line of life itself". Behind Perret's convictions lies a cultural framework of ideas, documented through centuries of pictorial and literary tradition and still valid today. How not to be reminded of the first verses of the second and fifth poems from Rainer Maria Rilke's cycle "The windows":<sup>12</sup>

*N'es-tu pas notre géométrie, fenêtre,  
très simple forme  
qui sans effort circonscris  
notre vie énorme?*

*Comme tu ajoutes à tout,  
fenêtre, le sens de nos rites:  
Quelqu'un qui ne serait que debout,  
dans ton cadre attend ou médite.*



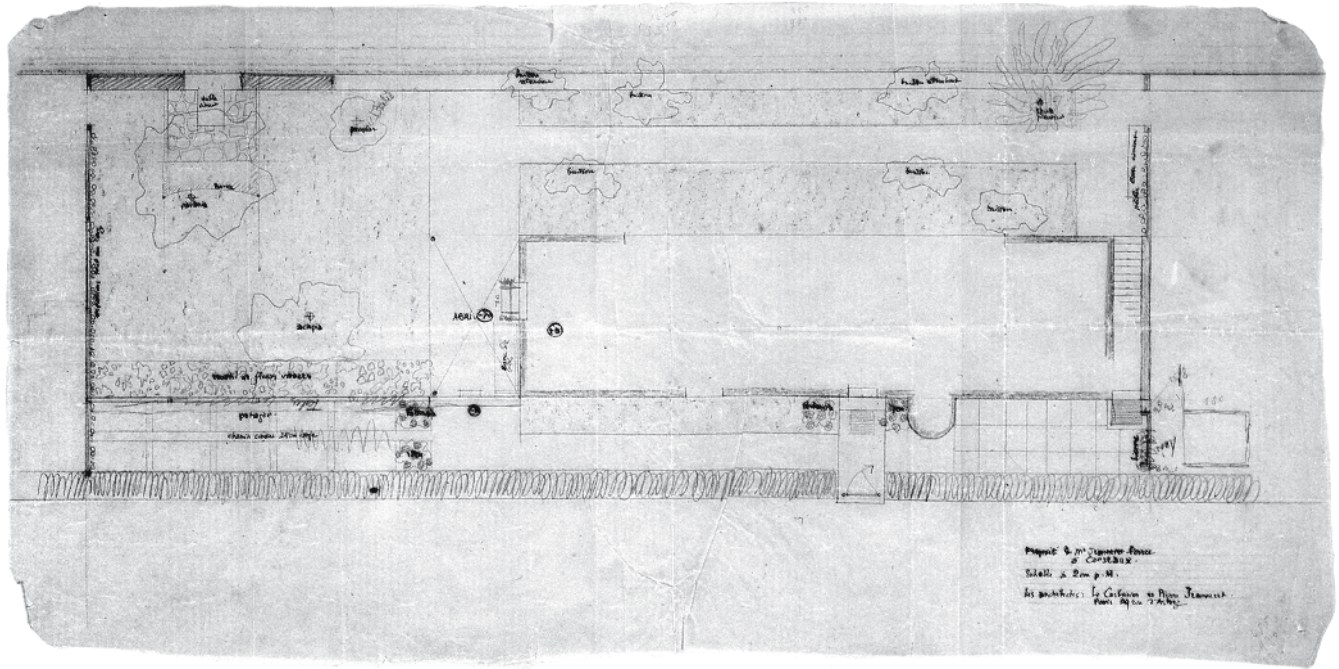


Fig. 5: Le Corbusier and Pierre Jeanneret: location plan for small house in Corseaux, Lake Geneva (CH), 1923

Perret was opposed to long windows because for him they indicated a momentous change, a change that questioned the values deeply rooted in culture, especially in the “experience” of the interior. And this is probably why he believed that Le Corbusier was “destroying the beautiful French tradition”.<sup>13</sup>

The traditional window opens up the inside towards the outside; at the same time, however, the window defines the space and acts as a threshold, “excluding” in a physical as well as a figurative sense. Whereas the long window “condemns us to look at an eternal panorama”, Perret observed, the vertical window is a stimulant “as it shows us *un espace complet* [a complete space]: street, garden, sky”. But what matters most is that these openings can also be closed.<sup>14</sup>

According to Le Corbusier the long window – in contrast to the traditional window – was acting as a mediator between inside and outside because the opening itself cancels both the threshold and its own boundaries. And this is the true meaning of the photograph of the long window at the *petite maison* published in the *Almanac*, a photograph in which everything that constitutes the physical elements of the building diffuses into an indistinct, dark background, a framework that allows the euphoric picture of “one of the world’s most beautiful panoramas”<sup>15</sup> to emerge. “The scenery is right there – it is just like being in the garden”.<sup>16</sup> Whereas the traditional window limits the view to a section of the continuum of the landscape, thus “manipulating” it by giving it the aura of a *veduta*, the long window is answering the request for “objectivity”

– one of the main goals of “Modernism” and “purism”: to depict the scenery as it is. “The window with its length of 11 metres allows the vastness of the outside world into the room, the unadulterated entity of the lake scenery, in stormy weather or brilliant serenity”.<sup>17</sup>

But is it true that a long window does *not* manipulate the view? Perret contended that the vertical window (in other languages not just by chance called a “French window”) renders a complete “three-dimensional impres-



Fig. 6: Le Corbusier: lighting sketches, 1923

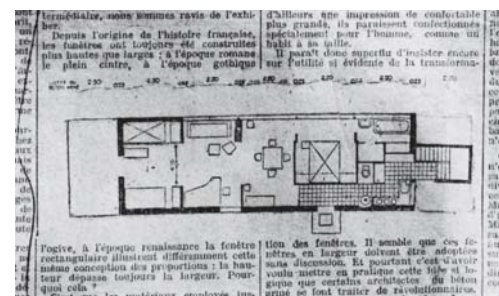


Fig. 7: Article about the small house in Corseaux by Le Corbusier and Pierre Jeanneret  
Excerpt from *Paris Journal*, 28 December 1923

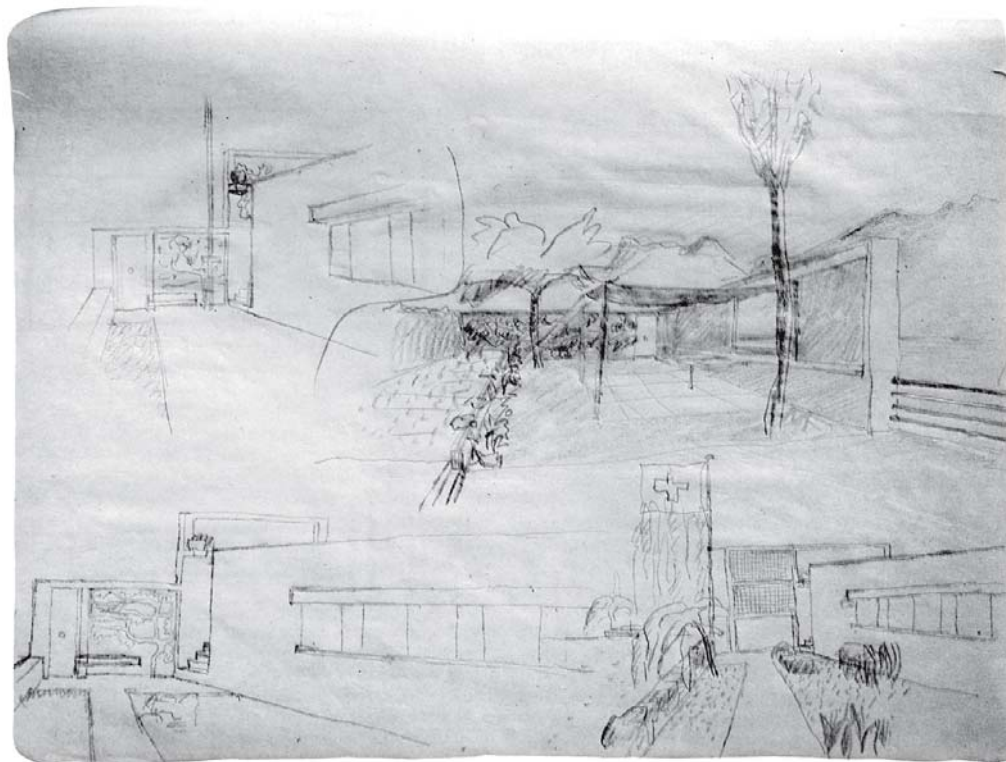


Fig. 8: Le Corbusier: sketches for the small house on Lake Geneva, 1923

sion” because it allows a view of street, garden, and sky. Marie Dormoy, Perret’s faithful supporter, elaborated on this: “A window in the form of an upright rectangle makes a room much more cheerful than a horizontal one because this form permits a view that includes the foreground, the most colourful and vivacious segment of a view.”<sup>18</sup> This comment reminds us of the particular preference for the window picture that dominated the world of painting from the days of Romanticism through to our times, and the important role it played in the development of the modern picturesque interior. The vertical window allows the eye of the observer to wander downwards to the first and nearest spatial levels – street and garden – and horizontally to the middle and deeper levels – houses opposite, trees, hilly background – and upwards into the unlimited expanse of the sky. The vertical window shows a pictorial cut-out of maximum perspective depth as well as great variety and gradation in terms of dimension, colouring, and brightness. But it is also an ideal conveyor of manifold atmospheric impressions: the perception of the immediate and familiar surroundings creates a feeling of quiet and calm, and looking out from the elevated position of the window provides the necessary detachment and the discretion of seclusion.

“The view from the window is one of the privileges of house-dwellers, mainly the middle classes, as they live in

apartments in the towns and cities... The window is... a place of silent monologue and dialogue, of reflection on one’s own status between the finite and the infinite.”<sup>19</sup> It is obvious that Perret prefers the vertical window for the very same reasons that painters are fascinated by the window as a motif.

The window motif is also an important experimental field in modern painting. This happened at the very latest when artists more or less consciously turned away from the painting as a peep-show, thus questioning the principle – which goes back to the Renaissance – that claims any painting in the original sense is a “window picture”. “In order to force all elements of a painting into the picture’s frame”<sup>20</sup>, painters gradually withdrew from the absolutisation of linear perspective, renounced the space of aerial perspective, and stopped rendering the tactile – and later the apparent materiality of the subject. Painting also abandoned the absolute colour of the object and the relative apparent colour as well as graphic detail and the exact rendering of anatomical and perspective proportions.

As far as the window motif and its role in these drastic sublimation processes is concerned, J.A. Schmoll, known as Eisenwerth, drew the conclusion that “the window motif in the paintings of the 19th and 20th centuries has paved the way for an understanding of a purely two-dimensional,



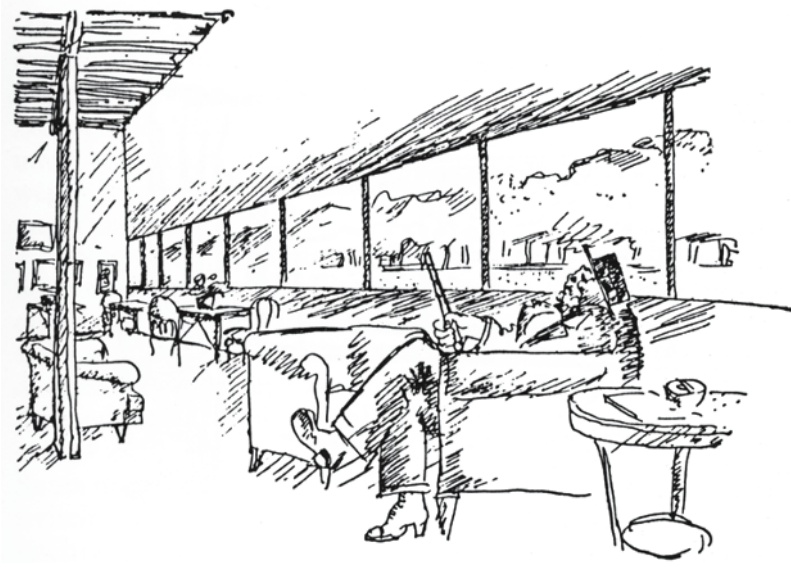


Fig. 9: Le Corbusier: August Perret seated in an armchair in front of the long horizontal window (*fenêtre en longueur*) of his art gallery, the "Palais de Bois", 1924

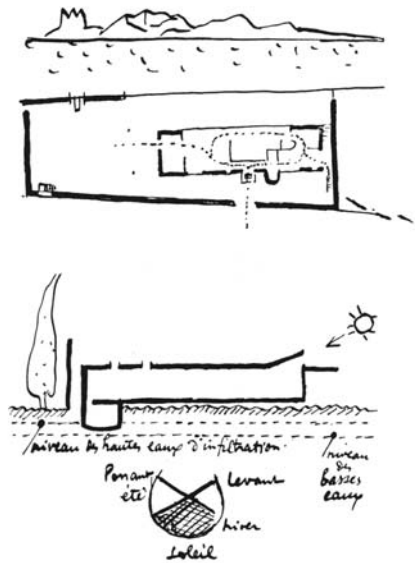


Fig. 10: Le Corbusier: location plan (top) and sketches (bottom) for the small house on Lake Geneva, 1923

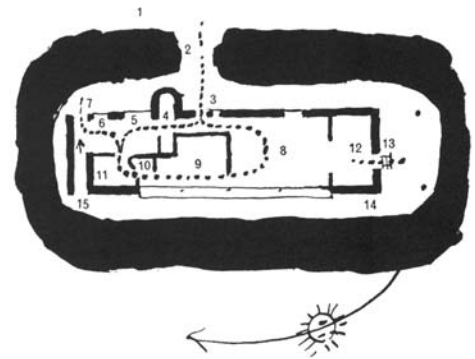


Fig. 11: Le Corbusier: sketch of functions (north at the top), 1923

abstract depiction devoid of illusory concepts of depth (as Matisse's painting 'Porte-Fenêtre' already suggested as early as 1914). The representation of perspective in Western art began with the assumption that the depth of a room is generated by a view through a window, and ended with the notion of recognising the form of the window itself as the principle behind a two-dimensional, pictorial architecture."<sup>21</sup>

Against the backdrop of this summary of the role of the window motif as an important pioneer of modern painting, we will once more return to the long window...

Perret was opposed to the long window because it did not facilitate a full view of the outside space – garden, street, sky – "particularly the segment of the sky, most of the time lost through the horizontal window", as Margherita G. Sarfatti remembers.<sup>22</sup> And, indeed, the long window does limit the perception and correct depth evaluation of the scenery that is visible. This impression is emphasised

by the extreme distance between the vertical boundaries to our view, even more so if – as in the first sketches for the *petite maison* – all the elements that delineate the room, i.e. the side walls and the ceiling bordering on the openings, are altogether hidden from sight. In other words: the long window breaks through both sides of the pyramid of vision horizontally and thus itself disappears from the visual range of the observer. Consequently, the window picture loses the characteristic of a *veduta* framed by a window, and the window frame its function as a *repoussoir*.

But if the long window is the opposite of the perspective peep-show with its characteristic steeply sloping sides and the traditional window frame, it must be considered as one of those constructional measures that played a vital role in architecture's gradual disentanglement from the traditional perspective environment. In looking at the conception and effect of the interior, the long window thus



Fig. 12: Le Corbusier and Pierre Jeanneret  
View through the long horizontal window of the small house on Lake Geneva, contemporary photograph



Fig. 13: Le Corbusier and Pierre Jeanneret  
View through the long horizontal window of the small house in Corseaux on Lake Geneva, today

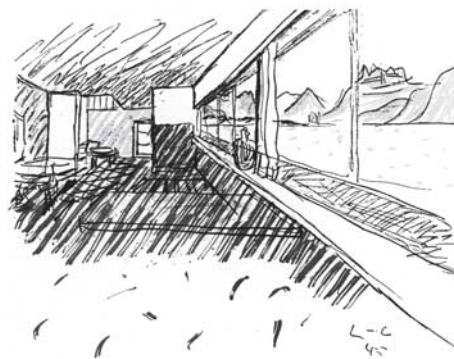


Fig. 14: Le Corbusier  
View through the long horizontal window of the small house on Lake Geneva, 1923

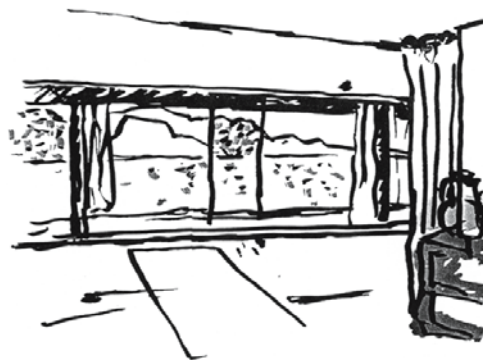


Fig. 15: Le Corbusier  
Interior of the small house on Lake Geneva, 1923

plays a similar role to the pictorial experiments that, based on the window motif, led to “a transformation from the panel painting to the prevalence of painting on canvas.”<sup>23</sup>

“The scenery is there”, in its direct immediacy, as if it were “glued” to the window because either a detached and calming effect is denied, or the “transition from the nearby, familiar objects to the more distant ones is hidden from view, which significantly reduces the perception of three-dimensional depth.”

“The paradox of the window – the modern, completely transparent one which simultaneously opens up towards the outside and admits but also confines”<sup>24</sup> – resulted in some embarrassment for interior designers and architects at the end of the 19th and beginning of the 20th century. It encouraged Dolf Sternberger to dedicate a whole chapter of his book *Panorama of the 19th century*

to “The Disruptive Window”. And Cornelius Gurlitt begins his chapter on windows, as published in his comments on art, the artistic crafts, and interior design,<sup>25</sup> with some cursory comments on the window’s recent development: the gradual enlargement of both the opening itself and the individual panes of glass: “Goethe’s cry from his deathbed for ‘More light!’ rang through our living quarters.” But he also makes a complaint: “The large window bonded the room too closely with the outside world. Man’s deftness in creating large, fully transparent walls grew to such an extent that the border between the room and the outside world was altogether blurred to the human eye, which greatly impaired the artistic consistency of the room.” For Gurlitt both the use of brightly coloured curtains towards the end of the 18th century and the more recent fashion of blinds and bull’s-eye panes are means employed in order to restore a room’s original feeling of “inner seclusion”, which was disturbed both by an excessively obtrusive relationship with the outside world and by the incoming flood of too much consistent daylight that deprived the room of twilight’s charms. “Far removed is all that goes on outside” – this should apply to the interior as Gurlitt wishes to restore it: “We feel alone in it, be it with our own thoughts or with our friends.”



Fig. 16: Caspar David Friedrich: View from the Artist's Studio, Window on the Left, 1806



Fig. 17: Henri Matisse: Open Window, Collioure, 1905



Fig. 18: Robert Delaunay: Window on the City, 1910



Fig. 19: Max Beckmann: Interior with Mirror, 1926

The same kind of criticism comes from Baillie Scott<sup>26</sup> in his sarcastic comment on the fashion of large windows spreading to English suburban mansions: “From the outside we instantly note the enormous breaches in the walls, calculated for their external effect just like shop windows. There is the table with the vase, there are the lace curtains, and so on, it all reminds us of a ‘shop display’. And inside there is this harsh, merciless light that destroys all feeling of calm and shelter.”

“The interior”, writes Walter Benjamin in his “The Arcades Project”,<sup>27</sup> “is not only a private person’s universe, but also his protective shell.” The shadowy, phantasmagorical half-light of the interior softens the all-too-physical reality of things, while the objects’ mainly symbolic existence “erases” their utility value, their concrete and commercial substantiality. In this environment furniture, furnishings, and personal knick-knacks turn the room into a safe haven for ideological and sensual identification because the gentle deception hovering at the centre of this microcosm has been created by the room’s occupant himself in accordance with his very own spiritual disposition.

But along comes Le Corbusier’s long window to tear open the “protective shell of the private person” and let

the outside world invade the interior. In the tiny living room of the lakeside villa, nature in all her glory is within reach, through the whole cycle of weathers and seasons. “A window with a length of 11 metres establishes a relationship, lets in the light... and fills the house with the vastness of a unique landscape, comprising the lake and all its transformations plus the Alps with their marvellous shades of colour and light.”<sup>28</sup>

“Then the days are no longer gloomy: from dawn to dusk nature goes through her metamorphoses.”<sup>29</sup> No longer shut out by walls and curtains, the light pours in through this opening and de-mystifies the room and the objects; the sentimental objects regain their original, solid, prosaic quality of practical tools.<sup>30</sup>

The interior has taken flight – this time into the open. *True nature* is a place of genuine memories, a euphoric object of desire with uplifting and consoling abilities. The house on Lake Geneva is a tiny hideaway protected within nature’s bosom.

But the *petite maison* does not constitute the typical “hut” with thick walls creating a protective square around the interior. The long window, opening up wide towards the scenery, enforces an unusual visual and psychological “omnipresence” on the occupant.



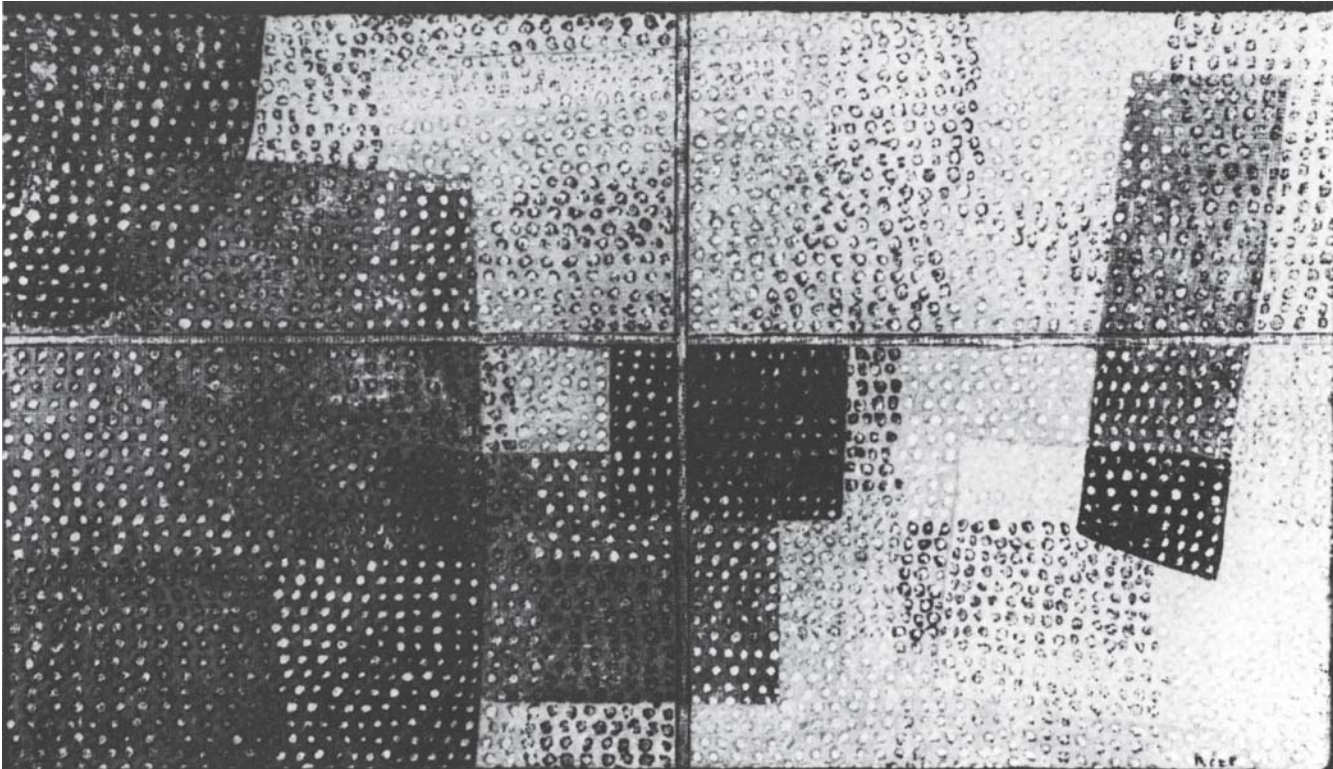


Fig. 20: Paul Klee: Through a Window, about 1932

On the borderline between two antithetical interiors, the place of physical presence and the place of spiritual longing, the human being – in the latter case forced into the role of a passive observer exactly when the all-embracing intimacy of objects and the room has disappeared – experiences the psychological and symbolic conflict within the modern “interior”, which architecture can, at best, only strive to elucidate and illustrate.<sup>31</sup>

Excerpt from: *Daidalos* 13, “Zwischen innen und aussen”, June 1984.

#### References

- <sup>1</sup> *Paris Journal* of 1 Dec 1923. The document is in the Le Corbusier Foundation collection (hereafter: LCF doc.), Paris.
- <sup>2</sup> However, the catalogue of the Salon d'Automne 1923 speaks of two *hôtels privées* models (p. 344).
- <sup>3</sup> All prior quotations of Auguste Perret appeared in the *Paris Journal*.
- <sup>4</sup> *Paris Journal* of 14 Dec 1923 (LCF doc.)
- <sup>5</sup> *Paris Journal* of 28 Dec 1923 (LCF doc.)
- <sup>6</sup> Parts of the diary of Le Corbusier's father, Georges-Edouard Jeanneret, are in the library of the La-Chaux-de-Fonds Villa. The entry for 5 Sept 1923 includes a first reference to the building plans. The proposal “d'une maison puriste, forme wagon” is first mentioned on 27 Dec 1923.
- <sup>7</sup> *Paris Journal* of 28 Dec 1923.
- <sup>8</sup> Letter from Le Corbusier to Auguste Perret, 13 Dec 1923 (LCF doc.).
- <sup>9</sup> Le Corbusier: *Une petite Maison – 1923*, Zurich, 1954, pp. 30–33, 36.
- <sup>10</sup> Le Corbusier: *Almanach d'architecture moderne*, pp. 95–97.
- <sup>11</sup> This opinion of Perret is taken from: Marcel Zahar: *Auguste Perret*, Paris, 1959, p. 15.
- <sup>12</sup> Rainer Maria Rilke: “Les Fenêtres”, Paris, 1927.
- <sup>13</sup> Notes by Le Corbusier on an undated sheet concerning a view Perret had expressed to the publisher of *L'Architecture Vivante*, Feb 1926 (LCF doc.).
- <sup>14</sup> After Marcel Zahar, *ibid.*
- <sup>15</sup> Le Corbusier: *Une petite Maison*, *ibid.*
- <sup>16</sup> Le Corbusier: *Almanach*, *ibid.*
- <sup>17</sup> Le Corbusier: *Sur un état présent de l'architecture et de l'urbanisme*, Paris, 1930, p. 30.
- <sup>18</sup> Marie Dormoy: “Le Corbusier”, in: *L'Amour de l'Art*, Paris, March 1930, No. 5, p. 213ff.
- <sup>19</sup> J. A. Schmoll (known as Eisenwerth): “Fensterbilder – Motivketten in der europäischen Malerei”, in: *Beiträge zur Motivatunde des 19. Jahrhunderts*, Munich, 1970, p. 152.
- <sup>20</sup> Cf. Georg Schmidt: *Kleine Geschichte der Modernen Malerei*, Basel, 1955
- <sup>21</sup> Eisenwerth: *ibid.*, p. 150.
- <sup>22</sup> Margherita G. Sarfatti: “Perret”, in: *L'Architecture d'aujourd'hui*, 1932, p. 11.
- <sup>23</sup> Eisenwerth: *ibid.* p. 151.
- <sup>24</sup> Dolf Sternberger: *Panorama of the 19th Century*, New York, 1977.
- <sup>25</sup> Cornelius Gurlitt: *Im Bürgerhaue*, Dresden, 1888.
- <sup>26</sup> M. H. Baillie Scott: *Houses and Gardens*, Berlin, 1912, p. 35.
- <sup>27</sup> Walter Benjamin: *The Arcades Project*, Cambridge, Mass., 1999.
- <sup>28</sup> Le Corbusier: *Précisions*, *ibid.*, p. 130.
- <sup>29</sup> Le Corbusier: *Almanach*, *ibid.*, p. 94.
- <sup>30</sup> Le Corbusier: *L'art décoratif d'aujourd'hui*, Paris 1925, chap. “Besoins-types”, p. 69ff.
- <sup>31</sup> Cf. Schmoll: *ibid.*, chap. “Schlussbemerkungen und literarische Aspekte”.

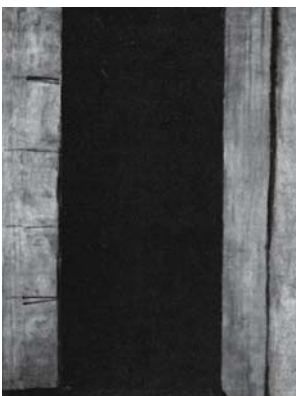


Fig. 21: Henri Matisse: Glass Doors, 1914

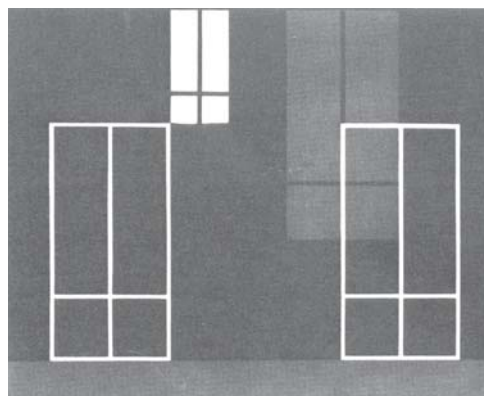


Fig. 22: Josef Albers: Windows, 1929



## The window – opening package

### The brief

An aperture in a wall, floor or roof is known as an opening. Openings join spaces for functional and/or visual reasons and thus establish a relationship between them. In the following we shall restrict our observations to openings in vertical external walls. The surfaces within the depth of a wall created by forming an opening are known as *reveal* (vertical), *sill* and *head/lintel* (horizontal).

The window is a building component for closing off an opening. It consists of outer and sash frames plus the glazing and is fitted into the structural opening. Together, window and opening therefore form an indispensable *constructional package*. The window is both an element of the package and the divider between interior and exterior.

The light permeability of the glazing promotes visual links between inside and outside, and also admits daylight into the interior. Consequently, the position and size of the opening is a key element in the design of the interior. Furthermore, if the incoming light – divided into direct sunlight and diffuse daylight – is also directed and regulated, this has a particular influence on the design concept.

In terms of the performance of the building, the window must provide a viable separation between the interior and exterior climates, and to do this it must exhibit certain thermal insulation characteristics. The main load on a window construction is that due to water and moisture in all their states, both from inside (moisture in the air, vapour diffusion) and from outside (rainwater, snow, meltwater). Essentially, the window design should prevent water from entering, but if it does enter it should be able

to drain away in a controlled fashion (waterproofing). The airtightness of the window–opening package also needs to be given attention. After all, the window assembly must guarantee comfortable conditions inside the building, and that involves thermal and sound insulation issues.

When preparing the working drawings the *tolerances* must be taken into account. As windows can be produced with considerably tighter tolerances than, for example, masonry, it must be possible to accommodate the tolerances when fitting the window into its structural opening. But the window manufacturer can use the as-built dimensions and hence construct a window to the exact size required.

At the window head it is necessary to leave space for a *sunshading system*, which will have an effect on the window head and lintel design.

### The principle of the opening rebate

The opening rebate is a peripheral step or shoulder in the structural opening and thus forms the contact face between outer frame and structural opening. The window is fitted up against this step, fixed with screws and sealed. To avoid stresses caused by temperature-related movements, the frame must be built in with minimum tolerance. All fixings must be protected against corrosion.

### The principle of the frame rebate (see full-size details)

The biggest problem with the window is keeping out water and wind. The rebate in the structural opening and the rebates in the frame members are therefore the most important elements in this battle. Special attention must be paid to the tightness of the joints between outer frame and opening, and outer frame and sash frames. The weatherstripping between outer frame and sash frames remains in the same position around the entire periphery and is sealed at the corners. There are two different sealing positions in a window element:

- Outer frame–opening
  - water and wind
  - accommodation of climate-related movements in the masonry

#### Outer frame–sash frames

The *rebate* is intrinsic to the design of windows with opening lights, i.e., *opening windows*:

- joint permeability for controlled air change rate between sash frames and outer frame
- protection against driving rain, water and wind

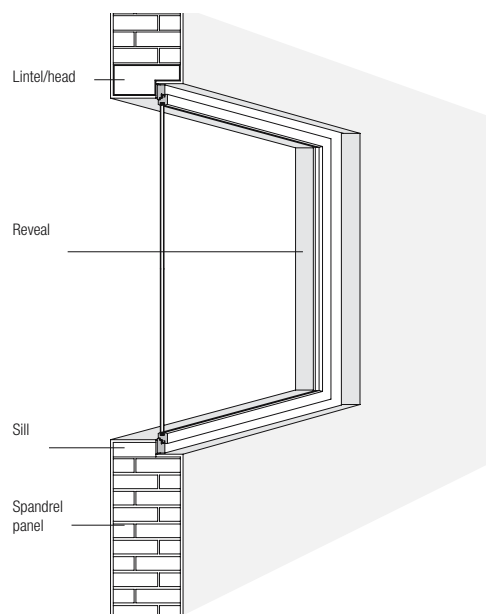
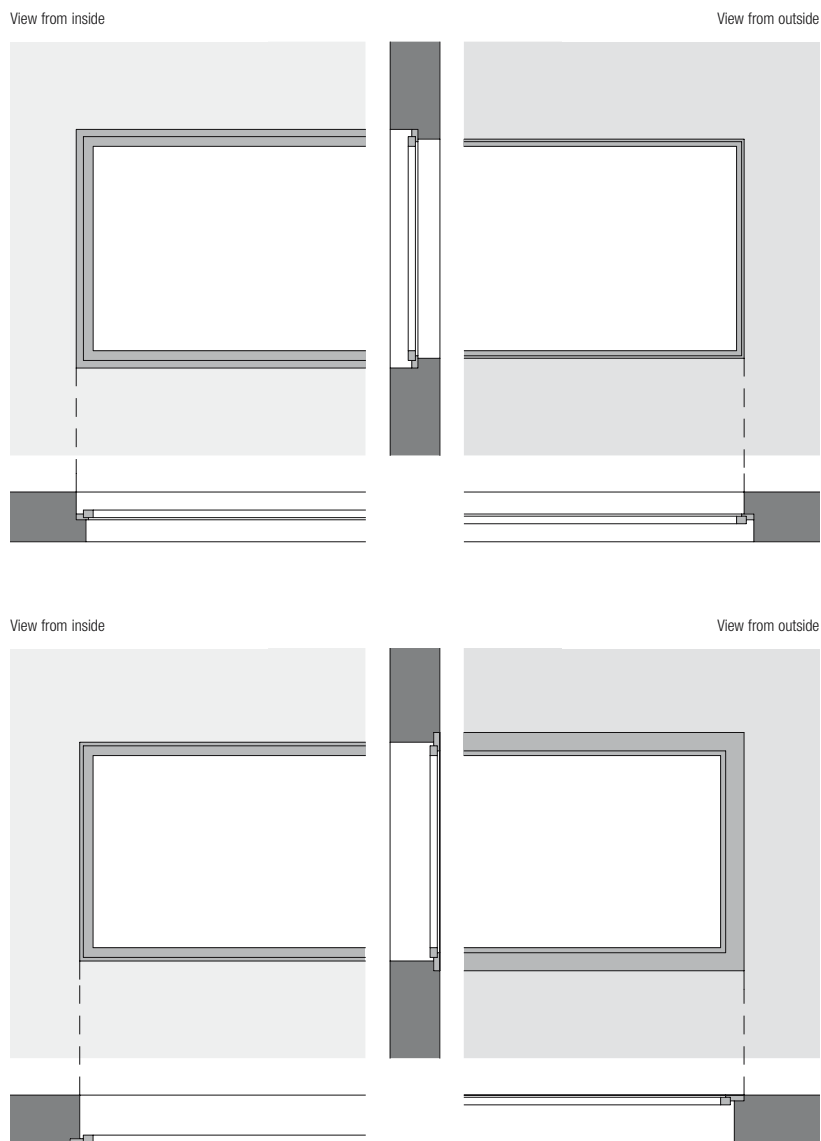


Fig. 23: Isometric view of opening rebates

## Position of window, opening rebate forms

The position of the window within the depth of the opening and the opening rebate form have considerable influence on the architectural expression of a building. Windows fitted externally, flush with the facade, lend the envelope a compact and enclosing appearance, which emphasises the form of the building. Contrasting with this, windows fitted further back within the depth of the opening create relief due to the play of light and shade, which breaks up the volume of the building. Depending on the opening rebate form, the part of the frame visible externally can be suppressed or featured. Viewed from the inside, a window fitted on the outside can create an alcove, thus extending the usable floor space, whereas windows fitted on the inside generate a distinct enclosure to the interior and possibly even the impression of a thin outer skin. Apart from the extreme positions of windows fitted flush with the inside or outside faces, the position of the window does not depend on the opening rebate form. We distinguish between two principal opening rebate forms.

Fig. 24: Window opening inwards (top), opening outwards (bottom)



### Window opening inwards

Such windows are usually fitted from inside. The entire width of the outer frame is visible internally, whereas from outside it might be that only the sash frames can be seen. The window can be fitted flush with the inside face of the wall. As the window is always fitted back from the face of the facade by a distance equal to at least the depth of the step or shoulder, it is relatively well protected against the weather. The connections do not present any problems because they are essentially covered and protected by this step or shoulder.

### Window opening outwards

The entire width of the outer frame is visible externally. The window can be fitted flush with the outside face of the wall; however, that does mean that the glazing and the frames are fully exposed to the weather. The connections must satisfy enhanced aesthetics and quality requirements because they are readily visible and very exposed, especially when the window is fitted flush with the outside face.

## The window as a component – frame sections

### Materials for outer and sash frames

#### Untreated wood

The following measures must be taken to ensure the durability of wooden windows:

Choose suitable, resistant species of wood such as pine, spruce, fir and larch. Ensure that water can drain away from all sections and surfaces.

Ensure protection by providing an appropriate surface treatment: priming is a preventive measure protecting against discolouring mould growth. Impregnation prevents rotting caused by moisture.

#### Painted wood

Wood can be painted many different colours. Opaque paints have a lower water permeability than mere impregnation and they protect against rot. Problems: resistance to ultraviolet radiation, vapour pressure from inside (in the case of thick coats of paint on the outside of the window).

#### Wood/metal

This is the combination of a loadbearing construction of wood on the inside and an aluminium facing on the outside. The latter protects the wood, but the architectural expression of the window varies from inside to outside.

#### Plastics

PVC is the most common material for the production of plastic windows. The material of the frame sections is initially white; it can be dyed or coated, but not painted.

The frame sections are hollow (single- or multi-chamber systems), with various forms readily available. Despite the inclusion of metal stiffeners to strengthen the chambers, plastic windows are known for their relatively low structural strength.

#### Aluminium and steel

Metal windows have a high thermal conductivity and so the frame sections must include a thermal break.

Aluminium windows: Stability is relatively good and so aluminium is suitable for large elements. As a rule, the surface is treated because otherwise the irregular oxidation of the material leads to blemishes.

We distinguish between mechanical surface treatments, e.g. grinding, brushing and polishing, and the electrochemical anodising process, which produces a consistent oxide layer. Stove-enamelling involves bonding a coat of paint to the metal surface by firing.

Steel windows: Mainly used for industrial buildings. Much more stable than aluminium windows. Large window assemblies, especially together with the glazing, are very heavy (installation problems).

The biggest disadvantage is the risk of corrosion, which can be reduced by painting or galvanising. Like aluminium windows, steel windows can be given a stove-enamelled finish.



Fig. 25: Window sample  
Frame: untreated wood; insulating glazing

## The window as a component – glass

### Types of glass

Various types of glass are available, distinguished by the method of manufacture:

- *Float glass* is today the most common form of glass and has a flat surface.
- *Window glass* was the forerunner of float glass and is characterised by a slightly undulating surface (cf. window panes in old buildings).
- *Rolled or patterned glass* has a textured surface and is therefore translucent, not transparent.
- *Wired glass* includes a wire mesh inlay, which enhances the fire resistance and binds together the fragments of a broken pane.

In addition to these basic types, diverse coatings and surface treatments are possible. The choice of glass and its coating or treatment influences the architectural expression and the quality of light entering the interior (direct, diffuse, coloured) plus building performance and security aspects. We distinguish glazing primarily according to mechanical and thermal treatments:

- standard glass
- toughened glass
- toughened safety glass
- laminated glass
- laminated safety glass
- fire-resistant glass
- heat-treated glass
- insulating glazing
- heat-absorbing glass
- solar-control glass

....

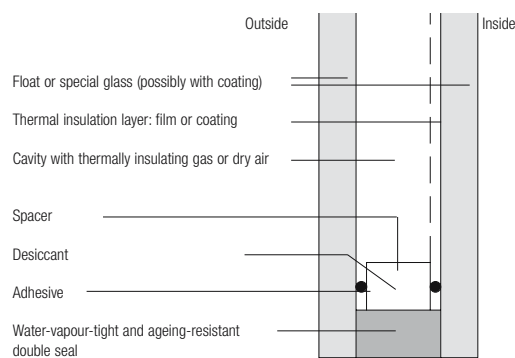


Fig. 26: Schematic diagram of insulating glazing construction

Current thermal insulation and comfort requirements have made insulating glazing the number one choice for almost all windows.

Insulating glazing consists of at least two panes of glass bonded to an aluminium or plastic spacer. The adhesive also seals the cavity between the panes.

The thermal insulation properties of insulating glazing essentially depend on the cavity and the quality of its filling (various gases), also any coatings that have been applied.

### Important parameters

*U-value:* This designates the thermal transmittance value of glasses and building components. The lower the value, the better the insulation. Customary values are 1.0–1.1 W/m<sup>2</sup>K, but values as low as 0.4 W/m<sup>2</sup>K are possible (HIT glass, glass with special interlayer).

*g-value:* This defines the total energy transmittance through the glazing. This value is important for controlling heat transmission gains and heat protection. The g-value specifies how much energy from the incident solar radiation passes through the glazing into the interior. It is made up of two components: the direct radiation transmission and the secondary heat emissions. This latter phenomenon results from the fact that the incident solar radiation heats up the glass, which in turn releases this heat both inwards and outwards.

### Further reading

- Schittich, Staib, Balkow, Schuler, Sobek: *Glass Construction Manual*, Basel, Boston, Berlin, 1998.
- Bruno Keller, Professor of Building Performance Issues, ETH Zurich: *Building Technology I–III, lecture manuscript, Building Performance Issues for Architecture Students*.
- Glas Trösch AG: *Glas und Praxis*, Bützberg, 2000.



## Window – horizontal section, 1:1

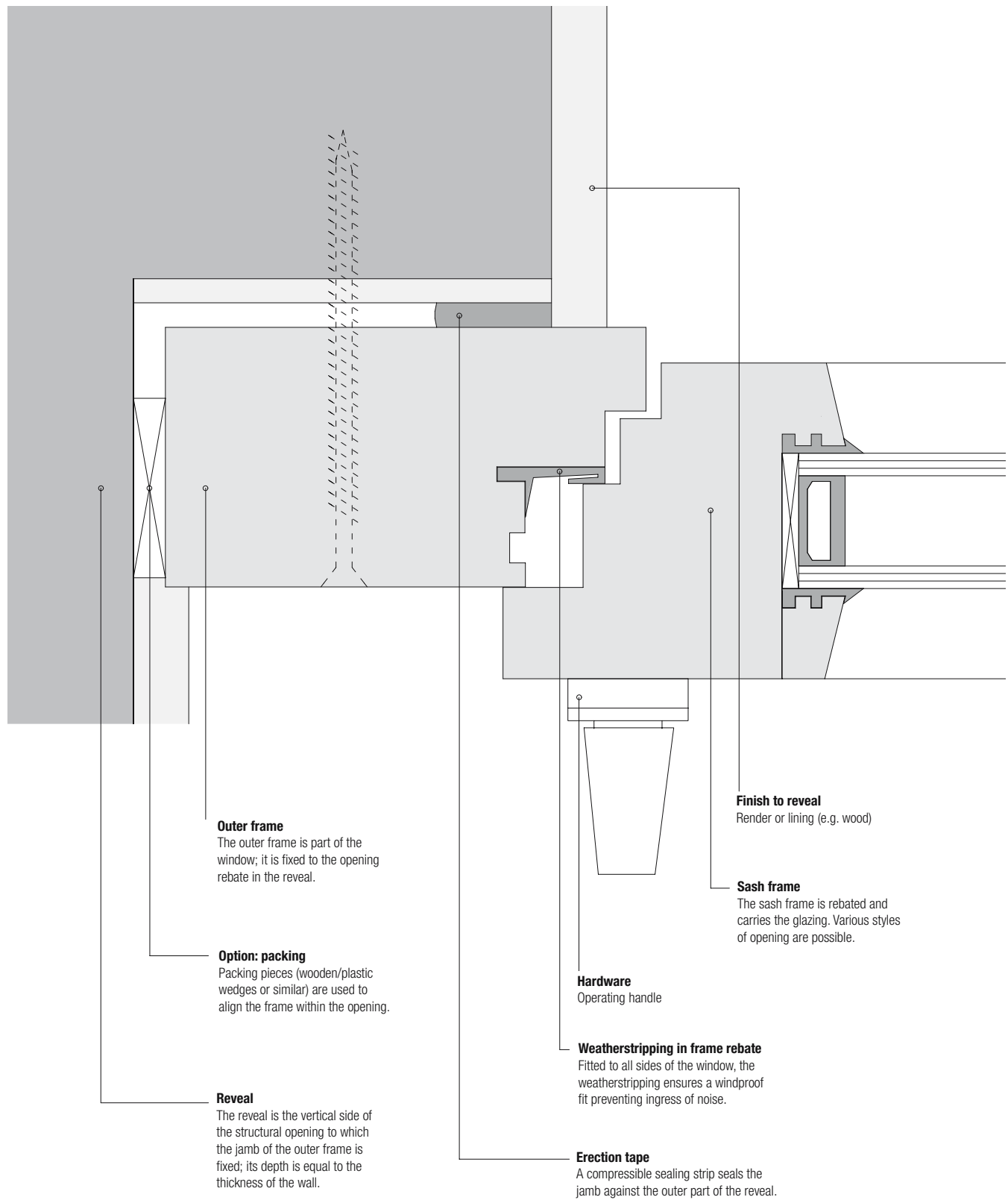


Fig. 27

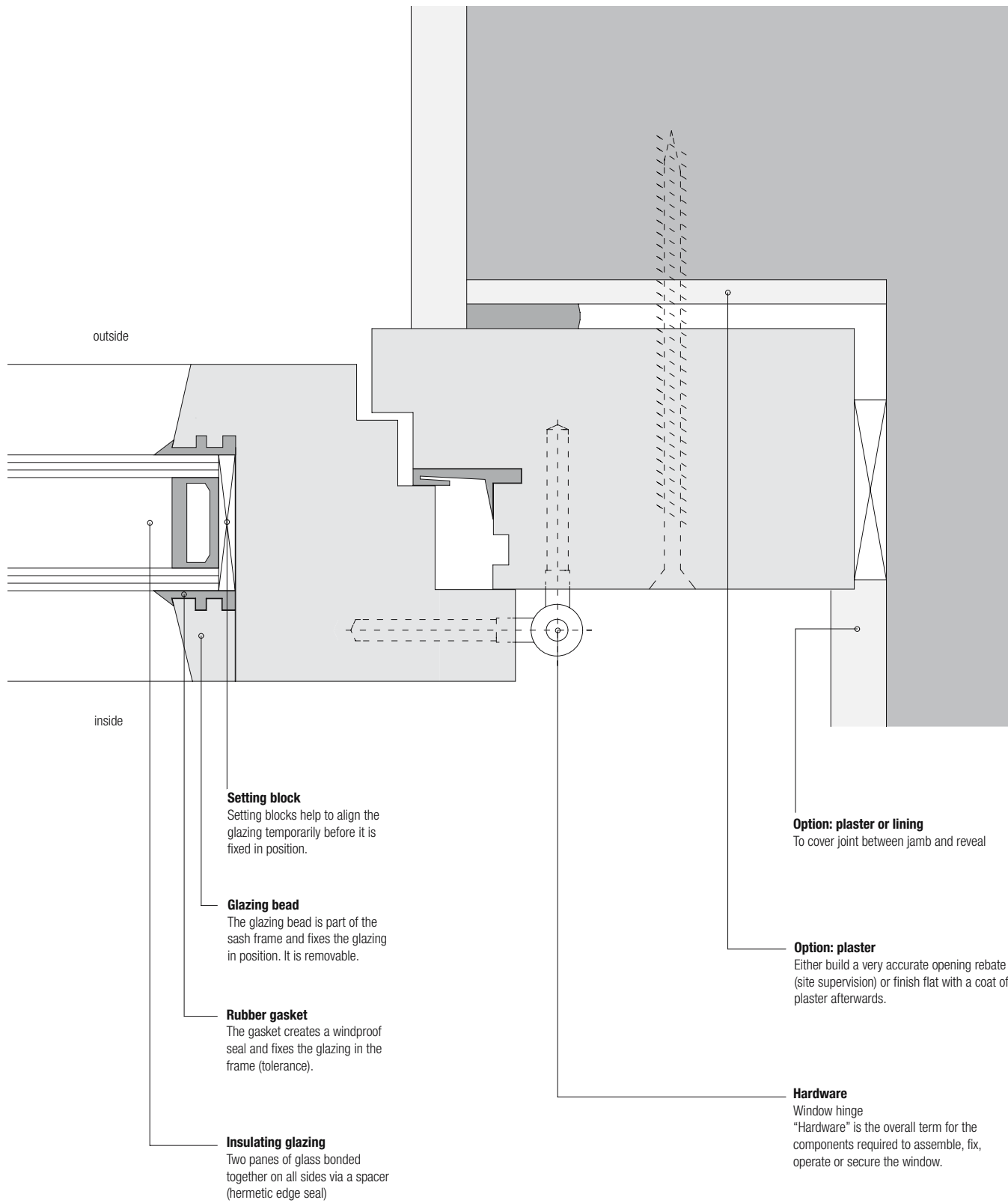


Fig. 28

## Window – vertical section, 1:1

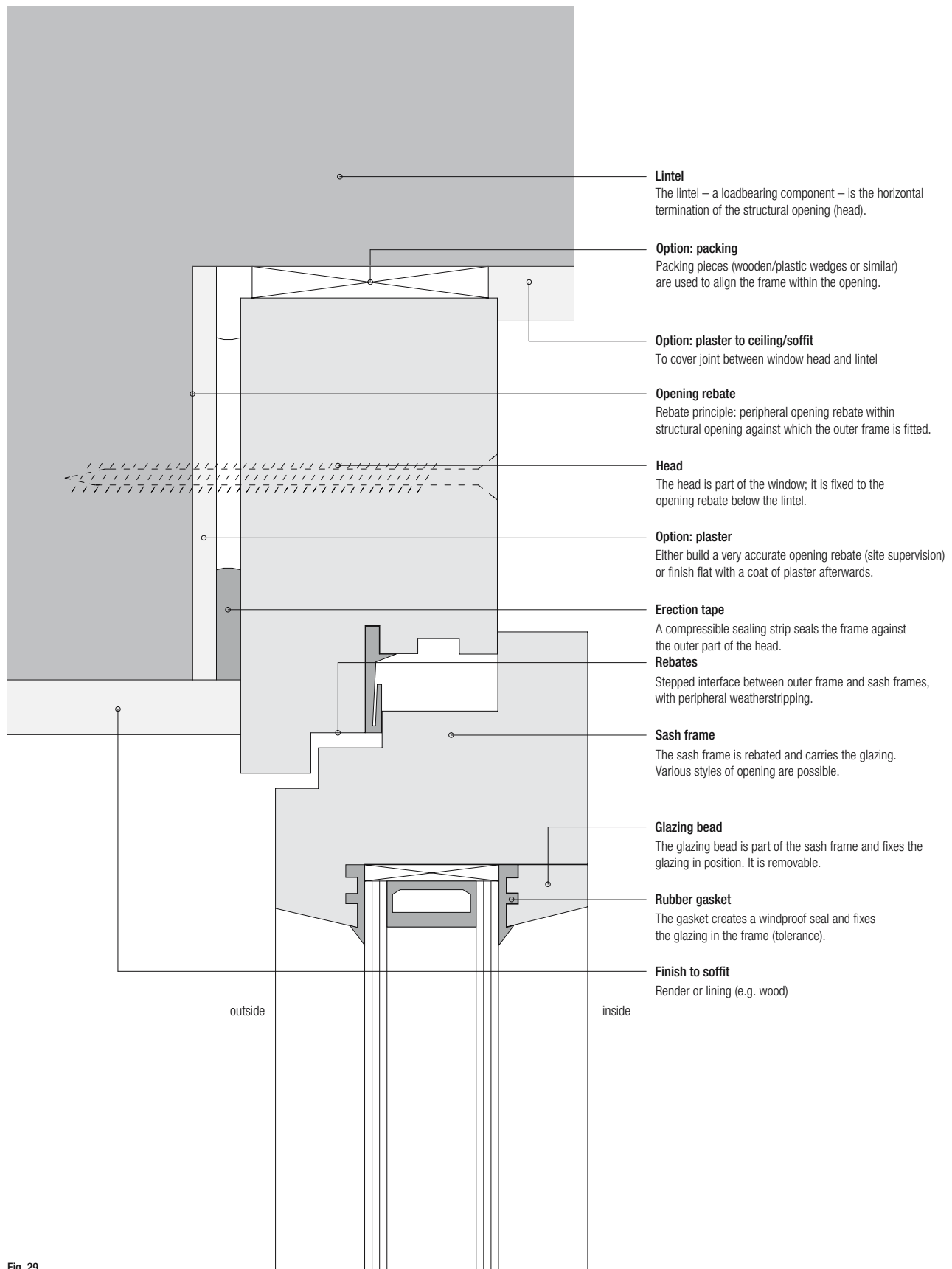


Fig. 29

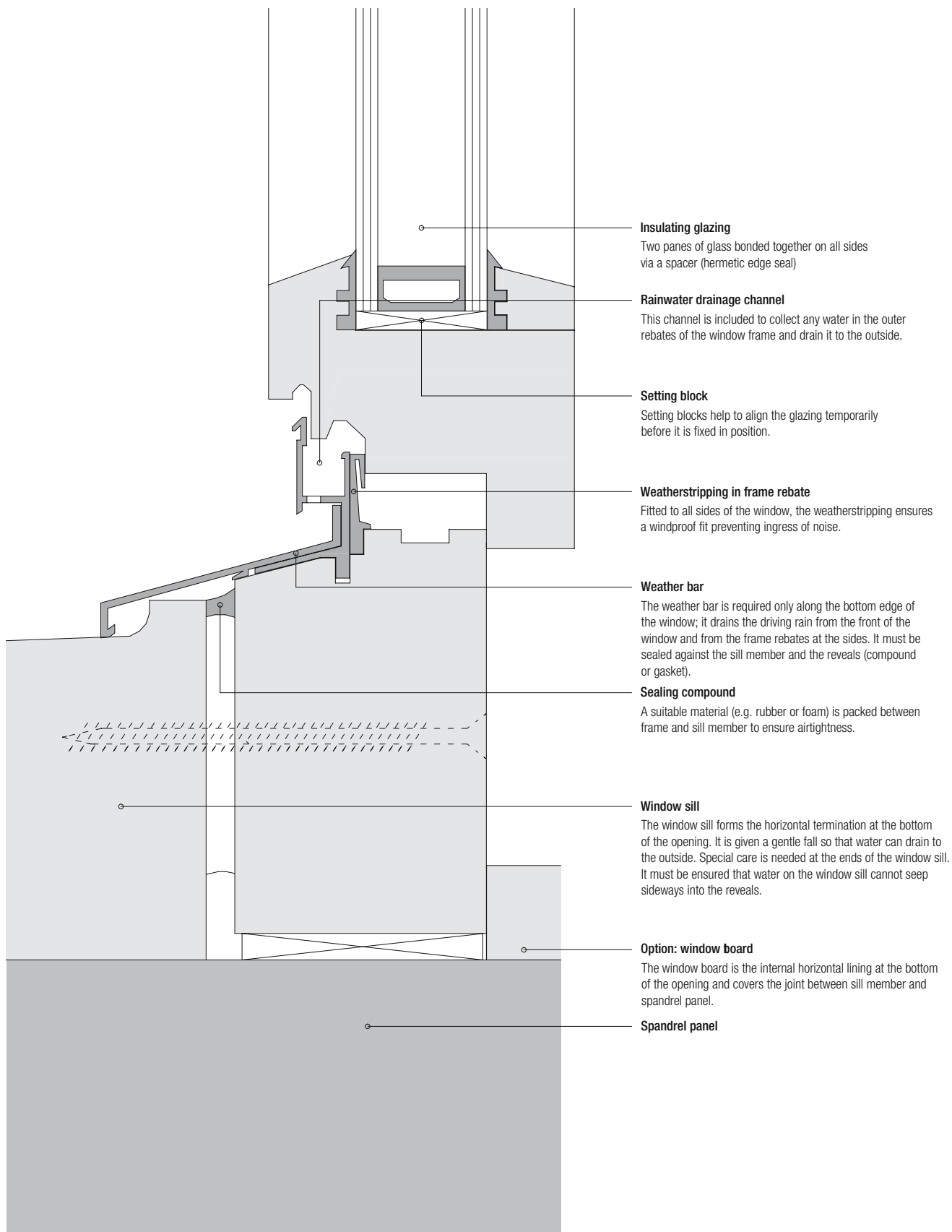


Fig. 30



## The opening as a hole



Fig. 31: Embedded in the steep coastal cliffs  
Adalberto Libera: Casa Malaparte, Capri (I), 1941

### Adalberto Libera: Casa Malaparte

Besides the numerous small openings in the facade, Casa Malaparte has four large, carefully positioned openings. From inside, whether sitting or standing, these permit an unrestricted view of the steep, rocky coastline of the island of Capri. The inside of each opening has an elaborately carved chestnut frame, giving the effect of a “painting”. The glass, as the physical separation between inside and outside, has no frame and is fitted flush with the outside face of the wall, which enables the thickness of the external wall to be experienced from inside. From the outside, however, this flush arrangement emphasises the homogeneity of the envelope.



Fig. 32: View of the steep coastal cliffs framed as a “painting”  
Adalberto Libera: Casa Malaparte, Capri (I), 1941

### Rudolf Olgiati: Van Heusden House

The tower-like appearance of this building is reinforced by the limited number of “punched” openings in the walls. The deep “hoppers” suggest mass and promise a solid, monolithic form of construction. On the contrary, the walls are thin skins. Only a section through the building reveals this to be a contemporary design using a minimum of materials. The inward projection of the window “hoppers” either frames the view of the outside world or focuses the incoming daylight.



Fig. 33: The deep, splayed window openings suggest a solid envelope.  
Rudolf Olgiati: Van Heusden House, Laax (CH), 1964



Fig. 34: Cantilevering glass oriels enable good views of the street below.  
Alejandro de La Sota: Calle Prior apartment block, Salamanca (E), 1963

### Alejandro de La Sota: Calle Prior apartment block

The Calle Prior is a narrow street that does not permit any balconies with a useful size. Nevertheless, tenants are still given the chance to “keep an eye on the street”.

Glass “showcases” protrude from the facade to enable a view of the entire street. They are glazed on all four sides and therefore stand out quite clearly from traditional oriels or windows. When looking out of the window the feeling of stepping out into the street is reinforced by this design and becomes an architectural feature.

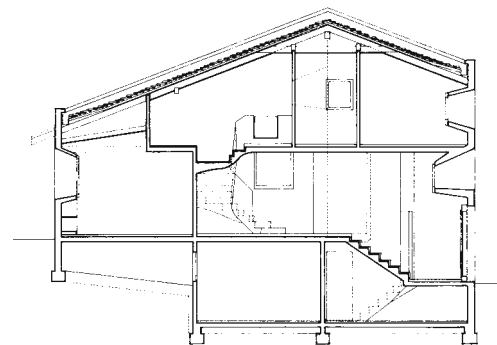


Fig. 35: The splayed window openings extend into the rooms.  
Rudolf Olgiati: Van Heusden House, Laax (CH), 1964

## The opening as a horizontal strip



Fig. 36: Different horizontal strip windows lend the facade a distinct hierarchy.  
M. Ponsett, E. Salas: "La Fabrica" furniture manufacturer, Barcelona (E), 1961

### M. Ponsett, E. Salas: "La Fabrica" furniture manufacturer

The internal organisation of this building is clearly legible on its facade. At ground level it is almost entirely one large display window. And this generous transparency is repeated for the working areas on the three stepped-back floors above.

In between, the high-level, continuous strip windows to the display areas extend across the full width of the facade. These have the effect of dividing the facade horizontally, storey by storey, and thus underline the hierarchy in a simple way.



Fig. 40: The dominant horizontal strip window on the upper floor reveals the loadbearing structure.

Otto Rudolf, Salvisberg: first church of the Christian Science Church, Basel (CH), 1937

### Otto Rudolf Salvisberg: first church of the Christian Science Church

The church is located in a courtyard plot set back from the road. The entrance is through an open foyer which is defined by the cantilevering assembly hall on the upper floor.

A finely divided horizontal strip window dominates the facade. The ensuing transparency reinforces the curving shape of the hall. A consistent level of daylight is able to reach deep into the building.

Separated from the facade, the loadbearing structure of individual columns becomes distinct, having absolutely no effect on the facade itself.

### Herzog & de Meuron: House in Tavole

Like an abandoned child, the building stands amid olive groves. The delicate concrete frame forms a fragile envelope denoting the floors. The infill panels are of rubble stone.

Whereas the individual windows submit to the rules of stratification, the mullioned continuous horizontal strip window separates the solid coursing of the envelope from the oversailing eaves. The window extends around three sides to admit light into an interior that is heavily influenced by the omnipresent landscape.



Fig. 37: The landscape seen through the horizontal strip window has a clear influence on the interior.  
Herzog & de Meuron: House in Tavole (I), 1988



Fig. 38: The horizontal strip window separates the roof from the solid walls.  
Herzog & de Meuron: House in Tavole (I), 1988

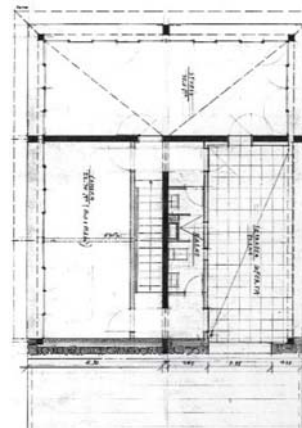


Fig. 39: Plan of upper floor  
Herzog & de Meuron: House in Tavole (I), 1988

## The opening as a joint

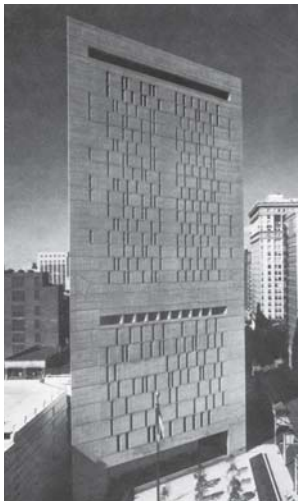


Fig. 41: The vertical "joints" distinguish the cells.  
Harry Weese: Metropolitan Detention Centre,  
Chicago (USA), 1975



Fig. 42: Tall windows create a link between old  
and new building.  
Diener + Diener: Pasquart Centre, Biel (CH), 1999

### Harry Weese: Metropolitan Detention Centre

This prison in the centre of Chicago is a triangular high-rise block built completely in reinforced concrete. At first sight the facades look like giant punched cards for computers owing to the pattern of the windows, which appear as storey-high joints between the masonry panels of irregular width extending vertically between the regularly spaced floors of the building.

Upon closer inspection we discover that the width of the windows has been calculated exactly to rule out the need for any bars. The reveals splay outwards, thereby maximising the angle of view from each cell. Horizontal openings for the plant rooms halfway up the building and the exercise yard on the top floor represent the exceptions. These horizontal dividers add scale to the monumental appearance of this "prison tower".



Fig. 43: Positioning the window in the corner leads to different lighting effects.  
Diener + Diener: Pasquart Centre (museum), Biel (CH), 1999

### Diener + Diener: Pasquart Centre

The extension by Diener + Diener sets itself apart from the existing building by appearing as its "poor relation". But the use of tall windows, a characteristic feature of the existing building, nevertheless creates a powerful link between the two.

Whereas the openings in the facade appear as traditional holes, from inside they become slits stretching from floor to ceiling, allowing ample light into the rooms. Positioned at the corners, the windows create two interior zones near the facade, characterised by their different lighting conditions. They therefore encourage a particular layout of the exhibits.



Fig. 44: Wall panels joined by diagonal corner window "hinge"  
Louis Kahn: Richards Medical Research Centre, Philadelphia (USA), 1965

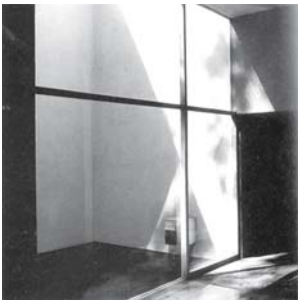
### Louis Kahn: Richards Medical Research Centre

The complex comprises several buildings in an interlinked linear arrangement. Towers abutting the main buildings house access and service shafts.

One tower, which provides sanitary facilities, lifts and stairs for several storeys, forms a dominant terminus. The square tower comprises four wall panels which are joined in such a way as to create continuous slits at the corners. However, with the two-storey-high diagonal corner windows it seems as though the panels are joined via a hinge.



## The opening as a transparent wall



### Luis Barragan: Casa Antonio Galvez

Situated within a plot enclosed by high walls the Casa Antonio Galvez offers the most diverse relationships with its surroundings and, through the positioning of the openings, plays with different degrees of intimacy and changing moods.

For instance, a small patio extends an ancillary room to the living room and in a certain way functions as a light source. Depending on the position of the sun, light enters the room either directly or after being reflected from the wall opposite. The view out the window becomes a view of a "sundial". As a clear distinction is made between inside and outside by using particular colours and materials (e.g. pond), the dissolution of the boundary between interior and exterior is no longer relevant.



Figs 45 & 46: Inner courtyard as "sundial"  
Luis Barragan: Casa Antonio Galvez, Mexico City (MEX), 1955



Fig. 49: Using the same materials to dissolve the boundary between inside and outside.

Eduardo Souto de Moura: Algarve House, Quinta do Lago (P), 1989

### Eduardo Souto de Moura: Algarve House

The living room of this single-storey holiday chalet opens up to the garden across its full width. The material and surface treatment of floor, wall and ceiling continue unchanged from inside to outside, thus blurring the boundary between interior and exterior, indeed dissolving it altogether.

The glazed facade that spans the entire width and height of the room is a climatic necessity. The sliding doors reduce the divisive effect of the glazing when open.

### Bo + Wohlert: Louisiana Museum

Louisiana Museum is a series of pavilion-type exhibition units situated within tree-covered parkland. Linking the pavilions are glazed corridors, which enable visitors to study the sculptures dotted around the park, which thus becomes an extension of the internal exhibition space.

The pavilion shown here overhangs the top of a slope which leads down to a lake. The proximity of the natural surroundings, enhanced by the lack of spandrel panel and lintel, and the floor raised clear of the ground convey the impression of a treehouse. But the mullions prevent the scene being perceived merely as a painting.

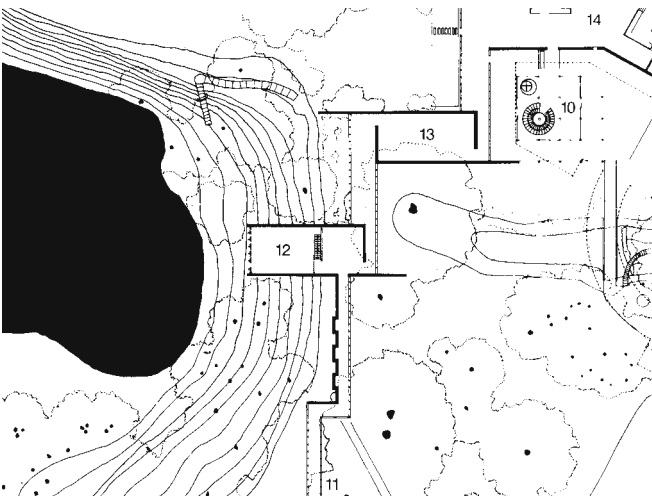


Fig. 47: Nature almost within reach thanks to the omission of spandrel panel and lintel  
Bo + Wohlert: Louisiana Museum, Humlebaek (DK), 1958



Fig. 48: Exhibition room (12) pointing like a "cannon" towards the lake  
Bo + Wohlert: Louisiana Museum, Humlebaek (DK), 1958



## About the door

Cordula Seger



**Fig. 50: Bold colours distinguish the entrance and so the door is singled out as a key design element**

Bruno Taut: Hufeisen estate, Berlin-Britz (D), 1925–27



**Fig. 51: Link between private and sacred: a miniature shrine above the wooden lintel distinguishes this entrance**

Old farmhouse in Villa di Zoldo, Dolomites (I)



**Fig. 52: The revolving door as a trademark of a grand hotel, Olive Street entrance, The Biltmore Hotel, Los Angeles (USA), 1923**

The door is our link between inside and outside, and creates a relationship between different spheres. Together with the threshold it denotes a significant crossing-place. In many cultures this transition from one space to another, which questions the physical presence of the person passing through the door, is accompanied by symbols. In doing so, the physical and the implied figurative transition from one social position to another are superimposed. Those who may pass through a certain door identify themselves as members of a community.<sup>1</sup>

As a crossing-point the door also represents the beginning of our journey through the building and, as we enter, prepares us for what follows. In doing so, the visual and the haptic experiences play an important role: Does the door handle fit snugly in the hand? Do we have to use our body weight to push open the door, or does it swing open easily? Does the door close with a satisfying clunk, or does it grate against the frame?

The height, width and design of the door indicate the degree of prestige and openness to the public. An entrance door with a generous opening and interesting design is an inviting gesture. However, the design of the entrance is often ignored, especially in residential developments. This deficit is reinforced by minimal ceiling heights – the correspondingly “squashed” doors look oppressive and uninviting. Within a multi-occupancy apartment block the entrance door to each apartment separates the semi-public corridor or landing from the private living quarters. Often provided with a wide-angle door viewer, which guarantees a view out but not in, the door demonstrates that not every visitor is welcome. We expect the entrance door to provide protection, whether against unwanted noise, intrusive looks, heat losses or even intruders. It is therefore built accordingly – solid, satisfying increasingly higher demands. It is really the internal door that separates the private areas and creates a hierarchy of spaces: the more intimate the function of the room, the more impenetrable is the door. After all, a jib-door is hardly noticeable; let into the wall to be as invisible as possible, it conceals secrets.

For its part, the type of door indicates the anticipated flow of visitors and the manner in which these are to be guided. The automatic sliding door obeys the wishes of a constant flow of people. In a department store, for instance, such a door enables an unhindered flow of shoppers in and out. On the other hand, the revolving door to a hotel spins invitingly into the street. Its circular movement represents a constant coming and going but allows every guest to arrive and depart individually. The swing door is also a traditional part of the hotel. It links the public sphere with that behind the scenes, e.g. the restaurant and the kitchen. Opened with a trained kick, the door moves in the desired direction to permit the unhindered passage of the busy waiter or waitress.



**Fig. 53: View of one of the large entrance portals on the northern facade**

Hans Kollhoff and Christian Rapp: residential development, KNSM-Eiland, Amsterdam (NL), 1991–94

In his *The Poetics of Space* the philosopher Gaston Bachelard asks: “And then, where to? To whom are the doors opened? Are they opened on to the world of people or the world of loneliness?”<sup>2</sup> In architectural terms this question can be answered at least partly: in the private part of the building the door opens inwards and guides the incoming person into the protective space. There are many figures of speech containing references to doors either opening or closing, showing the importance of this opening in the wall, and indicating that we should not cross the threshold too lightly when the door opens inwards. But in buildings in which large numbers of people congregate the doors must open outwards, in the direction of escape. However, the question of “where to?” concerns more than just the direction of opening. It points to the quality of the space into which the door opens. The positioning of the door – whether it emphasises the symmetry and leads us into the centre of the room, or is close to a wall and leaves space for furniture – has a crucial influence on the utilisation and atmosphere of interior spaces.

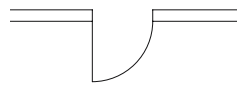
<sup>1</sup> See Arnold van Gennep: *Übergangsriten* (1909), Frankfurt a.M., 1999, p. 184.

<sup>2</sup> Gaston Bachelard: *Poetik des Raumes*, Frankfurt a.M., 1994, p. 222.

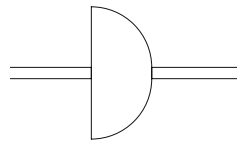
– English translation: Gaston Bachelard: *The Poetics of Space*, Boston, 1969.

## Doors – types of opening

Fig. 54: Types of opening  
scale 1:100



Standard hinged door



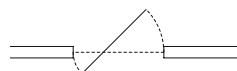
Double door



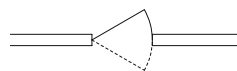
Sliding door (in front of wall)



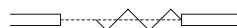
Sliding door (within wall)



Pivoting door



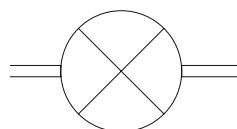
Swing door



Folding door (fitted between jambs)



Folding door (fitted in front of opening)



Revolving door

### The opening form

The most common type of door is the hinged, single-leaf door. Together with the swing door and the double door it has hinges on one side. As the weight of the door leaf acts directly on the hinge like a lever, the use of such doors is limited to standard door widths, although in the form of a double-leaf door twice the standard width can be accommodated.

The hardware for sliding and folding doors is less dependent on the weight and so can be used for larger openings as well. In contrast to the hinged door a sliding door needs less space around the door because the door leaf does not swing out into the room. However, space adjacent to the side of the door is necessary to accommodate the door leaf as it slides. Sliding doors are often used internally to subdivide a large room, e.g. for dividing a living room, or separating a dining area from the kitchen.

When used as an internal door to a bedroom it must be remembered that a sliding door cannot achieve the same sound insulation value as a hinged door. If good acoustic insulation is necessary, e.g. doctors surgeries, a double door is advisable.

Automatic sliding doors have become established for buildings open to the public where there are large flows of people. Such a door guarantees an optimum throughflow. Another type of door is the revolving door. Its efficiency depends on its diameter. The advantage of revolving doors over automatic sliding doors is that they obviate the need for a lobby.

### Standard hinged doors

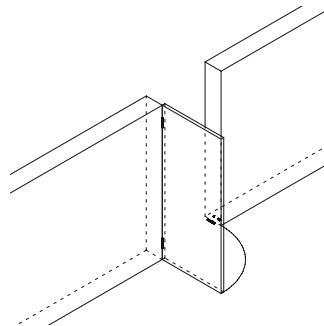


Fig. 55: Single-leaf hinged door, hinges on left

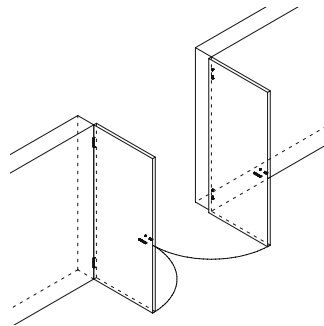


Fig. 56: Double-leaf hinged door

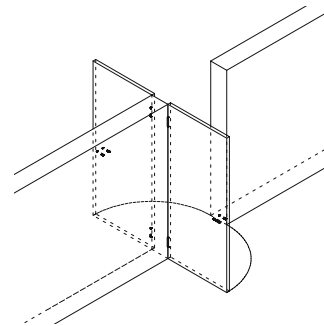


Fig. 57: Double door

### Sliding doors

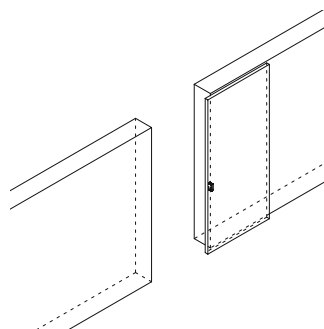


Fig. 58: Single-leaf sliding door (in front of wall)

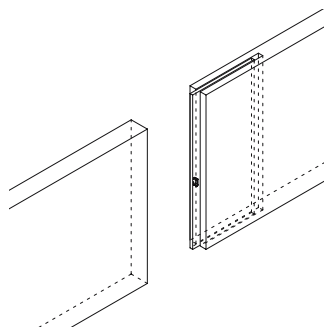


Fig. 59: Single-leaf sliding door (within wall)

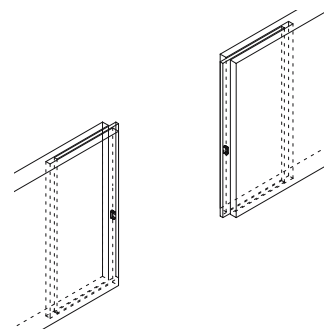
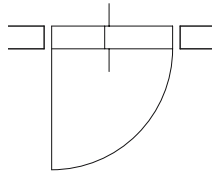


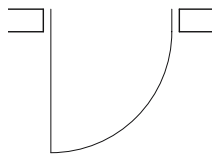
Fig. 60: Double-leaf sliding door (within wall)

## Doors – types of door stop

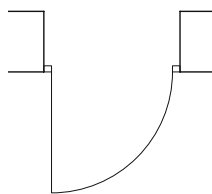
Fig. 61: Types of door stop  
scale 1:50



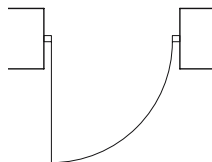
Lining and architrave  
raised threshold



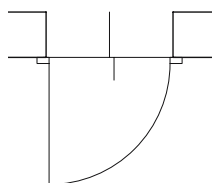
Rebated jamb  
no threshold



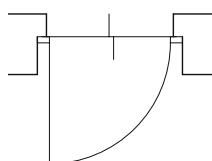
Frame in opening, finished flush  
no threshold



Frame in opening, centred in reveal  
no threshold



Frame clear of opening, either side of wall  
step in floor



Frame clear of opening, against shoulder in  
reveal, step in floor

## The door stop form

The door stop is the meeting point between the door leaf and the component in which the door opening is located. Its form depends on the technical, circulation and architectural requirements that the door has to fulfil.

The door frame is manufactured from a dimensionally accurate material, e.g. wood, steel, so that, once fitted into the structural opening in the wall, it can accommodate the dimensional discrepancies in the wall. The frame also serves as a member to which the door hardware, e.g. hinges, tracks, is attached.

If a door has to be waterproof and windproof, and meet a certain standard of thermal and acoustic insulation, a peripheral frame is indispensable. Special care is required at the threshold. On the one hand it must be waterproof, but on the other, crossing it should be as convenient as possible, whether on foot or in a wheelchair.

## Jamb stop detail

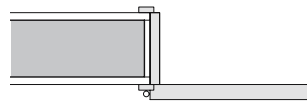


Fig. 62: Lining and architrave (internal door, also external door in timber frame construction)  
rebated door leaf

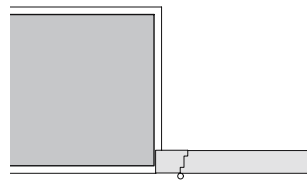


Fig. 64: Frame in opening, finished flush (internal and external doors)  
rebated door leaf flush with frame

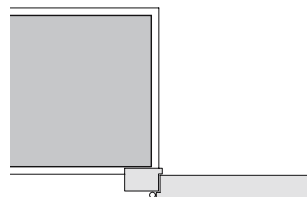


Fig. 66: Frame clear of opening, fitted to either side of wall (internal and external doors)  
rebated door leaf

## Threshold stop detail

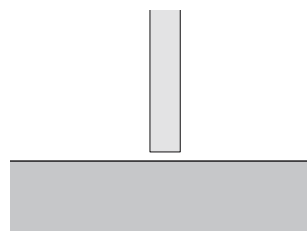


Fig. 68: No threshold

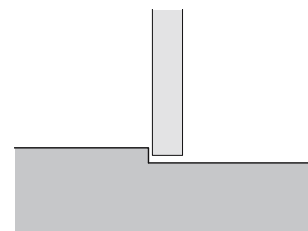


Fig. 69: Step in floor

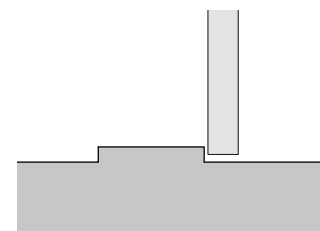


Fig. 70: Raised threshold

The form of the door stop changes the visual perception of a door. A frame finished flush with the wall and painted the same colour as the wall disguises the opening. If the frame is fitted within the reveal, it forms an inviting recess. A door that includes lining and architrave emphasises the opening as a “framed” aperture, an impression which can be further underpinned by including a raised wooden threshold.

Whereas the raised wooden threshold was very popular in the past, the preference these days is for internal doors without any threshold to interrupt the floor finishes. A change in the floor finish is covered accordingly with a thin strip of metal or plastic. If sound insulation is important, a vertical seal is included in the bottom of the door leaf.

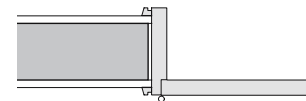


Fig. 63: Rebated jamb (internal door)  
no rebate in door leaf

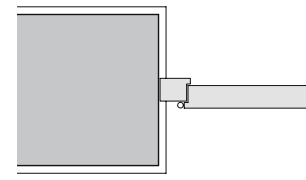


Fig. 65: Frame in opening, centred in reveal (internal and external doors)  
rebated door leaf

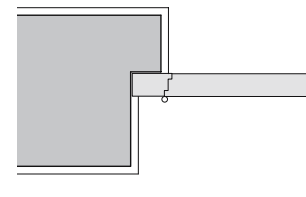


Fig. 67: Frame clear of opening, against shoulder in reveal (external door)  
rebated door leaf flush with frame

## Doors – hardware

**Hinged single leaf steel-framed glass door**

e.g. Forster Profilsysteme, Arbon

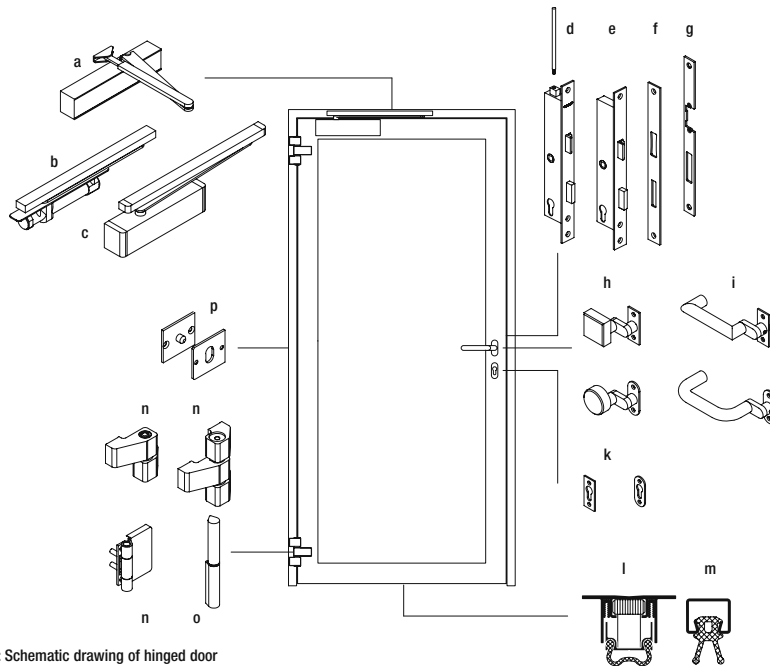


Fig. 71: Schematic drawing of hinged door

**Door closers**

- a Door closer with articulated arm
- b Concealed door closer
- c Door closer with fixed track

**Door locks**

- d Mortise lock (leaf) with latch and dead bolt plus additional bolt to door head
- e Mortise lock (leaf) with latch and dead bolt
- f Striker plate (frame)
- g Striker plate (frame) for electrical door opener

**Door handles**

- h Square or round door knob
- i Angular or rounded door handle
- k Escutcheon

**Seals**

- l Vertical seal in underside of door leaf
- m Threshold with seal

**Door hinges**

- n Screwed on (weight of door critical)
- o Welded on

**Hinge bolts**

- p A hinge bolt, positioned centrally between the hinges, prevents the door being forced open on the hinge side.

**Sliding wooden door**

e.g. HAWA-Junior hardware

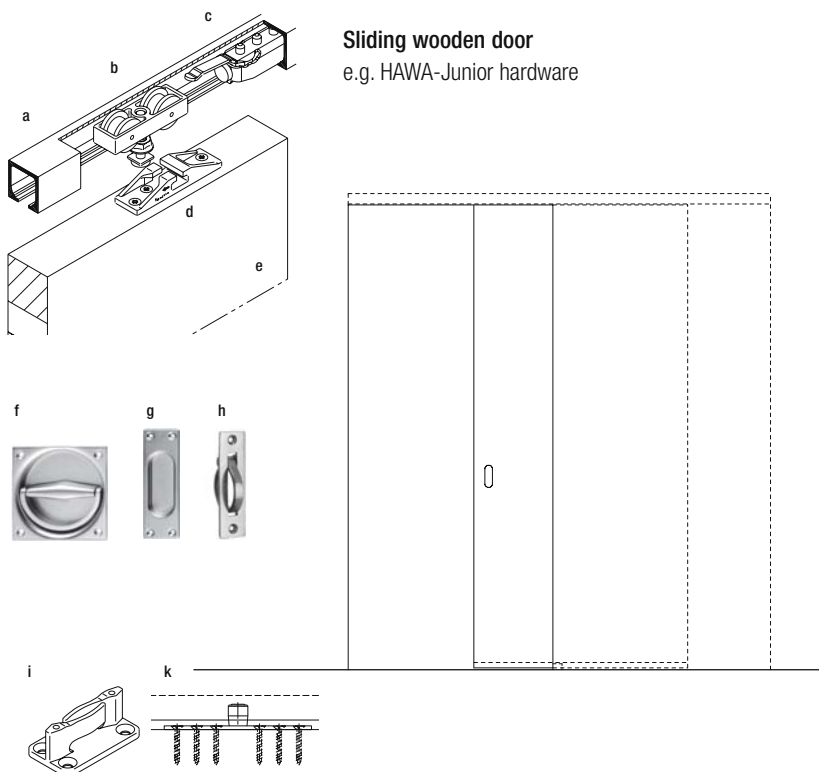


Fig. 72: Schematic drawing of sliding door

**Hardware for single-leaf sliding doors**

- a Track fixed to lintel or ceiling or soffit
- b Trolley with nylon rollers
- c Buffer with retaining spring
- d Hanger for left- or right-hand opening
- e Door leaf

**Door handles**

- f Recessed with ring
- g Recessed
- h On front edge

**Floor guides**

The floor guide profile is fitted adjacent to the opening at the start of the slot in the wall and runs in a track let into the base of the door leaf.

- i T-form floor guide (no play)
- k Guide pin



## Wall – opening

### Influences on the building envelope

#### 1. Rain

##### Wall

Erosion of outer leaf, risk of saturation of outer leaf, frost risk

- Masonry (monolithic, two leaves or with external insulation): render/paint.
- Fair-face masonry: clay/hard-fired bricks are water-repellent and frost-resistant, special mortar required (seal joints), possibly a ventilation cavity.
- Lightweight construction (steel, timber): cladding, shingles, planks, boards; if the loadbearing construction is positioned externally, it must be protected (paint, cladding, canopy).
- Exposed concrete facades: concrete is essentially waterproof, but the problem of carbonation must be considered: carbon dioxide and moisture in the air react with the alkaline components in the cement, which leads to corrosion of the reinforcement and subsequent spalling of the concrete surface.

##### Window

Rain striking the window is drained via a weather bar on to the window sill. Rebates in the window frame must always be formed to prevent water collecting. The joints with the spandrel panels at the sides are particularly vulnerable.

#### 2. Sunshine

##### Wall

Measures to combat ultraviolet radiation and temperature rise. Untreated timber facade elements exposed to direct sunlight are particularly vulnerable to deformation, cracking and sometimes "scorching" as well. Nevertheless, timber is regarded these days as a building material presenting few problems. Paints, glazes and impregnation are additional measures that can be taken to prevent water entering porous building materials. Dark finishes are a problem because they heat up too much and so are unsuitable for facades with external insulation.

##### Window/opening

Measures to combat glare and heat gains, and to provide privacy

– Flexible sunshading systems, external:

- Louvers (aluminium, position of louvres variable) integrated into window head or housed in surface-mounted box on facade
  - Roller shutters (wood, aluminium, fabric) integrated into window head or housed in surface-mounted box on facade
  - Hinged, folding or sliding shutters of wood or sheet metal (folding against reveals, hinged or sliding in front of facade)
- Fixed measures, external (*brise-soleil*, canopies, fixed louvres)

#### 3. Noise

##### Wall

Owing to their lack of mass, lightweight buildings (timber or steel systems) are more vulnerable to noise. Discuss with a specialist if necessary, but not a problem in normal cases.

##### Window

Thickness of individual panes, total thickness of glazing and airtightness of joints depend heavily on the level of noise to be expected. Opening the windows for ventilation is hardly possible when noise levels are high, so mechanical ventilation will be required.

#### 4. Wind

##### Wall

Generally, all facade constructions made from small-format, jointed elements, and primarily timber wall constructions, will require the inclusion of an airtight membrane in order to overcome the problem of any gaps that occur in the joints due to swelling/shrinkage.

##### Window

The rebates in the window frame must be windproof; window frames and glass can be subject to severe wind loads.

#### 5. Soiling of the facade, water entering horizontal joints

##### Wall, window

Rain in conjunction with upward air currents can force water into horizontal joints. Therefore, horizontal components such as lintels, window sills and cornices must be provided with rainwater drips.

#### 6. Temperature

(The thermal transmittance, and hence the minimum thickness of various constructions, is specified in standards.)

##### Wall

Thermal insulation materials guarantee protection against high temperatures in summer and low temperatures in winter. Depending on the system, the layer of insulation is separate, the material provides both loadbearing and insulating functions (single-leaf masonry), or the insulation requirement is integrated into the building component (timber platform frame construction).

##### Window

- Insulating glazing
- Double window possibly with insulated frames

#### 7. Vapour diffusion from inside outside

Avoiding saturation of the construction by condensation water

##### Wall

Possible measures:

- Ventilation cavities (drying out and dissipation of moisture in an air gap outside the layer of insulation with the help of natural convection)
- Vapour barrier/check on the warm side (inside) of the insulation for components vulnerable to moisture
- Vapour-proof internal loadbearing layer, e.g. in situ concrete
- Moisture-resistant insulation, e.g. cellular glass
- Whole construction open to vapour diffusion, e.g. single-leaf masonry

#### 8. Mechanical damage

##### Wall, window

Soft surfaces (paint, some types of wood) are vulnerable to mechanical damage. Rendered external insulation is particularly susceptible (principally at base of wall, i.e., from ground level up to a height of about 2.00 m).

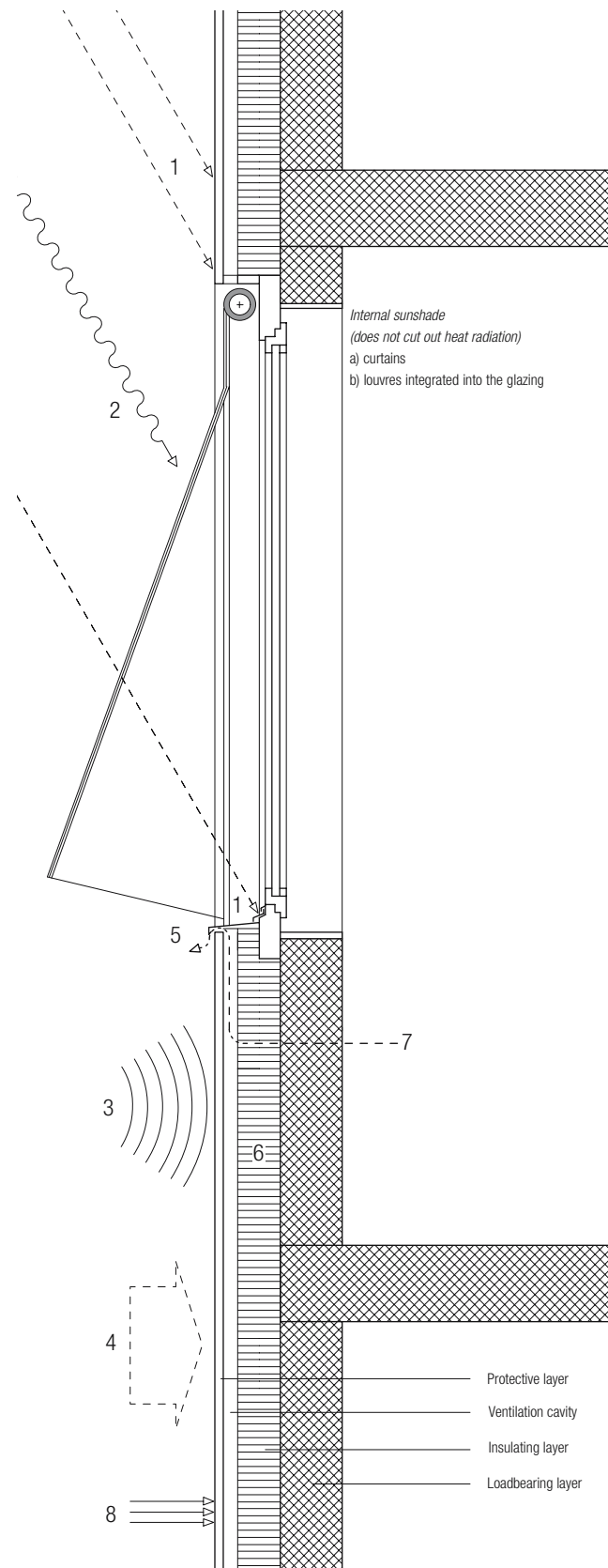


Fig. 73: Schematic section, scale 1:20

## Cutting out sunlight and glare

Patric Allemann

Protection against sunlight and glare is provided by additional elements around the opening. The task of these elements is to regulate the amount of daylight and solar radiation entering the interior, perhaps even exclude it completely. A secondary function is to provide privacy at night.

There are many ways of incorporating sunlight and glare protection measures into the architecture of a building. However, certain building performance aspects must be considered if efficient, functioning protection is to be achieved.

### Sunshading: the brief

Depending on the geographical location of a building, its exposure and the construction of its facades, solar energy can enter through the openings and lead to overheating of the interior in spring, summer and autumn. We prevent this by installing a suitable sunshading system. Basically, sunshades reduce the amount of heat radiation admitted by reflecting it. The total energy transmittance (g-value) is the means we use to assess the effectiveness of the protection, or to compare it with other systems. The g-value is the total of radiation transmitted plus secondary heat emissions to the inside and is determined through measurements or calculations. An efficient sunshade is distinguished by a high degree of reflection, which reduces the g-value accordingly. To prevent overheating of the interior, this reflection must take place before the radiation strikes the glass. If the solar radiation passes through the glass first, some of this radiation is absorbed

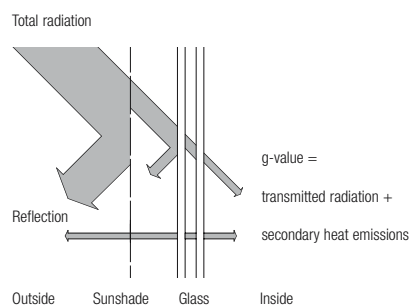


Fig. 74: External sunshade

by the internal sunshade and converted into long-wave infrared radiation. This radiation can no longer be reflected back through the glass and promotes a temperature increase inside the building. Optimum sunshading can therefore only ever be fitted externally.

### Types of sunshading

Sunshades can be designed as movable or fixed components. Examples of fixed sunshades are canopies, horizontal and vertical screens (*brise-soleil*), loggias and fixed louvres. Such elements form a vital part of the facade design. One advantage of the fixed sunshade is

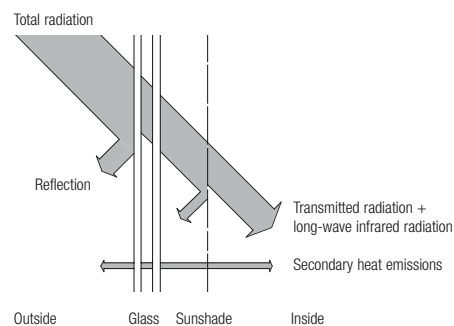


Fig. 75: Internal sunshade

that the visual relationship with the outside world remains essentially undisturbed. Depending on the form of the sunshade, an interesting intermediate layer can also be created between inside and outside which can even provide useful floor space (e.g. loggia). However, a fixed sunshade can respond to the changing solar trajectory (daily and seasonal) to only a limited extent.

A movable sunshade can be constantly adjusted to suit the position of the sun and to regulate the incoming sunlight according to individual needs. Owing to the diversity of types many design options are conceivable. During the planning it is important to consider the minimum and maximum dimensions of the respective systems. However, these dimensions vary only slightly among manufacturers of the same systems. Whereas the minimum dimension depends on the size of the opening, the maximum dimension mainly depends on the properties of the materials employed and the degree of exposure to the wind.



Fig. 76: Fixed sunshade as a tangible intermediate layer with *brise-soleil* (top) and loggia  
Le Corbusier: Unité d'habitation, Marseille (F), 1947



Fig. 77: The components of the sunshading system are housed behind an aluminium fascia and are therefore concealed when not in use. Gigon/Guyer: Bröelberg development, Kilchberg (CH), 1996

### Various types of movable sunshading

**Roller shutters:** These consist of non-adjustable slats guided in channels at the sides of the opening. When not in use the slats are rolled up around a spindle mounted near the window/door head or folded into a bunch (folding roller shutter). The degree of light transmittance is determined by the slat profile (interlinked or separate), the reflection by the material and its colour. Today, the slats are usually of aluminium, which combines a high degree of reflection with minimum maintenance. By contrast, the wooden shutters often preferred in the past require more maintenance. As an option, roller shutters can be pivoted outwards and upwards to allow indirectly reflected daylight to enter the room. The maximum/minimum dimensions for roller shutters without this feature are approx. 50/450 cm for the width and 50/400 cm for the height. During planning, the maximum permissible area of approx. 10 m<sup>2</sup> must be considered. The maximum dimensions must be considerably reduced on facades exposed to high winds (e.g. high-rise blocks).

**Louvres:** In contrast to the slats of the roller shutter, the angle of each louvre can be varied about its longitudinal axis, which enables flexible control and redirection of the incoming light. The louvres, which are made exclusively of aluminium, are guided in channels or by thin steel wires. When not in use the louvres are stored as a compact bunch at the window/door head. The minimum dimensions are similar to those for roller shutters, but the maximum dimensions depend on the louvre profile. Special care must be taken with louvres exposed to high wind loads.

**Roller blinds:** These are made of fabric and when not in use are rolled up at the window/door head. Light transmittance and degree of reflection are determined by the type of fabric. Light-coloured fabrics can scatter the incoming

light considerably and cause glare. Unlike the roller shutter, there is no option for pivoting a vertical roller blind outwards and upwards. The maximum/minimum dimensions are approx. 40/300 cm for the width and 40/400 cm for the height. The maximum permissible area is approx. 8 m<sup>2</sup>, the ideal width-to-height ratio 1:3.

**Semi-awnings:** This is an elaborate variation on the vertical roller blind which, thanks to an additional roller plus stays, can be pivoted outwards and upwards to permit a partial view of the surroundings. Apart from a minimum height of 120 cm, the maximum/minimum dimensions and maximum area are the same as for vertical roller blinds.



Fig. 83: Semi-awnings to the windows, straight-arm awnings and vertical blinds to the balconies  
Max Ernst Haefeli: Rotach development, Zurich (CH), 1928

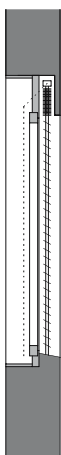


Fig. 78: Louvre blind integrated into the wall access from outside

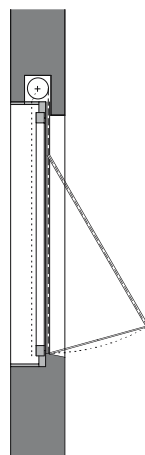


Fig. 79: Roller shutter with angled positioning option integrated into the wall access from inside

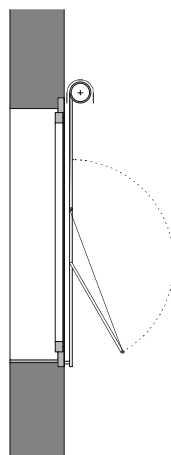


Fig. 80: Semi-awning surface-mounted access from outside

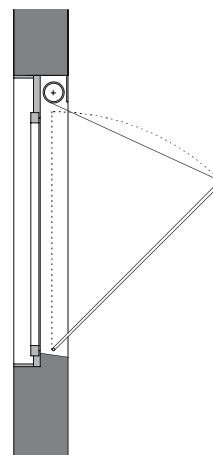


Fig. 81: Straight-arm awning mounted below the lintel access from outside

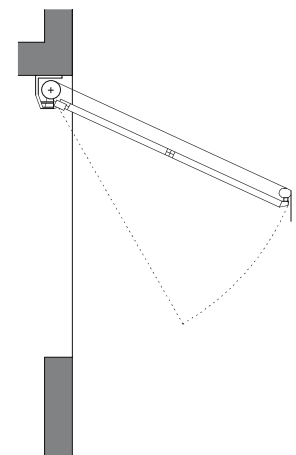


Fig. 82: Articulated-arm awning surface-mounted on soffit of balcony slab

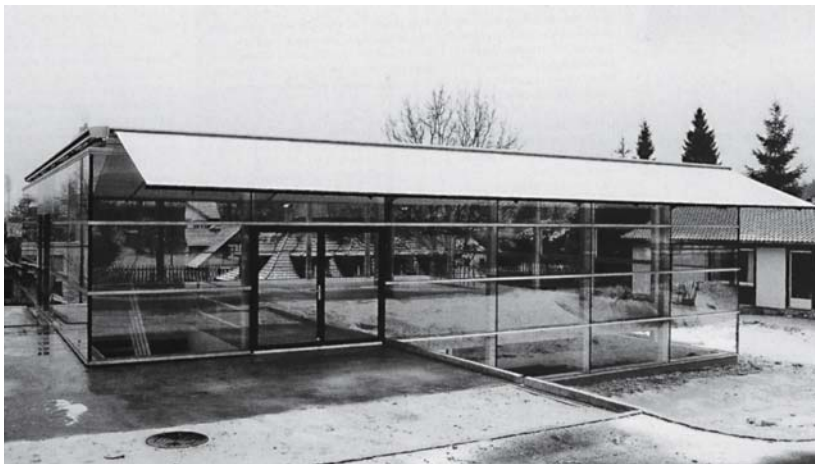


Fig. 84: Large articulated-arm awning forming a movable canopy  
Oliver Schwarz: factory building, Ebikon (CH), 1996

*Straight-arm awnings:* Two straight stays, their outer ends connected to a tube, unroll a fabric blind by means of gravity and position this at a certain angle to the facade. This type of shading was often popular for balconies in the past. The fact that the window is not completely covered guarantees a link with the outside world. The maximum/minimum dimensions and the maximum area correspond to those of vertical roller blinds; the length of the straight stays is 80–150 cm.

*Articulated-arm awnings:* Two or more articulated arms enable a fabric blind, which is rolled up when not in use, to be extended to any desired position between minimum and maximum. An additional hinge enables the angle to be adjusted as well. This is the most popular type of sunshading for balconies and patios and is also employed for shading large (display) windows. Widths of between 2 and 7 m are possible, the maximum arm length is 4 m.

*Hinged, folding and sliding shutters:* These, the archetypal movable sunshades, are usually made from wood or aluminium. When not in use, the leaves are folded together adjacent to the reveal or stored in front of a plain part of the facade. The dimensions depend on the particular window.

*Insulating glazing with integral louvres:* In this arrangement a louvre blind is integrated – gasketed – between the two panes of an insulating glazing unit. As explained above, this system does not provide optimum protection against heat radiation because the temperature rises in the cavity between the panes and some of the excess heat is emitted inwards in the form of long-wave infrared radiation. However, the system is suitable for high-rise buildings because fitting the blind between the panes of glass protects it against wind forces and soiling. A defect in the blind results in the entire glazing unit having to be replaced.

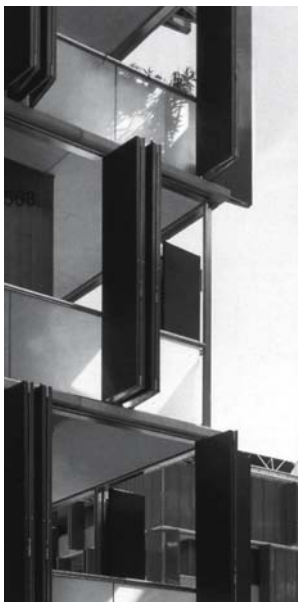


Fig. 85: Folding shutters providing sunshading for balconies  
Baumschlager & Eberle: Hötting Estate, Innsbruck (A), 1999

### Surface-mounted or flush?

With the exception of the last two examples all the other types of sunshading can be installed as surface-mounted elements visible on the facade or integrated into the window/door head detail. The latter variation results in the sunshading element being essentially concealed when not in use. One hybrid solution is the installation below the window/door head behind a fascia panel flush with the facade. Articulated- and straight-arm awnings are frequently fitted beneath the balcony of the floor above.

If the sunshading element is integrated into the window/door head detail, easy access for maintenance and replacement must be guaranteed. Furthermore, the continuity of the layer of thermal insulation must be taken into account.

### Antiglare measures: the brief

Glare is caused by direct sunlight and its reflection by internal surfaces, but also by daylight reflected by external objects (e.g. light-coloured buildings, snow-covered surfaces, etc.). In contrast to the sunshading issue, in which the heat radiation comes from a precisely defined direction, the incidence of the light and the resulting glare depends on diverse factors related to the particular conditions.

Glare is also an individual, subjective reaction influenced by the activities of the person concerned. For example, persons working at computer screens are more sensitive to glare than those writing manually at a desk.

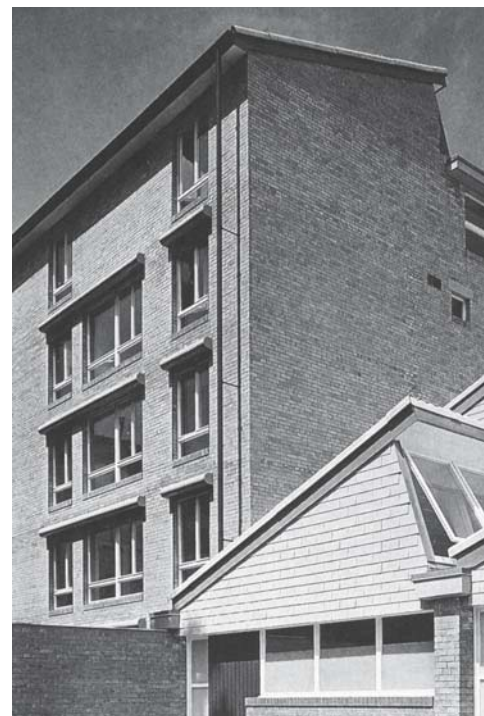


Fig. 86: Surface-mounted roller shutter boxes as a design element on the facade  
Ernst Gisel: housing and studios, Zurich (CH), 1953



Changing demands placed on the internal functions calls for a fine regulation or redirection of the incoming daylight, even complete blackout measures (e.g. classrooms).

As with sunshading, antiglare measures also involve limiting the view of – and relationship with – the outside world. This affects both the architecture (unwanted introvertedness) but also the human psyche (feeling of being excluded).

For these reasons antiglare measures should be (re)movable wherever possible. Although some of the sunshading forms described above can also prevent glare (e.g. louvres), antiglare measures are advantageous when fitted internally – for glare still occurs during the heating period when solar energy gains are undoubtedly desirable.

#### Types of antiglare measures

There are two main ways of preventing glare, which, however, can be subdivided into a number of variations.

*Curtains:* This traditional form of preventing glare and creating privacy is made from a fabric, which can be chosen to determine the light permeability. The level of incoming light can be controlled by using two or more layers of curtains with different light permeability (e.g. net curtains during the day, opaque curtains at night). However, as curtains can be moved only horizontally and not vertically, which would be necessary to track the sun properly, they must be drawn completely in order to prevent glare. Modern variations made from efficient high-tech textiles are available which achieve good reflection but with little loss of transparency. Vertical louvres, which can be rotated about their longitudinal axis, are the only form of “curtains” that permit the incoming light to be adjusted to suit the position of the sun.

*Blinds:* Vertical blinds with a corresponding opaque coating are often used to darken classrooms or other teaching facilities. Louvre blinds enable precise regulation of the incoming light, right up to complete exclusion. A relationship with the outside world is maintained by adjusting the angle of the louvres. The colour and material of the louvres have an influence on the quality of the light as perceived subjectively in the room, e.g. wooden louvres close less tightly but establish a warm light. Aluminium light-redirecting louvres guide incoming light through appropriately positioned louvre profiles into the depths of the interior and achieve consistent illumination plus a gain in passive solar energy through storage of the heat in solid parts of the building – and without any glare component.



Fig. 87: Curtains for preventing glare and for partial exclusion of the surroundings

Ludwig Mies van der Rohe: New National Gallery, Berlin (D), 1968



Fig. 88: Internal louvre blinds achieve diffuse interior lighting effects, the surroundings become blurred outlines

Alvar Aalto: Villa Mairea, Noormarkku (FIN), 1939

## The doubling of the sky

Sascha Roesler

Only when we stare at the ceiling at night do we really first appreciate it. The dream of the insomniac is that the ceiling above will finally disappear. A whole genre of 20th-century literature was dedicated to the ceiling being the counterweight to the ruminations, doubts, worries, and anticipations of the insomniac, and turned the ceiling into the canopy over the modern soul. "It is a special type of sleeplessness that produces the indictment of birth." (E.M. Cioran) The fact that in reality today we have to think in two dimensions, without structure, when considering the answer to this, is the outcome of a rationalisation process that has given birth to the flat slab of reinforced concrete being the normal case. The primary job of a floor today is to carry loads over typical spans. For economic and not architectural reasons we therefore almost always resort to flat slabs. The majority of all building tasks, residential and office buildings, are characterised by their flat slabs. Prestressing techniques mark the culmination of a technological evolution during which thinking in terms of joists and beams shifted step by step towards thinking in terms of slabs and plates. Even downstand beams, the leftovers of the old timber joists, are regarded as a disruption in modern concrete construction, not only from the economic viewpoint, and are avoided wherever possible.

In the architectural sense the flat slab of the "Dom-ino" house type developed by Le Corbusier in 1914 was programmatic. Its combination of frame and flat slab suggested a hitherto unknown degree of freedom in the design of the plan layout. The *plan libre* propagated through this system was, however, still restricted to a certain extent because the floor slab used by Le Corbusier at that time was a Hourdis-type hollow clay block assembly and the staircase was still linked to the internal beam arrangement. Concentrating the design work on the plan layout, which was finally achieved with the arrival of the flat slab, favoured the progressive neutralisation of the modern floor slab and determined the wall as the space-defining component. The view of the soffit and the plan on the floor had become merely backdrops to the space structured by the walls. Homogeneity, flatness and an indifference to direction determine not only the architectural expression of the flat slab, but are today normally the abstract prerequisites for this in order to elicit the economic efficiency of the space. And of course the floor area is also the yardstick with which the economics of an architectural project is calculated.

Today, the question is how the diversity of possible floor forms can be reintroduced into everyday building tasks. The timber joist floor, a popular method of support since ancient times – and up until the Second World War still the dominant method in the Western world –, was supplanted step by step by steel beams and reinforced concrete slabs. A quick review of the historical development prior to the flat slab shows the diversity of design

inherent in this process of development. The works of Claude Turner in the USA and Robert Maillart in Switzerland provided sufficient momentum to propel design in the direction of the flat slab with its indifference towards direction. The difference between the traditional floor supported on beams or joists, as François Hennebique used for his concrete structures, and the flat slab with flared column heads is that the flow of forces into the columns can be recognised.

No less decisive was the change in society that accompanied these engineering developments. The upsurge of the services and consumer society plus house-building for the masses led to the development of new types of construction – office towers, shopping centres, high-rise apartment blocks – and to a hitherto inconceivable manipulation of the interior environment. Building services of all kinds – sanitary and electrical lines, ventilation, lighting – are today, whether clad or left exposed, the matter-of-course elements of the modern floor. So the floor has turned into a complex "flooring system", the horizontal component upholding the interior environment. Polytechnical versatility – regardless of the material of the loadbearing structure – has now become the technological characteristic of the floor (and hence the ceiling). Layer upon layer, above and below, the structural floor designed to carry loads has been given new functions over the past 100 years in order to meet all the newly emerging social needs. To the layman the "ceiling" is the soffit of a horizontal layer of the building – the surface that spans over our heads. But considered as a complex, multi-layer component, the ceiling is also the underside of the floor to the next storey. Impact sound problems from above or a fire demonstrate not only the separating but also the bonding character of this component. Accordingly, we must distinguish between – and consider the mutual dependency of – the phenomenology of the soffit as a boundary and the technical treatment of the floor as a component that includes the floor construction of the storey above. This mutual dependency becomes especially clear in expansive interiors where the floors span considerable distances. The "underside" must be and is visible but direct access is not possible. The sheer expanse of the floor component calls for ingenious structural solutions. Starting from this double meaning – the floor as soffit and as component –, I shall discuss three conceptual approaches in the following, approaches that characterise the architectural handling of floors – and soffits – to this very day. Irrespective of the particular materials used, these approaches seem to me to show the correlation between the visibility and technicisation of the floor, an aspect that increased with Modernism.



Fig. 1: Flared-head columns in reinforced concrete (diameter varies with storey, or rather load)  
Robert Maillart: grain warehouse, Altdorf (CH), 1912

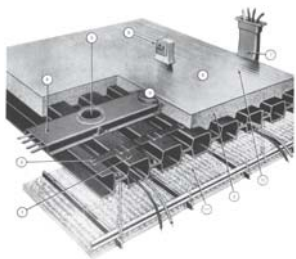


**Fig. 2: The roof as a “baldachin”**  
Frank Lloyd Wright: office building for Johnson Wax company, Racine (USA), 1940–50

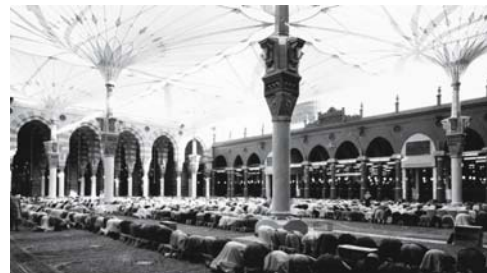
- The soffit as a canopy: Now, as ever, the soffit exposes those assembled below, brings them together, highlights individuals, causes them to rely on themselves. The soffit as an artificial sky, the symbolic character once attributed to the soffit, is echoed sometimes more, sometimes less distinctly in modern soffit finishes.
- The stacking nature of the storeys: As the construction of high-rise structures started to evolve, the stacking of the storeys became not only a technical challenge to many advocates of Modernism but also a social Utopia. Architectural expression and social consciousness can be found in the repetition of the floors.
- The longing for a different spatial order: The opposite nature of walls and floors seems to be obvious in everyday building. But in fact since the dawn of Modernism we have seen, again and again, attempts to dissolve this oppositum, to create continuity between wall and floor, wall and soffit, above and below, inside and outside.

### Baldachins

“Baldachin” is another word for canopy and is derived ultimately from *Baldacco*, an early Italian name for Baghdad. Originally, it was the name of a precious silk which was imported into Europe from Baghdad. Owing to the exclusivity of this silk material, it was used as an ostentatious textile ceiling over the heads of the powerful and important. The simple supporting framework, four poles were enough, reinforced the notion of a surface floating free in space. The baldachin made possible a wall-less space within a space, and it was precisely this that showed those underneath to be unapproachable. The idea of an individual sky for those persons who have to be protected, those whose outstanding individuality has to be emphasised, is unmistakable here. Portable versions of the baldachin (testers) are still used today in religious processions. What has remained, however, is not such temporary sky imitations but instead permanent, domelike canopies of timber or stone to cover the bodies of the living – the thrones of kings, the testers of bishops, the beds of princes – and the substitutes for the dead – statues on tombstones.



**Fig. 3: Structure of a steel cellular floor deck dating from the 1950s**  
from bottom to top: fire-resistant suspended ceiling, cellular floor deck, transverse duct for services, floor covering

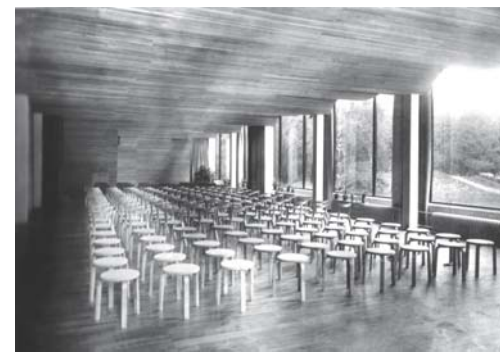


**Fig. 4: Convertible umbrellas in the courtyard of the Mosque of the Prophet**  
Frei Otto, Bodo Rasch, Jürgen Bradatsch: Mosque of the Prophet, Medina (Saudi Arabia), 1971

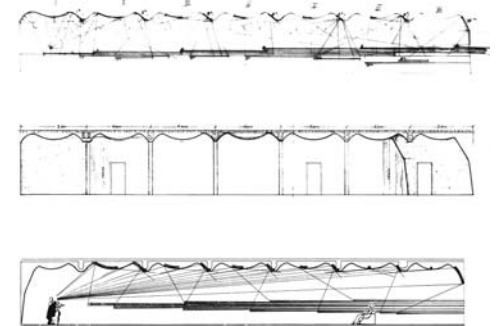
Looked at in this way, the baldachin is a reduced form of covering, a gesture of presentation and not a mere utility surface. This distinguishes the baldachin of the Middle Ages from our present perception of the soffit. The baldachin creates a symbolic space below itself, but not an accessible surface above. To access the “floor” above – to walk on it – would be regarded as a symbol of its profanity! To this day, the floor–soffit coalition still remains in this dilemma, trapped between symbolic meaning and profane use.

### Cladding

The suspended ceilings used today in so many different building projects remind many of the baldachin, rendering visible a will to present the modern individual in his or her daily business and lend him or her comfort and



**Fig. 5: Alvar Aalto: public library, Viipuri (RUS, formerly FIN), 1927–35**



**Fig. 6: The sections show the wave-like shape of the suspended ceiling. Acoustic considerations governed the shape of this wave.**  
Alvar Aalto: public library, Viipuri, (RUS, formerly FIN), 1927–35

security. Even the simplest suspended ceilings in open-plan offices are evidence of the attempt to harmonise complex interior environment requirements with a certain degree of architectural representation. In many places it is the suspended ceiling and not the soffit of the loadbearing floor component that is seen internally. And this boundary layer meanwhile has to fulfil countless functions. As the spatial expression of technical necessities (fire protection, sound insulation, lighting units, loudspeakers, sprinkler systems, etc.), the finished ceiling in architectural terms is all too often merely a compromise. The double

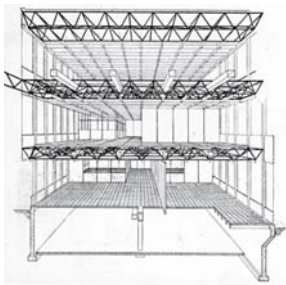


Fig. 7: Perspective view: all services are routed within the depth of the lattice floor construction.

Eero Saarinen & Associates: General Motors Corporation Research Centre, Warren, near Detroit, Michigan (USA), 1951–57

effect of a suspended ceiling – it is a form of cladding and at the same time creates an intermediate space – results in an architectural effect whether we like it or not.

The cladding character of this layer favours an inherent logic unconnected with the loadbearing structure, which was nevertheless attributed to it again and again in the history of building. Whether the textile-like timber soffits of Alvar Aalto or the pictures projected onto the ceilings of a hotel in Lucerne by Jean Nouvel, the soffit as architecture becomes an image, and the soffit cladding the *leitmotif* for the whole building.

The textured soffits like those devised and used by Robert Maillart, Pier Luigi Nervi, Frei Otto, Heinz Isler, or Santiago Calatrava also take on a similar, clad character. The difference between loadbearing structure and cladding has become obsolete in the works of these engineers. Gottfried Semper was surely the first to press for such a view of architecture. He recognised the link between the German words *decken* (to cover), *entdecken* (to discover) and *Decke* (the German word for floor component and ceiling), which showed the gestural nature that had once accompanied the origin of these things and so



Fig. 8: Detail of floor construction: V-shaped precast ferro-cement elements; wall thickness: 3 cm; total depth of floor (incl. floor finish): 50 cm  
Pier Luigi Nervi: Galbani office building, Milan (I), 1955/56



Fig. 9: Galbani office building Milan (I), 1955/56  
Reinforced concrete floor by Pier Luigi Nervi  
Design: E. Soncini, A. Pestalozzo

permeated architecture as well. The ceiling, a covering, enclosing, protecting structure, is simultaneously tangible and intangible. Its textile nature as given by the language undermines the image of a heavyweight floor structure above us. Semper shrinks the three-dimensional separating layer to an incorporeal surface – skin, textile, clothing, coating: “In all Germanic languages the word *Wand* [wall] (of the same origin and basic meaning as the term *Gewand* [garment/vestment]) refers directly to the ancient origin and epitome of a visible space termination. Likewise, cover, cladding, barrier, seam, and many other technical expressions are not symbols of language applied late to building, but rather certain indications of the textile origins of these components.”

In buildings with extensive services the various media – electricity, heating, water, ventilation – require their own zone, which can occupy a considerable depth, in some cases even the full height of a storey. In the Salk Institute in La Jolla (Louis Kahn, 1965) the services zone became an accessible room in order to ensure simple maintenance and upgrading.

In an architectural sense the Centre Pompidou in Paris (Rogers and Piano, 1976) marks the culmination of the progressive technicisation of the building. This structure witnessed the first-ever application of the preliminary ideas of Archigram and others stretching back 15 years. The building services were no longer the shameful thing that must be hidden but instead had become the governing spatial principle of the building. Le Corbusier’s vision of the modern building as a machine had been turned into a hands-on experience here by displaying the technical infrastructure – the building as a stage for the building services.

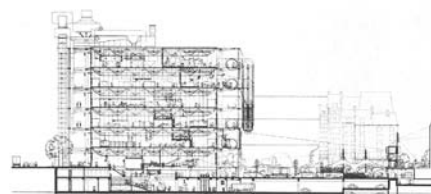
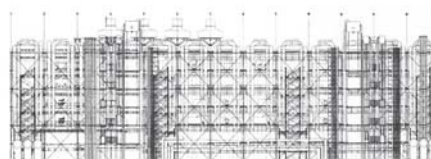


Fig. 10: Lattice beams at 13 m centres each span 48 m without any intermediate columns and therefore ensure maximum flexibility for the interior. The building houses a museum of modern art, a centre for industrial design and a public library.  
Renzo Piano & Richard Rogers: Centre national d’art et de culture Georges Pompidou, Paris (F), 1976

### Stacking

If the thread towards the profane means an advancing utilitarianism – becoming secular, worldly – of things, then the modern floor–soffit conglomerate is the place where this process has become particularly effective. Defying all handed-down symbolism, it is the most profane of all building components. No other component has been transformed to such an extent in the course of the technical and functional developments of Modernism. The brief and the technologies have changed radically within a very short time and opened up new design opportunities for architects and engineers. It was also the arrival of the skyscraper at the start of the 20th century that characterised the structure and significance of the floor and its soffit





Fig. 11: The cantilevering floor slabs, used as balconies, reinforce the layered nature of the two towers.  
Bertrand Goldberg: Marina City, Chicago (USA), 1959–64

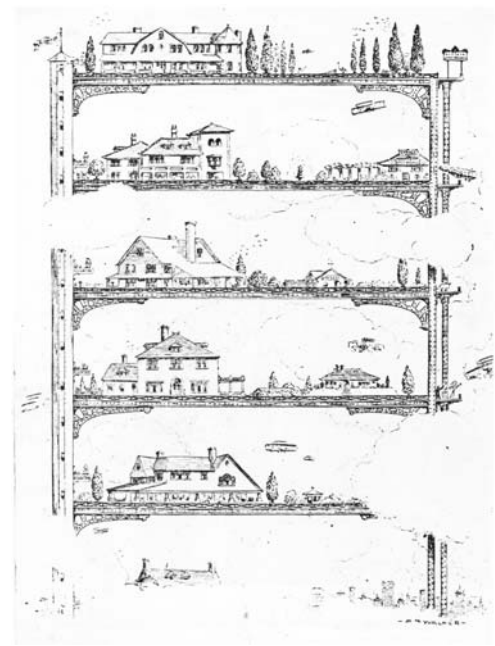


Fig. 13: Rem Koolhaas: “The skyscraper as utopian device for the production of unlimited numbers of virgin sites on a single metropolitan location.”  
Reproduction of a caricature taken from *Life Magazine*, published in 1909

decisively. They became a “separating layer” in a vertical stack and an “infrastructure zone” for horizontal services.

“Everything is devoid of gods” is how Cioran succinctly expressed the terminus of this increasing profanisation – and in doing so forgot that it is precisely this absence that prepares the ground for religious input. The glorifying of the profane, which had been elevated to a precept by the beginning of the 20th century, would have been inconceivable without the increasing technicisation of living conditions. Right from the start this glorification was charged with Messianic characteristics, the salvation of the individual. Within this, “feasibility thinking” tallied with the far more vague notion of “homelessness”. Both were embodied symbolically in the new high-rise buildings. No other type of building inspired such flights of fancy as the skyscraper rising skywards. Like no other type of building before, the high-rise block embodied the realisable opportunities of a society fascinated and surprised by modernisation. In all this, the floor component has become the platform for these opportunities and the dominating structural element in the facade. It was only the multiple stacking of the floors that had rendered both of these architectural phenomena visible. Peter Sloterdijk called the “serialism” of such stacking as the “transition between elementarism and social Utopianism”. Stacking leads to both architectural and social added-value.

The floor component becomes the structuring principle of the facade; the building rising vertically is given a horizontal component. The Marina City towers in Chicago designed by Bertrand Goldberg are excellent examples of

this. Here, the cantilevering floor slabs reinforce the layering of the building. This pair of towers represents a rare example of high-rise architecture using balconies.

Multiple stacking establishes a direct relationship between the repetition of identical storeys and the appearance of the entire building. Rem Koolhaas devised a formula for this: the greater the number of storeys, the more lasting is the impression of the overall form. In his famous study of the skyscraper architecture of New York (*Delirious New York*) he includes a caricature of a skyscraper that appeared in *Life Magazine* in 1909. The building, drawn as an iron frame, consists merely of a stack of country houses and their associated gardens. The underlying thought of a storey-by-storey stacking of different worlds turns architecture into the infrastructure for individual, storey-related fantasies. The building, generally conceived as a functional unit for a principal usage, dissolves into disparate storeys for this or that function. The floor becomes an artificially created, empty island that can be occupied and made habitable from time to time. The inheritance of this architectural development – the storey as an array of opportunities and a standardised element in a larger whole – has brought benefits for low-rise buildings, too. A faithful implementation of this concept could be seen at the World Exposition EXPO 2000 in Hannover in the form of the Netherlands pavilion designed by MVRDV. The floors in this pavilion functioned as platforms for man-made, independent landscapes visible to visitors even from afar.



Fig. 12: The floor providing texture on the facade  
Hideo Kosaka: Post Office Savings Bank, Kyoto (J), 1954

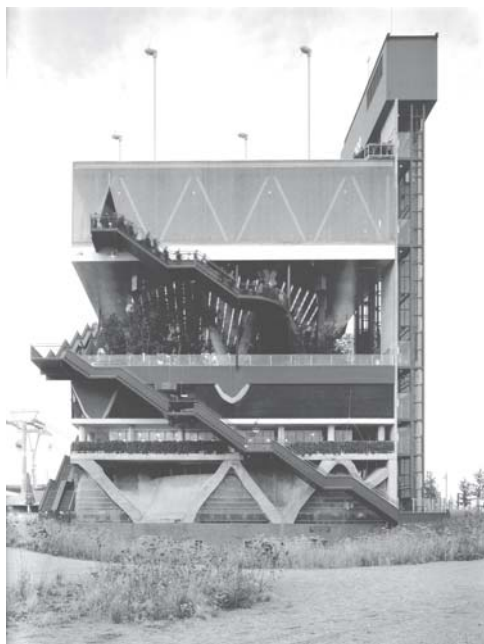


Fig. 14: Stacked landscapes ("Isn't the issue here new nature?")  
MVRDV: Netherlands pavilion at the World Exposition EXPO 2000 in Hannover (D)

### Möbius strips

In 1865 the German astronomer August Ferdinand Möbius described an infinite, curved surface in three-dimensional space that has just one edge and hence no distinguishable top and bottom. If we run a finger along the Möbius strip, we reach the other side of our starting point. This is due to the twist in the surface within its development. Depending on the position on the surface, what was formerly inside is now outside, the outside turned to the inside. Orientation in a conventional sense is not possible with such a figure because every segment of the surface is given an opposite meaning during the development. Conventional terms for describing spaces, like above and below, left and right, front and back, do not apply.

Just how much architecture is duty-bound to observe such terms in its thinking is demonstrated in practice, where the basic building blocks are walls and floors. The Möbius strip is therefore an example of a three-dimensional anti-world whose description and realisation depends on discovering new terms. Levels and no longer storeys, inclines and no longer walls and floors, fluid transitions and no longer enclosed spaces will probably dominate this anti-world. Landscapes and urban lifestyles are the models for an architectural realisation. Attempts to render such different spaces conceivable have accompanied the modernisation of architecture from the very beginning. The dream of the levitating surfaces of Russian Constructivism was also the dream of a floor that had discarded its supporting structure. Even the laws of gravity were relieved of their validity at this moment of social upheaval.

### Diagonals

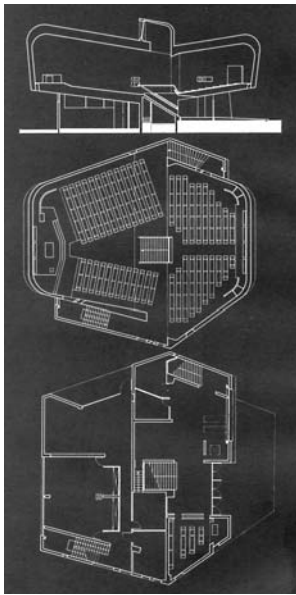
An awareness of vertically stacked interior spaces was Adolf Loos' starting point and goal, and he hoped that his breakthrough would come with the new frames of reinforced concrete. Loos developed his method of design, which was intended to overcome the traditional thinking in independent storeys and which only became known as the "spatial plan" later, in the 1920s, in the premises of Goldman & Salatsch in Vienna (1911). Levels made visible and storeys no longer separated from each other characterised this building. The floors became effective interior design elements, more space-generating than space-enclosing objects. The various functional zones were differentiated by way of distinct storey heights – 2.07 m for the seamstresses seated at their machines, 3.00 m for the cutters standing at their tables, 5.22 m for the steam-filled pressing room – and this had to be compensated for constantly through mezzanine floors, galleries and landings, the edges of which were therefore exposed internally. This constant up and down gave the connecting stairs the character of a route, a path. The principle of stacking the storeys, so fundamental to modern architecture, had been conceived for the first time – alternatively – as an intertwining of vertically stacked levels.

Whereas Loos' floors were designed as platforms that lent his architecture its specific interior atmosphere, some 40 years later the French architect Claude Parent elevated the terrain to the space-forming fundamental principle.

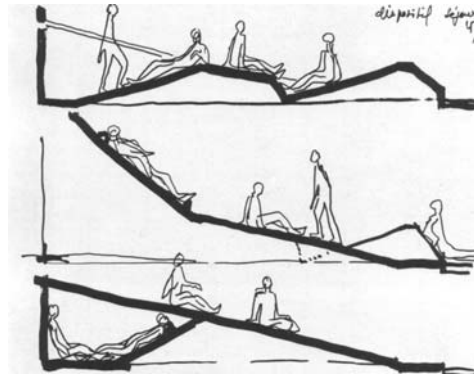


Fig. 15: Different levels made visible  
Adolf Loos: Goldman & Salatsch premises, Vienna (A), 1909–11

The ground, regardless of whether it was natural or man-made, established an abstract space continuum and contrasted a world of functional, separate spaces with another one involving fluid transitions and networking. Parent, like no other architect before him, placed the slope – the reflex to a terrain seen as sculpted – at the focus of his architectural creativity. He proposed the incline plane (*fonction oblique*) as a possibility for a different experience of space contrasting with the three-dimensional Cartesian system represented in architecture by walls and floors. Imbalance



**Fig. 16: The first implementation of the *fonction oblique*: the nave is dominated by two sloping roof slabs.**  
Claude Parent & Paul Virilio: Saint-Bernadette du Banlay à Nevers (F), 1965



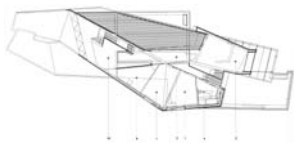
**Fig. 17: "Life on the slippery slope!": Sketches for *fonction oblique* (structure of living area)**  
Claude Parent



**Fig. 20: The Möbius strip as a code for hitherto unknown geometry**  
Foreign Office Architects: Virtual House, 1997

and destabilisation, the consequences of living on sloping planes, were Parent's guarantee for space perceived once again as authentic and corporeal. The architecture should thus contribute to testing a new, hitherto unknown experience of space.

It was only after the introduction of CAD for architects on a wide scale that the designs proposed decades before by Loos, Parent, and others began to find wider acceptance in everyday architectural practice. Furthermore, since the beginning of the 1990s we have seen the publication of architectural designs that elevate the landscape to a new model of urban architecture. Thinking in layers creates continuous surfaces extending beyond storeys and buildings, and in doing so distinctions such as floor and wall, inside and outside, lose their significance. It is no mere coincidence that architectural practices such as Unstudio and Foreign Office Architects are experimenting with the Möbius strip as a code for hitherto impossible geometry. Floors and walls are losing their horizontal and vertical definitions, are becoming curves, ramps, diagonals and folds, and since then persist in a zone of indistinguishability.



**Fig. 18: Plan of Möbius House**  
UN Studio/Ben van Berkel & Bos: Möbius House, Amsterdam (NL), 1993–98

#### Further reading

- E.M. Cioran: *The Trouble With Being Born*, New York, 1976.
- G. Semper: *Der Stil in den technischen und tektonischen Künsten*, Erster Band, Frankfurt a.M., 1860. – English translation: G. Semper: *Style in the Technical and Tectonic Arts; or, Practical Aesthetics*, vol. 1, Munich, 1860.
- P. Sloterdijk: *Spheres III – Foams*, Frankfurt a.M., 2004.



**Fig. 19: Wall and floor, inside and outside lose their significance as distinguishing features.**  
UN Studio/Ben van Berkel & Bos: Möbius House, Amsterdam (NL), 1993–98



## The roof

*Francesco Collotti*

Flat or pitched roof? We are not interested in pedantically reconstructing the position of this or that person, and we certainly do not intend to play the game of those who, taking the form of the roof as their starting point, distinguish between good and bad, progress and tradition, vernacular architecture and International Style. If we had been alive in the early 1930s, we would have been forced to take sides in favour of one tendency or a tendency of a tendency. We would have chosen Modernism or perhaps even those deliberate exaggerations that prevent moderate positions in revolutionary moments. Or we would have chosen another, more traditional Modernism that was pursuing the ancient myth of architecture and trying to evocate already forgotten briefs for this discipline.

Today, we no longer have to do make such categorical decisions and can permit ourselves the liberal pursuit of a non-dogmatic eclecticism which allows us to assemble dissimilar and sometimes contrasting worlds of forms in one and the same composition. We can therefore reconstruct – with a leisurely calmness and cheerfulness – the arguments of one or other position with respect to new trends. On the one hand, we acknowledge the ability of Modernism to re-establish the discipline, but at the same time we are conscious of the dogmatic inflexibility that precluded the “Neues Bauen” movement from inspiring permanent, local monuments and turning them into stone. On the other hand, now that we have had time to reflect on the ideological polemics we can recognise the motives of that rear-guard action that was in the position to conduct a dialogue with tradition, the local monuments and the slow passage of time, which for their part are linked with habits and an everyday life consisting of repetitive gestures, of normality, banality, coincidence.

The wise and moderate stances appear today to be more durable than the categorical avant-garde, also more convincing than the exasperated reactionary. In the flat-versus-pitched-roof debate everybody claims to have good reasons for underpinning the validity of his or her own proposal, and everybody wants an appropriate roof which protects and is simple. But what is an appropriate roof? Is it a roof that covers well? Or is it a roof that finishes off the building? Or is it a roof that conveys the impression of covering well and finishing off the building by remaining in the background as far as possible? Or is it a roof that beyond being a good covering and finishing off the building also presents a protective and powerful form?

Few speak about the roof as one of the archetypal and generating motifs of building work, the roof as an intrinsic form and image. The roof is related to the myth of construction and with the original instinct to protect ourselves. Perhaps the origin of the roof has something to do with the ancient idea of space, namely, the tent (in its most primitive or most cultivated forms, e.g. Asplund or Lewerentz). The nomads as tent-users and the settled tribes who built

earthen or stone terraces and pyramids represent two different and separate worlds. But both can be seen in the same picture. The roof goes hand in hand with the myth of construction, this oldest of all human gestures, to cover and protect ourselves. According to the extraordinary portrayal by Piero della Francesca, the cloak of the Madonna is simultaneously protection, house, tent and roof. And even if there is apparently no roof, i.e., also if it is not clearly present, it exists (consider the well-contrived house without a roof from the exercises of Paul Schmitthenner).

So the roof is a longing on the part of the building, a desire for a covering, the promise of protection, as well as completion. The roof finishes off the building. In some countries raising the roof is celebrated. This holds even for those flat roofs that some would like to banish from the family of roofs altogether for ideological reasons, for the simple reason that we do not see them. On the contrary, we sense flat roofs, even when they are not directly visible, or we try to make them noticeable. Sometimes all the good architect needs is a delicate cornice, subtle profiling, a narrow joint in the render, a small strip of sheet zinc or copper to convey the impression of the roof. At the Tuscolano Estate (Rome, 1950–54) Adalberto Libera used the remnant of the roof, a sensitive, interrupted, gently animated line, to mark the end of the facade – and the start of the roof. It is a lightweight wing ready for take-off, a discreet but important symbol. For Le Corbusier in an apartment for Charles de Beistégui in Paris (1930–31), the roof is reconquered space, the place for a modern hanging gardens, a place removed from the tight-fisted sellers of roofing tiles and slates. It is a wonderful place, natural and artificial, a space in the city but at the same time above it, outside the hustle and bustle of the metropolis. The height of the walls that enclose the terrace is such that only some Parisian landmarks are visible – the most important ones. A place in which the city seems surreal, the object of abstract contemplation, cleansed of and alienated from context. The roof, the open hall of the house (the flat roof as living space – Sigfried Giedion).

In any case the roof is related to the mythical archetypal forms which – even after successive metamorphoses, transfigurations and alterations – are still recognisable in the elements of architecture. For centuries the gable was a reminder of the roof in the facade (e.g. Heinrich Tessenow).

The roof is loaded with significance: it can be indiscreet. In some cases it will do anything to become visible. The roofs of ancient Greek temples on Sicily were announced through colourful architectural features rich in motifs, metopes and triglyphs, which for their part told of even older wooden temples that used decorative elements to preserve the memory of construction techniques (the little lion half-head gargoyles on the long sides spouting the water from the hipped roof surfaces). The roof includes figures and



symbols, it terrifies those who threaten the sanctuary (Norwegian stave churches with dragons' heads; the roof as the protective shell of an animal).

It is not just by chance that the roof suggests similarities between building and shipbuilding (in the arsenal at Venice the roof also serves as a crane for building ships). In theatre design the roof becomes a very complex part of the stage machinery, a place for producing special effects and illusions (Friedrich Weinbrenner, Karl von Fischer).

The roof and the locality: the roof always generates symbols, distinguishes one place from another, and not just for reasons of climate. The roof and its materials invoke a certain town, a certain atmosphere. The copper roofs of Paris call forth the idea of city architecture. All impressions that characterise a certain town or region are expressed through their roofs. The roof covering Giovanni Michelucci's Borsa Merci in Pistoia can never be seen in its entirety. It is a drawn shadow. As in other towns in Tuscany it is a fine line, an obviously lightweight structure with a great overhang, dark, rich in shade. We feel that the roof fulfils its function, but we see only the underside of the gutting eaves.

Mario Ridolfi regards the roof as a masterpiece of craftsmanship with an ancient origin, a traditional form that again and again is made more complex and adapted to suit the demands of the plan. A thick body of terracotta tiles, a powerful motif whose principal components are the ridge and all the elements of a cultivated, hand-crafted tradition. (There is something Baroque in all this, as if Borromini had been reborn in small architectural constructions.)

Jože Plečnik created an urbane figure out of the roof by converting a nonuniform terrace of houses into large-scale urban architecture (Trnovo, 1944). The roof can unite the spirit and soul of a people: a great hall in which a whole community can recognise itself again and to which it is called at important moments (Tessenow, community assembly hall, 1941/42, and local government forum, 1941). The roof is an unmistakable place in the centre of the town, the *coperto* tradition in Lombardy: a collective urban place covered by a roof supported on columns where we sometimes find a fountain, or benches for discussing, voting, recognising ourselves as a community, or, in a pragmatic way, for exchanging goods, buying, trading. In this case the roof, as an architectural element, can become a style. The changes to and rationalisation of the *coperto* reappear in many neoclassical works. Fluctuating between a vernacular architecture that is ennobled by various architectural features, and an enlightened, cultivated and, in a way, deprovincialised architecture, such neoclassical works embody a certain ambivalence. The roof as a boundary condition, as an interrupted figure between town and country... (the Coperto dei Figini in the cathedral square in Milan, destroyed c. 1850).

*Roof, character, identity:* In converting many palaces and large country houses Karl Friedrich Schinkel modified

the form of the roof. This gesture demonstrates an attempt to transform the rural character of the aristocracy into a learned and less provincial one.

The roof can be a structure totally independent of the building it covers, but also an inseparable element fundamental to the functioning of the construction. A room in which to dry grain and cereals, a room for the tackles, winches and pulleys for hoisting, for vehicles and bales of straw. In some examples in the Alps the roof descends from the highest point of the house to support the timber beams that run past the solid, white-rendered walls. Consequently, the roof is transformed. It is perforated; it is a thin textile material consisting of horizontal bars and a transparent timber lattice, filtering the light.

The vulnerable roof: a body that reacts to the weather, is sensitive to the prevailing wind and rain (Lois Welzenbacher's house in Grödnertal). In other situations the roof opens up to gather the sunlight from the valley, to provide a view of the mountains (Gio Ponti's Hotel Valmartello or Jože Plečnik's mountain house).

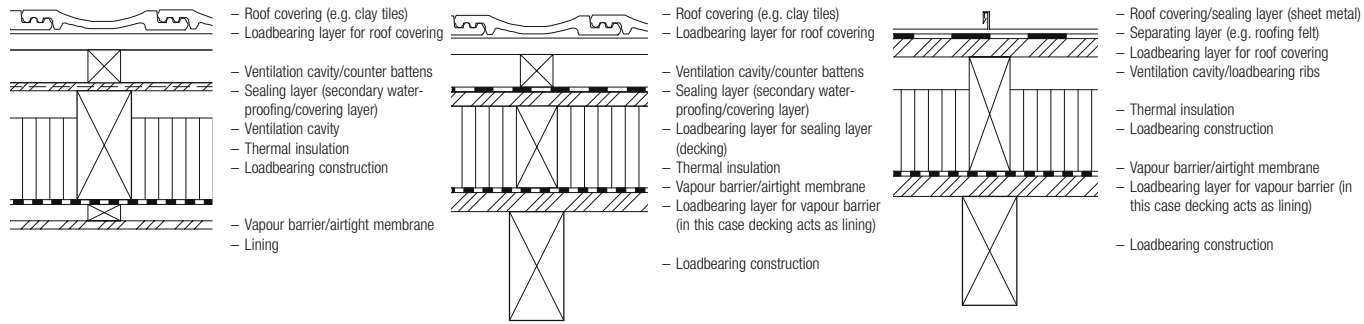
Provisional conclusions (with less certainty, many doubts and various unanswered questions): in Modernism a number of rich and fruitful positions dealing unreservedly with the subject of the roof exist and prosper alongside the official position and classification. We have noted that further in-depth research, like the current treatment of the roof, may never be ultimate, categorical or rigid. For the roof, as in the past with the facade or ornamentation, it is the attempt to find a solution that is important, not the stubborn pursuit of a principle. Take the work of Ignazio Gardella. During his life he was a protagonist of the fight that led the architectural culture of our century to renew its vocabulary, but together with others – Rogers, Samonà, Quaroni – he tried to prevent the vocabulary of Modernism from becoming a new style. Modernism is an intellectual attitude, a way of behaving with respect to reality. So Gardella's flat roofs of the 1930s, when the aim was to take up a demonstrative position, are almost a manifesto; but then we have in the postwar years his roof to a church in Lombardy, the roofs to workers' houses in Alessandria, gently placed on the buildings, the variation on a traditional form of roofing to the house of a vineyard owner between the vines on the slopes...

It is for all these reasons that the roof and its form cannot be reduced to a single slogan. I believe we have to read all the forms extant in Modernism, not only those of the avant-garde. The various souls of Modernism. It is to recognise the fact that we can no longer wallow in the belief that architectural experience begins and ends with Modernism. Today, Modernism can relate to monuments in a new light, reflect in a new way on the total architectural experience over the course of time. And it will continue to learn from these.

Excerpt from:  
Francesco Colotti: *Architekturtheoretische Notizen*,  
vol. 1 of the *Bibliotheca series*,  
pub. by Martin Tschanz, Lucerne, 2001.

## Pitched roof

### Functions of layers



**Fig. 1:** Pitched roof with secondary waterproofing/covering layer of overlapping sheets (cold deck)

**Fig. 2:** Pitched roof with seamless secondary waterproofing/covering layer (warm deck)

**Fig. 3:** Pitched roof without secondary waterproofing/covering layer (cold deck)

### Designation of layer

### Function

<b>Roof covering</b>	<ul style="list-style-type: none"> <li>– Protection against the weather (rain, hail, snow)</li> <li>– Protection against fire</li> <li>– Reflection (solar radiation)</li> <li>– Arrangement of the roof surface (on plan)</li> </ul>
<b>Supporting layer for roof covering</b>	<ul style="list-style-type: none"> <li>– Battens or decking for fixing the roof covering</li> </ul>
<b>Ventilation cavity</b> (in counter batten layer)	<ul style="list-style-type: none"> <li>– Ventilation of roof covering</li> <li>– Ventilation of timber battens (keeping them dry)</li> <li>– Dissipation of air heated up by solar radiation in summer (primarily a problem with dark roof coverings)</li> </ul>
<b>Sealing layer</b> (secondary waterproofing/covering layer)	<ul style="list-style-type: none"> <li>– Protection against soiling (dust, soot, drifting snow, wind)</li> <li>– Protection for layers underneath (thermal insulation)</li> <li>– Draining of water that has penetrated an overlapping roof covering (ponding)</li> <li>– Temporary protection to structural shell during construction until roof is completed</li> </ul>
<b>Ventilation cavity</b> (cold deck only)	<ul style="list-style-type: none"> <li>– Dissipation of any external moisture that may have penetrated the secondary waterproofing/covering layer</li> <li>– Dissipation of warm, moist internal air in winter (prevention of condensation)</li> <li>– Dissipation of air heated up by solar radiation in summer</li> </ul>
<b>Thermal insulation</b>	<ul style="list-style-type: none"> <li>– Protection against or delay of cooling in winter and temperature rise in summer</li> <li>– Insulation can be laid above, below or between loadbearing members (problem: sealing of joints with rafters)</li> </ul>
<b>Loadbearing construction</b>	<ul style="list-style-type: none"> <li>– Carries dead and imposed loads (snow, wind, etc.)</li> </ul>
<b>Airtight membrane, vapour barrier</b>	<ul style="list-style-type: none"> <li>– Protection against uncontrolled ventilation losses in the voids above and the associated condensation</li> <li>– Protection against warm, moist interior air diffusing into the roof construction</li> <li>– Protection against formation of condensation in cooler zones</li> </ul>
<b>Lining</b>	<ul style="list-style-type: none"> <li>– Termination of internal space, inner surface to roof void</li> <li>– Protection against surface condensation (moisture buffer)</li> <li>– Stores internal heat (avoids “stuffy” climate)</li> </ul>

### Materials, thicknesses

<ul style="list-style-type: none"> <li>– Clay or concrete roof tiles, slates, fibre-cement, sheet metal (approx. 2–40 mm)</li> </ul>
<ul style="list-style-type: none"> <li>– Roof battens, 24 x 48 mm (primarily for all small-format roof coverings), spacing approx. 15–30 cm, depending on roof covering</li> <li>– Timber decking, 27 mm (primarily for thin, sheet-like roof coverings)</li> </ul>
<ul style="list-style-type: none"> <li>– Counter battens, 24 x 48, 48 x 48 or 60 x 60 mm, spacing approx. 60 cm</li> </ul>
<ul style="list-style-type: none"> <li>– Bituminous felt, 3 mm, on 27 mm timber decking</li> <li>– Special plastic sheeting, vapour-permeable, 0.2 mm, on 27 mm timber decking</li> <li>– Fibre-cement sheets, approx. 4 mm, laid with overlaps</li> <li>– Timber boards, 6–24 mm (waterproof hardboard)</li> </ul>
<ul style="list-style-type: none"> <li>– min. 40 mm or as calculated</li> </ul>
<ul style="list-style-type: none"> <li>– Mineral wool, foam plastic (PU + PS), min. 120 mm or as calculated</li> </ul>
<ul style="list-style-type: none"> <li>– Timber, steel, reinforced concrete, cross-section according to structural analysis</li> </ul>
<ul style="list-style-type: none"> <li>– PE and PVC sheeting, kraft papers, approx. 0.2 mm</li> </ul>
<ul style="list-style-type: none"> <li>– PE and PVC sheeting, aluminium foil, approx. 0.2 mm</li> </ul>
<ul style="list-style-type: none"> <li>– Timber</li> <li>– Gypsum (plasterboard)</li> <li>– Wood-based materials</li> <li>– Plastered</li> <li>– Wood-cement boards</li> <li>– Wood panelling</li> </ul>

## Flat roof

### Functions of layers

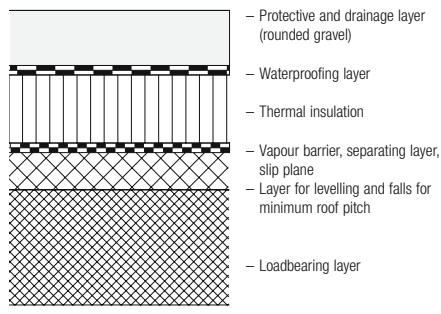


Fig. 4: Flat roof without ventilation (warm deck) not accessible

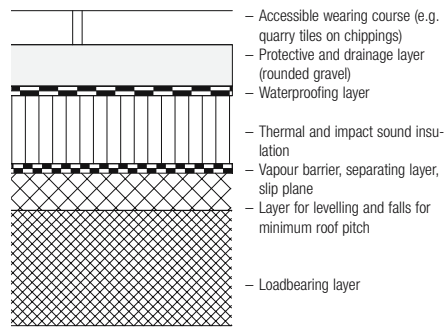


Fig. 5: Flat roof without ventilation (warm deck) accessible

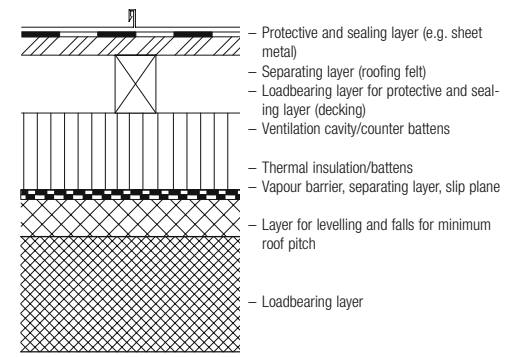


Fig. 6: Flat roof with ventilation (cold deck) not accessible

### Designation of layer

#### Wearing course

- For foot or vehicular traffic
- Vegetation layer, extensive or intensive planting systems

#### Protection and drainage layer

- Protection of sealing layer (or thermal insulation in upside-down roof) against mechanical damage and ultraviolet radiation, provides ballast for underlying layers (wind suction)

Single- or multi-ply layer to seal the structure against rain, snow and meltwater

#### Separating layer

- Sheeting laid on sealing layer as initial protection before installing protection layer and wearing course
- Protection against mechanical damage to waterproofing (caused by chippings)

#### Sealing layer

(moisture barrier, waterproofing)

- Wherever possible, wearing course and protection layer should be able to move independently of each other (separating layer)

#### Ventilation cavity

(cold deck only)

#### Thermal insulation

Layer of insulating material with defined thermal conductivity

#### Impact sound insulation

Only required on roofs subject to foot or vehicular traffic

#### Vapour barrier

- Layer with defined vapour permeability, prevents saturation of thermal insulation, not necessary on upside-down roof
- Intermediate layer providing permanent separation between two incompatible materials

#### Separating layer, slip plane

- Intermediate layer enabling independent movement of individual layers of flat roof make-up
- Layer that compensates for roughness or unevenness in the underlying construction

#### Levelling layer

(falls layer)

- Layer added to achieve the required falls (min. 1.5%) in the underlying construction
- The falls layer can be omitted when the loadbearing construction is already laid to falls.

### Materials, thicknesses

- Roof suitable for foot traffic: quarry tiles, asphalt or concrete on drainage layer, approx. 6–20 cm
- Roof unsuitable for foot traffic: rounded gravel (no sand owing to possible plant growth), approx. 6 cm
- Extensive planting: 6 mm filter layer, approx. 8–15 cm plant-bearing substrate, approx. 6 cm vegetation
- Intensive planting: 3 mm protection layer, approx. 12–15 cm water retention layer, 3 mm filter layer, approx. 7–20 cm soil or humus, 6–50 cm vegetation

#### Fleece

Conventional waterproofing systems for warm decks:

- Bitumen sheeting, 3 layers, with 2 intermediate layers of bitumen and 1 bitumen top coat (total thickness min. 7 mm), bituminous felt SNV 556 001: dry felt, jute fabric, glass fibre, aluminium foil
- Polyester-based bitumen sheeting, 2 layers, torched or bonded with hot adhesive (min. 5 mm thick), SIA 281 E: jute fabric, glass fleece
- Polyester-based synthetic sheeting, 1 layer, compatibility with adjacent materials must be guaranteed otherwise a separating layer must be included, SIA 280: Sarnafil, Gonon, etc.

- Mineral-fibre materials (limited compressive strength), glass wool, rockwool
- Porous materials (high compressive strength), cellular glass (foam glass), vermiculite, perlite (Fesco Board, Heraperm)
- Organic materials (high compressive strength), polystyrene foam (expanded or extruded), polyurethane foam, polyethylene foam, PVC foam

- Organic materials (high compressive strength), cork, wood pulp, expanded polystyrene foam, approx. 2–4 cm
- Mineral-fibre materials (high bulk weight and high compressive strength required), glass wool, rockwool, approx. 2–4 cm

- Bitumen sheeting, hot bituminous compound 85/25, F3, with talcum powder, F3 and hot bituminous compound, V 60, with talcum powder, aluminium 10 B, polyester-based bitumen sheeting, aluminium foil both sides, Sarnavap 1000, Golfi D 2.1, polyethylene, butyl rubber

- Diverse oil or kraft papers, PE-coated

## Flat roof

### Warm deck – conventional systems

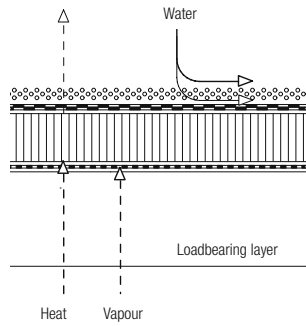


Fig. 7: Schematic drawing of building performance parameters

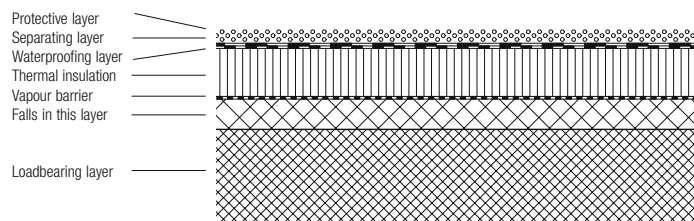


Fig. 8: Section through warm deck (synthetic roof covering)

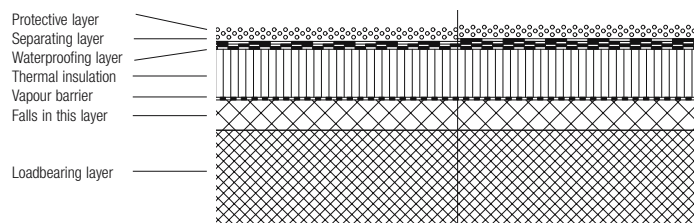


Fig. 9: Section through warm deck (bituminous roof covering)

The conventional warm deck is a single-skin roof which contains one each of the necessary functional layers (loadbearing, waterproofing, thermal insulation, possibly sound insulation for accessible roofs). Various functions can also be combined in one material layer, although the waterproofing is always placed above the thermal insulation. When selecting materials, ensure that the components are compatible with each other and the building performance values are correct (use tried-and-tested combinations of products). Warm decks have a seamless roof covering. To prevent damaging condensation it is vital to install a vapour barrier on the inside (warm side) of the thermal insulation above the loadbearing layer. The vapour permeability resistance of this vapour barrier must be coordinated with the other layers of the roof construction. A layer of gravel, paving flags, road surfacing material or planting is suitable for protecting the waterproofing against the weather and mechanical damage. It is usually advisable to install a separating layer, e.g. fleece, between the waterproofing and this layer of protection. The necessary falls (min. 1.5%) can be produced in the loadbearing layer, in a layer specifically incorporated for this purpose or in the thermal insulation.

#### Warm deck (synthetic materials)

The waterproofing here is a single layer of synthetic roofing felt with torched or bonded overlapping joints. The resistance to ultraviolet radiation is generally limited and so a protective layer must be added.

Various rigid products can be used for the layer of insulation. However, care must be taken to ensure that they are compatible with the waterproofing. Polystyrene, for instance, must be separated from the synthetic roofing felt (migration of softener). On accessible roofs it is important to ensure that the compressive strength of the thermal insulation is adequate.

#### Warm deck (bituminous materials)

The waterproofing here consists mostly of two layers of polyester-based bitumen felt. The first layer is laid loose on the thermal insulation and all further layers are then fully bonded together. When using pure bitumen sheeting at least three layers are necessary.

Various rigid products can be used for the layer of insulation. On accessible roofs it is important to ensure that the compressive strength of the thermal insulation is adequate.



## Flat roof

### Warm deck – special systems

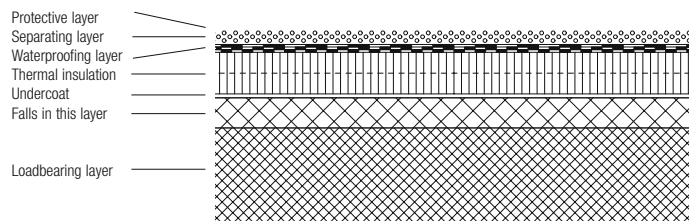


Fig. 10: Section through compact roof

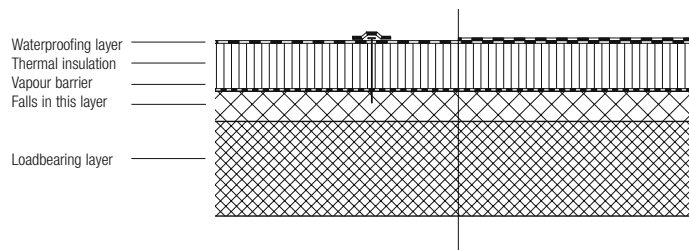


Fig. 11: Section through uncoated roof

The conventional warm deck systems have given birth to special flat roof constructions – for reasons of aesthetics and/or specific products. These are single-skin roofs and so follow the same layering principle as a conventional flat roof: the waterproofing is seamless and is placed above the thermal insulation. A vapour barrier installed on the inside of the thermal insulation prevents damaging condensation. Here again, the necessary falls (min. 1.5%) can be produced in the loadbearing layer, in a layer specifically incorporated for this purpose or in the thermal insulation.

### Compact roof

The compact roof evolved specifically from the use of cellular glass and only works with this material. All the layers apart from the protective layer or wearing course are fully bonded together and to the loadbearing layer; together they provide the waterproofing, vapour-imperviousness and thermal insulation functions.

The insulation consists of vapour-tight cellular glass laid in a hot bituminous compound on the loadbearing layer, and this also functions as the vapour barrier. The joints are simple butt joints filled with a hot bituminous compound. Two layers of bitumen roofing felt, again fully bonded, serve as a waterproofing layer. As on a conventional warm deck, a layer of gravel, paving flags, road surfacing material or planting serves as a protective layer or wearing course. The compact roof is an expensive system. However, with a loadbearing construction of in situ reinforced concrete (as rigid as possible) it guarantees a high standard of reliability with regard to preventing ingress of water.

### Uncoated roof

Uncoated roofs are flat roof systems without a protective layer or wearing course. The omission of this protection means that the “exposed” roof covering must withstand various influences.

The make-up of the waterproofing can employ either bituminous or synthetic roofing felts (number of layers as for a conventional warm deck). In each case the manufacturer of the materials must confirm that the roof covering is suitable in terms of its resistance to ultraviolet radiation. It must also be incombustible (fire rating No. 6). The omission of the protection (ballast) also means that the roof covering is exposed to the wind. It must be ensured that all layers are fixed together (bonded or mechanically) such that the forces can be transferred. Mechanical fixings must be covered. Edges and junctions must be specially secured (wind suction). Uncoated roofs are sensitive to loads and are thus unsuitable for foot traffic. They must be approved – also by the local fire brigade. It is essential to check the waterproofing function of such roofs at regular intervals.

## Flat roof

### Upside-down roof

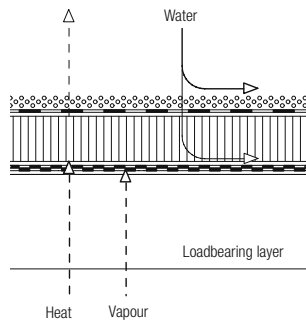


Fig. 12: Schematic drawing of building performance parameters

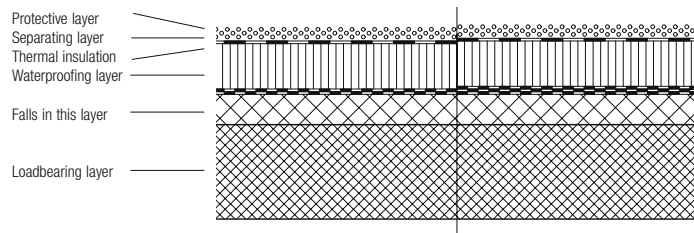


Fig. 13: Section through upside-down roof

### Upside-down roof

The upside-down roof is a non-ventilated flat roof system with the obligatory functional layers. However, the sequence of the layers is different from a conventional warm deck.

The layer of thermal insulation is placed above the waterproofing and must therefore itself be waterproof (extruded polystyrene). This is a single layer of material and must therefore incorporate rebated joints. As the insulation is laid "in the wet" it must be 20% thicker than is necessary to satisfy the actual thermal insulation requirements.

A separating layer of fleece above the insulation prevents the gravel infiltrating the joints in the thermal insulation. The use of a special separating fleece which allows most of the water to drain away enables the 20% extra thickness to be reduced to just 3%.

The seamless waterproofing can consist of bituminous or synthetic roofing felt (number of layers as for a conventional warm deck) and is laid beneath the insulation, directly on the loadbearing layer. This also acts as a vapour barrier, and its position below the thermal insulation means that it is adequately protected against any damage.

A protective layer is absolutely essential on an upside-down roof. It prevents damage to the thermal insulation and also serves as ballast to prevent the insulation lifting off the layers below. As on a conventional warm deck a minimum fall of 1.5% must be incorporated, which can be achieved in the loadbearing layer, in a layer specifically incorporated for this purpose or in the thermal insulation.

## Flat roof

### Cold deck

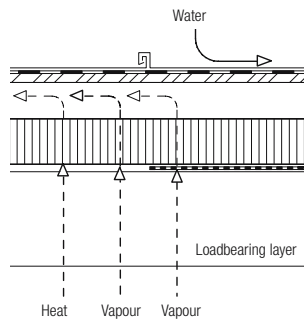


Fig. 14: Schematic drawing of building performance parameters

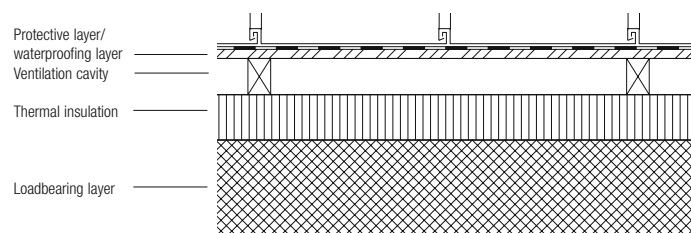


Fig. 15: Section through cold roof

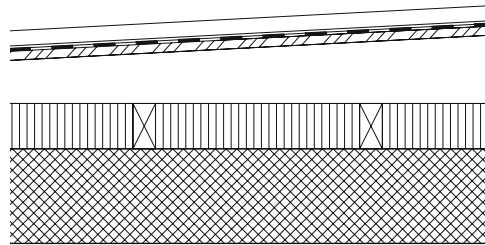


Fig. 16: Section through cold roof

### Cold deck

The cold deck is a double-skin roof construction consisting of a lower, enclosing and thermally insulating skin with a separate airtight membrane, and an upper, weatherproof skin designed to carry wind, snow and imposed loads. Between these two there is a ventilation cavity – the size of which is determined by building performance parameters – with appropriate inlets and outlets. The cross-sectional area of this ventilation cavity must be min. 1/150 of the roof area, the minimum depth must be 100 mm. The total area of inlets/outlets must be at least half the size of the minimum cross-sectional area of the ventilation cavity itself. This ventilation arrangement ensures a balance in the vapour pressure between interior and exterior climates, especially in winter, and that in summer the temperature rise caused by solar radiation (“stuffy” climate) is dissipated by convection. One specific example of a ventilated roof is the Davos-style roof; the ventilation cavity in this roof is designed as a crawl space which enables the waterproofing to be inspected from inside.

The layer of insulation is placed over the loadbearing layer and must consist of a vapour-permeable material (mineral or glass wool). Incorporating the ventilation above the thermal insulation obviates the need for a vapour barrier on the inside of the insulation. However, such a vapour barrier is included with a loadbearing layer that is very open to diffusion (timber or steel) and this acts as a diffusion-retardant airtight membrane. The layer of insulation need not be vapour-permeable because it is positioned above the ventilation cavity. However, it requires its own loadbearing layer (double-skin construction). Gravel or sheet metal are suitable materials for the protective layer above the insulation; the minimum roof pitch for a sheet metal roof covering with double welt joints must be 3%. The fall in the cold deck is usually achieved within the ventilation cavity (loadbearing layer or waterproofing layer). Such an inclined boundary surface promotes the thermal currents in the ventilation cavity.

## Pitched roof

### The multiple pitched roof

The crystalline form of the Böhler house harmonises in an obvious way with the mountainous landscape. The volume clings to the slope like a boulder, the irregular roof form underscoring its amorphous character. The animated silhouette of the slate-covered roof surface seems to emulate the outline of the mountains. Similar to the design of the facades, which are determined by a seemingly traditional fenestration but whose arrangement is actually a departure from tradition, the roof form oscillates as well between expressive gestures and hand-crafted traditions. The transition to the masonry is not abstract but instead employs the classical overhanging eaves, which protect the facades against rain and melting snow.



Fig. 17: Heinrich Tessenow: Private house (Böhler), St Moritz (CH), 1918, destroyed 1989

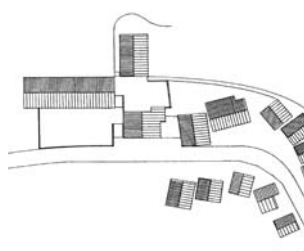


Fig. 18: Site plan  
Conradin Clavuot: School in St Peter (CH), 1997

### The pitched roof as a geometric element

Boasting different sizes, the exhibition wings of the Glarus Art Gallery dominate this L-shaped complex on the south-eastern edge of a park. The one- and two-storey pavilions appear as simple, rectangular buildings. Three exhibition rooms, one lit from the side and two from overhead, are the focal points. The rectangular brick volumes are each crowned by fully glazed pitched roofs whose architectural design emphasises the will to reduce the form. Although the overhang of the roof on all sides is minimal, it still generates a shadow on the walls below and hence reinforces the independence of the roof form. The glazed roofs illuminate two of the exhibition rooms, separated only by a dust screen.

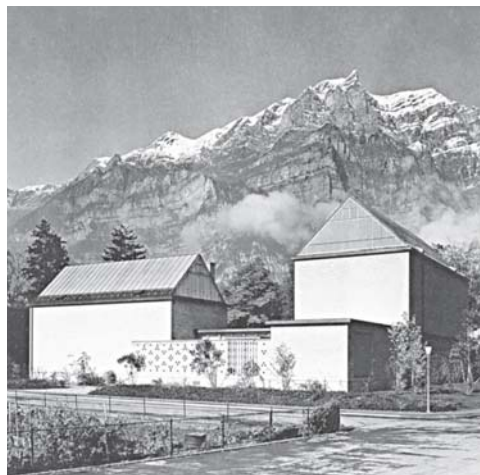


Fig. 19: Hans Leuzinger: Glarus Art Gallery (CH), 1952

### The integrative pitched roof

The extension to the school in St Peter integrates seamlessly into the local setting. The new buildings supplement the local built environment, which is characterised by a precise, functional positioning of the buildings and a choice of materials heavily influenced by the type of construction. Nevertheless, the pitched roofs of the new solid timber buildings achieve a certain autonomy thanks to subtle differences. Their roof surfaces are somewhat shallower than those of the neighbouring buildings and are finished with sheet metal. Wood-based boards replace the purlins of these couple roofs at the overhanging canopy, resulting in a delicate verge detail. The likewise slim eaves detail is characterised by a gutter that continues beyond the junction with the verge and acts as a spout, discharging the rainwater in a visible, thin, splashing stream directly into a gravel soakaway.



Fig. 20: Conradin Clavuot: School in St Peter (CH), 1997



## Flat roof



Fig. 21: Adalberto Libera: Casa Malaparte, Capri (I), 1941

### The accessible flat roof

Perched on a cliff-top, Adalberto Libera's Casa Malaparte has an imposing form, its red paint finish creating an artificial addition to the topography. A tapering external staircase in a form not dissimilar to the building itself links the natural with the man-made environment. From this flat roof platform there is an all-round view over the sea and the rocky coastline of the island of Capri. The exposed nature of this site is further reinforced by the complete absence of safety barriers. The finish to the roof surface is in the same colour as the facades so that the building presents a monolithic appearance. An elegantly curving screen of white-painted concrete ensures privacy for the solarium and is the sole enclosed part of the rooftop terrace.



Fig. 22: Adalberto Libera: Casa Malaparte, Capri (I), 1941

### The roof garden

The Villa Savoye is raised above the ground on columns and stands in a gently sloping forest clearing near Paris. The set-back ground floor facade helps the upper floor and the sculpted rooftop structures to appear more dominant. In contrast to the main floor, which is open to its surroundings on all sides thanks to the long ribbon windows, the roof garden of the Villa Savoye is enclosed by sculpted walls and offers only partial views of its surroundings. This results in an interior space open to the sky with a charming, introverted character. Unlike the platform of the Casa Malaparte, the protected rooftop terrace here serves as an extension to the living quarters



Fig. 23: Le Corbusier: Villa Savoye, Poissy (F), 1929

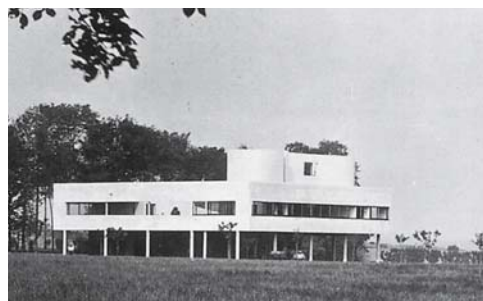


Fig. 24: Le Corbusier: Villa Savoye, Poissy (F), 1929

in the summer. In his *Five Points of a New Architecture* Le Corbusier regards the roof garden as a substitute for the ground area occupied by the building itself.



Fig. 25: Herzog & de Meuron: "Auf dem Wolf" locomotive depot, Basel (CH), 1995

### The apparently corporeal flat roof

The four parallel bays of the "Auf dem Wolf" locomotive depot in Basel are separated by in situ concrete walls. Corporeal roof structures span over these concrete walls. The glass-clad lattice beams also form a monitor roof profile, which provides good illumination throughout the interior despite the excessive interior depth in some places. In architectural terms the rhythm of the translucent monitors can be interpreted as the regular positioning of sleepers, the rails being represented by the longitudinal walls, albeit with the positions reversed.

### The roof as an independent large-scale edifice

Visible from Potsdamer Strasse is the ground-level section of the New National Gallery in Berlin, which is practically reduced to two architectural elements. A flat roof assembled from steel beams supported on eight columns soars over and beyond the reception area and ground-floor exhibition areas. But the other element, the set-back glass facade on all sides, is hardly noticeable. The roof spans 42 m and sails far beyond the glass walls. It comprises a two-way-spanning beam grid of 1.8 m deep H-sections which together weigh 1250 tonnes.



Fig. 26: Ludwig Mies van der Rohe: New National Gallery, Berlin (D), 1967

## The roof as a folded plate



Fig. 27: Gigon & Guyer: Extension to art gallery in Winterthur (CH), 1995



Fig. 28: View during construction  
Gigon & Guyer: Extension to art gallery in Winterthur (CH), 1995

### The sawtooth roof as a light-directing layer

The art museums in Appenzell and Winterthur, both by Gigon & Guyer, are excellent examples of two fundamentally different methods for dealing with the framework conditions of sawtooth roofs.

The extension to the art gallery in Winterthur can be divided into three horizontal layers. The unheated, ventilated ground floor is for parking only. The exhibition rooms are located above this on the true main floor. And above the exhibition level a sawtooth roof ensures the necessary illumination. This layering of the functions is reflected in the facade design, which is likewise divided into three parts, with the exhibition level – framed, as it were, by the parking level and the sawtooth roof – being given most emphasis. The rhythm of the sawtooth roof matches the grid of the steel frame, but depending on the size of the exhibition areas, three, four or five “teeth” of the roof are allocated to each area. Internally, in contrast to the facade, the subdivision into exhibition area and lighting layer is suppressed by the use of a seamless lining. The effective height of the sawtooth roof is thus added to the exhibition area and can therefore be appreciated directly. As the glazed surfaces of the sawtooth roof face almost exactly north, no direct sunlight enters the building.



Fig. 29: Gigon & Guyer: Liner Museum, Appenzell (CH), 1998

### The sawtooth roof as a sculptural element

The Liner Museum in Appenzell has a sawtooth roof for a completely different reason. The zigzag profile of the roof provided the chance to create an expressive, large-scale silhouette which, when viewed from close up, lends the museum an abstract quality. Only when we look down on the art museum and the town from the surrounding hillsides does the sawtooth roof blend in with the roofs of the neighbouring industrial buildings. In this case each “tooth” of the roof is allocated to a separate exhibition area, which means that from inside we see not a sawtooth roof but instead what appears to be an asymmetric pitched roof. The rhythm of the interior spaces (and hence the sawtooth roof) narrows towards the north. So as the pitch of the



Fig. 30: View from mountain side  
Bearth & Deplazes: Valley station of Carmenna chair-lift, Arosa (CH), 2000

roof slope remains the same, the height of each section decreases. This, together with the design of the ends of the building and the homogeneous cladding, promotes the alienation of the external expression of the sawtooth roof theme. Sandblasted chromium-steel sheets, overlapping like tiles, clad the whole of this monolithic structure, leaving no distinction between wall and roof surfaces. They thus lend the finished building a corporeal expression.

### The roof as an irregular folded plate

The Carmenna chair-lift takes day-trippers from the valley station, which is located above Inner-Arosa near the late-Gothic mountain chapel, via an intermediate station to the side of the Weisshorn.

To preserve the landscape, the relatively large volume of the valley station is partly buried in the rising slope of the mountainside. A thin layer of soil lies like a carpet on the tent-like, multiple-folded roof and thus produces a seamless connection with the landscape. The conspicuous angularity of the roof form, supported by a lightweight steel frame, nevertheless reveals that this is an artificial continuation of the natural terrain. But in winter the scale of the roof form, appropriate to the topography, and the layer of snow over everything results in an almost complete fusion between the natural and the man-made elements.

The picture is completely different when looking from the valley side. The multiple folds of the entrance facade remain completely visible; it looks like a cross-section through a sculpted landscape. Blurred outlines of the interior workings can be made out behind the semi-transparent “Scobalit” facade. The left half serves for the night-time storage of the four-person chairs. The right half is for dispatching the winter sports fans on their way up the mountain. This latter half, the actual valley station for the lift system, is in the form of a bright, neon orange-painted tunnel.



Fig. 31: Bearth & Deplazes: Valley station of Carmenna chair-lift, Arosa (CH), 2000

## Barrel-vault roof and shell roof

### The barrel-vault roof

The – on plan – symmetrical, three-part Kimbell Art Museum is given its rhythm by the barrel-vault roofs perpendicular to the axis of symmetry. The character of the building, both internally and externally, is essentially determined by the roof form. The barrel vaults with their cycloidal cross-section each span 30.5 m in the longitudinal and 6.7 m in the transverse direction, and are supported on just four square columns at the corners. All the segments have identical, large dimensions and, when placed together, form very large areas without any intervening columns. However, these areas can be subdivided by means of portable, non-loadbearing partitions. The unusual illumination is also due to the roof form. At the crown of the vault there is a longitudinal slit which admits daylight. As direct daylight is unsuitable for displaying works of art, a reflector mounted below the slit redirects the incoming light such that the soffit of the vault is illuminated. At the gables there is a glazed gap, varying in width, between the non-loadbearing, semicircular travertine infill panel and the stiffened edge of the barrel vault, and this renders visible the geometry of the cross-section.



Fig. 32: Louis I. Kahn: Kimbell Art Museum, Forth Worth (USA), 1972



Fig. 33: Louis I. Kahn: Kimbell Art Museum, Forth Worth (USA), 1972

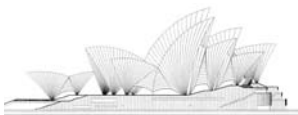
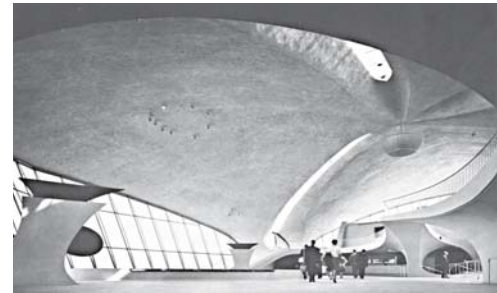
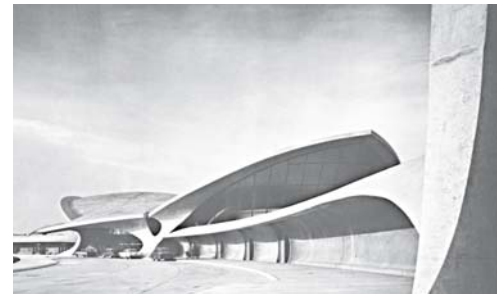


Fig. 34: Jørn Utzon: Sydney Opera House (AUS), 1973

### The additive shell roof

Sydney Opera house is located at a prominent position on a peninsula in Sydney Harbour. Jørn Utzon developed his design wholly based on this specific situation. Three groups of intersecting shells – containing concert hall, opera and restaurant – rise out of a massive, apparently monolithic plinth. The contrast between the heavyweight, earth-bound foundation and the lightweight, elegant shells helps to emphasise the functional separation between the ancillary spaces located underground and the public foyers and auditoriums above. At the same time, the plinth forms an artificial topography for the terracing, as in ancient Greek theatres.



Figs 35 and 36: Eero Saarinen: TWA Terminal, New York (USA), 1958

### The expressive shell roof

In contrast to the assembly of different shells at Sydney Opera House, the expressive roof form of the TWA terminal is a single symmetrical, large-scale arrangement. Although sculptural thinking was central to Eero Saarinen's design for the terminal and working drawings were not produced until the final form had been decided upon, the building benefits from the structural possibilities of the three-dimensional shell, transferring the weight of the roof to just four colossal columns. The dynamic shape, which explores the frontiers of formwork for in situ concrete, plays with the aesthetics of the propeller aircraft prevalent at the time of the building's construction.



Fig. 37: Jørn Utzon: Sydney Opera House (AUS), 1973

## Criteria and relationships

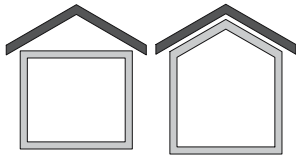


Fig. 38: Cold deck pitched roof cold roof space (screed)

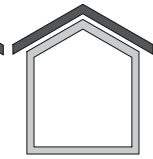


Fig. 39: Cold deck pitched roof two ventilation cavities

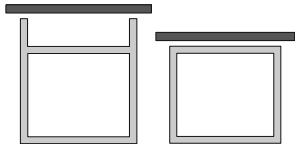


Fig. 40: Cold deck flat roof accessible roof space

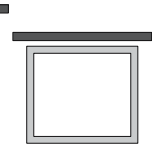


Fig. 41: Cold deck flat roof air cavity in roof construction



Fig. 42: Warm deck pitched roof one ventilation cavity

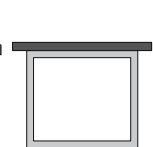


Fig. 43: Warm deck flat roof no air cavity

### Two layering principles

Apart from the fundamental protective function of the roof, i.e., providing shelter for human beings, keeping the water out is the main task of the roof. External influences (sunshine, rain, wind) but also those from inside (water vapour pressure) and the resulting problem of water vapour diffusion give rise to further strains in the roof construction. In order to do justice to these diverse demands, a multi-layer structure is necessary, which has led to two layering principles. One of these systems is chosen depending on the given overriding conditions, the roof form, the loadbearing structure, the conditions at junctions with other parts of the structure and at the edges of the roof.

### Cold deck

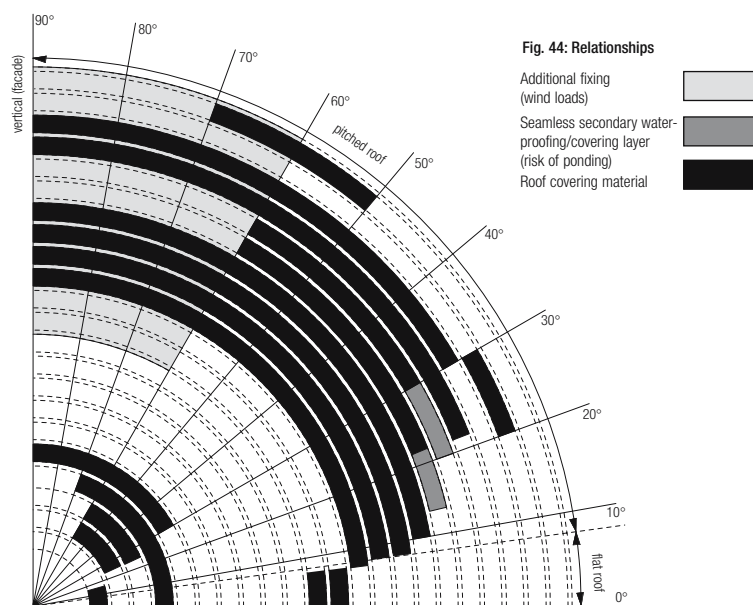
In the cold deck the waterproofing layer is so far removed from the layer of thermal insulation that a dry air cavity is formed between the two. This captures the water vapour diffusing out of the insulation and carries it away.

A pitched cold deck has two air cavities: one between the roof covering and the secondary waterproofing/covering layer, and one between this latter layer and the insulation, although it is this second cavity that actually qualifies the roof to be called a "cold deck" (see "Pitched roof" on p. 218).

### Warm deck

In the warm deck the waterproofing layer or a diffusion-retardant layer, e.g. in a pitched roof a secondary waterproofing/covering layer, is laid immediately above the thermal insulation. The water vapour diffusing out of the insulation could therefore condense on the non-ventilated cold side of the insulation and saturate this. A vapour barrier installed on the inside prevents the warm, vapour-saturated air entering the insulation and thus prevents any damaging condensation.

Thatch	Straw, reed
Flat overlapping elements	Loose stone slabs
	Wooden shakes/shingles
	Fibre-cement slates
	Clay/concrete tiles
Profiled overlapping elements	Clay/concrete tiles
Flat sheets	Glass
Profiled sheets	Fibre-cement
	Metal
Sheet metal	Metal (standing seam)
Flexible sheeting	Bitumen
	Synthetic materials
Couple roof	with queen struts
Purlin roof	with queen posts
In situ reinforced concrete roof	trussed



### Relationships between roof pitch and roof covering material

The pitch of the roof depends on the roof covering material, the roof form, the fixings and the type of jointing. A flat roof must exhibit a seamless, waterproof roof covering.

On the other hand, a roof covering of overlapping elements with its high proportion of joints is better suited to a pitched roof. The more watertight the roof covering element and its joints with neighbouring elements, the shallower is the allowable pitch.



## Flat roof – pitched roof

### Repercussions for the building envelope

#### 1. Rain

##### Flat roof

a) Waterproofing: The waterproofing and water run-off layer must exhibit, depending on the system, a minimum fall of between 1.5% (upside-down roof) and 3%. The waterproofing layer is generally the topmost layer or the second layer below any wearing course or protective layer. The exception is the upside-down roof, where the waterproofing layer is beneath the thermal insulation. In this case it must be assured that the insulating material is moisture-resistant (various systems available).

b) Drainage: Rainwater is drained to a downpipe or gully outlet at the lowest point on the roof surface and then inside or outside the building to a soakaway or drainage system. The provision of an upstand (parapet) around the edge of the roof is intended to prevent water running over the edge of the roof and down the facade during periods of heavy rainfall. Such a parapet must be at least 12 cm high (measured from top of wearing course or protective layer to topmost component of parapet – e.g. top of sheet metal capping) and must be absolutely watertight (SIA 271).

##### Pitched roof

a) In contrast to the flat roof, the water run-off layer on a pitched roof must be rainproof but need not be waterproof (e.g. thatched roof). The drainage of the water must take place via the uppermost layer, which can consist of sheet metal, clay/concrete roof tiles, stone, glass, etc. The pitch varies depending on the material. However, the pitch must always be steep enough to ensure that rainwater drains without ponding. The secondary waterproofing/covering layer functions as a temporary roof should the roof covering become damaged and also helps during severe weather.

b) Drainage: A gutter is essential along the edge of the roof (eaves); it can remain visible (external downpipe) or it can be incorporated in the edge of the roof (internal downpipe).

##### General

a) Oversailing eaves and verges protect the wall–roof junction against rain. The joints between roof covering and wall are exposed to extreme conditions (hydrostatic pressure). Underneath the eaves/verge the resulting eddy that develops, however, generates a countercurrent and lowers the risk of water penetration.

b) The dimensions of roof gutters and the number of downpipes are calculated according to the area of roof and the quantity of precipitation expected.

#### 2. Sunshine

##### Flat roof

Some waterproofing materials are vulnerable to ultraviolet radiation (e.g. bitumen sheeting) and must be covered and protected by a layer of gravel or similar material.

##### General

In a lightweight roof a “stuffy” climate (a build-up of heat below the roof) is prevented by the circulation of air in the cavity, and in a heavyweight roof it is the mass of the loadbearing layer, which absorbs the heat, that prevents this problem.

#### 3. Wind

##### Flat roof

Wind suction is primarily a problem on uncoated roofs because the roof covering is not weighted down by gravel or other similar materials. The roof covering must be fixed to the loadbearing layer at individual points. Parapets around the edge of the roof (not suitable for cold deck systems) reduce the wind suction on large areas. The outer protective layer also has the task of providing ballast (e.g. gravel, concrete flags) for the layers below.

##### Pitched roof

On roofs with overlapping elements wind suction can be a problem, depending on the pitch and the weight of the materials. Wooden shakes/shingles or thatch must always be securely fixed. Owing to their weight, tiles can usually be simply laid in place without fixing, but at pitches of 60° and more they must always include an additional mechanical fastener.

##### General

Lightweight roofs must always include an airtight membrane.

#### 4. Temperature

##### General

Standards stipulate the thermal resistance and hence the minimum thickness of the various constructions. The climatic conditions of Central Europe mean that a layer of insulation to the enclosing envelope of rooms designed for occupation is always necessary. The type of insulation and its position within the roof construction depend on the system chosen.

#### 5. Vapour diffusion from inside to outside

##### General

It must be guaranteed that moisture is not introduced into the layer of insulation through saturation of the construction due to vapour diffusion from inside to outside. Many insulating materials are poor insulators when wet! Saturation can be prevented by using concrete for the loadbearing layer (vapour-tight), including a vapour barrier/check on the warm side of the insulation, or employing moisture-resistant insulating materials.

#### 6. Snow

##### Flat roof

A parapet around the periphery of the roof (min. 12 cm) prevents fallen snow from penetrating the roof edge detail and creates a reservoir for meltwater.

##### Pitched roof

Snowguards must be fitted to prevent snow sliding off the roof.

##### General

The loadbearing construction must be designed to carry a certain snow load depending on the pitch of the roof and the location/altitude of the site.

#### 7. Mechanical damage

##### Flat roof

It is primarily the uncoated roof that is vulnerable to mechanical damage – also due to hail. On a bituminous warm deck it should be ensured that the protective layer of rounded gravel does not contain any sand because this provides nutrients for plants. The small roots of plants gradually penetrate the waterproofing and render it useless. On an accessible upside-down roof the thermal insulation is especially sensitive to point loads.

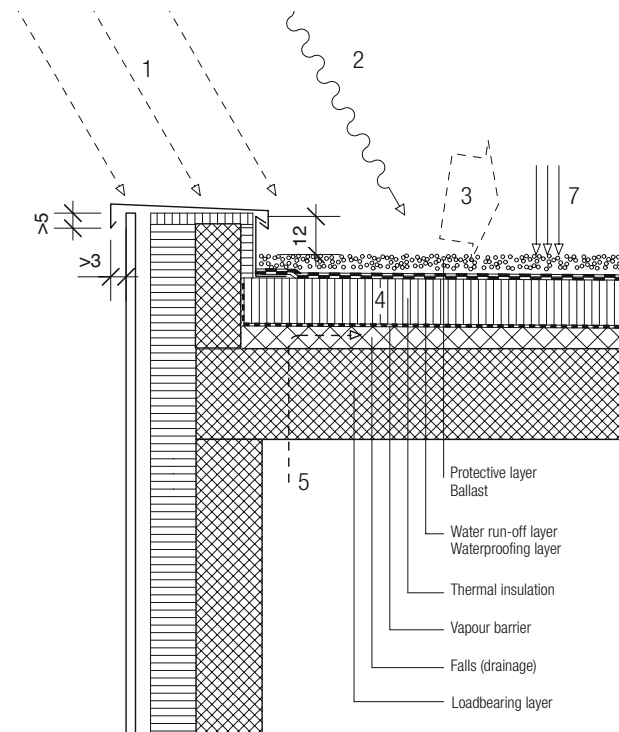


Fig. 45: Flat roof, warm deck, scale 1:20

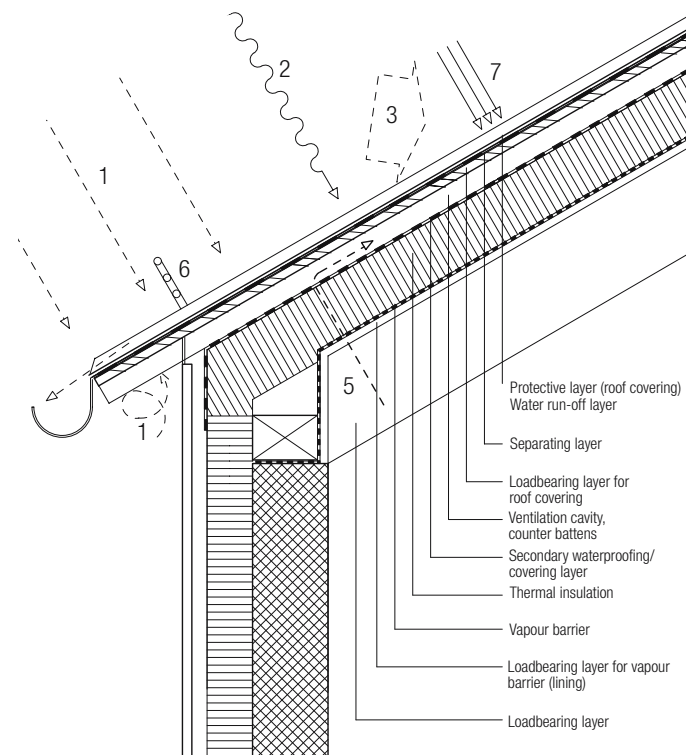


Fig. 46: Pitched roof, ventilated sheet metal, scale 1:20

For current Swiss and German standards on roof construction see [www.sia.ch](http://www.sia.ch) and [www.bauregeln.de](http://www.bauregeln.de).

## Flights of fancy

Daniel Gut

### The staircase as a multiplier of the horizontal plane

Space for human movement is practically limited to two dimensions because gravity pins us to the ground. Our bodies cannot explore the space overhead. Accordingly, our perception of the world takes on a horizontal orientation. Architecture has been drawing its conclusions from this for thousands of years and arranges the functions horizontally. The staircase is therefore one of the important inventions in the history of architecture because it offers us the chance to link conveniently the vertical multiplication of areas for human movement by dividing the difference in height into small units that human beings can negotiate.

Every staircase renders two fundamentally different, opposing movements possible. And not only in physical terms: ascending and descending are terms loaded with mythological and psychological meanings as well. In Christian mythology, for example, the connection between places of good and places of evil are given extra significance by using the word pairs above–below and light–dark. This has consequences for the psychological dimension of the terms ascending and descending. These opposites firmly anchored in the human mind have been transferred directly into the secular world. The stairway to Heaven has become a ladder of knowledge, a ladder of virtues; the higher position in the hierarchy is better; we ascend to the top league or descend into madness.



Fig. 1: Giovanni Battista Piranesi: *Carceri*, plate VIII, 2nd ed., 1761

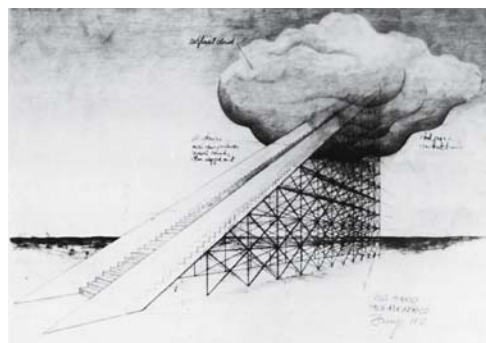


Fig. 2: Haus-Rucker-Co: *Big Piano*, 1972

Piranesi makes use of extravagant, enigmatic staircases in his architectural vision *Carceri* in order to lend his gloomy spaces an element of psychophysical disunion. The stairs lead into the depths of the dungeons and symbolise a world out of balance.

Ascending and descending movements, in relation to moving in the horizontal plane, represent a change of rhythm which has subconscious psychological repercussions. In the slowing of the rhythm as we ascend our spirit tends to want to hurry ahead of our bodies, to tackle our destination, or rather our immediate future. The German language even has an everyday specific, stair-related word for this: *Treppengedanke* – a forethought; likewise a word for the opposite direction: *Treppenwitz* – an after-

thought – a thought that occurs to us only after starting to descend the stairs while our minds are still upstairs dwelling in our immediate past.

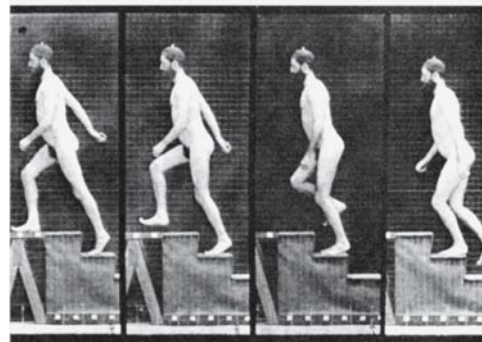


Fig. 3: Eadweard Muybridge: *Human and Animal Locomotion*, 1887

Human beings have become accustomed to the artificial character of a succession of horizontal planes. Every child, having mastered the art of walking, then has to deal with climbing stairs. Over the years this motion becomes a programmed movement mechanism. But because this ritualised sequence of movements, in contrast to moving on a horizontal plane, is inextricably linked with the geometry of the step, the staircase enjoys increased attention. What this means for the architect is a chance to use materials to satisfy this enhanced focus. Apart from the fact that the architect can determine the rhythm of future movements by choosing a particular step geometry, he or she knows that the floor covering will be trodden upon with just a touch more care and awareness, that the handrail will be consciously perceived and that a rotational movement into the prescribed direction will take place on any landings necessary.

In the following I shall use word pairs to represent the contradictory characters or design concepts for stairs to demonstrate the potential opportunities and consequences of architectural decisions. The choice of these word pairs is intentionally arbitrary. The vista of possible options is too broad to want to cover everything.

### The generating component of a project or building

Vertical access can be coupled with the three-dimensional concept of a building to the extent that it forms a permanent component or even the pretext for the concept. It is therefore an early topic in the design process and can be anchored in the design task. The design and choice of materials for vertical access are derived directly from the structure of the building or form a permanent component in this. Removal or repositioning during the ongoing design process becomes ever more difficult and practically impossible in an existing building without changing or destroying the entire concept. The enhanced potential for spatial quality is paid for by a loss of flexibility and is



Fig. 4: Le Corbusier: Apartment block, 24 rue Nungesser et Coli, Paris (F), 1934



Fig. 5: Frank Lloyd Wright: Guggenheim Museum, New York (USA), 1959

or less complementary character, depending on whether they have been devised as an accent, as part of a composition of various elements, or as a continuation of the building structure. In comparison to the aforementioned stairs they appear later in the design process. Their positioning and architectural expression are allowed much more flexibility. This applies to the design process and also to later changes to the existing building although, of course, the strategic positioning of a staircase remains crucial. The permanence within the building provides potential for a deliberate, relatively independent architectural statement which, in turn, can permit a fusion with the surroundings in numerous ways.

One example of this approach can be seen in the entrances to St Jakob Park – trunk-like staircase “hoppers” which, like mobile steps for aircraft passengers, are appended to the facade. The logic of the resulting flexible positioning could be adapted to suit the functional requirements. In terms of the materials employed, however, the translucent cladding to the staircase entrances ensures integration into the theme of the facade with its transparent plastic “rooflight” elements, which the night-time illumination changes into a shimmering skin.

On the other hand, the spiral staircase in Le Corbusier’s maisonette apartment is inserted like an artefact into the plan layout. Hidden in the base is the staircase leading down to the floor below. The permanence is expressed in the materials. While the strings blend in with the plastered surfaces of the apartment, the flight itself appears to be part of a composition of inserted elements.



Fig. 6: Adalberto Libera, Curzio Malaparte: Casa Malaparte, Capri (I), 1941

### Staircase as event or staircase as obstacle

There are stairs that invite the observer to use them. But there are others that we pass without noticing, and if forced to use them we get the feeling of being unwanted guests. One critical factor here appears to be the change in the degree of openness upon starting to use the stair or stair shaft. If this openness remains unaffected or is enhanced when using the stair, the stair tends to gain a more public character. The stair becomes an event. Numerous measures can be employed to manipulate this impression. The effective mass of the stair and its relationship with the surrounding space play a role. Three-dimensional settings can be devised in order to turn the ascent into a sensation or a social occasion. A dignified design and expensive materials can (but need not) emphasise the event of ascending the stairs.

Spatial and organisational decisions have turned the main staircase at the public library in Viipuri into an event. Visitors are initially channelled up a narrow stair before arriving at a broad landing in the very centre of the library. Although the handrail steers the visitor directly to the upper level, he or she senses the spatial extent of the symmetrical staircase on the central axis of the interior. The skill with which the handrail has been incorporated turns this stair into a combination of entrance and means of internal circulation, creates a prestigious staircase occupying the middle of the building.

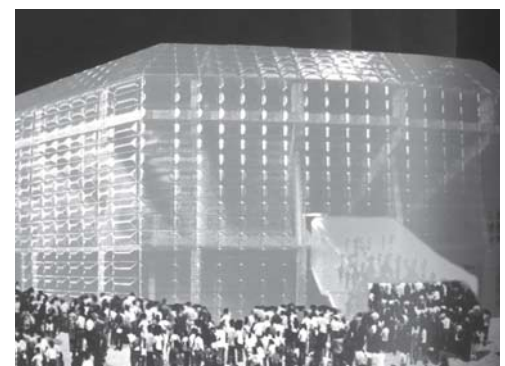


Fig. 7: Herzog & de Meuron: St Jakob Park, Basel (CH), 2001





Fig. 8: Harbour steps in St Augustine (USA)



Fig. 9: Alvaro Siza: House of Dr A. Duarte, Ovar (E), 1985

In Balthasar Neumann's proposal for the Hofburg Palace in Vienna the ascent of the stair is celebrated as a primary spatial attraction. This monumental staircase is accommodated in the largest room in the Hofburg Palace and is located in a prominent position on the central axis of the complex, lit from the two courtyards at the sides. Starting at entrance level, two flights lead up into the great staircase hall where several flights and landings branch off almost like a labyrinth. This almost intimidating staircase seems to symbolise the feudal claims to power.

Just as interesting is the question regarding the opposite situation: How do we prevent a passer-by from ascending a stair? How do we express, with architectural means, that a stair is not to be used? Reducing the degree of openness to a more private character, or providing spatial or geometrical restrictions, turns the stair into an obstacle. The more abrupt this change, the more obvious this statement becomes. In addition, the architectural expression of the stair can help it to be overlooked or create an off-putting effect. Steep steps or the omission of safety features (balustrade) can enhance this impression. A similar effect can be created by embedding the stair construction "incidentally" into its surroundings and using the same materials, especially if this homogenisation presents a contrast to the more public space.

The photograph of the harbour steps in St Augustine (Fig. 8) shows quite clearly that this is not a descent for public use, that it is reserved for fishermen and sailors who need to reach their boats. The clarity of this architectural statement is the result of the abrupt change in scale between the expansiveness of the quayside and the confinement of the steps, promoted by the choice of material for the steps – the same sandstone as the quay wall.

In the house of Dr Avelino Duarte, Alvaro Siza employs nuance-filled means for the stairs leading to the private area of the house to indicate that the stair transcends a barrier to the more private living quarters. While the bottom steps, belonging to the half-public room, appear

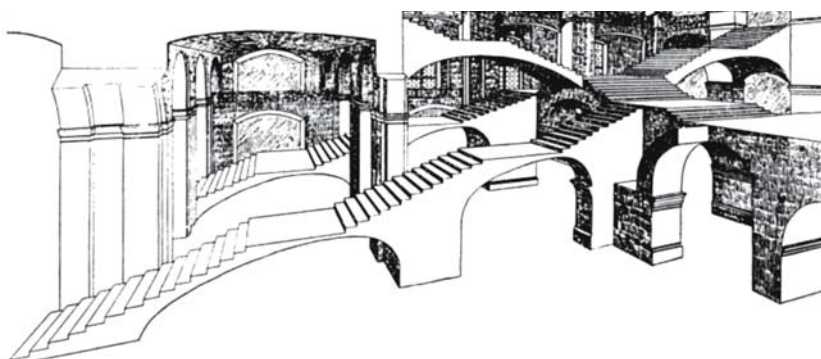


Fig. 10: Balthasar Neumann: Proposal for the Hofburg Palace in Vienna (A), 1747

to be cut out of the material of the high plinth, the floor covering to the stair itself, a warm wood, together with a narrowing of the width draws a clear line between public and private.

### Three-dimensional spatial fabric or stair core

Stair cores wind upwards over any number of storeys while their plan area remains equal or similar. They are usually quasi-autonomous shafts within buildings which join, or separate, the individual floors. Although the extent of the spatial separation can be manipulated by the type of connection between the stair shaft and the individual



Fig. 11: Alvar Aalto: Public library, Viipuri (FIN, today RUS), 1935

floors, or the vertical spatial "transparency" of the core, the stair shaft remains the symbol of movement between the essentially independent floors via the "neutral" stair shaft. The solution is economic because it permits an optimum relationship between access space and usable floor space and, through repetition of identical building elements, enables a rational construction process. Above a certain height of building this makes stair cores indispensable.

Stair shafts, or rather their outer walls, which are often solid to comply with the thermal, acoustic and fire requirements, can be used to brace the building, as the plan of the Pirelli Headquarters shows. The system of walls separating stair shafts and ancillary rooms brace the building in the longitudinal direction. As main access is via the lifts in the middle of the building, the stair shafts occupy only a minimum area and are located in *poché*-type spaces at the ends of the curved blocks.

By way of contrast to the above emergency stairs we should consider the stair shaft of the Palazzo Barberini. This stair shaft is an impressive combination of the goals of a spectacle and a rational, vertical connection. The size of the stairwell creates an effective three-dimensional space extending over six storeys.

The three-dimensional interior layout attempts to minimise the contrast between vertical and horizontal



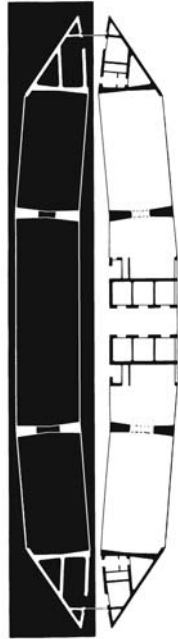


Fig. 12: Gio Ponti: Pirelli Headquarters, Milan (I), 1961

movement by merging horizontal and vertical circulation areas within a three-dimensional continuum. The spatial barriers between the storeys can be broken down further by introducing split levels, inclined planes and ramps. This permits almost unlimited manipulation of the hierarchy among the storeys. A *promenade architecturale* is created: the topmost storey becomes the end of a promenade, a lift becomes a time machine.

The spatial plans of Adolf Loos were one attempt to overcome the conventional breakdown into storeys, to achieve a three-dimensional interior layout. It became possible to give different spaces different ceiling heights according to their usage. The offsets between the individual levels resulted in plenty of freedom in the design of living quarters. Numerous short stairs formed a route through the interior, leading gradually to more private areas.

Some of the designs from O.M.A. are related to these spatial concepts although they stem from a completely different *Zeitgeist*. Contemporary technology enables us to deform the floor slabs at will, to overcome the classical subdivision of horizontal and vertical, and to allow the ground floor to flow upwards as a continuous band without a real staircase.

#### Thoroughfare and stopping-place

Stairs that are reduced to their practical function form vertical bridges between different levels and are designed purely as thoroughfares. We stop perhaps only briefly to exchange words with another staircase-user, or for a rest.

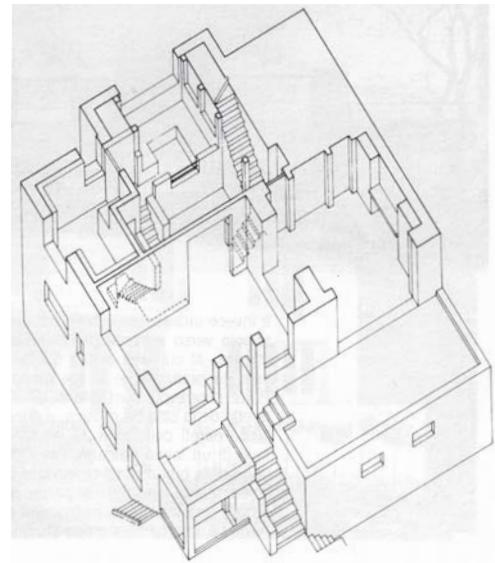


Fig. 14: Adolf Loos: Moller House, Vienna (A), 1928

Otherwise, such staircases are purely circulation areas and lead from one place to another. Depending on the ratio of the anticipated foot traffic and the dimensions of the stair, stopping for a moment can hinder the flow of people, even endanger their safety. In fact, specific measures can cultivate or influence the nature of the flow of people on a stair. Countless stairs in underground stations throughout the world demonstrate how a flowing movement of the mass can be promoted with an additional dynamic parallel with or in the direction of the flow.

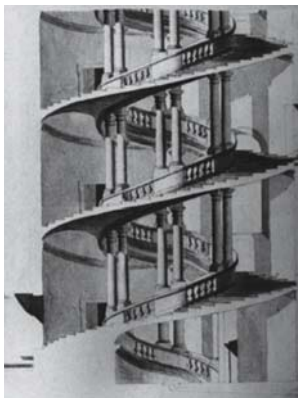


Fig. 13: Francesco Borromini: Palazzo Barberini, Rome (I), 1633

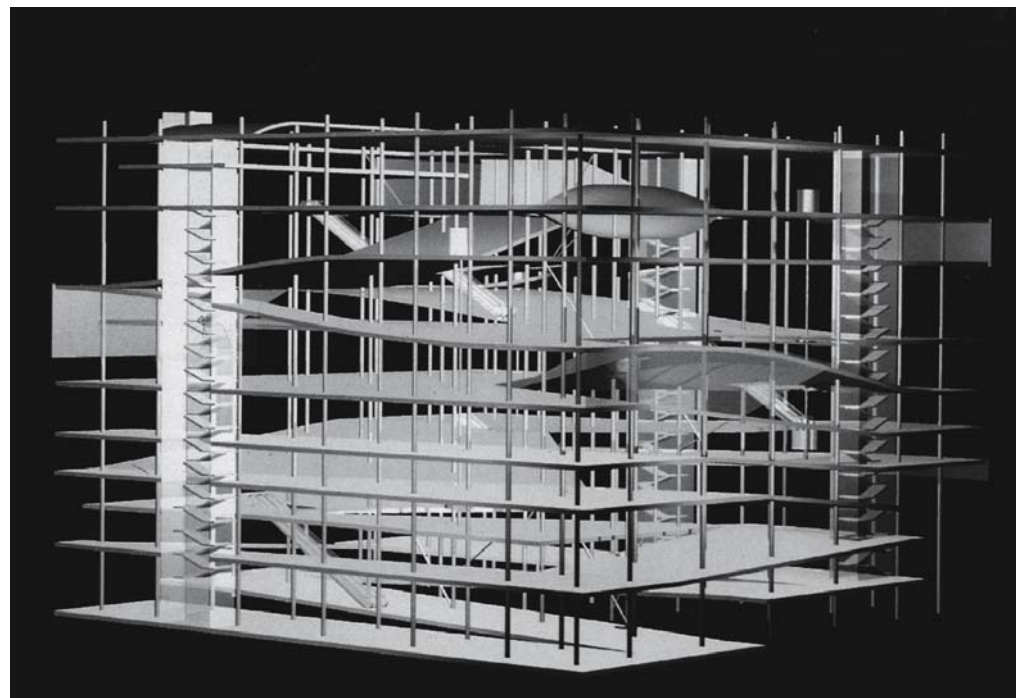


Fig. 15: O.M.A.: Jussieu University library project, Paris (F), 1993



Fig. 16: Paris Metro, stairs

What turns a staircase into a stopping-place or a place for communication? In terms of their actual width and steepness, the stairs leading to the entrances of the Bouça publicly assisted housing development are no different to the thoroughfare stairs described above. However, people are happy to sit here, to while away the hours with chit-chat. Critical aspects are the proportions of the flights and the relationship between the foot traffic expected and the width of the stair. Whether a stair acts as a catalyst for communication of course depends on the utilisation at both ends of the stair and how it relates to its immediate environment. The lighting, the microclimate and, possibly, the view can represent animating factors. Who doesn't prefer a wide open view to a confined perspective?

However, the stair also offers the advantage of being able to see beyond the person in front, a fact which has been exploited for thousands of years in the arrangement of audiences. These places normally serve one-way communication; those on the grandstand are the consumers. The steeper the terracing, the better our view and the greater the feeling of being exposed to what is being offered; it is harder to hide behind the person in front. However, if we place two grandstands opposite each other, multiple communication is possible. The discussion forums of history made use of this arrangement, a fact that is copied by contemporary televised discussions. One variation on this type of collective communication is the singing by blocks of fans in sports stadiums; this is only possible thanks to the stepped, grandstand form.

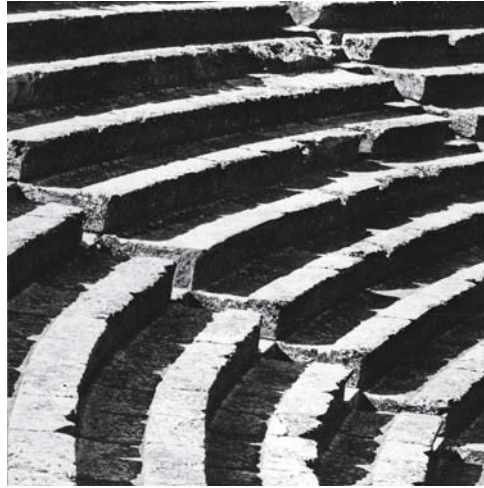


Fig. 19: Greek theatre in Epidauros (GR), 4th century BC



Fig. 17: Edward Hopper: Sunlight on Brownstones, 1956



Fig. 18: Alvaro Siza: Bouça publicly assisted housing project, Porto (P), 1977

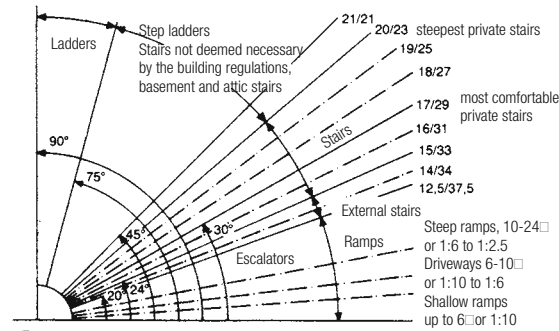
#### Further reading

- Karl J. Habermann: *Staircases – Design and Construction*, Basel, Boston, Berlin, 2003.
- John Templar: *The staircase Vol. 1+2*, Cambridge, Mass., 1992.
- Cleo Baldon: *Steps & stairways*, New York, 1989.
- Walter M. Förderer: "Treppenräume", in: *Daidalos*, No. 9, 1983.
- Wolfgang Meisenheimer: "Treppen als Bühnen der Raum-Anschauung", in: *Daidalos*, No. 9, 1983.
- Ulrich Giersch: "Auf Stufen", in: *Daidalos*, No. 9, 1983.

Extract from the *Bauteurfslehre* (Building Design Textbook) by Ernst Neufert

STAIRS

DIN 18064, 18065, 4174



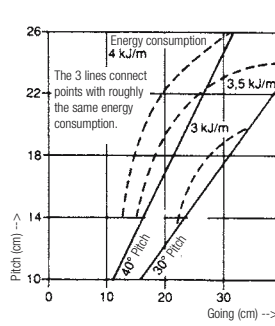
1 Pitches for ramps, external stairs, private stairs, plant access stairs and ladders

Storey height	Two flights		One and three flights, building entrance	
	Shallow (good) pitch	Shallow (good) pitch	Shallow (good) pitch	Shallow (good) pitch
	No. of steps	Rise	No. of steps	Rise
a	b	c	f	g
2250	-	-	13	173.0
2500	14	178,5	15	166,6
2625	-	-	15	175,0
2750	16	171,8	-	-
3000	18	166,6	17	176,4

2 Storey height and stair pitch

Type of building	Type of stair	Usable stair width	Rise a <sup>2)</sup>	Going a <sup>3)</sup>
Residential buildings with no more than two apartments <sup>1)</sup>	Stairs deemed necessary by the building regulations	iv 80	17 ± 3	28 ± 3
	Stairs leading to rooms suitable for permanent occupation	iv 80	≤ 21	≥ 21
	Basement and attic stairs that do not lead to rooms suitable for permanent occupation	iv 50	≤ 21	≥ 21
(Additional) stairs not deemed necessary by the building regulations, see DIN 18064, Nov 79, section 2.5		iv 50	≤ 21	≥ 21
(Additional) stairs not deemed necessary by the building regulations within one apartment		iv 50	No stipulations	
Other buildings	Stairs deemed necessary by the building regulations	iv 100	17 ± 3	28 ± 3
	(Additional) stairs not deemed necessary by the building regulations, see DIN 18064, Nov 79, section 2.5	iv 50	≤ 21	≥ 21

3 Stairs in buildings, DIN 18065



4 Energy consumption for an adult climbing a flight of stairs

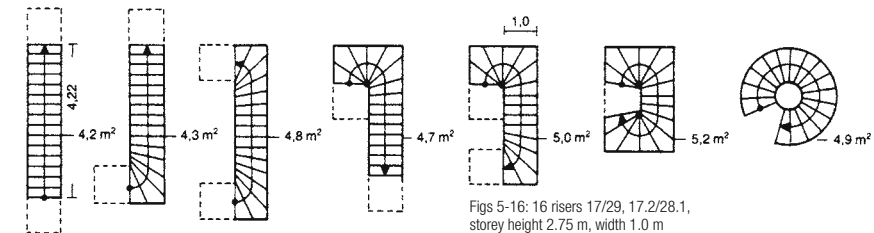
The range of possibilities for stairs and means of access is broad: from the design options for the most diverse types of residential stairs to spacious external stairs to those on which ascending and descending calls for big strides. Using a stair requires, on average, seven times more energy than walking normally along a horizontal plane. When ascending a stair the physiologically favourable "climbing work" is given by a pitch of 30° and a rise/going ratio of

$$\text{step height (rise) } H = \frac{17}{29} \cdot \text{step depth (going) } T$$

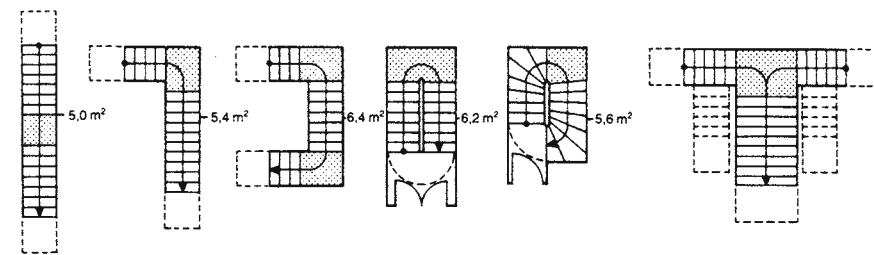
The rise/going ratio is determined by the step length of an adult (approx. 61-64 cm). To determine the favourable rise/going ratio with the minimum energy requirement use the following equation:

$$2h + t = 63 \text{ (1 step)}$$

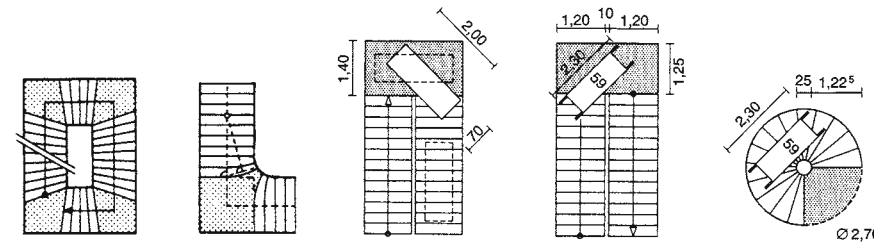
Besides the aforementioned relationships, the overriding functional and architectural purposes of the stair are very important for the dimensioning and design of stairs. It is not just the gain in height that is important but rather the way in which that gain in height is achieved. A low rise of 16 cm (with 30 cm going) is preferred for external stairs designed for use by large numbers of persons simultaneously. On the other hand, steps in offices or escape stairs should render possible a rapid change in height. Every stair deemed necessary must be placed in a continuous stair shaft which, including its entrances and exits to the outside, should be positioned and designed in such a way that it can be used safely as a means of escape. Exit width ≥ stair width. The distance from any point within a room designed for occupation or a basement storey to a stair deemed necessary or an exit may not exceed 35 m. If more than one stair is necessary, they should be distributed so that the means of escape is as short as possible. In stair shafts the openings to basements, roof spaces not designed for occupation, workshops, retail areas, storage areas and similar areas must be fitted with self-closing doors, fire resistance classification T 30.



5-11 All forms of stairs without landings cover practically the same plan area, but the distance from leaving the last step of a lower flight to reaching the first step of the next flight upwards can be considerably shortened by using winders -> 6-10 or spiral stairs. Therefore these are preferred for multistorey buildings.



12-16 Stairs with landings cover the plan area of a single flight + landing area - 1 tread area. Stairs with landings are necessary for storey heights 2.75 m. Landing width stair width. 17 Stair with three flights: expensive, impractical, wastes space



18 Diagonal first step and distorted steps save space 19 Curving the steps in narrow stair shafts saves on landing width 20 Minimum space requirement for transporting furniture 21 Space requirement for stretcher 22 Spiral stairs: space requirement for stretcher

Fig. 20: Source: Ernst Neufert, *Bauteurfslehre*, Braunschweig/Wiesbaden, 2002. - English translation: Ernst and Peter Neufert, *Architect's Data*, Oxford, 2004.

STAIRS

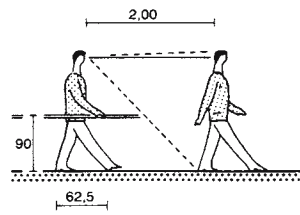
DIN 18064, 18065, 4174

Stipulations covering the design of stairs vary among the building codes. DIN 18065 covers the main requirements to be satisfied by stairs.

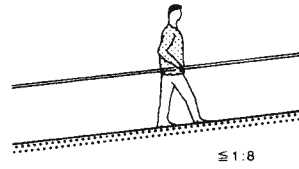
Residential buildings with no more than two apartments: usable width min. 0.80 m, rise/going ratio 17/28; stairs not deemed necessary by the building regulations: 0.50 m, 21/21; other stairs deemed necessary by the building regulations: 1.00 m, 17/28. Stairs in high-rise apartment blocks: 1.25 m wide. Stair width in public buildings must also take into account the desired escape time p. 466 "Theatre". Length of stair flight:  $\geq 3$  steps,  $\leq 18$  steps

5. Landing length = n times step length + 1 tread depth (e.g. for 17/29 rise/going ratio =  $1 \times 63 + 29 = 92$  cm or  $2 \times 63 + 29 = 1.55$  m). Doors opening into a stair shaft may not impair the statutory width.

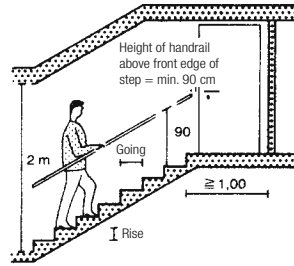
A shallow, comfortable pitch for external stairs in gardens etc. is achieved by including landings every 3 steps. This ensures that a stair in a theatre or an external location is ascended and descended slowly, i.e., it could be even shallower. But a stair to an ancillary entrance or escape stairs should enable a rapid change in height.



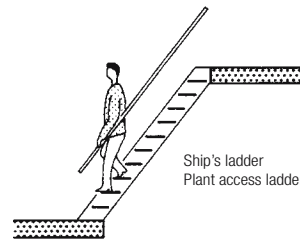
1 Step length of an adult on a horizontal surface



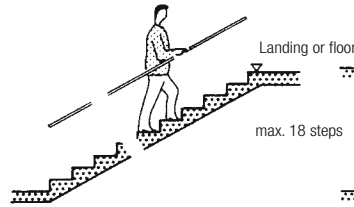
2 An inclined, rising surface shortens the step length; comfortable gradient: 1:10 to 1:8



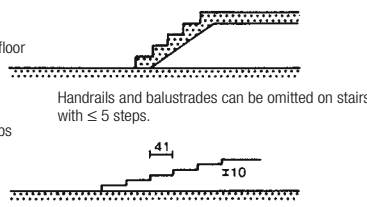
3 Favourable standard rise/going ratio 17/29; step length = 2 going + 1 rise = approx. 62.5 cm



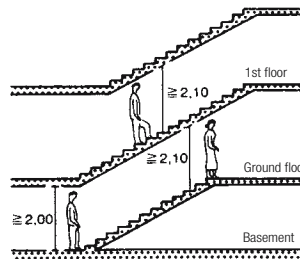
4 Step ladder with balustrade



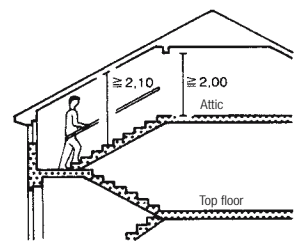
5 Standard stairs 17/29, max. 18 steps



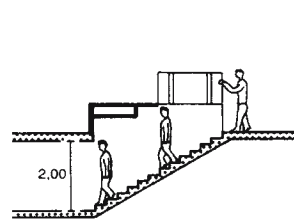
6 Stairs without handrail(s)



7 Stairs can save space when positioned properly one above the other.

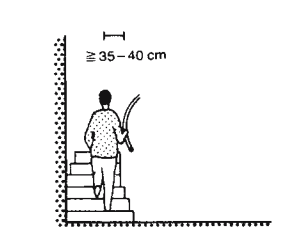


8 If rafters and beams run in the same direction as the stair flight, it is possible to save space and expensive trimmers.

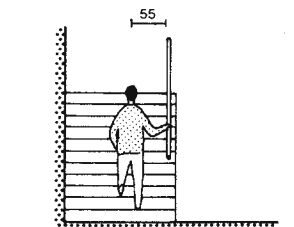


9 Basement entrances and trapdoors should be avoided; however, the above combination is advantageous and presents no risks.

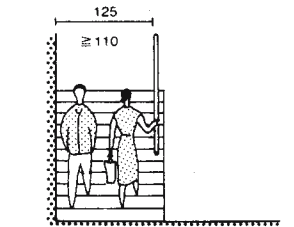
Fig. 21: Source: Ernst Neufert, *Bauelemente* (loc cit).



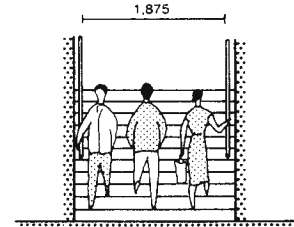
10 On spiral stairs the distance from the line of going to the outside of the string should be 35-40 cm.



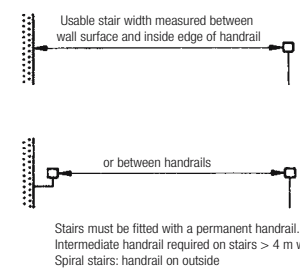
11 On straight flights the distance from the line of going to the balustrade should be 55 cm.



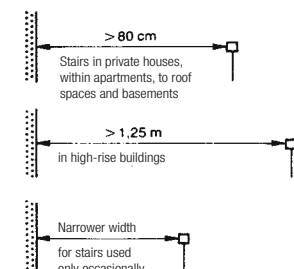
12 Stairs on which two persons can pass without difficulty



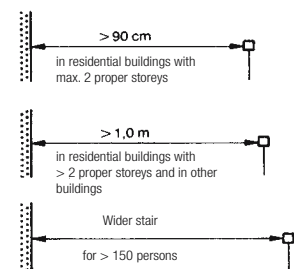
13 Minimum width for three persons



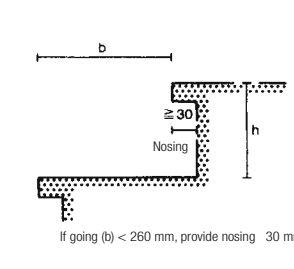
14 Minimum dimensions for stairs



15 Measuring the usable stair width



16 The rise/going ratio of a stair may not change within a flight.



16 The rise/going ratio of a stair may not change within a flight.



## The geometry of stair transitions

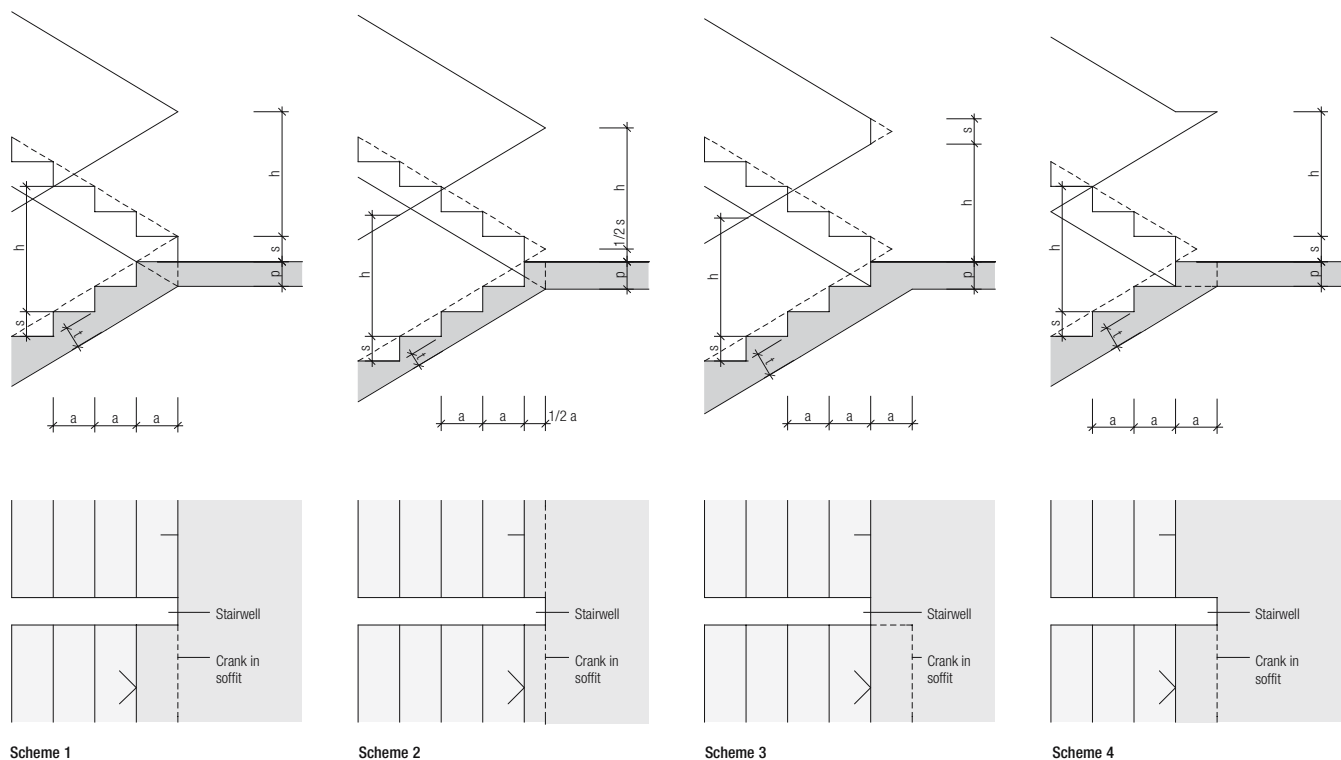


Fig. 22: Schemes (above)

a Going (step depth)  
s Rise (step height)  
h Height of balustrade  
p Thickness of landing slab  
t Thickness of stair slab

### Relationship between stair member thickness, handrail geometry and landing geometry

The designer has to deal with numerous geometrical relationships when designing a staircase. These change depending on the type of staircase construction and the handrails. The schemes shown above therefore do not represent universally valid solutions but rather use the example of a monolithic staircase to demonstrate the typical relationships between step geometry, handrail geometry and thickness of landing and flight members.

#### Scheme 1

Shifting the last step of the lower flight back by one going ( $a$ ) towards the stairwell places the stairwell, the crank in the soffit and the change of direction of the handrail all in one line. However, the exact position of the crank also depends on the ratio of the flight slab thickness to the landing slab thickness ( $p/t$ ), but this can be adjusted within structurally reasonable limits to match the geometry. The change of direction of the handrail is paid for by raising the height of the intersection of the two handrails by one rise ( $h + s$ ). Any horizontal handrails required at this point would therefore also need to be positioned at a height of  $h + s$ .

#### Scheme 2

If the top step of the lower flight and bottom step of the upper flight are each shifted towards the stairwell by half of one going ( $a/2$ ), the stairwell, the crank in the soffit

and the change of direction of the handrail all lie in one line. Again, the exact position of the crank depends on the ratio of flight slab thickness to landing slab thickness ( $p/t$ ). However, the change of direction of the handrail is only raised by half of one rise ( $h + s/2$ ).

#### Scheme 3

Aligning the top step of the lower flight and bottom step of the upper flight with the end of the stairwell shifts the crank in the soffit (of a monolithic stair) of the lower flight into the landing by approximately one going ( $a$ ). The intersection of the handrails moves into the landing by half of one going ( $a/2$ ). This problem can be overcome by using a curved handrail or interrupting the handrail, depending on the width of the stairwell.

#### Scheme 4

If the top step of the lower flight and bottom step of the upper flight each shifted towards the stairwell by one going ( $a$ ), the crank in the soffit of the lower flight coincides with the end of the stairwell. The handrail then needs to change direction twice in order to achieve the same height again.

## Balustrades and spandrel panels

Extract from Swiss standard SIA 358, 1996 edition

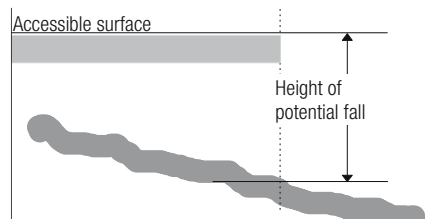


Fig. 23: Definition of height from which a person can fall

### Objective of protection

Balustrades, spandrel panels and handrails must constitute constructional measures to prevent persons falling from a higher level to a lower level. Protection against a risk of falling is given when suitable measures reduce the risk to an acceptably low level.

### Strength

The design and construction of balustrades, spandrel panels and similar safety elements should be such that they can withstand the loads and stresses anticipated. This requirement shall also apply to the associated fixings and infill panels.

### Materials

Materials that may corrode or may be adversely affected by the weather must be suitably protected and maintained. Risk of injury caused by damage to infill panels of glass, plastic and similar materials must be prevented by choosing a suitable material.

### Arrangement of safety elements

#### *Balustrades and spandrel panels*

Every surface that may be used by persons, i.e., every surface accessible to persons, in normal circumstances and that could constitute a risk of falling must be protected by a safety element. A risk must generally be assumed when a person could fall from a height of more than 1.0 m. Said height is the vertical difference between the edge of the accessible surface and the adjoining surface at a lower level. If there is an increased risk of falling, safety elements may be necessary even at lower heights. Safety elements for heights up to 1.5 m can be provided in the form of measures that simply restrict access to the edge of the accessible surface, e.g. planting.

#### *Handrails*

Stairs with more than five steps shall generally be provided with handrails. Escape stairs and stairs with more than two steps that are normally used by disabled, elderly or infirm persons shall generally be provided with handrails on both sides.

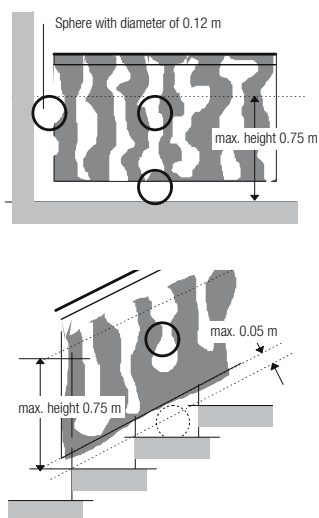


Fig. 24: Geometry of safety elements

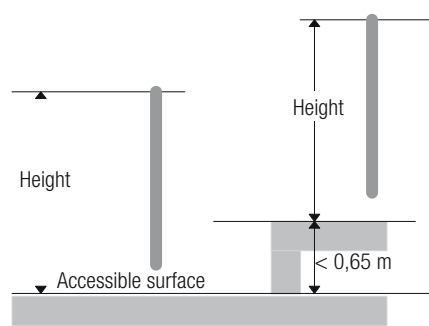


Fig. 25: Height of safety elements

### Requirements to be satisfied by safety elements

#### *Height*

The height is measured from the accessible surface, in the case of stairs perpendicular from the front edge of the step to the top edge of the safety element.

In the case of spandrel panels, the top edge of the fixed part of the bottom member of the window frame obtains.

Components, e.g. copings, radiators, in front of the safety element with an accessible surface less than 0.65 m above the primary accessible surface shall be regarded as accessible. In such a case the height of the safety element is measured above the higher surface. The normal height of a safety element is at least 1.0 m. In the case of permanent spandrel panels at least 0.2 m thick the minimum height shall be 0.9 m.

Spandrel panels and balustrades along a flight of stairs shall exhibit a minimum height of 0.9 m. For reasons of serviceability (avoidance of feelings of insecurity and dizziness), the height of safety elements should be increased in the case of extreme heights from which persons could fall.

#### *Geometric arrangement*

Balustrades, spandrel panels and similar safety elements must prevent persons from falling through them. The minimum requirement is a longitudinal member at the highest point plus an intermediate longitudinal member at half height or vertical members at a maximum spacing of 0.3 m. In buildings to which unsupervised children of pre-school age have access the following special requirements shall apply:

Openings in safety elements up to a height of 0.75 m may not permit the passage of a sphere with a diameter of 0.12 m. This requirement shall also apply to openings between safety elements and between safety elements and adjoining building components (exception: openings between edge of step and balustrade). On stairs the distance between front edge of step and balustrade may not exceed 0.05 m. Climbing on the safety elements shall be prevented or made difficult by suitable measures.

## Lifts



Fig. 26: The lift installation stands detached within the stairwell.  
Arne Jacobsen: Sölleröd Town Hall (DK), 1942

The vertical transport of persons and loads between storeys one above the other in a building is achieved by way of lifts. These are always counted as part of the infrastructure. They are not directly linked with the building services but rather are directly dependent on the vertical and horizontal circulation areas for persons within buildings.

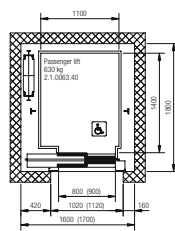
Unlike staircases, which expand vertically and horizontally and can change position from storey to storey, lifts are housed in vertical shafts for reasons of support and fire protection. Lifts form circulation interfaces for persons and goods on every single floor and are therefore also positioned in the immediate proximity of the stairs, not least to make sure they are more readily located.

The requirements placed on lifts are essentially determined by the use and function of the building. We distin-

guish between passenger lifts and goods lifts. However, owing to the requirements of the market and technological developments, the boundaries between different types of lift are not fixed.

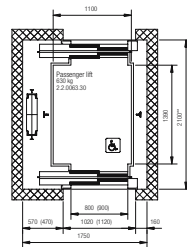
ISO 4190 specifies that a lift car must have a floor area measuring at least 1.40 x 1.10 m (depth x width) and a door opening at least 0.80 m wide in order to accommodate a wheelchair. All lift manufacturers can supply a standard model with these car dimensions and a load-carrying capacity of min. 630 kg for max. 8 persons. This provides enough space for the majority of wheelchairs plus up to two other persons. The space in front of lift doors should be large enough to accommodate persons waiting for the lift. A minimum lobby size of 1.40 x 1.40 m is recommended.

Fig. 27: A selection of various car and shaft dimensions; source: AS Lifts AG



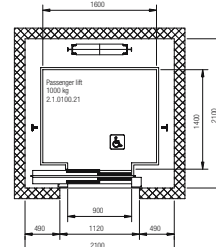
Passenger lift, small, door on one side

- Residential and office buildings
- Load-carrying capacity: 630 kg
- Car for up to 8 persons, standard type suitable for the majority of wheelchairs and prams
- Door on one side = minimum shaft dimensions
- 2-panel side-opening sliding door



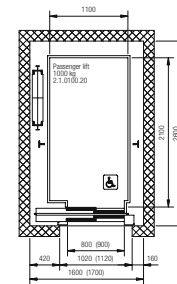
Passenger lift, small, doors on two sides

- Residential and office buildings
- Load-carrying capacity: 630 kg
- Car for up to 8 persons, suitable for wheelchairs and prams
- Doors on 2 sides = deeper shaft required
- 2-panel side-opening sliding doors



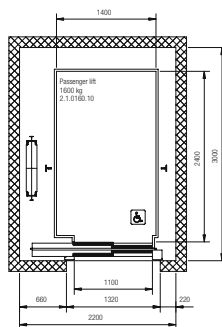
Passenger lift, medium, door on one side

- Office buildings
- Load-carrying capacity: 1000 kg
- Car for up to 13 persons, suitable for wheelchairs
- Wide car for more frequent use
- Door on one side
- 2-panel side-opening sliding door



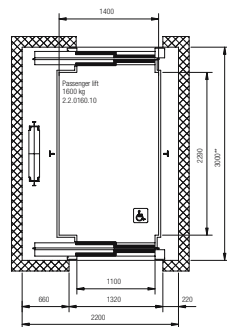
Passenger lift, medium, door on one side

- Residential and office buildings
- Load-carrying capacity: 1000 kg
- Car for up to 13 persons, suitable for wheelchairs and stretchers
- Deep car for easy transport of furniture
- Door on one side
- 2-panel side-opening sliding door



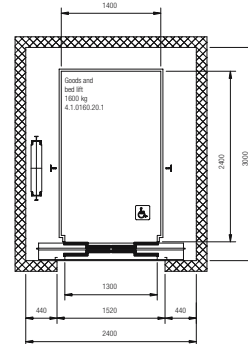
Passenger and goods lift, large, door on one side

- Office and industrial buildings, department stores
- Load-carrying capacity: 1600 kg
- Car for up to 21 persons, suitable for pallets
- Door on one side
- 2-panel side-opening sliding door



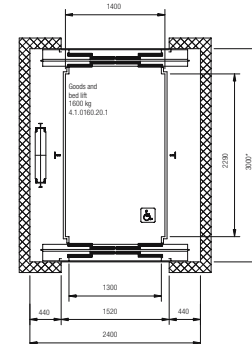
Passenger and goods lift, large, doors on two sides

- Office and industrial buildings, department stores
- Load-carrying capacity: 1600 kg
- Car for up to 21 persons, suitable for pallets
- Doors on 2 sides = shorter car but identical shaft dimensions
- 2-panel side-opening sliding doors



Bed and goods lift, large, door on one side

- Hospitals and industrial buildings, department stores
- Load-carrying capacity: 1600 kg
- Car for up to 21 persons, suitable for pallets and beds
- Door on one side
- 4-panel centre-opening sliding door



Bed and goods lift, large, doors on two sides

- Hospitals and industrial buildings, department stores
- Load-carrying capacity: 1600 kg
- Car for up to 21 persons, suitable for pallets and beds
- Doors on 2 sides = shorter car but identical shaft dimensions
- 4-panel centre-opening sliding door

### Lift drive systems

Three different lift drive systems are described below; these are typical of modern lifts. Basically, we distinguish between electromechanical lifts with wire ropes and counterweights, and electrohydraulic lifts with pump and ram.

The simple rope-operated lift is widely used today. Various gear ratios enable a lower driving power or the lifting of heavier loads. The travelling speed can be varied accordingly. The simple drive mechanism makes these lifts ideal for tall buildings.

Electrohydraulic lifts have a limited travelling speed and height, which depends on the maximum pressure that can be generated by the pump. Such lifts are useful in lower buildings. Their advantage is that the drive can be positioned virtually anywhere around the shaft.

Hybrid driving systems, which influence the performance and the position of the drive, as well as the design of the headroom at the top and lift pit at the bottom of the shaft, are available from numerous manufacturers.

Fig. 28: Three examples of various types of drive showing the effects on shaft geometries for identical car dimensions; source: AS Lifts AG

Fig. 29: Lift doors



#### 2-panel side-opening sliding door

This arrangement telescopes to one side and influences the width of the shaft. This type of door is suitable for standard cars with narrow openings.



#### 4-panel centre-opening sliding door

This arrangement telescopes to both sides. The width of the shaft is essentially governed by the type of drive and not the door.



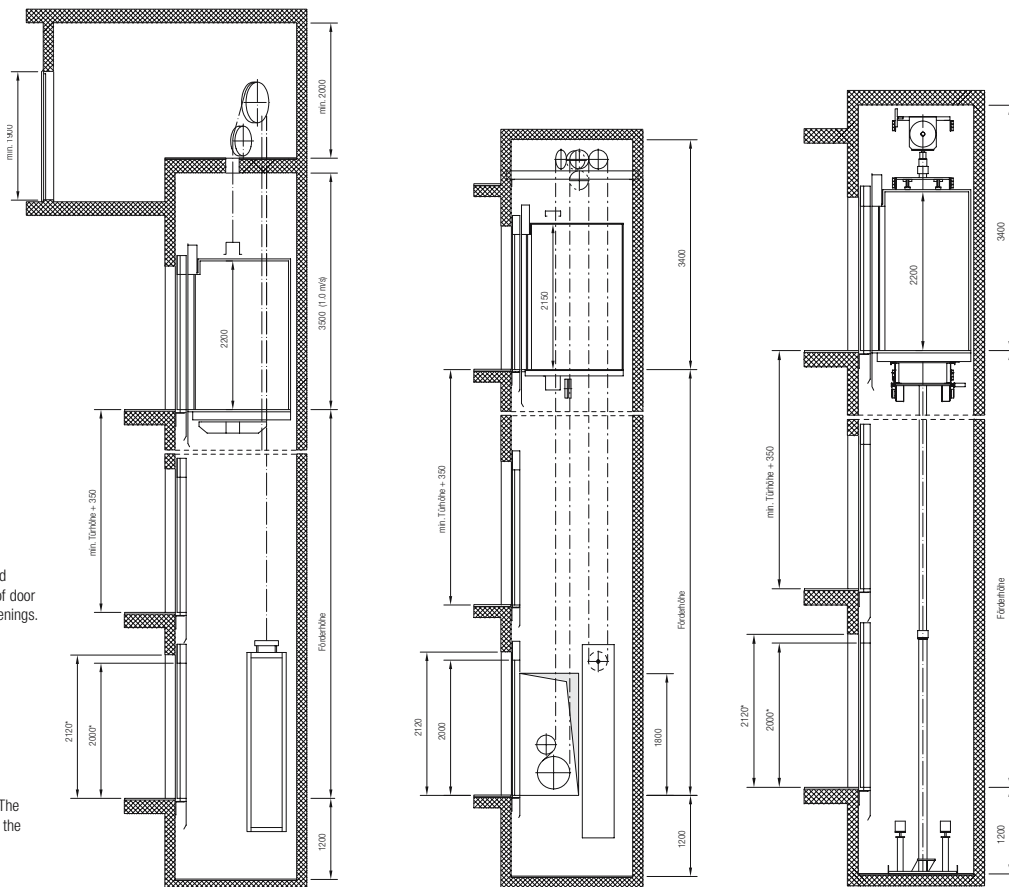
#### 6-panel centre-opening sliding door

This arrangement telescopes to both sides and is not very deep when open. This type of door is suitable for cars with wide openings (e.g. hospitals and industrial buildings).



#### 2-panel centre-opening sliding door

This arrangement telescopes to both sides and is deep when open, which has a crucial effect on the width of the shaft. This type of door is suitable for cars with wide openings from which persons may exit rapidly (e.g. high-rise office buildings).



#### Electromechanical simple rope-operated lift

The drive is accommodated in a separate lift machine room located directly above the lift shaft or to the side at the bottom. The load-carrying capacity is approx. 1600 kg; heavier loads require the gear ratio (up to 4:1) to be increased.

- gear ratio 1:1, central drive
- lifting height up to approx. 30 m
- travelling speed up to 2.0 m/s

#### Electromechanical geared rope-operated lift

The drive is accommodated in the shaft; it is easily reached from the outside via a separate door. This arrangement of the drive means that a lift machine room at or above roof level is usually unnecessary. Depending on the manufacturer, the drive can be located at the top of the shaft but also directly on the car itself.

- gear ratio 4:1, drive at side
- lifting height up to approx. 15 m (5 floors)
- travelling speed approx. 1.0 m/s

#### Electrohydraulic cantilever-style lift

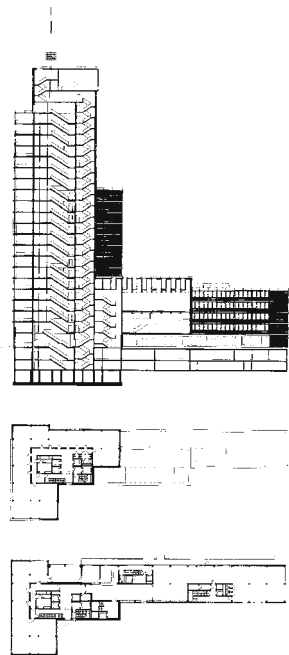
The hydraulic drive can be located on any floor in a separate lift machine cabinet within a radius of approx. 10 m around the shaft. The ram adjacent to the car enables doors to be positioned on up to three sides. At least one loadbearing shaft wall is required.

- gear ratio 2:1, drive at side
- lifting height up to approx. 18 m
- travelling speed approx. 0.6 m/s



## The staircase as an assembly of simply-supported beams

Burkhard, Meyer & Partner: Services centre in Winterthur (CH), 1999



Figs 30 and 31: Section and plans



Fig. 32: Staircase  
Burkhard Meyer & Partner: Service centre, Winterthur (CH), 1999

The mainly single flights of stairs in the access tower to this high-rise block connect storey heights of up to 4.5 m. This results in large spans for the individual stair flights, which are made from precast, solid, dark reconstituted stone.

As the load-carrying capacity of this reconstituted stone material is less than that of conventional concrete, four precast concrete elements are responsible for the loadbearing functions of the stair flights. These act as primary beams spanning between the supports. While one of these beams is in the form of a conventional downstand beam, the other is in the form of a deep beam and simultaneously acts as the balustrade. At the ends these beams are supplemented by two support elements (L-shaped in section). The reconstituted stone stair elements are laid on these loadbearing elements, with neoprene pads ensuring that no impact sound is transferred to the primary loadbearing members. The verticality, the physical presence and the accuracy of the precast elements determine the expression of the stair shaft.

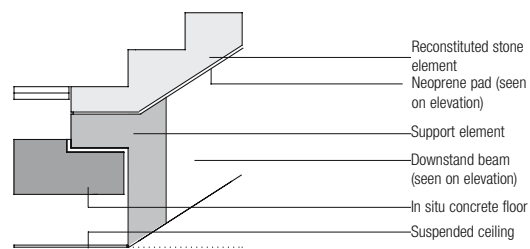


Fig. 33: Detail of support

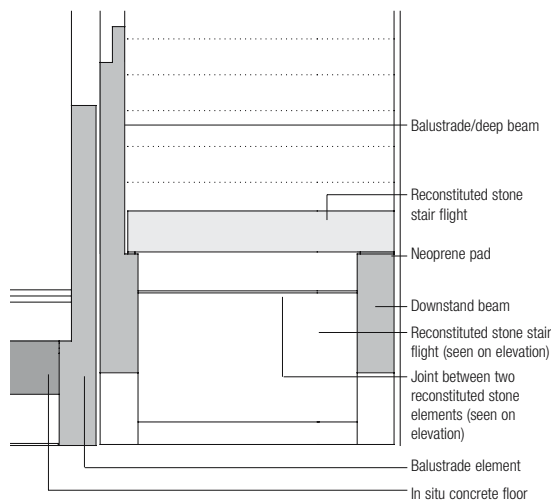


Fig. 34: Cross-section through stair

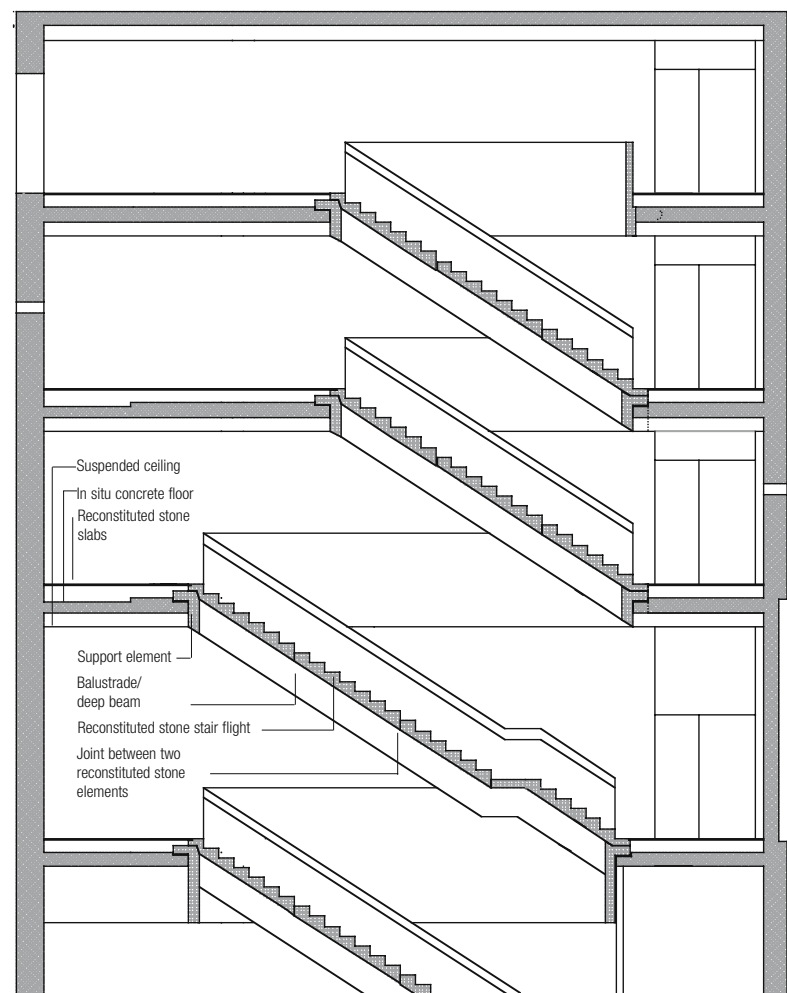


Fig. 35: Section through stair shaft

## The staircase as a monolithic, organic form

Herzog & de Meuron: Küppersmühle Museum in Duisburg (D), 1999



Fig. 36: The seemingly organic stairwell



Fig. 37: No joints are visible.

As an expressively designed vertical edifice, the external stair tower with a pentagonal plan shape forms a deliberate contrast to the modest statements of the exhibition rooms of this converted industrial building.

The cantilevering fair-face concrete stair construction winds its way up between the angled external walls around a seemingly organic stairwell. This space has been given its homogeneous character by ensuring that no joints are visible between the various concrete pours.

The external concrete walls were constructed first before casting the concrete balustrade and the stair flight in one operation. This meant that an L-shaped cross-section had to be cast. However, that made compaction very difficult because it is impossible to pass a poker vibrator around a 90 degree angle. The surfaces affected, i.e., the steps and the floor, were subsequently covered with a similarly homogeneous terrazzo finish. The vertical boards used as the formwork for the balustrade and the boards for the soffit formwork enabled the construction joints, which are essential over such a length of stair flight meandering over four storeys, to remain concealed. The top of the balustrade was the only surface that had to be finished (in this case ground) subsequently.

All the fair-face concrete parts have a red-brown colouring and hence reflect the colour of the brickwork of the existing building. The terrazzo finish likewise makes use of the same colour, which results in a monochromatic space and enhances the monolithic effect of the construction.

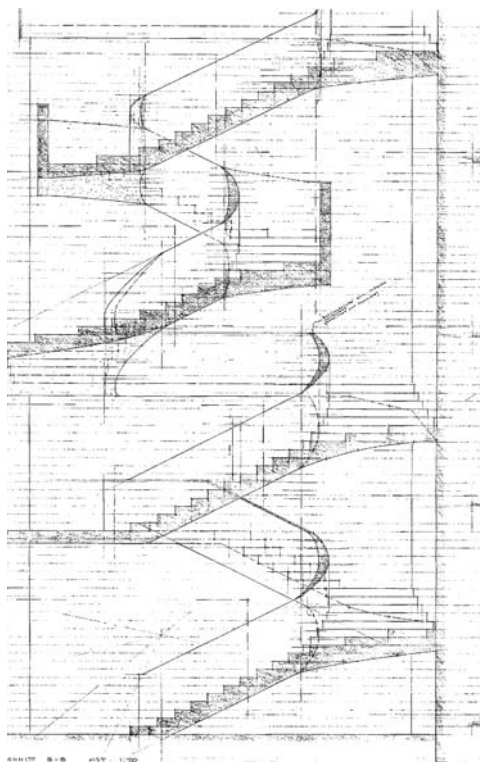


Fig. 38: Section

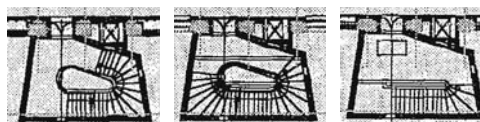


Fig. 39: Plans of ground floor, 1st floor and 2nd floor

## The staircase as a space frame

Otto Rudolf Salvisberg: District heating power station, ETH Zürich (CH), 1935

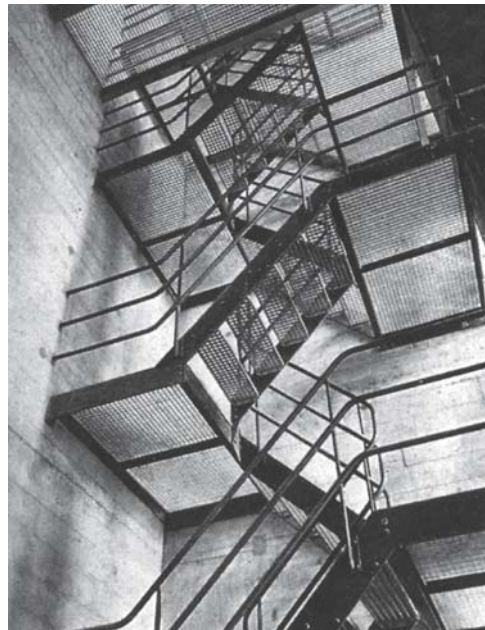


Fig. 40: General view of stairs

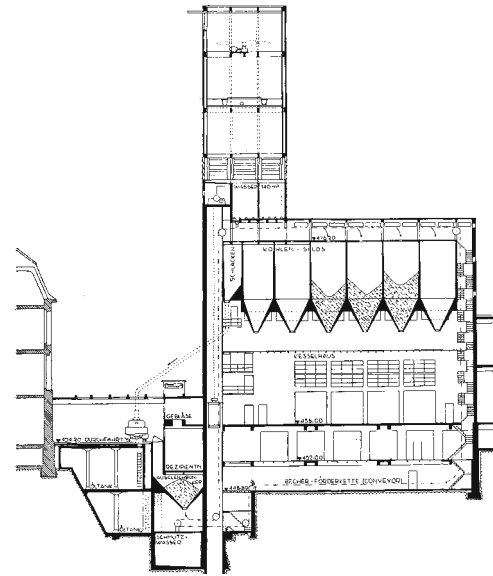


Fig. 44: Section through boiler house



Fig. 41: Detail of stairwell

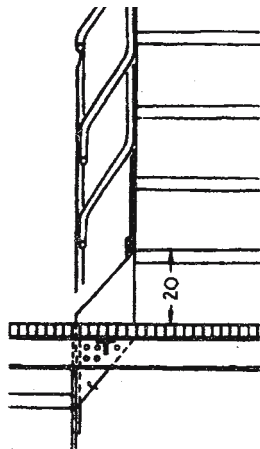


Fig. 42: Detail of stair/landing junction

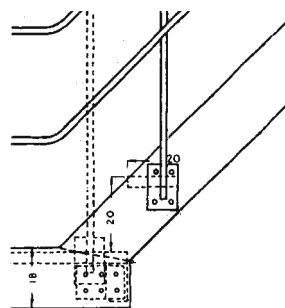
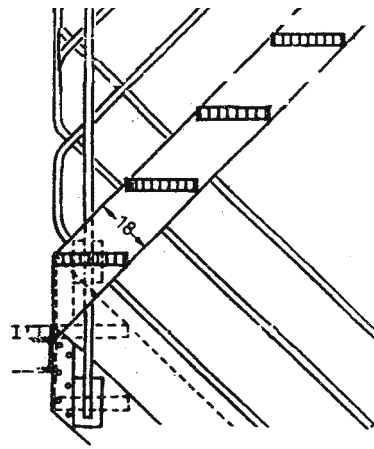


Fig. 43: Detail of connection between outer string and landing

Two “transparent” steel staircases with open-grid landings and treads were built in the boiler house. These stairs lend some texture to the elongated interior space surrounded by solid concrete walls and the silo hoppers but without occupying any space.

Situated in the corner, the three-dimensional structure climbs in dog-leg style up to the dizzy heights of the silo-charging level. Below the silo hopper openings steel beams and open-grid flooring panels make up the “transparent” mezzanine floor which stretches right across the interior, allowing workers access to the silo outlets.

Steel strings 18 cm deep are used as the primary load-bearing members for the stair flights and landings; these are bolted directly to the concrete walls. The stair string at the landing is bent into a loop around the stairwell without having to change the pitch in the transverse direction. This defines the geometry of the transitions at the landings and leads to an unconventional, welded crank in the outer strings that is nonetheless a harmonious complement to the detail of the inner strings when seen as a whole. The treads made from open-grid flooring are bolted directly between the strings without the need for any secondary loadbearing members and therefore seem to dissolve into the background. Steel flats and fixing plates join the tubular uprights of the balustrades to the strings. Where the tubular handrails and intermediate rails meet the concrete wall they are simply bolted directly to the wall.

Apart from the “lightweight”, simple form of construction, the direct connections between the stair components and the walls also play a major role in creating the effect of a space frame.



## The staircase as a solid timber construction

Conradin Clavuot: School in St Peter (CH), 1998



Fig. 45: The ends of the steps



Fig. 46: General view of stair

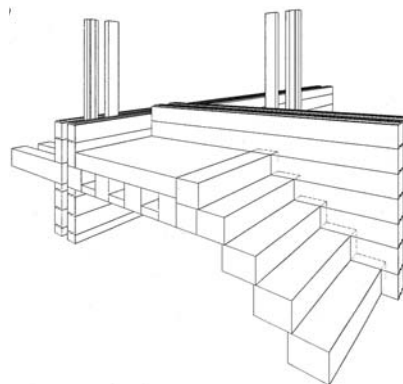


Fig. 49: Perspective view

The interior of the school in St Peter is determined by the material presence of the pine beams in log construction. The design of the staircase blends seamlessly into this constructional concept. The steps are made from untreated beams which appear to grow out of the module of the solid timber wall, running between wall and balustrade. While the steps were shown let into the wall in the early drawings (see Fig. 49), this was not carried out on site because the solid timber wall is one of the shear walls of the building whose structural action would have been interrupted by the inclusion of such members. The support on the wall side was therefore accomplished with a mortise and tenon joint additionally secured on the far side of the wall with metal bolts (see Fig. 48). The steps are suspended on bolts (concealed by dummy tenons) from the balustrade, which is also made from solid timber members and spans the distance between the floors. The individual members of the balustrade are joined by a number of threaded bars so that the balustrade acts as a deep beam and can span the full distance between floors.

Solid timber undergoes contraction and hence settlement in the first years of the life of a structure. In this school the settlement per storey was up to 10 cm. This resulted in the balustrade, which runs between the floors, undergoing a minimal (calculated) rotational movement. That in turn subjected the steps to a certain amount of torsion because their two supports were each subjected to different movement caused by the settlement. This factor and the contraction of the individual components of the staircase has led to small but noticeable gaps between the individual timber components. However, this in no way impairs the overall character of the construction. The elegant rawness of the solid components easily accommodate this phenomenon; indeed, it tends to emphasise their expressive character.

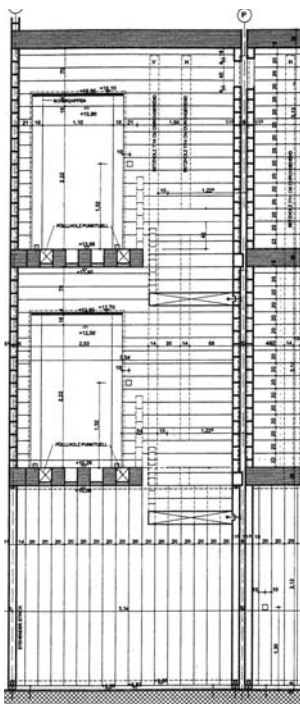


Fig. 47: Section

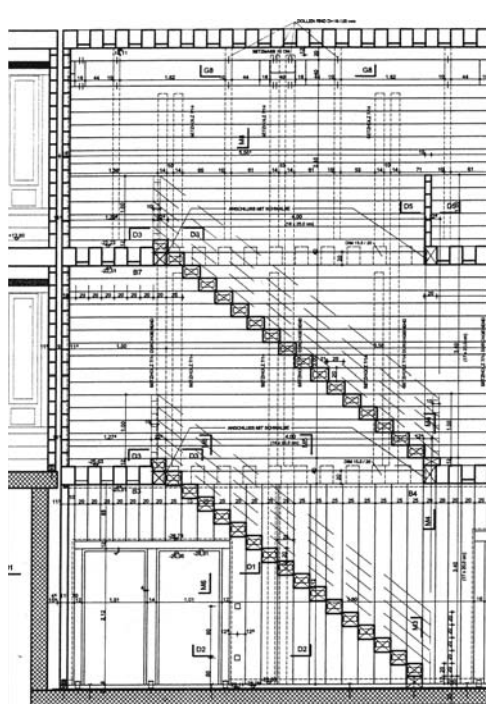


Fig. 48: Longitudinal section



# STRUCTURES

	<b>Forms of construction</b>	<b>Building performance, energy</b>
Introduction	<u>An attempt to classify horizontal and vertical space development</u>	<u>Sustainability</u> <u>– Fundamentals of architecture</u>
Concepts	<u>Vertical loadbearing structures in solid construction – Cross-section concepts</u> <u>Vertical loadbearing structures in solid construction – Plan concepts</u> <u>Vaulted loadbearing structures in solid construction – Compression structures</u>	<u>The problem of heat flow and vapour diffusion</u> <u>Insulation concepts – Diagram of layers</u> <u>Insulation concepts – Complementary systems, load-bearing layer inside</u> <u>Insulation concepts – Complementary systems, load-bearing layer outside</u> <u>Seven rules for the design of a low-energy house</u>
Examples	<u>Of heavy mass and apparent heaviness</u> <u>Ksar Ferich – A fortified store-house in southern Tunisia</u> <u>Sculpted architecture – The Scottish tower house</u>	<u>Low-tech – High tectonic</u>
Processes	<u>Provision of services during planning work</u> <u>The sequence of building operations</u>	
Systems	<u>Compartmentation</u> <u>Box frame construction</u> <u>Frame construction</u> <u>Column-and-slab systems</u> <u>Single-storey shed forms</u>	
Systems in architecture	<u>Prefabrication – System building</u>	

## An attempt to classify horizontal and vertical space development

Andrea Deplazes, Christoph Wieser

The job of the architect is actually to demarcate a piece of infinite space and place it in an enclosure. The most elementary form of such an enclosure, the simple compartment (the nucleus of human shelter), is our starting point for the following deliberations. What principles apply when extending this single room in the horizontal and vertical directions to form complex room conglomerates? In doing so, how do we alter the structure of the resulting buildings?

We shall proceed from the space to the structure (and back again), both in the concrete and the abstract sense. The deliberately simplified hypothetical model we shall be using for this purpose shall serve to establish a provisional classification which will be enriched with practical examples and hence also placed in perspective. This is because the proposed development does not pretend to be universally applicable; more complex sequences and hybrid forms of all kinds can prevail in everyday situations.

### Horizontal space development

For the sake of simplicity let us take this ancient compartment, so to speak, to be an abstract, early square hut measuring about four by four metres and with a height of two to three metres. Its effective size is primarily governed by its use and – in contrast to the snail's shell – is not directly derived from the size of the human body, even if this analogy does seem tempting. For there is no direct,

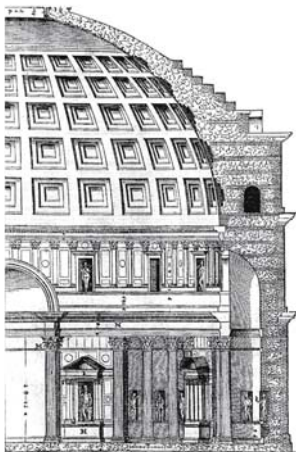
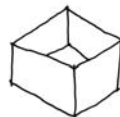


Fig. 1: Section after Palladio, 1570  
Pantheon, Rome (I), 118–128 AD



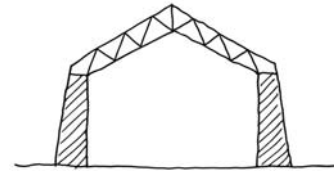
“genetic” link between architectural form and the physiology of the human body. However, the form does not “simply appear”. Besides materials-related, structural, cultural and social factors, the radius of action of our arms and human strength, for example, are just as important for determining the final size of huts and tents as are the materials employed.

Starting with the model of a one-room house, horizontal space development can take place in two basic ways: a) by increasing the volume, and b) by multiplying the compartments, which are then linked together.

### From chamber to hall

The desire to increase the size of the individual compartment has many causes. One of the earliest and most obvious may well be that a group needed to create a suitable place of assembly for festivities and other purposes. If the volume is enlarged, however, the dimensions of the structurally relevant parts also have to increase: the structural depth of the roof and the thickness of the walls. But this is possible only up to a certain degree – until the load-carry-

ing capacities of the materials are reached, thus forcing a change to the construction system. Although the increase in volume results in the desired enlargement of the interior space (the living space for one family becomes the communal hall for a whole village), there is a conflict of interests from a structural viewpoint. To span large distances we need more material, which leads to an increase in weight and hence to complications in the loadbearing



system, which in turn has an effect on the maximum span possible.

Depending on their properties, loadbearing structures can be designed with an “active cross-section” or an “active form”. What interests us here though is not an understanding of these different concepts from a structural engineering point of view but rather their function with respect to architectural structures. In constructions with an active cross-section the forces flow within an unspecified cross-section which is “oversized” and hence includes structurally inactive zones, or rather the relevant cross-section becomes the general cross-section. To save weight therefore it is often possible to use a lightweight material. For example, the Pantheon in Rome (118–128 AD), whose circular dome consists of ever lighter concrete mixes as it approaches the crown.

This is accompanied, however, by a decrease in the thickness of the shell, which makes the dome of the Pantheon a good example of an early, partly optimised loadbearing structure with an active form. For in such structural systems the flow of forces becomes a form-finding parameter and the structure is reduced until only the structurally relevant parts remain. Typical examples of this are frames of all kinds, be they simple trusses for spanning Roman basilicas, or the experiments of Konrad Wachsmann, who by means of an ingenious node design devises ever bolder space frames in steel. In contrast to loadbearing structures with an active cross-section, those with an active form demonstrate the “unadulterated” flow of forces. It is no surprise that this latter form was especially cultivated as an “honest” approach to form-finding during the Modern Movement.

As the example of the Pantheon – whose dome diameter of 43.3 metres was not equalled and exceeded until the 20th century – shows, even high-performance loadbearing structures for spanning a space without intervening supports reach the limit of the technical feasibility of their age at some point. And they are often totally

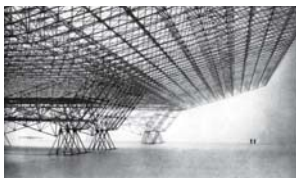
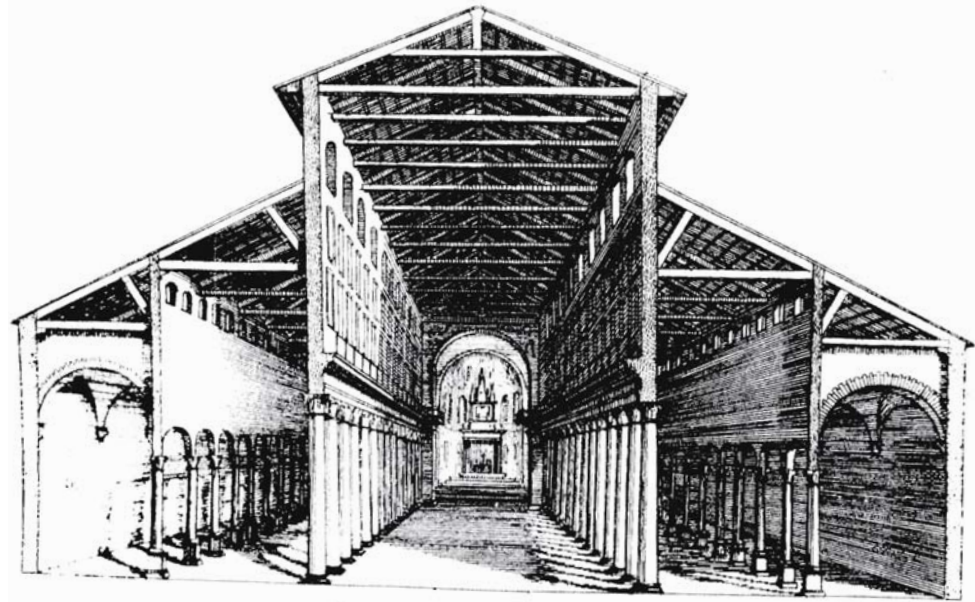
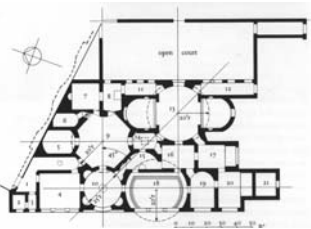


Fig. 2: Filigree loadbearing structure based on a modular arrangement and standardised member length  
Konrad Wachsmann: model of a three-dimensional (space) frame



**Fig. 3:** Cross-section through basilica with double aisles  
Earlier building on site of St Peters, Rome (I),  
4th century AD

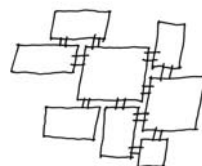


**Fig. 4:** Plan of small thermae  
Hadrian's villa, Tivoli (I), 118–134 AD

inadvisable for reasons of proportions. Therefore, the basilica was an early form of one-room building whose multi-bay arrangement cleverly distributes the loads: the horizontal component of the thrust which ensues from spanning the nave is resisted by the aisles. This measure produces not only a large, coherent interior space, but the distribution of the loads enables a construction with more slender members – the loadbearing walls were essentially resolved into colonnades, as in Gothic churches. The spectacular interiors flooded with light are paid for with a row of flying buttresses which, placed on the outside, guarantee the necessary equilibrium of forces and return the external form to earthly reality.

#### From the compartment to the conglomerate

The addition of further compartments produces a conglomerate whose parts can be composed to form a complex whole. Everyday needs trigger this type of horizontal development: the selection of spaces available has to be expanded. At the same time, there is the option of differentiating the individual spaces, e.g. to suit various functions, because the additional compartments need not have the same form nor the same dimensions. It is therefore conceivable that a ring of ancillary spaces could be arranged around one central, main space. If this latter space is open to the sky we create a courtyard house, a type of building design that had already been fully explored



by 2000 BC. Or the individual spaces of a conglomerate can be grouped in a tight sequence of varying proportions, dimensions and types, e.g. Hadrian's villa in Tivoli (118–134 AD), where this principle is artistically and enthusiastically celebrated, particularly in the small thermae.

Characteristic of such conglomerates is their tendency to be flexible with regard to further extensions, which Hadrian's villa demonstrates in exemplary fashion. The Roman Emperor Hadrian built a huge country retreat on a raised piece of ground covering about 300 hectares. The villa comprises four complexes with four different axes. As the external form of such a complex built in phases is not determined by restrictive conventions such as symmetry, in principle every new addition can change the configuration of the building completely.

The situation is of course much different in an urban context, where the perimeter practically prescribes, or at least severely influences, the external form. In this case the development will not be additive but rather divisive: starting with our external form the building is divided into individual spaces depending on the respective wishes and utilisation requirements. Incidentally, this method is even found in ancient one-room houses whose volume has been subdivided into separate rooms; sometimes, though, the walls do not extend up to the underside of the roof but instead are merely partitions reaching a certain height. This observation brings to light a structural phenomenon: buildings conceived with a divided interior are frequently built with solid external walls but an internal structure which owes its origins to filigree construction. This was the case with the castles of the Middle Ages, whose defensive walls were supplemented internally by relatively lightweight timber constructions. These days for

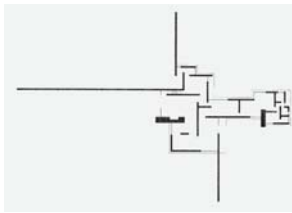
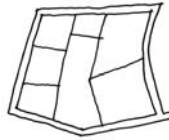


Fig. 5: Ludwig Mies van der Rohe:  
brick country house project (1923–24)

reasons of fire protection party walls still make use of solid construction, while the inner construction is less strictly regulated.

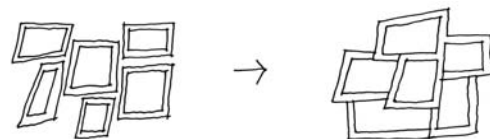
In structural terms the linking of individual compartments is interesting because there is a direct relation-



ship between the openness principle and the construction system. In solid constructions the openness of the rooms with respect to each other, but also to the outside world, is severely restricted, although techniques have been developed here that allow the walls to be reduced to loadbearing columns. The solid walls are the dominating element and openings have to be – figuratively speaking – punched through these subsequently. By contrast, in filigree construction openings and connections of any size are possible anywhere, provided they do not break the logic of the loadbearing “skeleton”. We could say, somewhat exaggeratedly, that in filigree construction the spaces do not need to be connected with each other, but instead individual spaces must first be created by means of separating elements because the structure provides merely a three-dimensional framework.

The example of additive interior space development is based on the assumption that individual compartments, independent in terms of layout and structural factors, are joined to form a conglomerate. However, this results in a doubling of the walls, which in reality does not take place of course because this would represent an uneconomic use of resources. Consequently, the extensions, in structural terms consist “solely” of wall segments of all shapes and sizes. Only in conjunction with the existing space(s) do they produce additional spaces and achieve the equilibrium of forces necessary for load-carrying purposes.

In principle, the flowing spatial concepts of De Stijl or Mies van der Rohe's design for a brick country house (1923–24) could be interpreted as a radical further development of this method. The self-contained structure of the intersecting wall segments has been resolved and walls not required for loadbearing purposes have been omit-



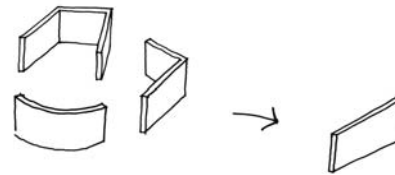
ted; the plane, L-shaped and circular segments are free-standing and define the spaces in between only loosely. But the covering over the spaces is realised differently. Al-

though in traditional building every compartment is often spanned individually for practical and economic reasons, the Modern Movement roof acts as a coherent loadbearing structure which permits cantilevers to a certain extent (e.g. platforms of steel sections or flat reinforced concrete slabs).

### Fundamental types of simple coverings over spaces

Back to the simple compartment. Its structural arrangement will now be investigated in somewhat more detail in relation to the system chosen for covering the space, and by means of a) vaulting, b) domes, and c) plane systems.

The choice of one or other type of roof over a hut in early times was governed by the materials available, and even to this day the material properties determine the



maximum span possible. The material also prescribes the constructional and the stylistic arrangement of the covering: heavyweight domes exhibit other properties to those of stressed skin structures or floors in timber and later in steel; yet further options became available in the 20th

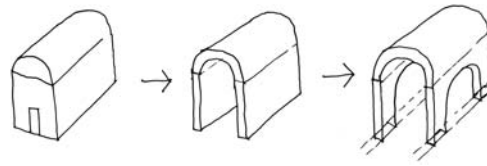


century in the form of reinforced concrete slabs. Vaults and domes are usually associated with a solid form of construction. As ancient examples illustrate, these forms of loadbearing construction are also feasible in filigree construction in terms of style (however, not in terms of their structural action).

a) Roofing over a compartment with vaulting results in a directional construction because the load of the vault is transferred to two of the four enclosing walls. Consequently, the structurally irrelevant end walls can be provided with large openings or even omitted completely, provided the transverse stability can be guaranteed in some other way. This simple shear wall principle can be further resolved by reducing the walls themselves to arches, then to columns.

b) A square single space with a dome as the roof is often described as a “non-directional” construction, which, however, describes the actual situation rather imprecisely. It would be more correct to say “bi-directional” because the thrust from the dome is transferred equally





to all four walls. Providing a tension ring at the base of the dome enables the thrust to be neutralised, and hence the walls to be resolved as far as the load-carrying capacity of the arches and columns permit. Of course, a circular building following the same principles is also conceivable. Examples are provided by Greek and Roman temples in which the walls have been replaced by a ring of columns.

c) The third option for roofing over a compartment is the plane variety, using joists of timber or beams of steel which, in contrast to vaulting and domes, are subject to bending moments and not axial thrust. The enclosure of the space below can be in the form of solid construction – with walls – but also filigree construction – as a frame. In structural terms this version is related to the first one

because the rooms are directional; the load-carrying roof members are supported on two of the four sides, on the walls or the frame. However, the reinforced concrete floor slabs so popular today exhibit a different behaviour; depending on how the reinforcement has been integrated, the direction of span can be chosen and manipulated. Thanks to the introduction of downstand beams this third variation enables the loadbearing walls or frames to be replaced by slender columns. However, once again it should not be forgotten that as the degree of resolution advances, so the stability in the longitudinal and transverse directions becomes ever more critical.

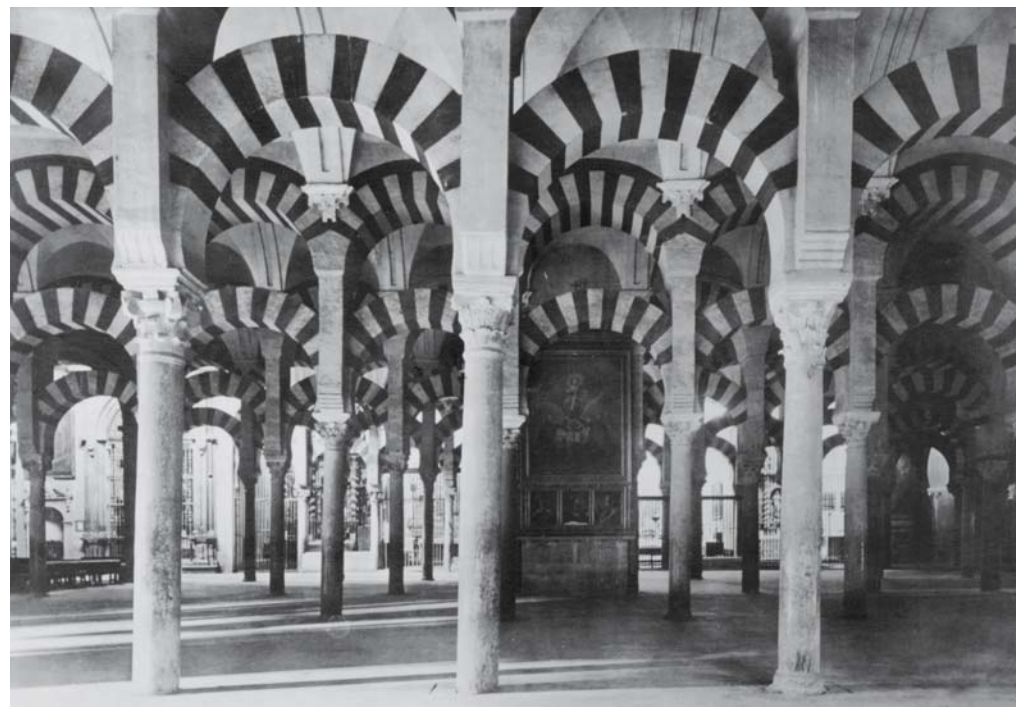
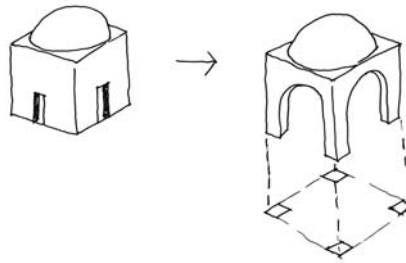
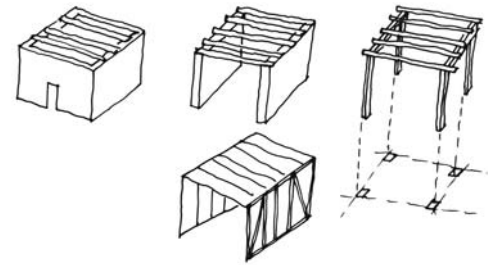


Fig. 6: View of the large hall transverse to the severely resolved wall structure consisting of columns and arches  
Great Mosque, Cordoba (E), 785–961 AD



Fig. 7: Aerial view  
Qarawiyyin Mosque, Fez (Morocco), 857–1613

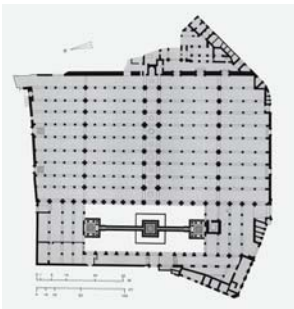
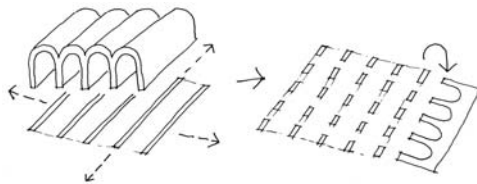


Fig. 8: Plan  
Qarawiyyin Mosque, Fez (Morocco), 857–1613

### Roofing over complex layouts

We shall now transfer these three fundamental principles to geometrically “adjusted” conglomerates, i.e. more or less regular arrangements of interior spaces, to check the structural effects of the various roofing options.

a) A succession of spaces between loadbearing walls initially roofed over with vaults multiplies the effect of the already strongly directional structure exponentially. The orientation of the interior spaces runs parallel with the walls. And in this direction the individual spaces may also be extended *ad infinitum*, while in the transverse direction a complete, new “vaulted unit” must be added every time. Of course, the distances between individual walls could vary, but this would not change the primary direction of the plan layout. In architectural, but also in structural



terms, the connections between these elongated chambers perpendicular to the walls are interesting. For here we can offer the most diverse interpretations, stretching from minimal openings right up to resolution of the wall structure into minimal members.

Fascinating here are the prayer halls of colonnade mosques, as in the Great Mosque in Cordoba (785–961), which was extended in various stages to create an overwhelming interior space with 600 columns. Or the prayer hall of the Qarawiyyin Mosque in Fez (857–1613). Like the majority of colonnade mosques, these two examples also

include flat timber ceilings between the walls. The roof construction consists of timber trusses and the pitched roofs emulate the wall structure below.

An early example of a barrel-vaulted building is the bathing house of the palace of Qusayr Amra (711 AD), which today stands in the middle of the Jordanian desert. The entrance hall is roofed over by three parallel barrel vaults supported on walls resolved almost completely into arches, creating a large, transverse room. Nevertheless, the longitudinal orientation of the barrel vaults determines the layout.

A modern variation of an extremely resolved wall structure was built by Louis I. Kahn at Fort Worth in Texas (1972). Here at the Kimbell Art Museum Kahn plays consciously with the dominance of the longitudinal vault form by placing the main direction of movement of visitors at 90 degrees to this. Arriving at the main entrance in the centre of the longitudinal facade, visitors are first channelled transverse to the structure and only then in the longitudinal direction of the exhibition areas. These latter are arranged with their principal dimensions transverse to the walls so that, once again, visitors have to move mainly across the structure.

b) Spaces beneath domes can also be assembled in modular form to produce complex internal layouts. If the intervening walls are resolved into columns, we achieve one or more large interior spaces. One characteristic feature of such interior spaces is the fact that the importance of the individual compartment is still apparent, or at least implied, because the dome has a strong centralising effect. Aldo von Eyck used this property in an ingenious way in his children’s home in Amsterdam (1955–60). Taking as his model an African souk (bazaar), he designed a honeycomb-like configuration whose compartments are

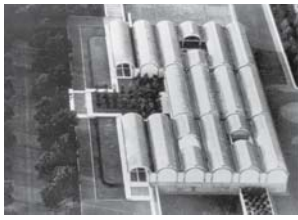


Fig. 9: Bathing house  
Palace of Qusayr Amra (Jordan), 711 AD

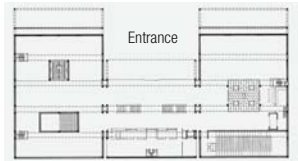


Fig. 10: Large entrance hall of bathing house  
Palace of Qusayr Amra (Jordan), 711 AD

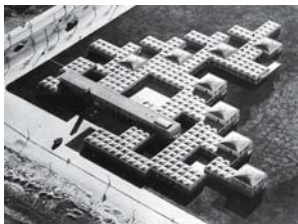




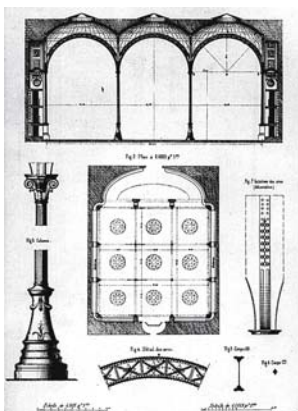
**Fig. 11: Barrel-vaulted wall structure**  
Louis I. Kahn, Kimbell Art Museum, Fort Worth (Texas, USA), 1972



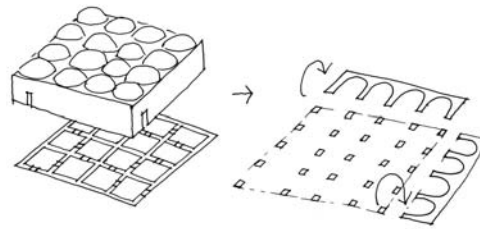
**Fig. 12: Plan**  
Louis I. Kahn, Kimbell Art Museum, Fort Worth (Texas, USA), 1972



**Fig. 13: Honeycomb-like, dome-vaulted structure**  
Aldo van Eyck: children's home, Amsterdam (NL), 1960



**Fig. 14: Drawing of reading room (right)**  
Plan, section and details (above)  
Henri Labrouste, reading room of Bibliothèque Nationale, Paris (F), 1854–75

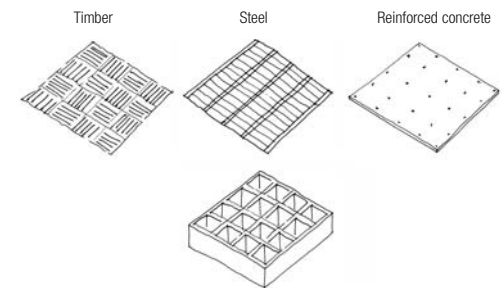


spanned by domes. To distinguish special spaces he used larger dimensions, but also individual or ring-shaped roof-lights. In addition, he exploited the flexibility of the additive method to expand the plan layout to meet the respective requirements exactly.

Henri Labrouste employed the same vaulting method for his reading room at the Bibliothèque Nationale in Paris (1854–75), but in this case to create a quasi-ideal, geometrically “neutral” place of contemplation. The nine domes forming the roof over this square room are supported on 16 cast iron columns which themselves tend to divide the floor area into nine squares. Each of the nine domes has a glazed crown to ensure even illumination of the reading room below.

c) Different configurations are possible with a flat roof of timber, steel or reinforced concrete over a multi-compartment, enclosed building, especially in terms of the resolution of the compartments into larger units. Owing to their relatively limited span, conventional timber joist floors without glued laminated timber beams are suitable for room conglomerates with essentially enclosed compartments, but immediately restrict the extent of the plan dimensions. To improve the transverse stiffness, it

is advisable to turn the joists through 90 degrees from room to room. On the other hand, plane constructions of steel enable extensive resolution of the structure because these can be designed to span over more than one compartment. And finally, the invention of the structure with flared column heads by Robert Maillart – which led to the reinforced concrete flat slab – enables the loadbearing elements to be reduced from walls and beams to a grid of columns.



The different structural and material-related “degrees of perforation” of such room conglomerates suggest different applications. For example, many plan layouts with several essentially enclosed spaces in succession are ideal for museums because in this way many wall developments are created which can then be used for displays. The illumination of these individual chambers is commonly by way of rooflights. And rooflights also guarantee even illumination in large interior areas created by resolving the walls into columns. Production buildings and exhibition halls are examples of this.

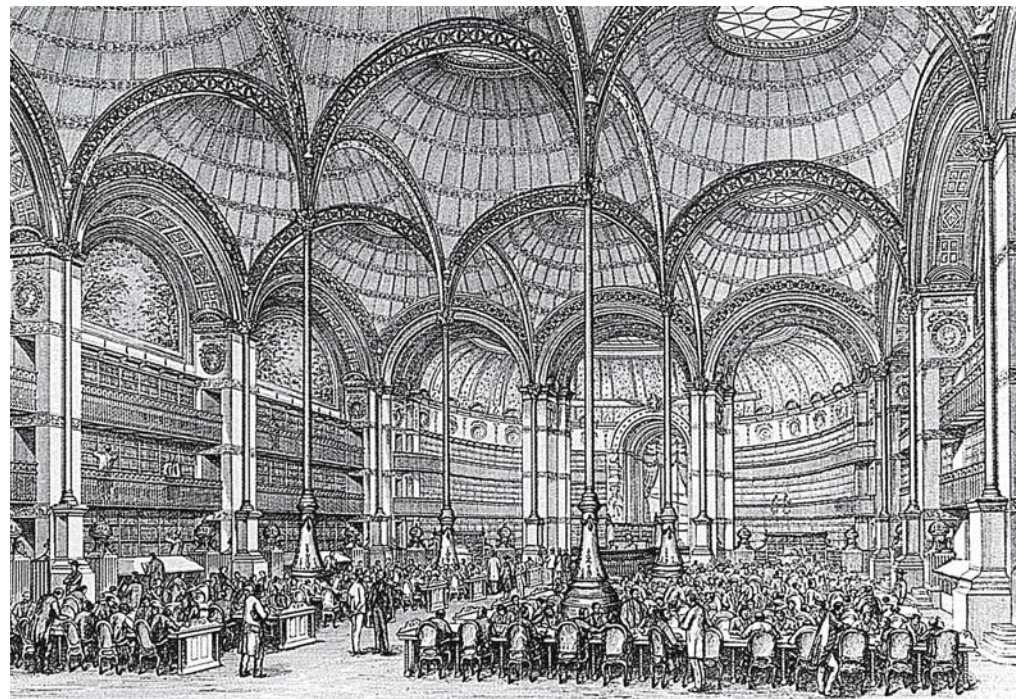


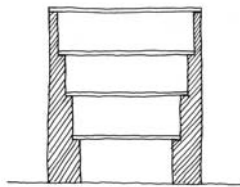


Fig. 15: The pockets for the ends of the scaffold beams are readily visible on the rear of the building.

Town Hall, Siena (I), 1288–1309, with the Torre della Mangia, 1338–48

### Vertical space development

Our starting point for presenting the development of vertical space is again our imaginary ancient compartment. If it is to be increased in height, the walls are simply raised. Mind you, this is easier said than done, for as we know such a measure leads – sooner or later – to constructional problems – strength, stability, material load-carrying capacities. In short, gravity makes its presence felt more and more the higher we build, and our efforts to overcome this determine our method of building. These conditions can be seen in simple buildings where the walls become thicker as they approach the base. Furthermore, above a certain height we shall require a scaffold. This could be called an independent, ephemeral structure because it is usually removed once the building is completed. However, a scaffold can leave behind tell-tale marks, as on the town hall in Siena (1288–1309), where on the rear of the building and on the tower (1338–48) the pockets for the ends of the scaffold members are still visible as an irregular pattern of holes in the surface of the brick walls.



Beyond a certain dimension increasing the height of the simple compartment opens up the option of adding a second floor. A multiple of our original height assumption of two to three metres is the module we shall use to divide the vertical space into horizontal units. In comparison to horizontal space development it would seem that the basic options in the vertical direction are more limited. It's all about stacking spaces, but in different ways: additive or divisive, exploiting the terrain or free-standing, as a repetitive layering or complex interlacing of the spaces.



Fig. 16: External view of two-storey ghorfas  
Ksar Ferich, fortified storehouse (Tunisia)

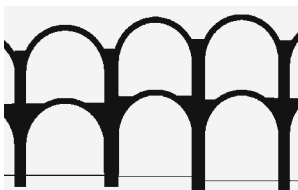
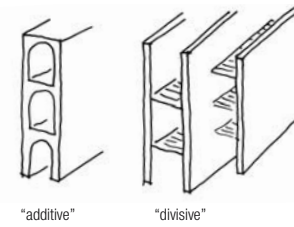


Fig. 17: Cross-section  
Ksar Ferich, fortified storehouse (Tunisia)

### The plan form as a projection of the storeys above

The simplest option for stacking spaces has proved to be the vertical layering of spaces with the same plan area. Expressed simply, in this method the plan shape of the ground floor is multiplied, with the loadbearing walls or columns continuing through all storeys. So in both the compartmentation principle and when using walls or columns the upper storeys are mapped on the ground floor. Whether the individual storeys are spanned by vaulting or plane elements is irrelevant for the stacking – the principle remains the same.

One example of a two-storey form of construction with vaulting is the Ksar Ferich fortified storehouse and



market in Tunisia, which consists of a succession of barrel-vaulted ghorfas (Arabic: space), each of which belongs to one family. The floors to the upper storey are not flat because the rounding of the underlying vaulting is not fully compensated for. A cross-section reveals the – from a modern viewpoint – elaborate form of construction. It is therefore not surprising that, when the situation and resources allow, flat floors are preferred, and are inserted between the loadbearing walls. In contrast to additive stacking this method could be described as divisive, with the joist floors providing stability as the walls are built. For starting from a certain height of wall the individual storeys, depending on utilisation requirements, are placed in the loadbearing structure. Continuous loadbearing walls over the full height of the building enable the interior spaces, even within a storey, to be arranged with different heights. In other words: in a vertical building with walls, the walls are the primary element and the floors the secondary element.

### Le plan libre

The reverse is true with the “column-and-slab system”, our second option for stacking several storeys, and the one which has been the most frequently used since the appearance of reinforced concrete floor slabs at the beginning of the 20th century. Dominant here are the horizontal floor slabs, while the spaces between the loadbearing columns can be arranged in practically any form. In conventional applications the regular column grid continues through the entire building and, together with a stiffening core or suitably positioned shear walls, ensures sufficient stability. As the number of storeys increases, so the loadbearing columns become more massive towards the base, something which is particularly noticeable in a high-rise building.

Le Corbusier's “Dom-ino” system (1914) is based on a combination of columns and slabs and was elaborated in his famous book *Five Points of Architecture* (1927); he developed this into a comprehensive programme for characterising his opinion of modern architecture. He was especially interested in the architectural freedom that this revolutionary “engineered” form of construction opened up: the “*plan libre*” and the “*façade libre*”.

In the late 1980s Rem Koolhaas developed an updated variation of a spatially complex, layered building based on



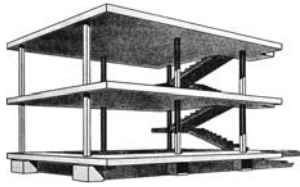


Fig. 18: Sketch of principle of column-and-slab system  
Le Corbusier: "Dom-ino" construction system, 1914

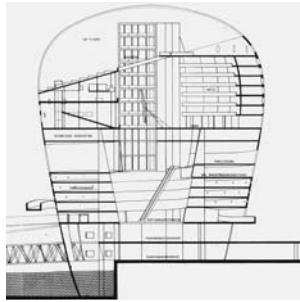


Fig. 19: Cross-section through competition project  
OMA, Rem Koolhaas: ferry terminal, Zeebrugge (B), 1989

the principle of separating structure (tectonics) and the formation of space, e.g. his competition designs for the Centre for Art and Media Technology in Karlsruhe (1989) and the ferry terminal at Zeebrugge (1989).

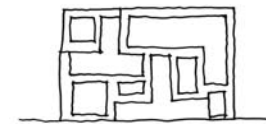
### The spatial plan

The third variation for vertical space development is also the most complex because in this case the spaces and storeys are no longer simply stacked one upon the other, but are interlaced vertically and horizontally. Adolf Loos is well-known for favouring the spatial plan. In contrast to the "Five Points" of Le Corbusier, however, the spatial plan is not a set of instructions which can be carried out and ticked off one by one, but instead the realisation of a space-oriented, complex design conception which must be re-appraised from project to project.

The aim of the spatial plan is to organise spaces with different plan sizes and different heights (split levels) – which can be treated as individual volumes – in such a way that they form a dense configuration of spaces. In the sense of a three-dimensional undertaking, the spatial plan is therefore certainly an economic approach, but in contrast to the idea of a "home for a minimal existence" it strives to achieve not the minimum necessary but rather the maximum possible in that the luxury of taller living spaces is balanced by lower ancillary spaces. This is also possible with multistorey walled structures. However, taken to the extreme the spatial plan has no loadbearing walls or columns that pass through all storeys. A continuous access core, which in all other variations provides a sort of "automatic" zoning, is also lacking here. In structural terms every compartment is an autonomous link within a complex chain which creates plenty of freedom but many more mutual dependencies. Consequently, the formation of structure and space is (apparently) artificial. To optimise

the fabric, the loadbearing structure can be simplified by designing some parts as non-loadbearing.

Müller House in (1930) by Adolf Loos is, in spatial terms, the most versatile implementation of his notion of the spatial plan. Despite its spatial complexity, the construction system is nevertheless astoundingly simple: the external brick walls are loadbearing; internally, there are no loadbearing walls, merely four reinforced concrete columns and downstand beams on which the joist floors are supported. In this way the columns subdivide the plan shape of the building into several rectangular zones. Therefore, the floors and roofs can be arranged at the necessary levels, corresponding to the requirements of the interior. These spaces, treated as autonomous volumes, are formed by cladding the framework – like infill panels – and are interconnected via precisely located



openings. Thus Loos established an extremely flexible but also inexpensive construction system with which he could realise his idea of the spatial plan in an optimum and surprisingly complex fashion.

Loos worked with a pragmatic hybrid construction in which the structure- and space-forming part are separated from each other – just like with the column-and-slab system. If the walls and slabs, however, are used systematically as coherent, loadbearing elements, which is now possible thanks to slab and plate designs in reinforced concrete (e.g. by Jürg Conzett), this leads to a merging of the two systems – and a return to the principle of solid construction.



Fig. 21: Plan of ground floor  
Adolf Loos: Müller House, Prague (CZ), 1930

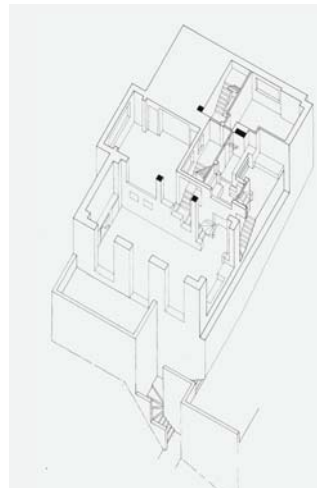


Fig. 22: Axonometric view showing main rooms and reinforced concrete columns (shaded black)  
Adolf Loos: Müller House, Prague (CZ), 1930



Fig. 20: View from living room into dining room at higher level  
Adolf Loos: Müller House, Prague (CZ), 1930

## Vertical loadbearing structures in solid construction

### Cross-section concepts

The principle of solid construction exploits the physical phenomenon of gravity:

- mass – self-weight
- interlocking of wall elements: the “zip” principle (bricks, stones, hybrid forms)
- jointing mortar between wall elements: the “glue” principle, increasing the frictional resistance (adhesion) between the wall elements
- stability and load-carrying capacity: the “wide base, narrow top” principle; objective: optimised use of materials

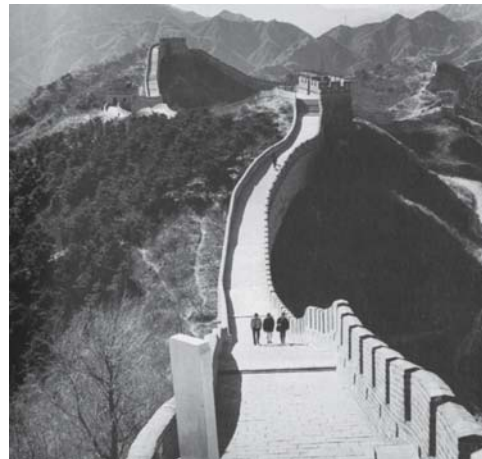


Fig. 27: Base of wall approx. 6 to 7 m wide, top of wall 4 to 6 m; masonry “external walls” with rubble infill  
Great Wall of China, c. 700–100 BC

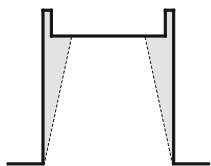


Fig. 23: Straight wall  
Excessive cross-section

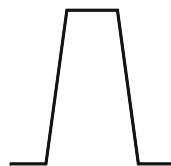


Fig. 24: Tapered wall  
Optimised cross-section

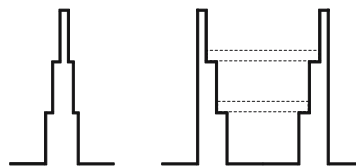


Fig. 25 Stepped wall  
e.g. providing support for beams/  
joists

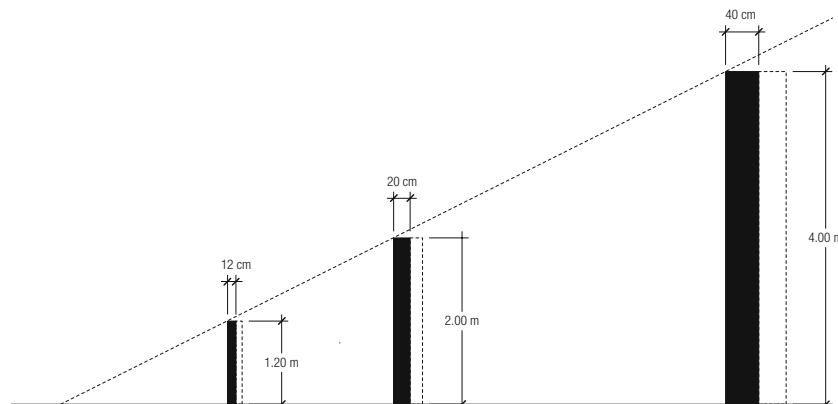


Fig. 26: Sizing after Rondelet (*Theoretical and Practical Treatise on the Art of Building*)  
Principally: the taller a free-standing wall, the wider its cross-section. Rule of the thumb for free-standing brick walls subject to wind loads only (average stability):  
 $b = 1/10 h$ ; built of rubble stones, factor approx. 1.75; ashlar stones, factor approx. 0.75

The form of the wall cross-section depends on various factors. The first critical factor is whether the wall is free-standing or whether it is braced or stiffened by other walls; this factor influences the width of the base. In any case, however, the cross-section will reduce with the height in order to optimise the use of materials because both the self-weight of the construction and the imposed loads resulting from the use of the construction gradually diminish further up the wall.

The variation in the cross-section can be either linear or stepped. It depends on the form of construction – with or without mortar, homogeneous or heterogeneous construction – and the building process (height of scaffold lifts), but is generally governed by utilisation considerations. For example, in a multistorey building it is sensible to step the cross-section at the level of the floors (and use the steps to support the floor beams/joists).

As the cost of labour in past decades has increased at a faster rate than the cost of materials, a building whose wall thickness decreases with the height is a rarity these days, with the exception of special structures such as retaining walls and dams. In the solid form of construction the larger wall loads of the lower storeys normally determine the size of the wall cross-section of all the upper storeys; this is especially true when we are stacking identical plan layouts one on top of the other.



Fig. 28: Multi-leaf wall with filling of loose, low-quality material (section)  
Trulli – traditional solid stone buildings of southern Italy, Sovero (I)

## Vertical loadbearing structures in solid construction

### Plan concepts

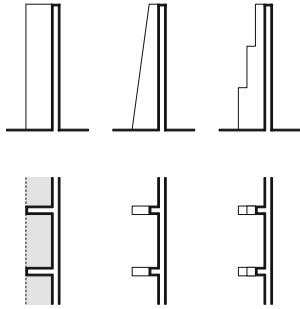


Fig. 29: Walls reinforced with ribs, sections (top) and plans (bottom) for increasing the inherent stability



Fig. 30: Cob construction with timber reinforcement (internal frame) with protective covering of cob (transverse ribs) Traditional construction of the Dogon people (Mali)

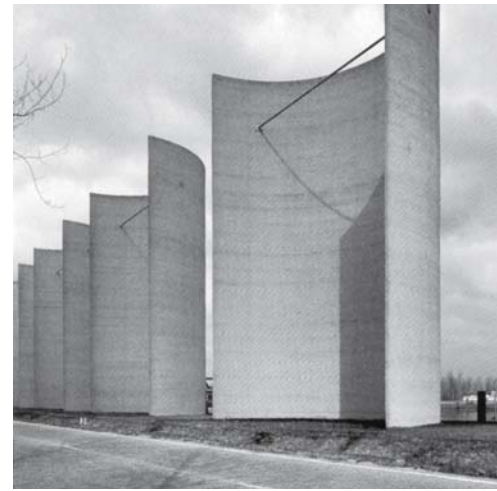


Fig. 34: Concrete half-cylinders 25 m high ( $d = 25$  cm); the tie bars at the top guarantee the stability of the form. Maarten Struijs: windbreak in Rotterdam Harbour (NL), 1985



Fig. 35: Wall forms for stability: L-shape, curve, cranked and winding forms

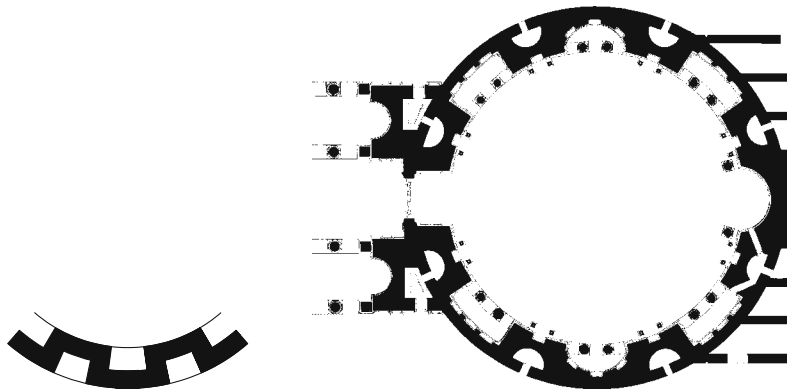


Fig. 31: Omission of material to form alcoves in circumferential wall, which creates a ribbed effect (left) Pantheon, Rome (I), 118–125 AD, loadbearing structure (right)

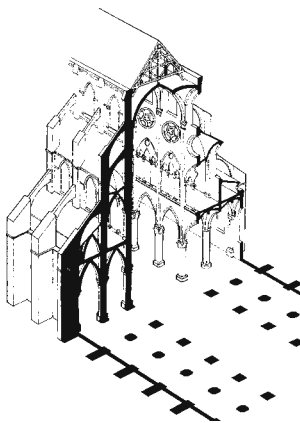


Fig. 32: Flying buttresses to transfer thrust, e.g. from vaulting Axonometric cut-away view of a Gothic cathedral

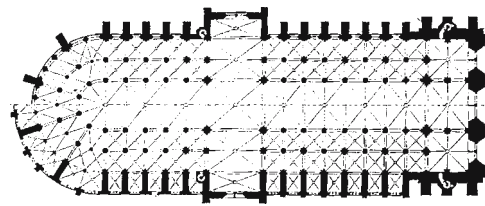


Fig. 33: The external loadbearing structure (flying buttresses) resulted in recesses which were later converted into chapels (along bottom edge of plan). Notre Dame Cathedral, Paris (F), begun in 1163

Looked at in terms of economy of material usage, various plan concepts are conceivable for stabilising the walls. For example, the stability and buckling resistance of the walls can be increased by including transverse ribs, which are either formed by adding the same or a different material, or by dividing, i.e. by omitting superfluous material, above all with very wide wall cross-sections (see fig. 31).

Changes of direction such as corners, cranks and curves also have a stabilising effect. Here, the height and length of the developed wall governs the number of changes of direction. The reduction in material can go so far as to make it essential, above a certain height, to include auxiliary structural members (see fig. 34).

## Vaulted loadbearing structures in solid construction

Compression structures: arches and barrel vaults



Fig. 36: Succession of stacked arches: sectional concept in order to omit superfluous material. The arch construction is sensible from an engineering and an economic viewpoint.

Pont du Gard, Roman aqueduct at Nîmes (F), 1st century AD



Fig. 39: Brickwork vaulting as permanent formwork to concrete above, with tie bars to accommodate thrust. The vaulted construction here has an architectural, space-forming value.

Le Corbusier: Jaoul houses, Paris (F), 1955

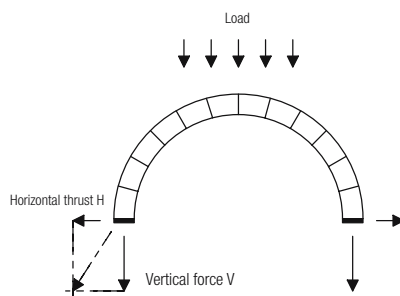


Fig. 37: Arch (as door or window lintel, for large spans)

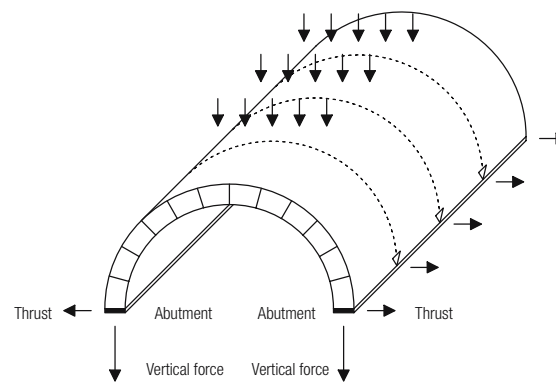


Fig. 40: Barrel vault

A compression structure allows the “disadvantage” of the weight of the construction to become an inherent advantage of the loadbearing structure.

The erection of arched and vaulted constructions follows identical criteria, also because a barrel vault is nothing

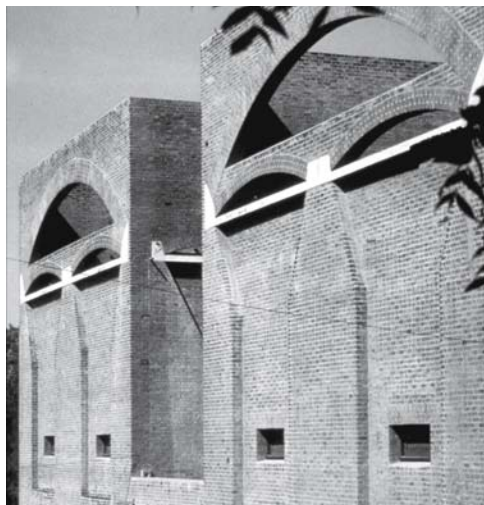


Fig. 38: The reinforced concrete tie accommodates the thrust and relieves the wall below.

Louis I. Kahn: Indian Institute of Management, Ahmedabad (India), 1962–74

other than an arch-shape curved surface, or rather a succession of parallel arches. The question of lateral stability is more significant with an arch because it is usually part of a wall subject to the aforementioned conditions (see “Vertical loadbearing structures”).

In the Louis I. Kahn example the double arches relieve the wall below and concentrate the forces at the supports. But the wall does not need to be strengthened as a result of this because the reinforced concrete tie beneath the arches takes the thrust so that all the loads are transferred vertically. The hopper-like reduction in thickness of the wall below the arches merely indicates those parts of the wall that carry practically no vertical loads.

The lateral thrust increases as the rise of the arch decreases. The shallow barrel-vault roofs of Le Corbusier’s Jaoul houses were therefore reinforced with steel tie bars. At the aqueduct in Nîmes, on the other hand, such tie bars were unnecessary because a succession of identical arches – irrespective of the rise – results in the coincidence of opposing identical horizontal forces and hence purely vertical loads. However, the end bays need special treatment.



## Vaulted loadbearing structures in solid construction

Compression structures: domes

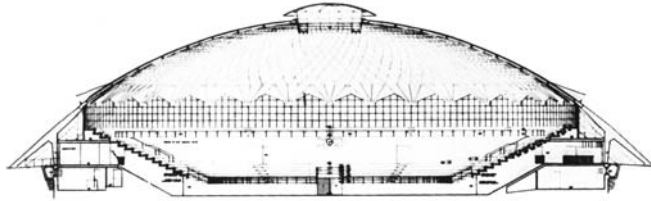


Fig. 41: The tension ring is below ground underneath the column foundations (abutments).  
Pier Luigi Nervi: Palazzetto dello Sport, Rome (I), 1957



Fig. 44: The dome is resolved into a ring of Y-shaped raking columns  
Pier Luigi Nervi: Palazzetto dello Sport, Rome (I), 1957

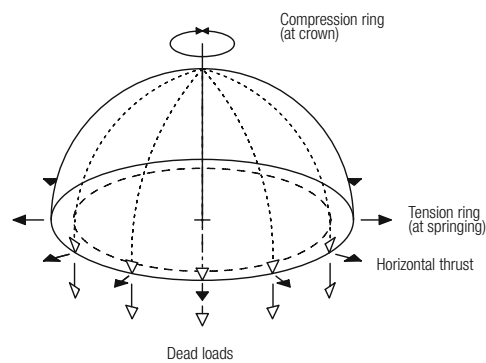


Fig. 42: Dome (body of revolution)

As with barrel vaults and arches, in domes we are always faced with the question: How is the thrust to be accommodated, reduced and taken down to the foundations?

At the Pantheon in Rome the designers employed various features to handle this problem. The weight of the dome decreases as it rises, which is achieved not only by reducing the cross-section but also by using lighter materials. The dimensions of the dome are such that the flow of forces starting from the crown remains within the cross-section of the dome. The extra wall height externally adds weight and hence allows the tensile forces to be accommodated in the wall. Likewise, a steel strap acting as a tension ring would also have been conceivable.

Pier Luigi Nervi's Palazzetto dello Sport makes use of a complex dome: the concrete shell is reinforced with folds and is resolved into Y-shaped raking columns, which accommodate the thrust by extending the dome and beneath the apex of the Y have a vertical column to transfer the forces vertically into the ground. In the ground there is a circumferential reinforced concrete tension ring. This allowed Nervi to create an interior space completely free from any intervening vertical loadbearing elements.

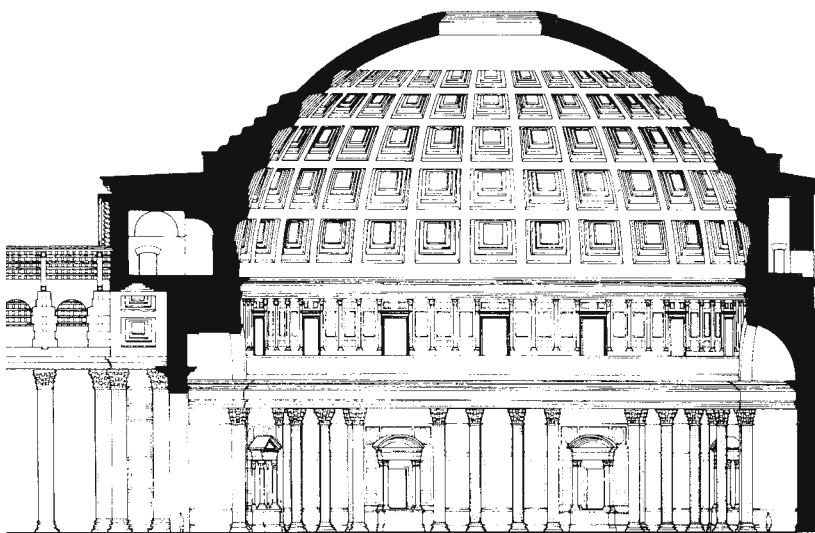


Fig. 43: Dome with voids to reduce weight and consumption of materials (omission of superfluous material). This creates a grid of stiffening loadbearing ribs. In addition, lighter materials were employed further up the dome. Pantheon, Rome (I), 118–125 AD

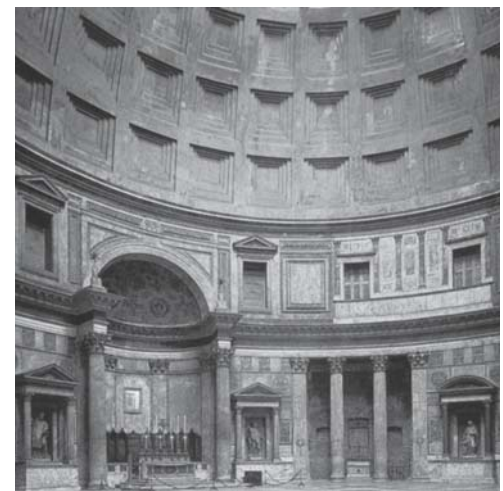


Fig. 45: An early example of construction with Roman concrete (*opus caementitium*). Pantheon, Rome (I), 118–125 AD

## Of heavy mass and apparent heaviness

Martin Tschanz

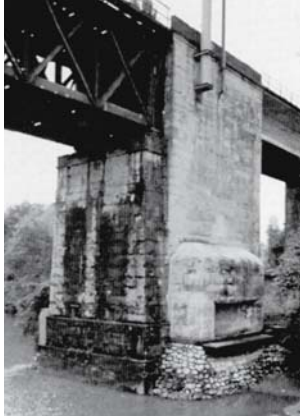


Fig. 46: Bridge over River Limmat, Zurich-Wipkingen. East pier

### Resistance

Mass is a fundamental property of material which expresses itself in the mutual attraction of bodies and in their inertias. The former results in the heavyweight, age-old problem of architecture, the latter allows mass to generate resistance. Both of these aspects are illustrated in the pier of the Wipkinger viaduct in Zurich. Its heaviness enables it to stand securely on the edge of the river bed, also resisting the highest floodwaters. However, the builders of this pier were not satisfied with this effective mass but instead emphasised this aspect with decorative additions: a not quite regular and relatively coarse yet careful cutting of the stones; a visual enlargement of the volume, which appears to extend far beyond the bridge supports (particularly when seen from a distance) and finally gently sloping sides, a stepped plinth and particularly coarse, almost rustic, masonry at the sides above the waterline. Furthermore, a carefully constructed, stocky arch indicates the loads to be overcome and, together with small openings at the sides, demonstrates that what the observer sees is perhaps not as massive as it appears at first sight. This vaulting was later fortified to form a bunker, which itself has recently been filled with concrete. A tumour-like protrusion of solid concrete should, with its inert mass, resist the impact of any projectiles. The rounded forms are only understandable as martial shows of strength because grenades would be deflected directly onto the structure they are trying to protect! They demonstrate the sculpted, moulded mass. The heaviness and inertia of the mass in the modest bridge pier are, on the one hand, necessary to carry out the tasks, and on the other, the themes of the design. In this way, its appearance conveys stability and obstinate resistance.

In architecture advocating a large mass, in terms of the primary functions, tends to be the exception. We usually think of retaining walls, dams, bunkers, avalanche protection and similar structures. In other words, structures which are generally the province of the engineer, who can

guarantee the desired results. But architects, for their part, can also convey and express the idea of the security and safety achieved.

### Massiveness

For most, this interest goes beyond the physical and, above all, formal properties of mass or the associated connotations. Massive material can be sculpted, and moulded. Its relative homogeneity and stability enable us to hollow it out or model it, so to speak. A massive wall, for example, invites us to make it thinner by creating local recesses, or to provide texture in the form of profiling. These possibilities are shown in an exemplary way by Mario Botta in his church in Mogno. His elliptical cylinder encloses a space that unites the non-directional basic geometric forms of square and circle with the directional forms of rectangle and ellipse. The architectural means to this end is the plastic formation of the mass of the walls. Recesses allow the square to become legible, additionally emphasised by the diagonal relationship established by the cylindrical column on the axis of the entrance; a continual reforming and thinning-out allows the rectangle on plan to transform gradually to an ellipse at the start of the glass roof, the ellipse itself terminating at the curving roof.

Of course, the idea of forming a space through plastic modelling of the mass of the walls is not new. Frequently, the external volume of a building does not obey the same laws as the design of the interior spaces – there is on the one hand the requirements of urban planning, on the other the utilisation conditions inside the building. This leads to an unavoidable conflict, particularly when functional or “scenic” aspects, rather than, for example, tectonics, determine the architectural approach, which correspondingly wishes to express these conditions. The mass of the walls is often a suitable place for dealing with this conflict. Baroque architecture, in particular, provides virtuoso examples of this. However, unlike in the case of the church in Mogno, the aspect of massive material forming the “grey area” between the spatial boundaries is usually of secondary importance. This is more often the place, besides the loadbearing structure, to embed the functions and all possible technical necessities. “Mass” in this sense is indeed precisely confined but its structure and composition less defined and vague. Whether the mass consists of voids or material, it is equivalent to the appearance of the material as a body, whose internal structure is hardly relevant, at least for everyday considerations.

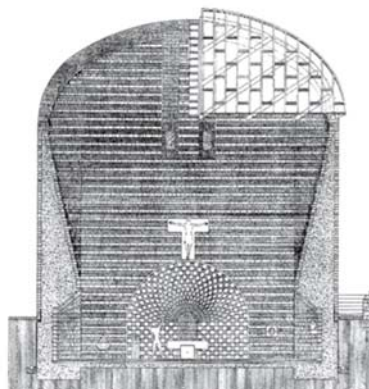
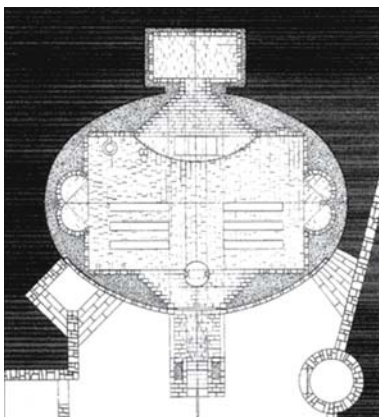


Fig. 47: Plan (above), section (right)  
Mario Botta: church in Mogno (CH), 1986–95



Fig. 48: Cassina de Camadra, Blenioital

We understand massiveness to express the (relative) homogeneity of the material of a body. It lends it interesting properties. Without immediately having to think of a “ruin”, it lets objects age with dignity, and gives them a claim to durability and longevity. In addition, it permits simple, direct design. Impressive in this sense are, for example, the Alpine buildings built entirely of stone (as can be found in southern Switzerland), where walls and roof are layered with the same gesture and are made from the same materials found more or less in the same place. Christian Kerez may well have had such buildings in mind when he designed the chapel at Oberrealta. His design concentrates fully on the essentials: a protective envelope in a trusted form, a door with threshold and a window form a structure which is both a man-made symbol of a house absolute and hence also a symbol of shelter and protection. This embodiment of familiarity and extreme abstraction, the simple, well-proportioned form and the solid materiality give this building a sacred dignity which does justice to the function and the location. This concentration would be inconceivable without a material “from one mould”, which enables such a construction without details.

#### Monoliths and “monoliths”

“One of the most prominent features of the bunker is that it is one of the few modern monolithic forms of architecture.

“While the majority of structures are bonded to the ground through their foundations, the bunker has none at all; its centre of gravity replaces them. This explains its ability to achieve a certain mobility...”

Thus Paul Virilio begins his chapter entitled “The Monolith” in *Bunker-Archäologie*<sup>1</sup>, providing in the same breath a convincing definition for architectural monoliths which remains very close to the term itself: a building like a stone that behaves like one as well. However, there are hardly any forms of architecture that do justice to the term used in this way. It is understandable that the term is also used for structures that only appear to be



Fig. 49: Rudolf Fontana, Christian Kerez: Oberrealta Chapel (CH), 1994–95

monoliths, even when they exhibit conventional loadbearing behaviour. Here is the definition of Rodolfo Machado and Rodolphe el-Khoury given in their catalogue *Monolithic Architecture*:<sup>2</sup> “We understand monolithic to signify monolith-like...” That is on the one hand in the sense of an exaggeration – although they call this form metaphorical – for not actually monolithic, and really extraordinarily homogeneous and solid objects; and on the other hand also in an “allegorical” sense as well “for buildings that do not have the physical material properties of the monolith, but that seem, ‘pretend’ or ‘act’ as though they do. In this allegorical mode the term monolithic has more to do with representational strategies than material qualities.”

Monoliths in this sense are compact architectural objects which appear to be hermetic and reveal nothing of their content. They are stand-alone, often remote structures, but may well form points of orientation in themselves. They are objects without scale which have an imposing, characteristic, individual form and, accordingly, are frequently personified, so to speak, and given a name. Their materials are often confined to a thin envelope which has nevertheless to demonstrate the appearance of a certain homogeneity. The design of the volume should suggest mass, which is mostly achieved by heightening a plastic deformation, preferably under the apparent influence of gravity or some other force.

The relationship between inside and outside is always problematic with such objects. The similarity with a massive body implies that the configuration of the interior, as a diffuse “mass”, is uninteresting. It plays no role in the building’s outward appearance, which in this sense is the only relevant aspect. This fact may well have contributed to the success of such hermetic architecture. In order to avoid reducing the design totally to the volume and the surface, the external form in the aforementioned sense has to be balanced by a similarly imposing interior. This might allow such forms to start resembling the bunkers described by Virilio once again, perhaps best shown by the designs for the National Library of France by OMA and the Tokyo Opera by Jean Nouvel. Nevertheless, the term



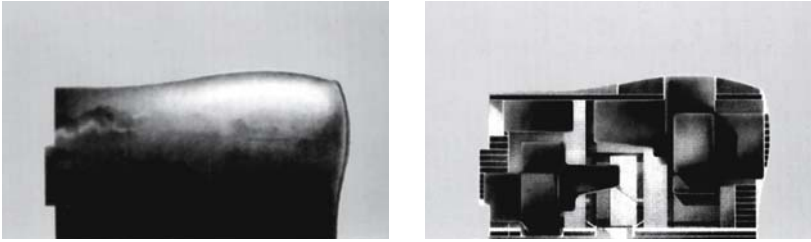


Fig. 50: Jean Nouvel: National Theatre project, Tokyo (J), 1986; view of model (left) and longitudinal section (right)



Fig. 51: Bunker in French Atlantic Wall "buried" in the sand (left), longitudinal section (right)

Katharina Bürgin, for instance, shows us a work which, even without a title, we recognise immediately as a house, owing to its simple, distinctive shape: the chalky, slightly blemished white surfaces, the somewhat worn edges, which are not quite straight, slightly bulging, and the sides, which lift the work clear of the underlying surface, causing it to float almost. The work manifests itself to us as solid, cast; we are reminded of plaster models. The "large" in the title "Large House" could relate to a scale, for at 48 cm long the object is not exactly large. If we dare to touch it, we are initially surprised by the silky softness and warmth of the surface, but then shocked: where is the weight? The work is massive yet frighteningly light in weight, moulded from papier mâché. So, what is a kilo now?<sup>3</sup>

"monolithic" does not seem to be at home in this figurative sense; the association with the enclosing sensual qualities of solid materials, which are not confined to viewing from remote distances and can hardly be limited, is too strong. It would seem to be more advisable to speak of hermetically or plastically formed solitary objects.

#### One kilo...

Not everything is what it appears to be. Even mass itself has many surprises in store. Schaffhausen-based artist

#### Notes

<sup>1</sup> Paul Virilio: *Bunker-Archäologie*, Munich, 1992 (1975), p. 37.

<sup>2</sup> Rodolfo Machado, Rodolphe el-Khoury: *Monolithic Architecture*, Munich, 1995 (catalogue of The Heinz Architectural Center, Pittsburg, 1995/96), pp. 15–16.

<sup>3</sup> This is how the text by Gertrud Ohling ends in the catalogue to the Manor-Kunstpreis 1994: *Katharina Bürgin, Objekte 1992 bis 1994*, Museum zu Allerheiligen, Schaffhausen 1995.

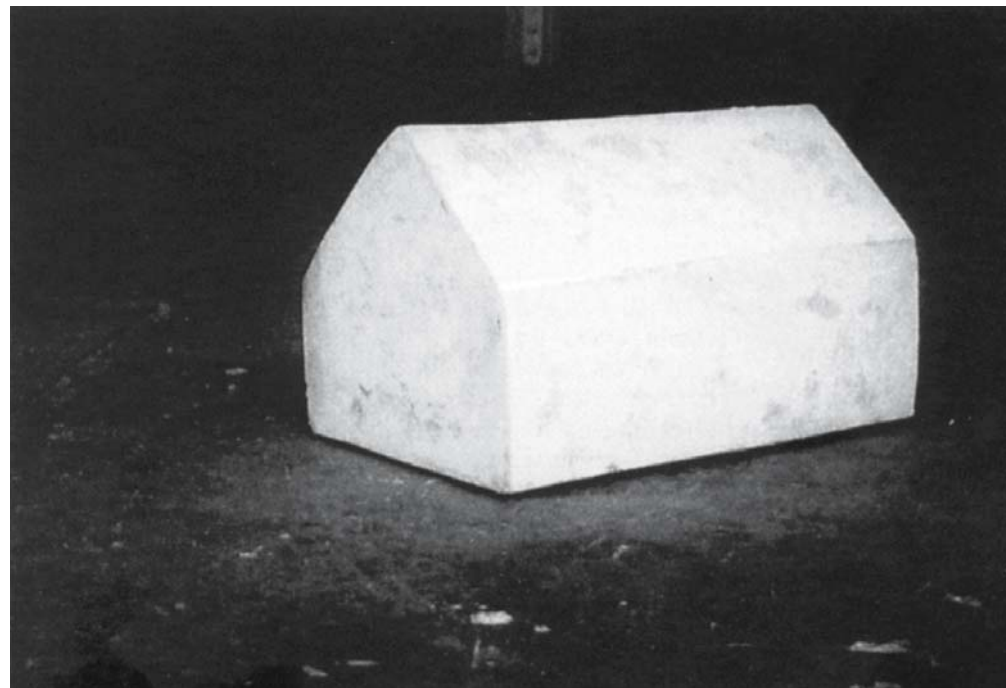


Fig. 52: Katharina Bürgin: "Large House" (1993)  
Paper, 28 x 48 x 26 cm



## Ksar Ferich

A fortified storehouse in southern Tunisia



**Fig. 53: Ksar Ferich**  
Development of the first courtyard



**Fig. 55: Ksar Ferich**  
The completely unbroken perimeter of the complex



**Fig. 54: Ksar Ferich**  
The ksar is located between an inhabited region and the Sahara desert



**Fig. 56: Inner courtyard**  
View towards the entrance



**Fig. 57: Inner courtyard**  
Complex at the centre of the ksar

### Ksour and ghorfas

The ksour (plural of ksar) of southern Tunisia are fortified living and storage complexes which were preferably built high up on the mountain plateaus or on steep mountain slopes. The centre of the complex is frequently a kalaa (a fortification). Grouped in the rocks below are the houses or caves and these are always accompanied by honeycomb-like, barrel-vaulted ghorfas (Arabic: ghorfa = space), often built in several storeys, one above the other. These serve mainly as storage rooms.

Isolated true ghorfa complexes built in the landscape are also called ksour. These (usually) rectangular complexes are surrounded by a continuous high wall interrupted by only one door, and convey a good defensive impression. They functioned primarily as collective warehouses for a clan while the nomadic tribesfolk were moving from pasture to pasture with their herds. Official guards, but also the sick and the old who could not travel with the herds, lived in and guarded the ksar. There were often hundreds of storerooms, some of which were up to

six storeys high, grouped like the honeycombs of a beehive around one or more internal courtyards.

Every family owned an appropriate number of these vaulted constructions – up to 10 metres deep, about three metres wide and about two metres high, secured with small doors of palm wood – to store their personal provisions. Rickety external stairs without balustrades, steps or timber joists cantilevering from the walls led to the upper entrances. Relief-type decoration in the internal plaster, e.g. in the shape of a hand or foot, ornamentation or lettering, is found in some places. A ksar was a place of trade and assembly in times of peace, a refuge in times of war. Thanks to the provisions stored within and a drawwell in the internal courtyard, a ksar could also survive longer sieges if necessary.

The large ghorfa complexes began to lose their significance as the nomads started to build permanent settlements. They decayed or had to be demolished to make way for new buildings (e.g. in Medenine, where more than 30 such ksour were razed to the ground). Many fortified storehouses have in the meantime decayed to such an extent that great care is needed when exploring them. Some are still used as storage rooms or stalls, others have been converted into simple accommodations for tourists. Occasionally, the visitor comes across well-maintained or restored complexes which, even today, are still occupied, or have been reoccupied, by local people.

Excerpt from: Dorothy Stannard, *Tunesien*, Berlin, 1992

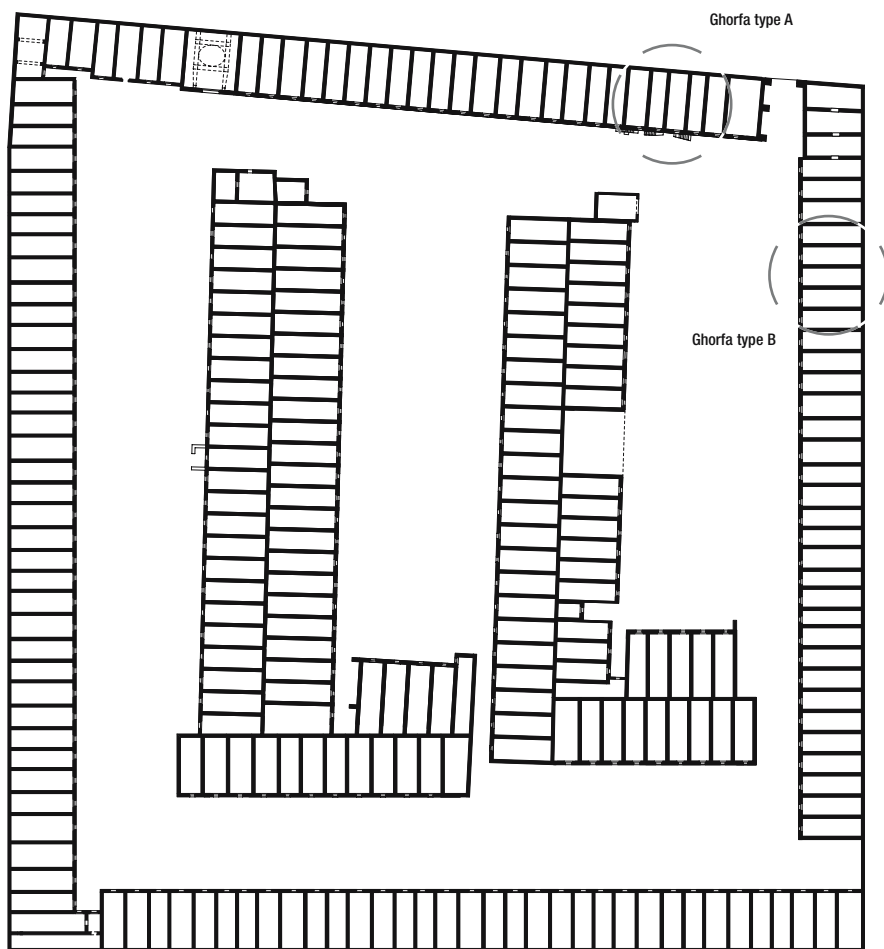


Fig. 58: Ksar Ferich  
Plan of ground floor, 1:1000

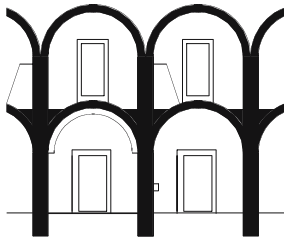


Fig. 59: Ghorfa type A  
Section, 1:200

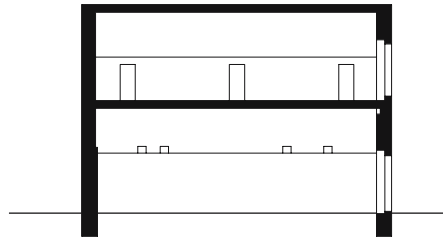


Fig. 61: Ghorfa type A  
Longitudinal section, 1:200

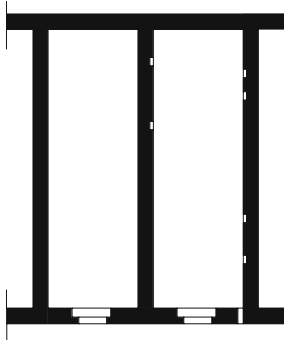


Fig. 60: Ghorfa type A  
Plan, 1:200



Fig. 62: Ghorfa type A  
Front facade



Fig. 63: Ghorfa type A  
Side facade



Fig. 64: Ghorfa  
Detail of partially rendered facade



Fig. 65: Ghorfa type B  
Front facade

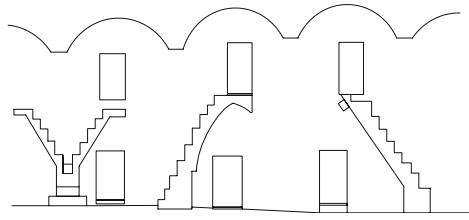


Fig. 68: Ghorfa type B  
Elevation, 1:200

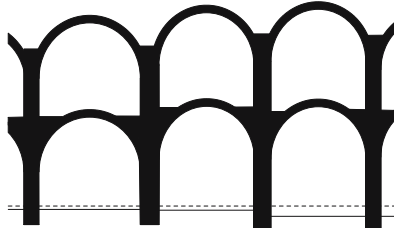


Fig. 69: Ghorfa type B  
Section, 1:200

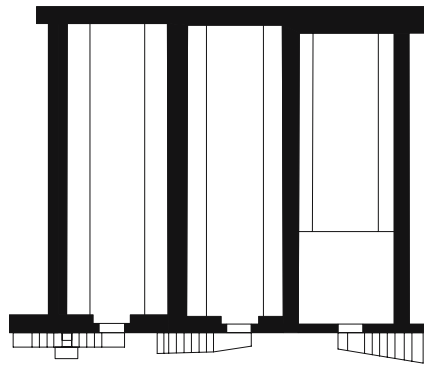


Fig. 70: Ghorfa type B  
Plan, 1:200



Fig. 66: Ghorfa  
Interior view, ground floor



Fig. 67: Ghorfa  
Interior view, upper floor, with vaulted floor



**How to make a ghorfa:**

Throughout the south of Tunisia grain was stored in small stone cells known as ghorfas. They were each about 2 m high and 6–10 m in length. More units were added as required both at either side and above, sometimes reaching up to 8 units in height. Eventually, the whole formed a courtyard, the blank outside walls deterring raiders. A skill you might just require – how to make a ghorfa:

1. Build two walls of rock and mud about 2 m apart and 1.5 m high.
2. Place vertically between the walls two straw grain baskets packed with earth. These must fit exactly between the walls to support them. Place a third straw grain basket of earth horizontally on top of the first two.
3. Over this place a previously manufactured plaited reed/straw mat to make an arch.
4. An arched roof of rocks held by a fine clay and gypsum mortar can then be gradually constructed, using the matting and grain baskets as support.
5. Construct a rear wall if necessary. Remove the supporting baskets and plaster the internal walls with lime and mud. Decorate if required with figures and handprints or fish to ward off the evil eye.
6. Construct a front wall with a wooden access door of palm.

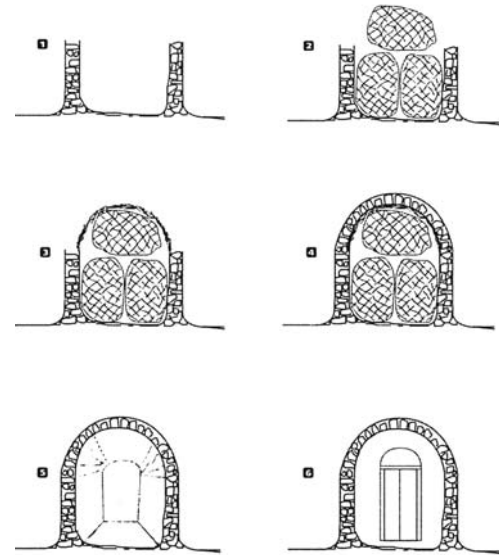


Fig. 71

Excerpt from: Anne & Keith McLachlan: *Tunisia Handbook*, Bath, 1997.

**Books on Tunisia:**

- Jellal Abdelkafi: *Tunesien: Geographie – Geschichte – Kultur – Politik*, Stuttgart, 1994.
- Myron Goldfinger: *Villages in the Sun*, New York, 1969.
- Derek Hill: *Islamic Architecture in North Africa*, London, 1976.
- Peter Andreas Kroehnert, Josef Schramm: *Tunesien, Land zwischen Sand und Meer*, Freilassing, 1969.
- Hans-Georg Roth, Anne Brakemeier: *Tunesien*, Breidenstein, 1995.
- Konrad Schliephake: *Tunesien: Geographie – Geschichte – Kultur – Religion – Staat ...*, Stuttgart, 1984.

## Sculpted architecture

### The Scottish tower house

Nik Biedermann, Andrea Deplazes



Fig. 72: Neidpath Castle, Peebles (Scotland, GB), 14th century

#### The fortified house

Typical of Scottish architecture is the tower house of the Middle Ages, a combination of castle and residence in a compact, vertically organised space. Early examples of this typically Scottish form were plain, the reflection of a poor land characterised by internal unrest and regional wars between rival clans. Constant rebuilding was unavoidable. As peace gradually gained the upper hand over the countryside, the external appearance of these tower houses became more decorative, picturesque, “romantic” – reflecting the needs of their owners at that time to express their prosperity. By contrast, the need for fortifications was gradually relegated to the background, transforming the keep into a fortified manor house. The topicality of these tower houses over a period of three centuries (13th to 16th century) led to hybrid forms characterised by regional influences. However, the original form always remains clearly recognisable in these numerous variations.

The core of this work is a study of the architecture of tower houses, not their chronological development and the other facets that occurred simultaneously. The selection that follows does not claim to be exhaustive but does allow an insight into their variety, the wealth of space in these tower houses and their specific idiosyncrasies.

#### Tower house versus castle

The Scottish tower house is surprising in that it is conceived as a free-standing solitary edifice. The entire defensive system corresponds to the “principle of the chestnut”: wooden, unprotected ancillary buildings grouped to form a courtyard like the prickly but soft shell; in the middle stands the tower house as the tough core, serving as the fortified residence and place of work of the Lord of the Manor, and the final, sole place of refuge. Depending on the topographical situation, the building was protected against enemies by simple palisade fences, walls or ditches. In certain situations suitable rocky hillsides – as at Smalholm Tower – or rocky escarpments – as at Neidpath Castle – replaced some of the elaborate defensive structures. The defensive strategy provided for



Fig. 73: Montebello Castle, Bellinzona (CH), 14th century

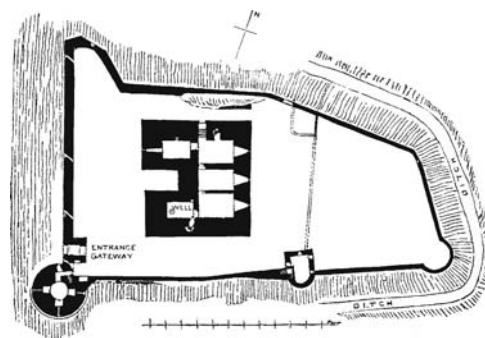


Fig. 74: Plan of whole complex  
Borthwick Castle, Midlothian (Scotland, GB), 15th century

retreating from the poorly fortified ancillary buildings to the tower, which could serve as living accommodation for a long period.

In contrast to the Scottish tower house, the castle complexes built during the same period on the European mainland employed the “onion principle”, i.e. the keep,

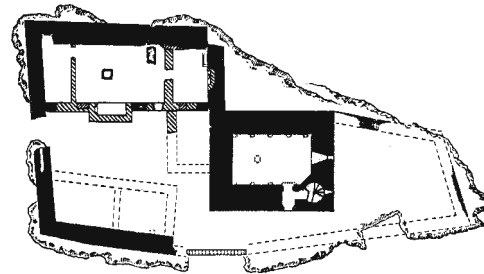


Fig. 75: Plan of whole complex  
Smalholm Tower, Roxburgh (Scotland, GB), 16th century

as the heart of the complex, was protected by several concentric defensive rings. Every ring was defended to the utmost because both residential and ancillary buildings extended over several rings. The keep, on the other hand, functioned purely as a (normally) unoccupied, defensive tower, from where the final defence of the complex could be organised. Compared to the Scottish tower house, designed for occupation at all times, the continental keep was, on plan, a much more compact affair. It is therefore also clear that the Scottish tower house was organised vertically and, as a result, had to evolve upwards. The defensive principle is founded on the difficulty of capturing storeys, i.e. the ease of being able to defend narrow spiral staircases.

#### Architectural observations

##### Mass and void

The Scottish tower houses, at least the early examples, stand today like eroded outcrops of rock on the hillsides. They appear to be straightforward, solid and elementary. Merely the few irregularly placed openings, which seem to follow no rules, give any hint of internal life behind the mass of stone. In fact, these immovable boulders are hollow inside and their enclosing walls are partly hollow, or even downright thin. The hidden chambers offer the occupants comfort and security against the harsh environment. To the outside world these structures appear to be highly fortified, while inside there is a surprising homeliness thanks to the numerous different spaces. The specific character of the Scottish tower houses is based on this apparent paradox – the combination of, in terms of space, most compact and most efficient form of residence and fortification.



Fig. 76: Eduardo Chillida: "Lurra" G-306, 1994

#### Eduardo Chillida

Like the sensation of heat can only be appreciated by first experiencing cold, architectural space can only be perceived through its physical boundaries. The mass of the building becomes, oddly enough, more compact once something lightweight is placed alongside, or is perforated by the inclusion of voids and compartment-like rooms.

This principle also characterises the work of the Spanish artist Eduardo Chillida, who calls himself an "architect of empty space". In his fine-grained clay sculptures in particular, the "Lurras", heaviness and massiveness are increased through implied or real spatial inclusions, through incisions which suggest a hollow interior. A rich dialogue between mass and space, heaviness and lightness ensues. As already intimated, the Scottish tower houses can also be interpreted in this way. They are excellent examples of how the fusing of opposites helps to reinforce the idiosyncrasies of the individual components.

#### Inside and outside

The external form of the Scottish tower house generally corresponds to the form of the main internal room, the hall. This coincidence of content and expression is not compulsory, as Baroque churches demonstrate, for instance. In a building external form and internal space often obey different masters. This is understandable in an urban context, with the chance to respond to external conditions prescribed by the location and locality. However, it is interesting to note that in the tower house there is a secretive "in between", a "massive" layer in which we find the most diverse spatial inclusions – "poché spaces": vertical access routes, small, sometimes interlinked chambers, but also mere protrusions of the main room to form window alcoves.

In the early types of tower house with external walls up to four metres thick and few rooms within this thickness, it would be better to speak of "masonry armour" than a conventional external wall. Their unusual, indeed incredible, size is the direct consequence of their task – to protect the living accommodation. The gradual transfer of compartments into this masonry appears to contradict this purpose at first sight. But this forms our "in between", a layer of individual rooms adjacent to the central hall, without weakening the masonry critically. Owing to the lack of openings the extent of this hollowing or thinning out cannot be seen from outside. The extra space gained in this way enables all secondary living functions to be transferred into the walls themselves. The central, main room is relieved and the size of this room can grow accordingly without having to increase the overall volume of the tower house. This achieves a clear separation between main room and ancillary rooms or – in the language of Louis I. Kahn – "servant" and "served" rooms. This division becomes clear when the resulting interior layout

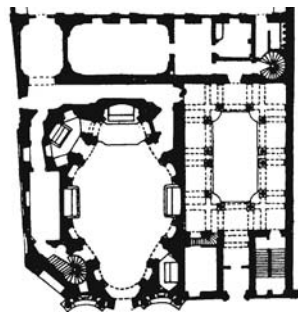


Fig. 77: Plan  
Francesco Borromini: San Carlo alle Quattro Fontane, Rome (I), 1634–67

is considered without the enclosing walls (like a "negative"). All the interior spaces, starting from the central, main room, appear to spread out or branch off like vectorised tentacles working to an inherent code.

#### Spatial inclusions

These ancillary rooms are actually the result of the main room "boring" into the surrounding walls and can be distinguished according to their specific functions. Looking at the alcoves of the main room raises the question of whether these should be regarded as part of the main room or as autonomous spaces. It is clear that all alcoves (for secluded seating, window seats or access to loopholes), with the exception of fireplaces, face outwards, i.e., face the light. Alcoves on the same level as the main room would seem to support the view that they are extensions of the main room. In contrast to these, alcoves reached via steps, and in some cases with fixed furnishings, could be classified as autonomous compartments. More obviously separate are the rooms concealed

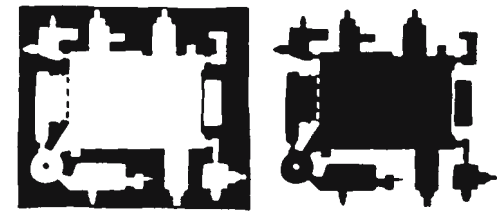


Fig. 78: "Positive" and "negative"  
Comlongan Castle, Dumfries (Scotland, GB), 15th century

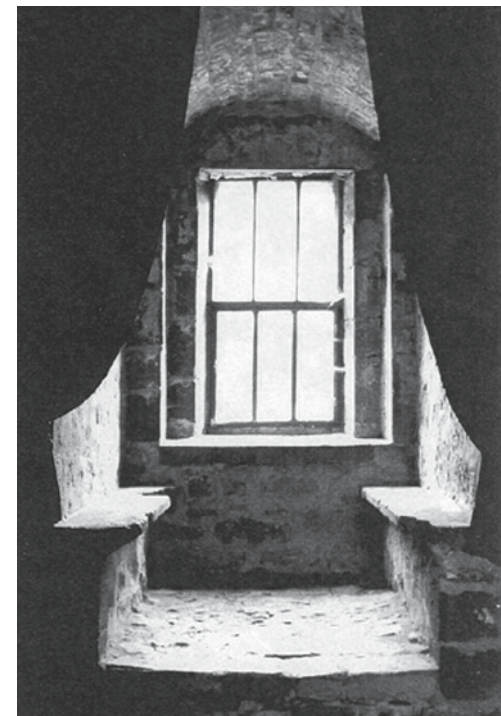


Fig. 79: Separate alcove with seating  
Comlongan Castle, Dumfries (Scotland, GB), 15th century

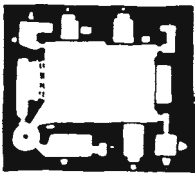


Fig. 80: Comlongan Castle

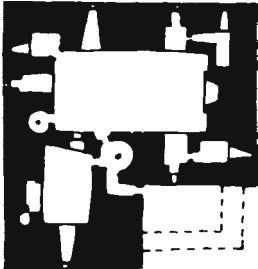


Fig. 81: Cessford Castle

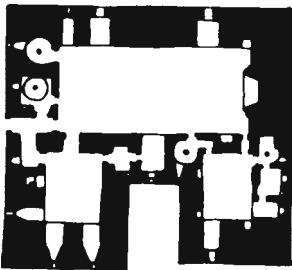


Fig. 82: Borthwick Castle

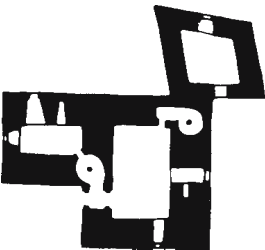


Fig. 83: Dundas Castle

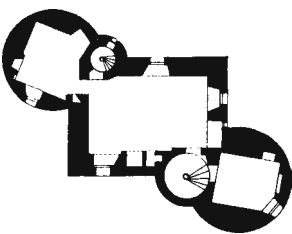


Fig. 84: Claypott Castle

small openings leading off the main room or, indeed, only via alcoves. These rooms adhere to the principle of compartmentation because the direct connection with the main room is clearly interrupted by the intervening walls.

#### Openings

Admitting light into the central hall enclosed on all sides imposes different conditions on the design and form of the light-admitting alcoves. Basically, we distinguish between two types of opening:

#### Openings with splayed reveals

Through reflection the narrow, deep openings with their splayed reveals distribute an even, diffuse light throughout the interior. They are not confined to a certain horizon and can therefore respond better to functional conditions. Ingenious location of these windows in the corners or end walls of the hall can promote strong sidelighting of the longitudinal wall, which thus becomes a bright "light wall" – as at Borthwick Castle. The orientation of the main room is thus underpinned not only by its geometry but also by the play of light and dark wall surfaces. With just a few, precisely located openings the lower part of the enclosed main room is illuminated surprisingly effectively, while the upper part forms a dark ceiling.

#### Alcoves

The daylighting effects are totally different in the deep seating alcoves. These alcoves tend to adhere primarily to the right-angled geometry of the plan disposition but prevent optimum scattering of the incoming daylight. They create high-contrast, exciting "inner" hall facades with light and shade, but above all with visual relationships with the surroundings so that the hall – contrary to the gloomy external expression – appears extraordinarily expansive, bright and homely. That is the real surprise that we never expected before studying the plans!

#### Vertical penetration and organisation

It is remarkable that the storey-by-storey plan concept is organised without corridors, apart from a few exceptions. The numerous spiral stairs can be regarded as a vertical corridor system (as Hermann Muthesius describes in his book *Das Englische Haus*), which, as a rule, are positioned in the corners of the external wall or at the junctions with later extensions. The characteristic aspect of this "corridor system" is that no staircase links all storeys. Generally, spiral stairs connect rooms over several storeys only in the case of unavoidable, functional requirements. The result is a complex three-dimensional labyrinth.

Confusion and error is the key to the vital defence of the tower house once an enemy has gained access. Narrow spiral stairs can be readily defended by switching the position of and direction of rotation of the flights,

the "eye of the needle" effect of narrow entrances and exits. Different connections between the floors at different places aggravate this loss of orientation. No additional measures are needed to create this confusion; it is integral to the access concept of the tower house. And the concealed escape routes should not be underestimated, allowing the unexpected and sudden retreat of the defenders in many ways.

#### Organisation

Access to the early tower houses was not at ground level like the later examples but rather via an external wooden stair or bridge at the side, which led directly onto the first floor. The typical vertical arrangement with one main room per floor meant that the ground floor contained the storage rooms and prison (= dungeon, later donjon), the first floor the main, prestigious hall for daily activities, the second floor the private rooms of the Lord, the third floor the rooms for the family and their servants, and above that the battlements.

#### Plan layout

The unique plan arrangements (rectangular, L-, C-, H- or Z-types) are essentially based on the progress in means of defence together with the growing needs for additional living areas on the individual floors. Starting with a basic form (a simple rectangle), tower houses were always extended according to the same pattern: the existing enclosing walls were extended so that a new, smaller "main room" with similar features was enclosed. It was usually the most important ancillary rooms that were transferred from the confines of the walls into this new space. However, the majority of tower houses did not obtain their plan layouts through changes to existing buildings; most were demolished and rebuilt over existing fragments according to the latest findings of contemporary ideas on defence and the current living and prestige needs of the owners.

#### Metamorphoses

As the defensive nature of the tower house diminished and the demands for a prestigious appearance grew, so the hitherto concealed alcoves and chambers within the outer walls started to become protrusions on the facade (as though they had become, so to speak, solid bodies trying to burst through the outermost skin and thus forcing this outwards). The originally massive, tranquil appearance of the fortified house became a sculpted body with projections. On the facade and in cross-section it can be seen that these projections preferably begin above the topmost floor with, in each case, coincident main rooms. A number of corner turrets and rooftop structures distinguish the silhouette of the building, which has become a three-dimensional crown. From now on the picturesque, romantic architecture of the later tower houses primarily followed



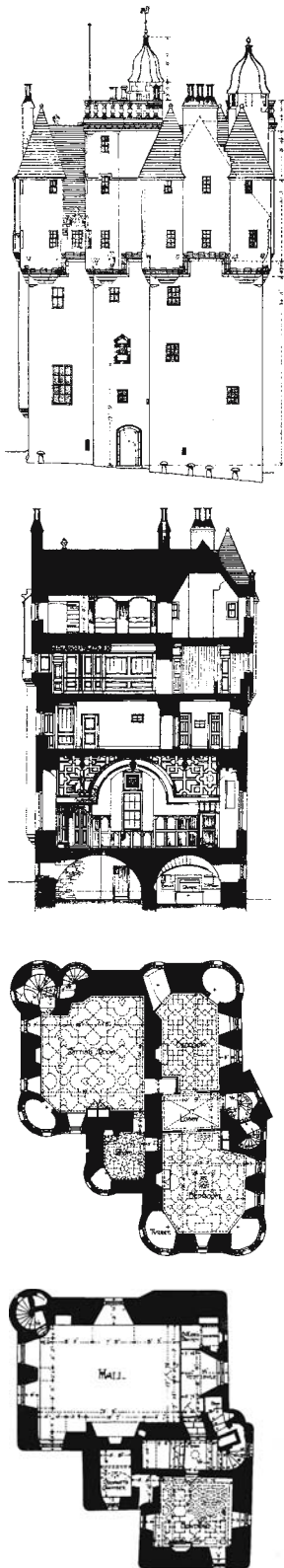


Fig. 85: From top to bottom: facade, section, 4th floor plan, 1st floor plan  
Craigievar Castle, Aberdeen (Scotland, GB), 17th century

the most diverse, fashion-oriented currents of each age and omitted any superfluous defensive measures.

Likewise, the internal organisation, as at Craigievar Castle, changed to a cluster-type conglomerate of spaces. The main rooms were now no longer directly one above the other but instead faced in different directions on the upper floors and were further subdivided and oriented according to specific needs. Larger ancillary rooms can be recognised on the facades as additional divisions of the L-shaped body of the tower. This vertical succession of spaces can be reached from the main rooms or may connect these directly. The multi-layer access and inter-connection principle of the interior layout, still organised storey by storey, continues via various stairs and their horizontal and vertical branching throughout the building. The originally distinct hierarchy of main and ancillary rooms had become compressed into a complex “room conglomerate”.

#### Morphological deductions

Thick walls enclose an elongated, rectangular space. The thickness of the walls and their geometry are not really identifiable, neither internally nor externally. However, the interior space is defined with geometric precision by the four corners.

It is only the openings in the walls that create a spatial reference with the outside world. At the same time, the enclosing walls are divided into individual L-shaped fragments. Their thickness becomes apparent through the depth of the reveals to the openings. As soon as the openings are positioned in the enclosing surfaces, the original geometry of the space becomes clearly recognisable.

However, if the openings are positioned at the internal corners and more or less match the height of the storey, so that some enclosing surfaces are extended by the reveals, the interior space begins to “drain away” and lose its distinct geometry. The fragments of wall will tend to become linear bodies; they lose their capacity to “enclose” the space.

If, in addition, the fragments of wall contain chambers, this has, on the one hand, little influence on the spatial properties of the main room; but on the other hand, from an economic viewpoint, this is a clear gain in floor area, which depends on the maximum possible reduction in the wall mass and hence the loadbearing structure. However, the true content of the apparently solid walls can be seen only by looking directly into these chambers. If the geometry and extent of these chambers varies (to suit functional requirements, for example), their influence on the interior and exterior spaces remains small. Only when the thinning of the walls containing rooms becomes quite extensive and these spaces start to “protrude” outwards do the various chambers become readily visible. In doing so,



Fig. 86: Schematic plan layouts  
Enclosed space – Openings – Openings in the corners

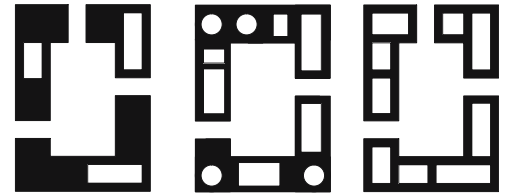


Fig. 87: Schematic plan layouts  
Individual chambers – Various room inclusions – Maximum use of wall thickness

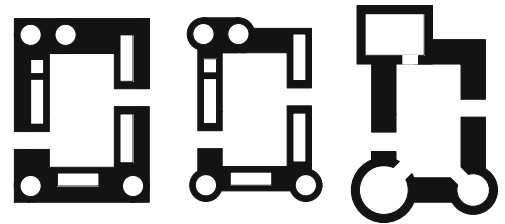


Fig. 88: Schematic plan layouts  
“True” basic plan – Extended basic plan – Sculpted surfaces

they create a sculpted surface through which the original angular basic shape is still recognisable.

If, however, the chambers enlarge at the corners and protrude beyond the confines of the wall to a much greater extent, we reach the point where the original basic shape is no longer recognisable. We arrive at a new composition which is determined by the large chambers within the walls and is hardly akin to the original basic shape. On the other hand, the geometry of the interior, the central hall, oddly enough remains unchanged, which underpins the validity of the hypothesis related here regarding the spatial growth of Scottish tower houses.

#### Serial expansion concept

It is unusual that, contrary to developments in England and on the European mainland, the vertical organisation of the tower houses continued to hold sway in Scotland for the “castles” of later times. Extra wings (called “jams”) were added to promote horizontal expansion, but no longer in the form of additional rooms but by interlocked “tower houses”. (We get this impression on the outside but in fact the interior layout of the wings employed simple principles of subdivision.) Glamis Castle is a good example of how the “L-type” nucleus was added in the 17th century to rise above the jams on both sides.

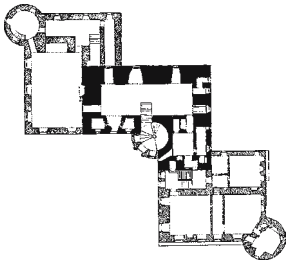


Fig. 89: Total complex, plan of 1st floor  
Glamis Castle, Tayside (Scotland, GB),  
13th–17th century

### Jams in the style of French palaces

Craigmillar Castle is a good example of another phenomenon which is not unusual in the history of tower houses with their surrounding complexes. The original tower house was of course incorporated into the sequence of spaces of the new complex. But in contrast to Glamis Castle the tower house was “ensnared”. Only a horizontal section reveals the thick external walls which have been woven into the overall complex.

### Adolf Loos and Scottish tower houses?

The plain expression and simple, cubic, vertical emphasis of the middle-class urban villas of Adolf Loos dating from the late 1920s awaken strong associations with Scottish tower houses. These urban villas are impressive on the one hand because of their elaborate space enclosures appropriately lined to suit their uses, and on the other because of the rich variety of spatially complex connections corresponding with classical notions of space hierarchies.

Tower houses are similar. Originally plain and unornamented on the outside, their interiors developed from functional to mazelike internal configurations with a rich hierarchy. In terms of interiors it is the most recent tower houses, e.g. Craigievar Castle, that are interesting in connection with Loos. Their spatial complexity and carefully detailed internal surfaces, especially the stucco to the vaulting over the main rooms and the wooden linings to the rooms protruding into the external walls, are comparable with the linings of diverse materials in the aforementioned urban villas.

### Spatial plan

Adolf Loos used this term to conceive a horizontal and vertical interlacing of spaces. It is tempting to search for this strategy in the tower houses. However, in reality in tower houses the notion of the spatial plan is confined to

the main room and its various alcoves plus the associated galleries, just the same.

Loos made a theme of the interdependency of variously sized and hence variously tall rooms. His argument was spatial economy, the need to compress them into a dense conglomerate with compact external dimensions. Precisely positioned openings link these spaces and define, through their size, the spatial and hierarchical coherence.

Despite the disparate organisation, we can detect a relationship between the tower house and a Loos villa. Both are devoid of corridors in the main spaces or storeys and both have several staircases which do not connect all storeys. In the tower house this is clearly explained by the need to confuse attackers, while in the Loos house it is the need to set the scene for the sequence of internal spaces. As in the tower house with its central, main room, the expansion of the main storey is legible in the Loos designs.

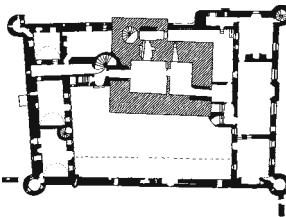


Fig. 90: Total complex, plan of ground floor  
Craigmillar Castle, Edinburgh (Scotland, GB),  
14th–16th century

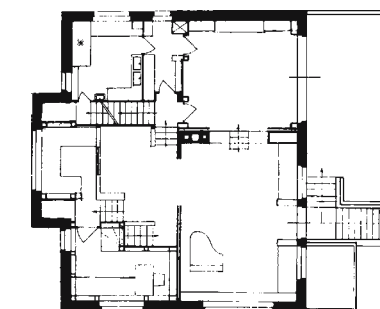
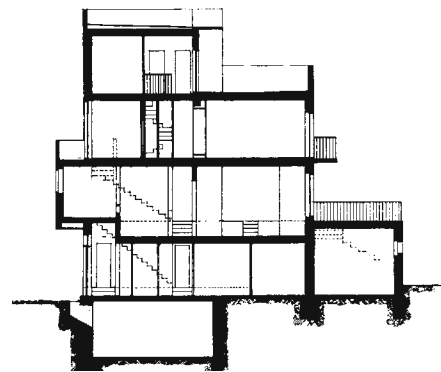


Fig. 92: Section, plan of 1st floor  
Adolf Loos: Möller House, Vienna (A), 1928

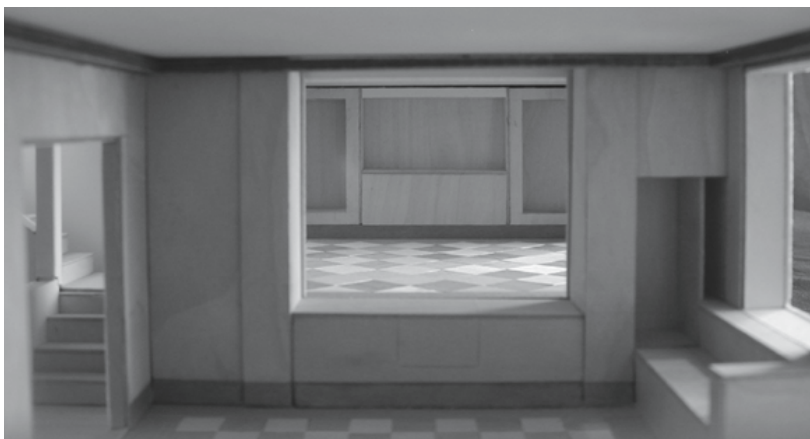


Fig. 91: Part of model of main floor, undergraduate study, ETH Zurich, 2002  
Adolf Loos: Möller House, Vienna (A), 1928

### Louis I. Kahn and Scottish tower houses?

*The Castellated and Domestic Architecture of Scotland*, a work in five volumes by David MacGibbon and Thomas Ross, is regarded as the standard work of reference on Scottish castles. We can assume that Kahn knew at least the first volume of this work very well indeed because he often refers to Comlongan Castle, which is well documented in this publication.

Kahn's obvious fascination with the simple, lucid, almost ancient classification of a space enclosed by a defensive wall which itself contains chambers (as is the case with the early Scottish tower houses) can be seen in his work. It was probably not the mass itself as such but rather the conception of spatial inclusions in the walls, which surround a main space and allow the creation of differentiated spatial references, that awakened Kahn's interest. The simple but readily comprehensible hierarchy of a main space and several clearly ordered peripheral ancillary spaces characterise Kahn's work.



Fig. 93: From top to bottom: facade, inner hall, peripheral study alcoves  
Louis I. Kahn: Phillips Exeter Library, Exeter (New Hampshire, USA), 1968–72

### Phillips Exeter library

Two rings of spaces surround a multistorey hall in the axially symmetrically organised square plan form of the Phillips Exeter Library (1968–72). The inner ring spans four access and service cores marking the corners. The outer ring seems to surround this without any regard for the regularity of the small-format facade arrangement. Only at the corners of the building do the rings meet.

The spatial compression, from the hall linking the floors to the bookshelves on each storey to the peripheral two-storey reading and study zones, responds accurately to the specific requirements of the brief. It is only the plasticity of the study alcoves – furniture-like enclosures inserted between the window reveals – that reinforce the periphery of the building.

The classification of main and, apparently, randomly created ancillary rooms in the defensive walls of tower houses is interpreted by Kahn in the form of a strict hierarchy of concentrically arranged and differently compacted layers of spaces.

Outside, the building appears as a "body", with thick brick walls whose piers taper towards the top. The resulting openings with their different heights divide the building up according to the classic rules of architecture into pedestal, column, and entablature. The chamfered corners of the building reveal the (sometimes) open internal spaces behind.

Although this measure does prevent the perception of continuity over the entire building, it enables the depth of the outer ring to be seen at the corners. The apparently compact mass of the building is softened by the fact that the outer walls do not meet at the corners. And this allows the richness of the interior to be made legible on the surface.

### Comparisons with current housebuilding: Japan

#### *Small house forms in Japan*

In the heavily populated districts of Japanese conurbations, which owing to the ever-present risk of earthquakes have spread out like carpets around their city centres, unique small-format houses are erected in the interstices. The enormous economic pressure and the resulting consequences for (exploitation of) the building regulations lead to plan sizes that cover virtually the full extent of the small plots of land. This calls for economic forms of construction, but far more critical is the need for a type of construction that can respond to these very confined spatial relationships. What these "mini-houses" appear to have in common is that their spatial response is basically introverted because externally there is hardly any space for the development of facades (Italian: *faccia* = face). The reasons for this can be found in the compact development structure with minimum clearances between buildings, or simply the placing of buildings in the gaps between existing buildings, which itself leaves little space for facades.

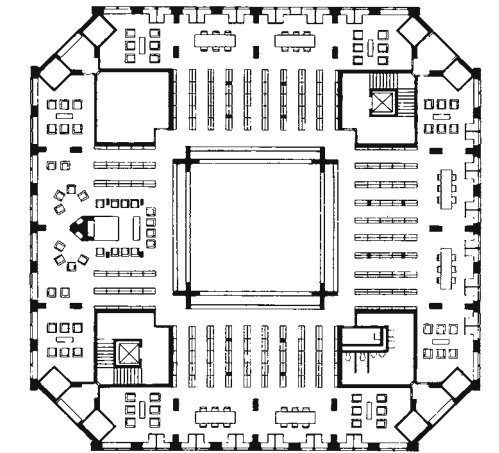
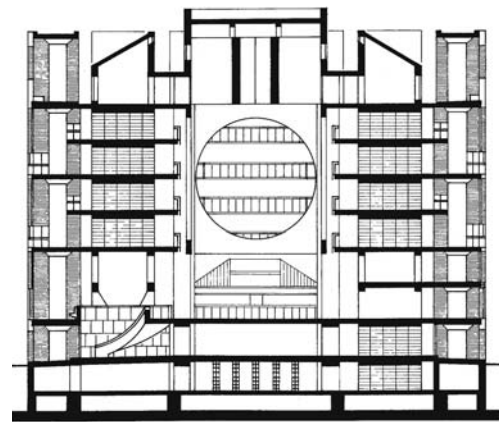


Fig. 94: Section, plan of 3rd floor  
Louis I. Kahn: Phillips Exeter Library, Exeter (New Hampshire, USA), 1968–72



Fig. 95: Hermetically sealed object with shafts apparently driven into the mass  
Jun Tamaki: Hakama House, Kyoto (J), 1998

### Hakama House

Jun Tamaki's Hakama House (1998) in Uji-shi, Kyoto, stands on a small road between an older house and the entrance to a plot of land further back from the road. Outwardly, the building responds autistically to its immediate surroundings. It is a monolithic object topped by a flat roof which is separated from the walls by a wide joint. The seemingly monolithic design of the building is reinforced by the few hopper-shaped openings driven deep into the apparent mass. Some of them are just on the limit of threatening to produce a visual weakening of the building. Even though the house does have a number of flush-fitted openings, their size and position turns them into minor players compared with the distinctive hoppers, and they do not relieve the monolithic effect. The principle of a central, two-storey hall and a surrounding ring of ancillary rooms is therefore sensible here because the reference to the outside world in this location is not really significant. Much more important is the "captured" main room, its lighting and its references to the neighbouring rooms.

### One-room house?

The central hall renders possible access without corridors, but also acts as a circulation area and a habitable room. From here, the upper floor is reached via the single staircase. This conflict is handled by providing curtains to close off the main room or leave it open to the alcoves behind. This enables the occupants to choose between the almost sacred "one room" with the curtains closed and the more far-reaching aspect that continues to the periphery and makes the interior appear larger than it really is.

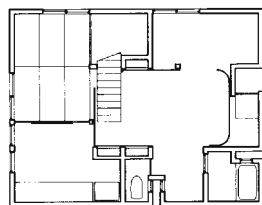
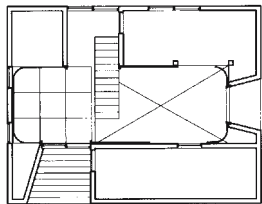
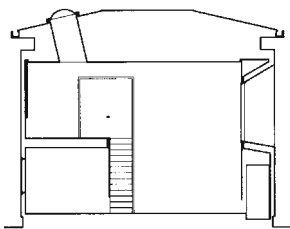


Fig. 96: Section, plans of ground and upper floors  
Jun Tamaki: Hakama House, Kyoto (J), 1998



Fig. 97: Extent of main room with curtains drawn back  
Jun Tamaki: Hakama House, Kyoto (J), 1998

### Diploma thesis, ETH Zurich

#### Twin tower houses

In her diploma thesis of 1999 Catherine Gay grappled with the notion of discrete, compact building using the high-rise structures at Kreuzplatz in Zurich as an example. There are two massive high-rise buildings among the trees of Arterpark, which stretches to the edge of the road at Kreuzplatz. The two structures are positioned in such a way that they divide up the park at this point and form an entrance from Kreuzplatz to the actual park itself. Their heavyweight appearance is due to the choice of solid sandstone facing masonry with its regular perforations; the set-back in the facade at the top reinforces the impression of height. The interior remains concealed behind this rigid lattice facade and is not revealed until we enter one of the towers.

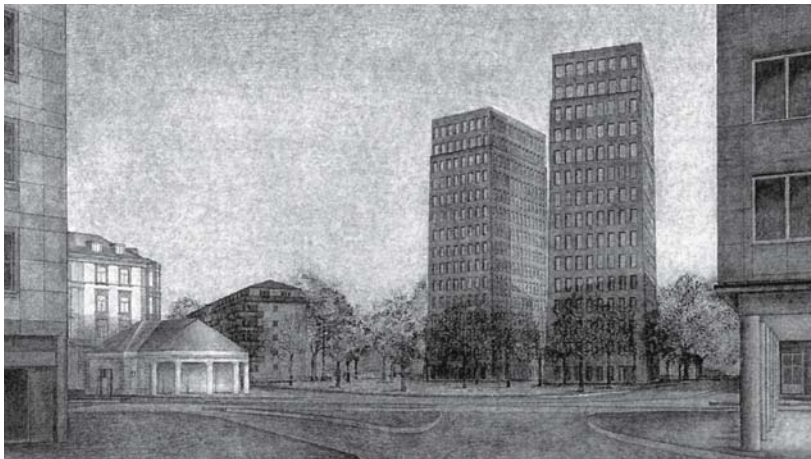
#### Loadbearing structure versus spatial structure

The loadbearing structure of each tower is in the form of a giant shaft within the outline of the tower itself ("tube-in-tube" principle), which results in a ring of interior spaces with different depths surrounding hall-type spaces. Solid concrete floors separate the rings horizontally storey by storey, while the hall in the central shaft of the tower can be divided at various heights with floors of lighter construction. The disposition of the plan layout more or less coincides with the loadbearing structure and can be modified by subdividing the ring spaces and changing the height of the central hall.



Fig. 98: Main room bounded by drawn curtains  
Jun Tamaki: Hakama House, Kyoto (J), 1998



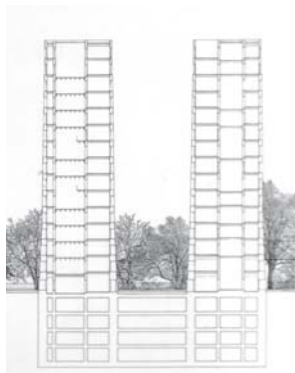


**Fig. 99: Catherine Gay: Towers at Kreuzplatz, Zurich**  
(diploma thesis, ETH Zurich), 1999

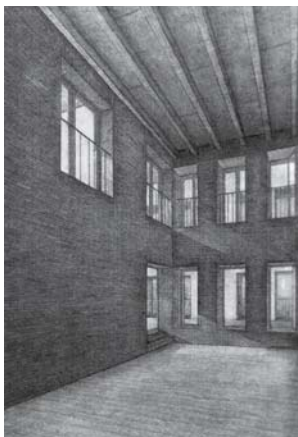
#### *Use options*

The standard floors have a “traditional” layout comprising two apartments, with the rooms, loggias, kitchens, and bathrooms, plus the continuous lift and stair shafts, grouped around the central halls. Owing to their size, the halls are primarily habitable rooms, a fact that is illustrated by the solid enclosing masonry piers and the floor of the hall placed at a slightly lower level. In contrast to the textile curtains of the Hakama House by Jun Tamaki, the space-defining boundaries are solid here and conspicuous by their immovableness. The hierarchy is created not only by location and size but also by the properties of the boundary elements.

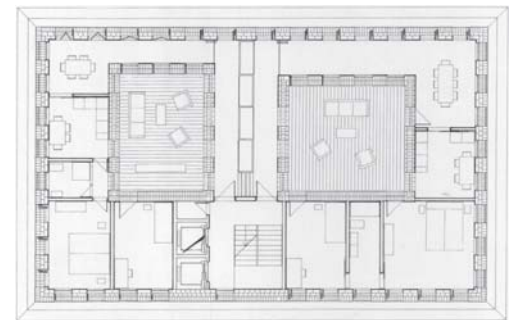
The principle of the vertical stacking of twin-wall rings around enclosed halls and non-loadbearing partitions enables a multitude of uses. For example, besides apartments, these high-rise blocks could accommodate offices, restaurants or nurseries without having to make any major changes to the loadbearing structure. The individual utilisation units can extend not only horizontally across the floors but also vertically through the halls, which helps to reinforce the spatial associations beyond a single storey.



**Fig. 100: Section through towers**  
Catherine Gay: Towers at Kreuzplatz, Zurich  
(diploma thesis, ETH Zurich), 1999



**Fig. 101: Inner hall lit from three sides**  
Catherine Gay: Towers at Kreuzplatz, Zurich  
(diploma thesis, ETH Zurich), 1999



**Fig. 102: Plan of standard floor**  
Catherine Gay: Towers at Kreuzplatz, Zurich  
(diploma thesis, ETH Zurich), 1999

## Provision of services during planning work

Project phase	Services	Fee in % to SIA 102	Drawings sent to... Which drawings?	Scale(s)	Accuracy of costs	Method of calculating costs	Dates, key parameters
<i>Strategic planning</i>	Formulation of needs, solution strategies	Reimbursement of costs					
<i>Preliminary study</i>	Definition of project, feasibility study, selection procedure	Reimbursement of costs	Client	Location drawings, block plans	1:10.000 1:5.000 1:2.000		
<i>Draft project</i>	Survey of potential options and rough estimate of costs	3 %	Client, authorities, some consultants	Site plans, cadastral surveys, plans, sections, elevations	1:1.000 1:500 1:200	Rough estimate	±25 % Building volume (m <sup>3</sup> ), Preliminary clarification, preliminary decisions
	Draft project and estimate of costs	6 % 9 %				Estimate	±20 % Building volume (m <sup>3</sup> ), components
<i>Building project</i>	Building project	13 %	Client, authorities, consultants, specialists	Site plans, cadastral surveys, plans, sections, elevations	1:1.000 1:500 1:100		
	Detailed studies	4 %		Detailed sections, detailed plans, detailed elevations	1:20 1:5 1:1		
	Estimate of costs	4 % 21 %				Estimate	±10 % Components, company prices
<i>Approval procedure</i>	Approval procedures	2.5 %	Client, authorities	Site plans, cadastral surveys, plans, sections, elevations	1:1.000 1:500 1:100		Application for building
<i>Tenders</i>	Tender drawings (provisional working drawings)	10 %	Client, consultants, contractor(s)	Plans, sections, elevations, earthworks, drainage	1:50		Approval for building
	Issuing and comparing tenders, award of contract(s)	8 % 18 %				Tender for work required	
<i>Detailed design</i>	Working drawings	15 %	Client, contractor(s)	Publication and detailed drawings, plans, sections, elevations, earthworks, drainage, details of kitchens and sanitary facilities	1:50 1:20 1:5 1:1		
	Contracts with manufacturers	1 % 16 %				Preparation of contract principles	Release for construction
<i>Construction</i>	Design supervision	6 %					Start on site
	Site supervision and cost control	23 % 29 %				Cost control by means of estimate(s)	
<i>Completion</i>	Commissioning	1 %					
	As-built documentation	1 %	Client, authorities	As-built drawings, drawings for publication	1:500, 1:200, 1:100 as required		
	Management of guarantee work	1.5 %					
	Final invoice	1 % 4.5 %				Final invoice	
<i>Management</i>	Operation, maintenance	Reimbursement of costs					

## Notes

The services listed here are taken from *Swiss standard SIA 102*, 2003 edition (Regulations Governing Architects' Services and Fees). In Germany the *HOAI*, 1991 edition, (Scale of Fees for Architects and Engineers) applies similarly.

## The sequence of building operations

<b>Preliminary work</b>	BKP 1	<ul style="list-style-type: none"> <li>– Soil surveys</li> <li>– Clearance, preparation of terrain</li> <li>– Setting up common site facilities</li> <li>– Earthworks</li> </ul>
<b>Structural shell 1</b>	BKP 2	<ul style="list-style-type: none"> <li>– Duties of site manager</li> <li>  scaffolding</li> <li>  drainage to buildings</li> <li>  concrete, reinforced concrete work</li> <li>  masonry work</li> <li>– Erection of concrete/steel/timber structures</li> </ul>
<b>Structural shell 2</b>	BKP 2	<ul style="list-style-type: none"> <li>– Windows, external doors</li> <li>– Flashings</li> <li>– Roofing work</li> <li>– Special seals and insulation</li> <li>– Rendering</li> <li>– Treatment of external surfaces</li> <li>– Sunshades, external finishing work</li> </ul>
<b>Media/infrastructure</b>	BKP 2	<ul style="list-style-type: none"> <li>– Electrical installations</li> <li>– Heating, ventilation, air conditioning</li> <li>– Sanitary facilities</li> <li>– Transport installations (lifts)</li> </ul>
<b>Fitting-out 1</b>	BKP 2	<ul style="list-style-type: none"> <li>– Plastering</li> <li>– Metalwork</li> <li>– Joinery</li> </ul>
<b>Fitting-out 2</b>	BKP 2	<ul style="list-style-type: none"> <li>– Floor finishes</li> <li>– Wall finishes</li> <li>– Ceilings</li> <li>– Treatment of internal surfaces</li> <li>– Drying out</li> <li>– Cleaning</li> </ul>
<b>External works</b>	BKP 4	<ul style="list-style-type: none"> <li>– Landscaping</li> <li>– Structural and fitting-out works</li> <li>  drainage to external facilities</li> <li>  retaining walls</li> <li>  roads and hardstandings</li> <li>– Gardens</li> <li>  planting</li> <li>  fences</li> <li>  equipment, appliances</li> </ul>

### Notes

The above extract shows the stages of work more or less corresponding to the sequence on the building site. Of course, the individual steps do not run strictly chronologically but are often carried out simultaneously. Several operations often have to be performed at different times in order to complete certain stages of the work.

This list corresponds to the breakdown into various operations according to the Building Costs Plan (BKP) of the Swiss Central Office for Building Rationalisation (CRB).

The following standards apply similarly:  
 in Germany DIN 276 "Building costs"  
 in Austria ÖNORM B 1801-1 "Building costs – cost breakdown".

## Compartmentation

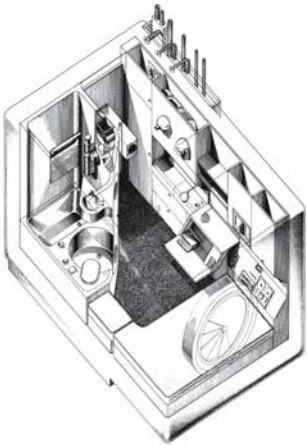


Fig. 103: Axonometric cut-away view of one capsule

Kisho Kurokawa: Nakagin Capsule Tower, Tokyo (Japan), 1972

### Kisho Kurokawa: Nakagin Capsule Tower

The Capsule Tower by Kisho Kurokawa is an assembly of 144 identical units stacked around two stair towers. The prefabricated units correspond to the dimensions of standard freight containers and contain a bathroom, kitchenette and bed.

The arrangement of the building is an expression of the design and construction principles, which are essentially congruent. The external form is not rudimentary but rather a product – as a variation on the stacking principle; the different orientation of the units is also noticeable.



Fig. 106: External view; the taller staircase tower is clearly visible.  
Kisho Kurokawa: Nakagin Capsule Tower, Tokyo (Japan), 1972

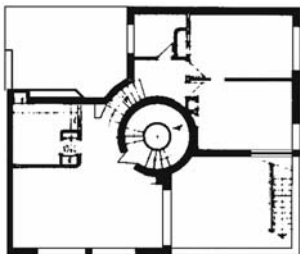


Fig. 104: Plan of 1st floor, on the right the terrace above the studio

Rob Mallet-Stevens: Martel Villa, Paris (F), 1926–27



Fig. 105: External view with studio in foreground and exposed staircase core

Rob Mallet-Stevens: Martel Villa, Paris (F), 1926–27

### Rob Mallet-Stevens: Martel Villa

The additive and the divisive forms of interior design can be seen in this building. The plan is based on a rectangle with a central circular stair tower linking all floors. The rooms are attached to this central spine like individual compartments, the number of which diminishes as we go higher up the building, and this leads to the creation of rooftop terraces.

The unifying render finish, which deliberately suppresses the construction joints, and the positioning of the openings are the manifestation of a sculptural approach to the design of the envelope. Accordingly, not only is the overall form a product of the internal spatial composition; it has an effect on this as well.



## Box frame construction

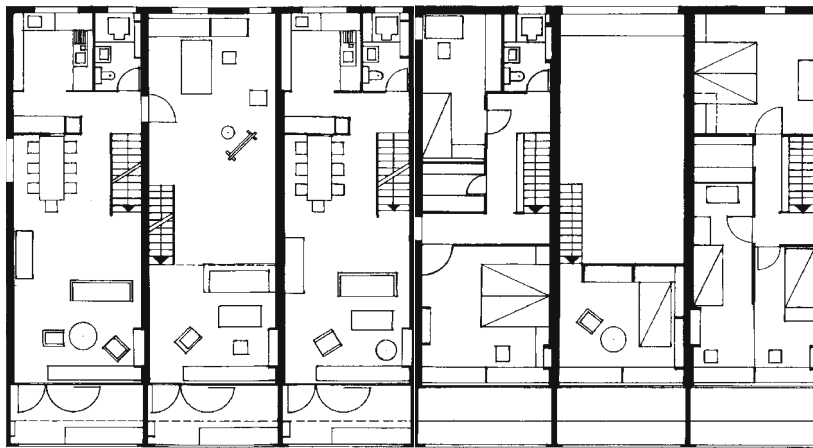


Fig. 107: Shear walls form the party walls between the maisonettes (left: main floor; right: upper floor)  
Atelier 5: Flamatt 1 residential development, Bern (CH), 1957–58



Fig. 109: The south facade reflects the shear wall structure.  
Atelier 5: Flamatt 1 residential development, Bern (CH), 1957–58

## Atelier 5: Flamatt 1 residential development

The apartment block shown here, designed by the Atelier 5 team, illustrates a typical use of parallel shear walls (or cross walls). They separate the individual apartments and on the standard floor determine the dimensions of the living room. The south facade reflects this loadbearing structure, which limits the openings on all sides (structural opening). The inclusion of loggias further emphasises the principle of the box frame construction.

The shear walls and the floors form the primary structure and are built of in situ concrete, while the partitions within the apartments consist of storey-high, precast concrete elements.

## El-Azhar Mosque in Cairo

The prayer halls of the Islamic world are the earliest examples of large open-plan interior spaces. They are based on an orthogonal column grid square – and hence unidirectional – in the case of the El-Azhar Mosque.

Nevertheless, the linear arches do lend the interior a certain directional quality which, however, is in turn weakened again by the transverse beams (for lateral stability), which seem to introduce an intermediate level. In terms of the loadbearing structure this is a classical box frame with parallel longitudinal walls and floor bays spanning the space below. However, the shear walls have been dissolved to the barest essential as columns and arches thus giving the impression of a wide open space.

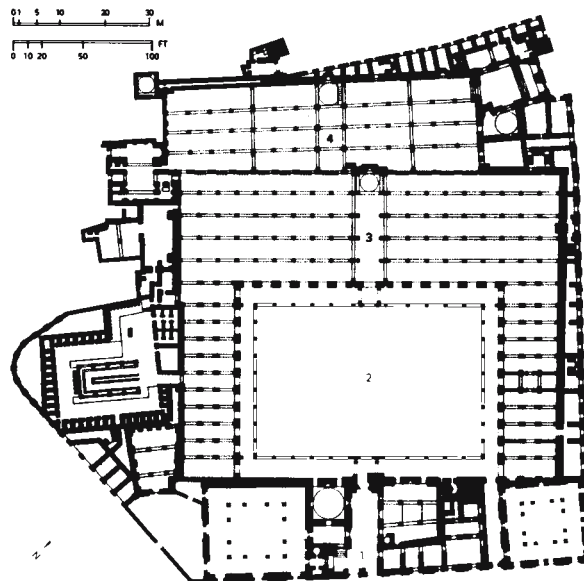


Fig. 108: On plan the walls resolved into arches are the dominant feature...  
El-Azhar Mosque, Cairo (Egypt), c. 970

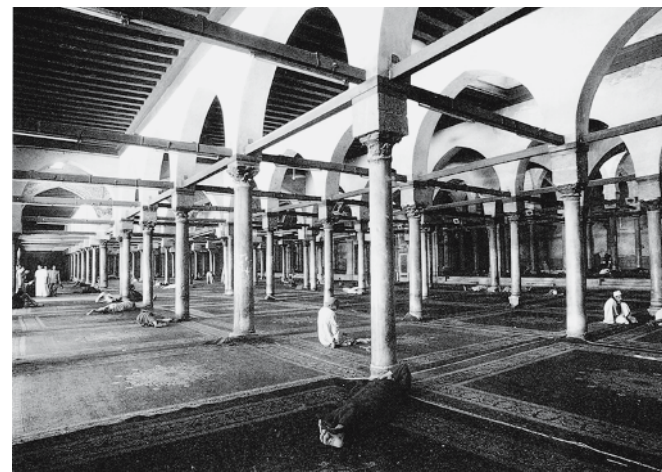


Fig. 110: ...while the prayer hall appears to be less directional owing to the transverse beams.  
El-Azhar Mosque, Cairo (Egypt), c. 970

## Frame construction



Fig. 111: The steel structure is a visible form criterion ("lattice structure").  
Craig Ellwood: Smith House, Los Angeles (USA), 1957–58

### Craig Ellwood: Smith House

This private house is based on a steel frame without any hierarchy in the structural assembly. Although the columns and beams are of different sizes, they appear to be of equal value. Only the diagonal bracing is quite obviously smaller.

A comparatively lightweight construction without expensive earthworks and foundations has been achieved as the steel frame evens out the topographical situation. Horizontal and vertical infill panels are fitted between the modular loadbearing structural members to form the individual rooms.

### Fritz Haller: canton school, Baden

A square column grid forms the starting point for this steel frame designed by Fritz Haller, which develops identically in both directions on plan. As the photograph shows, the columns are not erected storey by storey but are instead continuous over several storeys. The horizontal beams are seated on cleats on the columns before being bolted into place.



Fig. 113: Steel frame with beams at the same level, floor bays as subsystem  
Fritz Haller: canton school, Baden (CH), 1962–64

The floor bays are formed by a subsystem spanning between and at the same level as the beams. The lattice floor members save weight and also enable easier horizontal routing of services (heating, waste, etc.).

### Artaria & Schmidt: Schaeffer House

During construction, a clear distinction between primary and secondary loadbearing structures could be seen in the steel frame in this example. There are the longitudinal direction yokelike frames, consisting of two circular columns joined by an I-beam; steel angles as erection aids join the frames in the sense of a secondary loadbearing structure.

However, the form of construction cannot be deduced from the finished building with its enclosing rendered masonry. The structural steelwork is a means to an end and may well have been used purely to facilitate rapid construction.

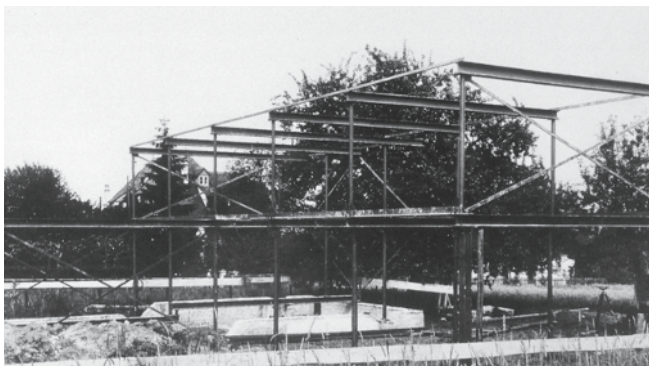


Fig. 112: The primary loadbearing structure is a horizontal and vertical succession of separate yokes.  
Artaria & Schmidt: Schaeffer House, Riehen (CH), 1927–28



Fig. 114: All traces of the structure are concealed behind masonry panels and render.  
Artaria & Schmidt: Schaeffer House, Riehen (CH), 1927–28

## Column-and-slab systems

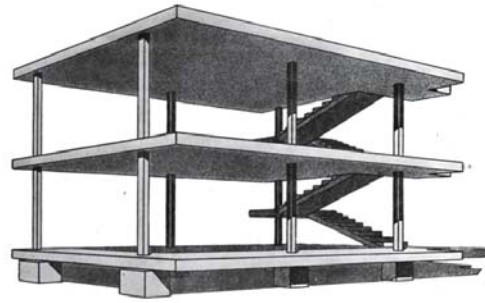


Fig. 115: Loadbearing structure in concrete, with cantilevering floor slabs and bracing provided by the staircase  
Le Corbusier: Dom-ino project, 1914



Fig. 116: Transparent, "flying" living room at the front stabilised by compartment-type bedrooms at the rear  
Lina Bo Bardi: Casa de Vidro, São Paulo (BR), 1951

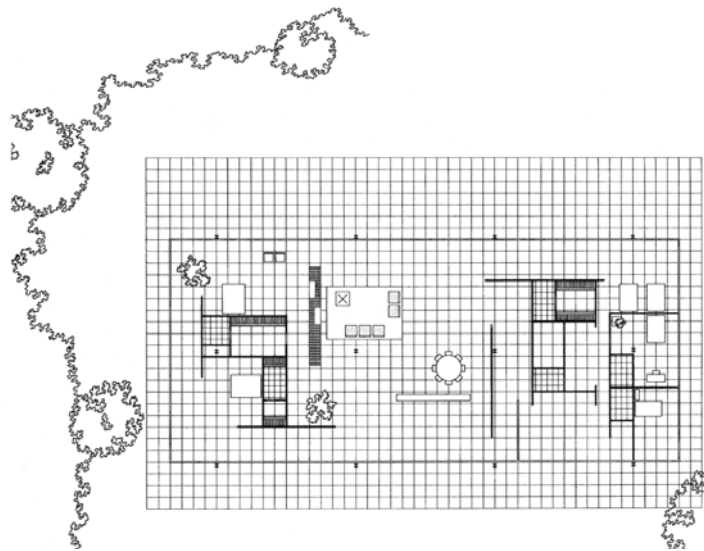


Fig. 117: Fluid space continuum, the fusion of interior and exterior  
Ludwig Mies van der Rohe: Caine House project, 1950

**Le Corbusier: Dom-ino project**

Le Corbusier took a Hennebique-type frame, in which the in situ concrete columns are placed at the very edges of the concrete floors, and moved the columns back from the edges. Firstly, this resulted in a shortening of the span (and as a result a reduction in the depth of the slab) and, secondly, it enabled openings to be positioned independently of the loadbearing structure. The ribbon windows advocated by Le Corbusier later, or indeed the curtain wall (*façade libre*), is closely linked with this form of construction.

In line with Le Corbusier's proposal for reconstruction after the war in Flanders, relieving the facade of its loadbearing function enables low-quality materials with poor loadbearing characteristics (e.g. debris from destroyed buildings) to be used.

**Lina Bo Bardi: Casa de Vidro**

This, the architect's own house, is situated on the side of a hill. It unites the column-and-slab system and the compartmentation approach. Supported on circular columns, the expressively cantilevering living room is formed by two slabs, with the glazing of the facade spanning these like a skin and conveying an image of maximum lightness.

The necessary stability is provided by the bedrooms at the back, which employ the compartmentation principle. They are arranged in two rows with the garden between. The open ground floor forms a forecourt to the garage and provides access to the living room.

**Ludwig Mies van der Rohe: Caine House project**

The definition of space in this design for a bungalow makes use of non-loadbearing wall plates arranged at random within the column grid. The way in which the walls relate to each other enables the creation of clearly defined compartments but also fluid, interconnected spaces. Depending on the occupant's position, he or she can seem to be in two or even three rooms at the same time!

In the project shown here there is a certain compaction on the right-hand side, with some of the rooms for domestic staff and children directly adjacent to the facade. However, the facade remains uncluttered over the remaining floor area.

The fully glazed column-and-slab system was proposed here in order to achieve the illusion of maximum possible fusion between interior and exterior.



## Single-storey shed forms



Fig. 118: MAXI steel building system, (above) before adding the cladding, (right) with associated facade system  
Fritz Haller: USM plant, Bühl (D), 1983–87

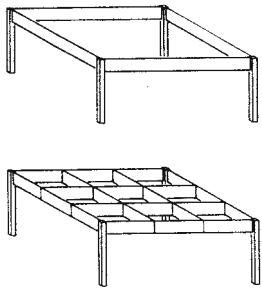


Fig. 119: Modular building system

### Fritz Haller: USM plant, Bühl

The MAXI modular structural steelwork system devised by Fritz Haller, as used for the USM plant, includes facade and roof elements as well as the loadbearing structure.

The maximum column grid is 14.40 m for a two-way span arrangement or 9.60 x 19.20 m for a one-way span. Not unlike Jean Prouvé's "Palais des Expositions", the floor also consists of lattice beams but in this case is not an independent system. The floor is made up of main beams, which span from column to column, and intermediate beams at the same level at right-angles to these (beam grid).

The non-loadbearing facade is connected to a secondary framework on a 2.40 m grid and conceals the primary loadbearing structure. Fritz Haller has also designed MIDI and MINI modular systems with correspondingly reduced spans.

### Salt warehouse

The single-storey shed shown here illustrates the use of glued laminated timber (glulam) members and the aspect of partial prefabrication.

Basically, the bonding of timber boards to form beams evens out the natural irregularities (inhomogeneity) of the wood but also enables to achieve lengths far beyond those that trees can achieve naturally. The shape of the

members used for this salt warehouse match the flow of the forces and form a three-pin arch.

Pairs of parallel members, together with wind and stability bracing, are assembled to form a half-shell, which is then erected against another half-shell (providing mutual support). The bracing and purlins between the arches are added on site and, in the final building, disguise the form of erection.

### Jean Prouvé: Palais des Expositions

With a column grid of 36 m the "Palais des Expositions" extends over a floor area of 23 800 m<sup>2</sup>. The primary structure was conceived as a platform with rigid connections between the columns and the 1.5 m-deep steel beams.

The columns themselves are each made up of five steel tubes which fan out from a common base and thus provide the necessary bracing effect. Resembling a table-top, the space frame, constructed of intersecting lattice beams, sits like a secondary structure on the beams. The space frame was assembled in sections on the ground before being lifted into position and fixed.

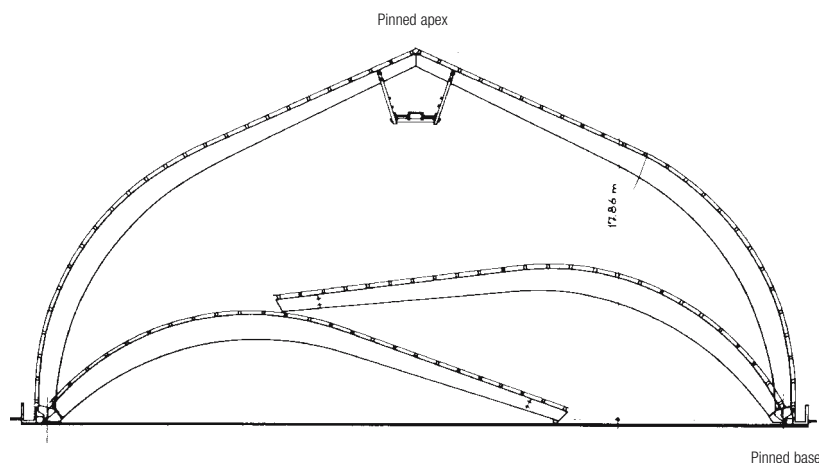


Fig. 120: Beams as primary and stressed skin as secondary loadbearing structure  
Salt warehouse



Fig. 121: Erection of prefabricated half-shells  
Salt warehouse



## Prefabrication

### System building

Alois Diethelm

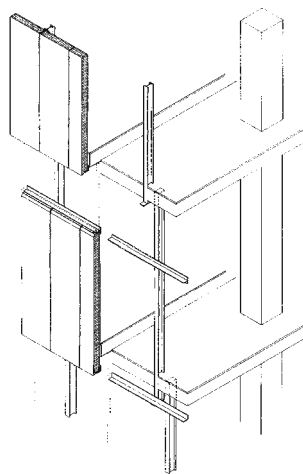


Fig. 122: Axonometric view: FCW warehouse  
Durisol panels attached to secondary structure

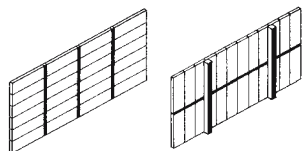


Fig. 123: Durisol system  
Horizontal panels between loadbearing columns, or  
vertical panels as curtain wall

Every form of construction is founded on a set of rules stemming from, initially, the properties and conditions of the materials employed and the requirements they have to meet. The specific properties of a building component are after all the product of a process of cognition drawn from both the empirical and analytical experiences gained. As a result, these experiences generate rules for their use or processing ("the rules of architecture"). Consequently, every form of construction involves building with a system.

#### Directives – standards

The impetus behind systemised building (a term which still has to be defined) is due to many reasons. However, it is always accompanied by the desire to achieve optimised working procedures, whether in the planning, production or processing. One example of this is the dimensional coordination of masonry units (see the essay "Types of construction"), which the architect can use as his or her dimensional basis, the brickwork manufacturer for producing larger batches, and the bricklayer for building practical bonds.

A minimal but relatively widely supported consensus on the dimensions of building components forms the basis for the modern building industry. So we can speak of systemised building because the quality and dimensions of individual components (primarily semi-finished goods, e.g. wood-based boards, metal sections, etc.) are defined by the relevant standards (SIA, DIN, etc.).

#### Types of prefabrication

The difference between systemised building and system building is connected with the various degrees of prefabrication. This gradation leads to motives for the choice of a particular form of construction. Generally, prefabrication is associated with cost- and time-savings plus improved workmanship. However, only when looked at in terms of additional criteria is it possible to choose an optimum system for a specific project.

These days, small- to medium-sized construction projects can employ two fundamentally different prefabrication principles: a) dimension-related systems with kitlike modular coordination, and b) individual prefabrication with specified jointing principles (e.g. timber platform frame construction). Both systems have, in the meantime, become highly developed – thanks to large-scale production. But otherwise they could not be more different! Modular construction is designed to permit the exchange of individual elements (easy adaptation to suit changing or new conditions) and this generates the architecture. The modular coordination relieves the architect of the need to make sometimes arbitrary decisions derived from aesthetics, e.g. the size and position of a window, but at the same time could be regarded as limiting the degree

of design freedom. At best, the surface finishes of the elements can be selected independently.

It is essential to make a distinction between self-supporting systems and those that need a loadbearing frame, and to include the form of the elements (2D/3D). Apart from just a few exceptions, we shall consider only those systems that fulfil all the requirements (thermal and sound insulation, weather protection) in one and the same ready-to-use building component, be it a sandwich panel with a multi-ply construction or a monolithic – "synthetic" – construction.

#### Non-loadbearing elements – facades

Most of the systems that require an independent loadbearing structure are 2D elements for facades. They are popular because they permit the use of diverse loadbearing systems and interior layouts. However, a secondary framework for fixing the elements will be necessary, to suit the size of the elements and the position of the columns. The Durisol system, which enabled two different forms of construction with the same panels, was a good example in many ways; horizontal elements positioned either between or in front of the loadbearing columns at a spacing of 1.5 m; alternatively, vertical elements suspended from a secondary framework like a curtain wall. The success



Fig. 124: Facade using Durisol system  
Rudolf Kuhn and Heinz Ronner: FCW warehouse, Zurich (CH), 1954–55

of the Durisol system (Durisol element: impregnated, cement-coated wood fibres formed the core for the factory-applied waterproof render outside and hard plaster inside) may well be due to the fact that it represented a rudimentary, easily understood system and, apart from the panels, was not restricted to certain products or manufacturers. It was thus comparable with a masonry unit, a brick. In contrast to the sheet metal panels widely used for single-storey sheds today, where the architectural input is mainly confined to the external cladding, Durisol facades bore a direct relationship with their tectonic properties. The design potential inherent in the Durisol system (compare Max Bill or Rudolf Kuhn with Heinz Ronner and others) can be attributed to its being a "soft" system (few parameters), a direct consequence of the small, directional format of

the panels. The method of using customary products in an uncustomary way manifests itself here.

### Self-supporting elements – room units

The 3D systems, where complete room units are suspended from or supported on a loadbearing frame, exhibit exactly the opposite behaviour. Adaptation to changing conditions or renewal from time to time (due to wear or fashion-driven obsolescence) require the replacement of the complete unit. Whereas in the 1960s the idea of exchanging units was primarily the outcome of a desire for social utopias (cf. Metabolism), today it is mainly production techniques. However, the aspect of large-scale production is usually confined to repetitions within the same structure; the universal application of such units is practically equal to zero. The situation is different with units that are not part of a primary structure but instead function autonomously. The best-known examples of these are prefabricated garages and standard (freight) containers used as temporary site accommodation.

In addition, the room unit exhibits the greatest degree of prefabrication. Like a caravan it is fully finished internally and is more or less ready to occupy after it has been transported to the building site. In the 20th century caravans, but also railway carriages, aircraft and ships, provided endless inspiration for various attempts trying to create compact, multifunctional units as the most compressed form of minimal shelter. Borne along on the euphoria of the plastics age, the late 1960s saw the appearance of diverse kitchens and bathrooms that could be inserted into the interior like furniture. Plastics enabled seamless transitions from, for example, a shower tray to the rising wall, and saved weight. However, the limited

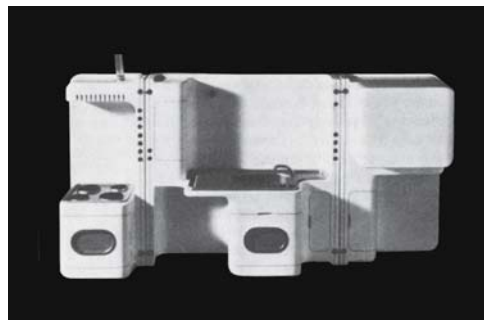


Fig. 125: Room unit interpreted as plastic furniture; the photo on the left shows the kitchen in the closed condition.  
Masonari Umeda: mobile kitchen, 1968

radius of action of mobile bathrooms (pipes and cables!) and the fact that plastics can only be renewed by replacing them may explain why these room units never became very popular. Fully fitted sanitary compartments installed storey by storey – coupled with the progress on site – have been in use for some time (primarily in hotels). These concrete units can be fitted with ceramic tiles and appliances in the conventional way to suit the client's specification.

This is clearly an attempt to optimise quality of workmanship and costs. The aspect of prefabrication concerns neither the replaceability nor the aesthetic relevance.



Fig. 126: Container (e.g. as meeting room) supported on steel frame  
Dollmann + Partner: office building, Fellbach (D), 1999

### Loadbearing elements – floor, wall and roof

When we speak of individual prefabrication, meaning that form of construction where a building is broken down into transportable segments and subsequently reassembled in such a way as to disguise the reassembly, we initially think of timber platform frame construction. However, we also see this method being used for more heavyweight forms of construction, above all in Germany, where brick walls are supplied as storey-high elements. As the prefabrication does not alter the constructional conditions significantly, this form of construction does not create its own specific architecture. The situation was different with the heavyweight panel construction that was widespread in the Warsaw Pact countries. Those elements were supplied completely finished (paint, plaster or tiles) and lifted into position. The exposed joints – whose degree of sealing left much to be desired – reflect the internal layout (the elements span from floor to floor and from wall to wall). Openings are generally holes within a panel, with the omission of whole panels and their replacement with glass, e.g. for an entrance or staircase, representing the exception.

Rudolf Schindler turned these “empty spaces”, or rather introduced clearance between the panels, into a standard on his own home in Los Angeles (1922). Large expanses of glass at the corners alternate with slit-like windows fitted between uninsulated concrete elements. An answer to the current building performance requirements is supplied by elements like the clay products of the French manufacturer Guiraud Frères in Toulouse. The storey-high elements, which are equally suitable for use as walls and floors, are available with and without core



Fig. 127: Storey-high clay elements with loadbearing and insulating functions; (left) erection of loadbearing structure at ground floor level, (above) finished building

Tectône: hotel training school, Nivilliers (F), 1999

insulation. They may be used without render/plaster, e.g. at the hotel training school in Nivilliers, and in this way are a direct reflection of the tectonic qualities.

#### Loadbearing elements – room segments

Positioned halfway between our two-dimensional elements and room units are those elements that are indeed three-dimensional but need to be joined to create a complete interior space. These are a) repetitions of identical room segments, or b) the combination of identical but also different elements. The L-shaped elements represent a hybrid form where one leg forms the wall and the other the roof; as separate units these belong to category b), but assembled in pairs they are similar to category a).



Fig. 128: The concrete panels were cast on the ground (top) and afterwards lifted into position (bottom).

Rudolf Schindler: Schindler House, Los Angeles (USA), 1921–22

The advantages are the simplified handling, helped by the smaller dimensions, and – as a direct result of this – the saving in weight. The space-forming principles extend from single L-shaped elements fixed in the ground (e.g. bus stops), to mutual support, to support on one side provided by, for example, in situ concrete walls or beams. The use of such L-shaped elements is interesting where the horizontal leg forms the roof – in single-storey structures or the topmost storey of a multistorey building. The structural and thermal insulation demands placed on



Fig. 129: Shell-type building envelope made from polyurethane  
Addition of self-supporting room segments

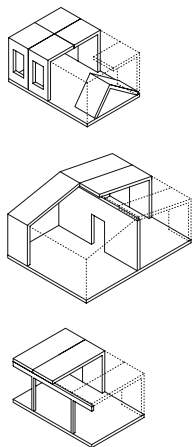
both legs are then almost identical, so the surfaces can also be identical. And if they are identical, it is possible to achieve a seamless transition from roof to wall and hence overcome a number of weak points in the construction (change of material).

#### Loadbearing elements – room units

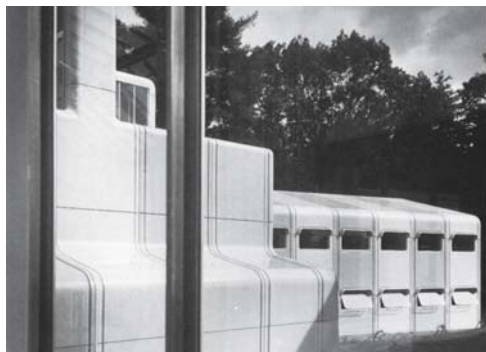
The fundamental prerequisite for every room unit is that it must be self-supporting. When we speak of “loadbearing” room units we mean the ability to stack them. The absence of a primary, independent loadbearing structure means that the aspect of interchangeability no longer applies but the possibility of temporary usage takes on more prominence. As the units are joined like building blocks, they can also be dismantled without damage and re-erected elsewhere. Examples of this form of construction are building site accommodation and temporary school classrooms.

On the other hand, building with room units has also been used where neither replaceability nor temporary usage were relevant. In such cases cost-savings and a better quality of workmanship were the decisive factors. Whereas other methods permit the assembly of individual walls, floors, and roofs to form interior spaces of virtually any size, in this method the room unit is coupled with the transport options. At HABITAT 67 the size and weight of the units (19.75 x 5.35 x 3.65 m; 85 t) meant that prefabrication had to be carried out in situ.

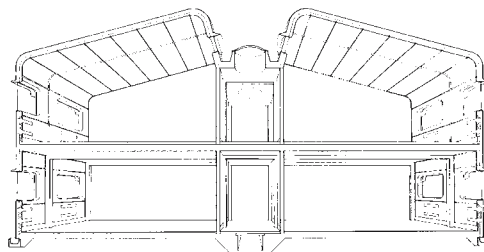
Stacking units so that they face different directions creates open terraces but also covered external spaces.



**Fig. 130: Room segments: L-shaped elements**  
Formation of interior spaces by fitting segments together or to a supporting structure



**Fig. 131: Plastic walls and roof**  
James Stirling: Olivetti training centre, Haslemere (GB), 1969



**Fig. 134: Intermediate floor with loadbearing structure of linear members; roof and wall elements are loadbearing**  
James Stirling: Olivetti training centre, Haslemere (GB), 1969

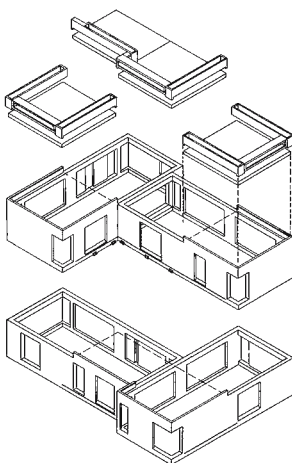
And stacking has an effect not only on the external appearance; internally, maisonnettes are often the result.

#### Outlook for the near future

Reduced to constructional aspects, prefabrication can be broken down into the categories “complementary systems” and “synthetic systems”. The former are systems that consist of a multitude of complementary, partially autonomous layers, the latter those whose components are quasi-permanently connected and that may well result in a material that satisfies the “loadbearing–insulating–protecting” requirements simultaneously. If a “comple-

mentary system” can be regarded as a mechanical assembly, then a “synthetic system” is something like a “contaminated agglomeration”, which of course immediately raises the question of its recyclability. They are usually classed as special waste.

The objective of current materials technology research is therefore to guarantee reuse or at least recyclability. The first attempts in this direction involve trying to replace the plastics by suitably refined organic materials. In this case prefabrication is aiming to solve an ecological problem, a tendency whose significance for system building is set to grow.



**Fig. 132: Roofs are only added where there is no unit above.**  
Moshe Safdie: HABITAT 67, Montreal (CAN), 1966–67



**Fig. 133: Stacking of concrete room units (“heavyweight prefabrication”)**  
Moshe Safdie: HABITAT 67, Montreal (CAN), 1966–67



**Fig. 135: The units are erected as “structural shells” without any roof.**  
Moshe Safdie: HABITAT 67, Montreal (CAN), 1966–67



## Sustainability

### Fundamentals of architecture

Andrea Deplazes



Fig. 1: Hans Kollhoff: High-rise office block, Potsdamer Platz, Berlin (D), 1999



Fig. 2: Jean Nouvel: Arts and Congress Centre, Lucerne (CH), 1999



Fig. 3: Solid construction, stereotomy



Fig. 4: Filigree construction, tectonics

The 3rd International Architecture Symposium took place in Pontresina in the autumn of 2000. This marked an encounter between two high-profile antipodes of architecture – not, unfortunately, in a direct debate – whose positions on the subject of “sustainability and self-conception in architecture” could not be more different: Hans Kollhoff from Berlin, whose office skyscraper in hard-fired brickwork on Berlin’s Potsdamer Platz has already attracted considerable attention, and Jean Nouvel from Paris, who presented an illustrated discourse of epic proportions on the Lucerne Arts and Congress Centre, besides other projects. These two rivals represent a – there’s no other way to describe it – diverging creed in terms of the relevance of architecture and its consistence today and in the future. Kollhoff will not desist from returning the fundamentals of architecture to solid construction (stereotomy) and filigree construction (tectonics) while calling for good workmanship, craftsmanship, and sustainable architecture. In his words: “The real question is which structures will still be around 75 years from now. Just look at the works of Jean Nouvel; in five years time they’ll be ready for pulling down!” Jean Nouvel, on the other hand, describes such criteria as 19th-century thinking and retaliates with the observation that the building process has changed radically, that modern technologies of architecture demand a completely new concept and attitude, due to industrial production and assembly, for example: “Whoever builds with bricks and inserts little windows must be very limited upstairs!” So much for the initial statements marking out the lines of battle.

Of course we know that Hans Kollhoff tends to favour solid construction. After all, it is precisely the filigree constructions of Jean Nouvel and others that he so despises. The terms solid construction and filigree construction, and their architecture theory equivalents stereotomy and tectonics respectively, are the names of two categories of architecture which are fundamental in morphological and phenomenological terms. If we do not wish to approach critical comparisons in architecture from a historical–contemporary or stylistic angle, but rather, for example, consider the structural characteristics of different cultures, then we quickly discover some surprising coincidences.

The pisé/cob form of construction in China and modern European reinforced concrete construction, in terms of the production process (“mould” plus “casting”) and the finished appearance of the wall (“pattern of the mould”), are identical. The only differences lie in the materials and the technology of the moulds. The concrete plays the role here of a further developed, processed, and therefore permanent “cob”. Both contain solids such as gravel and sand in different grain sizes, plus dustlike fine constituents, silts or cement, which form a mineral “glue”,

when water is added. Whether simple wooden panels or the very latest large steel formwork systems have been used is reflected merely on the surface of the finished wall.

Similarly, we can compare the frame of a yurt from the Caucasus with a traditional timber-frame building in Switzerland and the three-dimensional lattice made from industrially manufactured steel sections forming the load-bearing structure of an American skyscraper. We discover that there are almost identical tectonic principles that enable us to assemble linear members to form a two- or three-dimensional framework. The only differences are in the spans and the stability of the linear members (because we are comparing debarked sticks, sawn squared timber and rolled steel I-sections), the detailed design of the connections between the members (which are either axial or eccentric, tension- or compression-resistant or both), and the means of fastening required. Many other examples could be added to these, whose differences would then have to be fleshed out and explained; but that is not the intention of this essay.

We can draw two initial conclusions from this: the two categories stereotomy and tectonics are certainly suitable for describing the fundamental structural and building process characteristics of architecture and – comparing location, time, and culture – demonstrating the foundations of the origin and evolution of architectural form. They are not, as Jean Nouvel obviously believes, dust-laden, outdated dogma from the history of architecture. Further, these comparisons show that where different cultures have had access to the same resources of usable materials, they have developed surprisingly similar forms of building more or less independently of each other.

In reality the development of building techniques and the interplay between science, research, and technology exert a great influence on the building process and, consequently, on the visible architectural result. However, this concerns only the optimisation and refinement of the production and processing methods, i.e. the workmanship or the industrial production process, and hence the product, the building materials, of course. These have always been subject to ongoing improvements in order to make them either more *durable* or *stronger*, which is not necessarily the same thing. In striving to attain climate and weather resistance, timber was swapped for stone, an organic for a mineral substance, which triggered a completely different type of building process. (Consider the “theory of metabolism” of Gottfried Semper, which is less concerned with building techniques themselves and more concerned with the consequences for architectural style at the time of the change from tectonics to stereotomy, a sort of transfer of timber construction to solid construction. I call this conflict “technological immanence versus cultural permanence”.)



Fig. 5: Reversal process from solid to filigree construction from about 1800 onwards, provoked by industrial production



Fig. 6: Chicago  
The steel frame to a „solid“ high-rise block

So the trend was to favour solid construction whenever possible, which resulted in the increase in value of public architecture, in monumentalism, but also in the sense of a pragmatic approach to traditional timber construction, where the open panels between the timber members were filled with brickwork and the facades sometimes covered with a mineral lime render like the skin. And building materials became stronger in order to improve the *relationship between loadbearing capacity and material consumption*. The upshot of this was that the building elements became ever more refined and more slender, which first happened with the introduction of steel sections into architecture around 1800. It is not difficult to imagine what a fundamental upheaval this meant to the architect's self-conception; the sudden replacement of solid, real(!) structures with stone and brick walls by filigree lattices of steel sections with more or less permanent infill panels of masonry and stone cladding. That was what happened in Chicago with the invention and erection of the first high-rise buildings. And that marked the reversal from solid construction to filigree construction, provoked by industry.

Moreover, the technicians and engineers of structural steelwork faced a new problem, one which is still with us today: corrosion. The measures required to protect steel sections and panels against rust are immense and a considerable cost factor in the upkeep of a steel structure. And Jean Nouvel's Arts and Congress Centre in Lucerne has not been spared this problem; constant maintenance and renewal of the corrosion protection system is the only way to keep rust at bay.

This leads to a dilemma because, although building materials technology is always trying to achieve durable *and* strong materials, as yet no suitable synthetic, answer-to-everything building material has been found. We are saddled with similar problems in the corrosion that attacks reinforcement in reinforced concrete. But even indestructible stone, the incunabulum of stereotomy and the reason for the immortality of historical structures, is showing the signs of erosion caused by acid rain and aggressive urban atmospheres, particularly softer varieties such as sandstone, tuff, or limestone. So even stone is not our answer-to-everything building material, even if it is more durable than steel.

So in this sense Nouvel's plea in favour of modern technology as a generator of contemporary architecture and an answer to the acute demands of sustainability – of course, not as the only criterion – does not go far enough. This is because it is not a third category but rather an ingredient contained in both stereotomy and tectonics.

However, if we consider Nouvel's stance in the light of the fact that technology has tended to develop ever stronger and hence thinner building elements, which led

in steps to our glazed filigree construction (from solid walls to slender brick or concrete shells, from multi-layer double windows to thin insulating glass membranes), then we might dare to suggest an adventurous hypothesis:

If the present glass technology and the associated curtain wall facade systems advance as rapidly as they have done in the past decade, ten years from now we shall surely reach the point at which we can no longer sublimate the substance. What this means is that we would then have facade films in the nano-molecule range, e.g. two film-like skins with aerogel between spanning ultralightweight carbon fibre structures.

If that seems unbelievable, take a quick look at the technology of space travel, which triggered the aforementioned rapid progress in glass technology. The space suits worn by the astronauts on the moon were multi-layer designs. Each layer had to guarantee a different protective function. The *moon suit* was therefore a *complementary system of monofunctional components* with the undesirable side-effect that it was heavy and restricted the astronauts' movements considerably. By contrast, the *Mars suit* will be a *synthetic system* comprising just a few, perhaps just one *complex* layer of high-tech textiles which will perform *multiple functions*. Now if that doesn't have an effect on our facades...

But how does that serve architecture?

Somehow, listening to Nouvel's lecture in Pontresina, I was reminded of the film "Déjà Vu", with its illuminated glass towers covered in writing and pictures, celebrating the play of multi-layer transparency and the reflective parallaxes in the aurora of the artificial light of the illuminated city – all brilliant projects in a virtuoso presentation. Take note! Nevertheless, what remains apart from the *"two-dimensional image"* of architecture? Where do we go from here – if not mere imitation – with this extreme reduction to "projection"? What is there left to invent that has not already been tried? Is the final "kick" really just the leap into the virtual world of fantastic, animated illusion? At any rate this road towards technological and architectural sublimation will only leave room for recurring variations! A horror vision for today's architects asking the question of what will really be relevant for their discipline in the next three to five years!

So if filigree construction seems to be heading towards a temporary dead-end, solid construction – following a sort of genetic programme of compensation – may be heading for unforeseen new honours simply because it promises a broad fallow field site for architectural discovery.

As an example let us assume that we overcome the already *outdated building performance standards of the 1970s*: from multi-leaf facade construction to

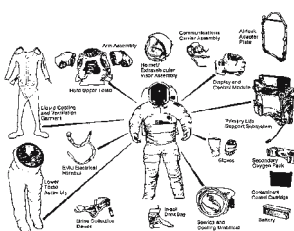


Fig. 7: Moon suit  
Structure and components

monolithic-synthetic. Not because I wish to praise this technology (but a corresponding minimum expertise is important for architects), but because unforeseen possibilities for the *plastic modulation* of building mass and spatial inclusions, of massiveness and solid walls, of layering and opening are waiting for us; all extraordinarily rich and elementary architectural themes.

Again and again I am amazed by the spatially clear conception of the Scottish donjons (or keeps), with their rooms built within the three-metre-thick walls: a maximum defensive stance with minimum use of materials, true “clearings”. This is not about massiveness and monumentality in a historical sense or style but rather about a source of architectural design strategies which, with the present conditions and signs, are worth sounding out. In comparison with this Le Corbusier’s beacon for overcoming cell-like, plain interior spaces by using reinforced concrete columns and flat slabs, his famous sketches from *Five Points of Architecture*, are rather consumptive, although I must admit that his and also Mies van der Rohe’s fascination with an open progression of spaces and glazed membranes (the term “facade” is questionable here) was undoubtedly new and justified. But that is already 70 years ago, which is why Nouvel’s statement must inevitably be regarded as anachronistic.

Why should Kollhof’s solid construction be antiquated and Nouvel’s filigree construction contemporary?

Let’s look at the essential features of both categories and their structural differences in order to discuss their suitability for and relationship with the issue of sustainability. Obviously, *the term “architectural structure”* has something to do with visions of durability, inertia, rigidity, changeability, and flexibility.

In solid construction, as the name suggests, solid, uniform walls are erected first and perforated (to create openings) immediately afterwards, or at least during the building process. This is the direct creation of interior space, whose arrangement has been established on the plans and sections, as well as the separation from the outside world. Solid construction appears to be erratic and permanent, or looked at another way, inflexible and rigid. This concept is obviously also carried over to the usability of a solid structure, and even to the assessment of its *usefulness*.

In filigree construction a lattice of slender linear members is erected first. This framework projects into the surrounding, natural space, but without us being able to distinguish between interior and exterior. As soon as it is erected it is covered with a skin or the open spaces between the linear members are filled in to create surfaces. This is the only way of distinguishing between interior and exterior, above and below. Which bay is closed off or not is not prejudiced by the lattice structure, which gives rise to the impression of increased flexibility, during utilisation as well.

Now, we know that every generation is accompanied by changes in values which characterise that generation and distinguish it from others. And by this I certainly do not mean fashions, which are extremely short-lived. In the indistinct mix of concurrent values that characterise our modern pluralism, the problem would seem to be the lack of a sufficiently adaptable concept for distinguishing and assessing vital criteria. There are also biological re-evaluations and changes, e.g. a couple moves into an apartment together, they have children, and those children grow up in that apartment, departing when they reach adulthood. It hardly needs to be explained that such changes exert a direct influence on the concept of and the desire for adaptable architecture which matches situations throughout life.

What this means for solid construction is that despite a defined internal layout, sufficient *flexibility of utilisation* must be incorporated. This is nothing other than designing interior spaces not for specific purposes but instead leaving them “open” to allow for various utilisation options. In this way not every change of function will lead to a conversion, plus the associated energy requirements and disposal problems. On the other hand, this concept risks introducing monotonous, stereotyped, uninteresting architecture, which in turn proves to be a permanent problem in urban, everyday situations. (Astoundingly, it was precisely the classicism of the 19th century that provided a credible solution to this dilemma.)

The situation is completely different with filigree construction in which the *flexibility of the interior spaces* appears to be, so to speak, inherent within the system. The problem of “adaptable” utilisation does not arise here (the specific internal layout requirements can be met completely individually), but instead the question of the provision of permanent and flexible components for dividing the interior space, for creating rooms, and their environmentally compatible disposal and/or reuse. It seems that we have to introduce a new scale of values at this point: the classification into short-, medium-, and long-term lives of building materials and building elements which are dependent not only on such factors as climate and weather, load-carrying capacity and stability, but to a large extent on the *utilisation demands*. This is also a welcome occasion, albeit perhaps late, to dispense with the rather didactic distinction between solid construction and filigree construction, or at least to blur the distinction to allow for the newly introduced criteria to apply to both categories. (Of course, solutions between these two poles have been attempted continually throughout the history of building. What is a Gothic cathedral if not a solid construction of most sublime filigree design? What are the temples of the ancients if not the most solid tectonics? But I don’t want to discuss the considerably more complex architecture theory term “tectonics” here.)

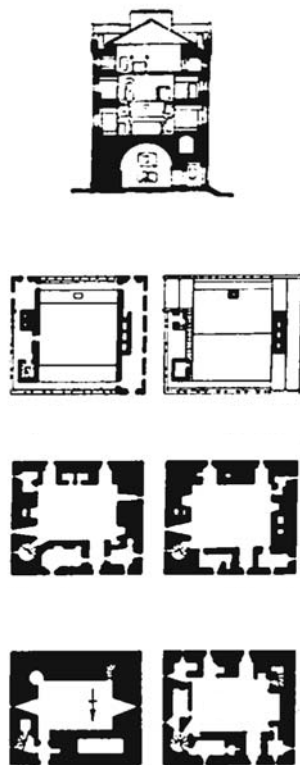


Fig. 8: Comlongan Castle, Dumfries (Scotland, GB), 15th century

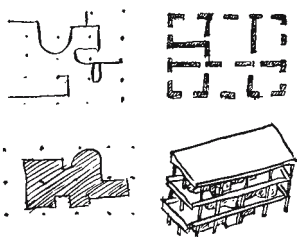


Fig. 9: Le Corbusier: sketches from *Five Points of Architecture*

So we are talking about the *half-life* of a building and the realisation that the basic fabric of a structure has a governing influence on the extent of the finishes and fittings. In solid construction the structural shell corresponds to the finished construction to a large extent (basically only the services, closures to openings and surface finishes are missing). But in filigree construction the permanent, structural proportion is, by contrast, so small that considerable work is required to subdivide the interior space and add the finishes and fittings. In the light of this it is worthwhile classifying building elements according to three priorities: the basic fabric of a structure, the structural shell, comprises the loadbearing structure and, possibly, the building envelope. This has a long lifetime (target: 100 years) and therefore cannot be changed, i.e. is permanent. This is called the *primary structure*. The interior subdivision, the interior finishes and fittings and the building services constitute the *secondary structure*. These have an average life-span of about 20 years, which is why they must be conceived as adaptable and variable. The *tertiary structure* is made up of equipment, technical apparatus and furnishings with short lifetimes (on average five to ten years). These items are easily changed and flexible. These three time-related conceptual stages are characterised by clear demarcations between the different structures and components. It must be possible to install, disassemble, or reassemble secondary and tertiary systems subsequently without disrupting the intact whole. The “seams” also guarantee recycling sorted according to material. I am not advocating, for example, a self-contained building system (I certainly do not wish to repeat the history of industrialised prefabrication through standardisation), but instead wish to demonstrate further strategies for architectural design, a long-term concept for the development of flexible design and form-finding criteria.

This brings me to the last point in my comparison of solid and filigree construction. It would seem that, led astray by the building insulation requirements of the 1970s, we have paid too little attention to the mass of the building. Today we know that the absorption of heat by solid components, particularly in well-insulated buildings with plenty of windows, has to be given special attention to avoid overheating of the interior in summer. There are two methods in low-energy design: the *storage concept* and the *insulation concept*. Both approaches exploit the system-related properties of solid construction and filigree construction. The storage concept works, as you might expect, with the solid components that are needed anyway: floors, walls, etc. These form heat storage units in which, for example, passive solar energy entering through large south-facing windows can be stored (e.g. school in Vella).

Contrasting with this, in filigree construction, e.g. in a modern timber house (platform frame or panel construction, e.g. Bearth-Candinas private house, Sumvitg), the mass of the building is missing, such that windows facing south tend to lead to overheating. In this case it is much better to fill the spaces between the timber members with a thick layer of insulation and to distribute the windows over all facades in order to achieve an advantageous balance between heat gains and heat losses.

Finally, I shall draw a couple of conclusions which I hope will provide food for thought:

Sustainability is a basic ingredient of architecture. In the ideal case it does permanent good on various levels of human culture – in society, in urban planning, in economic and ecological matters, in the creation of living space (a juncture that is part of human life just as the snail’s shell is part of the snail), in aspects of energy and materials audits, etc., i.e. *in the complex totality*. In this respect success or failure is not governed by having the highest level of technology: transparent thermal insulation, solar collectors, and mechanical ventilation do not automatically guarantee a conscious, sensible use of energy, particularly when we know that in the operating phase of a state-of-the-art building, i.e. after the energy-intensive production phase, the consumption of valuable electrical energy plays a far greater role in an environmental audit than the heat losses. These technical accomplishments, similar to the ingenious but expensive sorting concepts of recycling, stand at the end of a chain of decisions and processes whose success essentially depends on whether a *clear, architectural concept was present at the beginning*. In the light of this the issue of sustainability must be used as a chance to develop new design strategies within the discipline of “architecture”, with which the debate surrounding the architectural relevance of purely formal observations, as are often to be found in schools and in practice, is transformed. The discussion is then:

“Which known and proven architectural principles can be renewed in conjunction with contemporary technology? What is the potential for new creations of architectural themes that can be derived from this? In all this, what is really relevant for the architects of today?”



Fig. 10: Storage concept  
Bearth & Deplazes: school complex, Vella (CH), 1997



Fig. 11: Insulation concept  
Bearth & Deplazes: private house  
(Bearth-Candinas, Sumvitg (CH), 1998)



## The problem of heat flow and vapour diffusion

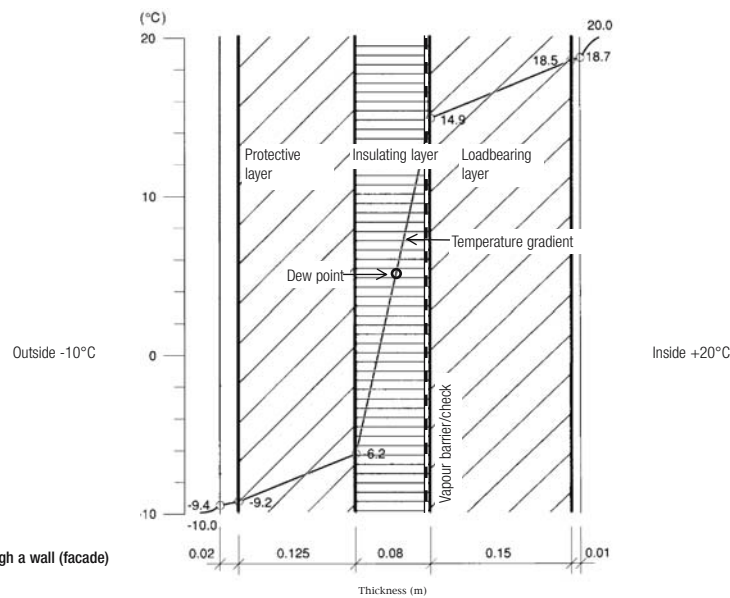


Fig. 12: Heat flow through a wall (facade)

The phenomenon of vapour diffusion

Cold air contains little water vapour (outside – dry air),

hot air contains considerable water vapour (inside – high humidity).

When hot air meets cold air or is quickly cooled, moisture in the air condensates as water (dew point). This can happen as a result of the temperature gradient within a layer of insulation ( $\Delta t = 21.1^\circ\text{C}$ ) within the construction.

Moisture in the construction leads to damage to the building fabric:

- rotting (wood)
- mould growth
- breakdown of the microstructure (materials)
- disruption to the loadbearing structure
- damp thermal insulation is useless

Condensation within the construction (interstitial condensation) must therefore be prevented, or all moisture must be allowed to dry out or escape.

Basic principles

A “vapour barrier/check” must be integrated in order to prevent condensation. Two rules must be observed in conjunction with this:

- The vapour barrier/check must be attached to the warm side (inside) prior to fixing the thermal insulation.
- The imperviousness (to vapour) of the materials must decrease from inside to outside. “Sealed loadbearing layer on the inside, vapour-permeable protective layer on the outside.”

The following symbol is used on drawings to indicate the position of the vapour barrier/check:



*Measures*

Specific technical measures to prevent interstitial condensation, in the thermal insulation especially, are as follows:

*Measure 1*

Internal loadbearing layer made from a vapour-tight material, e.g. in situ concrete, glued panels (sandwich panels in timber construction), internal lining of sheet steel;

or

*Measure 2*

Vapour barrier membrane attached on the warm side directly in front of the thermal insulation;

or

*Measure 3*

Thermal insulation made from a vapour-tight insulating material, e.g. cellular glass;

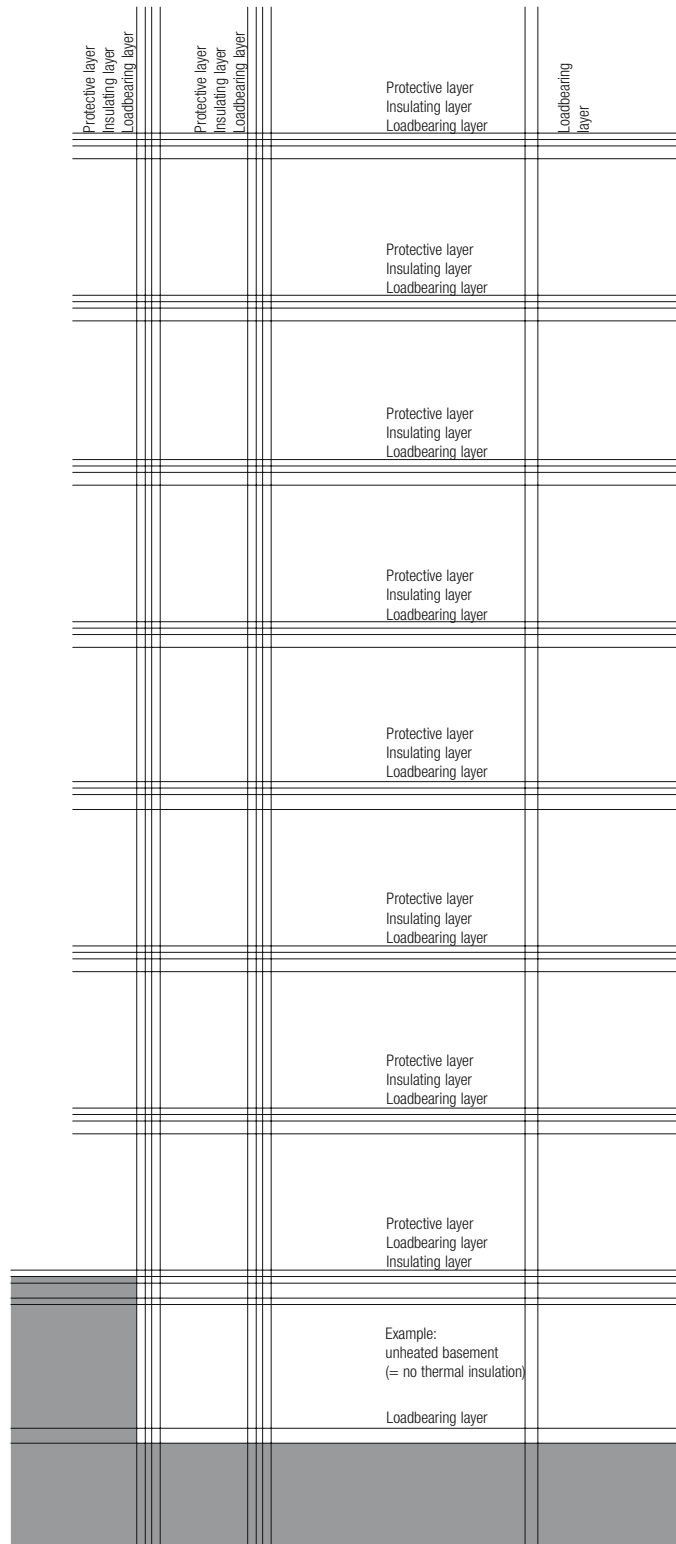
or

*Measure 4*

Ventilated cavity between insulating layer and protective layer;  
condition: good air circulation (thermal currents) in the cavity, width of cavity: 3–4 cm

## Insulation concepts

### Diagram of layers



**Fig. 13: Diagram of layers (template)**

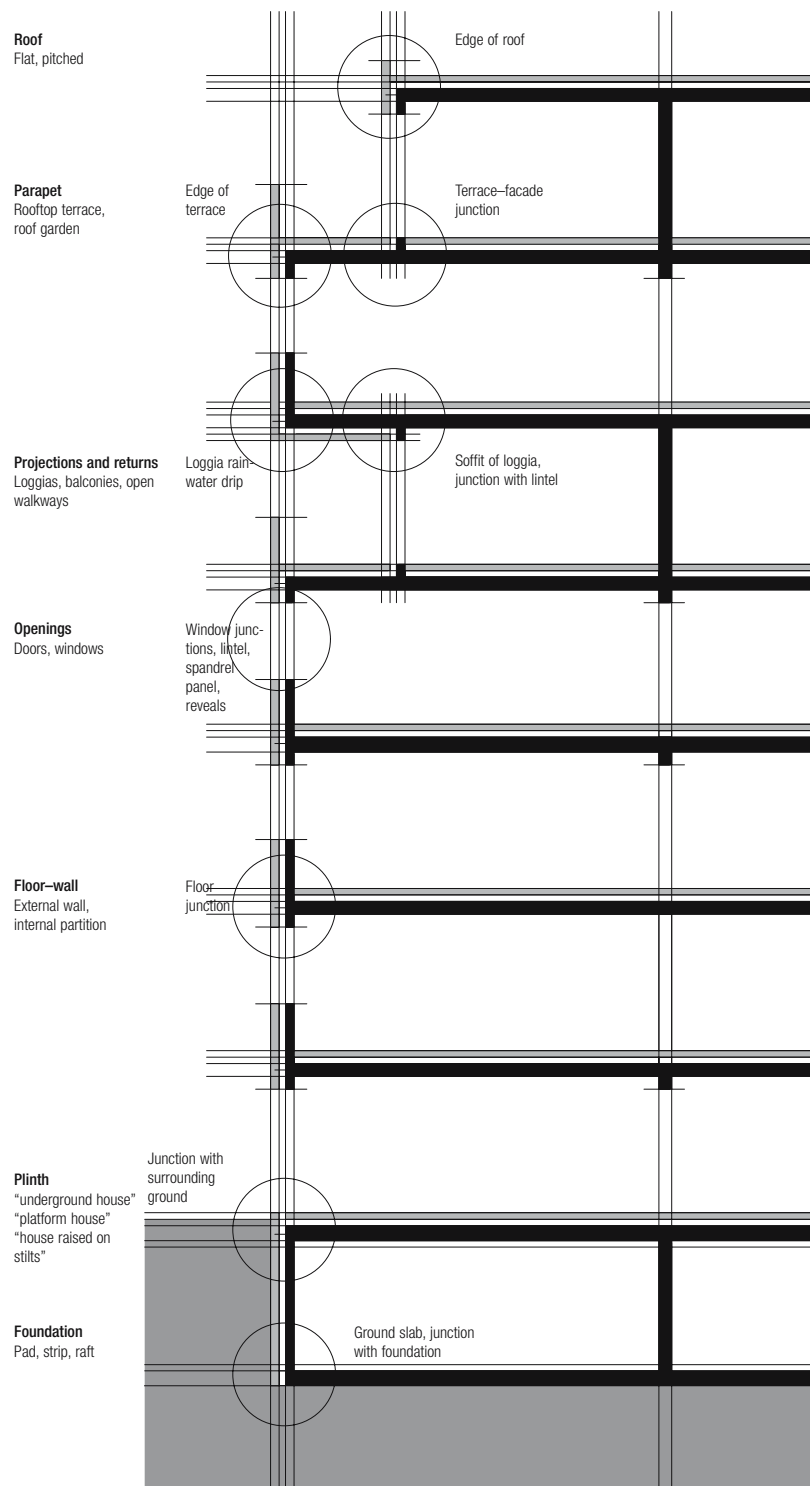
External walls, floors and roofs are first drawn schematically with three layers. The dimensions of the individual layers are not defined here, they are determined by building performance, structural and architectural criteria.

In finalising a draft design the question of a suitable insulation concept arises in conjunction with the intended architectural appearance of the building. Insulation is not automatically “thermal insulation” but can also include sound insulation, for example. Thermal insulation between the interior and the exterior climates is used above all in the facades, in the roof and in the foundations, or rather the “floor over the basement”. Sound insulation is employed primarily between the storeys (in the floors) or in the walls between sound compartments, e.g. between apartments, offices, etc. At the start the architect is faced with the choice of a thermal insulation system. In synthetic systems or compact systems individual elements provide several functions, e.g. insulating and load-carrying. Examples of this are single-leaf masonry walls and timber panel elements. By contrast, there are complementary systems split into a hierarchy of layers with the functions of loadbearing, insulating, and protecting. Starting with the position of the structural elements in relation to the insulation, complementary systems therefore require a further refinement of the insulation concept according to “loadbearing layer inside” or “loadbearing layer outside”.

When choosing a complementary system the diagram of layers serves as a reference for the constructional analysis of a building. It is suitable for checking the continuity and coherence of the insulation concept and for localising problems. Loadbearing layer, insulating layer (thermal and sound insulation) and protective layer are shown schematically on plan and in section, with the rule being that the individual layers should not be interrupted. Openings (doors, windows), changes of direction (projections, rooftop terraces, etc.) and nodes (junctions) in the layers demand special attention. The insulation concept is elaborated when these key points are designed in detail, or – if particularly serious disadvantages are discovered – the concept is discarded.

## Insulation concepts

### Complementary systems – loadbearing layer inside

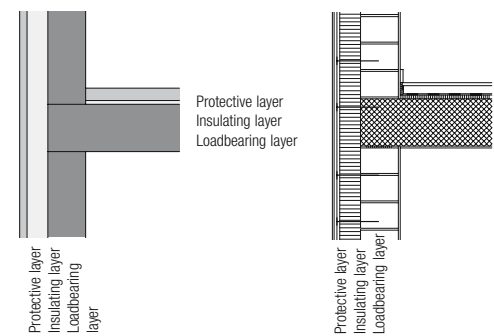


**Fig. 14: Diagram of layers, loadbearing layer inside**

The insulating layer continues uninterrupted as a "second leaf". The circles designate the transitions where the different layers are joined together; these key details must be resolved in detailed drawings.

In this concept the loadbearing layer is exclusively on the "warm side", completely enclosed by the layer of insulation. The outermost layer serves, in the first place, to protect the insulation against mechanical damage and climatic effects and has no loadbearing function. Various materials may be used, from a thin layer of render to suspended stone slabs to facing brickwork or fair-face concrete. Accordingly, the thickness of the protective layer can vary considerably. Penetrations through the thermal insulation are confined to the fasteners for the insulating material and the external cladding or the ties attaching a self-supporting external leaf to the loadbearing layer. The ensuing thermal bridges are minimal.

Owing to the uninterrupted development of the insulation layer and the minimal thermal bridges, the "loadbearing layer inside" concept does not present any problems in terms of the building performance and is one of the most common facade arrangements. It is also frequently used in the refurbishment of uninsulated or poorly insulated buildings.

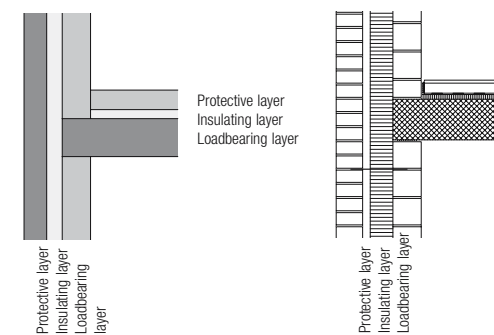


**Diagram of principle**

**Construction detail**

**Fig. 15: Case study: rendered external insulation, wall-floor junction**

The protective layer consists of render applied to the insulation. This form of construction results in a thin wall but the protective layer provides little defence against mechanical damage, which can lead to problems around the plinth in particular (damage to the insulation caused by feet, vehicles, etc.).



**Diagram of principle**

**Construction detail**

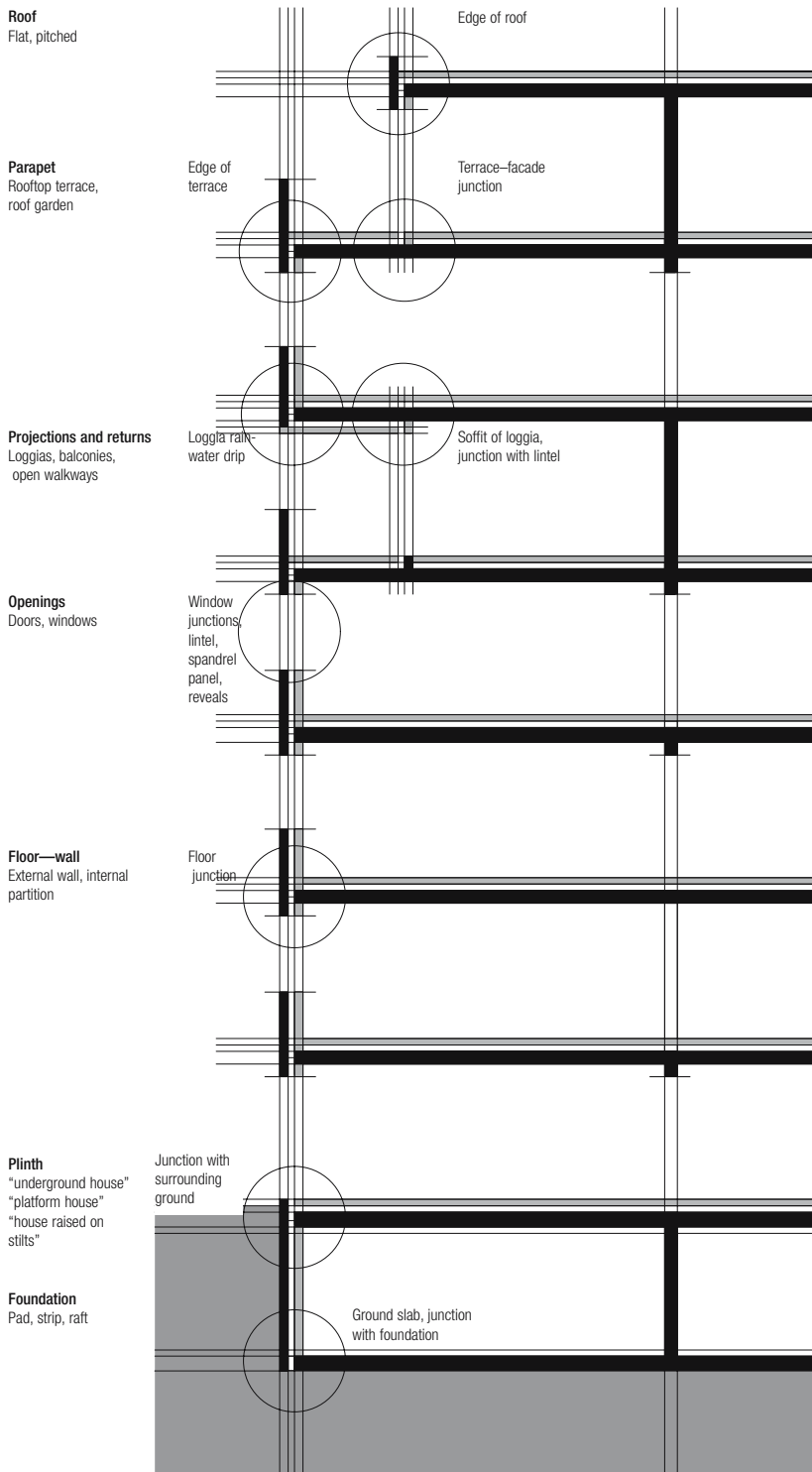
**Fig. 16: Case study: double-leaf masonry, wall-floor junction**

The protective layer is realised as a self-supporting masonry leaf, e.g. using clay or calcium silicate bricks, and partial tying back to the loadbearing layer is necessary owing to the instability of the non-loadbearing external leaf in the case of multistorey buildings. The use of double-leaf masonry results in the thickest wall construction.

## Insulation concepts

### Complementary systems – loadbearing layer outside

The “loadbearing layer outside” concept is used primarily on buildings with a fair-face concrete or facing masonry external facade, or those with a single interior space.

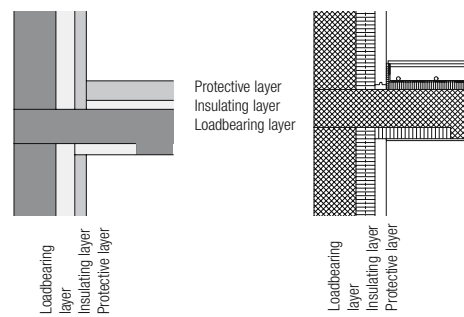


**Fig. 17: Diagram of layers, loadbearing layer outside**

The system chosen for the floor connections (with chromium steel anchors) makes possible an uninterrupted insulating layer. The circles designate the transitions where the different layers are joined; these key details must be resolved in detailed drawings.

The insulation in this case is on the inside. The transfer of loads from floors to the external loadbearing structure in multistorey buildings means that the insulation layer is interrupted at every floor. To reduce the ensuing thermal bridges the soffits of the intermediate floors have to be insulated for a distance of at least one metre around the perimeter. Combined thermal and impact sound insulation can be incorporated on the top of the floor. Fair-face concrete structures can also make use of corrosion-resistant chromium steel anchors which enable a structural connection between wall and edge of slab but also leave a cavity which can be filled with a compression-resistant insulating material. The continuity of the insulating layer is guaranteed here, but the (closely spaced) anchors do represent discrete thermal bridges.

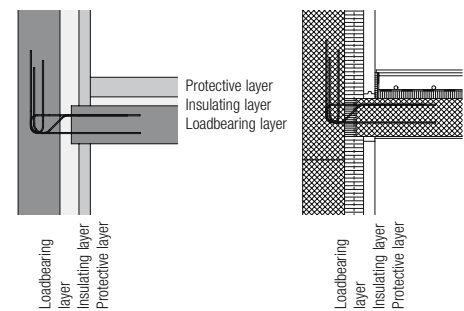
Owing to their “false vapour-tightness sequence” (most permeable layer on the inside, densest layer on the outside), constructions with internal insulation must include a vapour barrier on the inside of the thermal insulation in order to prevent condensation.



**Diagram of principle**

**Construction detail**

**Fig. 18: Case study: floor support not separated, discontinuous insulating layer**  
To compensate for the interruption in the insulating layer a strip of insulation at least 100 cm wide must be attached to the soffit around the perimeter (either laid in the formwork or fixed to the underside of the floor). Disadvantage: the soffit must be plastered or lined (“facing quality”). Combined impact sound/thermal insulation must be incorporated on top of the floor. The vertical loadbearing layer can be in concrete or masonry.



**Diagram of principle**

**Construction detail**

**Fig. 19: Case study: floor support separated, continuous insulating layer**  
This type of construction is only possible in reinforced concrete because the chromium steel anchors must be integrated into the wall and floor reinforcement. Compression-resistant insulation must be incorporated between the face of a wall and the edge of the floor. Such insulation is often included with the respective anchor system (e.g. Schöck-Isokorb).



## Seven rules for the design of a low-energy house

What are the key factors when planning a low-energy house? The following seven rules are intended to provide an overview and a guide.

### 1. Work according to a concept

The form, location, and interior layout of a building have a major influence on the energy consumption. Strive for clear, simple solutions. If you are not inventive by nature, assemble your house (intelligently) from inexpensive, readily available parts.

### 2. Plan a high degree of insulation...

The thermal insulation of a low-energy house is at least 20 cm thick. Depending on the type of construction, the complete external component can be between 25 and 60 cm thick in total.

### ... and avoid thermal bridges

The problem of thermal bridges occurs wherever the insulated building envelope is penetrated by components which allow the passage of heat from inside the building. Many buildings lose more heat via avoidable thermal bridges than over the entire uninterrupted wall. Transitions and junctions require special care:

- between window and wall, roof and other windows,
- between door and wall,
- between wall and roof,
- between roller shutter and wall,
- via shafts and flues at wall and roof,
- via thresholds, window sills, lintels at floor and wall,
- via fasteners, e.g. for balconies.

### 3. Exploit solar heat gains

Include large windows on the side facing the sun, provided their energy audit is positive. Adequate storage capacity is necessary in order to absorb the radiation. This means that a heavyweight form of construction is preferable for internal partitions and floors. Position permanently habitable rooms, e.g. living room, children's rooms, on the sunny side whenever possible.

### 4. Build airtight...

No house without convection safeguards! The occupants breathe, not the walls, nor the roof. Ensure airtightness and check the workmanship, particularly at troublesome details.

### ... and install mechanical ventilation

This will increase the quality of life in the house and reduce energy consumption because the heat losses can be recovered (heat exchanger). The ventilation plant must be carefully sized, and disturbing noise can be reduced with sound attenuation.

### 5. Cover the residual heating requirements with renewable energy media

Solar energy, wood, and ambient heat are ideal for low-energy houses because small installations (heat pumps, collectors) are adequate for low energy requirements, or only a small amount of fuel (wood) is necessary.

### 6. Store and distribute the heat with a low temperature level...

The lower the temperatures of the heating media, the smaller the losses; this applies to both the generation and the distribution of heat.

### ... install the heat storage media in the heated part of the house...

Every storage medium loses heat; this heat must be used in a low-energy house.

### ... and insist on short lines

In some low-energy houses the supply and return pipes (due to their large surface area) heat up more than the radiators being supplied. This can lead to problems in the regulation of the heating system and to unnecessary energy losses.

### 7. Use energy-saving household appliances

The use of energy-saving household appliances reduces emissions and environmental loads at the power station locations.

## Low-tech – high tectonics

Andrea Deplazes

### Camouflaged energy concept

One example for energy-saving construction within the costs framework of conventional building methods: What was originally intended as a conventional school design at the tender stage changed during the planning phase to a concept complying with the Swiss “Minergie” Standard. In doing so it was possible to avoid delegating the energy problem to the building services and instead to achieve a synthesis with the tectonics of the structure.

A visitor to the school in Vella would be unable to discover anything that could be deemed unusual in a school. The buildings employ a solid form of construction, with fair-face concrete walls internally and solid timber wall panelling for the classrooms and the sports and assembly halls. The buildings are enclosed in a layer of thermal insulation 12 cm thick, which in turn is protected by a layer of render about 3 cm thick – exactly as used in the traditional timber houses not far from the school, which are clad with a thin render “membrane”. The internal layout corresponds exactly with typical school requirements.

But upon closer inspection our attentive visitor would make a few discoveries: no radiators in the rooms, no centralised heating plant in the basement, no solar collectors anywhere in the building or on the roof! Instead, a mechanical ventilation system ensures a supply of fresh air with a low air change rate (0.5) and is intended to prevent uncontrolled ventilation losses (e.g. windows left open unintentionally). A heat exchanger has been installed downstream from this system to introduce waste heat from the exhaust air into the incoming fresh air. That is it, the only technical component in the school; this belongs to the – in architectural terms – less interesting part of the concept. More conspicuous are the ribbed concrete floors, the solid floor finishes of Vals quartzite stone slabs (also in the classrooms) and the large-format windows with their hopper-shaped reveals whose timber frames are screened externally by the thermal insulation. This is where the inconspicuous energy concept begins – with the use of passive solar energy.

### A technical problem?

Soon after beginning the planning it was discovered that the location of the new school would be really ideal for

exploiting solar energy. Although nothing of this kind had been allowed for in the budget, the local authorities approached us, the architects, with the wish to integrate solar collectors into the roof surfaces. (“However, it mustn’t cost more.”)

We were not impressed by the idea of the “badge of enlightened energy consciousness”, which all too often is placed conspicuously in the foreground. After all, the addition of technical equipment to the building would have disturbed not only the architectural surroundings of this mountain village with its splendid, archaic houses. To greater extent it disturbed our understanding of our role as architects – trying to combine diverse, often conflicting parameters in the design process – in that we would have to come to terms with an aesthetically successful integration of collectors into roof and other surfaces.

### A tectonics solution

We therefore developed the concept of storing the solar energy in solid components. The appealing notion here is that we can use the same wall thicknesses and floor depths as in a conventional design – provided that the components are of solid construction so that they can absorb the incoming solar radiation (through the windows) as quickly as possible and thus prevent overheating in the interior. However, as the walls in the classrooms would be needed for all sorts of blackboards, magnetic notice boards, cupboards and showcases, and hence would not be available as a storage medium, we opted for ribs on the absorption surfaces and the optimisation of the floor mass distribution in line with the recognition that the dynamic penetration of heat radiation into solid components is about 10 cm (primary storage). During periods of good weather lasting a few days in the winter the storage media can be continually charged (secondary storage).

### Multiple use strategy

This is coupled with additional, satisfying multiple uses. Provided with ribs, the floors easily span the 7.5 metres across the classrooms with little material consumption. At the same time, the profiled soffits create an extremely effective acoustic diffusion so that other acoustic measures (absorption) are unnecessary. Inexpensive energy-saving



Figs 20 and 21: School building and multipurpose hall (left), south facade with large area of glazing (right)  
Bearth & Deplazes: school complex, Vella (CH), 1997

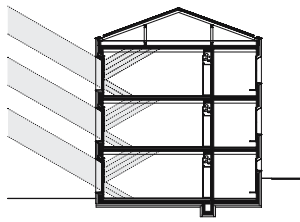


Fig. 22: Section through classroom wing

lights are easily installed between the ribs without creating any glare. And finally, the ribbed floors create a rich architectural motif which can certainly be regarded as a transformation of the Baroque ceilings in the aforementioned houses of this district. Just one last component was missing in order to redirect the maximum amount of solar radiation up to the soffit – light-redirecting louvres on the inside of the window panes.

But as specially designed light-redirecting systems would have been too expensive, we made use of conventional aluminium louvres which we threaded onto the operating cords and rotated 180°. These louvres are let down in winter just enough so that the pupils nearest the windows are not disturbed by the shallow, intense incoming sunlight, which is heightened by snow on the ground. However, the foremost one-third of the floor surface directly adjacent to the windows can still absorb heat and correspondingly “charge up” like a sheet of blotting paper across the depth of the room. The louvres can be rotated into position to reflect the sunlight over the heads of the pupils and up to the underside of the ribbed floor slab. This allows not only the heat absorption of the floor slab to be exploited to best effect, but also improves the natural lighting across the depth of the room, which in turn reduces the amount of electrical energy required for lighting. And the fact that in this position the louvres are still “open” and thus permit a view of the surrounding countryside should not be underestimated.



Fig. 23: Classroom with ribbed concrete soffit

Project: School complex with multi-purpose hall, Vella (CH)  
 Client: Local authority of Vella, Lugnez (CH)  
 Architects: Valentin Bearth, Andrea Deplazes, Chur  
 Energy concept: Andrea Rüedi, Chur  
 Building services: Nold + Padrun, Chur

#### Key parameters

Recommendations of SIA 380/1 “Energie im Hochbau”, 1988 edition; target value : 260 MJ/m<sup>2</sup>a

SIA brochure D 090 “Energiegerechte Schulbauten”;  
 standard target value: 150 MJ/m<sup>2</sup>a  
 optimised target value: 76 MJ/m<sup>2</sup>a

Value calculated for Vella according to “Handbuch der passiven Sonnenenergienutzung”, SIA/BEW document D 010: 24 MJ /m<sup>2</sup>a  
 Measured results for Vella (IBT diploma thesis 98/99): 34 MJ/m<sup>2</sup>a

The deviation of the measured energy consumption values from the calculated ones for the school complex in Vella lies within the tolerances of the method of calculation.

Storage capacity (reserve for poor weather):  
 During a period of poor weather lasting 4 days, an outside temperature of -5°C and decreasing solar gains the storage media discharges from an average 21°C to 19°C. At this point the descending temperature gradient intersects with the preheated (with the heat exchanger) air temperature curve of the mechanical ventilation system such that the value can be maintained. (Measured values from 12–15 Jan 1999, measurements taken in winter 1998/99)

#### Versatile concept

As a concept for the use of solar energy through storage in solid components such as floors and walls, which have to be constructed anyway, this method is not confined to schools. The multiple use strategy of components is the condition that must be fulfilled in order to remain competitive – in terms of price – with conventional methods of building. It could be the right time to switch from the modernistic understanding of complementary architectural systems comprising monofunctional individual parts to synthetic, complex, polyfunctional components. That is what we call holistic thinking. Only in this way can we achieve added value in economic, energy, and cultural terms “in one fell swoop”, which is nothing other than “sustainability”. The entire energy concept with solid storage media would have been architecturally meaningless for Vella if the necessary massiveness could not have been combined with the theme of plasticity and the “monolithic mass” of the building, in the play of the surfaces, interior depth, and thin-wall facade skin, both in the corporeal expression of the building and in the motifs of the detailing, and with the urbanistic structure of this mountain village and its powerful, cubic, stocky houses.

Excerpt from:  
*Bulletin, Magazin der Eidgenössischen Technischen Hochschule Zurich*,  
 issue No. 276, “Energie – im Umbruch”, January 2000, pp. 32–33.

# BUILDINGS

## Selected projects

Introduction

Structural issues  
– The relationship  
between interior  
structure, load-  
bearing structure  
and infrastructure

Examples

Apartment blocks,  
Martinsbergstr.,  
Baden: Burkard  
Meyer + Partner  
Gallery for  
Contemporary  
Art, Marktoberdorf:  
Beath + Deplazes  
Detached family  
home, Grabs:  
Peter Märkli  
Paspels School:  
Valerio Olgiati  
Volta School:  
Miller + Maranta  
Sihlhof School,  
Zurich:  
Giuliani + Hönger  
"Im Birch" School,  
Zurich:  
Peter Märkli  
Chur Teacher Training  
College, science  
wing:  
Beath + Deplazes  
Swiss School of  
Engineering for the  
Wood Industry, Biel:  
Meili + Peter  
Private house,  
Sevqein:  
Beath + Deplazes



## Structural issues

### The relationship between interior structure, loadbearing structure, and infrastructure

Alois Diethelm, Andrea Deplazes

Interior structures, loadbearing structures, and infrastructures are factors relevant to the design which, depending on the utilisation structure, influence each other to differing degrees, or activate various relationships. Whereas interior structure and loadbearing structure form a pair of concepts that can be applied just as well to the primitive hut as to a modern-day building, infrastructure – by which we mean fundamental facilities for the circulation of persons and media, but primarily in conjunction with building services – is meaningless for vernacular buildings because in the majority of pre-industrialisation buildings it existed only temporarily (e.g. in the form of an open fire) or not at all. Although, it is well known that the Romans already possessed highly developed supply structures such as underfloor heating and water pipes, these accomplishments remained virtually meaningless to everyday building work until the Industrial Revolution. From that time onwards they started to influence design more and more, owing to the mass production that became possible and also because of the drive to improve the poor hygienic conditions of 19th-century towns and cities.

From then on, client and architect were therefore confronted with defining the degree or scope of services and the associated usage. If the level of comfort demanded is low, an old building such as those built before the 20th century will still satisfy the needs of many different users. A conversion, if deemed necessary, is relatively simple because the service lines are seldom concealed in the walls or floors, and there are not many of them anyway. Bernoulli realised as early as 1942 that “in today’s new buildings it is precisely their systems, devised and installed for very specific situations, that must herald their downfall, must shorten their lives, because a complicated construction cannot be adapted to changing conditions as easily as a simple one.”<sup>1</sup> Since then services have multiplied to become an ever denser nerve system infiltrating virtually every building component. Modern buildings would be unthinkable without the tasks they perform. In some cases simplification may be possible, but essentially it must be accepted that contemporary buildings are complicated, according to Bernoulli’s definition. The question of adaptability no longer affects just the loadbearing structure, but also the infrastructure to an equal extent. And the fact that adaptability is desirable is proved again and again in practice – throughout the design phase. That was the reason behind the question posed by Marcel Meili recently in an interview. He asked how usage should materialise, “if there is no layout any more because the building afterwards is to appear on the investment market?”<sup>2</sup>

In the light of this, the structural issue should be investigated during three phases:

1. Prior to commencing work on site
2. After completion (short-, medium- or long-term)
3. During construction

#### Differentiated flexibility

We are not interested here in the *absolute flexibility* that fulfils every conceivable adaptation or conversion, but rather design strategies that withstand the conditions of economics-based practice and might supply answers to possible medium- or longer-term needs. This opinion is to some extent contrary to the mentality widespread in the present economic climate (in the building industry), a



Fig. 1: Loadbearing structure with potential for expansion  
Apartment block in the centre of Tirana (Albania), 2002

mentality that believes in keeping capital costs down in the knowledge that the follow-up costs after completion will have to be paid by somebody else. Of course, it is always a question of weighing up whether, when, and to what extent intervention is necessary; for the more time that elapses before the first intervention, the less significant is the easy adaptability of the building. This is precisely the situation when the building’s original function no longer applies, e.g. disused factories converted into housing, offices, schools, etc., where frequently everything apart from the loadbearing structure is torn down because all other components have become obsolete. Infrastructures become outdated after 30, 40, or 50 years; a facade no longer complies with the thermal insulation regulations, a previously harmless building material has proved in the meantime to constitute a health risk. Consequently, the only constant is the loadbearing structure. And its suitability for new uses depends on the degree of coupling with the interior structure.

If the interior layout must be flexible, it is usually necessary to create rooms, or room segments, of different sizes within the same utilisation. The connectable rooms (separated by sliding doors) in housing or the grid dimensions in offices are traditional. We are talking here about *flexibility of use*, which is relevant only after the building is completed.

On the other hand we have the *flexibility of planning*, which is based on the fact that certain components, e.g. vertical circulation, are declared as immovable from the very start, whereas other parts, which once construction starts are equally permanent, can still be influenced at the outset – up to a certain point of no return; e.g. in housebuilding the sizes of wet rooms and, very occasionally, their positions. If the internal partitions are loadbearing, the interior structure that can still be influenced at best is subjected to a floor span defined as economic and openings in the facade. Burkard Meyer & Partner exploited most of the flexibility of planning options in their apartment blocks on Martinsbergstrasse in Baden (1998/99). The plan layout is based on a loadbearing facade and a central access core, while the remaining internal configuration, which included bathrooms and kitchens, could be determined by the buyers of the individual apartments.

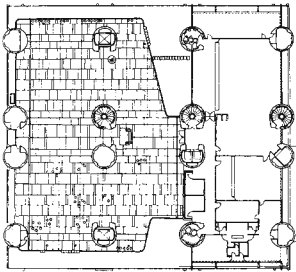


Fig. 2: Columns with space for toilets, stairs, etc.  
Kenzo Tange: communications centre, Kofu (J), 1964–67

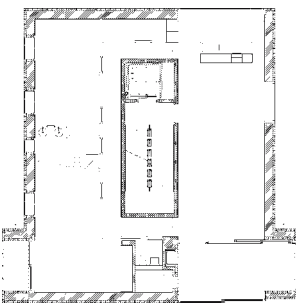


Fig. 3: Only the location of the staircase was established prior to starting work on site.  
Burkard, Meyer: apartment blocks, Martinsbergstrasse, Baden (CH), 1998/99



Fig. 4: Flexibility in planning: the position of the windows was determined by the buyers of the apartments.  
Burkard, Meyer: apartment blocks, Martinsbergstrasse, Baden (CH) 1998/99

It was unusual that even the positions and sizes of the storey-high windows could be influenced by the buyers. However, once work had started on site, the flexibility in the unsold apartments was reduced drastically because the plan layouts had been more or less fully configured by the positioning of openings and locating of building



Fig. 5: Loadbearing structure and infrastructure combined in shafts  
Kenzo Tange: communications centre, Kofu (J), 1964–67

services, i.e. the sanitary installations. The immovability of services is due to the senseless casting-in of the pipes, which is still customary, especially in housebuilding. This reduces the options for adjustments during construction and makes replacement difficult when the system has served its useful life, not to mention any changes of use.

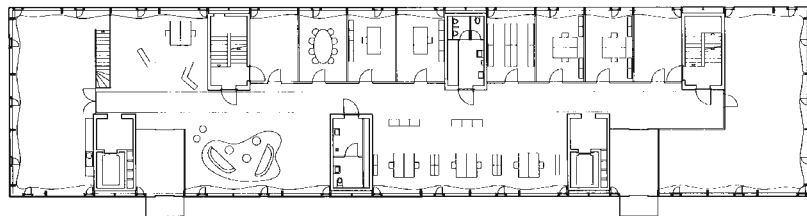
#### Hollow columns – slender floors

Assuming that we wish to convert a multi-occupancy block into a guest-house or hotel, this raises a number of questions. The existing horizontal circulation within the apartments, possibly only a vague notion, has to be changed to a corridor and form a separate fire compartment. The denser occupancy may well call for additional escape stairs, and the increased number of decentralised wet rooms questions the feasibility of a central service core. Structuralists like Kenzo Tange have tried to find answers to such questions by coupling the vertical infrastructure (services, stairs, lifts) with the inevitable loadbearing structure. The slender columns of traditional column-and-floor systems are transformed into shafts. The predecessors of multifunctional building components can be seen in the industrial buildings of the late 19th century, where vertical lines were routed between pairs of columns.

A similar effect can be seen in the grouping of flues along the fire walls of the multistorey apartment blocks of the 19th and early 20th centuries. The decentralised arrangement of the flues minimises the horizontal service components or, at the very least, renders them superfluous. Relieved of horizontal services, the constructional properties of the floors have to satisfy only loadbearing and sound insulation requirements. Prior to the introduction of reinforced concrete slabs and the possibility of casting services inside these, the exclusively vertical routing was the most obvious (in housebuilding).

Although the structuralists were trying to achieve the opposite, even Tange determined the uses to a certain extent because the apparently neutral shafts accommodated first a lift, then stairs and finally also wet rooms and ventilation ducts. In other words: the structure is no longer 100% flexible, even though this might seem to be the

case at first glance. The plan layout is, on the one hand, dependent on the existence of the appropriate infrastructure components at the desired locations; on the other, the physical cores form a framework to the plan layout that no longer extends from facade to facade but rather stakes out individual internal bays between the cores. But if every core contains stairs, lifts, wet rooms and service shafts, this obviously leads to a system with an “overdesigned”



**Fig. 6: Column-free plan layout with loadbearing facade and cores (lifts, wet rooms or stairs)**  
Bearth & Deplazes: ÖKK offices, Landquart (CH), 2001/02

infrastructure and a building whose flexibility is substantially reduced because of the larger cores.

For example, in Tange's building (see fig. 5) – like the ÖKK offices in Landquart (CH) by Bearth & Deplazes – there is no hierarchy among the cores. They form compartments in which the infrastructure uses, e.g. toilets, face inwards. The opposite approach employs a continuous vertical shaft that is only just large enough to accommodate the necessary pipes, cables, and ducts. The shaft forms the starting point – or the backbone – for the development of the plan layout, which might be different on every floor. It is interesting to note that when asking the question “Centralised vertical services plus intensive horizontal distribution, or decentralised vertical services with less horizontal distribution?” vertical access by means of stairs and lifts is not affected because the location and number of these vertical circulation routes are defined by the maximum permissible distance to a means of escape, i.e. by fire regulations.

#### Slender columns – hollow floors

The outcome of a more or less dense network of continuous vertical components – be they parts of the infrastructure or loadbearing structure – is that uses that call for different interior structures from storey to storey are feasible only when such interior structures are based on a small format. In the opposite direction, pipe runs, ventilation ducts, and columns restrict the usability of the interior spaces.

Therefore, essentially unrestricted planning of individual storeys presupposes a centralised vertical infrastructure from where the local horizontal distribution takes place in cavity floors, suspended ceilings, or within the depth of the floor construction. The point at which at least two service lines cross, e.g. a cable duct and a ven-

tilation duct, determines the overall depth of such hollow spaces. Besides aspects such as easier accessibility for installation and maintenance, it is precisely the intention of avoiding the crossing of services that has led to the simultaneous use of cavity floor plus suspended ceiling.

Combined with a reinforced concrete floor slab, such constructions can reach a total depth of 70–80 cm; however, only 25–30 cm of this is required for loadbearing purposes. This is a waste of potential because the individual layers of the separate functional parts of the floor do not benefit from each other. It would be possible to double the structural depth while retaining the same overall depth by using a “hollow” loadbearing system in steel, concrete or timber, e.g. the MINI, MIDI and MAXI systems of Fritz Haller. This would in turn result in larger spans and, consequently, more flexible utilisation configurations. Whereas in the past the crossing of service lines alone determined the depth of the hollow space, the falls of waste-water pipes is just as important, if not more so. This is particularly relevant when there are different numbers of wet rooms at different locations on the individual floors. The larger hollow spaces of such structures have a positive effect on the horizontal distribution of services.

In Louis Kahn's Salk Institute the floors to the laboratories themselves became accessible for maintenance and upgrading of the numerous installations. The Vierendeel girders, wall plates without openings, and reinforced concrete floors form a rigid hollow box that spans the rooms below without the need for intermediate columns. Service floors are also not unknown in high-rise buildings (e.g. PSFS Building, 1932, Howe & Lescaze) in order to reduce the transport distances for treated media (air and water).

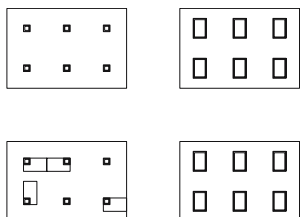


**Fig. 10: Services in the plane of the loadbearing structure**  
Fritz Haller: SBB Löwenberg Training Centre, Murten (CH), 1980–82

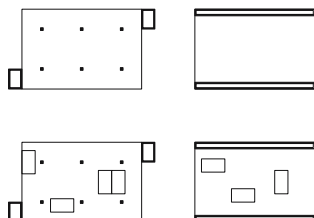
Louis Parnes' design for a department store has several storey-high, long-span floors housing not only services but also storerooms for the respective sales areas above.



**Fig. 7: Grouping versus decentralisation**  
Schemes with stove and bathroom combined in the centre of the house (left: short service lines), and a decentralised layout (right: many service lines)



**Fig. 8: Hollow columns – slender floor slabs**  
Schemes showing loadbearing structure (top) and interior fitting-out (bottom); the wet rooms are linked to the loadbearing structure containing the services.



**Fig. 9: Slender columns – hollow floors**  
Schemes showing loadbearing structure (top) and interior fitting-out (bottom); the wet rooms are positioned independently of the loadbearing structure. Multistorey circulation is via perimeter shafts which can also function as vertical loadbearing elements, (see also figs 24–27).



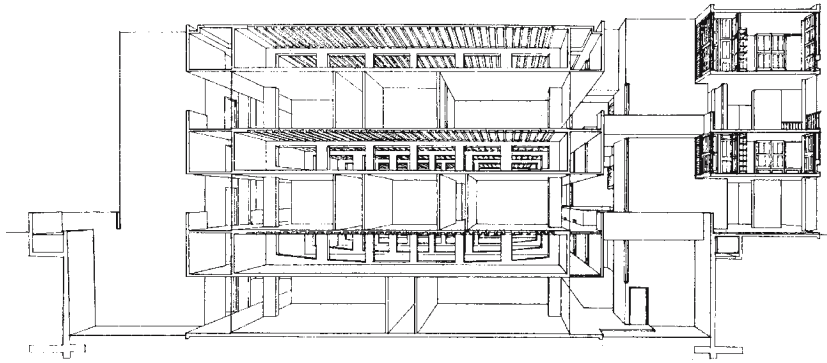


Fig. 11: Storey-high floors to accommodate services  
Louis I. Kahn: Salk Institute, La Jolla (California, USA), 1959–65

### Comfort and technology

Human shelter is essentially designed to provide protection from the weather and other persons or animals. In many regions of the world protection against cold weather is a key issue. The open fire is the most primitive form for meeting this requirement, its very nature uniting the generation and output of heat at the same place. The stove and the oven make use of this principle, either singly as the only source of heat in the centre of the house, or distributed among several rooms. The unlimited autonomy that the functional unit of heat generation plus output suggests is spoiled by the associated, vertical flues (the situation is different with sources of heat that do not produce exhaust gases, e.g. electric fires). The flue conveys the smoke and exhaust gases and in multistorey buildings brings warmth to adjoining rooms as well. Another line of development began with the Roman *hypocaust* hot-air heating system in which the fire providing the heat is located outside the room to be heated because an open fireplace was regarded as dangerous. The hot air is fed via a sort of cavity floor to flues built into or in front of

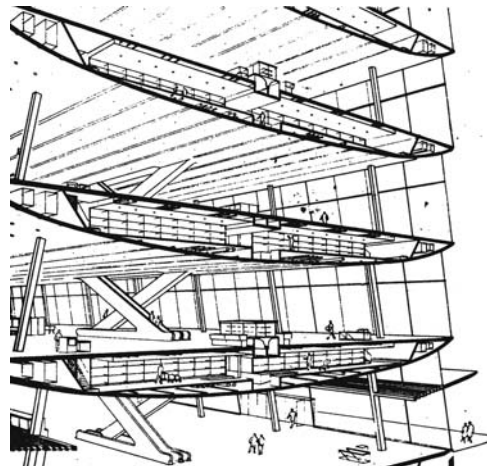


Fig. 12: Storey-high floors as storerooms for the respective sales areas above  
Louis Parnes: department store project, c. 1947

the inner faces of the walls. This ensured that floor and walls were heated equally. It anticipates central heating and underfloor heating in one system and the principle of supplying heat to the places where the heat is lost most readily. In addition, as a form of pure radiant heating, the heat provided by the *hypocaust* system is more efficient than modern radiators or convectors and also does not suffer from dust-disturbing convection currents. (For a contemporary reinterpretation of the *hypocaust* system see the description of the Gallery for Contemporary Art in Marktoberdorf by Bearth + Deplazes, 2000.)

Rayner Banham saw the technical possibilities of heating rooms or individual components directly as the basic principle for implementing the new interior layout concepts of Modernism.<sup>3</sup> The critical aspect of reduced comfort due to large windows could now be compensated for by the heating. Banham cites the north-facing windows of the draughting rooms at Mackintosh's School of Art in Glasgow (1896–99) as an example. For Frank Lloyd Wright the hot-water heating system with a central heat source and decentralised distribution presented the chance to realise more complex volumes: "This enabled the form of the various parts of the building to be devel-

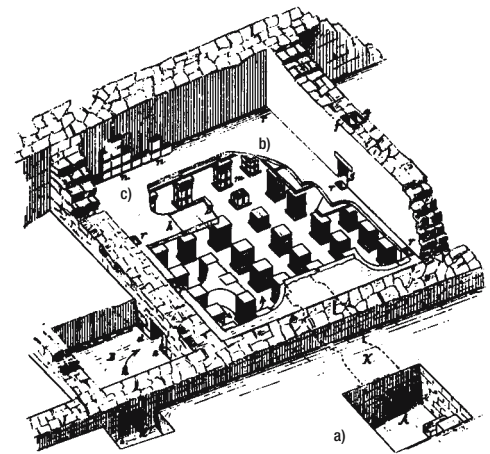


Fig. 13: Roman *hypocaust* heating system  
a) fireplace outside the building, b) cavity floor, c) flues (*tubuli*)

oped more fully, they would gain light and air from several sides."<sup>4</sup> Building services – whether in terms of heating in winter or cooling in summer – could now be called upon to compensate for the poor insulating properties of the building materials, i.e. the glass. This situation continued until the oil crisis of the 1970s and growing environmental awareness in the 1980s led to investigations into how the use of technical systems could be reduced through materials technology. Although insulating glass coated with heat-absorbing film and noble gas in the cavity had been



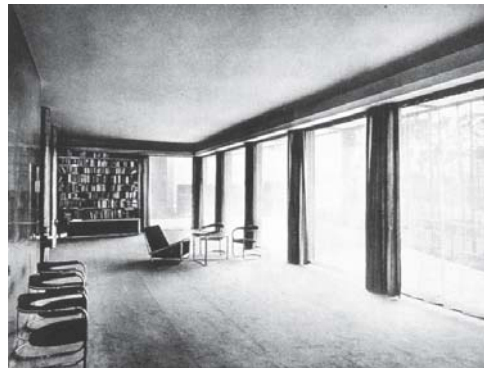
known since the 1950s, it has undergone a phenomenal development since then and glass is now no longer seen as a synonym for high energy losses.

The growing use of central heating in the first half of the 20th century meant that the necessary infrastructure, for heat distribution or heat output, was being added to or integrated into building components more and more. Whereas up until that time the established services in housing had been restricted to the sanitary facilities in individual ancillary rooms, building services now started to appear all over the house. The way in which architects handled this new challenge varied from the pragmatic approach of routing the services in full view, to the opposite approach in which all pipes and radiators were concealed behind some form of screen or cladding. Yet another approach was employed by those architects who saw the technical heating components as a configuration option – whether in the form of special featuring (colour, arrangement, etc.) or through combining with other functions (balustrade).

For Bruno Taut the unpretentiously positioned, but coloured, radiators and pipes represented contrasting elements in a polychromatism that encompassed the whole interior. The heating in the Kenwin Villa in Veney (1929) by



**Fig. 14: Undesirable building services: the reality with radiators!**  
Hans and Wassili Luckhardt: house on Rupenhorn, Berlin (D), 1928



**Fig. 15: Undesirable building services: photo with radiators discreetly erased!**  
Hans and Wassili Luckhardt: house on Rupenhorn, Berlin (D), 1928

Hermann Henselmann was in the form of several parallel pipes imitating the course of the long horizontal window above and thus became a horizontal, profiled surface. But in a house in the Kundmannngasse in Vienna (1928) by Ludwig Wittgenstein hidden underfloor heating was specified for the non-private rooms on the ground floor and air ducts fed from the cellar in front of the French windows. According to Christoph Bürkle two photographs of the interior of the house on Ruppenhorn in Berlin (1928) by the Luckhardt brothers testify to the fact that architects sometimes regard radiators as a nuisance; in the photograph used for publication the radiators have been discreetly erased.

Over the years, to relieve the interior of technical components convectors, mounted in the floor to guarantee un-



**Fig. 16: Heating pipes grouped to form a surface**  
Alexander Ferenczy, Hermann Henselmann: Kenwin Villa, Vevey (CH), 1929

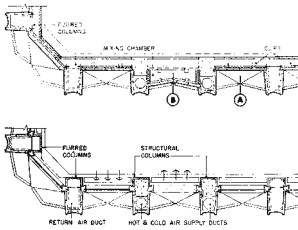


**Fig. 17: Underfloor heating plus hot-air ducts supplied from the cellar (in front of French windows)**  
Ludwig Wittgenstein: house in Kundmannngasse, Vienna (A), 1928

restricted transparency, started to replace radiators more and more. This unrestricted transparency also applies to ceiling and floor heating systems in which the invisible pipes no longer have to be clad but are instead encased in concrete and cement screed respectively. It is interesting that underfloor heating seems to suggest an evenly distributed heating surface indifferent to types of use, but in practice the spacing of the pipes plus their positioning in individual zones is just as dependent on the actual interior layout as a heating system employing discrete radiators. For instance, the number of heating pipes in the floor is increased, i.e. their spacing is reduced, local to storey-high windows, and deep rooms are divided into zones with their own temperature controls depending on the different amounts of incident solar radiation.

#### The facade as an infrastructure medium

Up until the beginning of the 1960s building services held really little significance for the design of the facade and, at best, could be made out behind a more or less transparent glass curtain wall because until then the services were all on the inside. However, from that point on they started to assume a more active role in the configuration of the facade. In the buildings of the Brutalism movement solid, usually concrete, shafts surround groups of pipes, cables, and ducts, and combined with stairs and other



**Figs 18, 19, 20:**  
**Top:** every third "column" is non-loadbearing  
**Centre:** section through spandrel panel  
**Bottom:** section through window  
 Paul Rudolph, with Anderson, Beckwith & Haible:  
 Blue Cross Building, Boston (Mass., USA), 1958

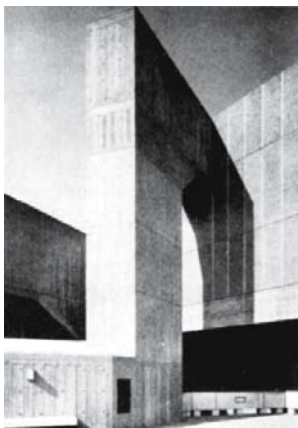
"use-related" bulges add relief to the building envelope. In a reverse approach, exponents of high-tech architecture – and prior to this the Metabolists – created their aesthetic out of the fact that services remained on view or essential functional units were granted autonomy. However, components on the outside must inevitably penetrate the climate boundary, and in the light of the higher standards of thermal insulation now required, external services hardly find favour any more.

Between these two extremes – building services as a styling element on the one hand and invisible necessity on the other (whose common denominator is the unmistakable separation from the loadbearing structure) – there exist concepts in which there is an amalgamation between loadbearing structure, building services and interior fitting-out elements in a multifunctional arrangement. A good example is the Blue Cross Building in Boston (1958) by Paul Rudolph in association with Anderson, Beckwith & Haible. This 13-storey office block in the centre of Boston is based on a loadbearing facade whose facing leaf of vertical columns at a spacing of 1.53 m appears to reflect the loadbearing structure. However, the "columns" that are "missing" at ground floor level, are non-loadbearing. Every third column is therefore hollow and the entire cross-section is used as an exhaust-air duct. Even the neighbouring loadbearing columns are not quite what they seem because half of the depth of each column is reserved for a fresh-air duct. And as the spandrel panels function as mixing chambers the ventilation system therefore spreads like a net over the entire facade – a principal that is not dissimilar to that of the exposed services of high-tech architecture. However, the difference is that the lines of the services coincide with the loadbearing structure and the interior structure. The air duct in the



**Fig. 23: Amalgamation of loadbearing structure and vertical service ducts**  
 Paul Rudolph, with Anderson, Beckwith & Haible: Blue Cross Building, Boston (Mass., USA), 1958

form of a column can therefore accommodate junctions with internal partitions, likewise window frames. The visible facade relief is made up of precast concrete elements just a few centimetres thick which appear as cladding owing to the type of jointing. Whereas this type of cladding represents an improvement to the surface of the (Swiss) lattice facade of the 1950s, applied directly to the substrate, on Rudolph's building it forms a hollow backdrop. How-



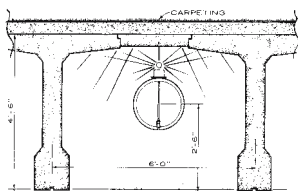
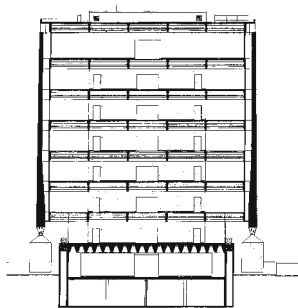
**Fig. 21: Sculpted services shaft, in materials to match the facade**  
 Greater London Council, Hubert Bennett: Queen Elizabeth Hall, London (GB), 1966



**Fig. 22: Exposed infrastructure as the characterising motif**  
 Renzo Piano & Richard Rogers: Centre Pompidou, Paris (F), 1971–78



Fig. 27: Floor slab without intervening columns, with ventilation ducts and lighting units between the ribs  
SOM: American Republic Insurance Company, Des Moines (Iowa, USA), 1965



Figs 24, 25, 26:  
Top: facade without openings as loadbearing plate containing services  
Centre: ground and basement floors as an autonomous block  
Bottom: section through floor, scale approx. 1:60  
SOM: American Republic Insurance Company, Des Moines (Iowa, USA), 1965

ever, we must ask whether concrete is the right material because the cranks in the spandrel panels are reminiscent of the stiffening folds of sheet metal panels.

On the Blue Cross Building loadbearing structure, building services and windows form a network that is identical on all sides of the building. However, the functions are separated on the building for the American Republic Insurance Company in Des Moines by Skidmore Owings & Merrill (1965): services housed in loadbearing concrete plates without openings on the longitudinal sides, storey-high glazing on the ends of the building. The topic of hollow loadbearing construction, which is characteristic of the facade, is repeated in the floor, where 1.36 m deep concrete T-beams span 30 m across the whole building without any intermediate supports. These beams form a box-like relief with the air ducts accommodated between the stalks of the Ts. Mounted on top of the circular air ducts are fluorescent lights that use the underside of the ribbed floor as a reflector. In addition to their function as an infrastructure medium, the wall plates (without openings) are designed as deep beams spanning between four columns at the base. In section the building looks like a bridge spanning a two-storey object slipped underneath – the fully glazed cafeteria and refectory block free from all loadbearing members. This addresses the change in structure that affects every larger building owing to the different interior needs of ground floor and upper floors.

### Structural change

Even monofunctional buildings often provide for a different usage at ground floor level, above all in city-centre locations. The reasons are obvious: the direct relationship with public spaces favours profit-making uses such as shops, restaurants, etc., and the location level with the surrounding ground means that the ground floor is even accessible to vehicles (cf. fire station, Zurich). In Germany the cast iron columns on the ground floor that support the downstand beams of joist floors in buildings from the

late 19th century are especially classical. This is a type of structural change that is hardly noticeable. But the situation is totally different in a building with a transfer structure which tracks the change in the loadbearing members with expressive force. The high-rise block “Zur Palme” in Zurich by Haefeli Moser Steiger (1961-64) is a good example. The windmill-plan shape of this tower is carried on a concrete platform 12 m above the ground supported on wedge-shaped columns – space enough for an independent two-storey structure underneath.

Lina Bo Bardi took a different course at the Museum of Modern Art (1957-68) in São Paulo, where the storeys are not elevated above ground level, but instead suspended. At least the enclosing concrete frame, with its span of 50 m, conveys this picture. In fact there is another pair of beams within the glass building, so that only the bottommost floor is really suspended. In any case, the whole area beneath the building remains open, in the form of a covered plaza.

Buildings like the school in Volta by Miller & Maranta prove that a structural change is possible without displaying the structural conditions. The in situ reinforced concrete loadbearing structure devised in conjunction with the consulting engineers Conzett Bronzini Gartmann makes use of wall plates on the upper floors that are rigidly connected to the floor slabs. This arrangement functions as a monolithic construction spanning the full 28 m across the sports hall, and cantilevers a further 12 m on the entrance elevation. The wall plates, which incidentally are not continuous from facade to facade but instead consist of two separate parts, line up on all the floors of the school. Jürg Conzett explained in an article that it is sufficient “when the wall plates [above one

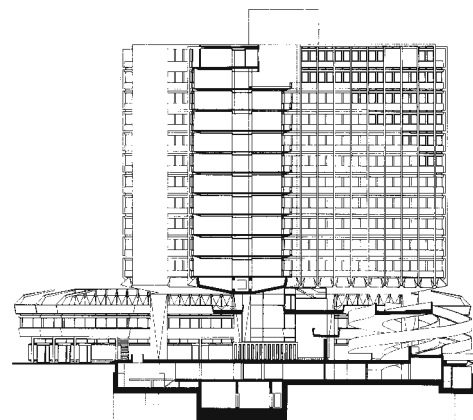
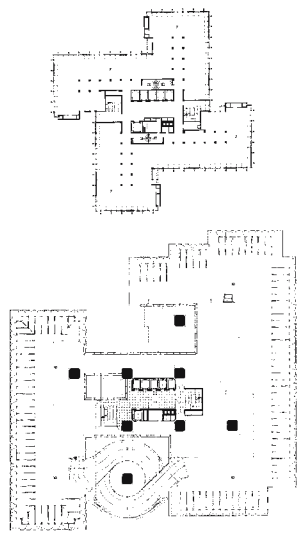


Fig. 28: High- and low-rise buildings, each with its own loadbearing structure  
Haefeli Moser Steiger: “Zur Palme” Tower, Zurich (CH), 1961-64

another] make contact at any one point”.<sup>5</sup> Consequently, this principle permits different interior structures from storey to storey, which in the case of the school in Volta is only consummated when supplemented with non-loadbearing





**Figs 29, 30, 31:**  
At parking level (bottom) massive columns trace the windmill-plan shape of the upper floors (centre); general view of building (top).  
Haefeli Moser Steiger: "Zur Palme" Tower, Zurich (CH), 1961–64

#### References

- <sup>1</sup> Hans Bernoulli: "Vom Altwerden der Häuser"; in: *Die organische Erneuerung unserer Städte*, Basel, 1942; cit. in Fredi Kölliker (ed.): *Zahn der Zeit – Baukonstruktion im Kontext des architektonischen Entwerfens*, Basel, 1994.
- <sup>2</sup> Marcel Meili: "Dinglichkeit und Idee", Marcel Meili in conversation with Hubertus Adam, J. Christoph Bürkle and Judit Solt; in: *archithese* 2003/1, p. 7.
- <sup>3</sup> Rayner Banham, "Die Architektur der wohltemperierten Umwelt", in: *ARCH+*, Feb 1988, p. 36.
- <sup>4</sup> Frank L. Wright, 1910; cit. in: Rayner Banham, p. 43.
- <sup>5</sup> Jürg Conzett, "Raum halten"; in: *Werk, Bauen und Wohnen*, 1997/9, pp. 34–39.

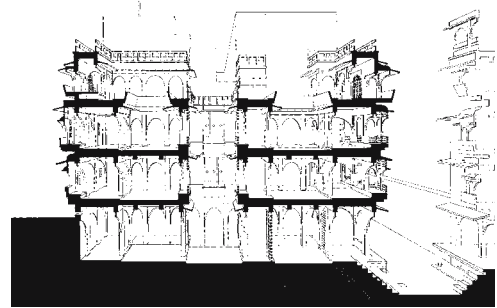
walls. It might be exciting to investigate at which phase (prior to beginning work on site, during construction, or after completion) which degree of flexibility can be achieved with this system.

#### Alternatives

At the start it was said that the complexity of contemporary buildings has to be accepted. But this is only partly true of course. More and more intelligent low-tech concepts are appearing, particularly in the realm of building services, concepts that are based on centuries-old knowledge and are "only" coming to the fore again or being reinterpreted. The stack effect (thermal currents), which is being exploited these days in order to achieve a natural change of air, e.g. in office buildings, was already common for cooling buildings in India in the 15th century, accomplished by means of internal courtyards and an open ground floor. People exploited the physical effects provided by the building elements and spaces that were unavoidable. So building services in traditional buildings is not an appendage rich in technology, but rather an integral part of the interior structure and loadbearing structure. And last but not least, the "air shaft" provides the obvious additional function of allowing light to reach the adjoining rooms!



**Fig. 33: Frame with suspended floors**  
Lina Bo Bardi: Museum of Modern Art, São Paulo (BR), 1957–68



**Fig. 34: Exploiting the stack effect: fresh air flows through the open ground floor and rises in the internal courtyard.**  
House, Jaisalmer (India), 15th century



**Fig. 32: Only the positioning of the windows provides evidence of the structural change.**  
Miller & Maranta: Volta School, Basel (CH), 1999



Example

## Apartment blocks, Martinsbergstrasse, Baden

Urs Burkard, Adrian Meyer + Partner

Alois Diethelm

### Situation, theme

This development occupies the south-east corner of the Merker district, a former industrial site in the centre of Baden. The three separate blocks, two of which were built in the first phase of the project, reflect the style of the detached houses along the Martinsbergstrasse, which date from the early 20th century.

The main entrance on Martinsbergstrasse is via a small forecourt enclosed by concrete walls and hedges. In keeping with the urban situation, the private external areas are covered in gravel and screened off from the public road by walls. The road at the rear gives access to the garages and also to the "Merker" meadow, an open recreational area which, like the two apartment blocks, forms part of the development plan for the whole area.

Whereas the buildings appear to be solitary when viewed from the south side, the lower ground level on the north side exposes the basement and reveals the fact that the buildings are part of the same unit. The sequence of open car parking areas below the blocks and closed garages between forms a sort of chequer effect as they alternate with the buildings and intervening open spaces above. Although there is a variation of material (fair-face concrete and facing brickwork) in the basement parking level and the apartments above, continuity between them is maintained.

Architects: Burkard, Meyer, Baden  
 Construction period: 1998–1999  
 Project managers: Roger Casagrande  
 Alois Diethelm  
 Structural engineers: Minikus Witta Voss, Zurich

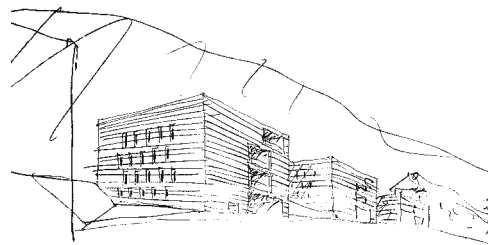


Fig. 36: Stark volumes in an urban context  
 Sketch

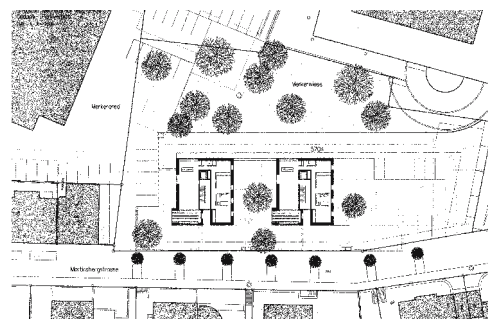


Fig. 37: Situation without third block  
 Point-blocks on the opposite side



Fig. 35: View from the "Merker" meadow  
 The difference in levels reveals the basement.

### Layout and loadbearing structure

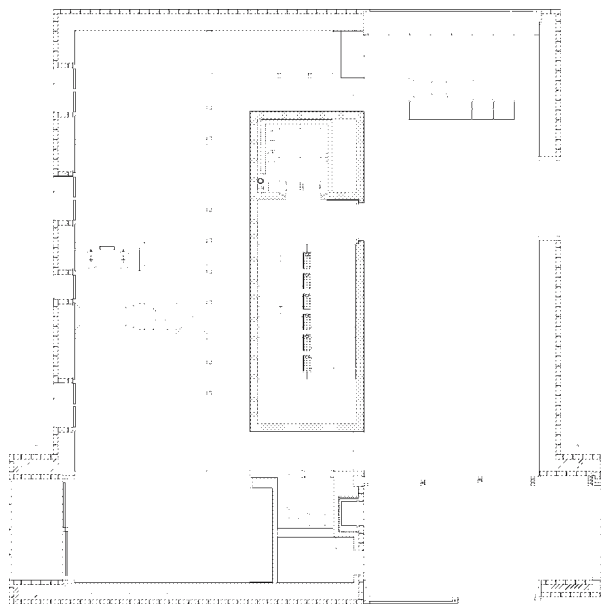
With the exception of block A, where the topmost apartment occupies one-and-a-half storeys, each block contains four apartments, one on each floor, organised around a central access core. This core divides each apartment into two areas: a bedroom wing with a ceiling height of 2.46 m, and a living/dining wing with ceiling heights up to 3.06 m. This latter wing, which spans across the full depth of the building from facade to facade, changes from one side of the core to the other on every floor. This enables the lower ceiling height of the group of rooms above or below to be exploited. This "stacking" principle is visible in the facade by way of the staggered floor slab edges.

The living room opens out onto a veranda. Although this is not heated, it is fitted with double glazing on the facade. This creates a buffer zone which can be opened up virtually over its full area in the summer.

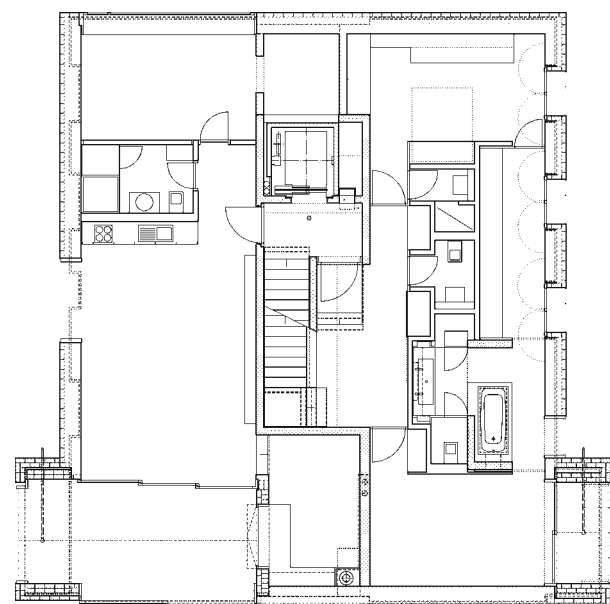
The masonry of the facade and the concrete access core, together with the in situ reinforced concrete floors, form the loadbearing structure. The remaining walls are non-loadbearing plasterboard on timber studding.



**Fig. 40: Wooden model**  
Shows the different ceiling heights and how the apartments are "stacked".



**Fig. 38: Plan of 1st floor**  
The living room extends from one facade to the other.



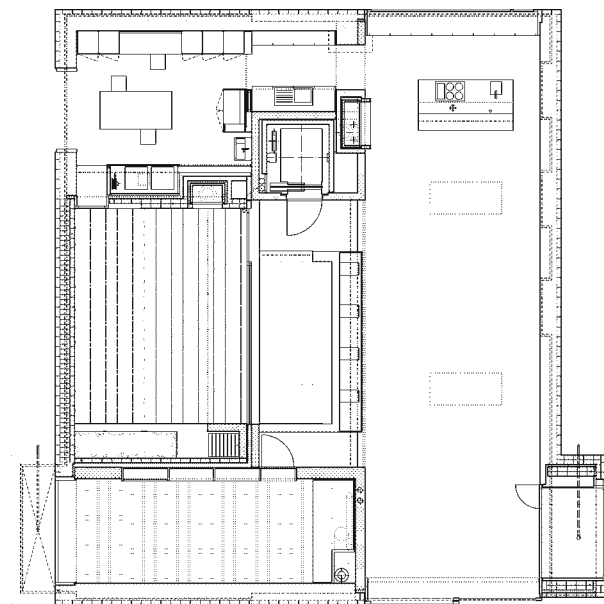
**Fig. 39: Plan of 2nd floor**  
The small apartment and the penthouse share the 2nd floor.



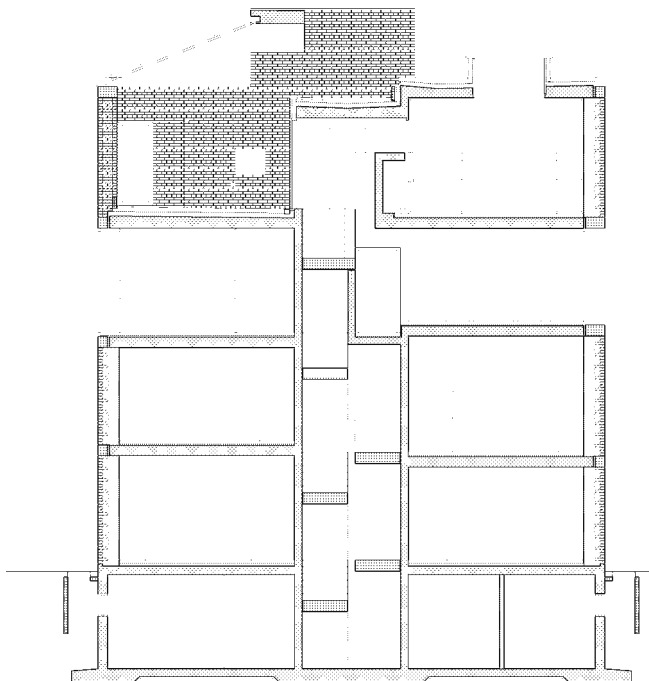
**Fig. 41: Penthouse**  
View towards kitchen; interior lit by rooftop terrace and rooflights.



**Fig. 42: Penthouse**  
Multimedia furniture serves as room divider; the rooftop terrace can be seen in the background.



**Fig. 43: Plan of 3rd floor**  
Living room without veranda



**Fig. 44: Section**  
Showing rooftop terrace to penthouse

### Openings and loadbearing structure

Some of the openings are intrinsic to the layout and others may be located to suit the owners' requirements. What both have in common is that they span between the edges of the floor slabs.

Openings of the former type are to be found on the north and south elevations, forming extensions to the living rooms. Their interaction reflects the principle of the mirrored plan layouts. With a span of about 4.60 m, however, they are on the limit of feasibility because the adjoining Optitherm masonry, which owing to its porosity has a lower compressive strength than normal brickwork, can only just carry the loads that arise.

On the other hand, the east and west elevations are characterised by the storey-by-storey alternation between "frameless" windows flush with the facade and French windows set in deep reveals. Spanning between the floor slabs, these openings turn the masonry into shear walls which, owing to the fact that the floor slab edge elements distribute the loads, stand virtually separately from the sections of wall above and below. From a design point of view this meant that the position of the windows could in fact remain variable right up to shortly before work started on site.



Fig. 45: External view of block A  
The garden wall along Martinsbergstrasse can be seen in the foreground.

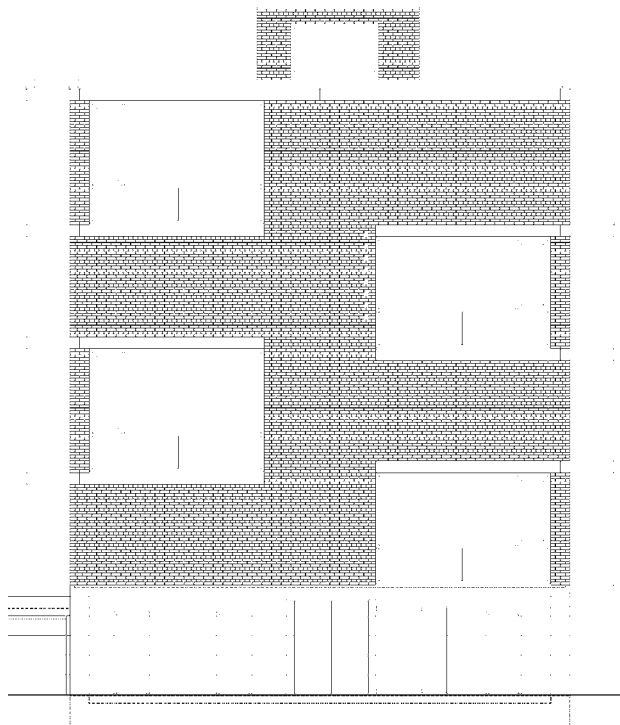


Fig. 46: North elevation

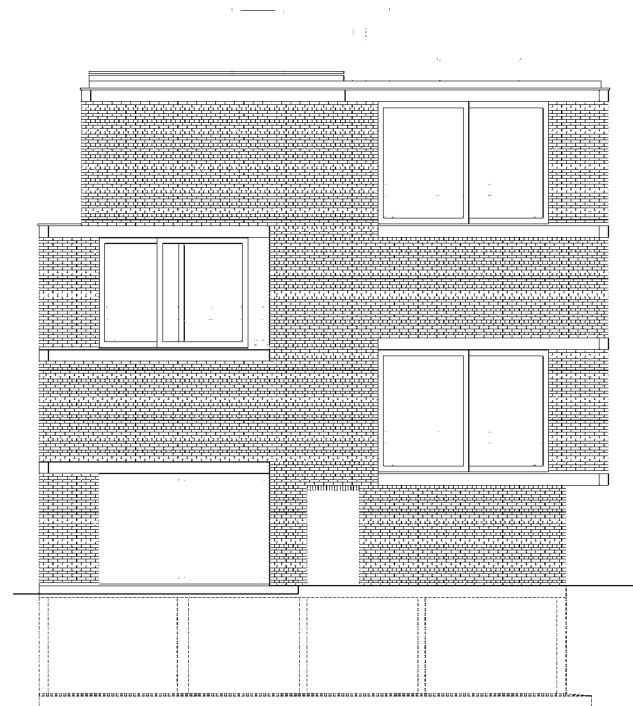


Fig. 47: South elevation





Fig. 48: Ground floor wall at the position of the window flush with the outside face  
The masonry bond can be clearly seen.

### Design and realisation I

The brickwork of the facades is based on the combination of Optitherm and Kelesto masonry developed by the architects and first used on Brühl School in Gebenstorf.

The walls are made up of 400 mm thick Optitherm units (insulating bricks) in a masonry bond plus 120 mm Kelesto units (facing bricks fired below the sinter point). The two leaves of masonry, which are built simultaneously, are connected at every fourth course by means of a row of headers to form an inseparable bond. The wall requires no further insulation (U-value 0.38 W/m<sup>2</sup>K). No insulation is inserted into the voids that are created between the bricks.

Besides the advantages for the interior climate that result from such an inert wall construction (phase shift effect), this design also benefits from the fact that – in contrast to conventional facing masonry in a twin-leaf arrangement and cavity insulation – the interlacing of the courses means that expansion joints are unnecessary. The sculpted appearance of the building (no interruptions at the corners and in the middle of the elevations) is primarily due to this component.

The facing masonry and the type of joints were chosen based on performance criteria. According to these, it is important to guarantee the migration of the vapour diffusion but also to protect against driving rain. The mortar joints on the outside face were therefore compacted with an electric vibrator as the wall was built because any water penetrating the joints cannot be drained away as there is no ventilated cavity as such. Joints simply struck with a trowel would have been inconceivable. Likewise, facing bricks with a high vapour diffusion resis-

tance would have been unsuitable because the backing of Optitherm bricks is open to diffusion; a hard-fired facing brick would have been too dense.

In terms of its elasticity, Optitherm masonry is regarded as moderately soft. For internal plastering work this means that it is not possible to use a pure cement plaster. Instead, a lime-diluted undercoat (hydraulic lime plus cement) or a lightweight undercoat must be used. The Optitherm bricks themselves are normally used in conjunction with a lightweight mortar, which exhibits better thermal insulation properties owing to the expanded clay-sand content but has a lower loadbearing capacity. Their use together with facing masonry, where a lightweight mortar would be unsuitable because of the high water infiltration, meant that for both the Optitherm and the Kelesto units a facing-grade mortar was used throughout in order to create the same structural relationships for both types of masonry.

During construction great care had to be exercised by all involved to ensure that the masonry was kept dry because the highly porous Optitherm bricks (thermal insulation) quickly absorb any water. The upshot of this is that any moisture present migrates outwards during the first heating period and in doing so liberates lime from the bricks, which appears on the surface in the form of efflorescence. However, this is quickly washed away by the rain.

Another building by Urs Burkard Adrian Meyer & Partner employs similar masonry but with impregnated Kelesto bricks. The idea behind the impregnation is to prevent the efflorescence.

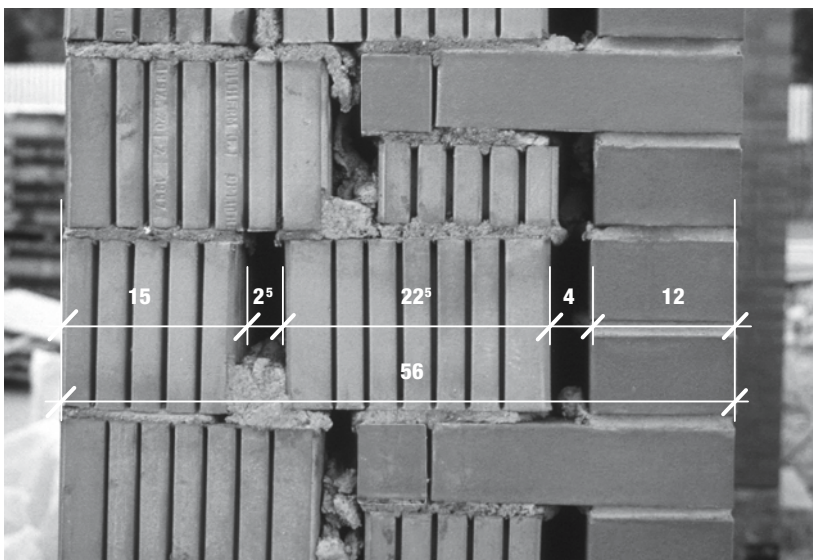
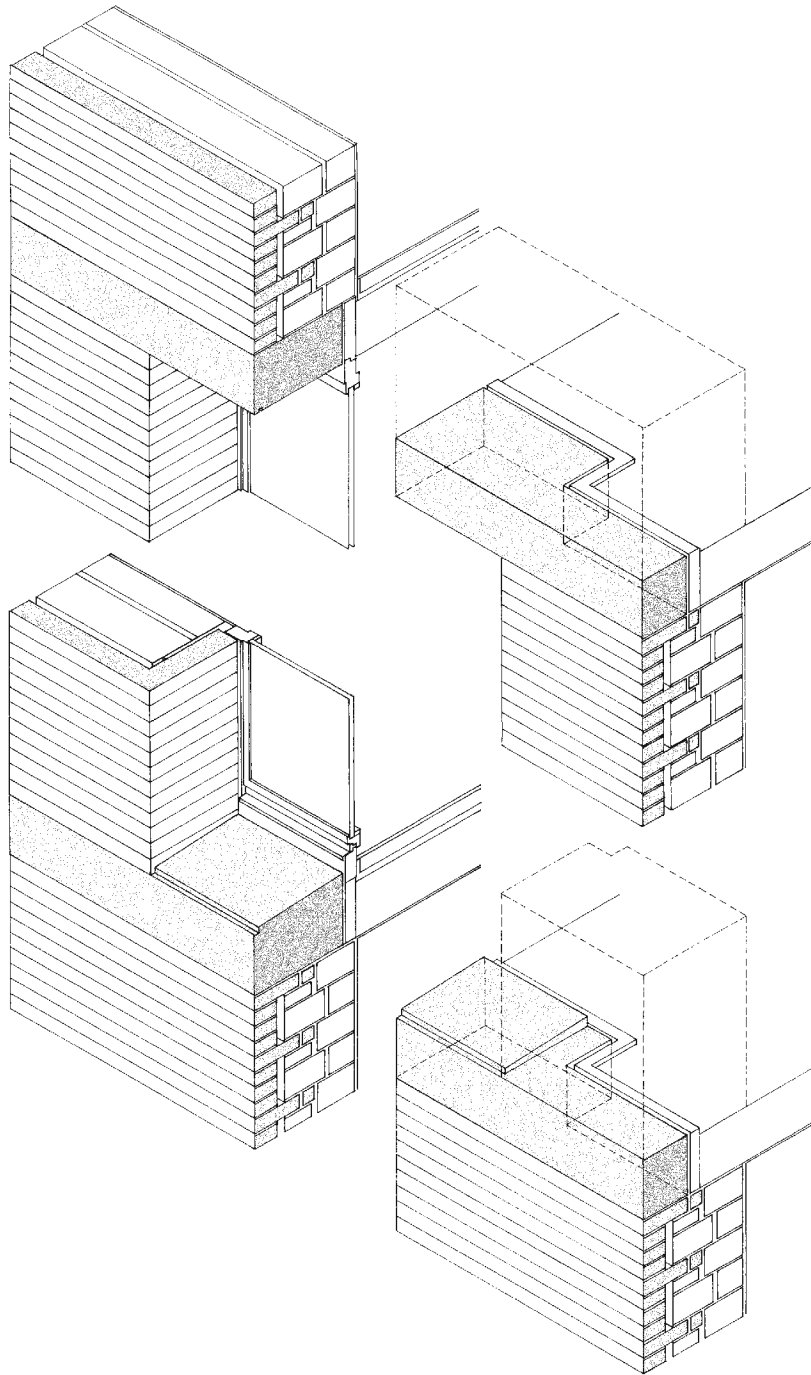


Fig. 49: Close-up of masonry  
Combination of Optitherm and Kelesto facing masonry

**Design and realisation II**

The edges of the floor slabs, which characterise the appearance of the facades, consist of prefabricated concrete elements which, in the standard case, are supported on the outer half of the masonry cross-section. This means that the cross-section at the French windows, which open inwards, is doubled because of the formation of a lintel plus sill.



**Fig. 50: Axonometric view**  
"Thickening" of slab edge elements adjacent to window

Although these bands offer almost unlimited freedom for positioning openings during the design phase, the opposite is true during the construction phase. The desire to create complete concrete soffits or lintels throughout the thickness of the masonry had the effect of limiting the repetition of elements because of the unrestricted positioning. Prefabrication was therefore chosen because it produces a better surface finish and not because it achieves rational construction.

The contractor used the concrete elements as permanent formwork which, owing to its relatively high "self-weight", did not require any further fixings. A 10 mm cavity between the strip of extruded polystyrene insulation along the edge of the slab and the concrete elements guarantees that floor slab and elements can move independently. Gypsum boards act as spacers during placing of the concrete and are later removed.

Polyethylene film both above and below the concrete elements separates them from the masonry so that both materials can move independently. Accordingly, the joints are sealed with putty.



**Fig. 51: Close-up of formwork**  
The slab edge elements act as a permanent formwork; gypsum boards provide a space for the insulation.



**Fig. 52: 1st floor slab**  
The returns in the slab edge elements indicate the positions of the French windows.

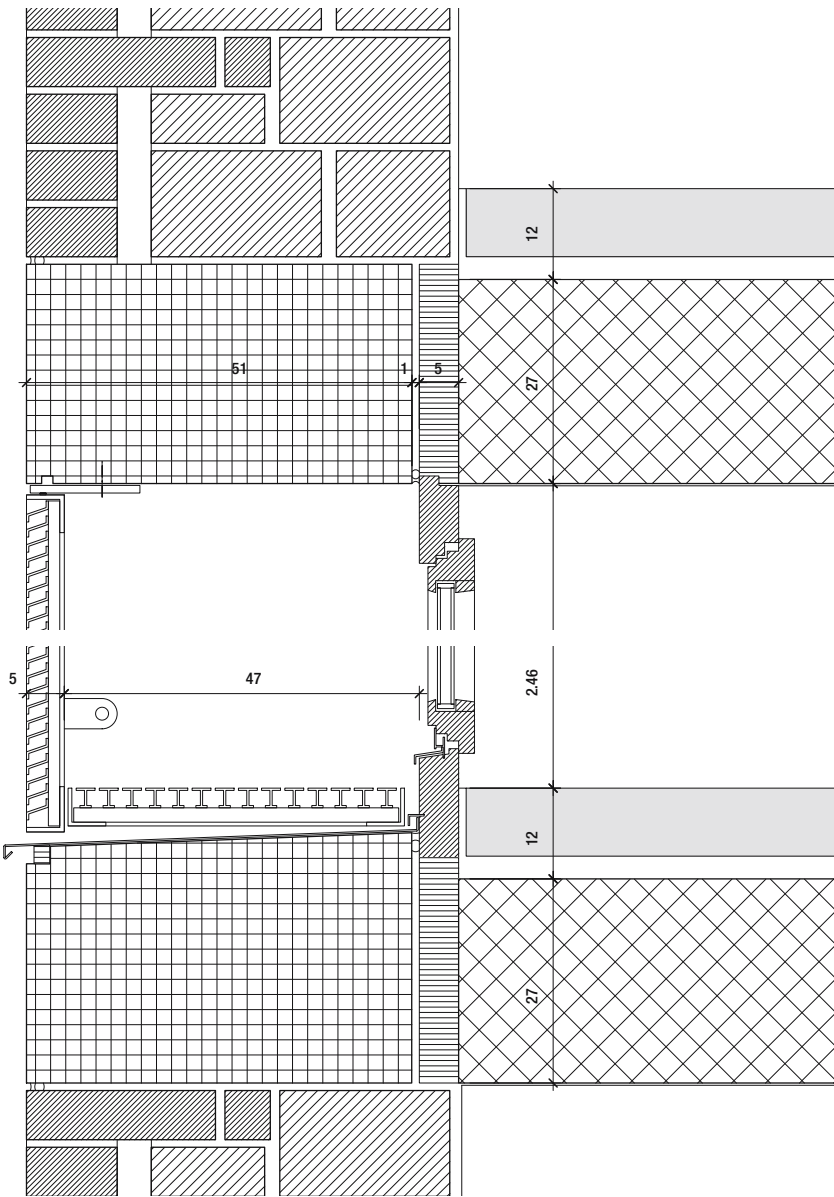


Fig. 53: Section, 1:10

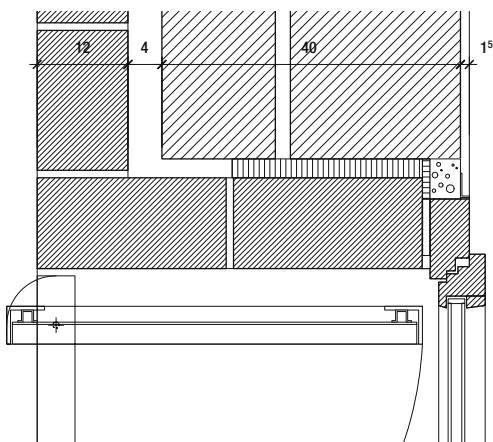


Fig. 54: Plan, 1:10

**Design and realisation – the French window**

The window opens inwards and is a simple painted wood version because of its less exposed position. The lower section of the external anodised aluminium weatherproof screen, fitted flush with the facade, serves as a balustrade; the upper section guarantees privacy by means of two shutters which pivot inwards. The space between screen and window therefore becomes – like the veranda – a transition zone, useful as a balcony for smokers but also as a rainproof area for airing clothes. The position of the shutters changes the expression of the facade from an absolute plain one without any relief to a more sculpted one exposing the full depth of the masonry.

The construction of the reveals in Kelesto bricks, which have a considerably poorer insulation value than the Optitherm masonry, and attaching the window frames to these bricks meant that it was necessary to include a strip of extruded polystyrene insulation between the Optitherm and Kelesto units.

**Slab edges**

- Prefabricated concrete element, 500 x 290/340 mm
- Anodised aluminium sill, d = 3 mm, bonded to smooth-finish concrete element; turned up at junction with reveal masonry
- Aluminium open-grid flooring laid in stove-enamelled steel frame; finished level with apartment floor



Fig. 55: Close-up of French window  
Weatherproof screen acts as balustrade and shutter.

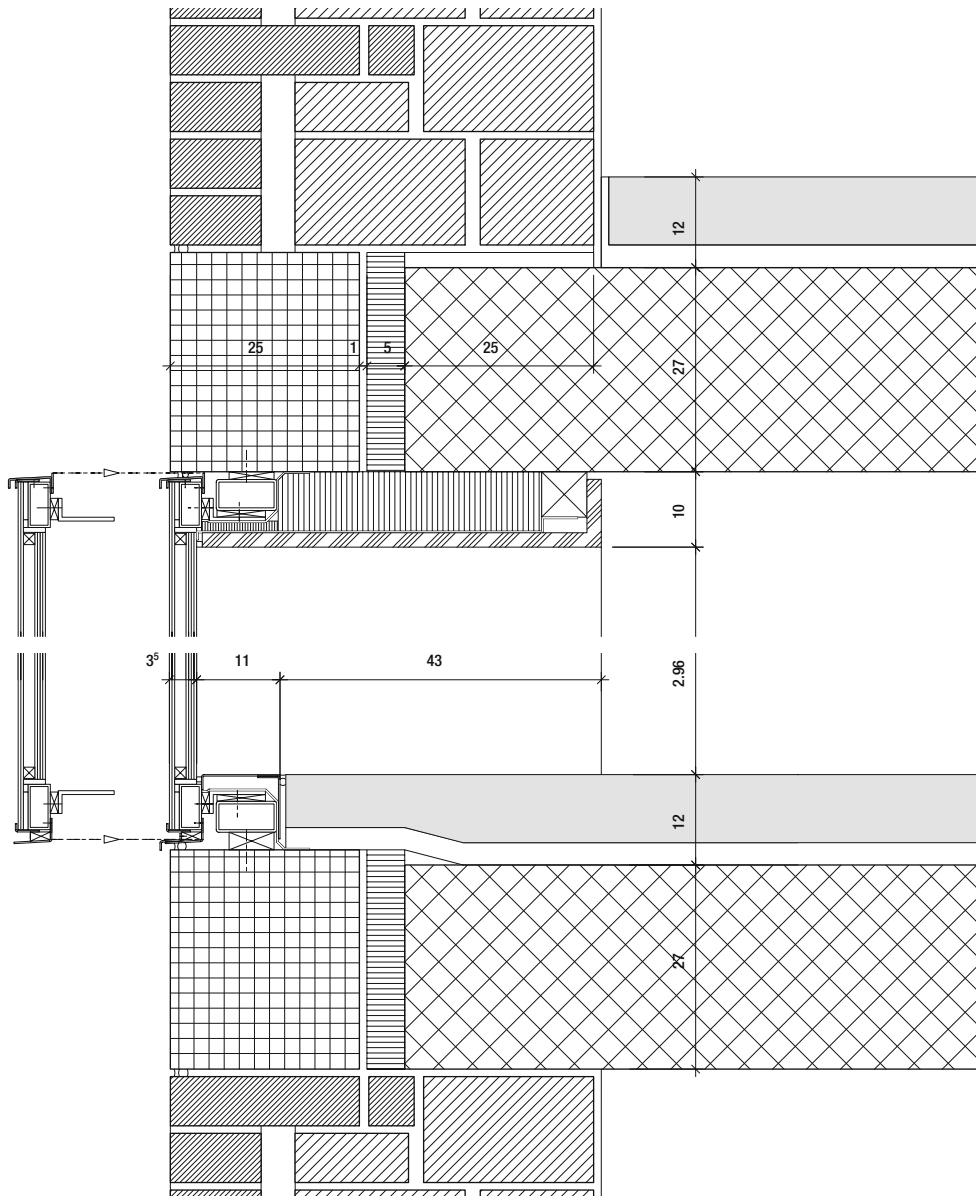


Fig. 56: Section, 1:10

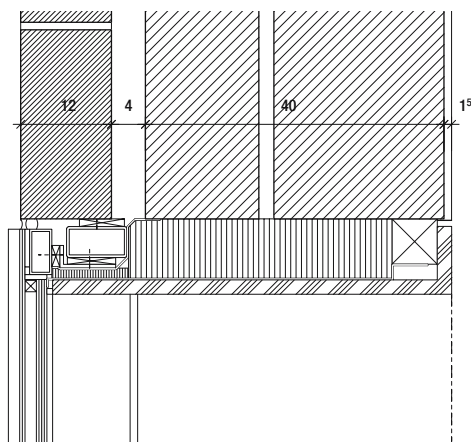


Fig. 57: Plan, 1:10

**Design and realisation –  
the “frameless” window**

The window, fitted flush with the facade, enables the full depth of the masonry to be appreciated from the inside and gives the matt but, owing to the brickwork bond, strongly textured facade a highly abstract highlight. This effect is accentuated by the use of stepped insulating glass which gives the impression of a window without a frame.

To create a safety barrier, the inner pane is of laminated safety glass; a separate balustrade, which would have lessened the effect of the direct transition to the outside world, is therefore unnecessary.

The linings to reveals and lintel conceal both the supporting framework for the window and the insulation.



Fig. 58: View of “frameless” window from inside  
The reveals enable the thickness of the masonry to be appreciated.

**Window element**

- Stepped insulating glass bonded to aluminium frame (prefabricated structural sealant glazing)
- Glazing beads top and bottom serve as additional mechanical fixings
- Window element fitted into steel frame installed beforehand

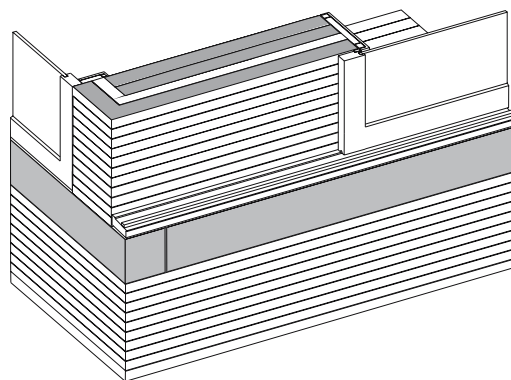


**Design and realisation – the sliding window**

The two leaves of the window, which owing to its exposed position is a wood/metal composite design, slide in front of the masonry and enable the window to be opened to virtually its full width. The veranda, which in spring, autumn and winter also serves as a climate buffer zone, therefore becomes a proper balcony.

Unlike conventional sliding windows, there is no rectangular frame here; in other words, the window has been reduced to guide tracks top and bottom. This lends the facade relief at these points thanks to the juxtaposition of window and masonry within the depth, a relief that would otherwise only be possible by varying the building envelope.

The reduction of the wall thickness by the width of the guide track, and the desire to have walls in facing masonry on the inside of the veranda as well, led to the use of a twin-leaf masonry arrangement locally.



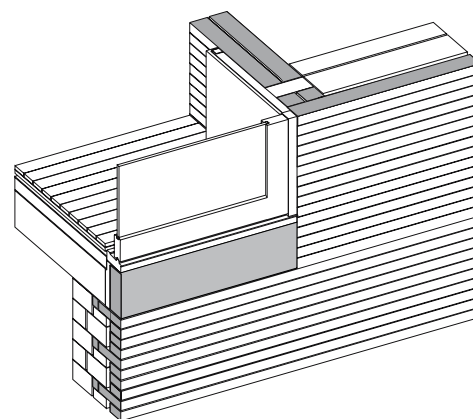
**Fig. 59: Axonometric view of sliding window**  
Wall behind sliding window built as twin-leaf masonry, otherwise combination masonry

**Floor construction, studio**

Floor covering	10 mm
Cement screed	80 mm
Impact sound insulation	30 mm
Polyurethane thermal insulation	50 mm
Concrete slab	240 mm

**Edge of slab**

Prefabricated concrete element	120 x 290 mm
OMEGA anchors	
Extruded polystyrene slab edge insulation	50 mm



**Fig. 60: Floor construction, veranda**

Wooden grid (Douglas fir)	27 mm
Rubber mat bonded to insulation underneath (for stability)	
Extruded polystyrene thermal insulation	80 mm
2 layers of bitumen roofing felt	
Concrete slab laid to falls	220–240 mm



**Fig. 61: Ground floor veranda**  
The sliding doors opening onto the veranda lend depth to the facade.



**Fig. 62: Veranda**  
Unheated intermediate zone acts as extension to living room and also as balcony.

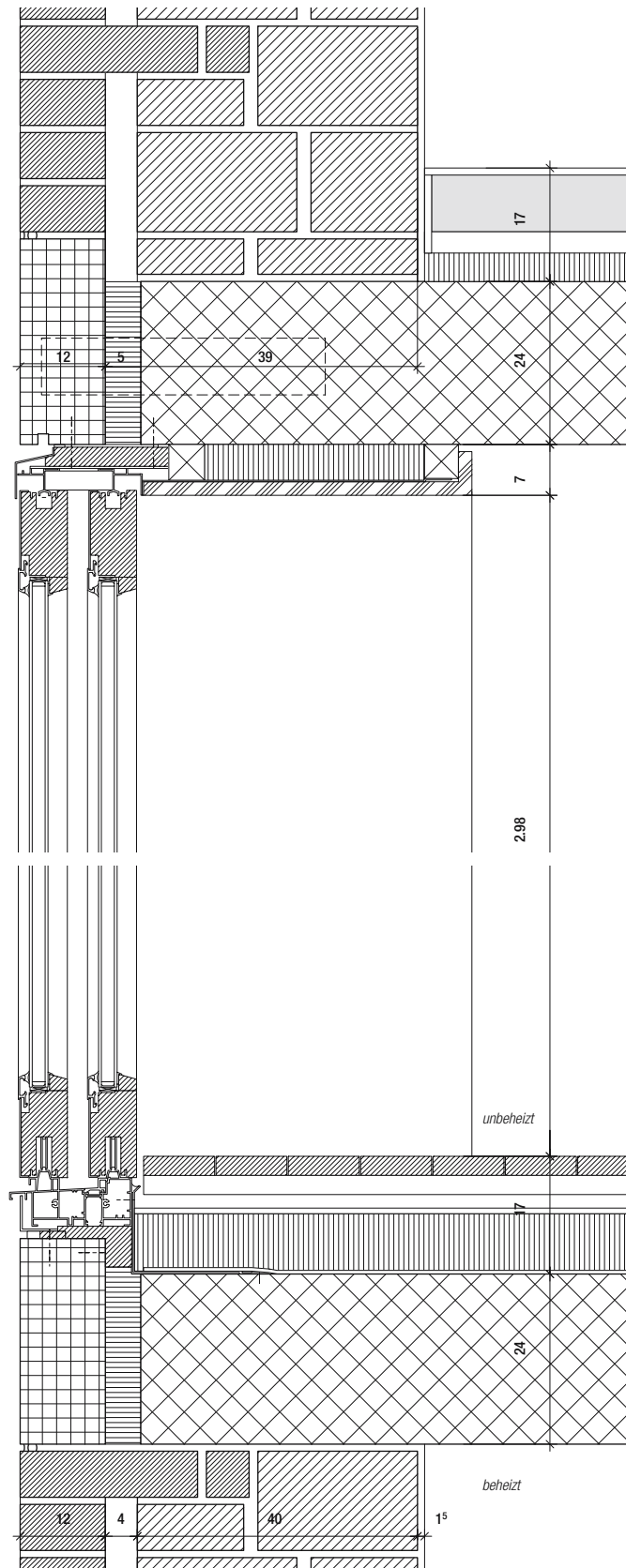


Fig. 63: Section, 1:10  
At the sliding windows the slab edge elements are fixed with OMEGA anchors.

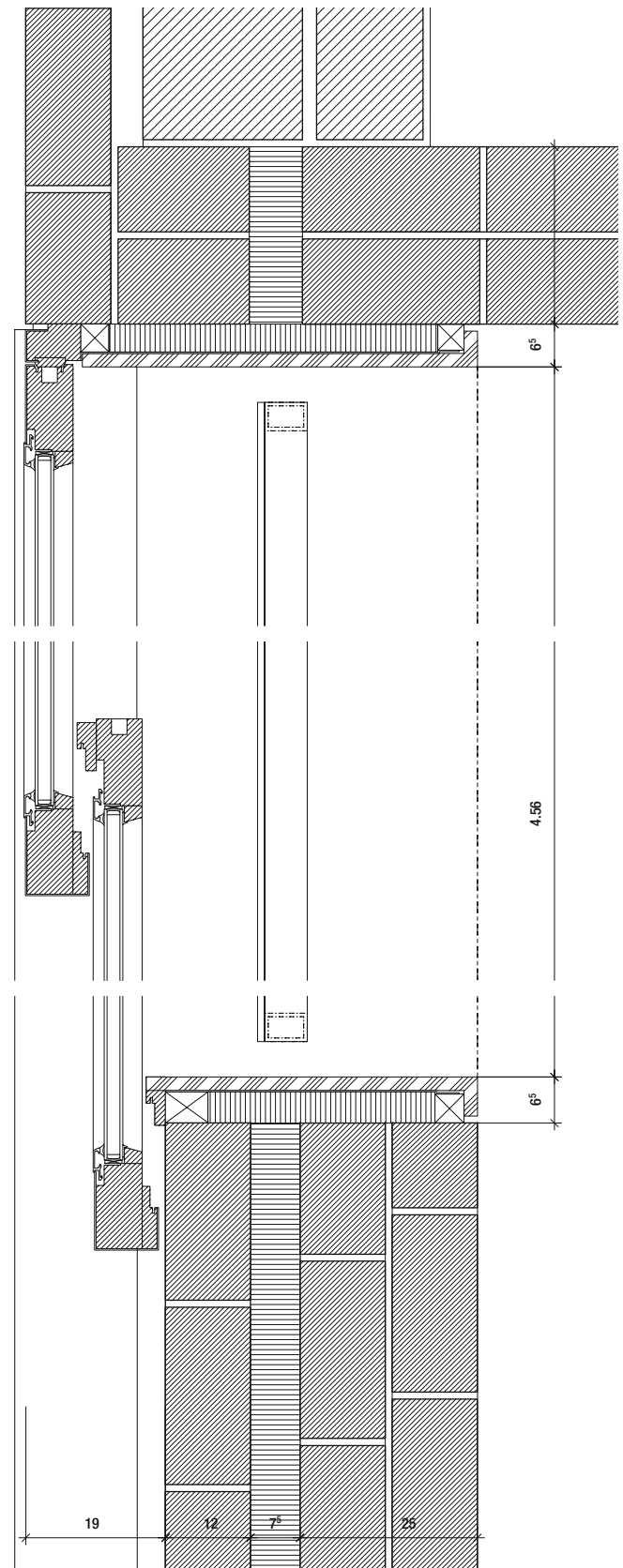


Fig. 64: Plan, 1:10  
The windows are fitted without a true rectangular frame.

## Gallery for Contemporary Art, Marktoberdorf

Bearth + Deplazes

*Katharina Stehrenberger*



Fig. 65: View from north side

### Situation and theme

Positioned between the town hall and private villas that date from the 1920s, the art gallery of the Dr Geiger Foundation stands in the centre of Marktoberdorf in Germany's Allgäu region. Its multifunctional qualities make it equally ideal for special exhibitions, the presentation of the Foundation's own collection or for use as a studio. This detached building nicely integrates into the environment of individual buildings so typical of Marktoberdorf. However, its stark cubic form also distinguishes it from the surrounding houses. The composition with the existing Foundation building maintains the internal logic while achieving optimum utilisation within the plot. What appears to be an empty forecourt – a quadrangle enclosed by walls – within the complex is in fact a space for exhibiting sculptures; it thus forms a pivotal point and hence a central element. The two brickwork cubes forming the structure are of different heights and slightly offset sideways. Each measures 10 x 10 m on plan. The special feature is the compactness of the building envelope made from red-brown, flush-pointed hard-fired facing bricks. With facing brickwork also used on the inside, this art gallery takes on a sort of workshop-like character and expresses the idea of a "living" gallery whose purpose – just for once – is not to act as a neutral room housing works of art.

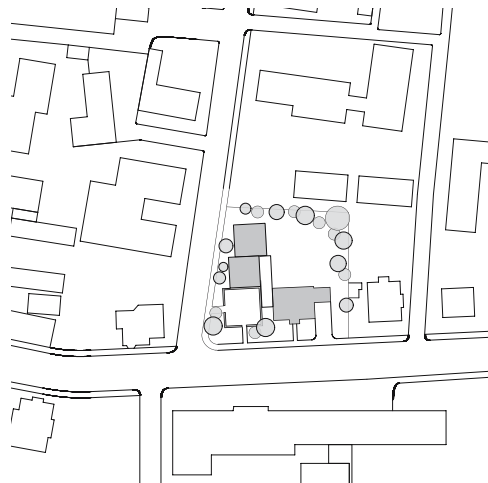


Fig. 67: Site plan, 1:2500



Fig. 68: Main entrance with forecourt

Architects: Bearth + Deplazes, Chur  
 Construction period: 1998–2000  
 Project manager: Bettina Werner  
 Structural engineer: Jürg Buchli, Haldenstein

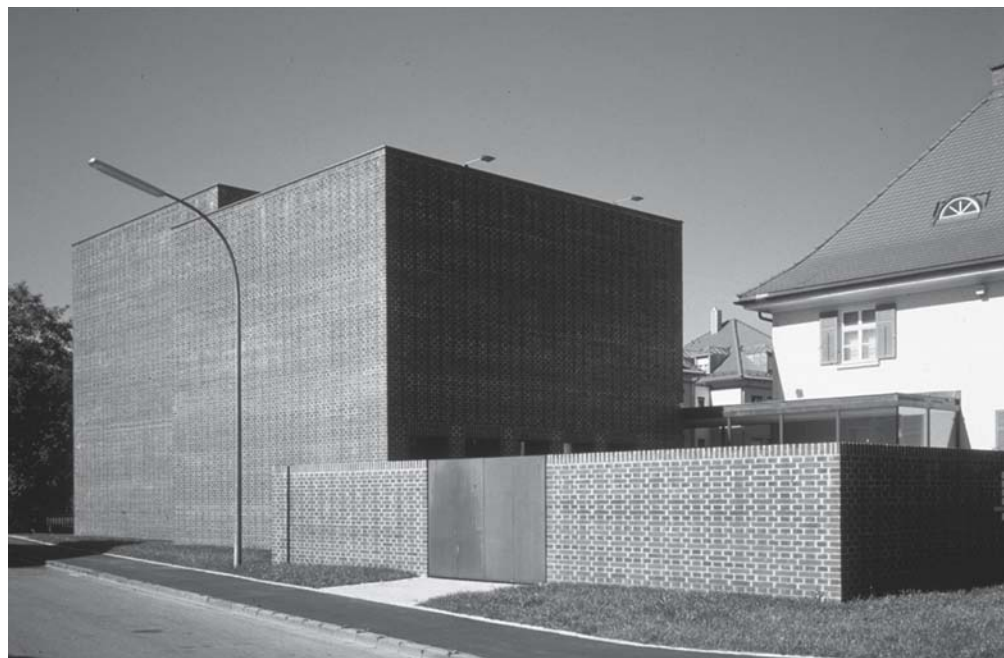


Fig. 66: View from the town hall

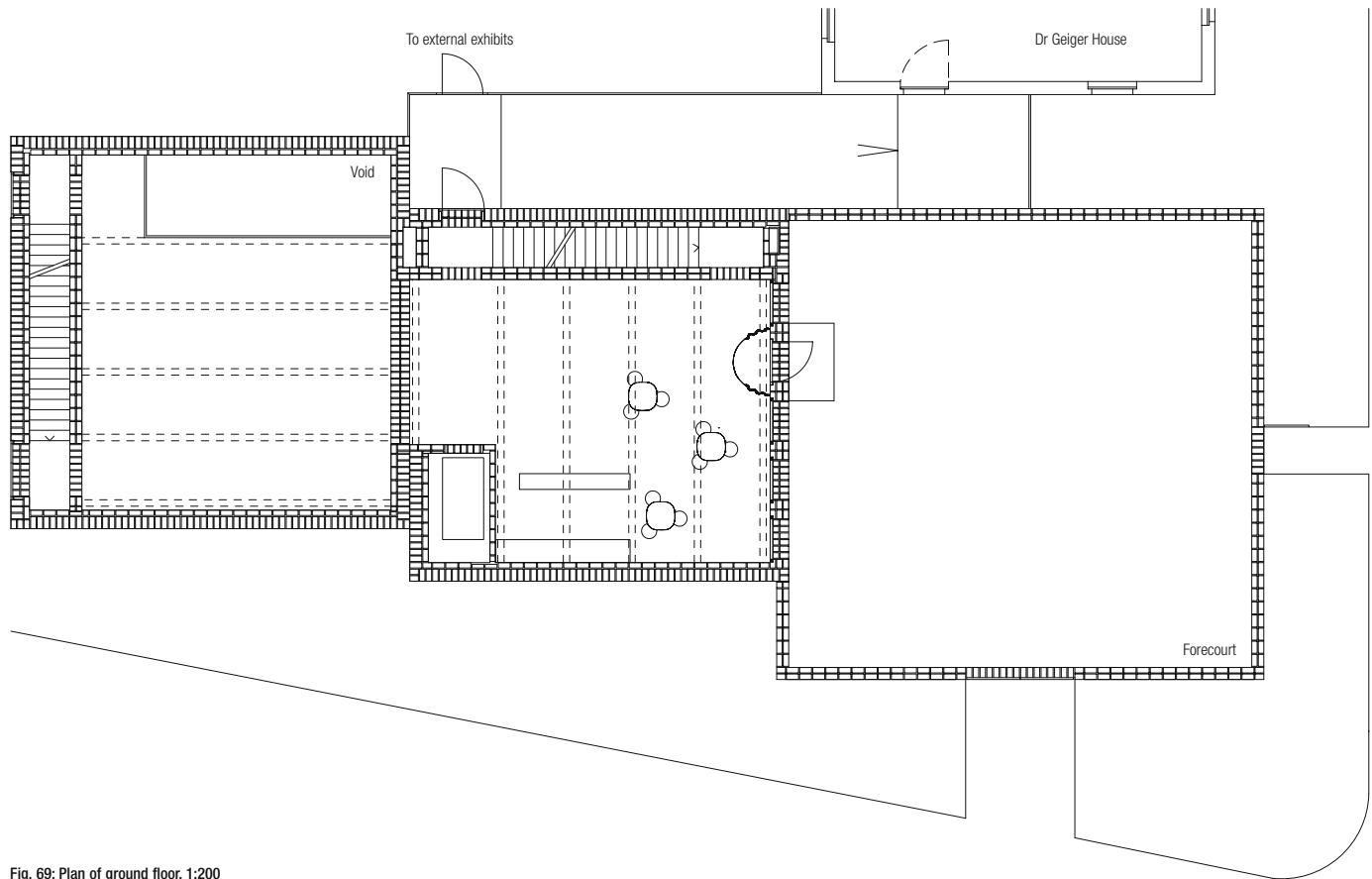


Fig. 69: Plan of ground floor, 1:200

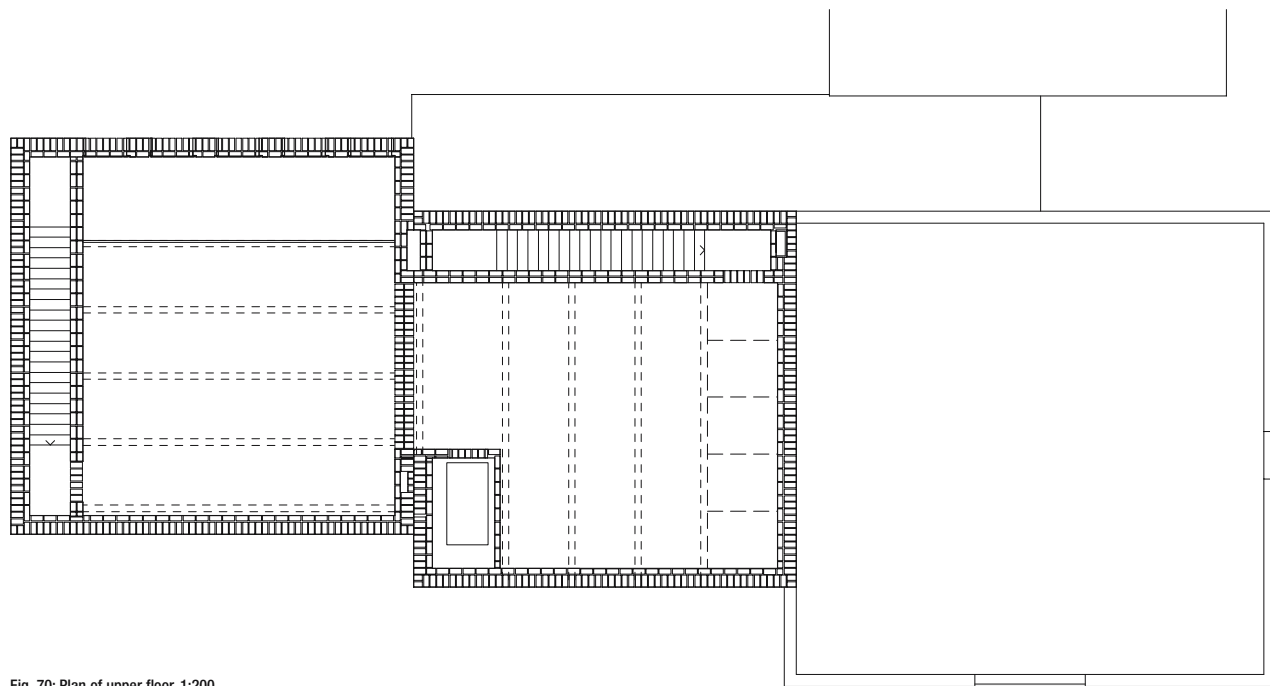


Fig. 70: Plan of upper floor, 1:200



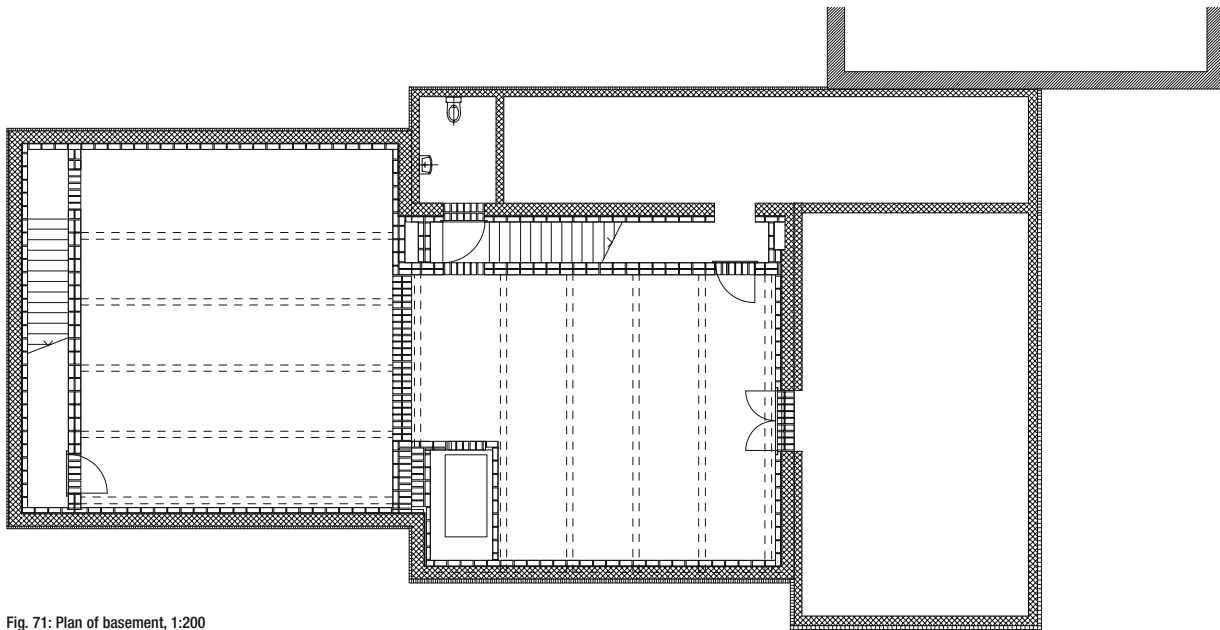


Fig. 71: Plan of basement, 1:200

### Loadbearing structure

In terms of classification, the building consists of two identical volumes, one of which is turned 90° and butt-jointed to the other. The seam between the two parts is rendered visible by way of the change in direction of the span of the beams and the double thickness of wall. The layout concealed behind the masonry shell obviously facilitates the unrestricted use of the exhibition areas and deliberately omits any internal core or partitions. Stairs and service shafts blend into the enclosing walls in order to create coherent exhibition areas of maximum size. Basically, the building is reduced to the interplay between a self-supporting envelope and the floors it surrounds, which are borne on steel beams. The monolithic basement and the roof functioning in a similar way to the intermediate floors provide a logical conclusion to the brickwork envelope.

The foundation of the gallery structure extends below ground level in the form of a brick-clad tank; this gives the impression that the masonry envelope has been sunk into the ground. The actual building envelope in solid masonry is built up off the basement. The clay masonry functions as a “brick–mortar composite section” with high compressive and low tensile strength. The actual loadbearing capacity results from the interaction of the two materials in all three directions. Minimal intermediate floors of tightly fitting spruce planks integrate into the vertical layout of the interior space without impairing the masonry shell. From the outside this solid masonry structure thus preserves an impression of having no internal floors.



Fig. 72: Masonry enclosing walls



Fig. 73: Longitudinal section, 1:200

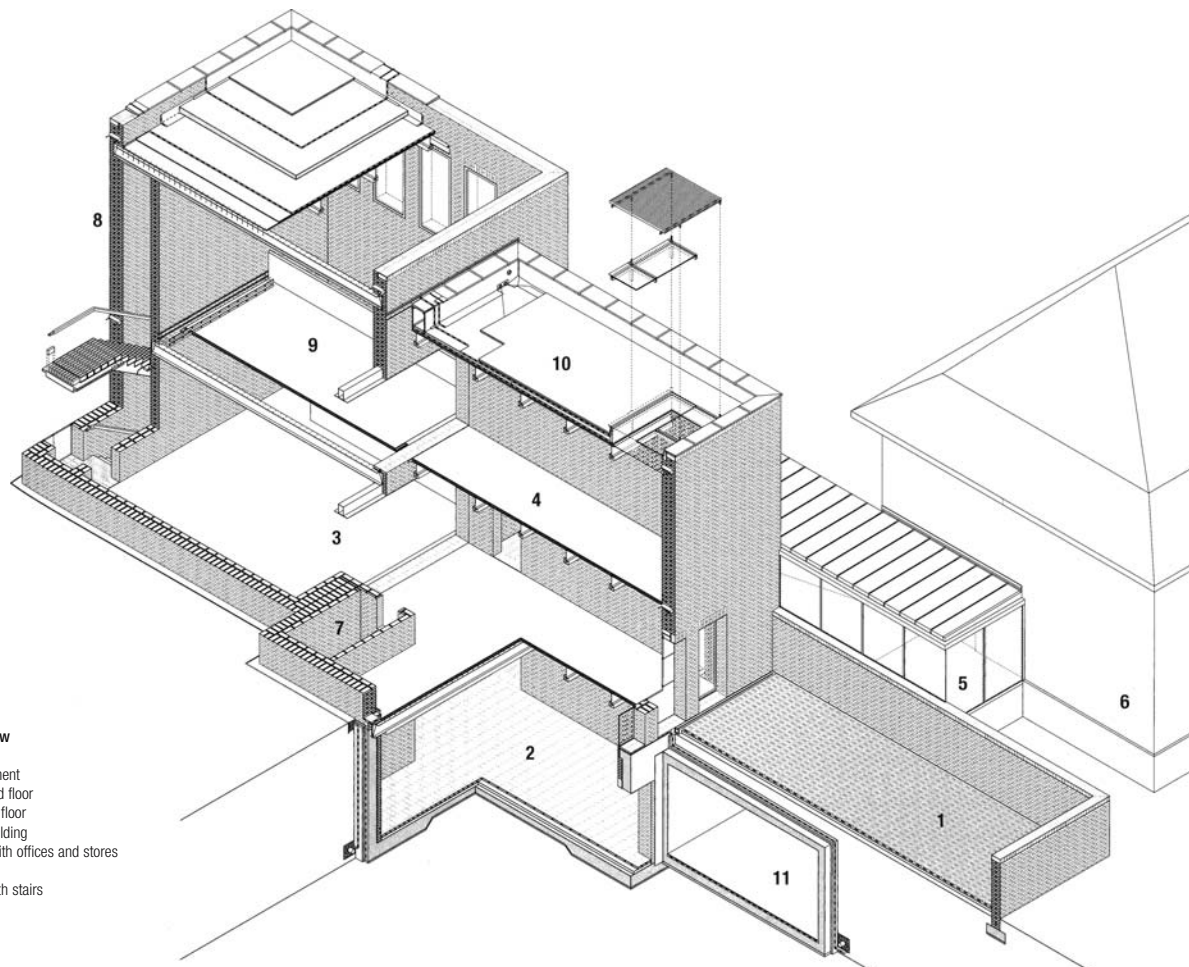
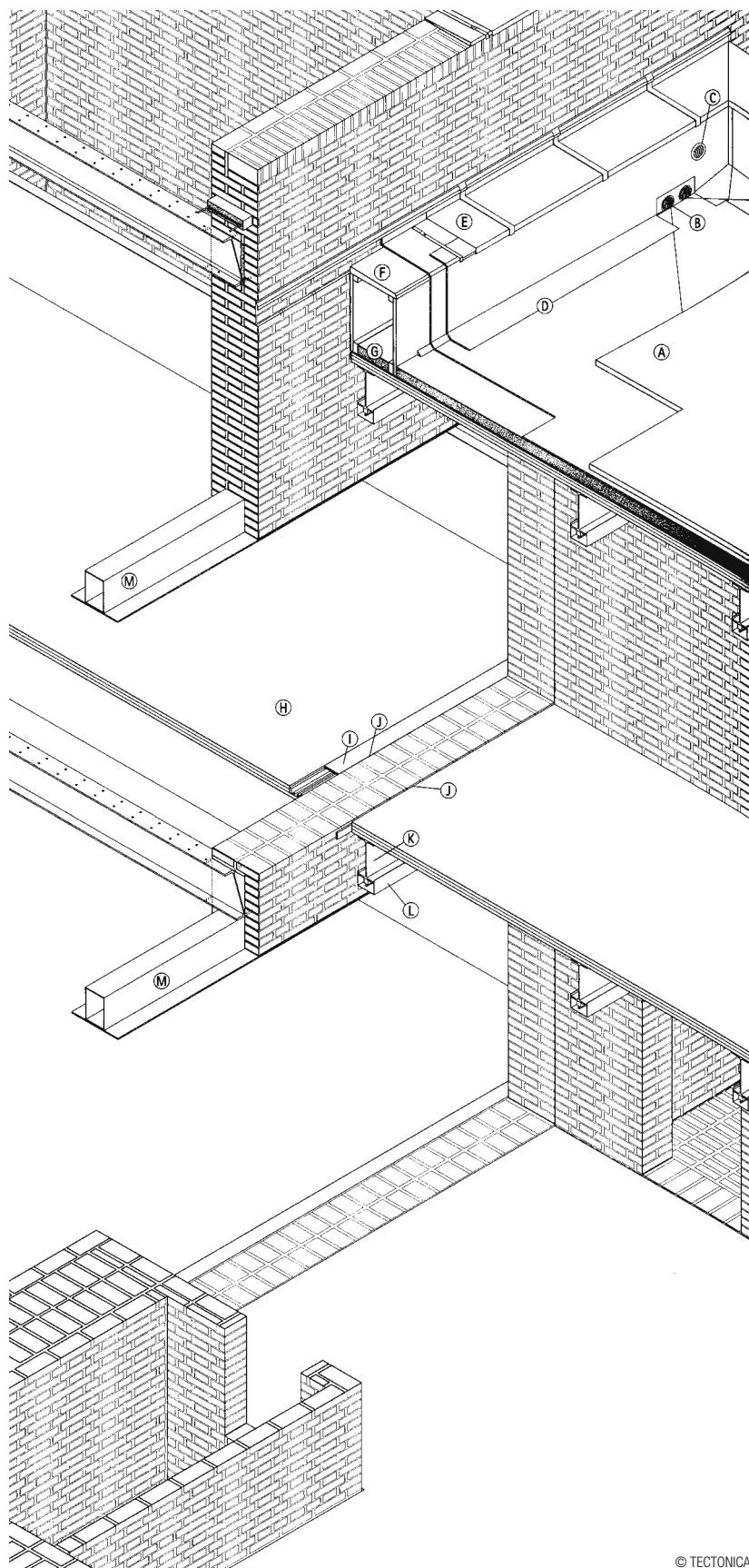


Fig. 74: Axonometric view

- 1 Forecourt
- 2 Exhibition area, basement
- 3 Exhibition area, ground floor
- 4 Exhibition area, upper floor
- 5 Link to Foundation building
- 6 Foundation building with offices and stores
- 7 Lift
- 8 Enclosing masonry with stairs
- 9 Gallery
- 10 Rooflight
- 11 Store



### Floors, roof, roof edge and loadbearing structure

The steel beams of the cubes abutting at 90° run parallel to the openings in the masonry. The fusing together of the two volumes makes it necessary to introduce a "dummy roof edge" to complete the parapet. This is a timber construction covered in sheet metal imitating a solid parapet. Inside the building, beams fabricated from a hollow steel section plus steel plate are used to support the floor beams (IPE sections) above the large openings between the two parts of the gallery. From inside, only the bottom flange is visible in the opening. The incoming steel floor beams are incorporated in the first course of the masonry in English cross bond. Pins anchor the beams to the masonry. This means that the floors are incorporated into the masonry without seriously defacing the inner skin of the building envelope.

The wall was built first up to the level of the beam support. Round steel bars were then incorporated in the mortar bed at the position of the floor beams. Afterwards, the wall was continued upwards in the normal way. A space was left around the end of the beam so that it could be subsequently separated from the external masonry by means of 30 mm polystyrene. The beam pocket was finally filled with concrete.



Fig. 75: Bearing for floor beam

### Fig. 76: Axonometric view

- A 50 mm gravel
- B Drainage outlets
- C Ventilation outlet
- D 2 layers of bitumen roofing felt, 3 mm
- E Sheet metal capping on mortar laid to falls
- F Supporting construction of water-repellent wood-based board
- G Rockwool thermal insulation laid to falls, 100 mm
- H 3-ply core plywood, 95 mm
- I Cable duct with removable cover (for electric distribution)
- J Separating strip, 1.5 mm
- K Steel beam, IPE 360
- L Fluorescent tube with transparent plastic diffuser
- M Beam: 200 x 300 x 8 mm rectangular hollow section + 495 x 12 mm bottom flange

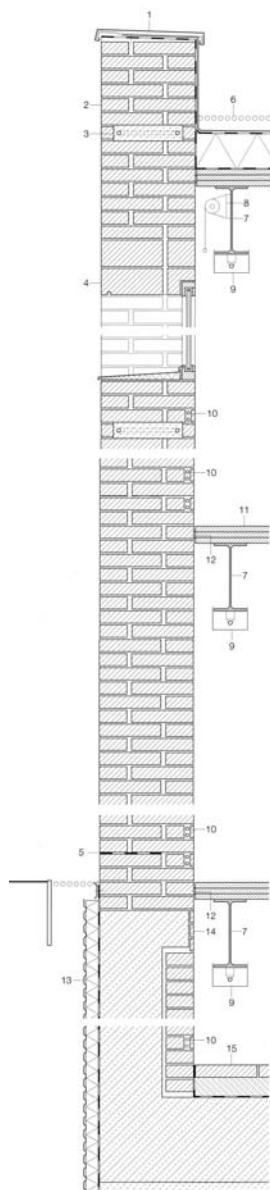




Fig. 77: Special reveal bricks prior to fitting door



Fig. 79: Daylight enters through the large rooflight



### Openings

The care taken with the way the floors are integrated is also evident in the arrangement of openings for doors and windows. Used only sparingly, they reinforce the monolithic character of this art workshop. The economical positioning of windows and the sometimes narrow, low-height openings give the effect of broad, mostly uninterrupted wall surfaces for the presentation of the exhibits. To be able to incorporate door and window frames flush with the wall surfaces, special bricks with corresponding rebates were prefabricated. Structural masonry cambered arch door and window lintels, which effectively distribute the wall loads of the masonry above, were built in situ with the smallest possible rise.

### Fig. 78: Detail section

- 1 Sheet copper capping
- 2 Hard-fired facing bricks, 320 x 145 x 65 mm, lava texture, brown
- 3 Reinforced concrete ring beam
- 4 Window lintel, clay
- 5 Damp-proof course
- 6 Roof construction:
  - 50 mm gravel
  - waterproofing
  - thermal insulation
  - vapour barrier
  - 95 mm glulam planks
- 7 Steel beam, IPE 360
- 8 Textile sunblind
- 9 Fluorescent tube with transparent plastic diffuser
- 10 Heating pipes bedded in mortar
- 11 Glulam planks, fir/spruce, 95 mm, oiled with white pigment
- 12 Sealing strip
- 13 Basement wall construction:
  - plastic sheeting
  - peripheral insulation
  - waterproofing
  - 330 mm reinforced concrete
  - hard-fired facing bricks, 320 x 145 x 65 mm
- 14 Brick slips, 320 x 15 x 65 mm
- 15 Floor construction:
  - hard-fired facing bricks, 320 x 145 x 65 mm
  - 105 mm mortar bed
  - separating layer

### Lighting

The cubes are divided into three levels. This creates three floors with different levels of lighting. Whereas the basement – the floor of the cube – is characterised by hard-fired facing bricks and artificial light, the exhibition rooms above are flooded with daylight entering through tall windows on one side. The decision in favour of artificial lighting in the basement and at ground floor level was quite deliberate. Only on the upper floor does daylight enter through windows and rooflights. The simple structural concept also requires a neat solution for the artificial lighting. And so in the gallery the artificial lighting is fitted beneath the white-painted steel beams. The lighting units are of fluorescent tubes with transparent plastic diffusers which can be controlled individually.



Fig. 80: Horizontal section through window showing special reveal bricks



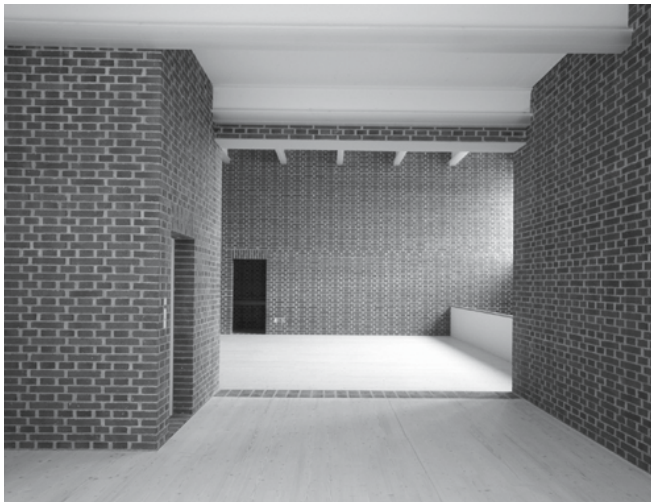


Fig. 81: Daylight enters through the tall windows on the upper floor.



Fig. 83: Artificial lighting fitted to bottom flanges of beams

© TECTONICA

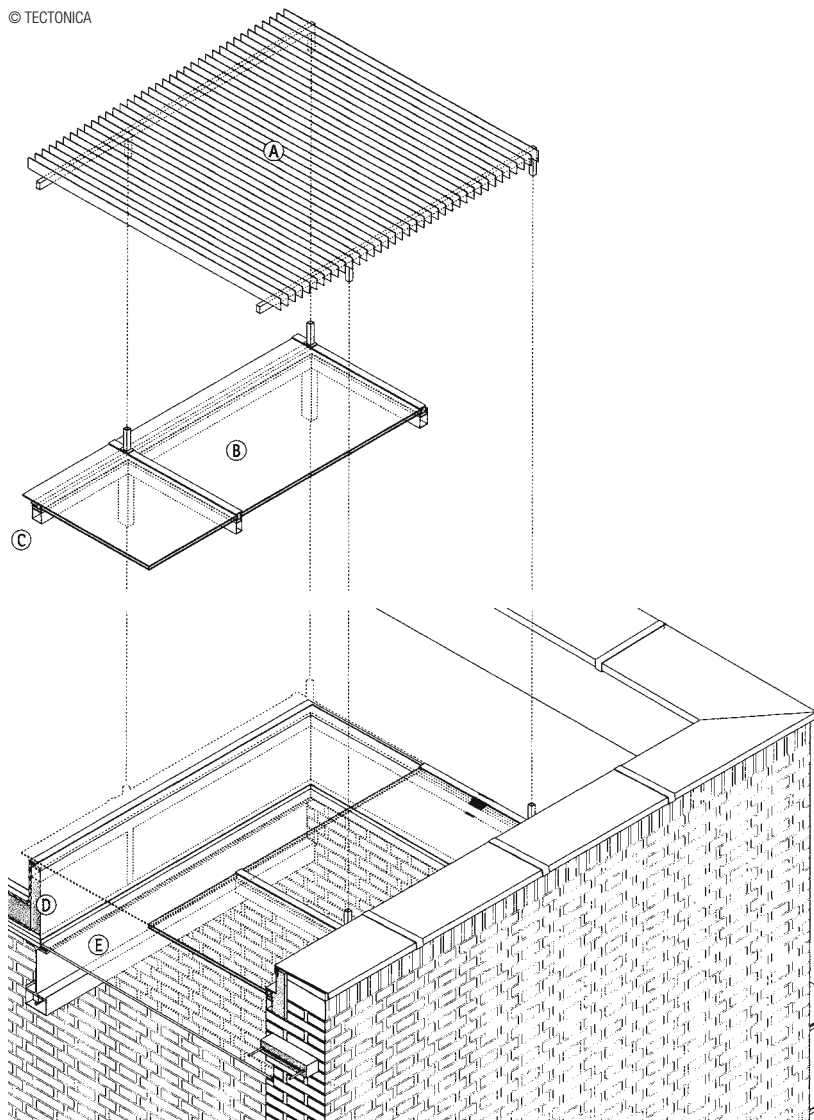


Fig. 82: Exploded diagram of rooflight

- A Aluminium louvers as thermal insulation, also providing protection against glare and sunlight
- B Laminated safety glass: 8 mm glass, 15 mm cavity, 8 mm toughened safety glass
- C Steel frame of rectangular hollow sections, 80 x 50 x 2 mm
- D Loadbearing sandwich element with integral posts of 7 mm sheet steel and 70 mm rockwool
- E Laminated safety glass, 16 mm, coated

### Internal surfaces

In the basement the floor finish to the cube is of hard-fired facing bricks with wide joints. Contrasting with this, the floors above are formed by steel beams and timber planks. The arrangement is very "proper" and thrifty: solid, 80 mm thick, finely glazed spruce laid on white-painted steel beams without any further floor finishes. This results in sound transmissions that propagate vertically throughout the building. However, this has been accepted in order to retain the minimalist concept of the architecture.



Fig. 84: Corner showing toothed intersection

### Design and realisation in clay brickwork

The Bavarian hard-fired facing bricks used for the gallery resemble the materials employed in this region in the Middle Ages, although, strictly speaking, Marktoberdorf does not lie within the actual clay brickwork catchment area. Besides this local reference, the material – in historical terms – is well suited to this workshop-type building. The building envelope is built from high-strength hard-fired clay facing bricks in the Bavarian format of 320 x 145 x 65 mm with an animated, irregular lava texture surface, left exposed internally and externally, and used consistently throughout. The use of hard-fired facing bricks, which ensure some relief themselves and not just an attractive appearance, is an intrinsic component in the overall monolithic design. The irregular texture of the clay bricks and the coarse-grained mortar also create a wall surface that calls to mind a woven textile. Their stability and inertia with respect to climatic influences underscores the aesthetic qualities of these bricks. These factors determine the design of the building as a monolithic masonry structure, approx. 540 mm thick, built in English cross bond. Besides the climatic advantages of an inert wall construction, this thick uniform shell offers an advantage, i.e. no expansion joints are necessary. Such continuous vertical joints in a solid brick wall are normally required to prevent uncontrolled cracking (caused by disparate loadings, settlement or thermal movement of individual components). However, owing to the limited dimensions of the facades, such joints are unnecessary here. The lack of interruptions in the wall considerably helps the sculpted effect.

Of great significance in the masonry bond is the way the joints harmonise with the brick themselves, not only in terms of their size (30 mm perpends, 10 mm bed joints),

but also in terms of colouring and texture. In order to break up the seemingly archaic-looking expressive force of the red-brown brickwork, both internally and externally, grey, grainy joints were chosen. Another prime advantage of the choice of clay masonry for an art gallery is that the humidity of the internal air – so crucial for preserving the exhibits – always remains constant. The humidity hovers around the level that is acceptable for both gallery visitors and exhibits alike.

This clay masonry building owes its existence to expertise imported from the Czech Republic (knowledge of old masonry bonds and sound knowledge about the building of facing brickwork). About 100,000 bricks of 18 different types were used, including solid and facing bricks plus specials at lintels and reveals.

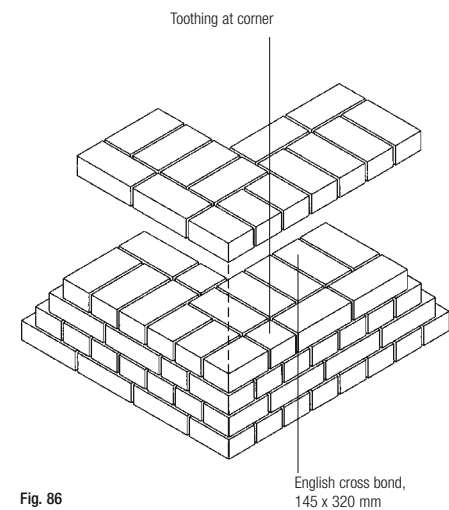
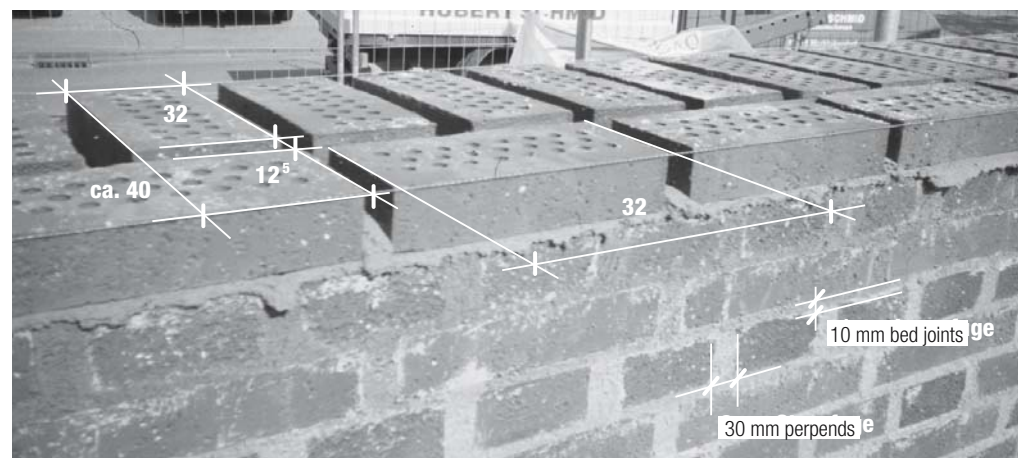


Fig. 86

Fig. 85: English cross bond with wide joints



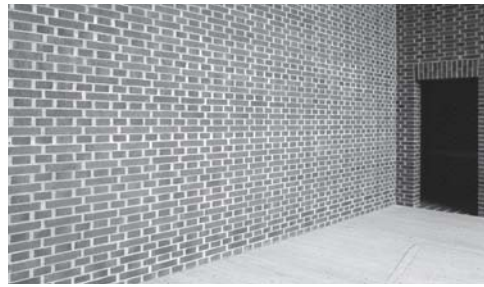


Fig. 87: The wall plinth heating is totally invisible!

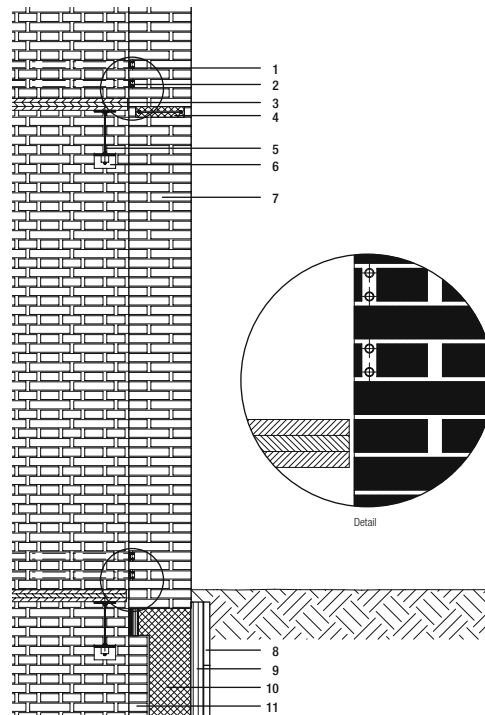


Fig. 88: Wall construction

- 1 Copper pipes, D = 18 mm, flow and return fully surrounded by mortar
- 2 Brick slips, 5 mm thick
- 3 Glulam planks, 95 mm thick
- 4 Ring beam (for horizontal stability)
- 5 Steel beam, IPE 360, built into masonry
- 6 Fluorescent tube with transparent plastic diffuser
- 7 Masonry, 495 mm
- 8 Cementboard
- 9 Cellular glass thermal insulation, 100 mm
- 10 Reinforced concrete, 320 mm
- 11 Facing brickwork, 145 mm

as dust and microbes. The principle of heating by radiation (controlled movement of interior air) was invented by the Romans, with their underfloor heating, called *hypocaust*. The heat generated at a source (*prae-furnium*) is fed into a cavity floor where it subsequently rises into the interior rooms through clay flues (*tubuli*) and radiates from the inner surfaces of the walls by taking the path of least resistance: the radiation penetrates the air virtually without loss, while within a masonry body it can only propagate from molecule to molecule by way of vibration, i.e. has to perform work. The consequence is that the majority of the heat can be used for space heating without being lost within the cross-section of the wall. This is backed up by the solar radiation incident on the outside face, which is stored in the uniform masonry body, uninterrupted by thermal insulation.

### Wall plinth heating

The *hypocaust* concept was considerably simplified for the gallery in Marktoberdorf without, however, relinquishing any of its effectiveness. Instead of an internal wall layer comprising vertical clay flues through which the hot air rises, two circuits of water-filled copper pipes have been integrated into the masonry walls just above each floor level to act as a heat transport medium. A conventional oil-fired boiler generates the heat for this system.

Consequently, the wall plinth heating uses only the principle of radiated heat in the loadbearing masonry. Heat source, transport medium and building measures are considerably different to those of the *hypocaust* underfloor heating system. The wall heating has proved to be amazingly effective. Owing to the inertia of the solid masonry, the controllable heat radiation is sufficient to guarantee a controlled interior temperature. A lower water temperature and hence less expensive heating is the outcome of the more even heat distribution of this heating by radiation. Such an installation is particularly viable for art galleries and museums. Until now, the interior climate necessary in such buildings containing valuable and highly sensitive works of art had been regulated mainly by way of extremely cost-intensive technology. But instead of complex building services and an air-conditioning plant, this building merely requires a network of copper pipes let into the external walls just above each floor level. The internal surface of the masonry radiates the heat evenly and ensures a comfortable interior climate. This combination of single-leaf wall construction and wall plinth heating has proved to be simple but effective.

### From *hypocaust* to wall plinth heating

The object of this observation is primarily the interaction of building mass (masonry) and the principle of space heating. If air-filled capillaries in porous building materials are good thermal insulators, then air must be a totally unsuitable medium for transporting heat. Nevertheless, convector heaters (unrestricted movement of interior air) are still installed, with the disadvantage of intensive heat generation, and the drawback that the interior air is set in motion together with all fine particles such

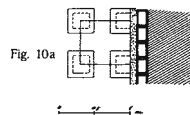
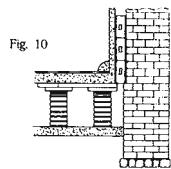


Fig. 89: *Hypocaust*, section and plan

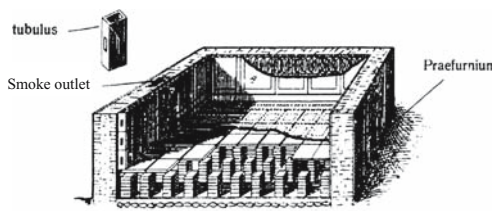


Fig. 90: Isometric view of *hypocaust* (*hypocaust* = heating from below)



## Detached family home, Grabs

Peter Märkli

Thomas Wirz

### Situation and theme

Grabs, the kind of scattered settlement, that is typical in Switzerland, lies in the flat land of the St Galler Rhine valley. Peter Märkli's house stands in a gentle depression between farms and other detached houses. It faces south and access is from the north side, via a narrow asphalt road.

At the start the design work was marked by an intensive analysis of the location and the interior layout, always keeping in mind the needs of the occupants. In the course of the design process the aim was to focus on a few themes – “one decides in favour of a whole”. One sketch finally embodied all the essential factors of the design.

Märkli responded to the given situation with a solitary, compact building. The house does not attempt to fit in with the existing buildings; it distances itself, so to speak, from its environment. It achieves this through abstraction. The intent here is not “minimal art” or a “new simpleness”, but rather a directness of expression in which all parts of the whole are visualised together.

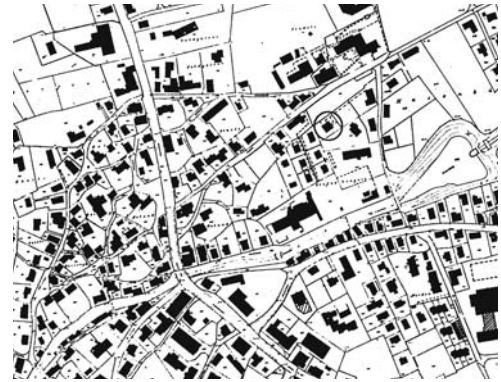


Fig. 91: Site plan

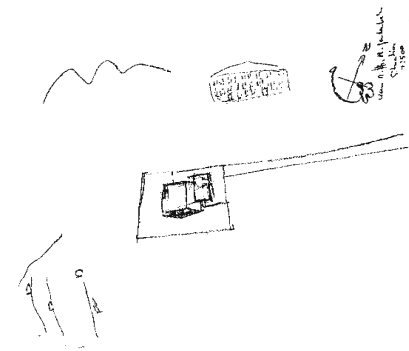


Fig. 92: Sketch showing location and context



Fig. 93: The house stands like sculpture on the open ground.

Architect: Peter Märkli, Zurich  
 Construction period: 1993–1994  
 Project manager: Gody Kühnis, Trübbach  
 Structural engineer: Kurt Gabathuler, Scuol



**Relationship with the terrain**

The open ground on which the house is built had to remain intact as far as possible. Therefore, the cantilevering part of the veranda seems to float above the ground. All the elements grow out of the envelope itself, which lends the building an autonomous, even introverted expression. It was not intended to be a house with external facilities competing with the neighbouring farmyards. The house is different from its surroundings, or as Ines Lamunière says: "It possesses a certain austerity which confines people either to the inside or the outside." A private garden in the normal sense of the word would be inconceivable here; the private external space – the veranda – is part of the house.

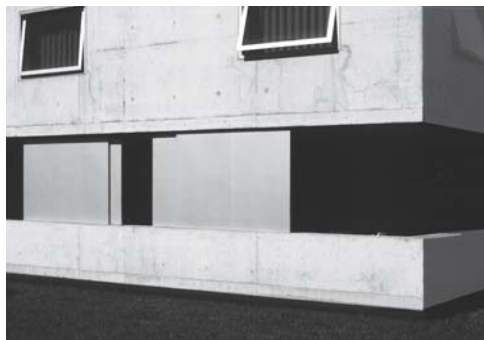


Fig. 94: The veranda is seemingly cut out of the volume.

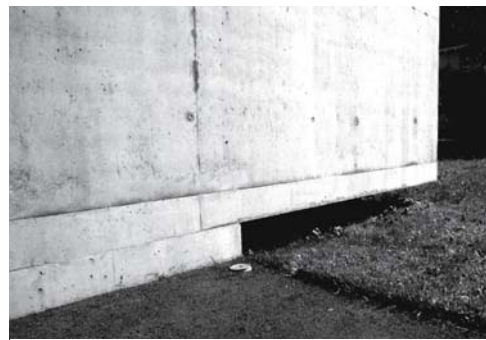


Fig. 95: The veranda "floats" above the ground.



Fig. 96: The veranda – external and yet enclosed

### Interior layout

The plan evolved around a focal point along the lines of the "onion skin principle". A few steps lead up from the covered entrance area to the hall, from where stairs lead to the upper floor and basement. The living room and kitchen are arranged in an L-shape on two sides of the hall. The large sliding windows allow a good view of the veranda and the seemingly distant surroundings beyond. The sliding aluminium shutters, providing privacy and protection from direct sunlight, help to reinforce this effect. Owing to the relationship between the corner and a section of wall, the interior space becomes opened up. This space then, devoid of any intervening columns, with the folding dividing wall between kitchen and living room, and a cement screed floor finish throughout, achieves an astounding expansiveness.

The interior layout on the upper floor also makes use of the L-shape. The south-facing rooms in the "L" are reached from a central hall, brightly lit via rooflights. The rooms, cantilevering out over the veranda, are of different sizes and are separated by plasterboard walls and built-in cupboards. The tiled bathrooms have been placed on the north side of the building.

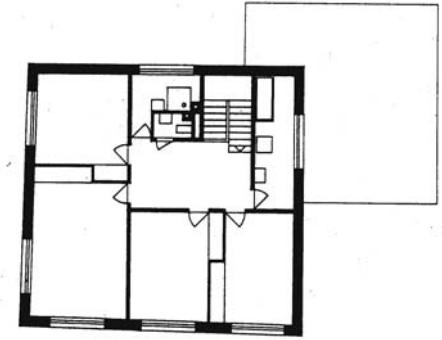


Fig. 97: Plan of upper floor

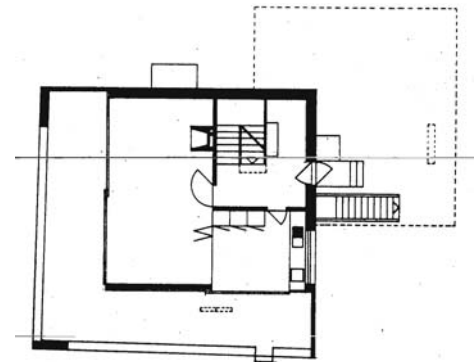


Fig. 98: Plan of ground floor

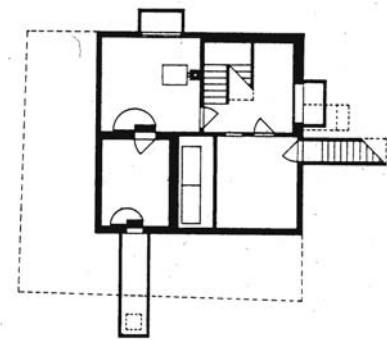


Fig. 99: Plan of basement

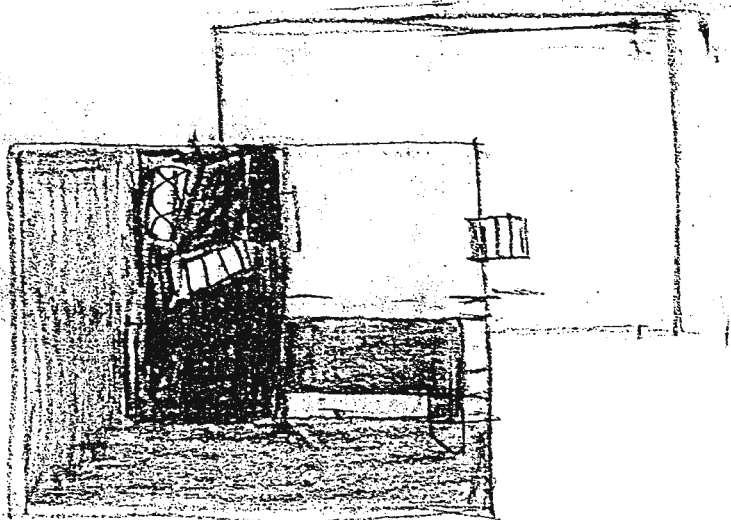


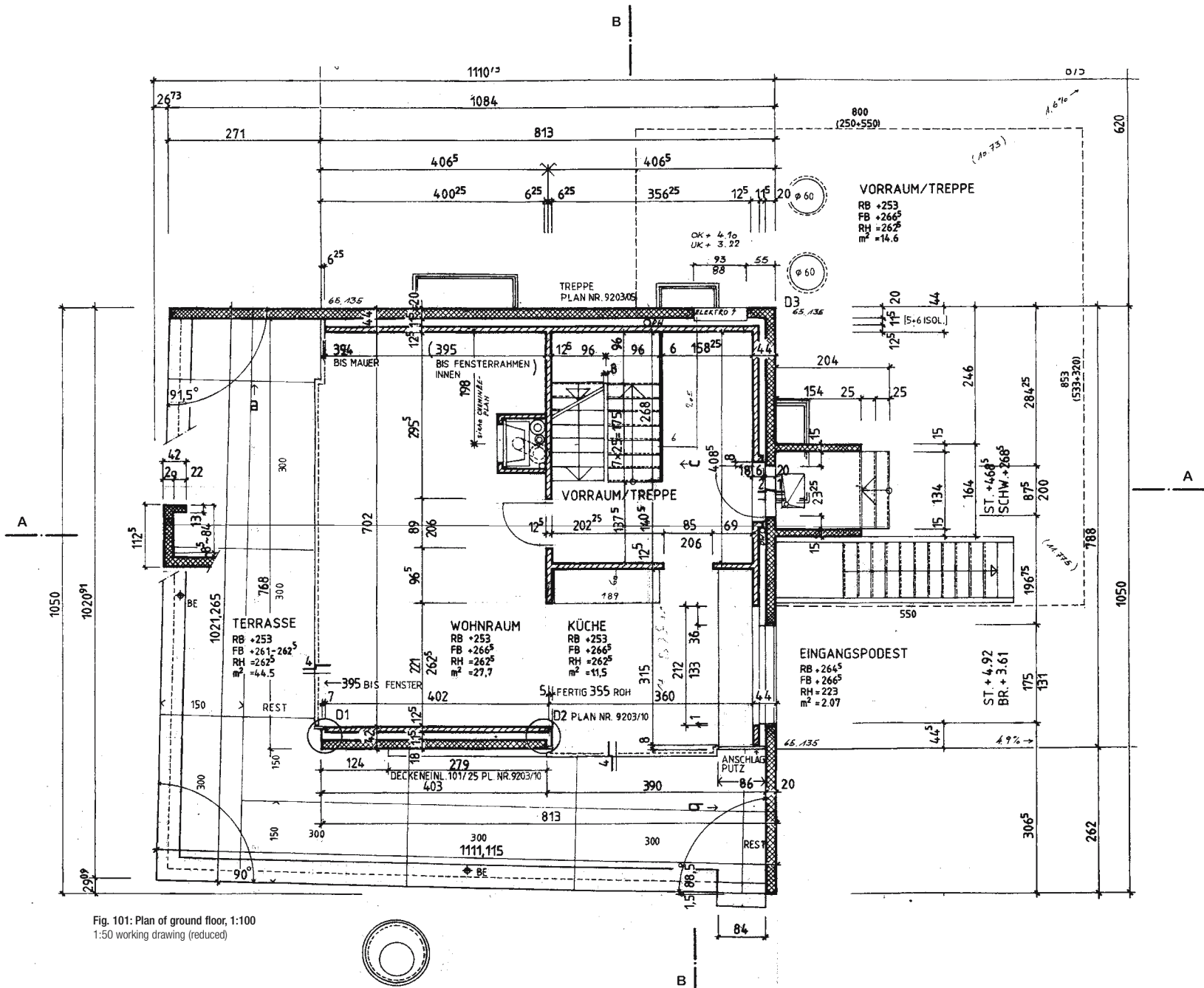
Fig. 100: Sketch showing interlacing of rooms

**Construction and structural aspects**

The use of in situ concrete is underscored by the non-right-angled geometry of the building, "which allows the cast form to be seen as bordering on the ideal, so to speak". The homogeneity of the cube is achieved by a constructional separation. The outer skin of concrete is structurally independent, with the loads being carried through prestressing and cantilevers. The inner skin is of plastered masonry. The concrete wall at ground floor level is the sole free-standing structural element. Besides its loadbearing function, it lends structure to the plan layout and marks the limit of the living room.



Fig. 102: Entrance elevation



The inner skin, masonry and concrete floors could be removed at a later date; the outer concrete envelope is totally separate from these in a structural sense. The point in the floor slab over the ground floor where the inner and outer skins meet (circled in fig. 103) is the point at which the large sliding windows to the veranda are incorporated. The use of such large window elements, without employing any cover strips, required a high degree of precision (tight tolerances) during manufacture and installation.

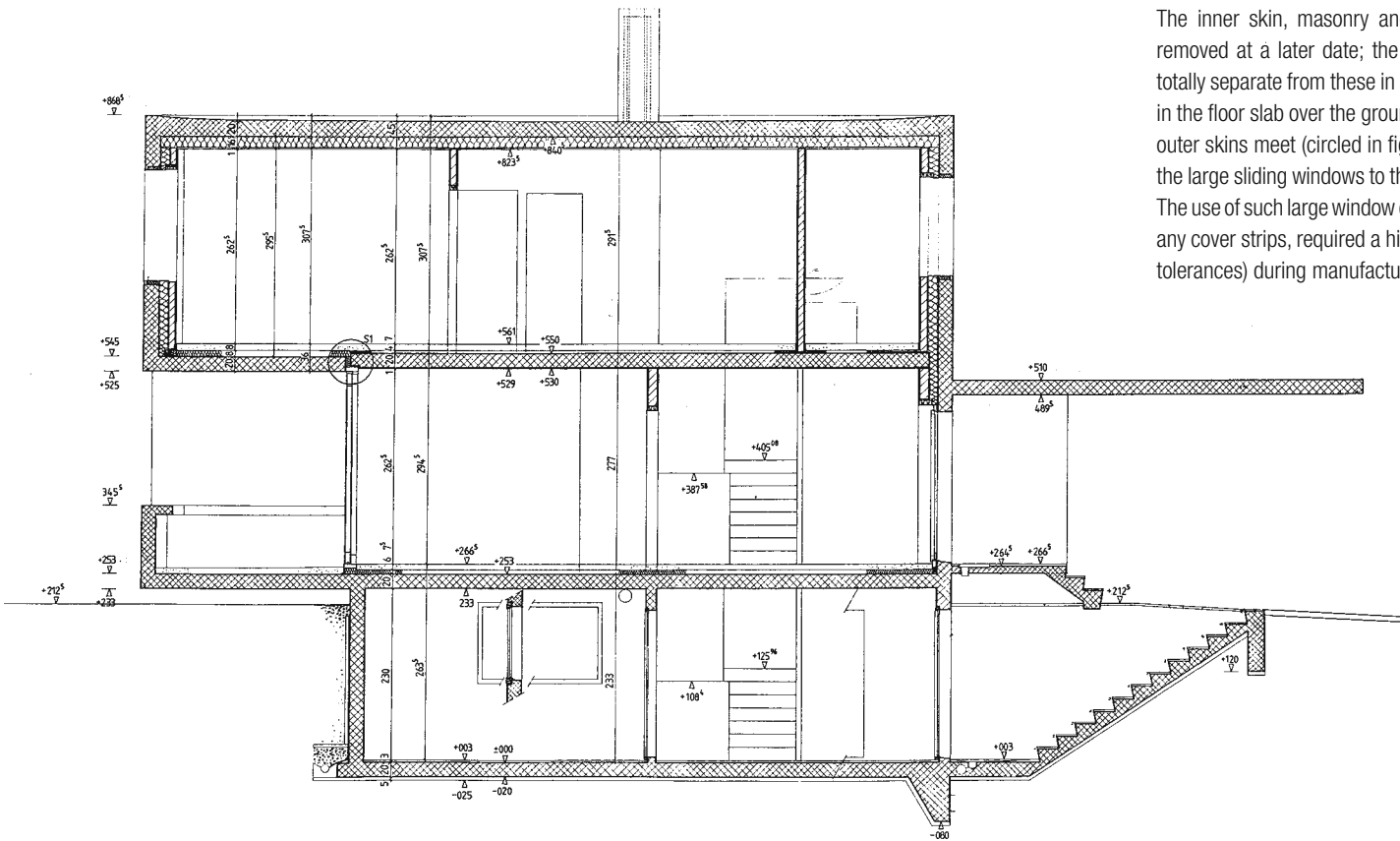
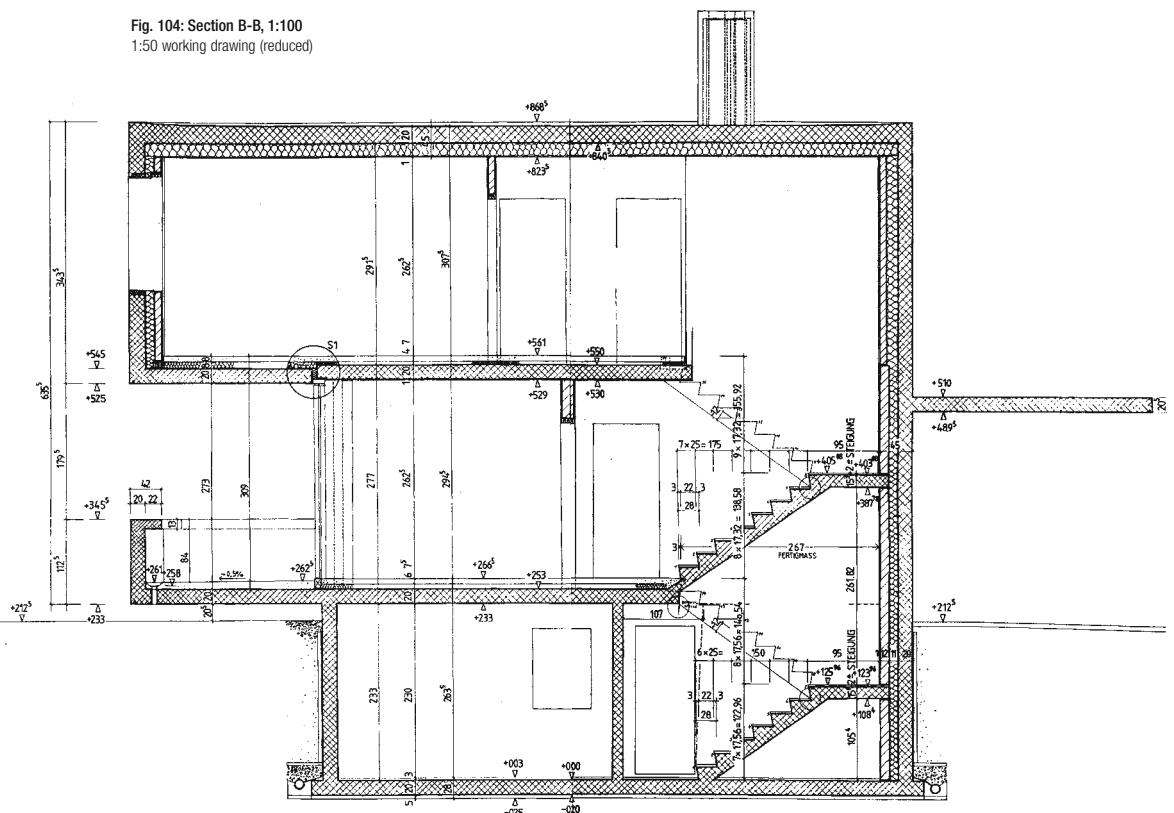


Fig. 103: Section A-A, 1:100  
1:50 working drawing (reduced)

<b>Roof</b>	
Triflex waterproofing	
Concrete	200 mm
Extruded polystyrene	80 mm
Rockwool between metal framing	80 mm
Vapour barrier	
Plasterboard	15 mm
<b>External wall, upper floor</b>	
Plaster, smooth finish	10 mm
Brickwork	100 mm
Extruded polystyrene	140 mm
Concrete	200 mm
<b>Slab over ground floor</b>	
Epoxy resin floor covering	
Cement screed	40 mm
Extruded polystyrene (aussen 80 mm)	
Concrete	200 mm
<b>External wall, ground floor</b>	
Plaster, smooth finish	
Brickwork	125 mm
Extruded polystyrene	120 mm
Concrete	200 mm
<b>Slab over basement</b>	
Granolithic concrete floor covering	
Cement screed	75 mm
Extruded polystyrene	60 mm
Concrete	200 mm

Fig. 104: Section B-B, 1:100  
1:50 working drawing (reduced)





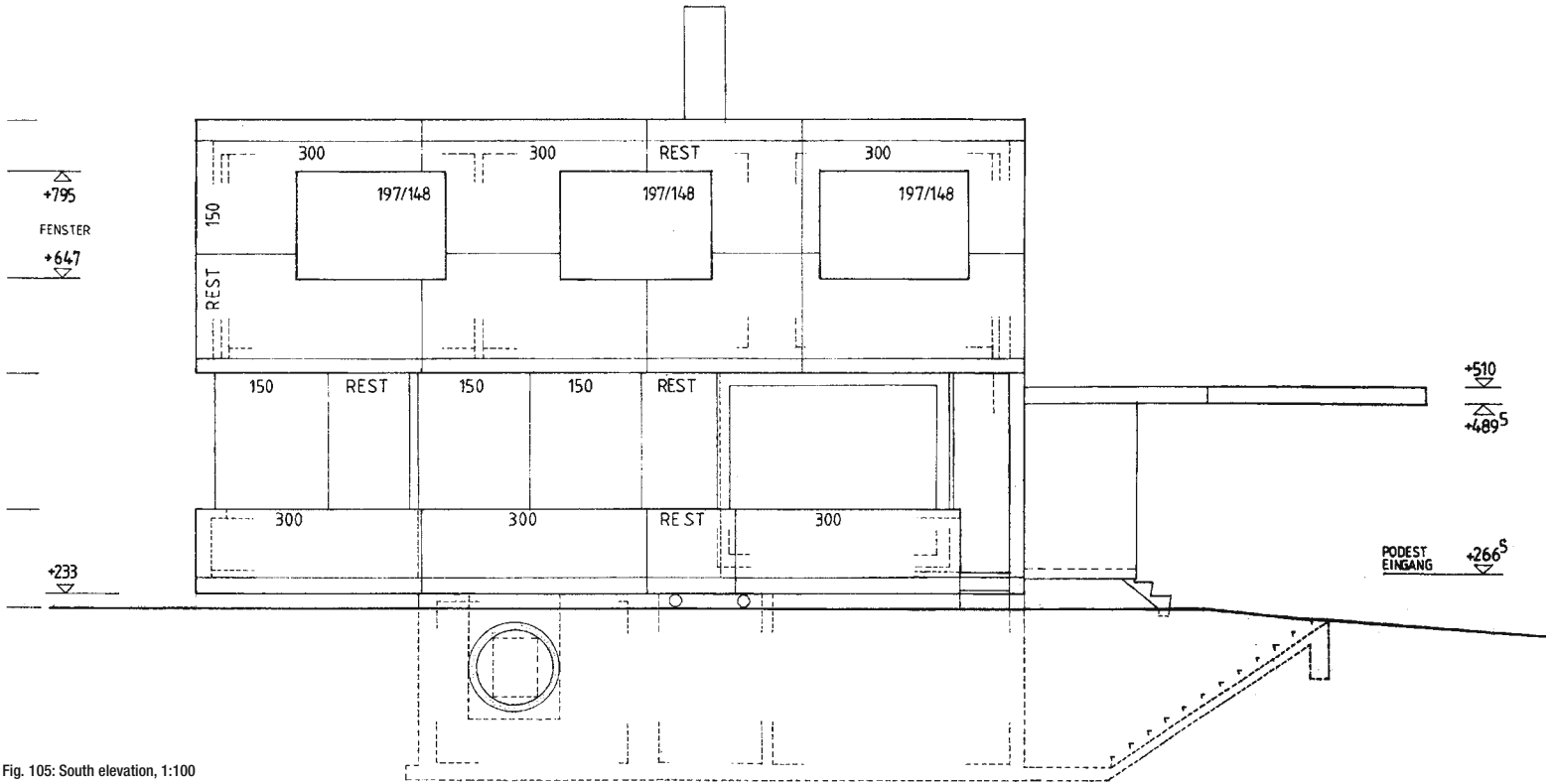


Fig. 105: South elevation, 1:100

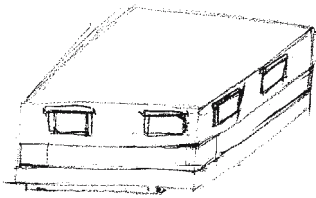


Fig. 106: Sketch showing facade proportions

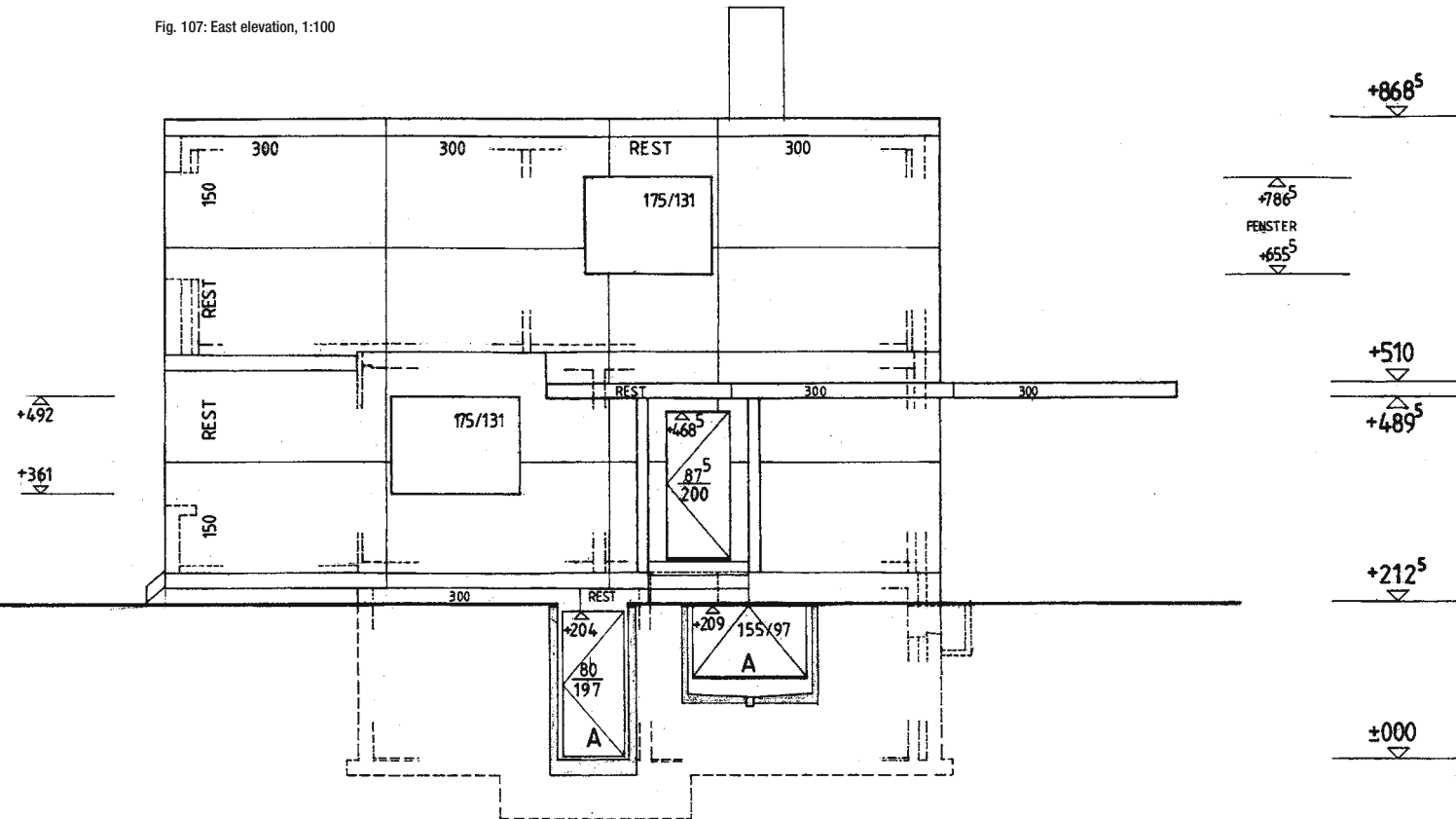
**Facades**

Here again there is no clear hierarchy among the components. As with the interior layout the most important thing in this case is the proportions. The relationship between the parts and the whole, between the parts themselves, and between openings and wall surfaces are crucial influences on the expression of the building. Internally, Märkli

also controls the elevations and the positions of openings in every single room by means of a consistent system of dimensions. At the lowest hierarchic level we have the pattern of formwork joints, which itself is subservient to the surface.

Small sketches showing two elevations were used to check the relationships.

Fig. 107: East elevation, 1:100



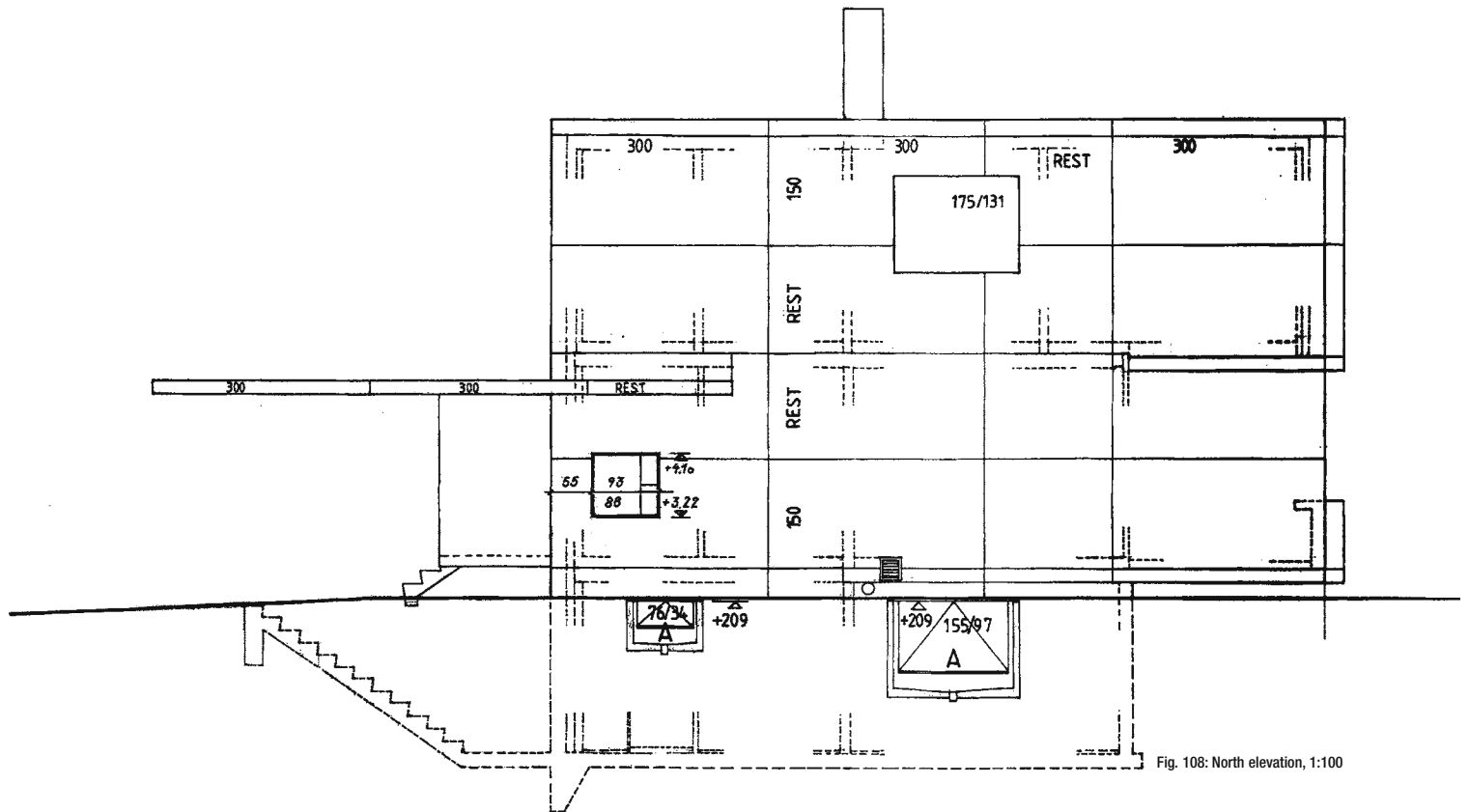


Fig. 108: North elevation, 1:100

Märkli works according to visual rules. The north elevation, for instance, is dominated by the two divergent cantilevers – the canopy over the entrance area and the veranda – and these add a certain tension to the facade. But the openings are positioned in such a way that the visual balance is restored. What this means is that the “centre of gravity” for the viewer comes to rest within the outline of the building (one can check this with the view towards the corner).

A single element like the long cantilevering canopy always has more than one function. Besides the architectural use already mentioned, it also serves as a symbol for the entrance, protects the entrance from the weather and acts as a carport.

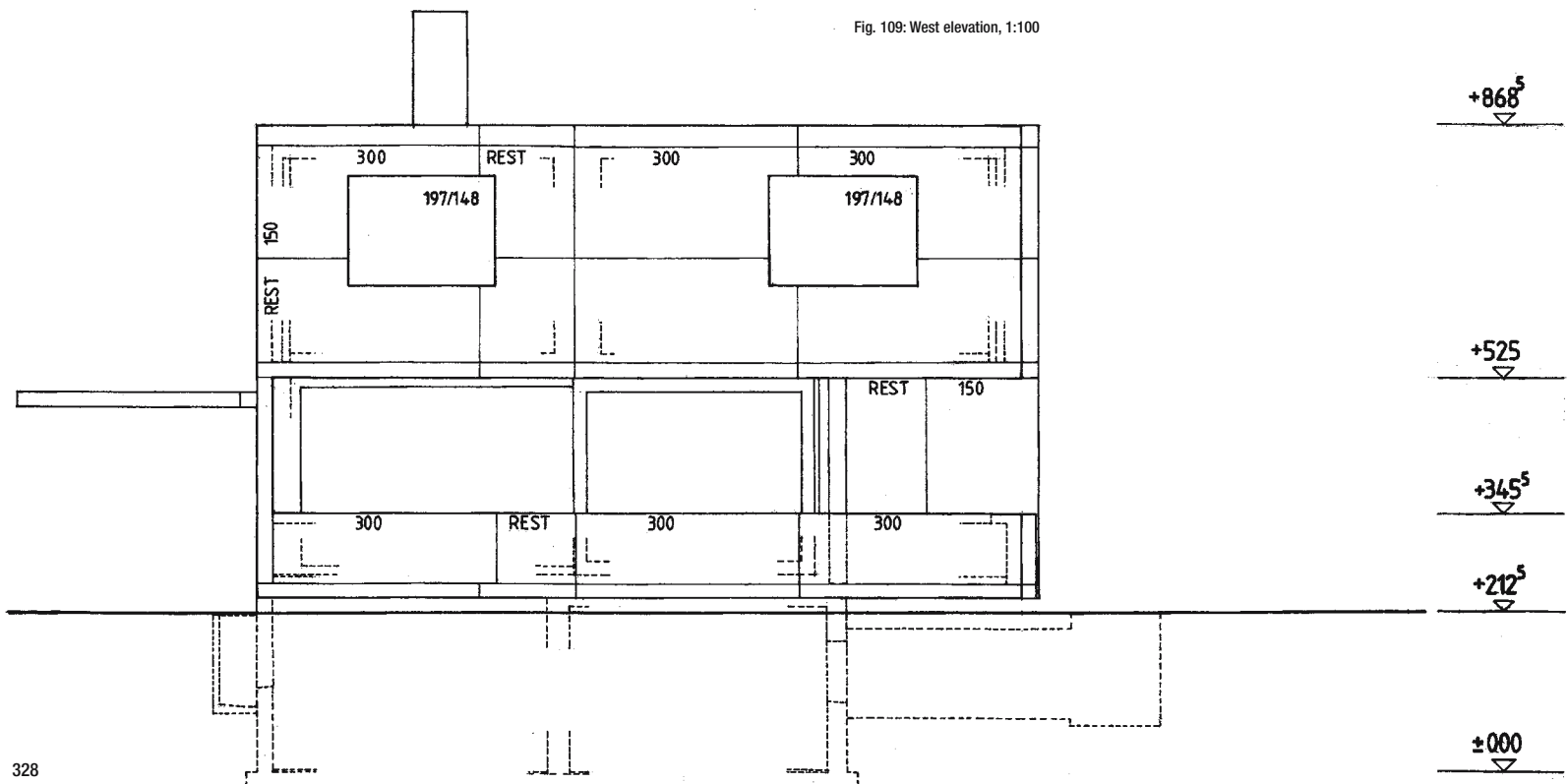


Fig. 109: West elevation, 1:100

### Openings

For tectonic reasons, the windows finish flush with the outside face, which helps to emphasise the coherence of the envelope. This results in deep internal reveals, whose “archaic” nature would not normally suit the character of such a house. Märkli solves this problem by including a wooden lining on the inside with a recess for storing the shutters. With the lighting units also being positioned above the window, the technical elements are concentrated around the opening. The walls and ceilings therefore remain intact, a coherent whole.

There are two different types of window, in both cases horizontal pivot windows in aluminium frames. In the rooms above the cantilevering veranda the “wooden box”, fitted with folding shutters of imitation leather, projects into the room. On the north side, in the kitchen and in the bathrooms, this box is fitted flush with the inside wall. It houses painted folding wooden shutters to provide privacy and protection against direct sunlight. All the folding shutters are standard products easily integrated into the whole thanks to their accurate design and fabrication.



**Fig. 110: Window flush with facade surface**  
Fitting the window in this way calls for carefully controlled details in terms of sealing against driving rain and wind pressure (rebated joints).



**Fig. 111: Aluminium horizontal pivot window**



**Fig. 112: Window with “imitation leather bellows”**

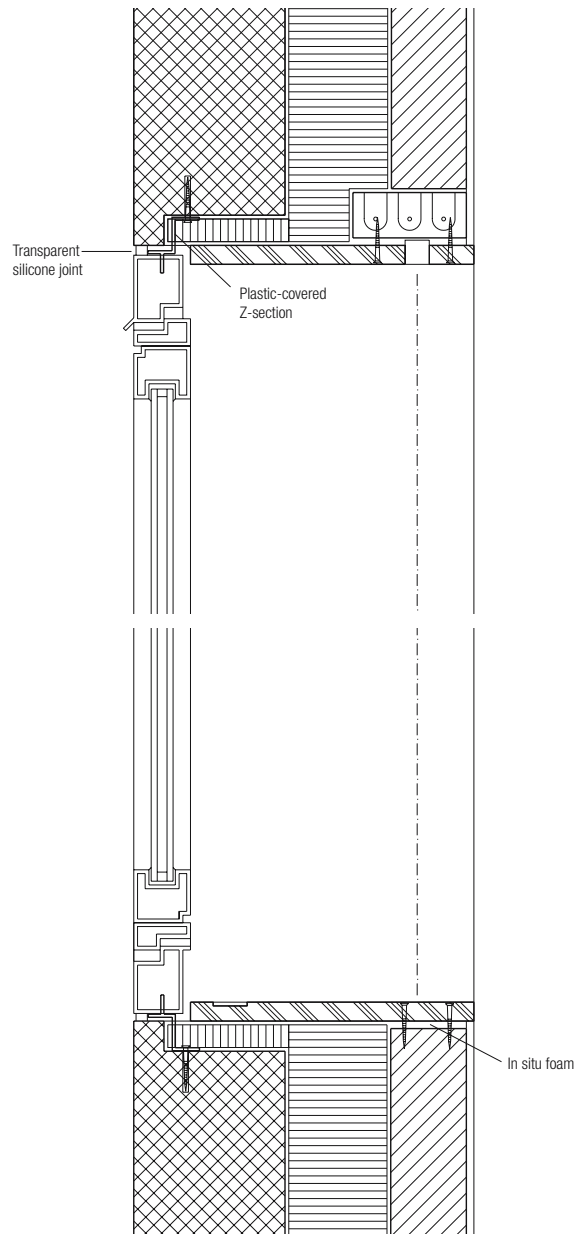


Fig. 113: Section through window, 1:10

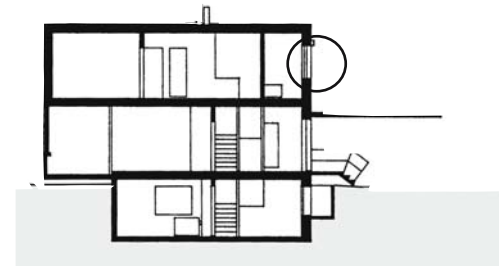


Fig. 115: Window type I



Fig. 116: "Imitation leather bellows" from outside



Fig. 117: "Imitation leather bellows" from inside

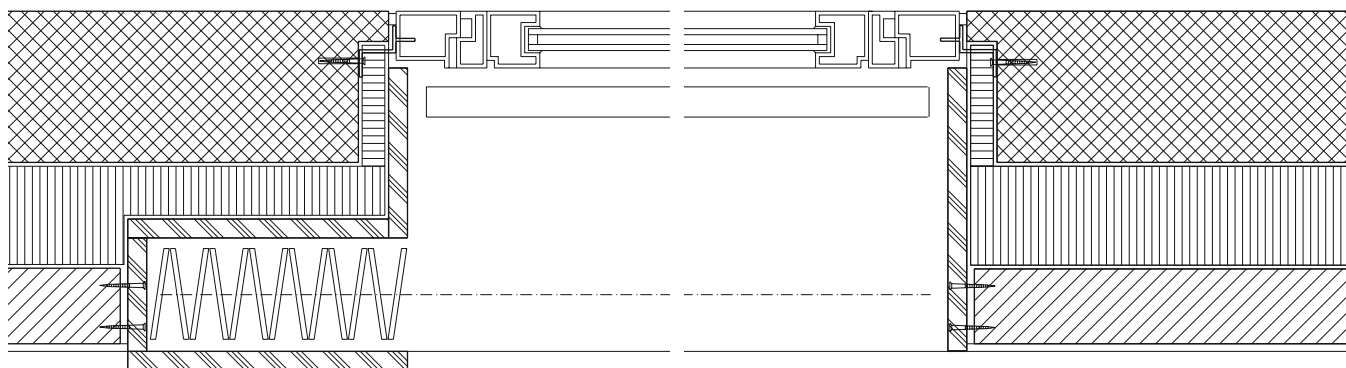


Fig. 114: Horizontal section, 1:10



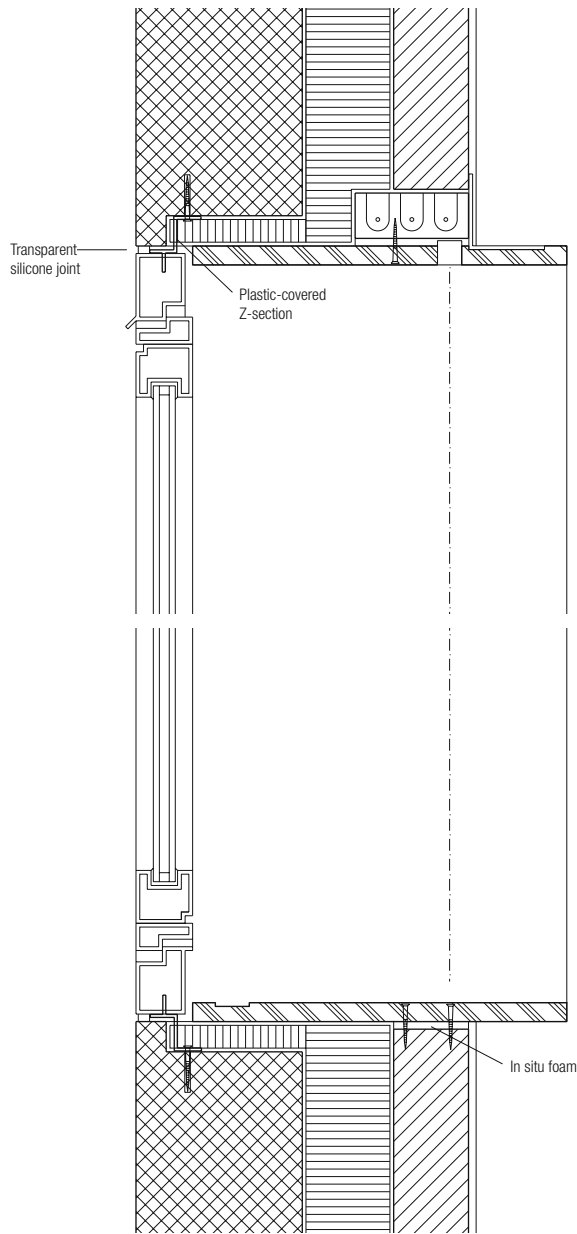


Fig. 118: Section through window, 1:10

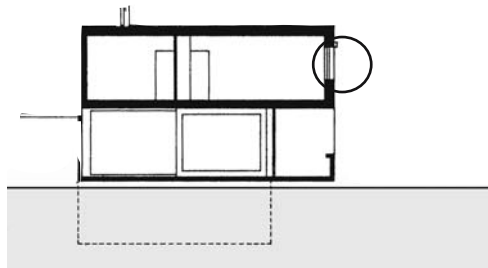


Fig. 120: Window type II



Fig. 121: Horizontal pivot window from outside



Fig. 122: Horizontal pivot window from inside

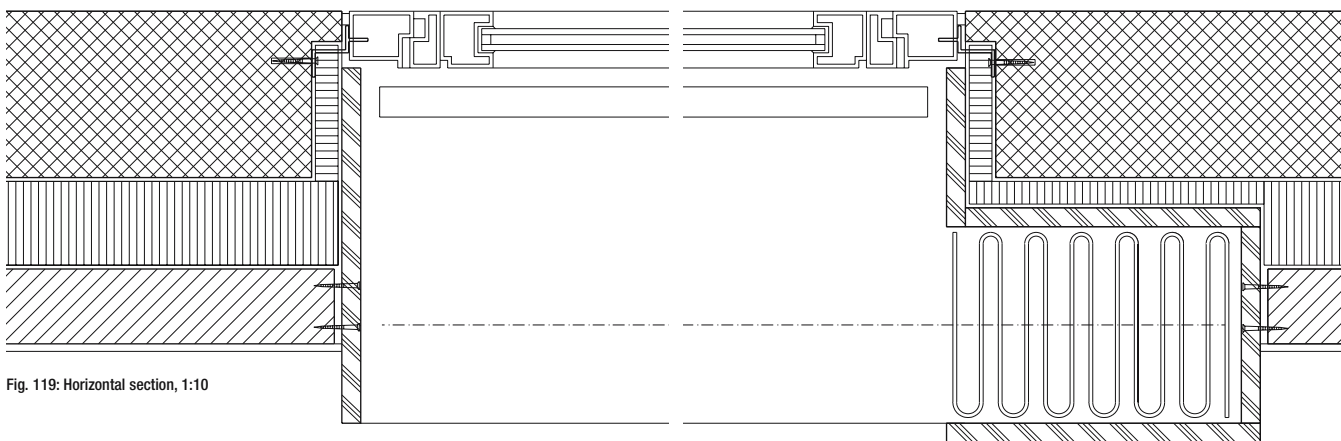


Fig. 119: Horizontal section, 1:10

## Paspels School

Valerio Olgiati

Martin Tschanz

### Paspels School

The school is located at the top end of Paspels village, which clings to a slope facing south-west. The three individual buildings of the existing school complex are joined in a row along the contour line of the slope, each one positioned to suit the local topography. They integrate seamlessly then into the scattering of buildings that make up the village.

Following the same logic, the new, separate school building is added on at the top end of the village. A distorted square on plan, with sides not quite at right-angles to each other, this building and its roof pitch, which tracks the line of the slope, exudes a very compact expression. It seems to be moulded from a viscoplastic material that has changed shape under the effects of gravity.

Starting from a central corridor at ground floor level, the two floors of classrooms above are each reached by single flights of stairs. There are three classrooms and one ancillary room on each floor, arranged in the four corners of the building and thus facing in a different compass direction. This results in a cross-shaped common area lit from all sides, with a north-eastern arm that widens out to form an area used by the pupils at break-times. A diffuse daylight prevails here, contrasting with the changing direct sunlight in the three other arms of the cross.

As the doors to the classrooms are positioned at the far ends of the arms, each room gains its own lobby. The irregular geometry is especially noticeable in these areas because the inside corner of each room indeed forms a right-angle and the short side of each room also joins the facade at a right-angle.

The layout of the rooms on the two upper floors is not identical. This means that although the rooms may appear

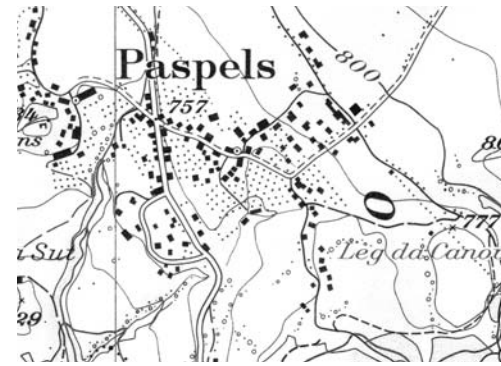


Fig. 124: The scattered layout of the village

the same, the changing lighting effects essentially create different rooms. On the outside this repositioning results in a sort of play on symmetry. Window frames in costly bronze make for a noble contrast with the crude simplicity of the concrete walls.

In terms of its construction, the school follows on the traditions of the houses of the Grisons canton. Solid concrete walls form the loadbearing structure, which contrasts starkly with the homely effect of the wood-lined rooms. The different characters of the rooms are thus highlighted: the warmth and intimacy of the classrooms contrasting with the hard, cool common areas (transition zones); a quiet, even muffled acoustic contrasting with resonance, warm brightness contrasting with differentiated light directed into the depth of each space.

Without any stylistic preferences, this school building, in terms of its character and construction, as well as in the nature of its interior, fits in exactly with its location.

Extract from: *Archithese* 2.97

Architect: Valerio Olgiati, Zurich  
 Construction period: 1996–1998  
 Assistants: Iris Dätwyler  
 Gaudenz Zindel  
 Raphael Zuber  
 Site manager: Peter Diggelmann, Chur  
 Structural engineer: Gebhard Decasper, Chur

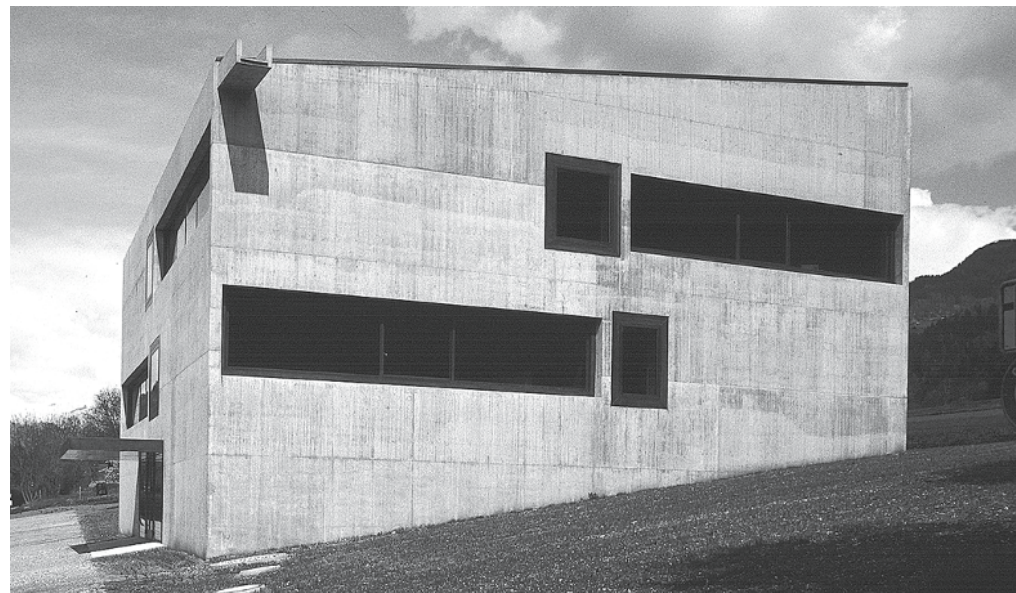


Fig. 123: Two sculptural elements project beyond the cube of the building: the canopy over the entrance and the water spout

Concept



Fig. 125: External envelope

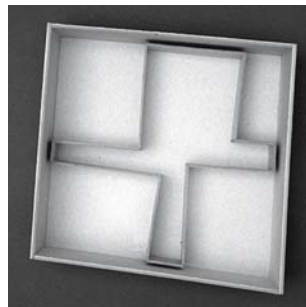


Fig. 126: The meandering internal skin around the classrooms forms a complete loop.



Fig. 127: Inner layer of insulation

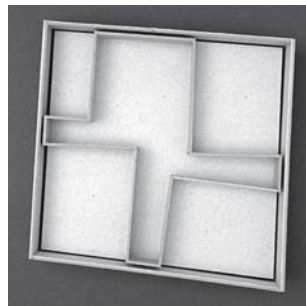


Fig. 128: The structural system chosen permits a rearranged layout on the floor above.

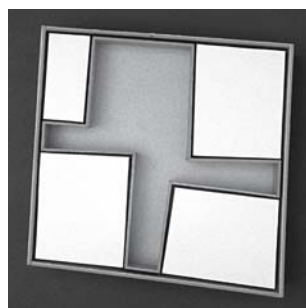


Fig. 129: The classrooms are lined with wood panelling.

Draft project

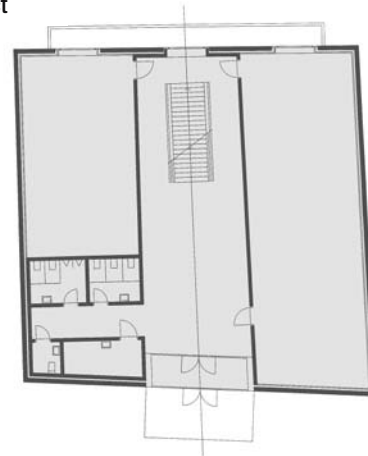


Fig. 130: Draft project, plan of ground floor

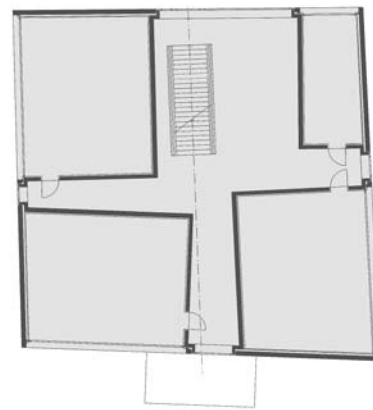


Fig. 131: Draft project, plan of 1st floor

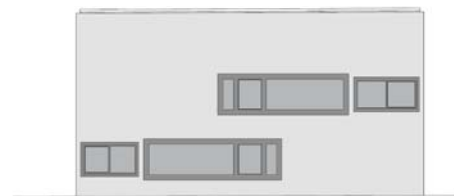


Fig. 132: Draft project, east elevation

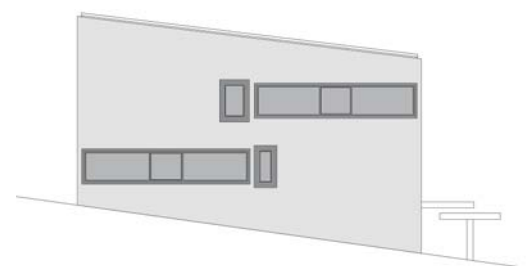


Fig. 133: Draft project, north elevation

Gebhard Decasper

### Structural aspects

#### The engineer's report

The architectural concept called for the inside of the building to be separated from the external facade by 120 mm of thermal insulation without erecting a second loadbearing wall to support the floor slabs. This in turn called for an optimum engineering solution in order to transfer the support reactions from the walls and floors to the external facade.

The answer was to use high-strength double shear studs.

At ground floor level the two walls to the left and right of the stairs are the primary structural elements supporting the first floor. The inner walls of the first and second floors are the structural elements for the floor and roof above respectively. The interaction with the floor and roof slabs (walls as webs, slabs as flanges) is taken into account. All the support reactions are transferred at the wall junctions transverse to the external walls. Double shear studs, one above the other, were incorporated in the facade at these junctions. The number of shear studs required depends on the loadbearing capacity of a single stud.

In order to eliminate the deflection of the unsupported slab edges (spans between 8.0 and 10.0 m) along the facade, additional support points with shear studs were incorporated in the centre of each slab edge span and at the corners of the facade.

Special attention had to be given to transferring the shear forces at the shear studs.

The thermal insulation had to be reduced to 50 mm around the shear studs; however, this was acceptable in terms of the thermal requirements. In order to prevent – as far as possible – the formation of cracks in the external walls, particularly around the long windows, considerable additional longitudinal reinforcement was fitted in the areas at risk. The structural analysis of this new building represented a real challenge for the engineer.



Fig. 136: Cage of reinforcement with shear stud positioned ready for cast-

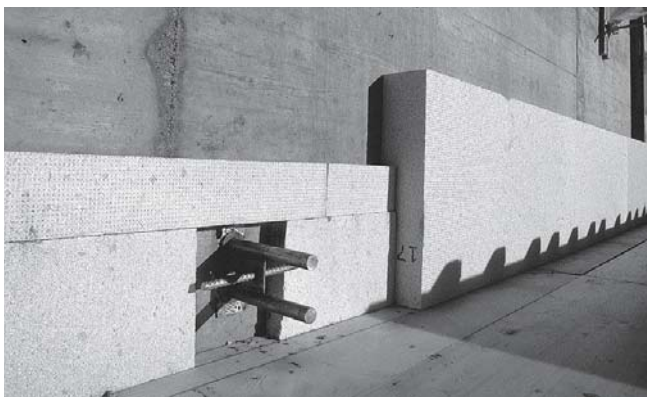


Fig. 134: The thickness of thermal insulation is reduced around the shear studs.

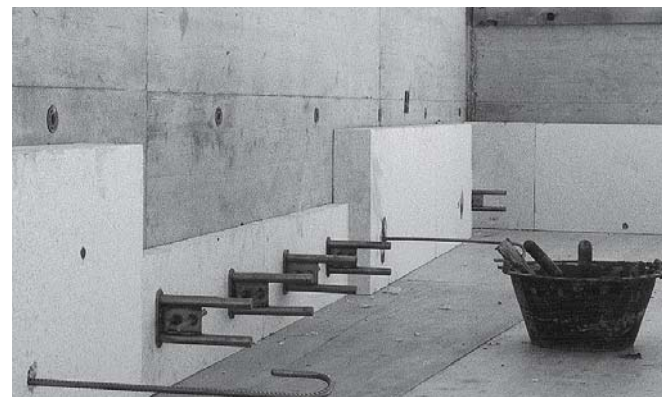


Fig. 135: Row of shear studs in the internal corridor







Fig. 140: Common area on 2nd floor



Fig. 141: Corridor, 2nd floor

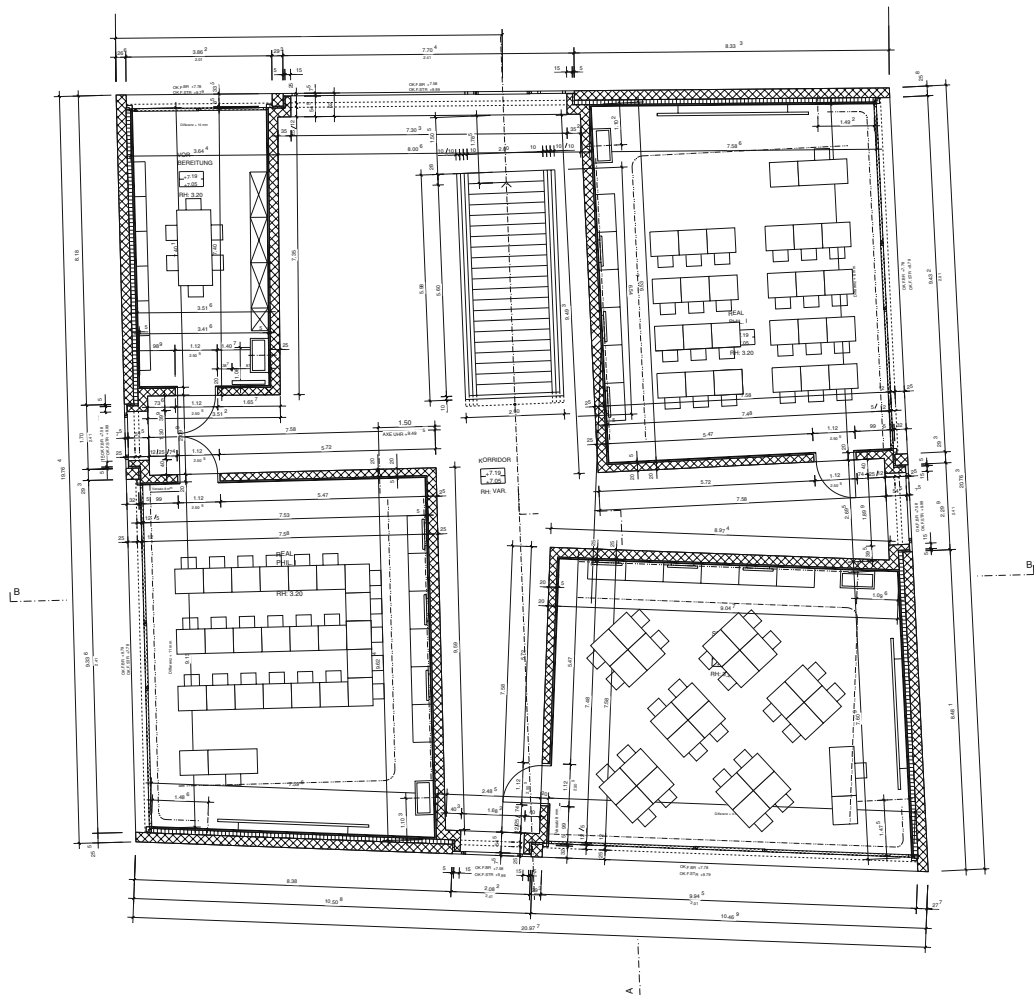


Fig. 142: Plan of 2nd floor, 1:200  
1:50 working drawing (reduced)

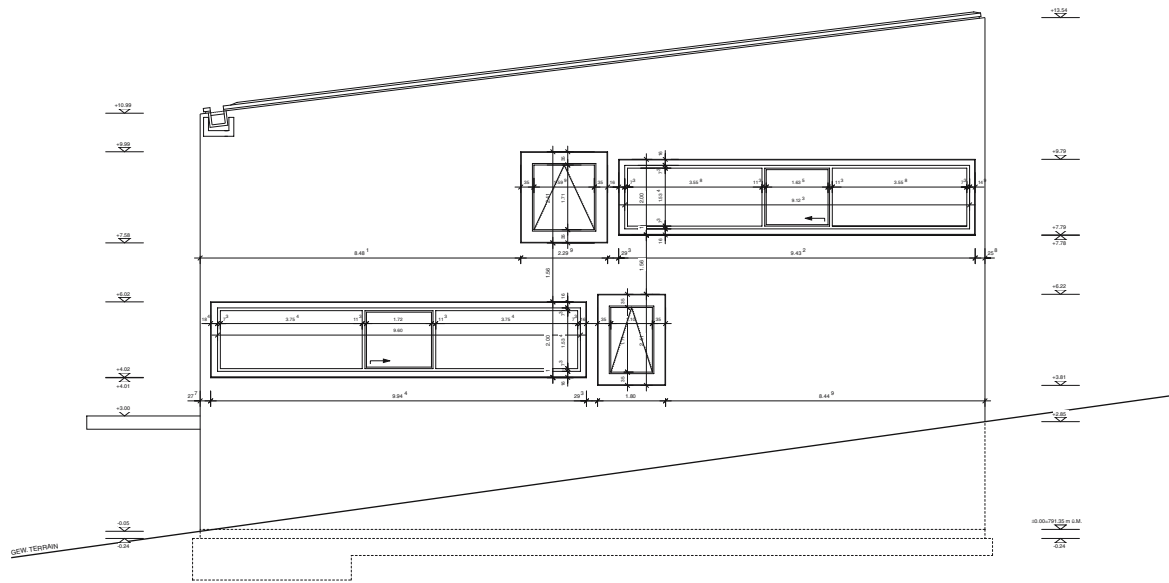


Fig. 143: South elevation, 1:200  
1:50 working drawing (reduced)

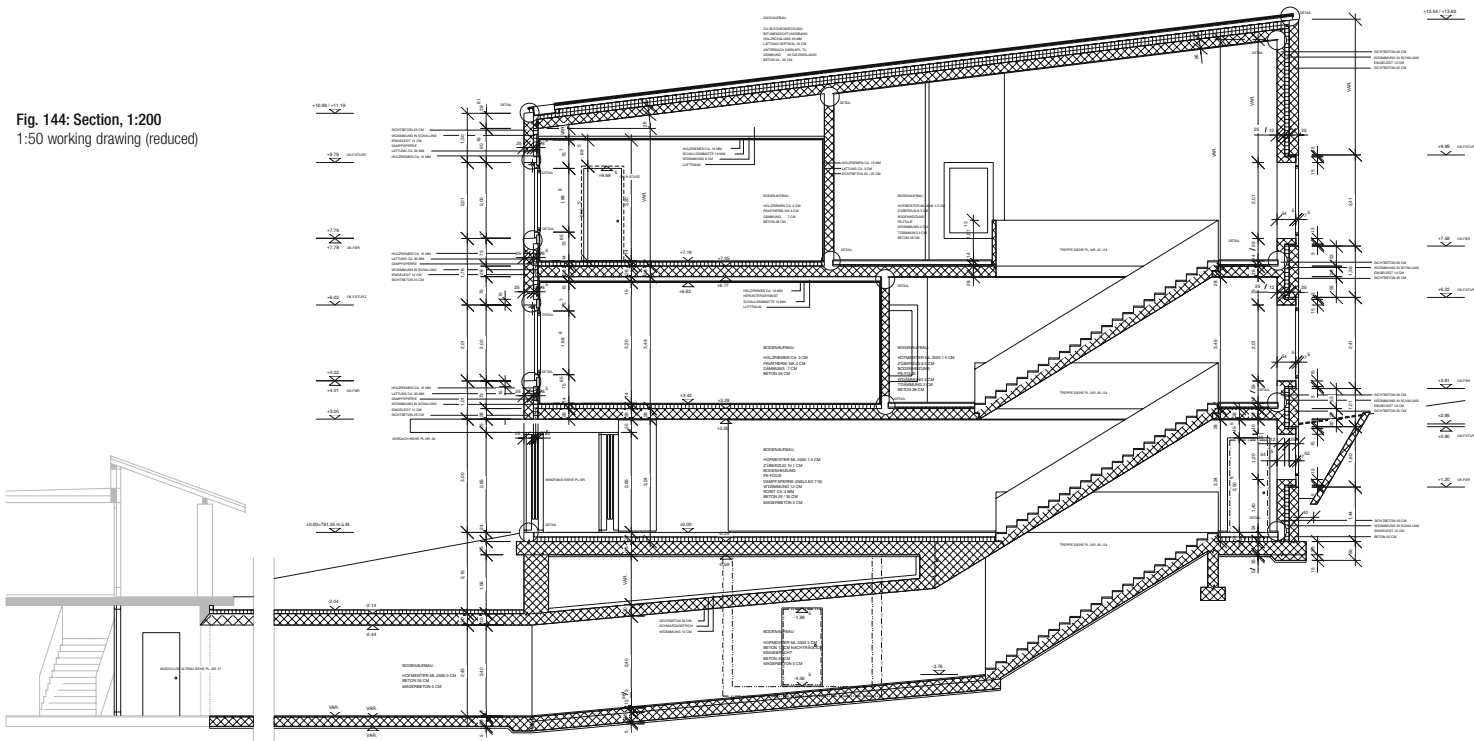


Fig. 144: Section, 1:200  
1:50 working drawing (reduced)

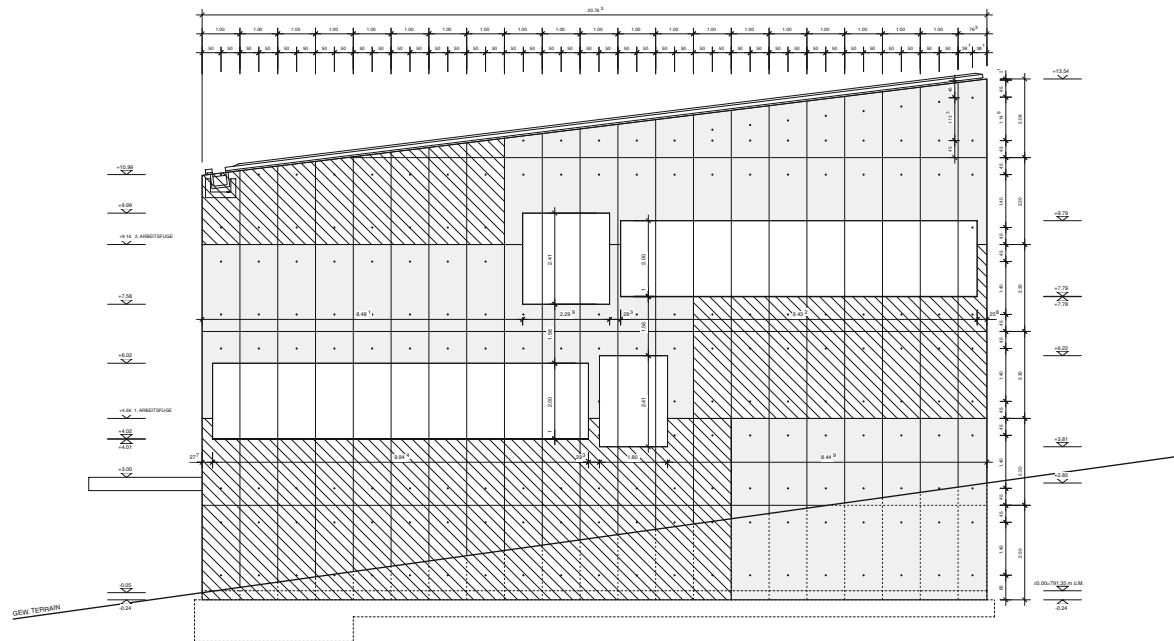


Fig. 145: South elevation, formwork layout, 1:200  
1:50 working drawing (reduced)



Fig. 146: South facade





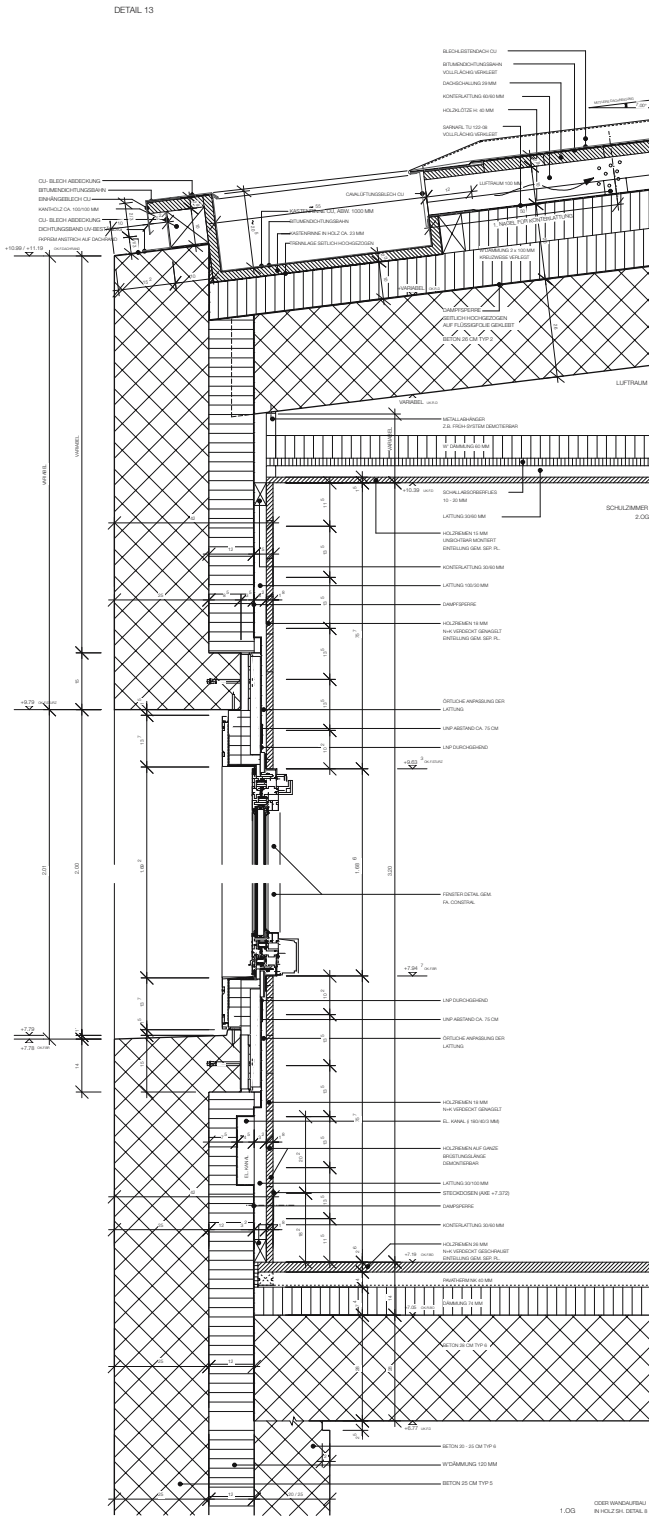


Fig. 150: Section through corridor window, 1:20  
1:5 working drawing (reduced)



Fig. 151: Windows in common areas open outwards

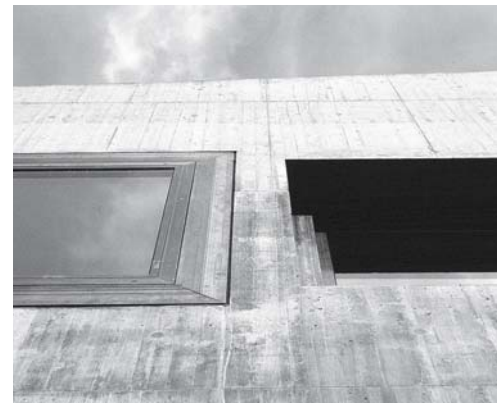


Fig. 152: Contrast between inward- and outward-opening windows

**Floor construction**

Granolithic concrete	20 mm
Screed with underfloor heating	80 mm
Polyethylene sheet	
Thermal insulation	40 mm
Concrete, type 6	280 mm

**Wall construction**

Concrete, type 5	250 mm
Thermal insulation	120 mm
Concrete, type 5	250 mm

**Roof construction**

Sheet metal	
Bitumen roofing felt, fully bonded	
Boarding	29 mm
Counter battens	60/60 mm
Battens	40 mm
Sarnafil TU 122/08, fully bonded	
Thermal insulation, 2 layers laid cross-wise	2 x 100 mm
Vapour barrier	
Concrete, type 2	260 mm

## Volta School, Basel

Miller + Maranta

Judit Solt

### Situation and theme

The St Johann district of Basel is a tense clash of different scales. Residential blocks, the Novartis industrial area, the northern ring road and the St Johann inland port on the Rhine are all found in close proximity. And between these two extremes lies a perimeter block development stretching mercilessly without interruption, plus the massive volume of a former coal warehouse, which has housed oil tanks for the nearby district heating power station since the 1960s.

The reform of the Basel school system and the large influx of newcomers to this part of the city in recent years resulted in an urgent need for new educational facilities here especially. In 1996 the local authority, Basel City, organised a design competition for a school building containing 12 classrooms, the related ancillary rooms and a large sports hall.

The project as constructed is not an attempt at inner-city rehabilitation, but rather the opposite; it highlights the fragmentation of the urban structure at this point in the city. But it mediates with great sensitivity between the various types of use and conflicting architectural scales that meet here.

The powerful presence of the warehouse, which dominates this district, was the starting point for the design. The new school building has been built on the site of a former heavy oil tank. It adjoins the remaining warehouse directly and assumes the same building lines; the only difference is that the new building is taller. The 6 m deep excavation that remained after removing the oil tank has been used to accommodate the sports hall. The open area in front of the school, with its gravel underfoot and canopy

Example

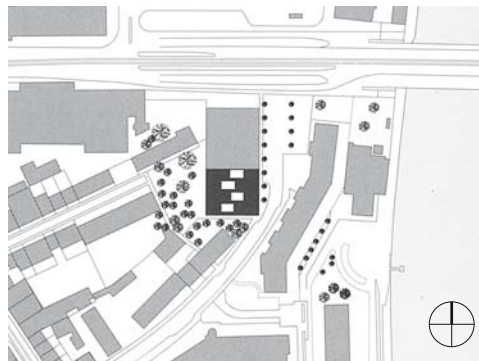


Fig. 154: Site plan

of leaves overhead in the summer, is used by the pupils at break-times but also serves as a common area for the local community.

The fair-face concrete facades help to establish the school building as an interface between the residential and industrial elements. Thanks to the layout of the form-work panels, the facades lend the building a monolithic character, even though the east and west elevations contain large openings. This compactness and the use of wood/aluminium windows fitted flush with the outside face are references to the neighbouring industrial structures, for instance the district heating power station. However, this is not a case of thoughtless industrial aesthetic. Like the adjoining warehouse, the facade concrete's pale yellow colouring has a warm, weathered feel, yet at the same time its fine, smooth character shows it to be something totally distinct.

Extract from: *Archithese* 1.01



Fig. 153: Entrance elevation fronting the open area

Architects: Miller + Maranta, Basel  
 Construction period: 1997–2000  
 Assistants: Peter Baumberger  
 Othmar Brügger  
 Michael Meier  
 Marius Hug  
 Structural engineers: Conzett Bronzini Gartmann,  
 Chur

Jürg Conzett

### Interior layout

The main access to the school is from the open area used by the children at break-times. Much of the entrance hall which runs the full width of the building, can also be opened up to merge with the open area. On one side a staircase leads down to the first basement level containing a viewing gallery for the sports hall and the cloak-rooms, and from there a second staircase leads down to the sports hall at the second basement level. The stairs to the first floor, which accommodate common areas, are on the other side of the entrance hall. Two smaller staircases lead to the other floors above.

The layout of the other floors is essentially determined by the depth of the building and the loadbearing walls. The four room "bands" have a simple form: a classroom on the facade and the adjoining generously sized atrium, opposite this a room for special teaching requirements. However, the result is complex: a maze of corridors spreading out from the atria, but providing interesting views – into the atria, into the surroundings, into the classrooms and often even straight through several room "bands". This guarantees orientation at all times, but is also a spectacular demonstration of the unique character of an urban district split between residential and industrial uses.

The entrance to the school building is on the "residential side" of this district, where small structures prevail and where only the district heating power station with its



Fig. 156: Classroom and atrium, with a view of the inland port on the Rhine in the distance

100 m chimney provides a clue to the abrupt alternation in the structure of the local developments. We see more and more of the other side of the city as we climb higher and higher within the school. We can see as well the industrial buildings and the cranes of the inland port on the Rhine, whose unexpected size suddenly makes us realise how near they are. This setting helps to illustrate the impressive change of scale and opens up new perspectives for this district in the truest sense of the word.



Fig. 155: Access corridor with atria on both sides



Interior layout



Fig. 157: Section, 1:500

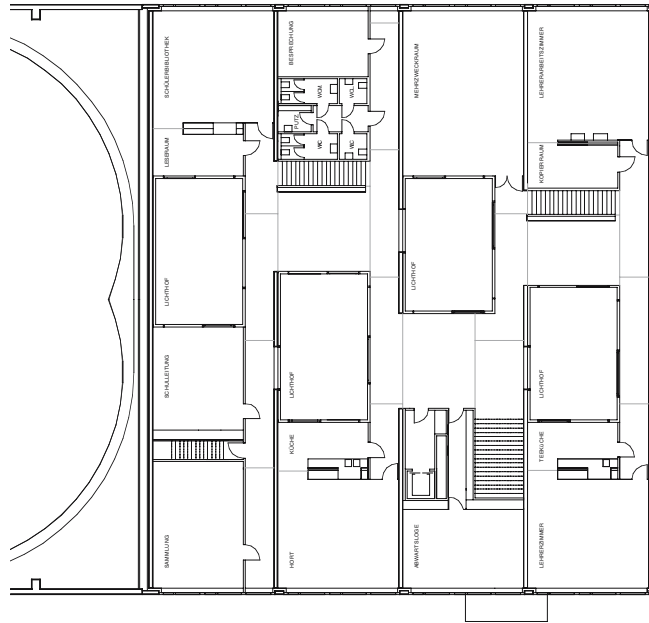


Fig. 158: Plan of 1st floor, 1:500

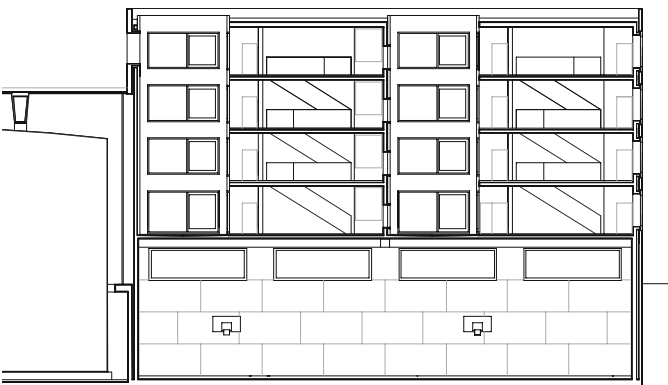


Fig. 159: Longitudinal section, 1:500

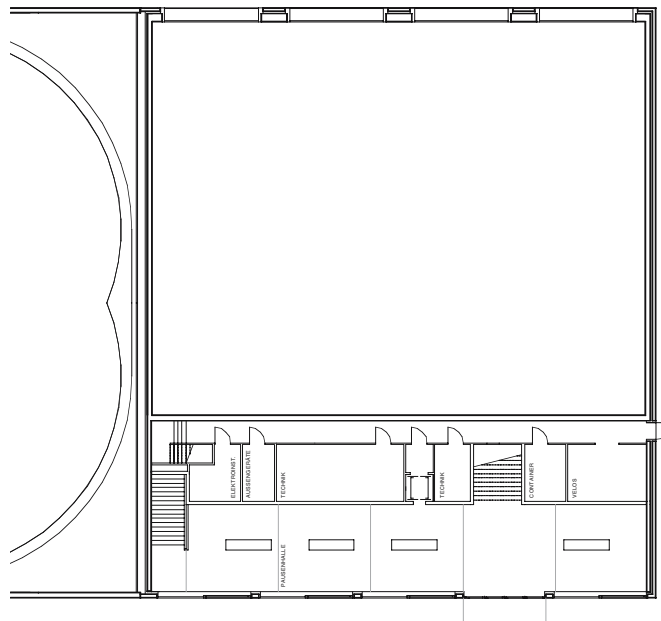


Fig. 160: Plan of ground floor, 1:500

### The structural system

The mixed usage of the building – the large open sports hall with several storeys of smaller room units above – and the large depth of about 40 m led to an unconventional reinterpretation of monolithic construction. The structural system developed in conjunction with the Chur-based consulting engineers Conzett Bronzini Gartmann AG involves the composite action of concrete flat slabs (i.e. no downstand beams) and walls. The two parallel walls of the sports hall carry a slab which spans 28 m and cantilevers 12 m in the direction of the open area fronting the school. This slab in turn supports the loadbearing walls which divide the building into four room “bands”. Bending moments are resisted by prestressing.

The man-made link between separating and supporting – intrinsic to monolithic construction – leads to a particular concentration of significance for every single element. This is especially relevant when, as with this building, the structural concept and internal layout are conceived as a single entity. It is interesting that the construction principle employed here permits walls to be supported only at a certain place, and hence reveals new interior layout options in monolithic construction that are worth exploring.

The construction principle behind this building remains discernible without becoming oppressive. The facades ensure the stability of the building in the longitudinal direction; however, they are non-loadbearing and are connected to the loadbearing structure only at discrete points. One of the places where this can be seen is on the west elevation, where the grid lines are displaced. The



Fig. 162: Shear wall showing reinforcement and prestressing tendon

materials used also point to the structural principles: the loadbearing elements – slabs and walls – are in fair-face concrete, contrasting with the non-loadbearing elements employing lightweight construction techniques.

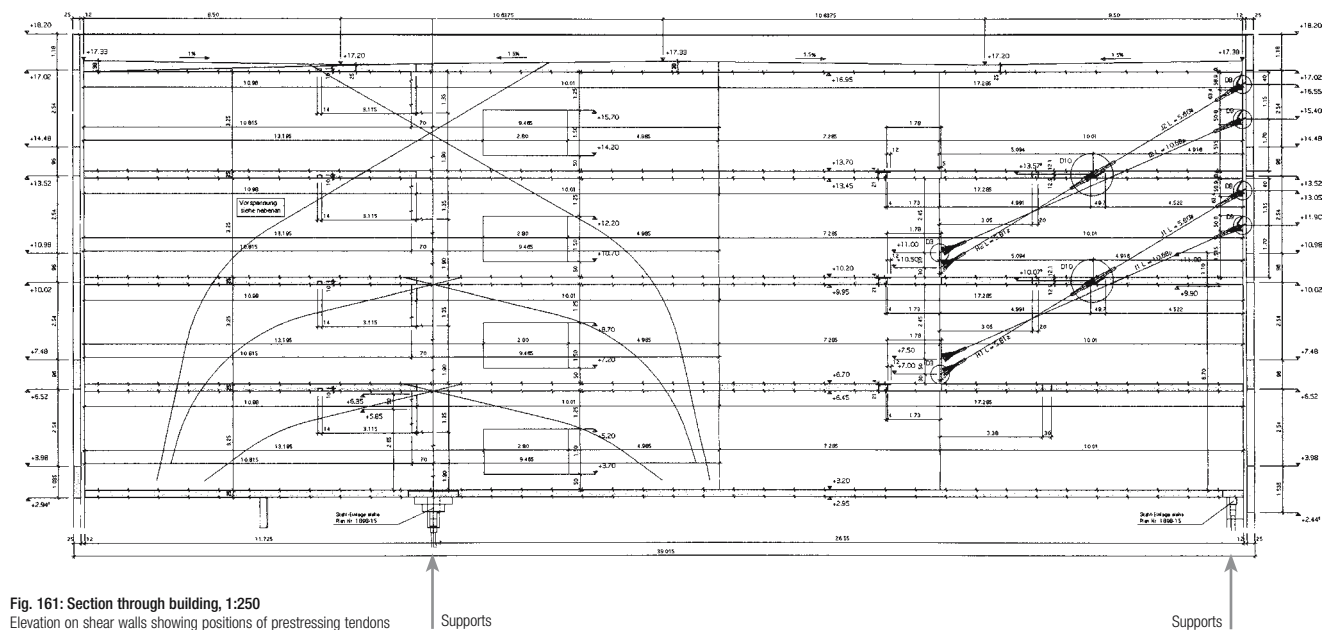


Fig. 161: Section through building, 1:250  
Elevation on shear walls showing positions of prestressing tendons



Fig. 163: East facade

### External and atrium facades

#### *External facades*

The design of the facades is not essentially dictated by the internal layout behind. The facade is basically a single-leaf construction attached to the loadbearing wall behind only at individual places. Without expansion joints and structurally autonomous, it embraces the loadbearing walls like an independent skin. Using the same material for the facade and the walls prevents an ambiguous, fragmented realisation.

Neither the internal layout nor the enormous room depths are apparent on the fair-face concrete facade. The metal-framed windows are arranged in horizontal bands.

Internally, the contrast between structure and fitting-out is reduced to the simple complementary elements of shell and lining, which means that the structural efforts are hardly perceptible.

#### *Atrium facades*

The atria have a cladding of wood-based panels in a mother-of-pearl colour and wooden windows fitted flush with the outside face. Together, these create the effect of polished, compact inclusions in a concrete monolith.



Fig. 164: Atrium



Fig. 165: East elevation showing layout of formwork panels, 1:500

External and atrium facades

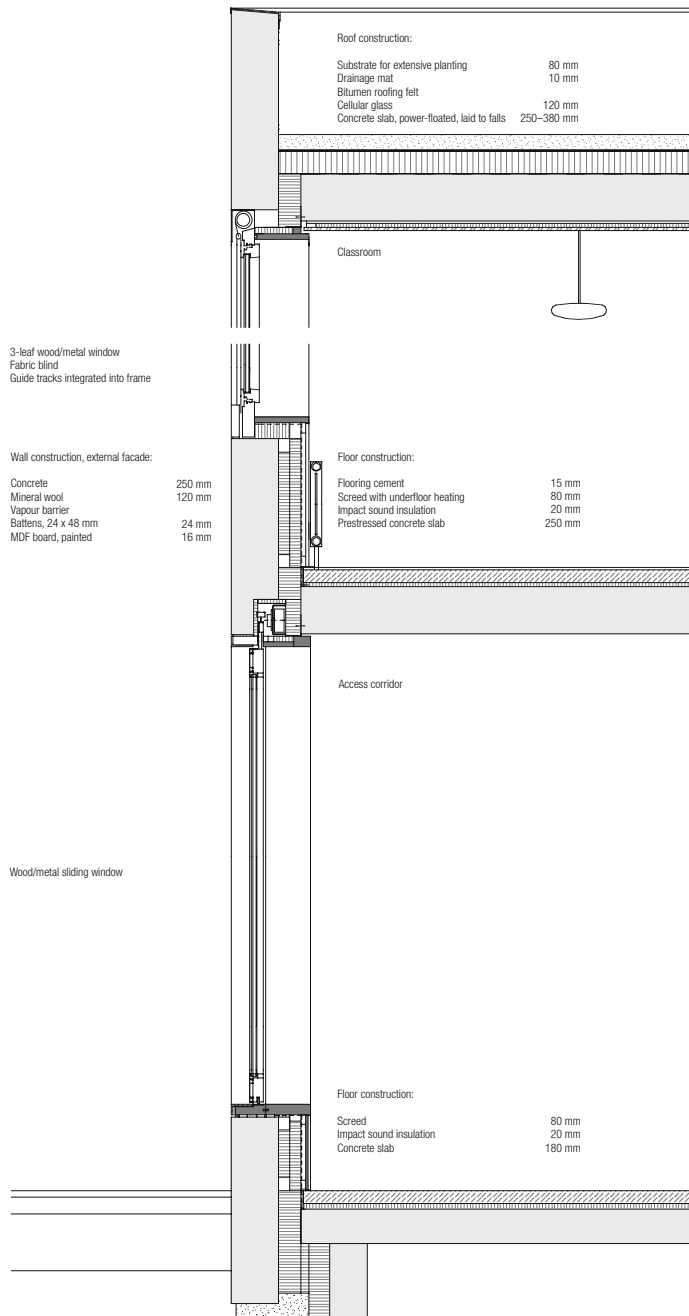


Fig. 166: Section through external facade

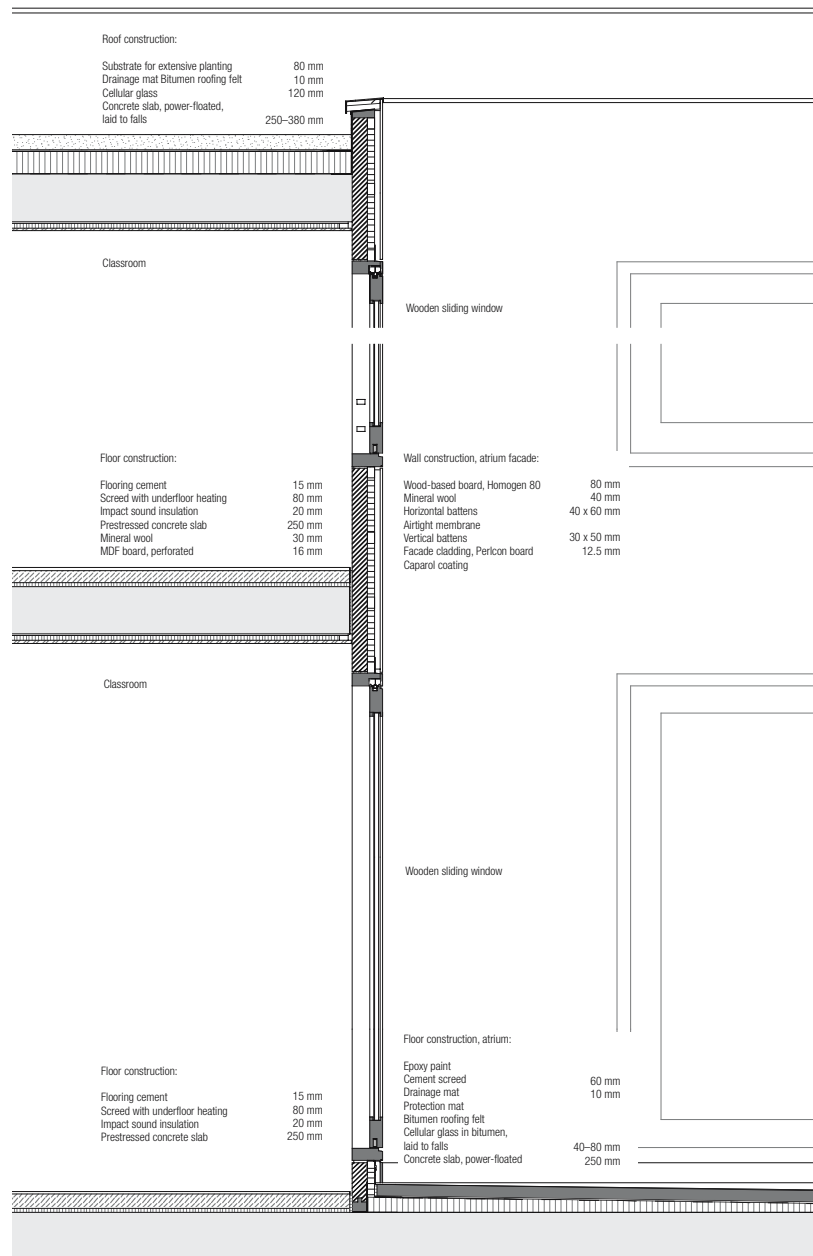
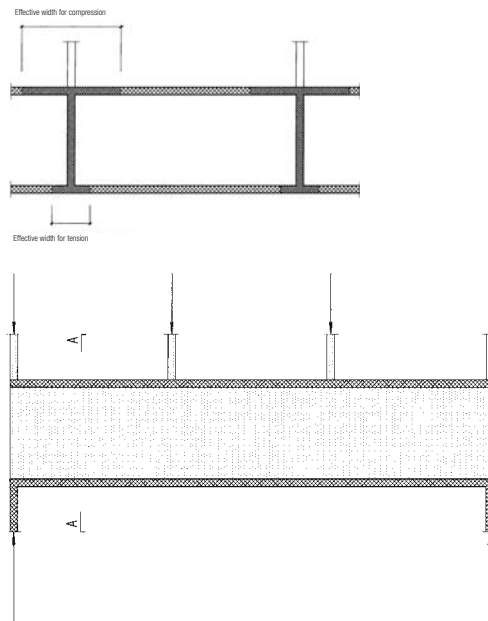


Fig. 167: Section through atrium facade





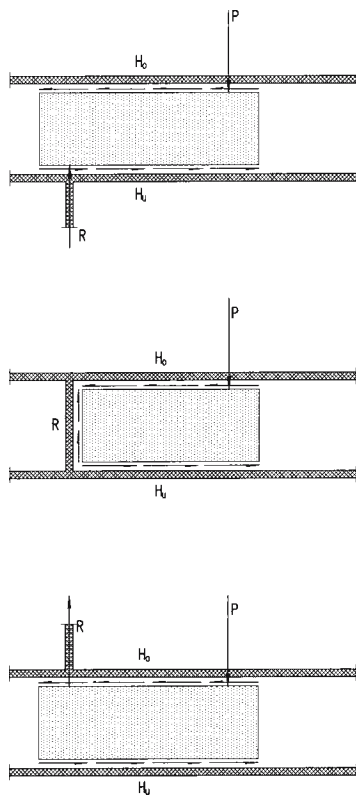


**Fig. 168: Shear wall schemes**  
Loadbearing shear walls acting as transfer structures for individual columns (elevation and section)

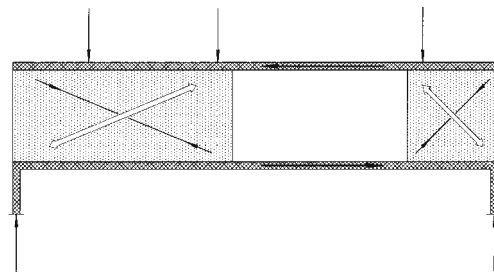
**Remarks on the structural system**  
**“Shear diaphragms in buildings”**

The idea of using walls and floor slabs as interconnected, loadbearing elements in buildings is not new. This principle, however, is used mainly only locally, when other options prove inadequate, e.g. in transfer structures or cantilevers for heavy storeys. But when employed systematically as a constructional concept for a building, this approach can result in useful solutions, particularly with complicated internal layouts, and thus present a rational alternative to a framed building.

We shall start by looking at a reinforced concrete wall plate constructed monolithically with the floor slabs above and below. Such a wall plate can be considered, for example, as an I-section beam, transferring the loads of a row of columns into the external walls (fig. 169). Far more interesting and more versatile applications are, however, possible if we exploit the fact that in most instances the floor slabs of a building are supported on an internal core and external walls such that they are held in position horizontally. If this condition is satisfied, then it is sufficient to support a wall plate at just one point, any point, in order to turn it into a stable, unyielding loadbearing element (fig. 170). The beam in fig. 168 can therefore be split into two individual wall plates of different sizes without suffering any loss in load-carrying capacity (fig. 171).



**Fig. 169: Shear wall schemes**  
Shear wall as unyielding structural element with single discrete support. The rotational effect of load P and support reaction R is eliminated by the horizontal couple  $H_0$  and  $H_u$  generated in the floor slabs.



**Fig. 170: Shear wall scheme**  
Beam consisting of two non-identical shear walls

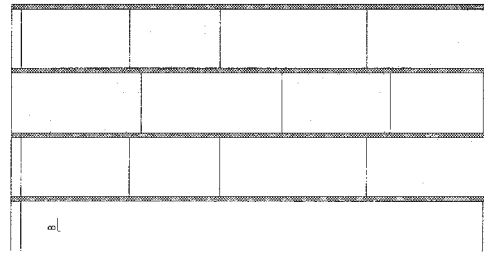


Fig. 171: Planar unyielding wall systems (system A)

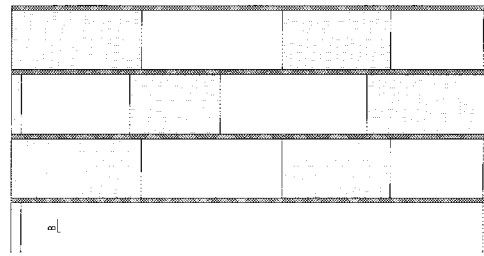


Fig. 172: Planar unyielding wall systems (system B)

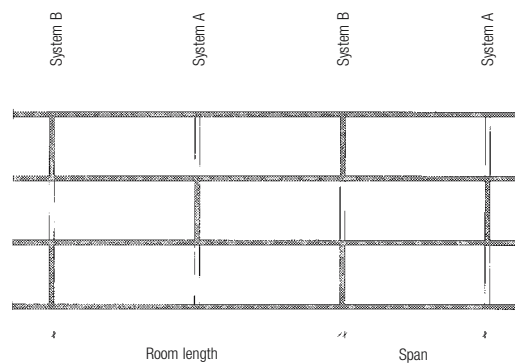


Fig. 173: Section B-B through a row of several systems as shown in Figs 171/172

However, keeping in line with the aforementioned condition, the unequal horizontal forces that are transferred from the wall plates into the floor slabs must be able to continue down to the foundations via stiff cores or external walls. The floor slabs are loaded in two different ways: on the one hand they act structurally as slabs which transfer the forces from distributed loads to the loadbearing wall plates by way of bending (this is the conventional structural action of floor slabs), and on the other they also act as plates in conjunction with the walls (and in doing so assume a role similar to that of the flanges of a rolled steel beam section). The floor slabs become then interactive loadbearing elements which realise several structural functions simultaneously. Interactively loaded components have long since been common in bridge-building. For example, the road deck of a box girder bridge acts as a slab transferring the wheel loads transverse to the axis of the bridge into the webs of the box, while at the same time acting as the upper flange in the longitudinal direction of the bridge. In buildings the stresses due to the plate effect are generally so low that conventional design based on bending of the slab is sufficient to determine the thickness of the floor slab. The plate forces then need to be considered only when sizing the reinforcing bars.

An unyielding wall plate can also serve as a support or suspension point for another plate. In this way we can build complete systems of unyielding plates (figs 171 and 172). As already mentioned, it is sufficient when the plates make contact at one – any – point. The floor slabs are either supported on or suspended from the wall plates. Wall plates above or below are equally useful as supports; by choosing complementary wall plate systems the span of the floor slab can be reduced, possibly to just half the length of the room (fig. 173).

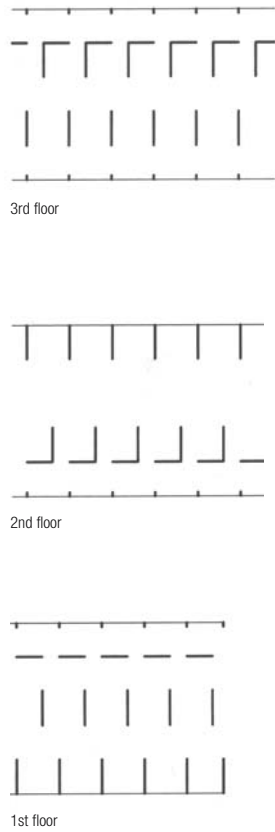


Fig. 174: Plans on schemes in axonometric view below

Systems of unyielding wall plates are not confined to just one level. Individual plates can be cranked or rotated with respect to each other without diminishing their structural effect or making them more complicated to build (fig. 175). As long as we maintain the conditions of the horizontally unyielding floor slabs and the wall plates held at one point at least, numerous combination options ensue. Nevertheless, only the components already provided are used to transfer the forces; ribs, downstand beams or linear structural members are unnecessary.

Several examples investigated in detail show that in buildings of three or more storeys unsupported spans of up to 40 m are possible without any inappropriate effort. The thickness of the concrete wall plates in these cases is between 200 and 350 mm. The planning and execution of such a system is simple and economic, but does require close cooperation between architect and engineer from the very beginning, and leaves little room for improvisation.

Excerpt from: *Werk, Bauen+Wohnen* 9/97

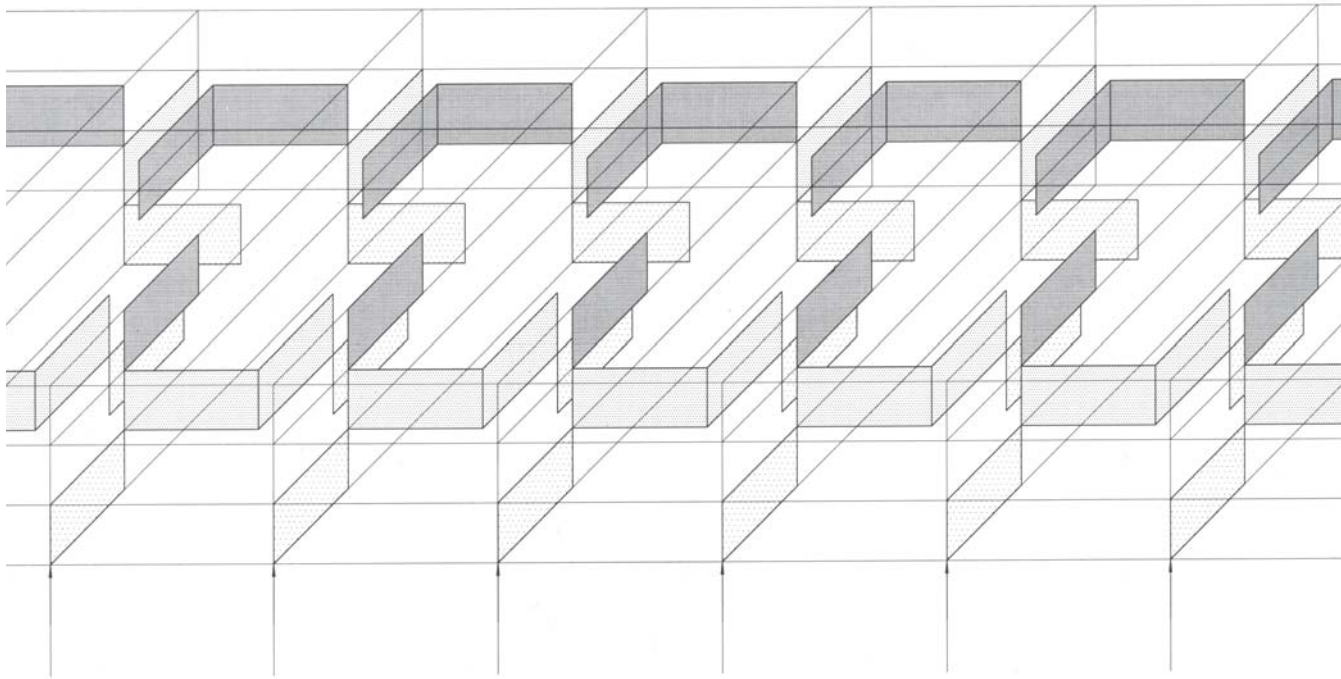


Fig. 175: Axonometric sketch showing the principle of a three-dimensional system of unyielding shear walls

## Sihlhof School, Zurich

Giuliani Hönger

Lorenzo Giuliani, Christian Hönger,  
Patric Allemann

### Concept, urban integration

The concept is distinguished by the great complexity of the brief: two different polytechnics with very extensive and – when planning started – not fully defined interior layouts had to be realised within a single building in a central location. In order to minimise the design and building time, this large new building had to comply with the applicable building regulations; there was insufficient time to apply for a lengthy architectural design approval procedure. Nevertheless, the aim still was to create a convincing urban and architectural statement within this heterogeneous context.

Starting with the maximum volume allowed by the building regulations, the building was given a distinctive form compared with its variegated surroundings. A five- to seven-storey facade in a large-scale format was built facing Lagerstrasse. This abuts an office building – protected by a preservation order – dating from the 1950s by way of a respectful “joint”. At the back the building steps down towards the smaller neighbouring buildings, thus matching their scale. The projections allowed for in the building regulations enabled this terracing effect to be devised in such a way that the building gains a sculpted character but still appears as a coherent unit. Exploiting the outlines more or less to the full results in

Architect: Giuliani Hönger, Zurich  
Construction period: 2001–2003  
Project management: Lorenzo Giuliani  
Christian Hönger  
Marcel Santer  
Site management: Bosshard + Partner, Zurich  
Structural engineers: Dr Lüchinger + Meyer, Zurich



Fig. 177: Site plan

the maximum possible volume for the ambitious interior layout.

Like the shape of the building, the facade also interprets its urban context. On the one hand, the beige-coloured reconstituted stone cladding enables the building to blend into its surroundings. While on the other, the minor variations in the width of the piers between the windows, the dominant feature of the facade, leaves a slightly odd impression and thus enables the university building to take on its own character.



Fig. 176: View from Kasernenstrasse

The main entrance is emphasised by the cantilevering lecture theatre above. On the left the “joint” between the new building and its neighbour.





Fig. 178: View of rear of building

### Internal layout

Two offset atria help to handle the great depth of this building. The two are connected at one point and so become a coherent structure which – in a similar way to the atria at Zurich University and in the central hall in the main building of the ETH University – creates a powerful identity. Depending on the observer's position and viewing angle, this element is perceived either as one "cranked" internal space or as two separate inner courtyards. In line with this dual usage each atrium is associated with one of the polytechnics. Whereas the Business and Management School is arranged around the upper atrium (lit from above), the Teacher Training College surrounds the lower atrium (illuminated by diffuse light from the sides). With their generous vertical dimensions, these are quality urban inner spaces ideally suited to the inner workings of such an educational establishment.

The single, large lecture theatre is positioned over the entrance so that it can be reached from both polytechnics via a small foyer but is also accessible to external users. By projecting a little beyond the line of the facade it helps direct the eye towards the main entrance and defines the entrance area before this expands upwards in the form of the first atrium.

Whereas the lecture theatre, a special-purpose room, is slotted into the plan like a piece of a jigsaw, the seminar and study rooms trace the lines of the various facades. Winding access corridors are the outcome of this plan layout, the atria and the adjoining ancillary rooms. The facade steps back as we proceed up the building, as do the positions of the corridors. Their layout also has to



Fig. 179: Lower atrium  
At top right the entrance to the foyer of the lecture theatre

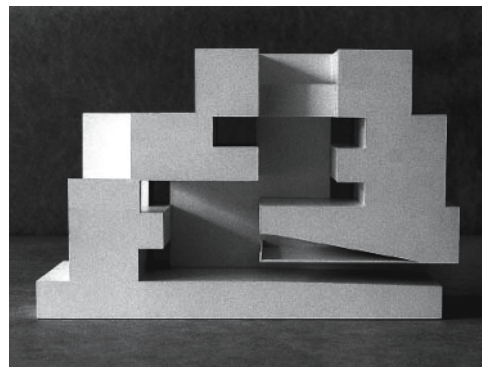


Fig. 180: Sectional model  
Upper and lower atria join to form one interior space

take account of the two atria. But thanks to the recurring references to the atria, orientation remains straightforward despite the complexity of the internal layout. To minimise the space for the staircases, these are kept simple, which is a boon to the atria. All three staircases also serve as escape routes.

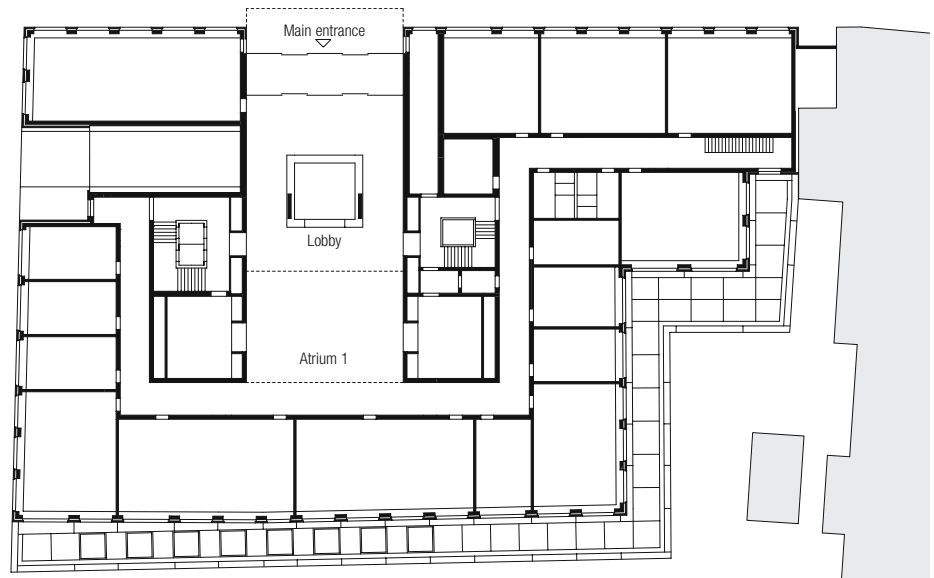


Fig. 181: Plan of ground floor, 1:600



Fig. 182: Plan of 1st floor, 1:600



Fig. 183: Plan of 2nd floor, 1:600

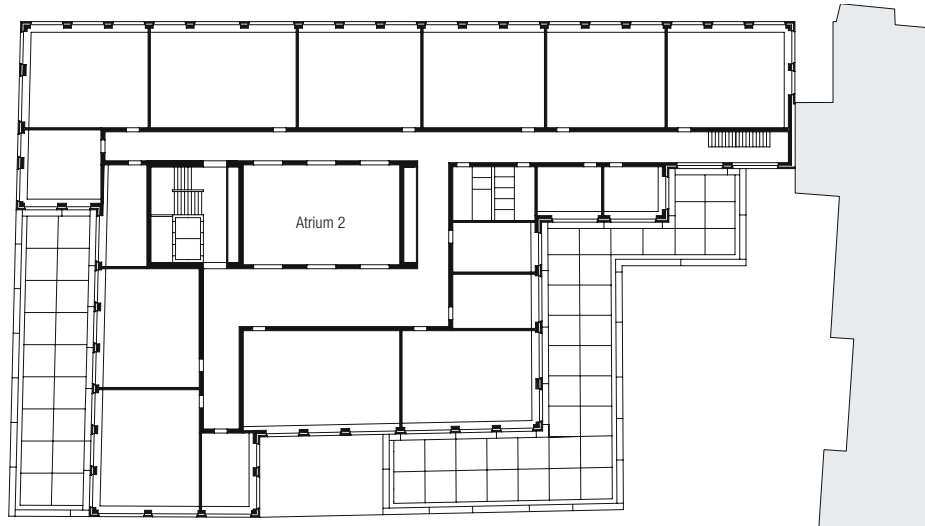


Fig. 184: Plan of 3rd floor, 1:600

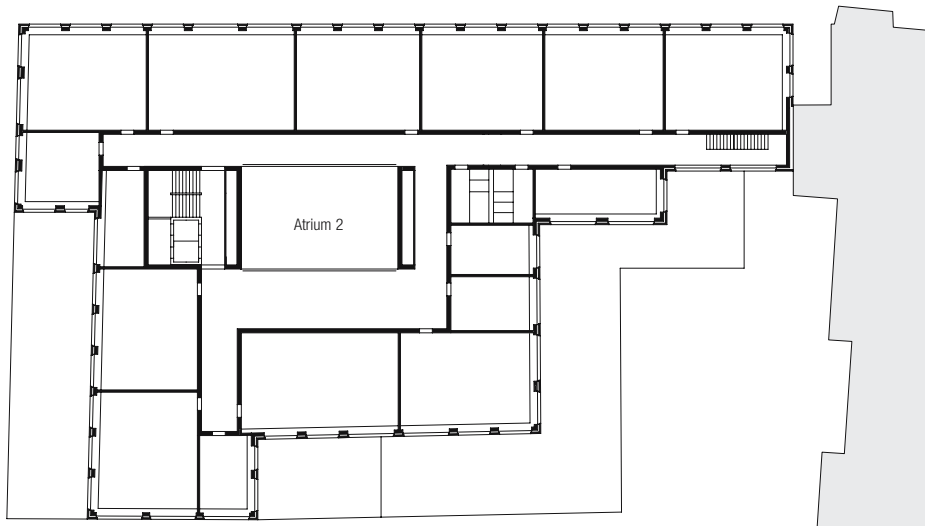


Fig. 185: Plan of 4th floor, 1:600

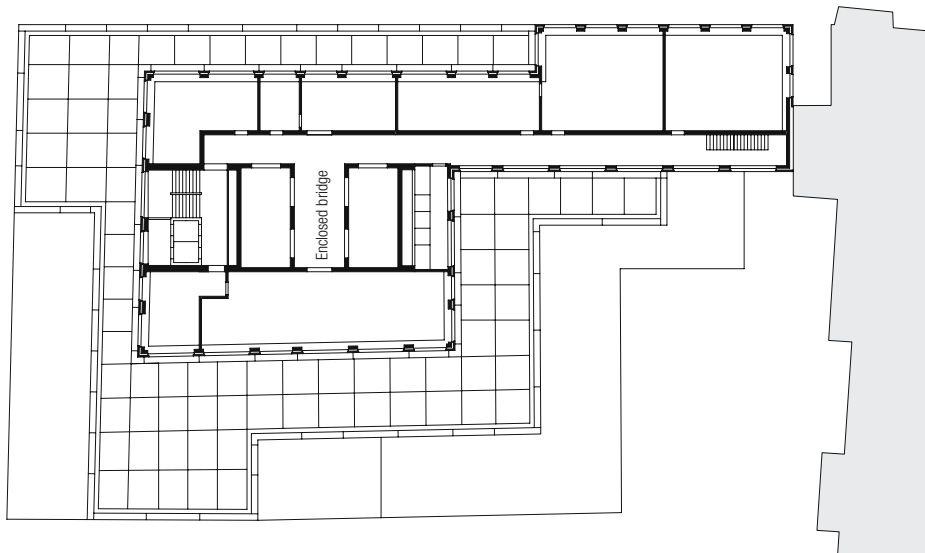


Fig. 186: Plan of 5th floor, 1:600

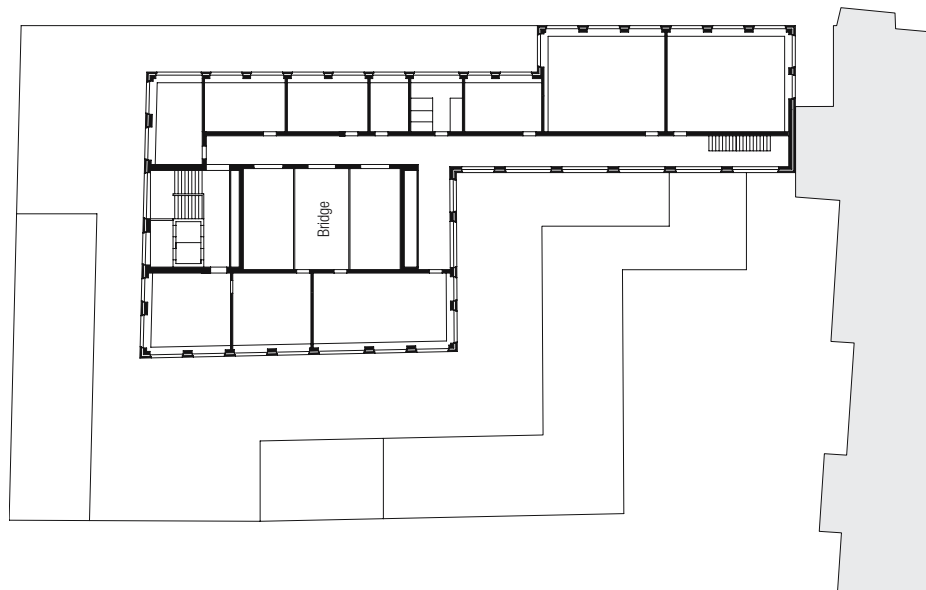


Fig. 187: Plan of 6th floor, 1:600

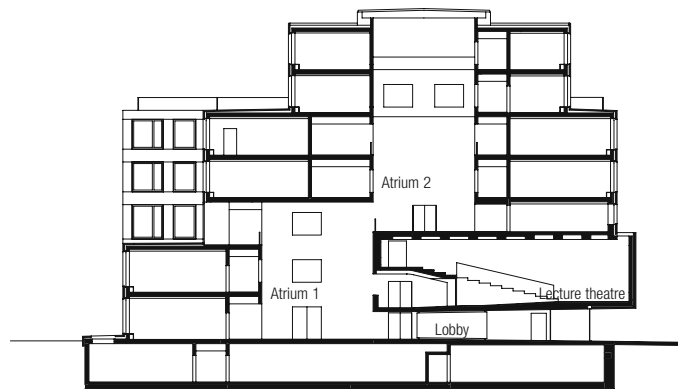


Fig. 188: Section, 1:600

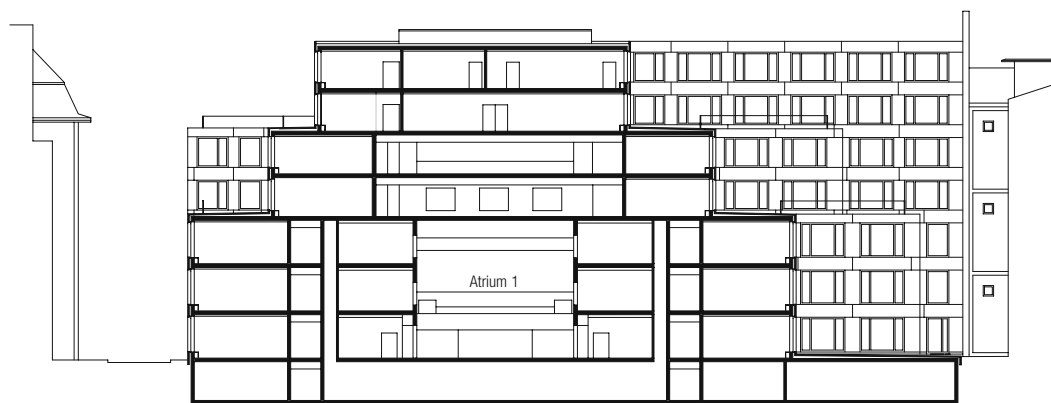
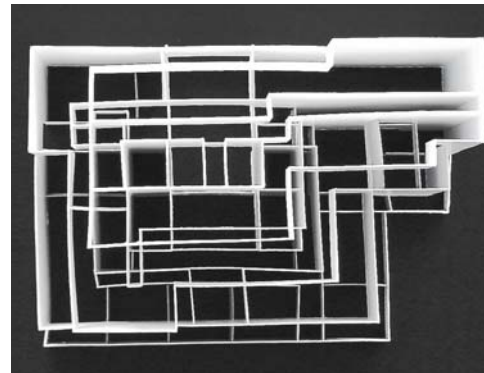
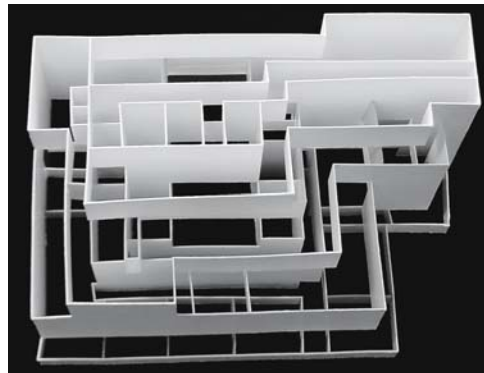


Fig. 189: Longitudinal section, 1:600





**Figs 190 and 191: Model showing principle of vertical loadbearing structure**  
The loadbearing walls are stacked in different positions with respect to each other and intersect storey by storey.



**Fig. 192: Upper atrium, looking down towards entrance level**  
The walls without intermediate supports act as storey-high deep beams.

### Loadbearing structure

The terracing at the back of the building and the offset atria leaves the structure with only a few vertical loadbearing walls that pass through all storeys. Loadbearing walls of reinforced concrete stacked cross-wise make up the primary vertical loadbearing elements. At the same time these act as the facades and the fair-face concrete walls to the meandering access corridors (see figs 190 and 191). The loads are directed into the loadbearing walls and then accumulate at the intersections, from where they continue on their downward journey to the foundations.

In this system the door and window openings in the wall plates represent a problem. In order to maintain the structural integrity it is necessary to include top and bottom chords (door and window lintels, door thresholds, spandrel panels) at all openings and/or adequately sized floor slabs. Therefore, on the terracing at the back of the building the severely perforated loadbearing walls in the facade act compositely with the 300 mm thick reinforced concrete floor slabs. Around the atria the concrete walls have fewer openings and can therefore span further. Some of the slabs, e.g. over the lower atrium or the floor of the lecture theatre, are suspended from these loadbearing walls.

Despite the ambitious structural aspects the strict architectural requirements governing the formwork layout and the surface quality requirements for the fair-face concrete walls internally still had to be fulfilled.

The groups of seminar and study rooms can be flexibly subdivided, despite the monolithic construction, within the limits imposed by the fenestration and the doors in the walls to the corridors.

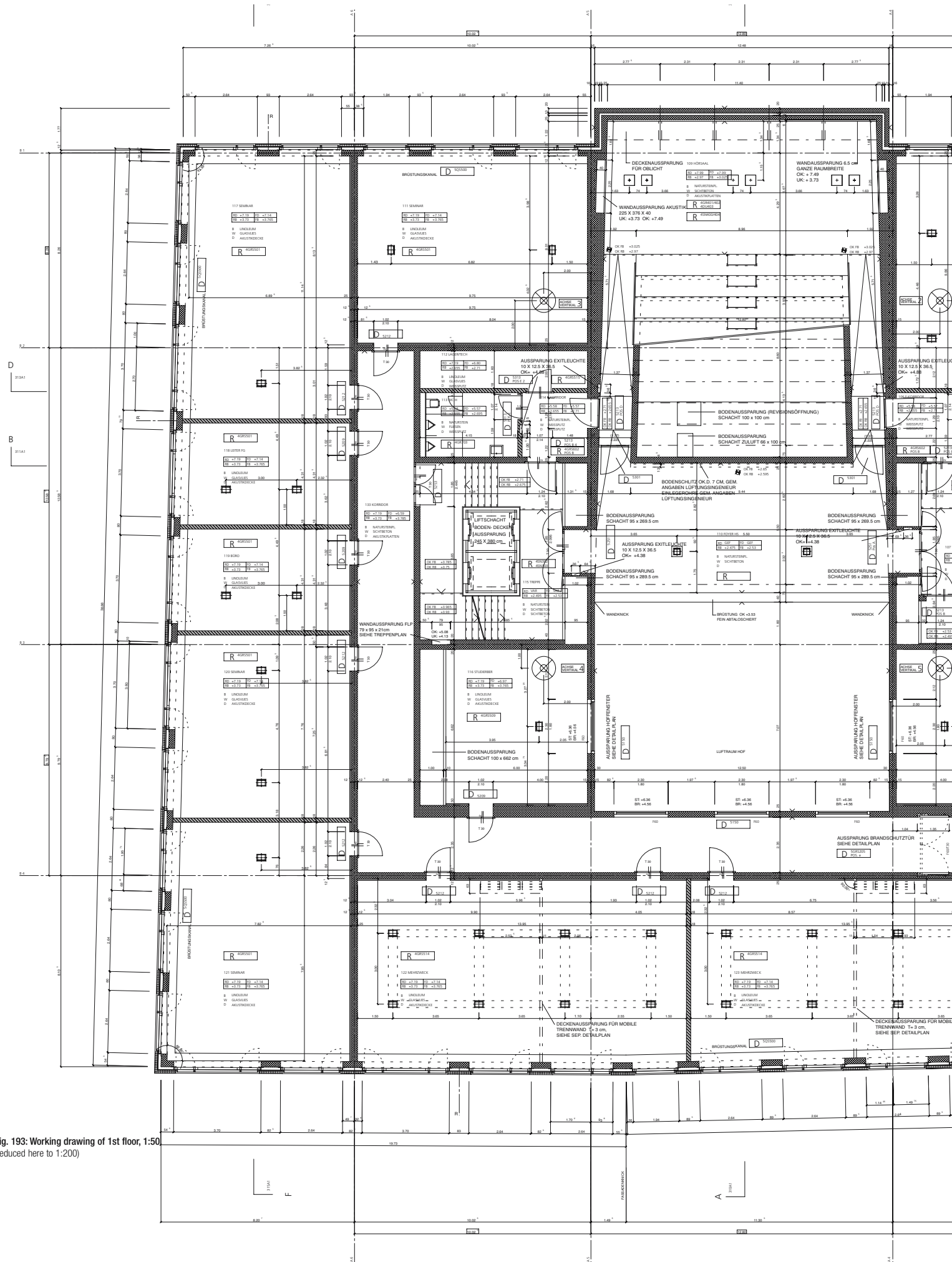


Fig. 193: Working drawing of 1st floor, 1:50  
(reduced here to 1:200)





### Materials and design

Both the facade and the terraces are clad with prefabricated polished reconstituted stone panels. The beige-yellow colouring of the Jurassic limestone exposed by the polishing provides a reference to the colours of neighbouring buildings like the post office and the office building on the corner (protected by a preservation order). The facade makes use of vertical piers and horizontal spandrel elements of a similar size suspended like a curtain wall in front of the structural members. The joints are sealed. At first sight we appear to be viewing a large-scale structural facade. But owing to the displacement of the piers from floor to floor, attributable to the internal layout, a closer inspection reveals a new type of appearance which, compared with conventional grid-like facades, loses much of its rigidity. The edges of the 120 mm thick reconstituted stone panels are never visible. All corners and edges are

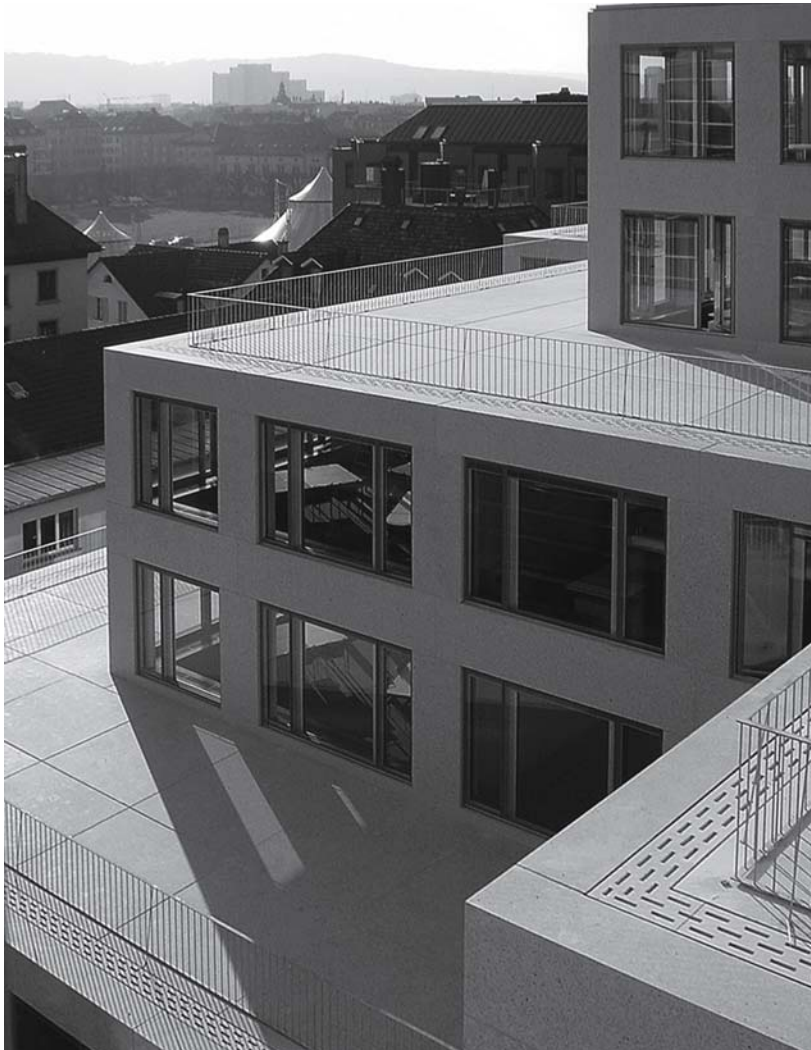


Fig. 194: Terracing at rear of building

Terraces and facades are finished with polished reconstituted stone panels; corner and edge pieces are three-dimensional elements.



Fig. 195: Seminar room

formed with three-dimensional elements, which reinforces the corporeal appearance of the building.

The three different sizes of window employ the double window principle. Whereas the inner window completes the building envelope in terms of thermal performance requirements, the outer window provides acoustic insulation and protection for the sunblinds fitted between the inner and outer windows. The windows are set back with respect to the cladding, which establishes a delicate relief and introduces a subtle play of light and shade on the facade.

Light-coloured fair-face concrete walls and stone floor finishes in Venetian trachyte make it very clear that the architects intended the atria and access zone to serve as urban spaces. Taking up this logic, the lecture theatre – a place of assembly – employs the same materials. To contrast with this, the seminar rooms have linoleum or carpeting on the floors, white-painted glass-fibre wallpaper on the walls, wooden doors and wooden window seats to create a more homely atmosphere. The floor slab thickness of 300 mm necessary for structural reasons meant that all floor finishes could be laid directly on the floated concrete without the need for impact sound insulation or screeds. The (long) drying time normally required for screeds was thus unnecessary and this shortened the construction time considerably.



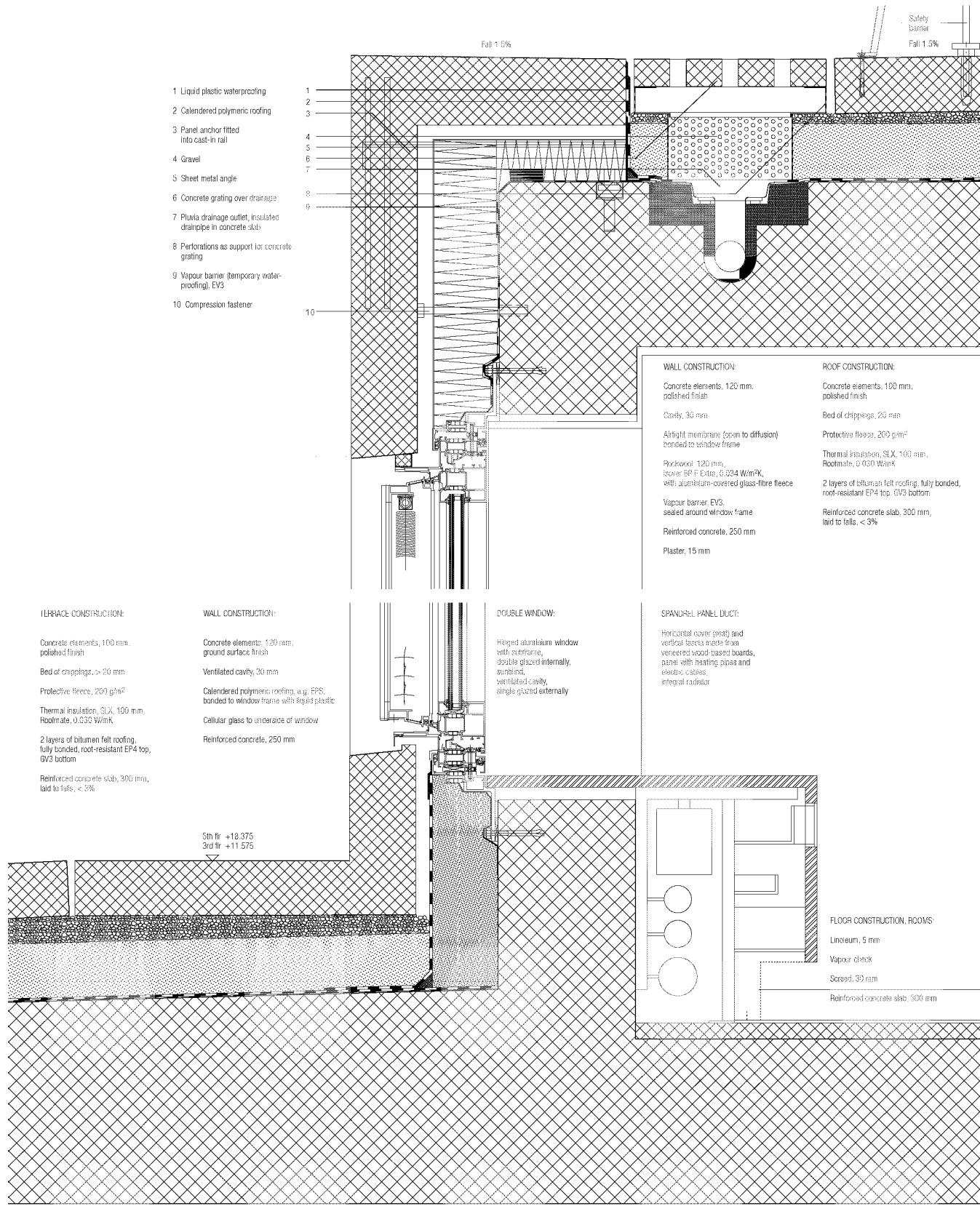


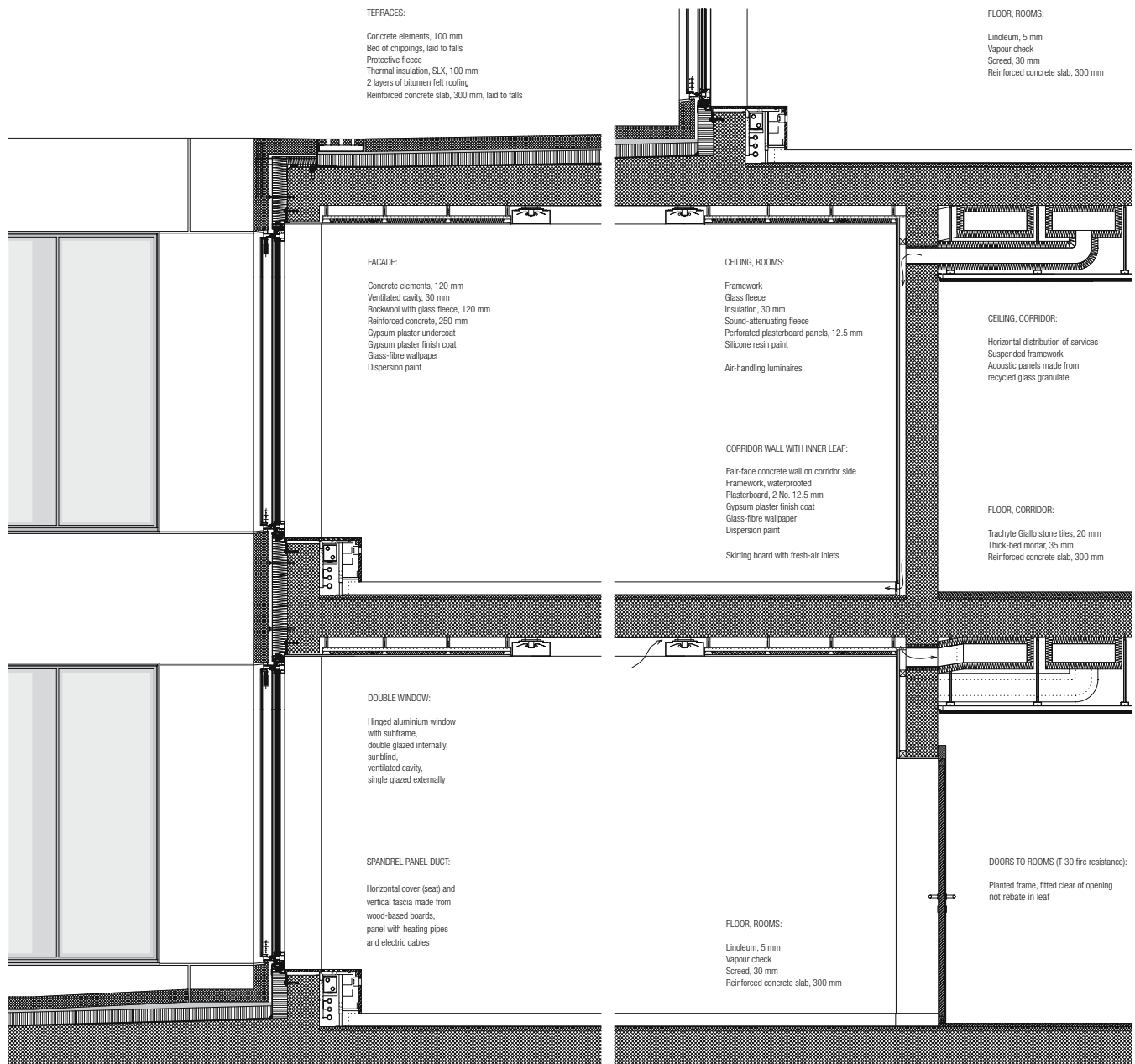
Fig. 196: Section through edge of terrace (top) and junction with facade, 1:5 (reduced here to 1:10)

### Building services

The use of thick, solid floors increases the active storage mass significantly and, thanks to the heat storage capacity, improves the comfort in the interior at all times of the year. All seminar rooms are mechanically ventilated for reasons of comfort (high noise levels on Lagerstrasse), but natural ventilation (by opening the windows) nevertheless remains possible. Air-conditioning is used in the lecture theatre and the IT training rooms. Louvre blinds provide sunshading which is controlled according to the level

of daylight. This helps to achieve an optimised energy balance. Heat generation and distribution is by conventional means. As the use of the building calls for the temperature control to respond rapidly, space heating is by means of radiators fitted along the spandrel panels.

Supply- and exhaust-air ducts are routed in the suspended ceilings over the access corridors. Electric cables, heating pipes and the IT network cables run in the ducts along the spandrel panels.



**Fig. 197: Section through seminar room and corridor**  
Services are routed in ducts along the spandrel panels and above the suspended ceiling over the corridor.

## “Im Birch” School, Zurich

Peter Märkli

Marius Hug

### Zentrum Zurich Nord

The restructuring and relocation of production for the industries based in Oerlikon marked the starting point for rapid changes to an inter-city area measuring some 60 hectares in size. The existing, large-scale manufacturing buildings and their development pattern, along with the siting of four different open, recreational areas – part of the overall planning concept – defined the formal structure for ongoing urban redevelopment. These guidelines were the result of an urban planning competition held in 1992 for the Zentrum Zurich Nord, a new city district designed to provide homes for 5,000 and jobs for 12,000.

The “Im Birch” School, situated on the northern boundary of the area covered by the plans, is the largest school complex in Zurich. It provides facilities for 700 pupils within two predefined building complexes, each with a stipulated maximum building height. The magnitude and complexity of the use requirements, the result of combining several stages of education under one roof (nursery,

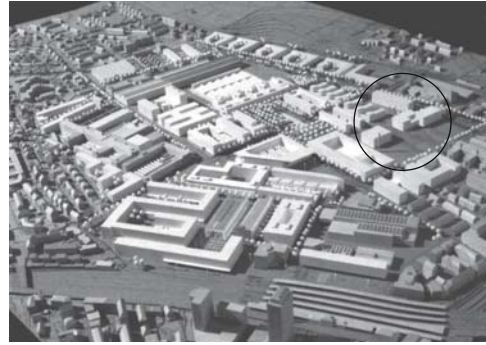


Fig. 198: Photo of model  
Zentrum Zurich Nord, after completion, 1:1000, view from south

primary school and secondary school, plus after-school care facilities, common areas and sports hall), placed high demands on the layout of the school. At the same time, the design had to be flexible enough to take account of future requirements while allowing for the needs of current teaching methods.

Fig. 199: General view of school buildings



Architect: Peter Märkli, with Gody  
Kühnis, Zurich  
Construction period: 2001–2004  
Project management: Jakob Frischknecht  
Christof Ansoerge  
Landscape architects: Zulauf Seippel Schwein-  
gruber, Baden  
Structural engineers: Bänziger + Bacchetta +  
Fehlmann, Zurich  
Main contractor: Die Bauengineering AG,  
St Gallen

### Situation

Peter Märkli placed two buildings on the plots, one rather flatter and elongated, the other more compact and taller. The relationship between the two buildings is quite definite thanks to their positioning and the volumetric "subtractions"; they are seen as one coherent, sculpted figure. The more northerly building is divided into two distinct parts: the sports hall and a four-storey wing. The latter houses the primary school and the common facilities such as a multi-purpose hall, library and dining hall.

The four-storey building (with a ceiling height of 3.5 m in contrast to the 3.0 m of the northern building) on the southern plot contains the secondary school and the nursery, and together with the covered bicycle racks marks the southern limit of the development. The forecourt forms part of the overall plan for the open areas and also serves as a link between Oerliker Park and Friedrich Traugott Wahlen Park to the east. Large-format in situ concrete

slabs create a coherent paved area which – due to the choice of materials and the form – stands out clearly from the neighbouring paths and roads, positioning the school complex as a distinctive public facility in the Zentrum Zurich Nord.

Together with the adjoining developments and the parks, the volumetric arrangement of the complex defines external areas with changing boundaries. This is a strategy that helps provide the individual levels of education within this large complex with their own access zones and their own external areas. At the same time, it helps to integrate this group of buildings into its environment.

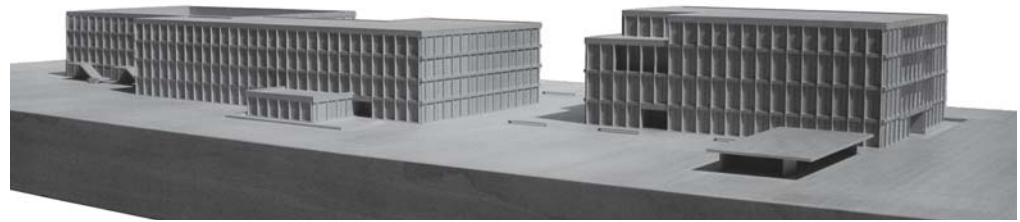


Fig. 200: Model, 1:500

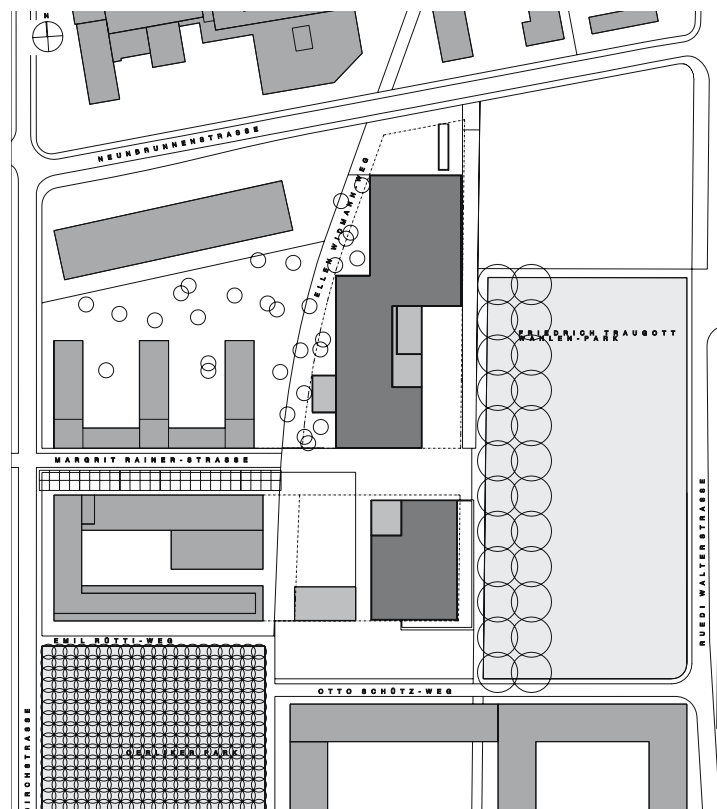


Fig. 201: Site plan, 1:3000



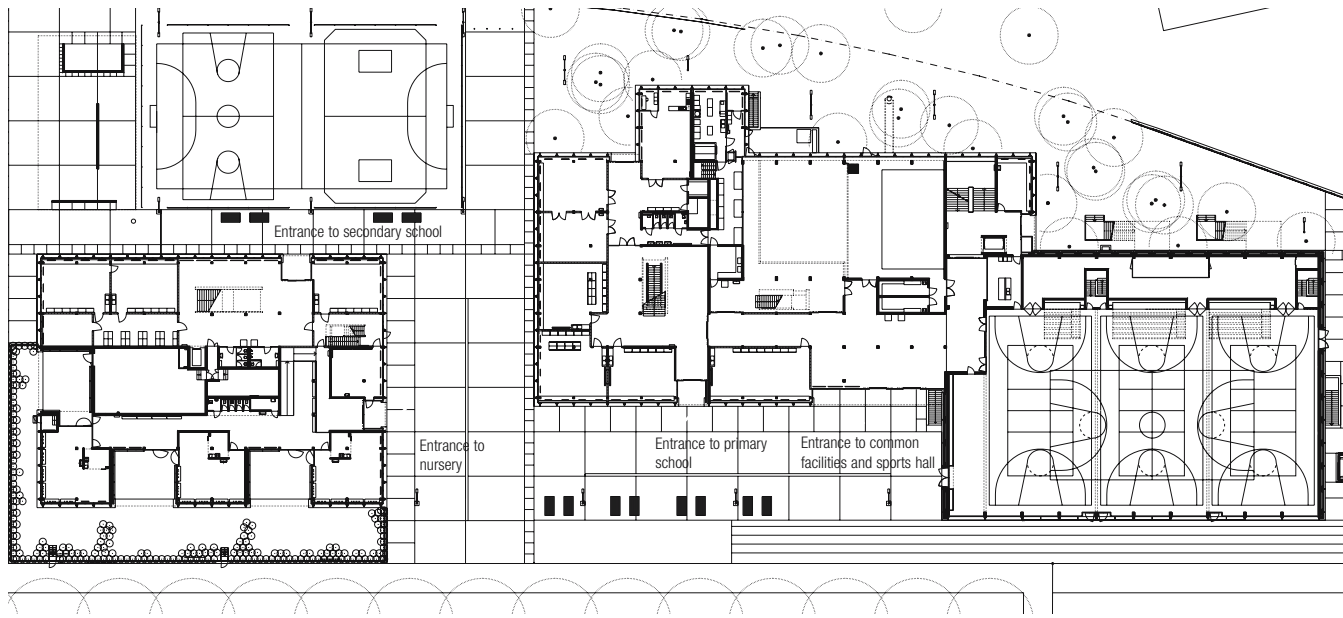


Fig. 202: Plan of ground floor

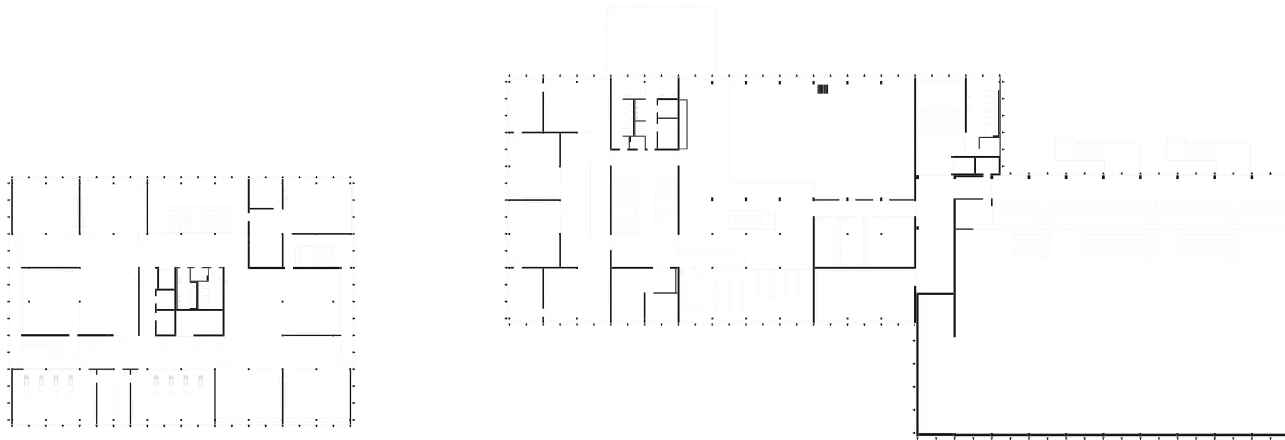


Fig. 203: Plan of 1st floor

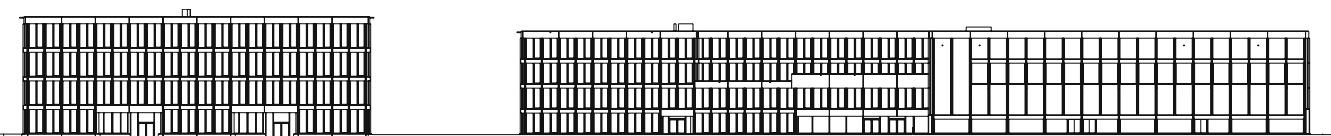


Fig. 204: East elevation

1: 1000

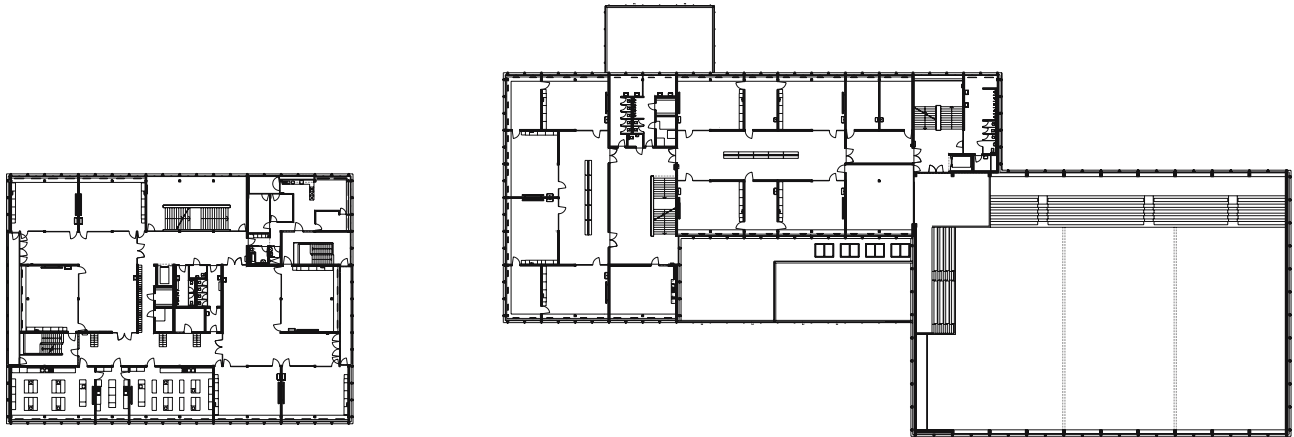


Fig. 205: Plan of 2nd floor

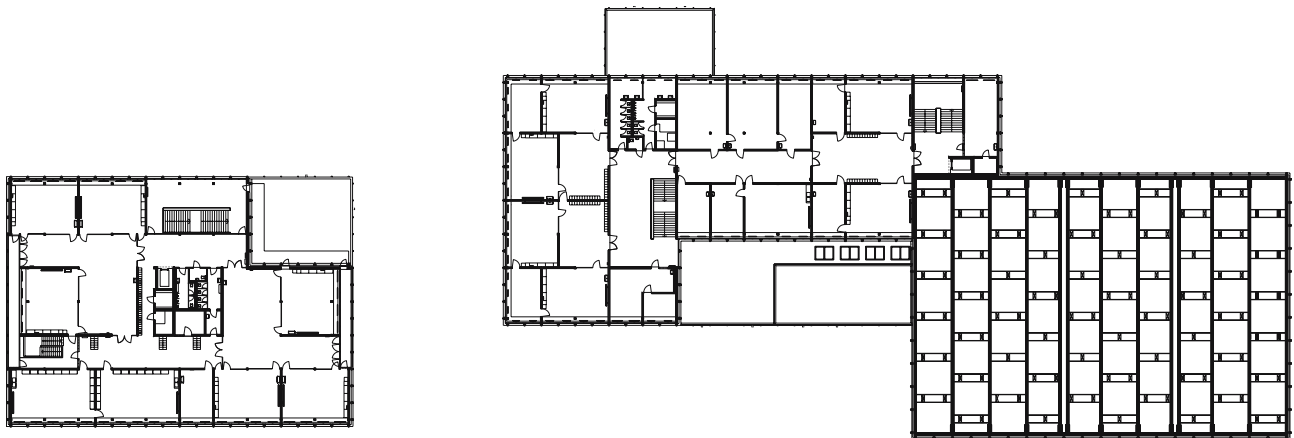


Fig. 206: Plan of 3rd floor

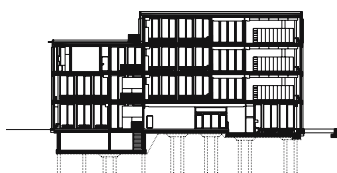


Fig. 207: Section through secondary school

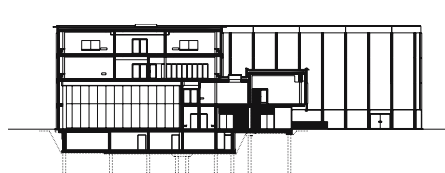


Fig. 208: Section through primary school and common facilities

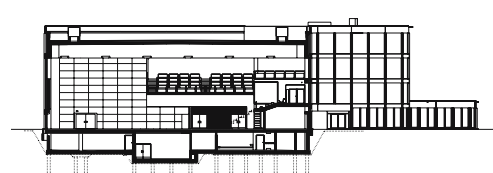


Fig. 209: Section through sports hall

1: 1000



Fig. 210: Lobby in teaching unit of secondary school

### Internal layout and classification

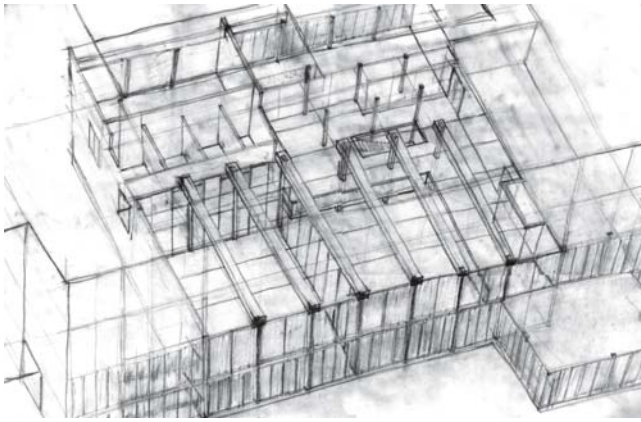
The idea of allocating certain areas to the individual education levels externally is continued inside the building. There are groups of rooms for the different levels and these form independent units within the parts of the building. Groups of two to four classrooms plus one or two group rooms, together with a common area, form one teaching unit, a sort of small school within the larger establishment.

The proposed internal layout with the hall bounded by classrooms on three sides makes for a building with a significant depth. In order to provide adequate lighting for the central areas, the walls of the hall are glazed for the full height of the room. This transparency and the arrangement of the rooms enables clearly structured, interdisciplinary teaching and, by including the shared hall, various other different teaching methods as well. Curtains are used to regulate the views into the individual classrooms.

This layout, characterised by the central hall or the lobby, differentiates this school from conventional ones, where the classrooms are usually reached via a system of corridors. Identifiable places have been created within the school complex at the level of the individual teaching stages to reinforce the pupils' identification with the school. Another crucial aspect of this layout is the "deconcentration system", which was required by the local fire brigade. What this entails is a third exit for all classrooms to guarantee an escape route that does not pass through the hall; that enables the hall to be furnished without any restrictions.



Fig. 211: Plan of teaching unit, 1:200  
Secondary school

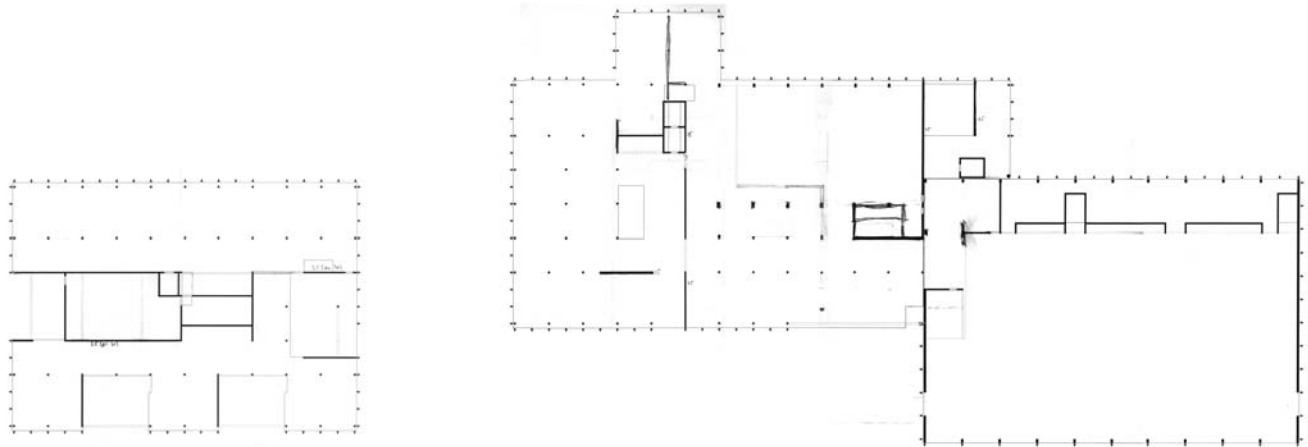


**Fig. 212: Isometric view**  
Checking the room layout and loadbearing structure around the music room, dining hall and library (sketch)

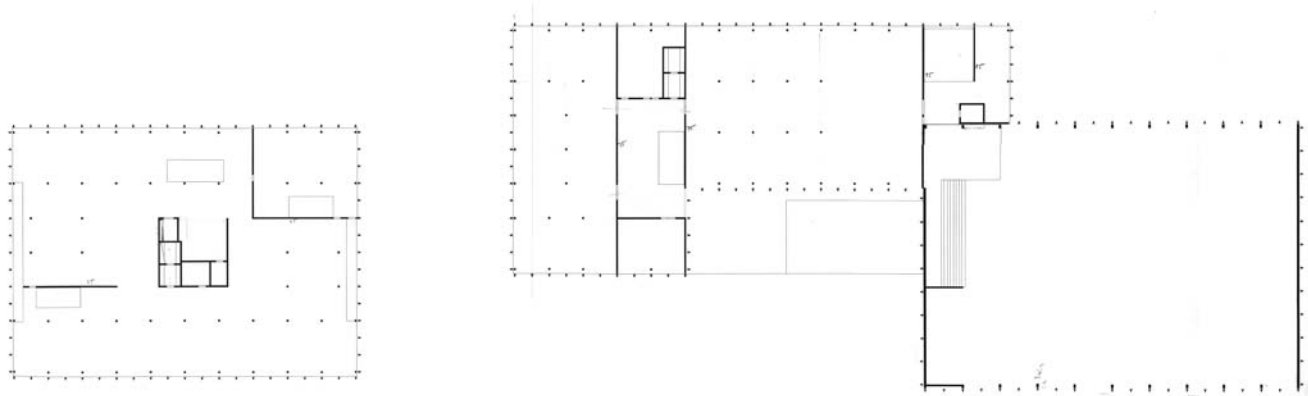
### Design and loadbearing structure

The loadbearing structure is a system of columns and slabs braced with additional fair-face concrete walls to resist horizontal forces. Lightweight elements, bricks and glass block walls constitute the non-loadbearing elements.

The rational facade layout with its projecting lesenes (pilaster strips) seems to indicate a corresponding arrangement of the loadbearing columns behind. However, a closer look reveals variations in the column layout and the structural walls. The placement of the teaching units and the interlacing of different structures and room sizes, around the music room and the sports hall for instance, meant that the loadbearing structure had to be adjusted accordingly. In particular, the structure at ground floor level was determined by references to external spaces and the position of entrances. Around the entrance to the common facilities and the sports hall, as well as the covered external facilities for the nursery, the loads from



**Fig. 213: Loadbearing structure, ground floor, 1:1000**  
Plans of design process with additions by hand



**Fig. 214: Loadbearing structure, 2nd and 3rd floors, 1:1000**





**Fig. 215: View during construction**  
Entrance hall to secondary school, floor slab over ground floor and precast concrete columns

the columns above are carried on downstand beams acting as transfer structures.

The floor slabs are 340 mm thick in order to bridge the long spans in some areas. But even where the spans are shorter the same thickness is used for economic reasons. This great mass of concrete renders impact sound insulation unnecessary.

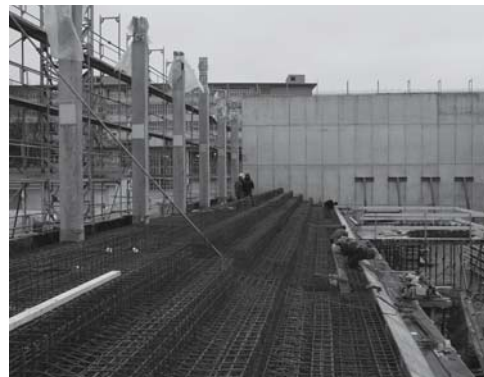
The dark colouring of the prefabricated, slender (250 x 250 mm) fair-face concrete columns is due to the properties of the aggregates used and the high proportion

of cement. This high-strength concrete complies with enhanced structural requirements in terms of the compressive strength. The loads are transferred to the subsoil via a concrete pile foundation, with piles up to 27 m long.

The surface finish to the structural fair-face concrete walls is achieved by using formwork type 2, i.e. a uniform surface texture is achieved without specifying the size of formwork panel to be used, which depends on the formwork system employed. Only the direction of the joints between panels was specified by the architects; their position and appearance was then decided by the contractor.



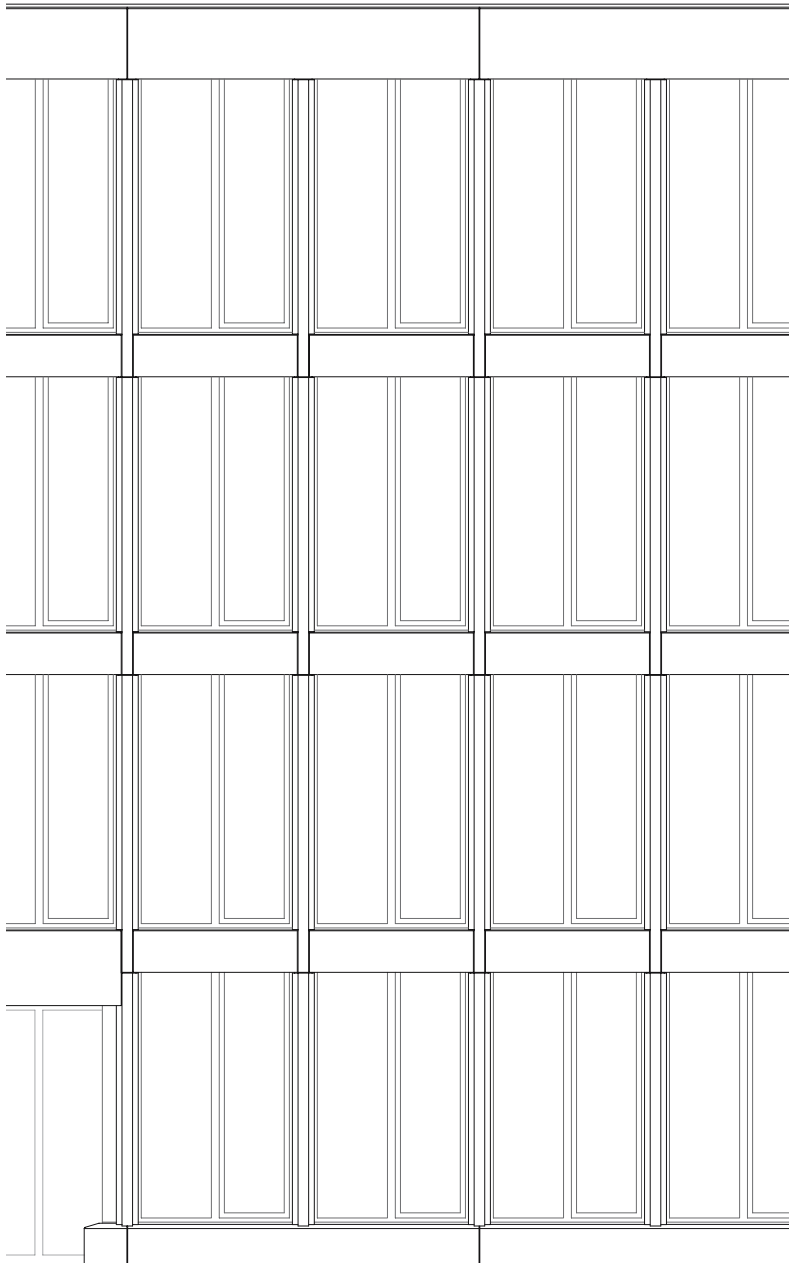
**Fig. 216: Column and wall**  
Access zone in secondary school, fair-face concrete wall with formwork type 2 and precast concrete column



**Fig. 217: View during construction**  
In situ concrete columns and fair-face concrete wall to sports hall, fixing reinforcement to in situ concrete spectator seating



**Fig. 218: Lesenes**  
Precast concrete element  
Lesene (pilaster strip) in this sense is a pier-type projecting strip of wall without a capital or a base.



**Fig. 219: Elevation, 1:50**

### Design I

The expression of the facade is characterised by the precast concrete lesenes which divide up the surfaces vertically. These elements are not merely decorative but since they are also employed for fixing the windows. All facades use this system – the classroom wings and the sports hall.

The use of different precast concrete elements for items such as the roof edge, lesenes, slab edge and plinth leads to a calm, static, almost classical facade construction. The spacing of the lesenes is equal to half the distance between the grid lines of the structural layout, which permits the use of different materials for the infill panels: glass, rendered surfaces, other concrete elements or steel features (safety barriers along the escape balconies). These disparate infills alter the references to the surrounding spaces.



**Fig. 220: Corner of building and edge of roof**  
Steel safety barrier to escape balcony, glazing and rendered brick wall

Fig. 222: Building housing primary school and sports hall

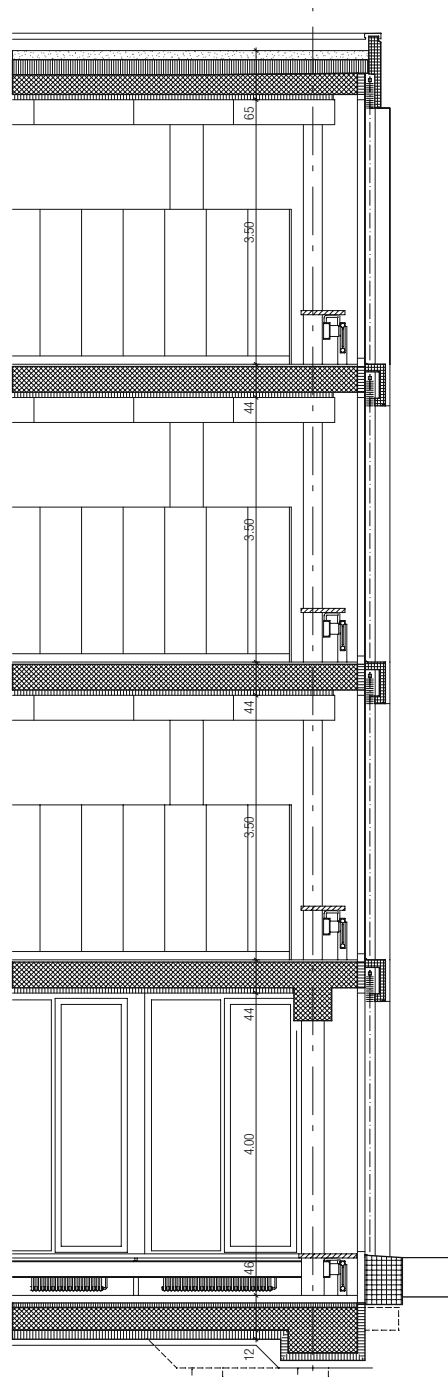


Fig. 221: Section, 1:50

**Roof construction**

Rooftop planting (unplanned, i.e. natural) substrate, optional drainage mat	100 mm
Separating layer	
Waterproofing, root-resistant EP 4	10 mm
Mineral-fibre insulation	200 mm
Vapour barrier, VA 4, fully bonded	10 mm
Fair-face concrete slab laid to falls	260 mm
Acoustic ceiling panel	70 mm
<i>Total</i>	<i>650 mm</i>

**Floor construction, upper floors**

Linoleum/adhesive	5 mm
Optional vapour check	
Fibre-reinforced screed	25 mm
Fair-face concrete slab	340 mm
Acoustic ceiling panel (perforated and painted gypsum boards)	70 mm
Luminaires	
<i>Total</i>	<i>440 mm</i>

**Floor construction, ground floor**

Linoleum/adhesive	5 mm
Fibre-reinforced screed	85 mm
or	
(12 mm stone flags laid in adhesive	
78 mm screed on separating layer)	
Mineral-fibre impact sound insulation	20 mm
Thermal insulation, expanded polystyrene (F20)	40 mm
Vapour check	10 mm
Concrete slab, waterproof	300 mm
Polyethylene sheet, 0.2 mm	
Thermal insulation, extruded polystyrene	120 mm
Blinding layer, lean concrete	
<i>Total</i>	<i>580 mm</i>

### Design II

In comparison with existing structures that employ the column-and-slab principle (e.g. Le Corbusier's Dom-ino principle), the architect exploits neither the independent arrangement of the facade, nor the freedom in the internal layout that would be possible. Instead, this system can be regarded as a neutral framework for the structure of the facade.

The clear and simple assembly of the individual concrete elements is dominated by the prefabrication and the logistics of the erection. The first phase involves insulating the edges of the floor slabs and attaching angles ready for fixing the windows later. At ground floor the edges of the slabs include nibs measuring 440 x 330 x 300 mm on which the prefabricated plinth elements are seated. The lesenes are fixed, storey by storey, to the loadbearing structure, i.e. to the edges of the concrete slabs. The

horizontal concrete elements – to conceal and protect the sunblinds and form sills for the windows above – are then mounted on the lesenes. The roof edge elements are fixed with Omega expansion anchors, while loadbearing facade anchors with spacer bolts are used for the lesenes. The brick infill panels are built up in situ. In the second phase the thermal insulation is attached. This consists of storey-high elements of 220 mm thick expanded polystyrene which are bonded directly to the brickwork and subsequently rendered. The aluminium windows are mounted between the lesenes on the angle sections that were attached earlier. All precast concrete elements have open, drained joints, i.e. the design of the individual elements and the logic of their jointing obviates the need for sealing materials.



**Fig. 223: Fixing the lesenes**

View of slab soffit showing lesene with facade anchor and spacer bolt supporting vertical concrete element



**Fig. 224: View during construction**

Lesenes and vertical concrete elements, masonry infill panels



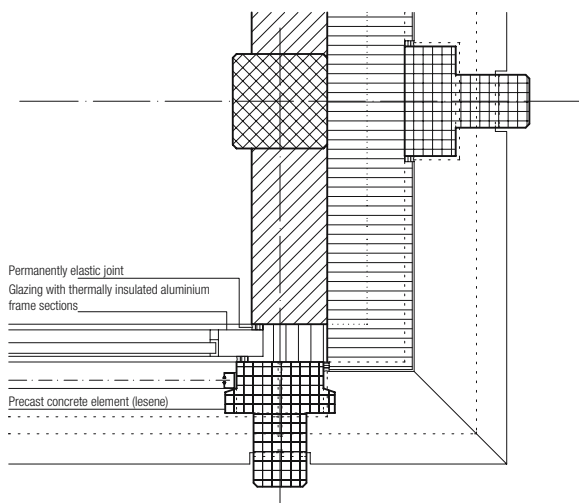
**Fig. 225: Plinth**

Cantilevering ground floor slab and plinth zone with nibs

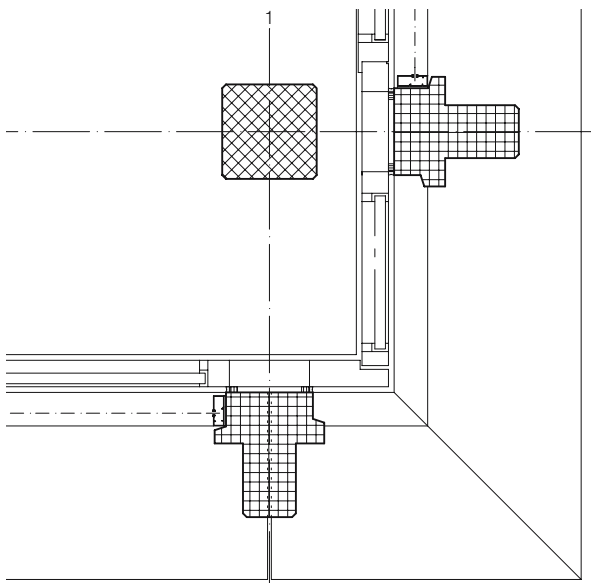




**Fig. 226: Facade to secondary school**  
Window with fixed light and bottom-hung light, fixed desks and radiators



**Fig. 227: Detail, 1:20**  
Corner showing junction of masonry infill and external thermal insulation, rendered



**Fig. 228: Detail, 1:20**  
Non-symmetrical corner at ground floor level showing plinth element

The storey-high openings within the grid of lesenes are divided in two. Each window consists of a fixed light and a bottom-hung light. A controlled air-conditioning system with heat recovery has been installed and complies with Switzerland's "Minergie Standard". The classrooms are fitted with built-in cupboards for the necessary teaching materials; the cupboards have fresh-air inlets at the base. Exhaust air is extracted via a duct that runs above the suspended ceiling along the inside wall.

All classrooms are fitted with internal blackout blinds or curtains that run in tracks along the glazed system walls to the common areas (see fig. 211). The classrooms can also be darkened by means of louvre blinds. Another feature is the built-in tables fixed between the columns which also serve to conceal the radiators. Services run in the duct along the spandrel panel below the windows.



**Fig. 229: Close-up of facade**  
Corner between ground and 1st floor levels on primary school building

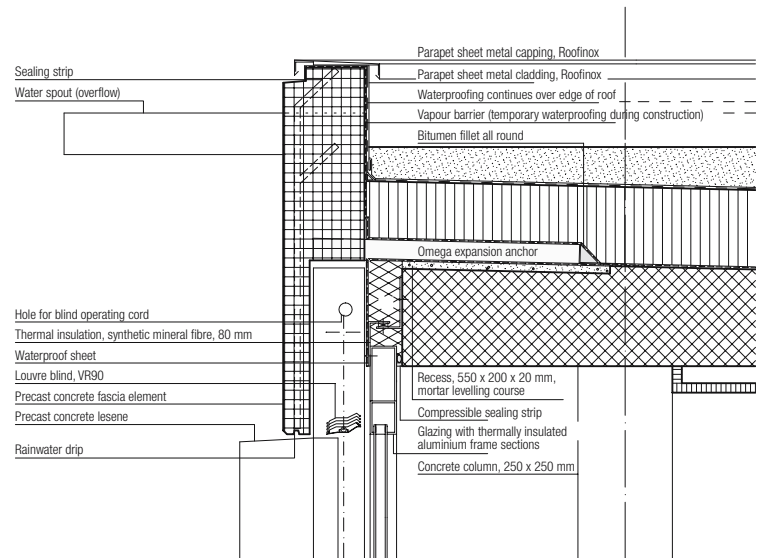


Fig. 230: Roof detail, 1:20

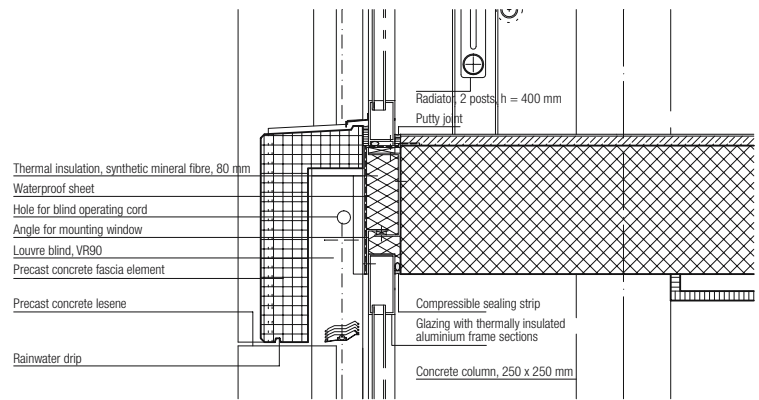


Fig. 231: Floor slab edge detail, 1:20

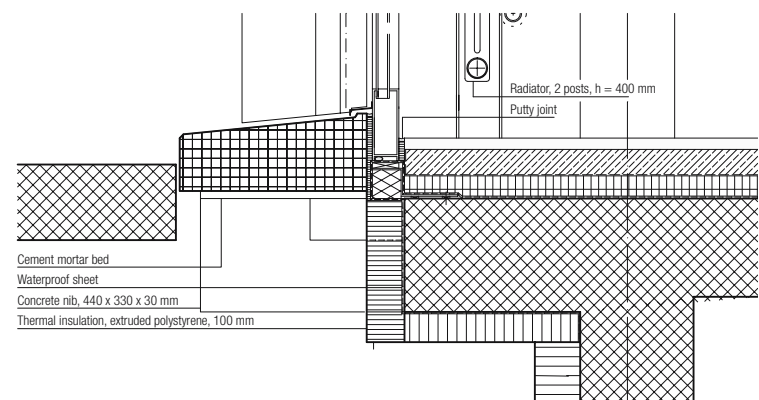


Fig. 232: Plinth detail 1:20



**Fig. 233: Close-up of stairs**  
Joint between in situ concrete and travertine

### Materials

The precast concrete elements (lesenes, spandrel panels and plinth segments), the grey render and the anodised aluminium windows form the visible elements of the building on the outside. These materials and the way they are used essentially determine the colour scheme, or rather the restrained "colouring" of the complex, with the areas of glass, which appear dark, plus the dark render contrasting with the light colouring of the concrete elements in the facade.

Inside, the loadbearing structure of the building is always present. The uneven, raw texture of the fair-face concrete surfaces is finished with a clear lacquer, which gives the walls a stony appearance. Non-loadbearing parts complement the structural elements: the glass block walls, the glazing and the brick walls, finished with white-painted glass-fibre wallpaper. Whereas open-pore travertine flags have been laid around the stairs and in the entrance lobbies, beige-coloured linoleum has been used in the teaching units.

The materials employed and their different surface qualities seem to converge rather abruptly. This suggests a pragmatic approach: established rules, whether in terms of jointing the materials, framing the glazing or detailing the plinth, are part of an overriding plan of action by the architect. They form a tool for the controlled management of the planning work, an approach appropriate to the size of the building.

To take as an example the edge detail for the stair flight and the travertine stair finish, the attitude of the architects with respect to jointing the materials is readily seen. The actual difference in the accuracy of the materials is allowed for, i.e. the different dimensional tolerances



**Fig. 235: Entrance area for dining and sports halls**  
The columns in the entrance areas are clad with travertine.

govern the treatment of the in situ concrete, which becomes an obvious, protruding edge.

The architectural allocation and presence of the elements and their materials also becomes evident in the routing of the building services. The horizontal distribution along the floor slabs takes place in a duct with branches, an efficient method, and around the lobbies along the edges of the floor slabs. The services duct is clad with grey sheet metal and appears to be trying to find its way along the floors in order to supply all the classrooms.



**Fig. 234: Materials in classroom**  
Fair-face concrete soffit and acoustic gypsum panels with integral lighting units, ventilation duct clad with grey sheet metal, glazing with curtains, peripheral aluminium rail for displaying drawings etc., sink and blackboard, beige-coloured linoleum floor covering

## Chur Teacher Training College, science wing

Bearth + Deplazes

Valentin Bearth, Andrea Deplazes,  
Alois Diethelm

### Situation and theme

The science wing is an extension to the Grisons Teacher Training College. Its architectural vocabulary – four concrete platforms stacked one upon the other – and its division into teaching and preparation rooms reflect the terse operational space and economic criteria.

The total transparency of the interior and facades is presumably meant to make clear for all to see the purpose of science. The precise clarity of a crystalline lattice or a molecular structure as the building block of life or nature to be studied has been transformed into the rational scientific structure of an angular, polished glass box planted in the cultivated greenery of its surroundings. Rational artificiality in the midst of romantic artificiality. A “reflection” of nature next to the “model” of nature.

The absence of colour – within the building there exist only shades of grey on grey (“laboratory grey”) – increases our perception of the artificiality of the science laboratory as a total contrast to the intensive, diverse, dense “illustrative” greenery of the vegetation in the area. Trees, bushes, vines, ferns, etc. extend right up to the glass box itself. Unexpectedly, observer and observed exchange places.

Architects: Bearth + Deplazes, Chur  
Construction period: 1997–1999  
Project manager: Bettina Werner  
Structural engineer: Fredy Unger, Chur

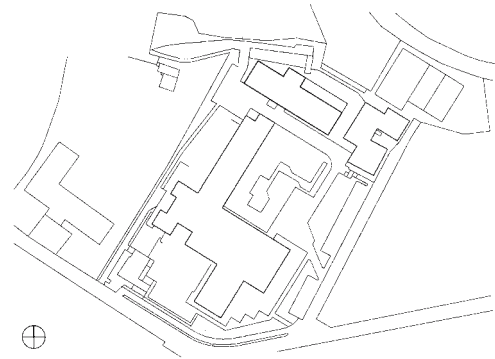


Fig. 237: Site plan  
The new building at the foot of the Hoffelsen in Chur



Fig. 236: South facade  
Viewed head on, it is possible to see right through the building!



### Internal layout and loadbearing structure I

The loadbearing structure of in situ concrete consists of four platforms stacked one upon the other, the conglomerate braced by an access tower on one side. Each row of columns is coupled with downstand beams to form a frame-like, five-bay "yoke" running parallel to the length of the building. A suspended ceiling spans the two yokes, hemmed in by the beams.

In contrast to beams that are positioned perpendicular to the length of the building, this arrangement permits a straightforward horizontal distribution of the services required (electricity, water, waste water, gas and laboratory media). Apart from the tower, the structure does not initially imply any particular use or internal layout. The division into teaching, ancillary and access zones is primarily by way of non-loadbearing walls – glass in the longitudinal direction (for transparency). Across the building the main rooms are demarcated by walls of built-in cupboards between the appropriately sized columns (600 x 600 mm).

The user-defined and – possibly – temporary arrangement of walls, for which the loadbearing structure is ideal, is somewhat restricted however by the position of risers and waste pipes. The shafts for these vertical service runs are located on the two columns to the left and right of the tower and cannot be altered (see "a" in fig. 238). On the other hand, the building services on the platforms are autonomous. Use of the tower as a possible services shaft, which would mean elaborate perforations in the downstand beams in this area and the need for a suspended ceiling, is therefore superfluous and favors the concept of the platforms.

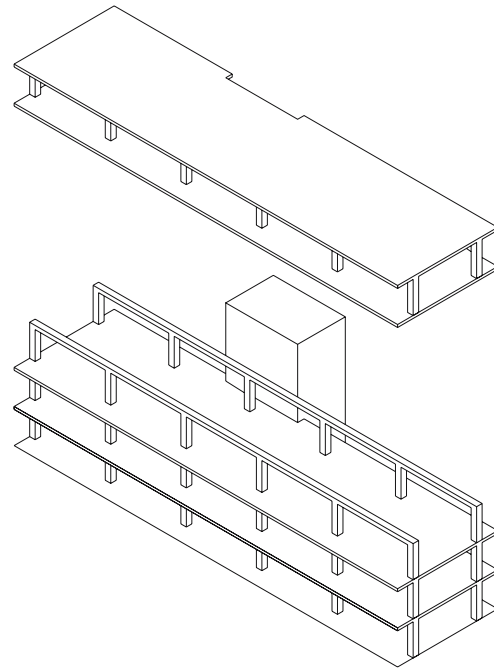


Fig. 239: Axonometric view of structural system  
Stacked concrete "platforms"

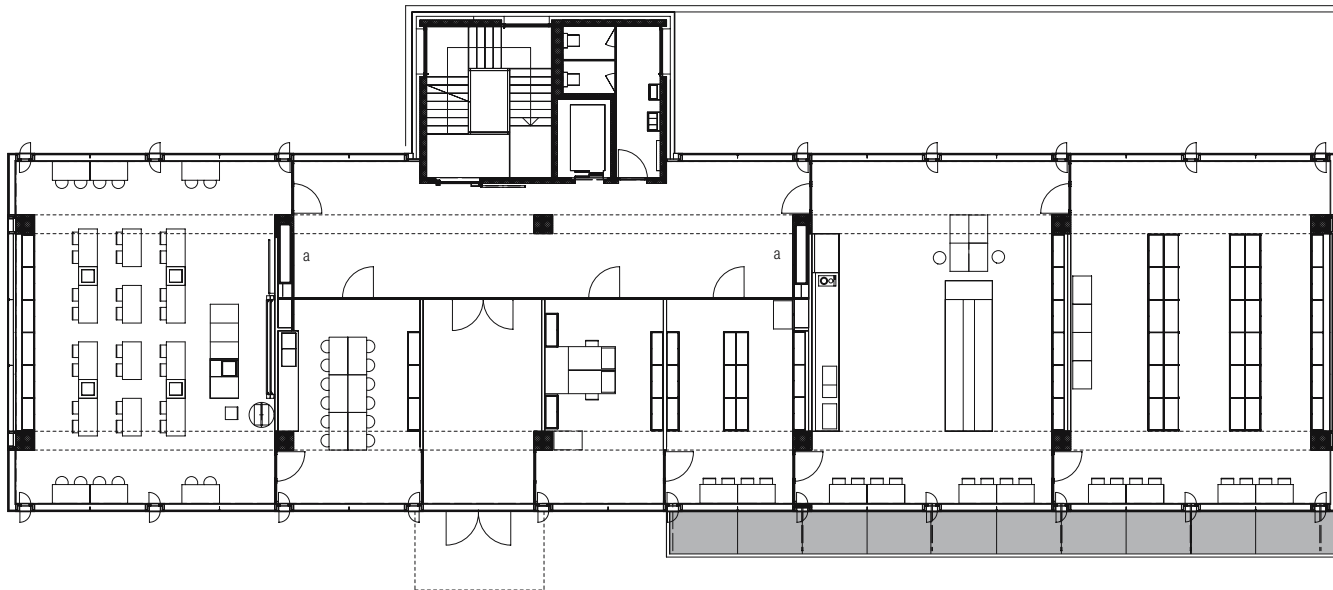


Fig. 238: Plan of ground floor  
The rooms are reached without the need for corridors.  
a) Vertical service shafts

0 1 5 m

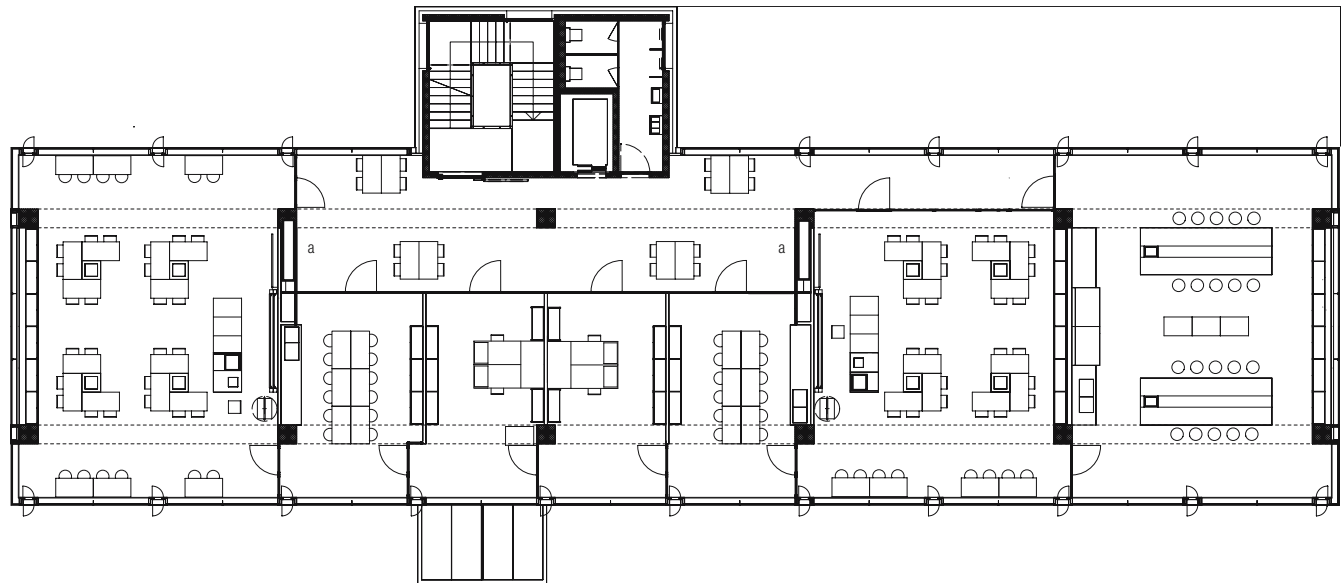
Internal layout and loadbearing structure II



**Fig. 240: Seminar room**  
A suspended ceiling between the downstand beams, but only the bare concrete soffit adjacent to the facade (see section)



**Fig. 241: Seminar room**  
Views of the outside are still possible even when the awnings are extended.



**Fig. 242: Plan of 1st floor**  
Lobby adjacent staircase and corridor to room at east end of building  
a) Vertical service shafts

0 1 5 m

Internal layout and loadbearing structure III



Fig. 243: North facade  
Staircase tower bracing the whole structure; frameless glass curtain wall

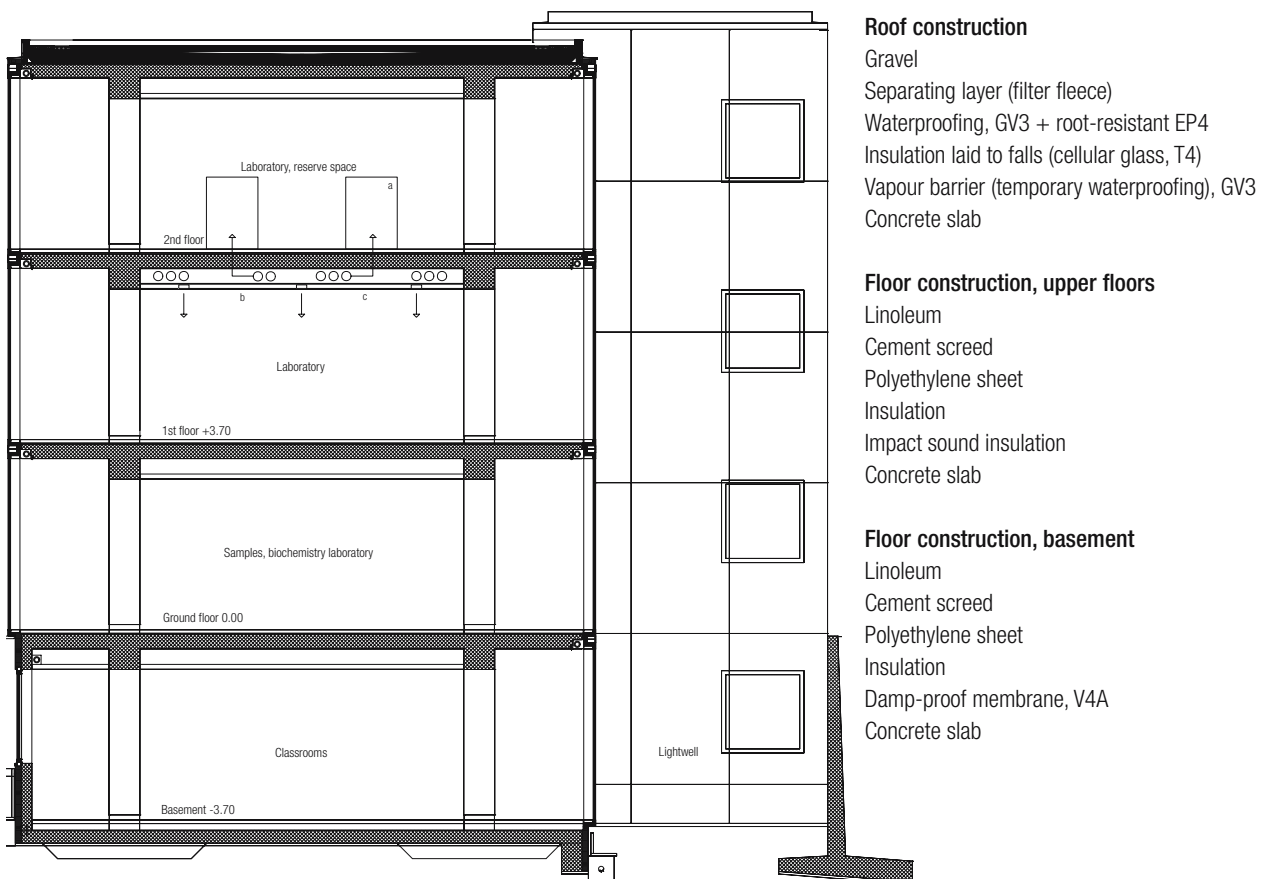


Fig. 244: Section  
The stacked concrete "platforms" and staircase tower, which in the basement is coupled with the lightwell.  
a) Laboratory benches/media supply points; b) horizontal media zone/distribution; c) lighting unit



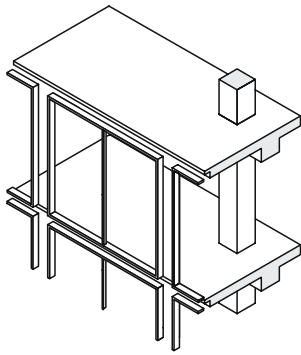


Fig. 245: Concrete members (primary load-bearing structure) with lightweight metal frames (secondary structure)  
Frames fitted to edges of floor slabs

### Design and realisation – the curtain wall

The facade is based on a system of nearly square frames, each fixed top and bottom to the edges of the floor slabs. The frames (post-and-rail construction) are positioned relative to each other so that there are spaces in between. The horizontal spaces house the external awnings, the vertical spaces the ventilation flaps.

A vertical T-section in the middle of the anodised aluminium frames halves the width of the glass and hence considerably reduces the price of the glass. Laminated safety glass is used for the inner panes of these double-glazed units and thus renders any form of balustrade (safety barrier) unnecessary. Natural ventilation is provided by the aforementioned inward-opening flaps. The outer louvres guarantee ventilation regardless of the weather (e.g. night-time cooling in summer, protection against driving rain), but also prevent intruders gaining

access to the building. The outer centre flap is a response to the teaching staff's wish for a physical link with the outside world.

Using the spaces between the frames in this way (for awnings and ventilation flaps) allows the glass to finish flush with the frames and so create a skin-like development – glass and frames in the same plane. The corners employ stepped glass (the panes meet without any frame) and this reinforces the idea of the developed facade. All the engineering components are built in, which causes the whole facade construction in the end to function together like a clockwork.

Nevertheless, at SFr 970/m<sup>2</sup> (including awnings, ventilation flaps, connections and terminations and internal blinds; index 1999) this is a cost-effective solution for a curtain wall system.

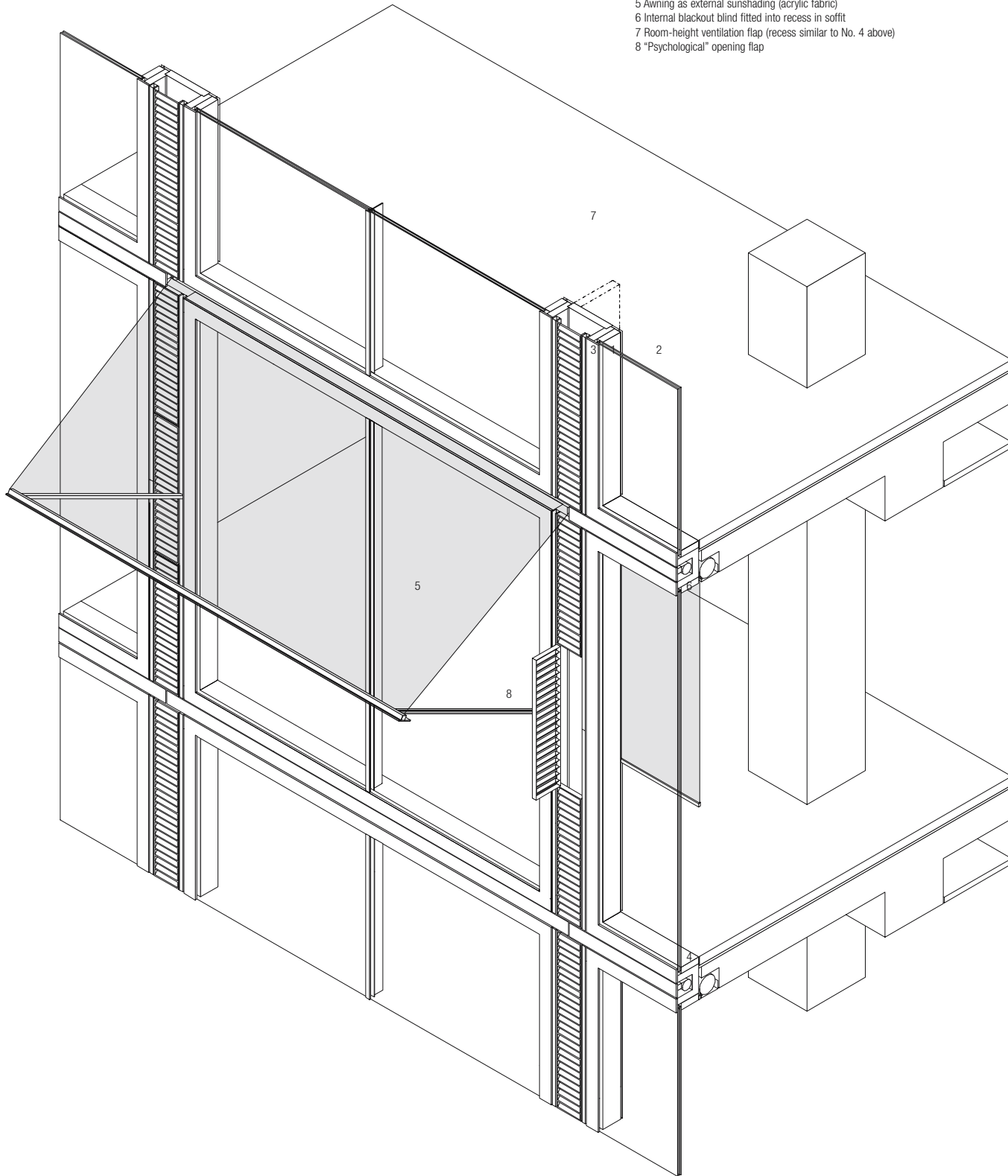


Fig. 246: Close-up of facade  
Frameless corner detail (stepped glass)

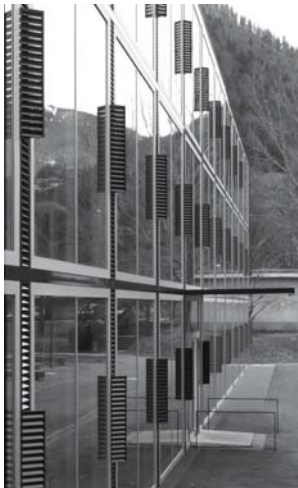


**Facade construction**

- 1 Aluminium facade sections, 60 x 180 mm
- 2 Double glazing, inner pane of laminated safety glass
- 3 External patent glazing fitting for mechanical fixing of glass
- 4 Recess: 60 mm rockwool thermal insulation plus sheet aluminium lining
- 5 Awning as external sunshading (acrylic fabric)
- 6 Internal blackout blind fitted into recess in soffit
- 7 Room-height ventilation flap (recess similar to No. 4 above)
- 8 "Psychological" opening flap

**Fig. 247: Facade details**

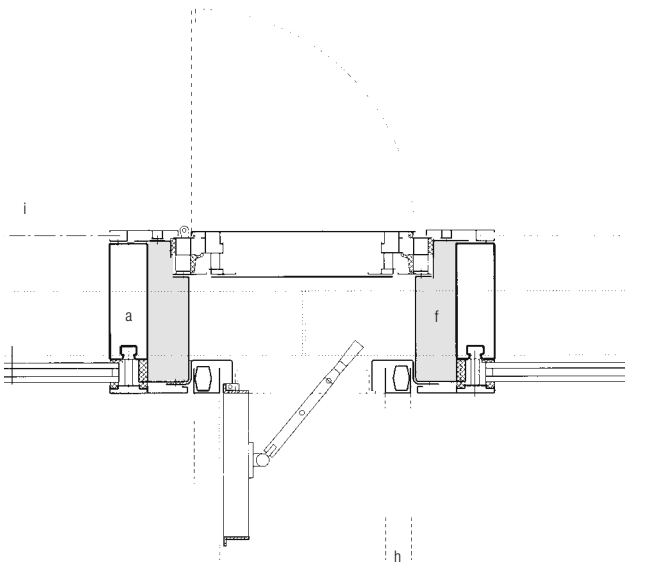
Spaces between window frames for ventilation (vertical) and sunshading (horizontal)



**Fig. 248: South facade with entrance**  
External ventilation flaps open

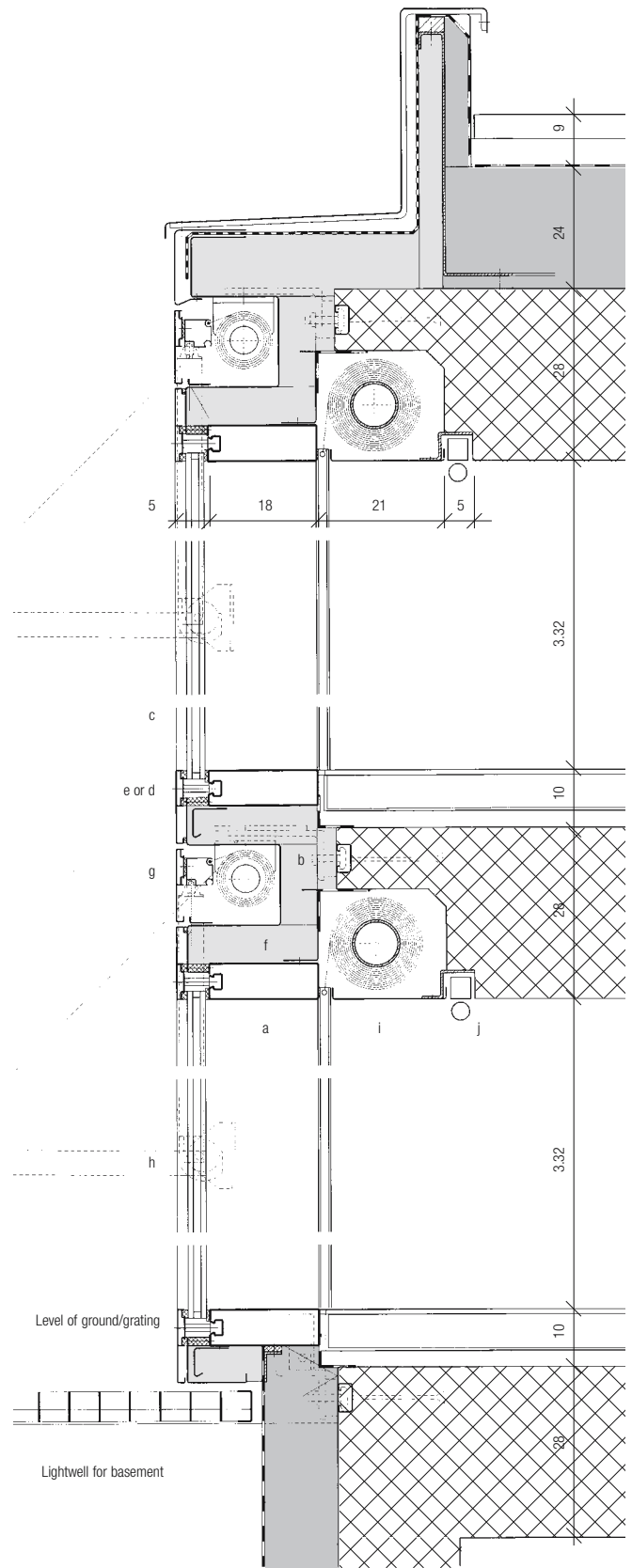
**Facade construction**

- a Aluminium facade sections, 60 x 180 mm
- b Bracket and cast-in rail for attaching facade sections
- c Double glazing, inner pane of 8 mm laminated safety glass, outer pane of 8 mm float glass (outer pane at frameless corners: 8 mm toughened safety glass)
- d External patent glazing fitting for mechanical fixing of glass (b = 60 mm)
- e Extra-wide cover strip (b = 120 mm)
- f Rockwool, 60 mm, plus sheet aluminium lining
- g Front edge of awning
- h Straight awning arm
- i Internal blackout blind fitted into recess in soffit
- j Fluorescent lights recessed into soffit



**Fig. 249: Horizontal section**  
Vertical joint with internal and external ventilation flaps

0 10 50 cm



**Fig. 250: Vertical section**

### Design and realisation – the sunshading

Protection against direct sunlight is an integral part of the building services concept which, despite the fully glazed facades, does without mechanical air-conditioning. In contrast to vertical blinds, which, when in use, stretch like a skin over the facade (but cannot be integrated flush), these straight-arm awnings lend the building form and relief. Depending on the position of the awnings the building takes on two different appearances. (This changing appearance is also reinforced by the fact that the awnings are fitted only on the southern side and hence represent a stark contrast to the otherwise glass-only facades.)

Once extended, the cantilevering awnings still allow the facade behind to remain visible – an unconventional, inviting gesture not possible with the majority of sunshading systems. Even more significant is the way they separate inside from outside to a greater or lesser degree. But here again, the visual relationship is still preserved. However, the drawback of this type of awning can be seen at the end of the building where, depending on the position of the sun, the incident sunlight can still reach the glass. Another drawback is their vulnerability to the wind when extended.

The same architectural expression could have been achieved with articulated-arm awnings. However, they present a weakness that repeated buffeting by the wind can alter the adjustment over time.

These electrically operated awnings roll up into the spaces between the window frames. The same cover strip ( $b = 120 \text{ mm}$ ) as used on the adjoining post-and-rail construction conceals the standard horizontal edge section of the awning. Channel sections were fitted over

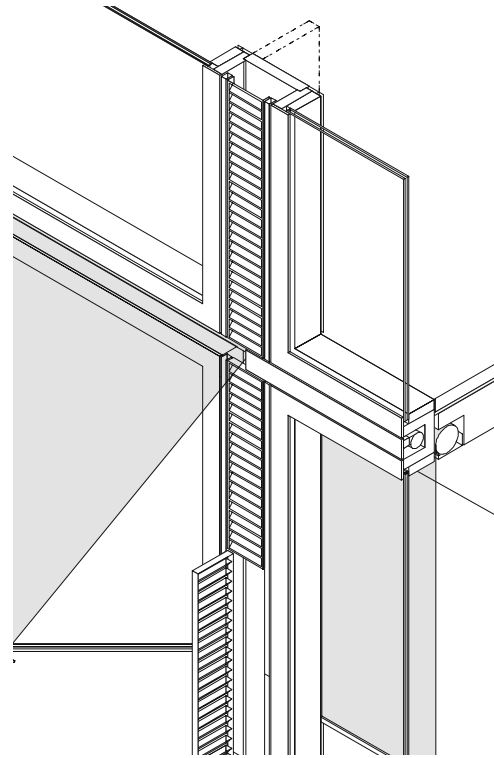


Fig. 252: South facade with awning extended  
Maximum extension of straight arm = horizontal

the arms so they too fit flush between window frame and ventilation flap. Apart from the window frames in standard anodised aluminium, all the exposed parts of the facade have a black stove-enamelled finish, which minimises the presence of the joints and the louvres of the ventilation flaps.



Fig. 251: South facade with awnings retracted  
The same appearance on all sides



Fig. 253: South facade with awnings extended  
The facade is given relief; the omission of one awning marks the entrance (fixed canopy).

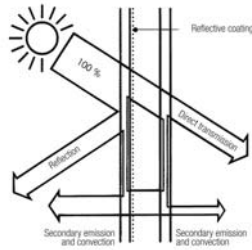


Fig. 254: Shading – the radiation relationships  
Source: "Glas und Praxis", Glas Trösch AG, 2000

### Energy concept – the greenhouse problem

The specific problem of glazed buildings – which basically applies as well to any window in a fenestrate facade – is that in winter glass provides less protection against heat losses (although this is more than made up for by the solar energy gains during the heating period, primarily with large areas) and in summer admits too much (unwanted) energy. If nothing is done about this, the consequences are all too well known: overheating in summer, overcooling in winter.

Until the 1980s full air-conditioning in glazed buildings was therefore the most common answer to this problem. But our changing environmental awareness and the resulting growing rejection of air-conditioning systems has meant that since that time various solutions have been applied to make the continued use of large expanses of glass possible. These involve, on the one hand, optimised materials (e.g. changing the properties of glass) and, on the other, optimised design concepts (structure, building services, building performance).

The main thrust of development in glass production has been improvements to thermal insulation (U-value) and total energy transmittance (g-value). Technical means of achieving this involve (colourless) films for thermal insulation and shading, plus gas fillings (e.g. argon). The influence of the g-value should not be underestimated because extreme shading measures can exclude the heat-giving solar radiation just when it is wanted, i.e. passive use of solar energy in winter. At the same time, however, good shading measures can protect against excessive temperature increases if sunblinds cannot be extended because of high winds, for example.

Because of the large areas of glass, the teacher training college uses a glass with a very good shading value (south facade: g-value 38%) without reducing the solar energy gains significantly. Of course, the flow of energy

from outside to inside is also reduced by good thermal insulation (see fig. 254), which can lead to the decision to exploit solar energy gains in winter by using south-facing glazing with a poorer U-value. At the teacher training college double glazing with a U-value of 1.0 W/m<sup>2</sup>K and a light transmittance of 70% was used on all sides. Logically, the g-value on the north facade – at 55% – is lower than that of the south facade.

Design criteria involve the orientation and positioning of a building and hence a ventilation concept, which inevitably also includes the choice of building materials. At the college the south-facing orientation guarantees optimum utilisation of solar energy. However, because the rooms span the building (i.e. in a south–north direction), this orientation also sets up thermal currents within the building that ensure natural ventilation. The night-time cooling in summer also plays a key role, with solid, monolithic building materials, e.g. concrete, being "charged up" by the flow of cool air. The stored cooling effect is then released during the day and ensures a comfortable interior climate. Opening fanlights over the doors have been installed in those rooms bordered by a corridor on one side and these enable cross-ventilation via the staircase. Here the difference in height (the ventilation opening is at second floor level) promotes the "stack effect" (natural air pressure differential: pressure and suction effects).

HVAC concept after Waldhauser Haustechnik, Basel

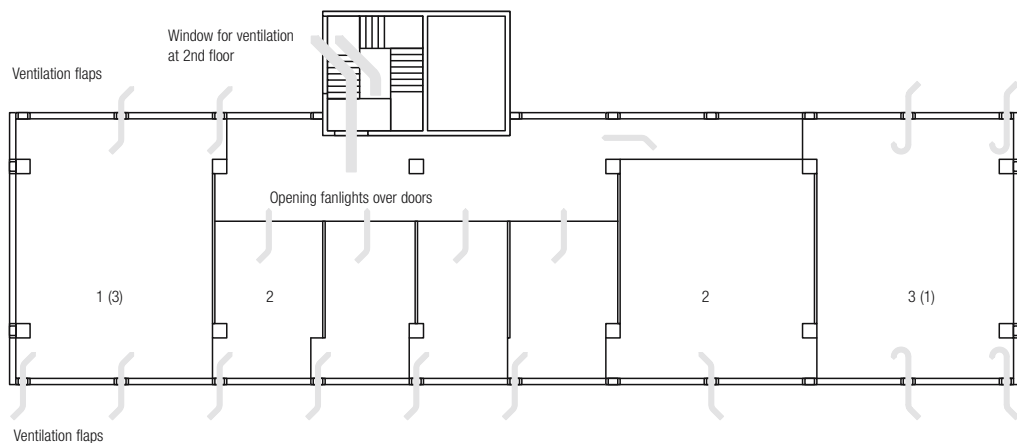


Fig. 255: Ventilation scheme

- 1) Movement of air (from facade to facade): by wind and/or temperature differences
- 2) Movement of air (from facade via corridor to staircase): by temperature differences/stack effect
- 3) Movement of air (at facade): thermal currents, different interior temperatures



## Swiss School of Engineering for the Wood Industry, Biel

Marcel Meili, Markus Peter

### Swiss School of Engineering for the Wood Industry, Biel, 1990–1999

This school, even before the new extension, already boasted a remarkable character. The site and the buildings form what is almost an island between residential districts and an industrial area, which stretches along the hard edge of the Jura Massif. The vocabulary of the ensemble of school buildings – a main building in the romantic, national style of the post-war years plus a single-storey workshop – seems to be anchored in the landscape and the breadth of the valley floor.

The new work changed these forms into a new overall figure, which, thanks to two different gestures, represents a further development of the relationship between the architecture and the open spaces. Firstly, the workshops at ground floor level with their pitched roofs now extend like an outstretched finger to almost touch the new teaching building. Secondly, this wing, a four-storey timber design, towers over the shallow silhouette of the timber workshops, its proximity achieving an almost dissonant proportional relationship with the more traditional architecture on the site.

The four-storey building is designed as a series of timber boxes assembled from prefabricated, storey-high frames. The gaps between the boxes create terraces and corridors which form a fluid link with the external spaces. Merely the central access cores are built of concrete to satisfy fire protection requirements.

The method of joining these room modules is allied to the technology of large timber spans. The floors consist of exposed, long-span box elements which render primary/secondary construction concepts superfluous. The bottom section of the loadbearing facade frames is a glued laminated timber beam matching the height of a spandrel panel. This serves as an upstand beam for the floor ele-

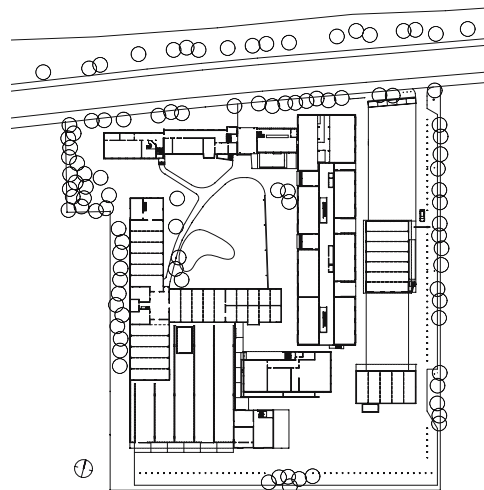


Fig. 258: Site plan

ments. This means it is possible to install large, subdivided windows whose proportions are no longer dictated by the close spacing of the timber studding, but instead by their relationship to the spacious rooms behind. Timber panels of untreated oak form the cladding to the facade. In this type of panel the joints between individual boards become invisible and allow the recessed joints between the elements to become more prominent.

The form of construction is therefore important in this project because only by overcoming timber engineering's own dimensional and divisional hierarchy was it possible to implement the three-dimensional concept. In this design the special qualities of traditional timber buildings abruptly encounter an approach that suppresses the additive character of the wood in favour of a more moulded, expansive and three-dimensional look.

Architects: Marcel Meili and Markus Peter, with Zeno Vogel, Zurich  
 Construction period: 1997–1999  
 Project manager: Zeno Vogel  
 Structural engineers: Conzett Bronzini Gartmann, Chur

Figs 256 and 257: The Swiss School of Engineering for the Wood Industry is a series of wooden boxes.



Planning phase

(reduced planning drawings, 1:200)

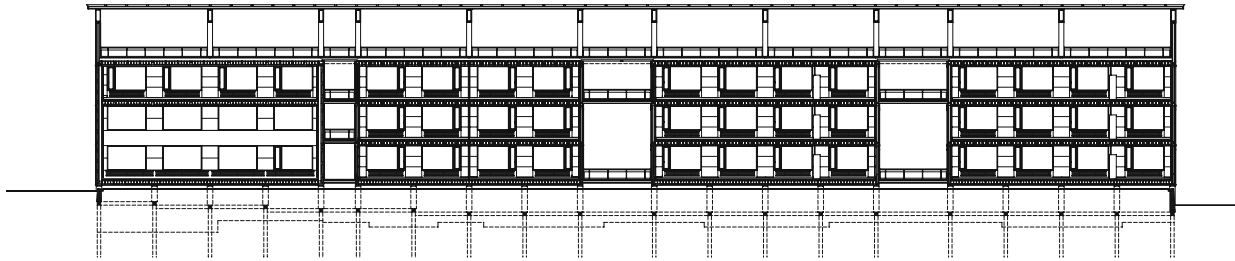


Fig. 259: Longitudinal section B-B

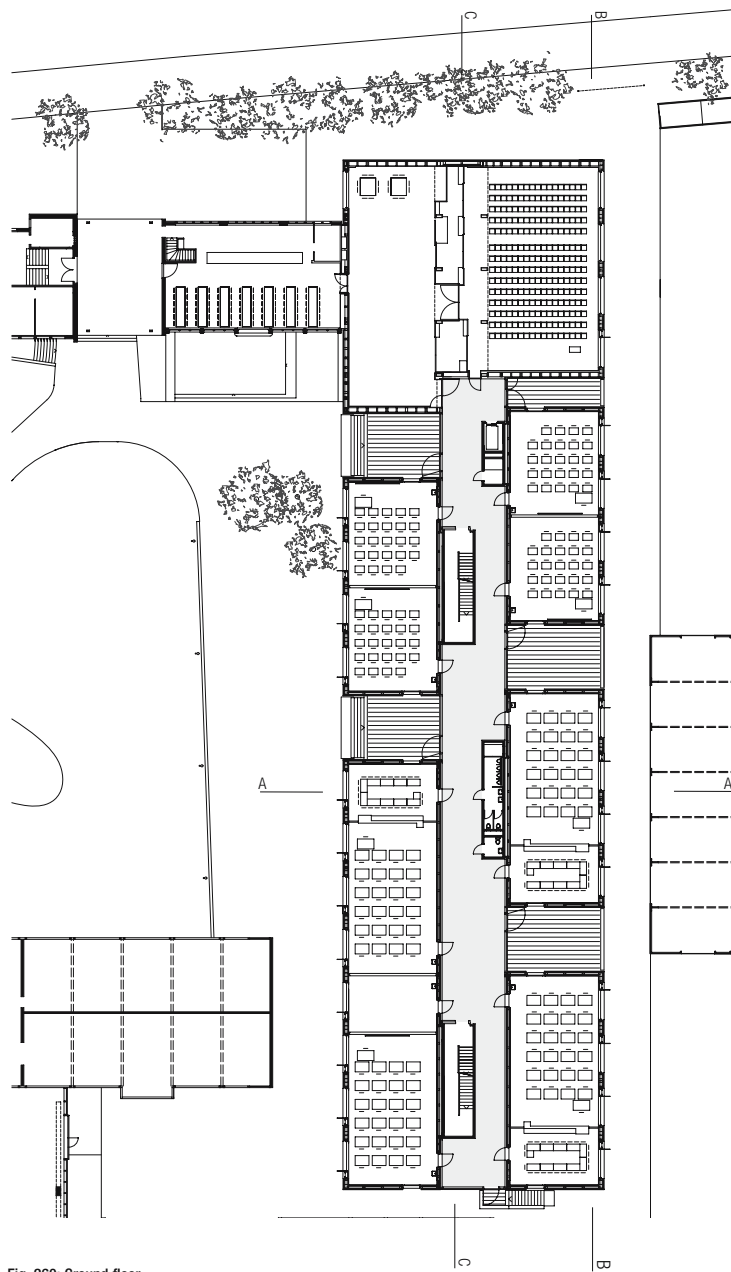


Fig. 260: Ground floor

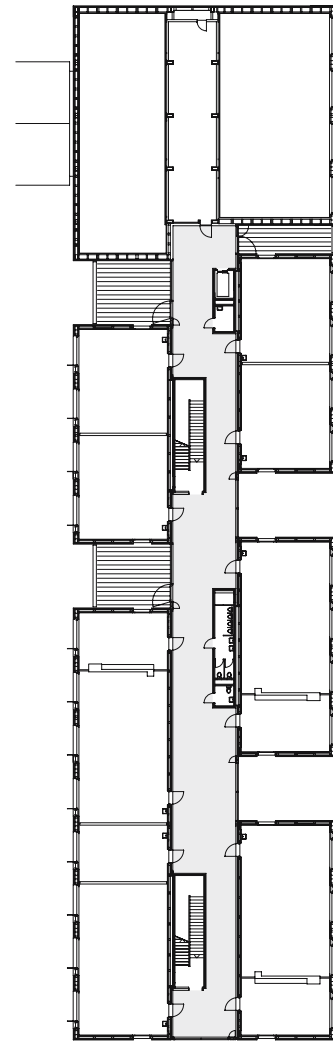


Fig. 261: 1st floor

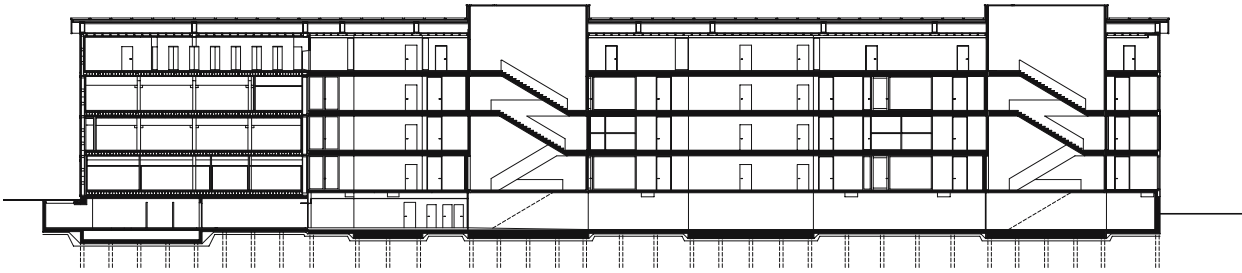


Fig. 262: Longitudinal section C-C

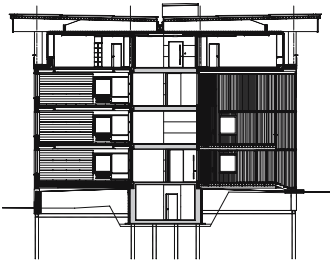


Fig. 263: Section A-A

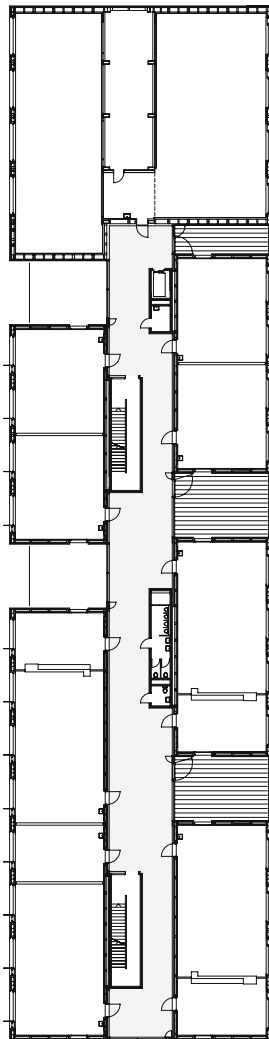


Fig. 264: 2nd floor

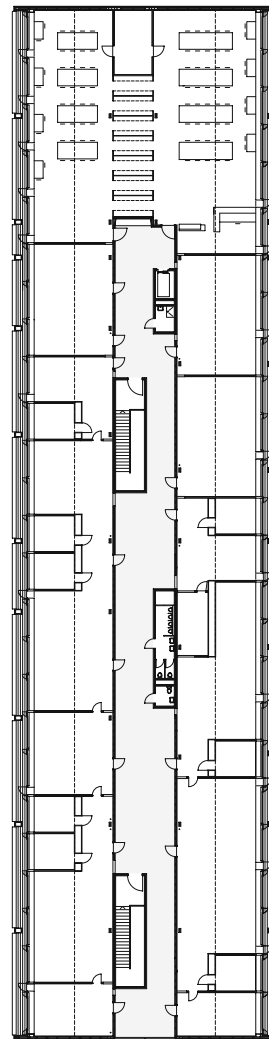


Fig. 265: 3rd floor

Jürg Conzett



**Fig. 266: Model of concrete cores**  
Corridor access (fire-resistant escape routes), concrete towers for stability that accommodate stairs, lifts and sanitary facilities



**Fig. 267: Concrete cores**  
Under construction, 1997; the concrete floors support only their own self-weight and therefore large spans and cantilevers are possible.

### The structure – the engineer's report

The work of the engineer adhered to “contractor-like” virtues: the building should be simple, spacious and economic, should discover opportunities embodied in the architectural concept, exploit any regular components (also structurally) and thus essentially accomplish a harmonious relationship between the architectural and engineering goals.

With this in mind the foundation design for the new teaching building becomes particularly interesting. The heavy, solid central section rests on a concrete basement which in structural terms acts as a continuous box distributing the point loads from above in the longitudinal direction. The loads on the ground slab are distributed evenly into the subsoil; a longitudinal section through the central section reminds us of a floating ship. In contrast to this the loads of the lightweight seminar rooms under which there is no basement are transferred (as point loads corresponding with the loadbearing frame) to a loadbearing stratum via a ring of driven piles.

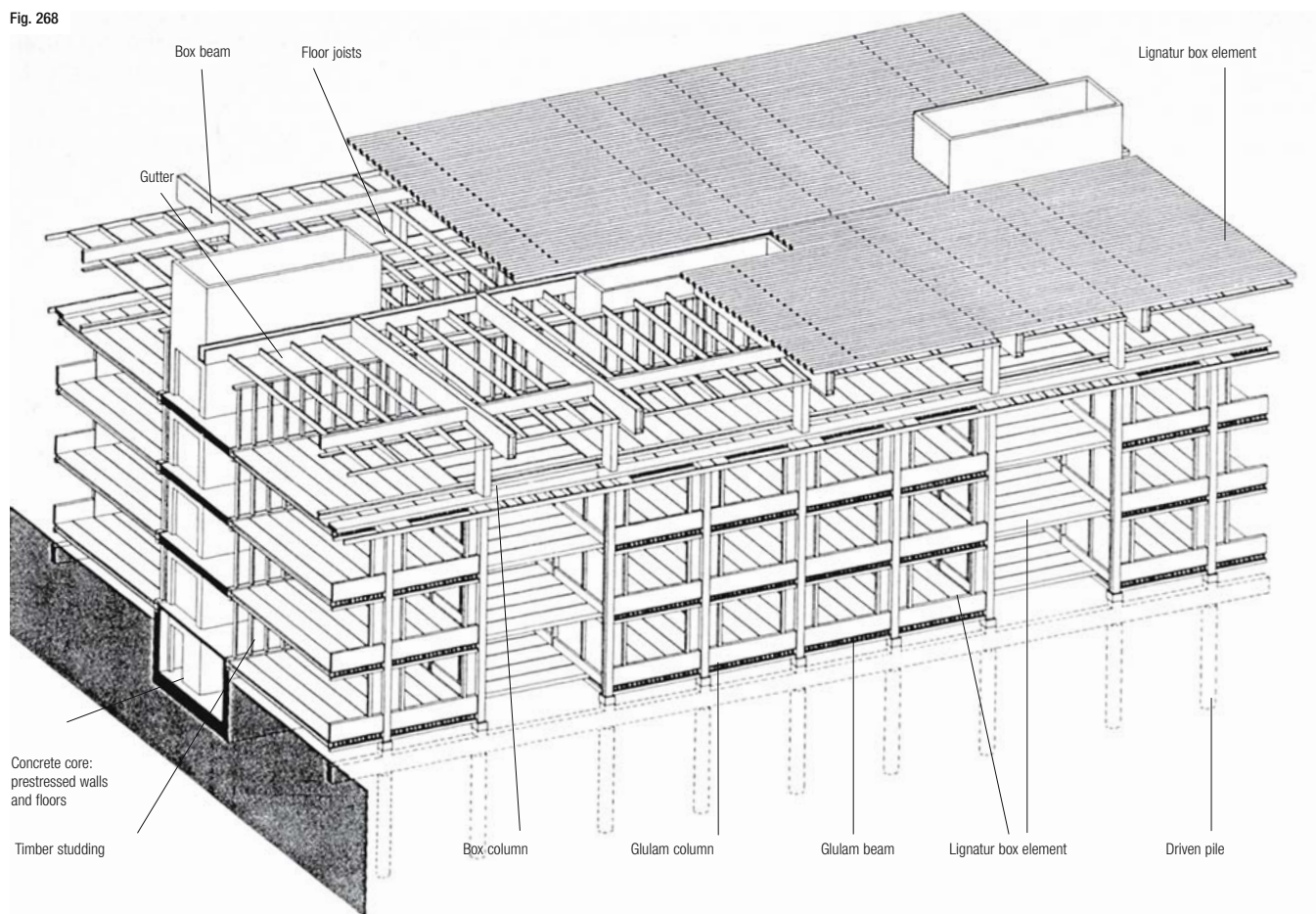
The normal spacing of the piles is 4.800 m, a dimension that matches the pile length well but also represents a sensible spacing for the main columns along the outer longitudinal wall. An 860 mm deep beam (in the spandrel panel) is just able to carry the floor loads over this span.

Above the windows, the floors are suspended from this beam and this leads to a very shallow lintel depth – an important aspect for the daylighting requirements of the interior.

In timber buildings it is less advisable to build non-loadbearing partitions to control the spread of sound and fire. Hence, the floors of the teaching units between rooms and corridors are hence supported on another timber frame. The concrete floors of the central section therefore do not have to carry vertical loads from the rooms, only their own weight, and consequently, they could be designed as prestressed flat slabs with long spans and cantilevers. The corridors do not have any auxiliary columns standing like piers against the walls and so the full width of the corridors is available to users.

The roof beams are likewise box elements, i.e. a top flange and a bottom flange in glued laminated timber linked by glued plywood and placed on top of the loadbearing columns. The roof consists of two large timber panels each 97 m long and 13 m wide. With a beam spacing of 9.6 m the box elements were able to be reduced to 220 mm thanks to the continuity effect – a concept that leaves plenty of scope for the interior layout of the topmost storey.

**Fig. 268**



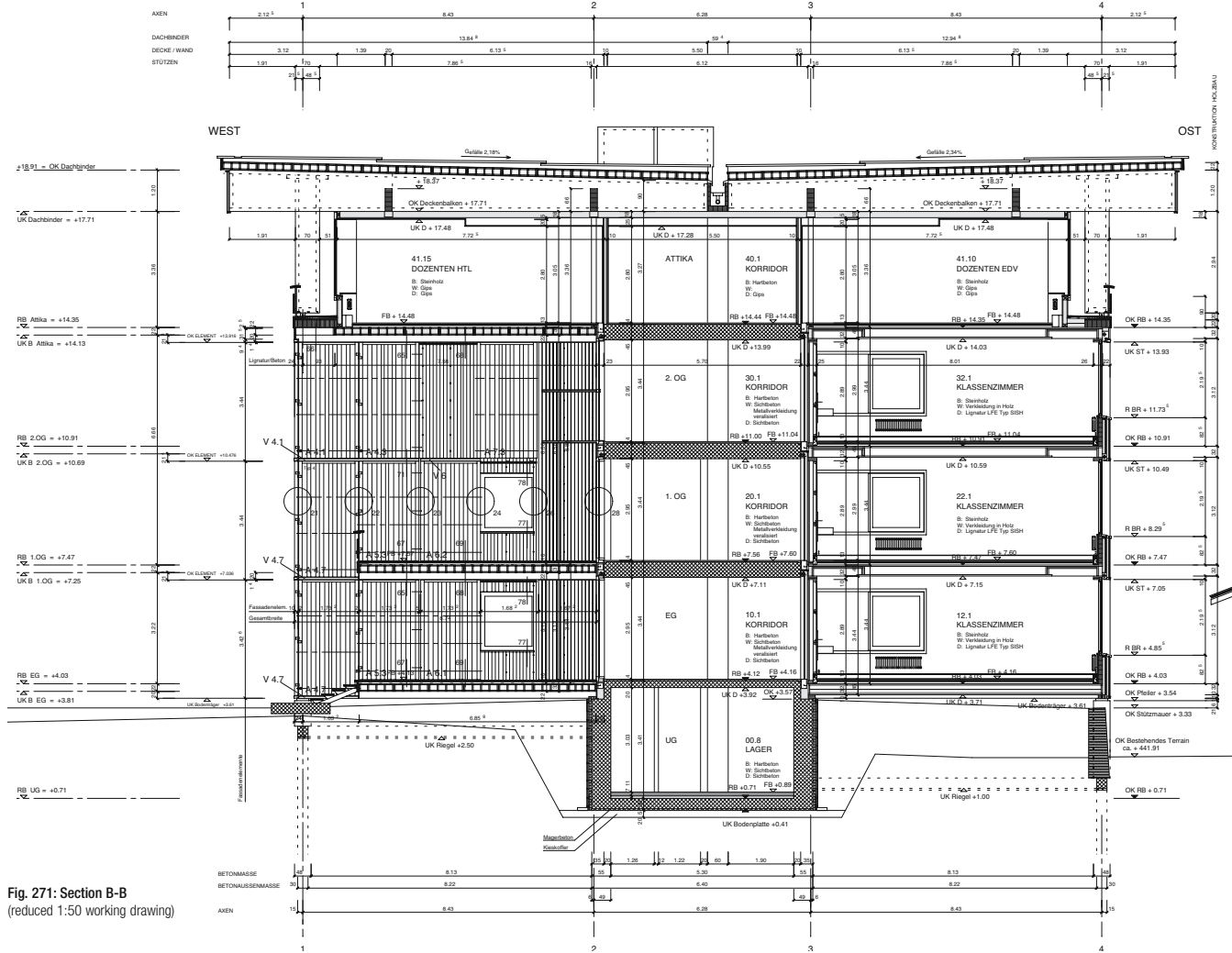




**Fig. 269: Covered external zone**  
The covered external zone between the room boxes allows daylight to enter the corridor alternately from left and right, and – between the “boxes” – also ensures views of the site and the landscape beyond.



**Fig. 270: Foyer**  
The three-storey foyer serves as a lobby for the adjoining assembly hall and the dining hall in the existing building.



Detail design

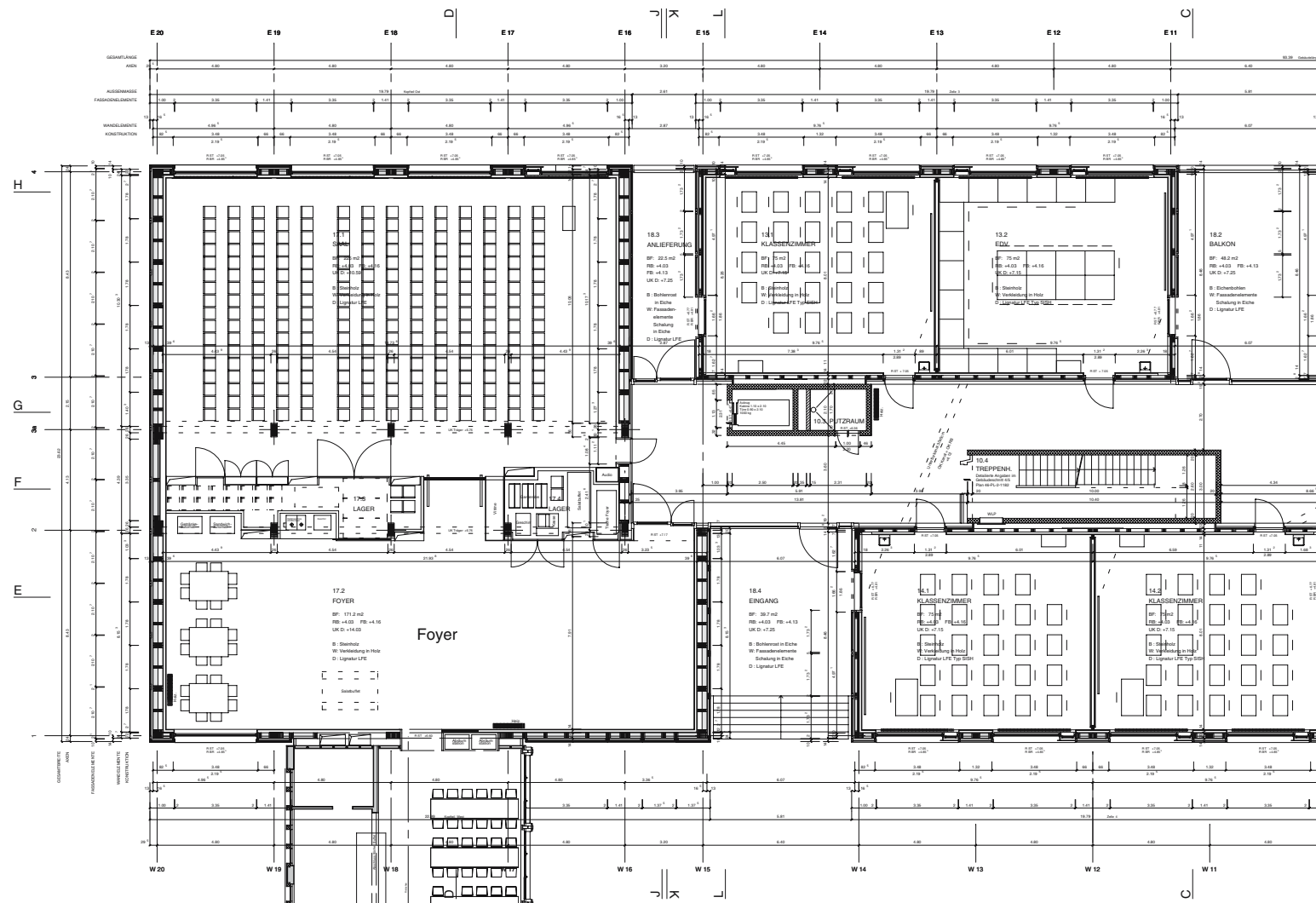


Fig. 272: Plan of ground floor (reduced 1:50 working drawing)



Fig. 273: Transition between concrete core and timber box  
The timber and concrete parts are structurally independent systems. The timber studding is covered on the corridor side with a cement fibreboard (Duripane) for fire protection purposes.



Fig. 274: Seminar room prior to fitting-out work  
The ceiling comprises Lignatur box elements left exposed which present a continuous soffit. This results in excellent flexibility for the positioning of partitions.

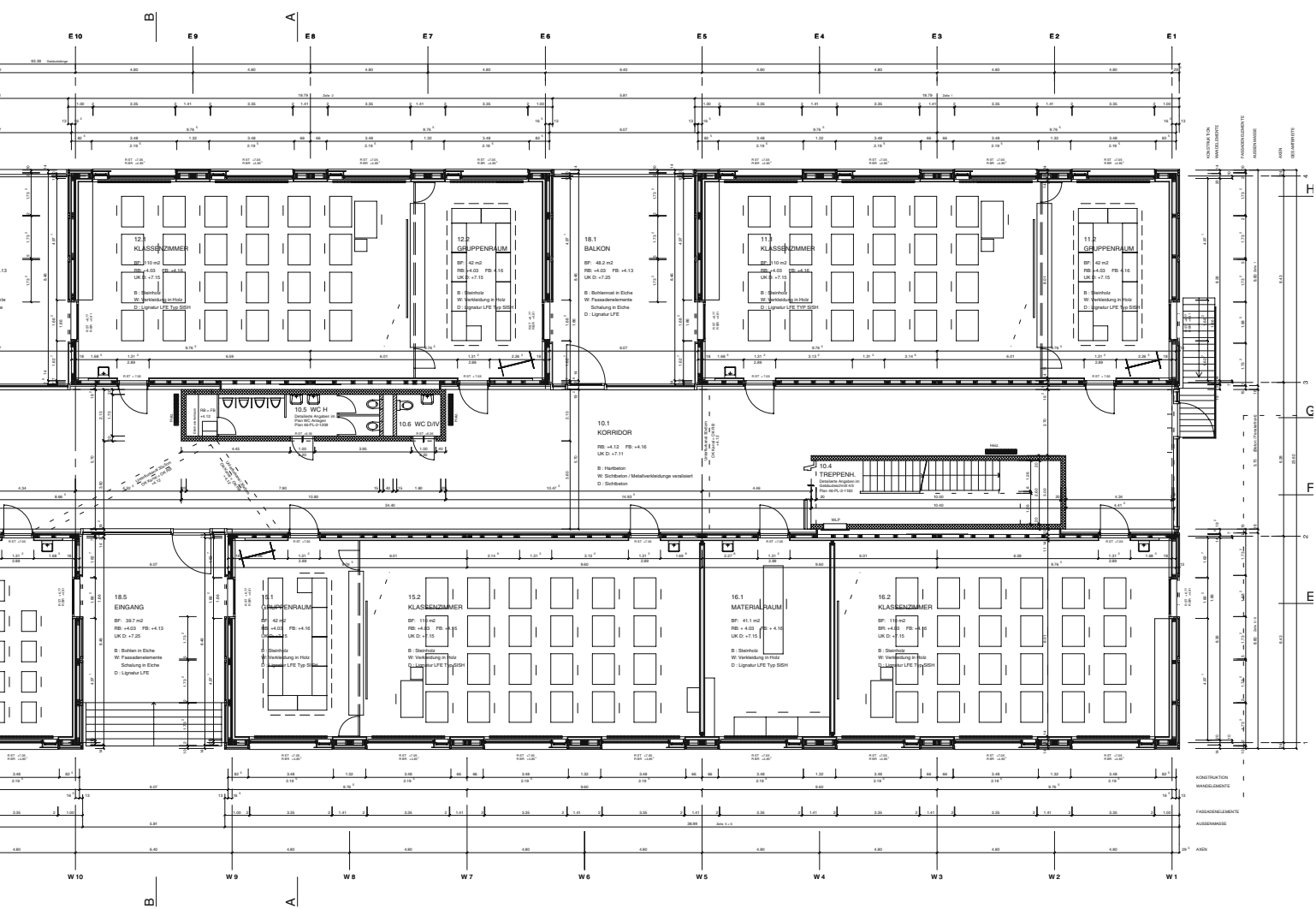


Fig. 275: The two-storey assembly hall is located at one end of the building.

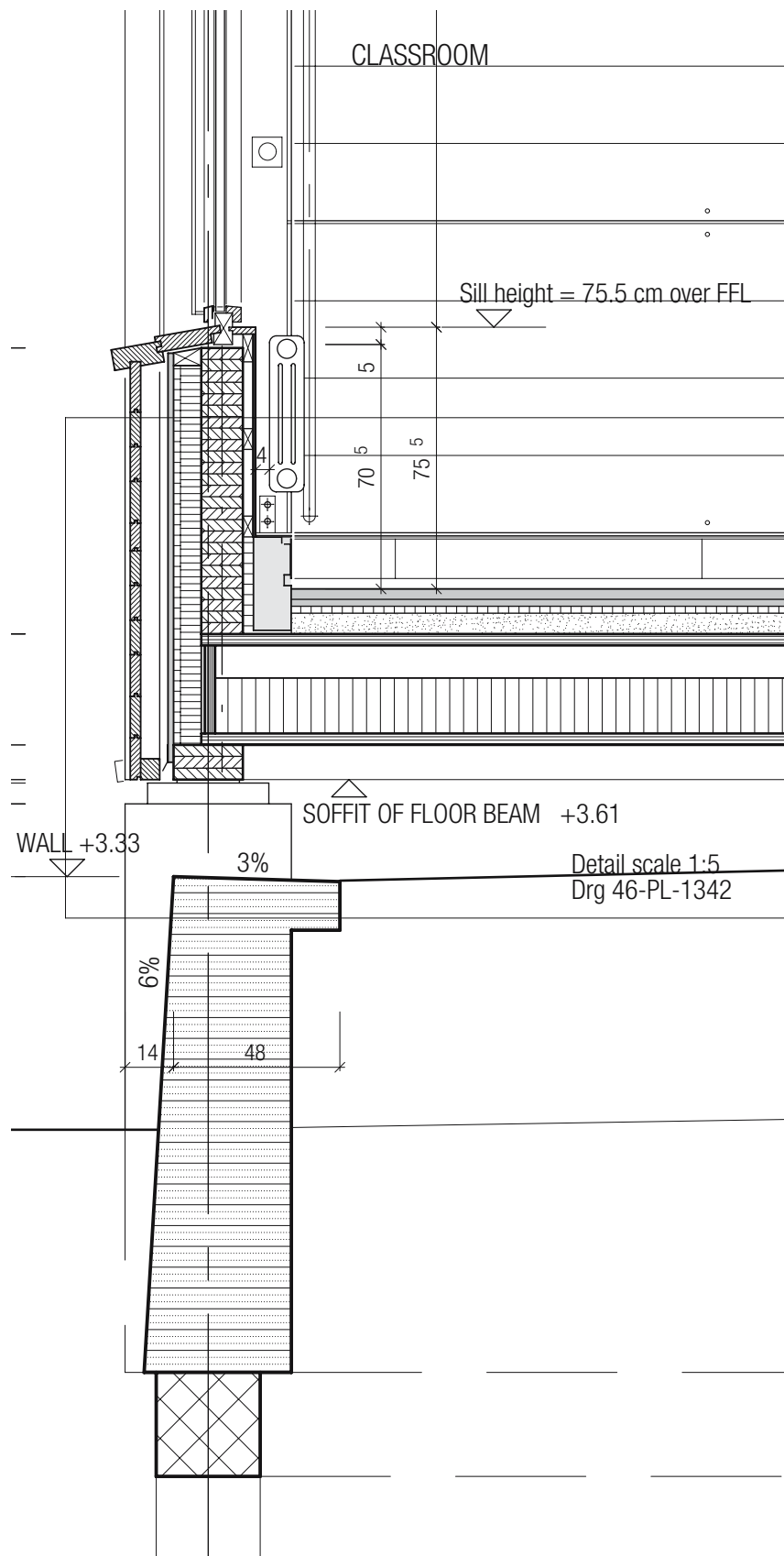


Fig. 276: Plinth detail, 1:20



Fig. 277: Plinth



Fig. 278: Close-up of plinth

The columns that carry the prefabricated facade elements are supported by piles driven about 10 m into the ground. There is a ventilation gap beneath all parts of the timber construction.

#### Wall construction

Oak facade elements (frame and infill)	
Ventilated cavity	
Bitumen-impregnated wood fibre insulating board (Isolair NK)	16 mm
Mineral-fibre board	20 mm
Thermal insulation	80 mm
Upstand beam (in spandrel panel)	120 mm
Inner lining with multiplex boards, surface oiled with aluminium pigments	

#### Floor construction

Flooring cement, 2 layers (e.g. Euböolith) composite of gypsum and asphaltic cardboard	30 mm
Chipboard backing	21 mm
Impact sound insulation, PS81	20 mm
Battens laid out in a grid	65 x 50 mm
Sand or chippings as ballast (for structure-borne sound)	
Polyethylene sheet	
Lignatur LFE element, with 160 mm Homatherm insulation	1000 x 320 mm

#### Plinth

Tamped concrete with exposed aggregate finish, broken limestone aggregate	max. 63 mm
---	------------



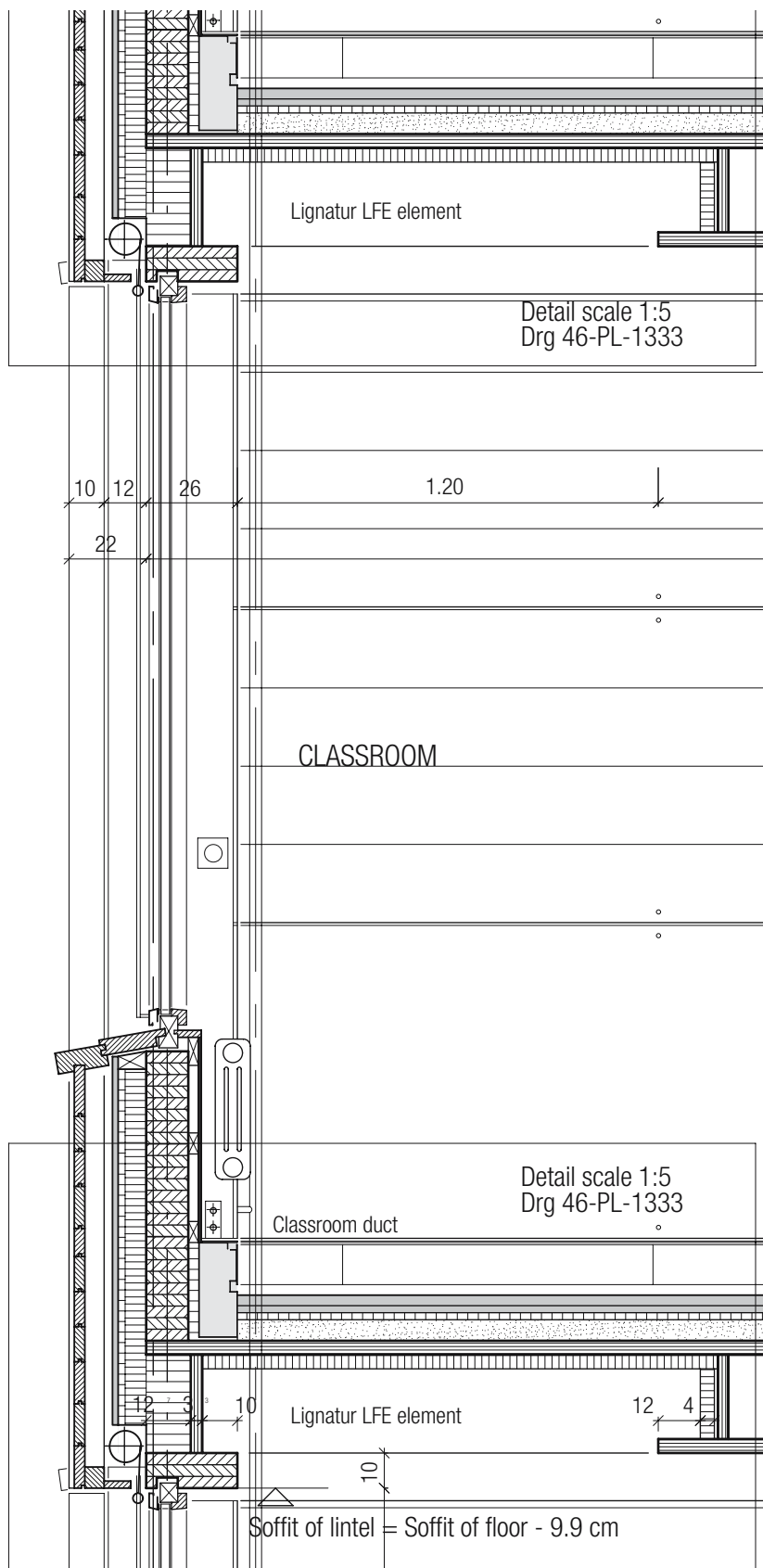
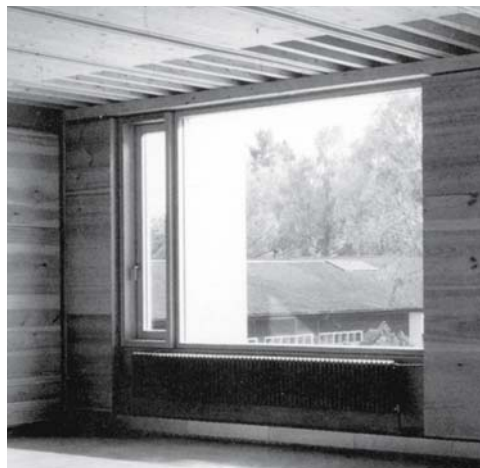


Fig. 279: Window detail, 1:20



**Fig. 280: Window**  
The window is fitted directly into the structural frame. A narrow opening light for ventilation has been included instead of just providing a large undivided glazed area.



**Fig. 281: Sunshading**  
Sunshading in the form of an aluminium shutter in front of the ventilation light plus a fabric awning in front of the fixed light

**Wall construction**

- Oak facade elements (frame and infill)
- Ventilated cavity
- Bitumen-impregnated wood fibre insulating board (Isolair NK) 16 mm
- Mineral-fibre board 20 mm
- Thermal insulation 80 mm
- Upstand beam (in spandrel panel) 120 mm
- Inner lining

**Floor construction**

- Flooring cement, 2 layers (e.g. Euböolith) 30 mm composite of gypsum and asphaltic cardboard
- Chipboard backing 21 mm
- Impact sound insulation, PS81 20 mm
- Battens laid out in a grid 65 x 50 mm
- Sand or chippings as ballast (for structure-borne sound)
- Polyethylene sheet
- Lignatur LFE element, with 160 mm Homatherm insulation 1000 x 320 mm

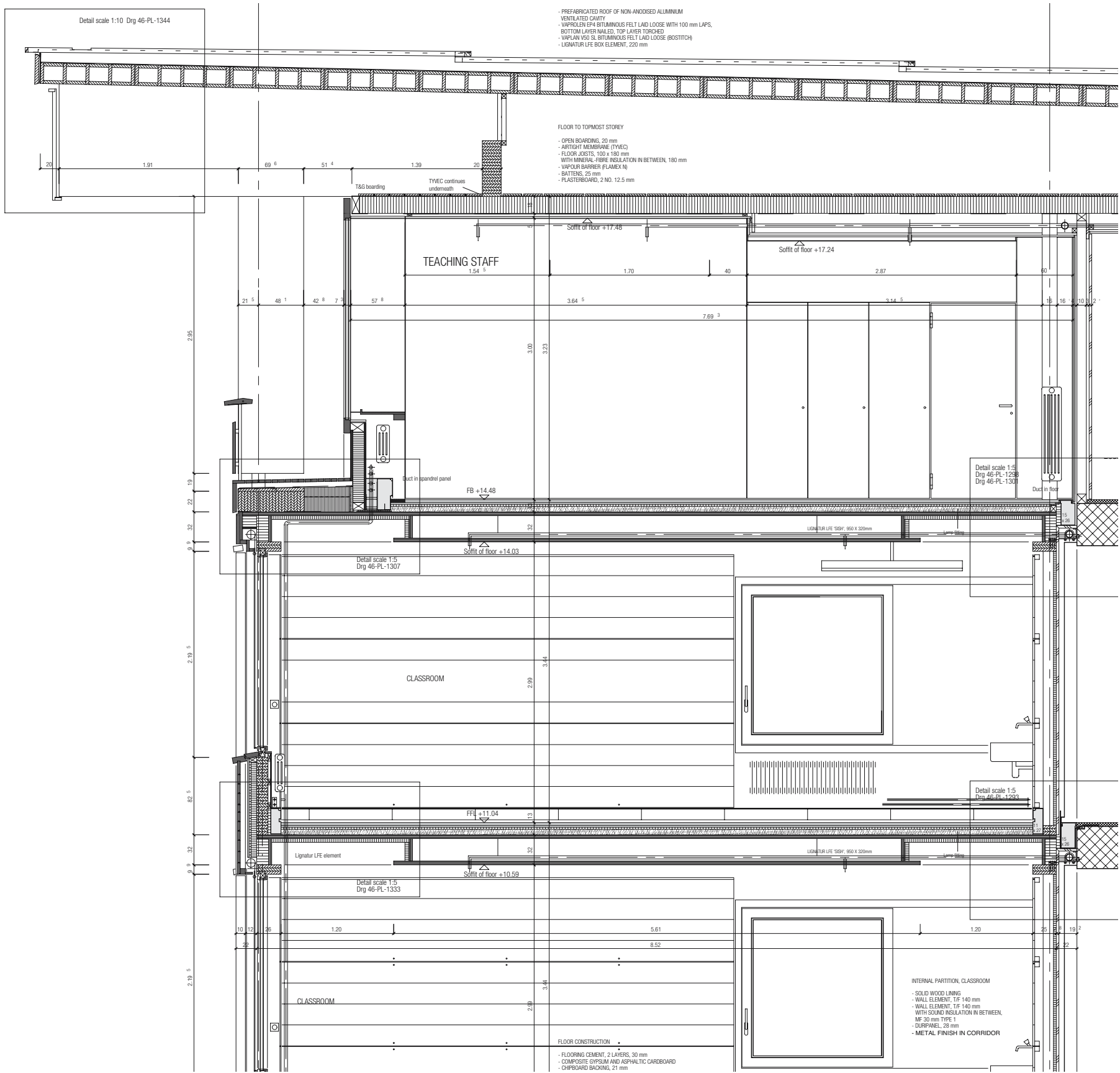


Fig. 282



**Fig. 283: 3rd floor**

Wholly in keeping with a *plan libre*, the column grid on the 3rd floor enables complete freedom for the plan layout. Large box beams supporting the roof are placed on top of the loadbearing box columns, and these together form a stiff half-frame.



**Fig. 284: Corridor on 3rd floor**

The corridor on the 3rd floor is an enclosed space without references to the outside. The dark, graphite-enriched oil paint finish on the walls seems to make the space even narrower.

### Section through topmost (3rd) storey, 1:50

(reduced 1:20 working drawing)

#### Roof construction

Prefabricated roof of anodised aluminium

Ventilated cavity

Secondary covering layer: bituminous felt

(Vaprolen EP4) laid loose with 100 mm laps,

bottom layer nailed,

top layer torched

Bituminous felt (Vaplan V50 SL) laid loose (Bostitch)

Lignatur LFE box element 220 mm

#### Floor to topmost storey

Open boarding 20 mm

Airtight membrane (TYVEC)

Floor joists, 100 x 180 mm

with mineral-fibre insulation in between

(suspended from beam) 180 mm

Vapour barrier (FLAMEX N)

Battens 25 mm

Plasterboard (e.g. Rigips) 2 No. 12.5 mm

#### Floor construction

Flooring cement, 2 layers (e.g. Euböolith) 20 mm

Composite gypsum and asphaltic cardboard

Chipboard backing 30 mm

Impact sound insulation, PS81 20 mm

Battens laid in a grid with sand or

chippings in between as ballast

(for airborne sound) 65 x 50 mm

Polyethylene sheet

Lignatur LFE box element 320 mm



**Fig. 285: General view**

Together the monumental half-frames carry the roof with its generous overhangs. The shadows cast on the set-back facade by these large surface areas reinforce the visual effect of the column, beam and slab elements.

## Private house, Sevgein

Bearth + Deplazes

### Situation and theme

A small clearing on the edge of the village of Sevgein is the site for this house, a man-made wedge standing between the mountain ridge and the foothills. Starting at the carport next to the road, a narrow footpath leads down to the house itself, greeting us with beautiful views towards Flims and Vorderrhein in the distance. With its minimal footprint, this tower-like unit responds to the idiosyncrasies of the plot and exploits the tolerances of the building regulations (this is still classed as being in the village) while attempting to uphold the openness of the clearing. This building, for which several models were made first, stands as if it were itself a group of trees hugging the edge of forest and hence leaves the largest possible open space.

Designed with a split-level floor arrangement to make maximum use of the interior, the lowest level also follows the line of the terrain. The slope down from the road to the entrance door continues within the house in the stairs, which run down to the dining room.



Fig. 287: Site plan



Fig. 286: View from north-east

The large expanse of glass – bordered by floor, ceiling and walls – reveals the extent of the living room.

Architects: Bearth + Deplazes, Chur  
 Construction period: 1998–1999  
 Assistant: Bettina Werner  
 Structural engineer: Jürg Buchli, Haldenstein

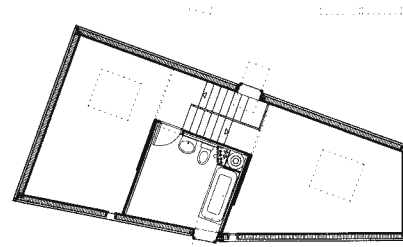




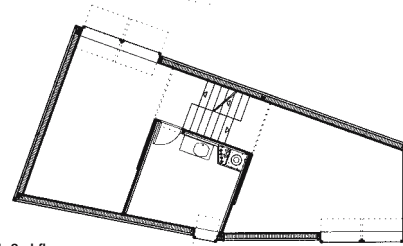
**Fig. 288: Stairs**  
Views into the adjacent rooms in both directions

**Internal layout and loadbearing structure I**

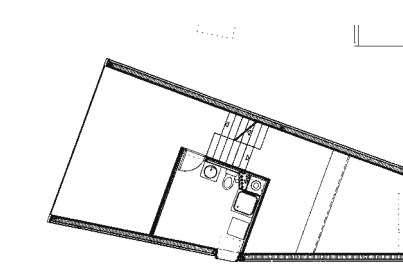
The split-level arrangement mentioned above permits visual links to the room at the next level above or below and, on the whole, helps to give the house a more spacious feeling. The rooms' arrangement falls into place thanks to the inclusion of a "spine" containing kitchen, bathrooms and utility room. Each level (provided with sliding doors) benefits from the lighting of its neighbour. The result is that, for example, the living room, which faces the valley and hence north, is supplied with daylight from the south via the gallery and the stairs. This theme of a vertical layout finds expression not only in a "helix of rooms" but also in the two-storey entrance hall. The timber platform frame facades and the timber stud walls of the central spine are loadbearing and are supported on the in situ concrete basement.



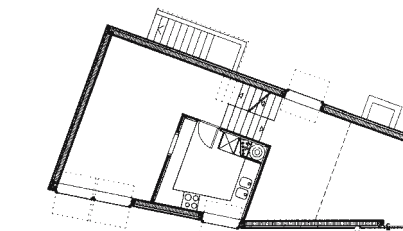
**Fig. 290: Attic**



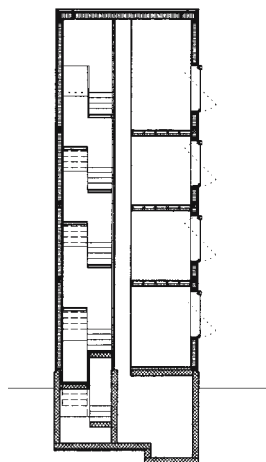
**Fig. 291: 2nd floor**



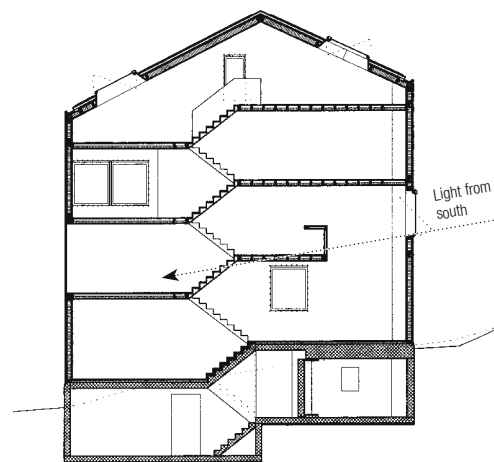
**Fig. 292: 1st floor**



**Fig. 293: Ground floor**



**Fig. 289: Section**



**Fig. 294: Longitudinal section**



### Internal layout and loadbearing structure II

A prefabricated timber structure was chosen because of the geographical location (mountain village with difficult access) and also to facilitate a high degree of self-installation by the owners themselves (facade planking with glaze finish and interior planking with paint finish). Critical factors for the overall architectural impression therefore lay not so much in the accurately conceived and drawn details, as in the working practices, e.g. the cladding used for the facade.

Three different plank widths were fixed vertically, with the only criterion being that the same size planks should be used above and below the window openings. This “automatically” resulted in an interesting, yet technically correct, effect with sections of the facade characterised by the joints between the planks. The dark grey facade minimises the wooden nature of the building and makes it clear that the prime intention here was not to build a “timber house”.

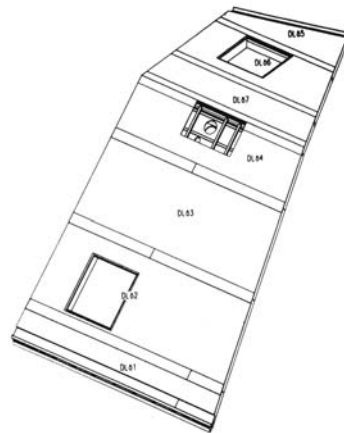


Fig. 295: Axonometric view of roof

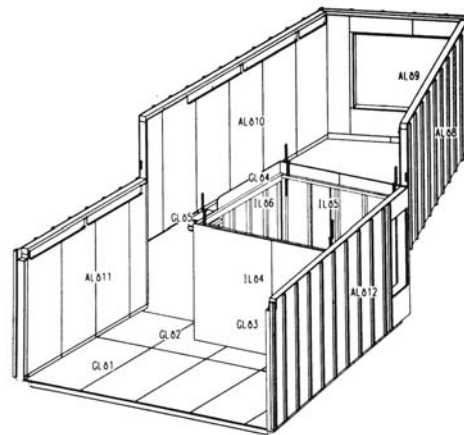


Fig. 296: Axonometric view of wall elements



Fig. 297: Timber platform frame elements waiting to be erected  
The timber platform frame construction was erected in two days.



Fig. 298: Assembling the wall and floor elements  
The floor elements are suspended between the walls on Z-sections.

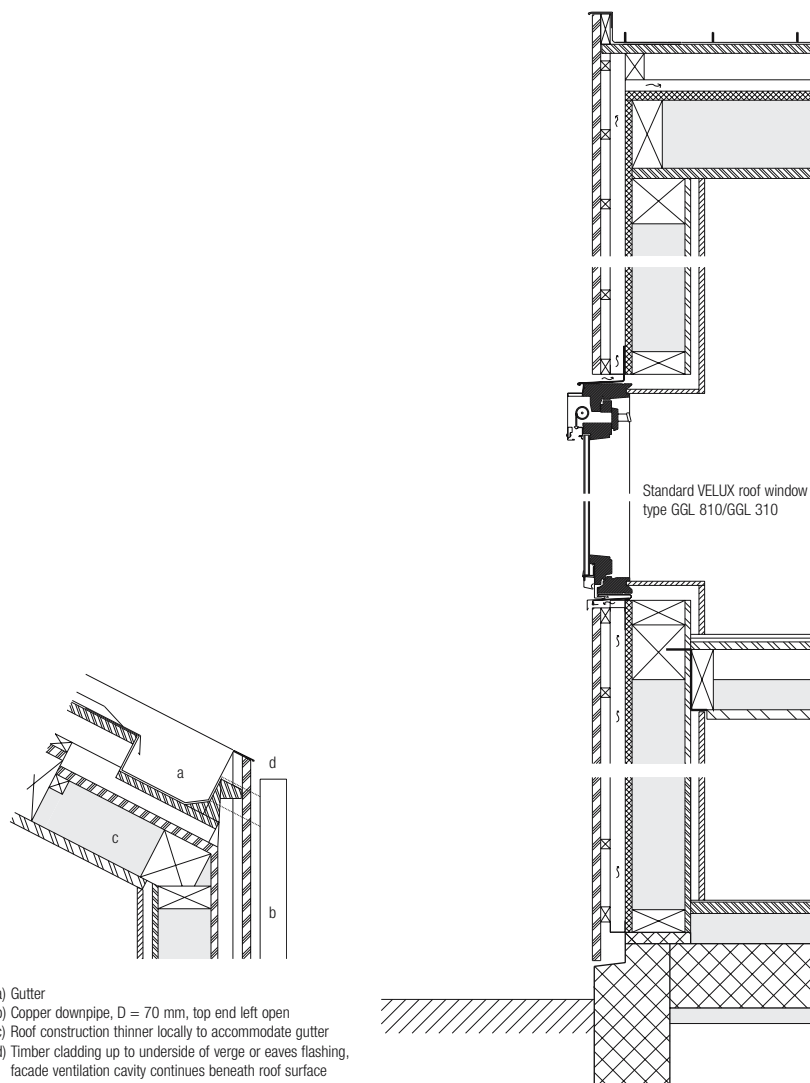


Fig. 299: Installing a roof element  
Prefabrication guarantees a good degree of accuracy.

Facade and roof construction



**Fig. 302: Close-up of window**  
The ventilation flap and roller blind are behind the fascia panel at the top.



- a) Gutter
- b) Copper downpipe, D = 70 mm, top end left open
- c) Roof construction thinner locally to accommodate gutter
- d) Timber cladding up to underside of verge or eaves flashing, facade ventilation cavity continues beneath roof surface

Fig. 300: Detail of eaves with gutter, 1:20

Fig. 301: Section through facade, 1:20

**Roof construction**

Copper roof with locked double welt seams	0.6 mm
Bitumen felt	
Timber boarding	24 mm
Ventilated cavity	100 mm
Bitumen-impregnated wood fibre insulating board	24 mm
Structural timber, spruce/fir with Isofloc thermal insulation between	80 / 180 mm
3-ply core plywood, spruce/fir	27 mm
<b>Total</b>	<b>355 mm</b>

**Wall construction**

Vertical planks with butt joints	22 mm
Battens laid in a grid	25 mm
Counter battens/ventilated cavity	40 mm
Softboard	18 mm
Timber studs/thermal insulation	140 mm
OSB 3-ply core plywood	15 mm
Battens laid in a grid	15 mm
Wood panelling	15 mm
<b>Total</b>	<b>290 mm</b>

### Openings and loadbearing structure

Principally, the timber platform frame construction does not dictate any specific approach to positioning the openings, but rather permits an almost random arrangement. Two types of window are used in this house: a large expanse of glazing for the living room, running from floor to ceiling and from wall to wall, and VELUX roof windows, used not only in the roof but also in the facade! The use of standard roof windows in the walls is unusual, but offers all the advantages of a conventional wood/metal window for the price of a wooden window and, furthermore, allows for ventilation regardless of the weather conditions. The ventilation flap fitted as standard to these windows is protected by the peripheral sheet copper flashing, which also accommodates a roller blind to cut out direct sunlight. Every window is positioned such that one reveal is aligned with one wall, which is therefore used to spread the incoming light throughout the room. The position of the windows also changes from floor to floor on a rotational basis; this highlights the detached nature of the building but also reflects the fluid internal layout. It follows logically that the vertical arrangement of the windows one atop the other in the central spine deviates from this since these rooms are not part of the spatial continuum.



**Fig. 304: Internal view of window on 2nd floor**  
The reveal merges into the wall.



**Fig. 305: Internal view of living room window**  
The frameless glazing seems to eliminate the physical separation.



**Fig. 303: West facade**  
The linear arrangement of the windows identifies the position of the "static" rooms.



**Fig. 306: Window in attic**  
A VELUX roof window used in the traditional way!



# CATALOGUE OF COMPONENTS

Drawings	Foundation – Plinth	Wall – Floor	Opening	Floor	Roof – Parapet
Preparation of drawings for buildings Extract from Swiss standard SIA 400 Presentation on drawings – Example: timber platform frame construction Symbols – Legend for the catalogue of components	Single-leaf masonry, rendered Double-leaf masonry, rendered Facing masonry Fair-face concrete with internal insulation External insulation, rendered External cladding, lightweight External cladding, heavyweight Timber platform frame construction Plinth – Roof: solid timber panel construction	Single-leaf masonry Double-leaf masonry, rendered Facing masonry Fair-face concrete with internal insulation External insulation, rendered External cladding, lightweight External cladding, heavyweight Non-loadbearing external wall Timber platform frame construction Solid timber panel construction	Single-leaf masonry Double-leaf masonry, rendered Facing masonry Fair-face concrete with internal insulation External cladding, lightweight External cladding, heavyweight External insulation, rendered Non-loadbearing external wall Timber platform frame construction Solid timber panel construction Hinged door, external – wood Hinged door, external – wood/glass Sliding door, external – metal/glass Hinged door, internal – wood Sliding door, internal – wood	Hollow clay block floor Hourdis-type hollow clay block floor Solid concrete slab Ribbed concrete slab Concrete waffle slab Hollow-core concrete slab Composite slab, profiled metal sheeting–concrete Solid timber floor Timber joist floor Timber box element floor Steel floor	Pitched roof – warm deck – Fibre-cement, external cladding, lightweight Pitched roof – warm deck, monopitch roof – Fibre-cement facing masonry Pitched roof – cold deck – Roof tiles, masonry in brick-work bond Pitched roof – cold deck – Sheet metal, single-leaf masonry Flat roof – warm deck – Bitumen, double-leaf masonry, rendered Flat roof – warm deck – Bitumen, fair-face concrete with internal insulation Flat roof – warm deck – Plastics, external cladding, heavyweight Flat roof – warm deck – Bitumen, non-loadbearing external wall Flat roof – upside-down roof – Bitumen, external insulation, rendered Flat roof – cold deck, uncoated roof – Bitumen, timber platform frame construction Flat roof – warm deck, suitable/unsuitable for foot traffic Flat roof – cold deck Flat roof – upside-down roof, with rooftop planting

## Preparation of drawings for buildings

Excerpt from Swiss standard SIA 400:2000

### B.1.4 Scales

All the scales used on a drawing are to be stated in the title block of the drawing.

The following scales are used in the building industry:

Scale	Generally used for the following	
1:10 000 1: 5000 1: 2000	Location drawings, block plans	
1: 1000 1: 500	Site plans, cadastral surveys	
1: 200	Urban site plans, competition drawings, preliminary scheme drawings	
1: 100	General arrangement (GA) drawings	
1: 50	Fabrication drawings	Working drawings
1: 20 1: 10 1: 5 1: 1	Detail drawings	

Fig. 1: Standard scales for architectural drawings

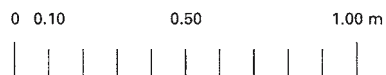


Fig. 2: Example of a scale bar for a 1:20 drawing

Owing to the widespread use of reduction techniques it is recommended to include a scale bar on every drawing. This enables approximate dimensions to be taken from the drawing even after it has been reduced in size.

Reductions and enlargements must be indicated as such.

## B.5 DIMENSIONS AND LEVELS

### B.5.1 General

Dimensions have priority over the accuracy of the drawing. It is recommended to draw a line over dimensions that do not match the dimensions as drawn. This also applies to drawings produced with a CAD system.

### B.5.2 Units of measurement

The units of measurement kilometre, metre, centimetre and millimetre shall be used for dimensions and levels, with the unit selected being indicated on the drawing.

Example: Dimensions in m

Decimal fractions shall be separated from the whole number by means of a decimal comma or a decimal point.

Examples in m: 2,75 or 2.75  
0,52 or 0.52

In accordance with modern usage in the Swiss building industry, components that are smaller than one metre – when the basic unit of measurement is the metre – may also be specified in centimetres. In this case millimetres – in conjunction with dimensions in centimetres – are written in superscript form.

Examples: 52 = 0.52 m  
2<sup>5</sup> = 2.5 cm  
0<sup>5</sup> = 0.5 cm

Angles are specified in the old 360-degree format.

Examples: 24° 32.5° 45°

The term fall is used for drainage, incline for trafficable surfaces. Falls and inclines are given in per cent (%) or per thousand (‰). Falls are indicated by an arrow pointing downwards (e.g. draining a garage forecourt), inclines by an arrow pointing upwards (e.g. stairs or ramp).

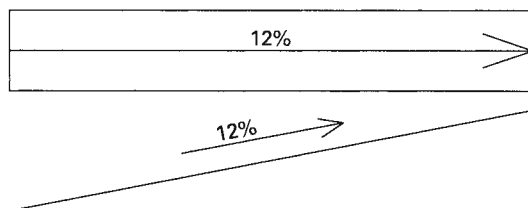


Fig. 3: Indicating an incline on plan and in section

### B.5.3 Dimensions

Dimension lines and dimension projection lines are to be drawn with the thinnest line used.

Marks indicating the extent of the dimension line are to be twice as thick as the dimension line itself.

Dimension projection lines extend almost to the object being dimensioned. If possible, dimension projection lines should not cross one another.

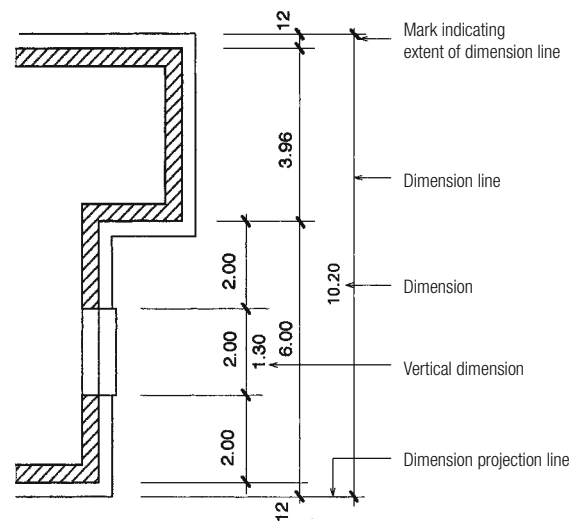


Fig. 4: Dimension lines and dimension projection lines on plan

Dimensions should be written a distance of about half the height of the lettering above the dimension line and such that they can be read from the bottom or the right-hand side of the drawing.

In the case of sloping dimension lines the dimensions should always be written above the dimension line – as seen from the bottom of the drawing.

Dimensions written below the dimension line are vertical dimensions measured from top of threshold or finished floor level (FFL) to underside of structural lintel or underside of structural floor. In the case of windows the dimension is measured from top of finished spandrel panel to underside of structural lintel (= structural opening).

Width and height dimensions (e.g. 30 x 1.80) shall be specified in the case of square/rectangular sections. The symbol for diameter shall be written in front of the dimension in the case of round sections (e.g. Ø 12).

Examples of how to specify dimensions are shown in figures 5 to 8.

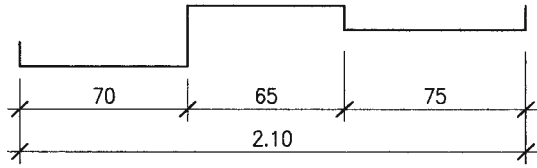


Fig. 5: String of dimensions with overall dimension

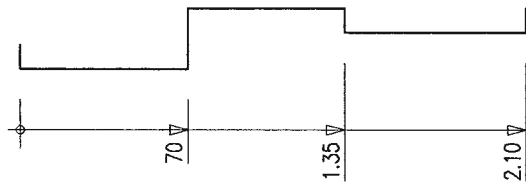


Fig. 6: Chain dimensions

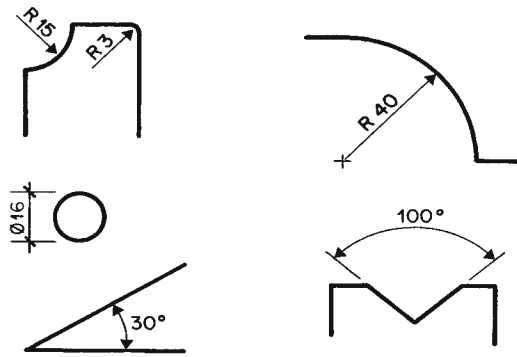


Fig. 7: Specifying radii, diameters and angles

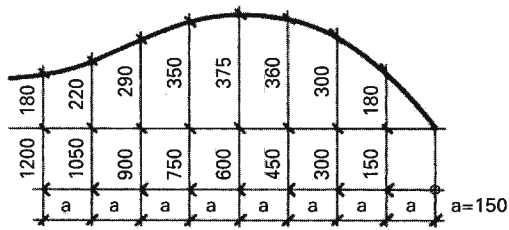


Fig. 8: Specifying an irregular curve

### B.5.4 Levels

Levels must always be specified in metres.

Our starting point is the level  $\pm 0.00$ . This is frequently the finished floor level (FFL) of the ground floor. In exceptional cases a new  $\pm 0.00$  level may be defined for every storey. If this is the case, this new datum should be defined exactly in the title block of the drawing.

Example: level  $\pm 0.00$  for 2nd floor = 518.60 m above sea level

If a level is valid for the entire area of a plan, it may be stated once in the title block of the drawing.

- ▽ +3.25 Finished level, topside
- △ +3.00 Finished level, underside
- ▽ +1.25 Structural level, topside
- △ +1.10 Structural level, underside
- ▽ +0.00 / △ -0.10 Finished and structural levels, topside

Fig. 9: Specifying levels on sections

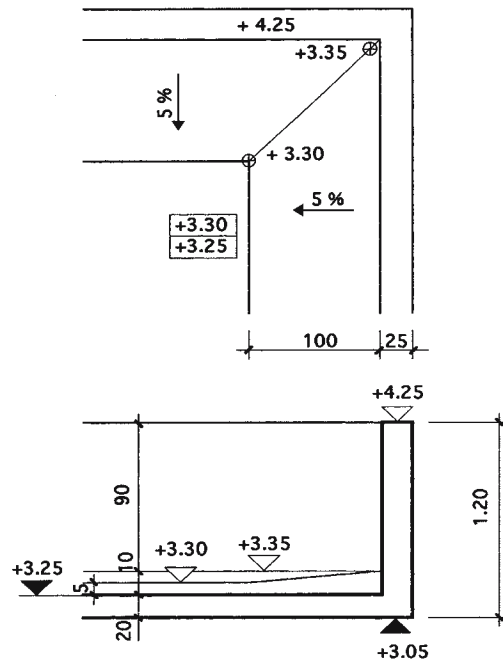


Fig. 10: Example: levels on plan and in section



**B.7 PROJECTIONS**

**B.7.1 Principles of representation**

All parts of the building are three-dimensional components which can be represented only in two dimensions on paper. The representation is carried out by projecting the component onto one plane, the drawing plane.

Figure 12 shows the three-dimensional object represented by the drawings given below.

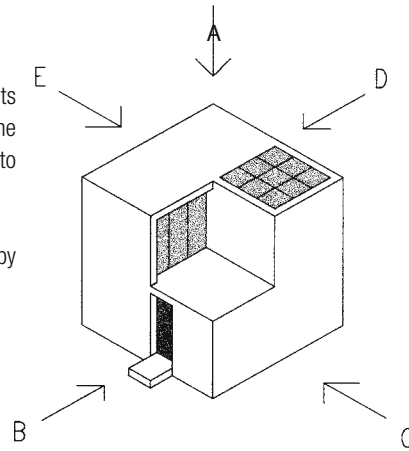


Fig. 12: Perspective view

**B.7.2 Standard projection**

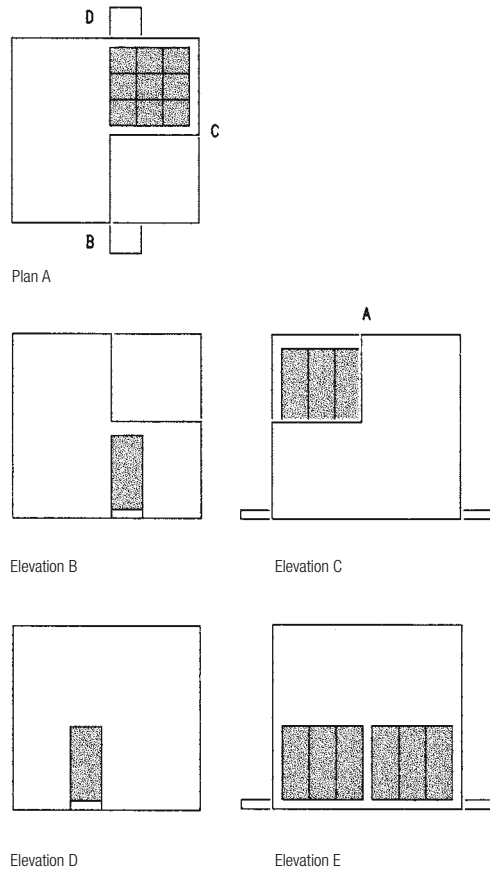


Fig. 11: Standard projection  
Representation of a non-sectioned object

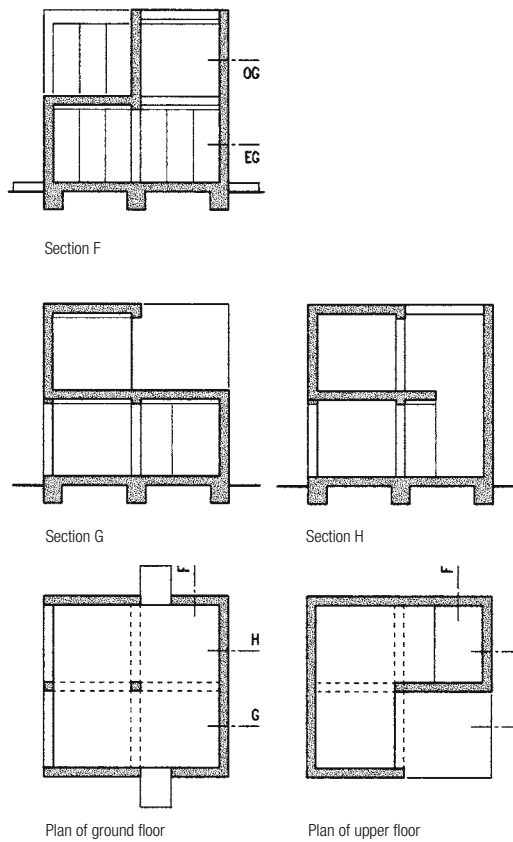


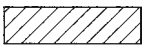

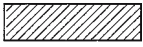
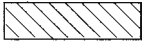



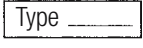
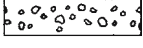




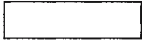






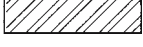
Fig. 13: Standard projection  
Representation of a sectioned object

**B.8.3 Building materials****B.8.3.1 Pictorial representation**

Sectioned surfaces are usually shown enclosed by thick lines and, in addition, by the markings given below.

The density of the markings should be adjusted to suit the scale of the drawing.

Sectioned surfaces on drawings at a scale of 1:100 and smaller are often shown in black or by means of some other equivalent marking for all building materials.

Clay bricks		bright red
Steel (scale 1:1)		
Refractory bricks		dark red
Calcium silicate bricks		grey
Cement bricks		olive green
Plain and reinforced concrete		green
Reconstituted stone		blue-grey
Fair-face concrete		green
Mortar, plaster, render		violet
Solid timber		yellow to brown
Solid timber/ glued laminated timber	 	yellow to brown
Wood-based products		light brown
Metal		light blue
Steel (in section)		black
Insulating materials		pink
Barriers (air, vapour, water)		black/white
Sealing compounds		yellow
Glass		dark green
Plastics		grey
Stone, general		blue

**B.8.3.2 Abbreviations**

(on Swiss German-language drawings)

Concrete	B
Lightweight concrete	LB
Portland cement	CEM I
Hydraulic lime	HL
White lime	CL
Masonry	M

Standard masonry without special properties made from:

- clay bricks	MB
- lightweight clay bricks	MBL
- cement bricks	MC
- lightweight cement bricks	MCL
- calcium silicate bricks	MK
- aerated concrete bricks	MP
- lightweight aerated concrete bricks	MPL

Masonry with special properties is additionally indicated by means of:

- built in masonry bond
- prefabricated
- with declared compressive strength
- external facing leaf masonry
- reinforced
- prestressed
- weathered facing masonry
- non-weathered facing masonry
- with increased fire resistance
- for sound insulation
- for thermal insulation
- with additional requirements for seismic regions

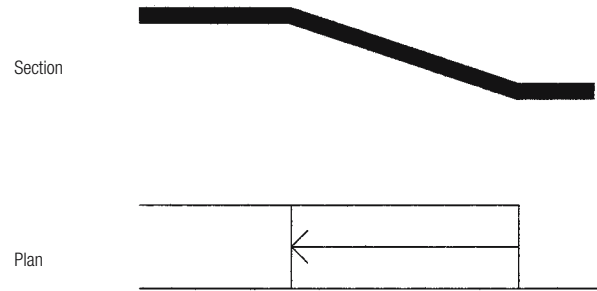
Glued laminated timber (glulam)	BSH
---------------------------------	-----

**B.9.3 Stairs and ramps**

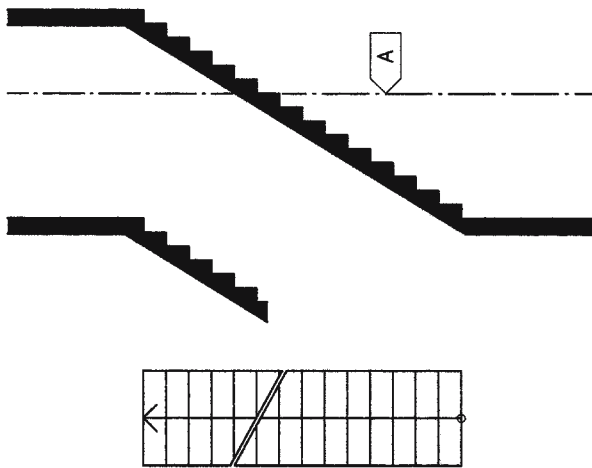
On plans stairs are to be cut through at about two-thirds of their height. In the case of multi-storey stairs the upper part of the lower and the lower part of the upper flight are to be shown.

A continuous arrow shows the upward direction of stairs and ramps.

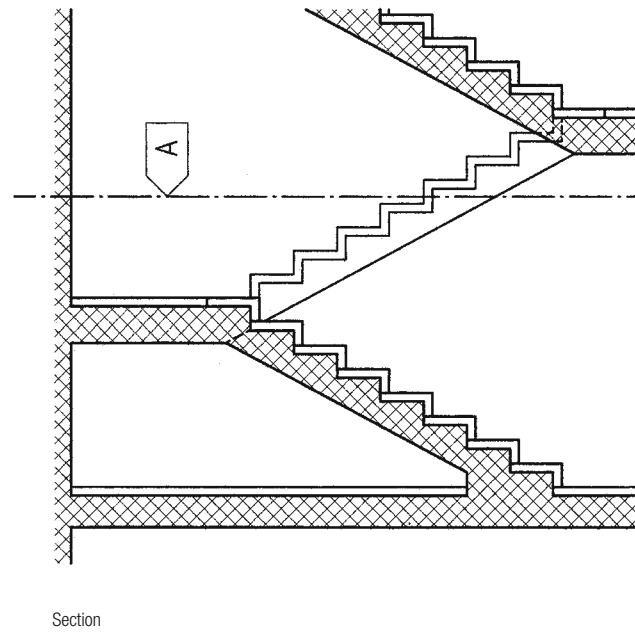
If the stairs rise only one storey, the stairs above the cut line are represented by chain-dot lines.



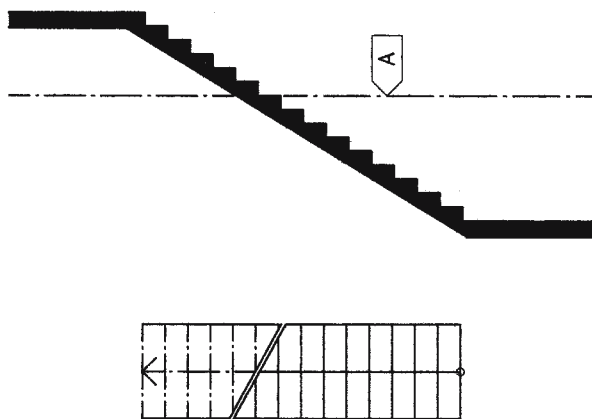
**Fig. 16: Ramp**  
Plan and section



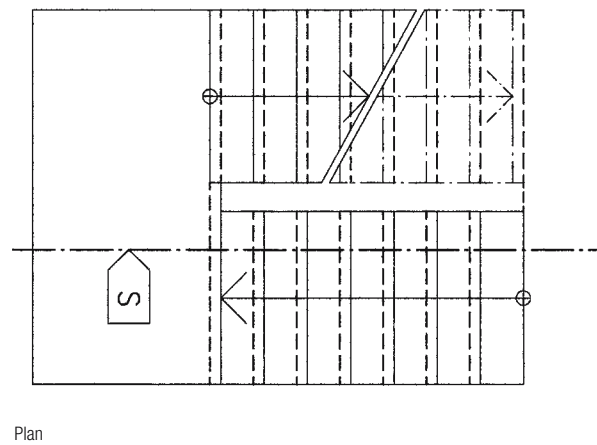
**Fig. 14: Multi-storey stairs**  
Plan and section



Section



**Fig. 15: Single-storey stairs**  
Plan and section

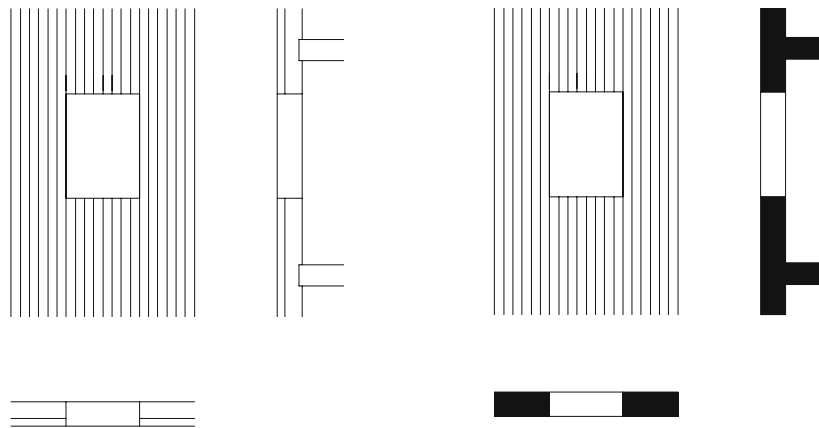


Plan

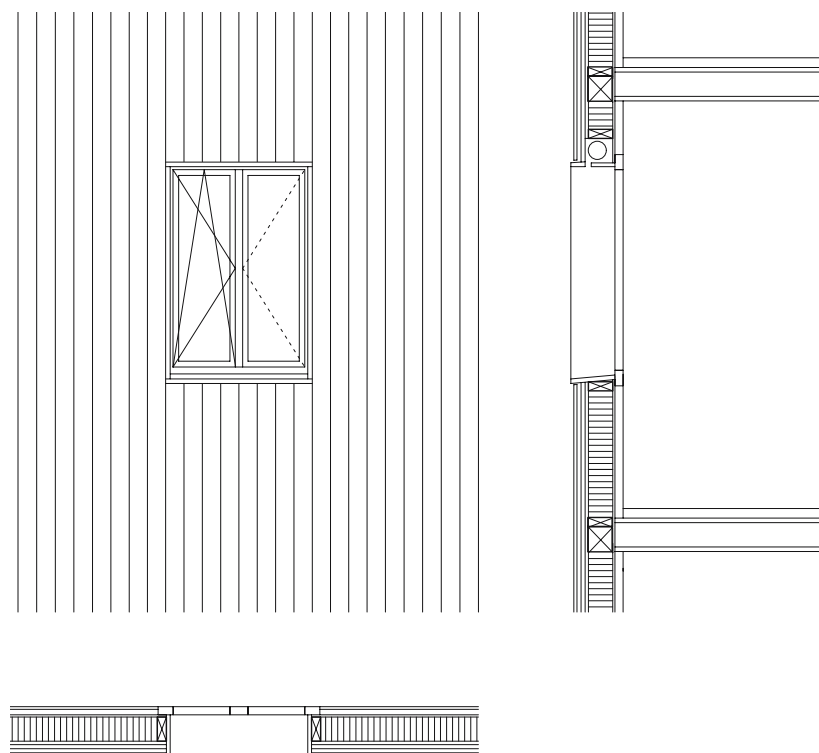
**Fig. 17: Dog-leg stairs**  
Plan and section

## Presentation on drawings

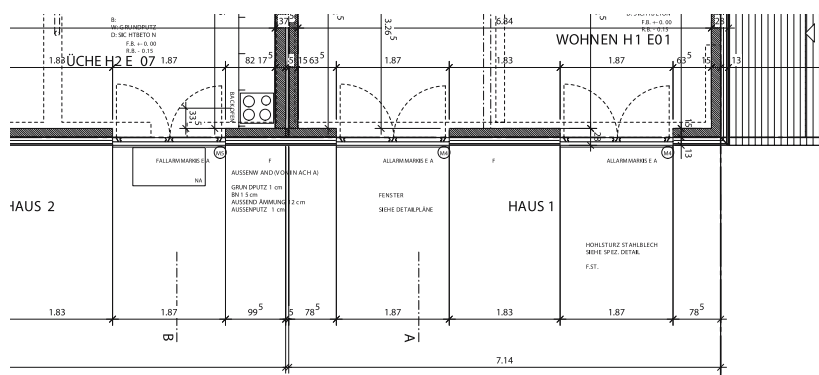
Example: timber platform frame construction



Plan, section, elevation, scale 1:100, outline or shown solid black



Plan, section, elevation, scale 1:50



Example: dimensions on working drawings

### General arrangement drawings, scale 1:100

The general arrangement (GA) drawings contain all the information required for a full understanding of the project. They are (principally) intended for the client and the building authorities.

- Plans, sections, elevations
- Boundaries, neighbouring buildings
- Existing terrain, new landscaping

The expression of size and space is conveyed graphically. Openings are shown as holes, strips, etc. Windows, plinths, roof edges, facade surfaces, etc. are only drawn where they are relevant to the project.

The general arrangement drawings are used as the basis for the building approval drawings. In most cases the general arrangement drawings are equivalent to the building approval drawings. The local building authorities prescribe which additional information the building approval drawings must contain.

### Working drawings, scale 1:50

The working drawings (and fabrication drawings) are essentially limited to the primary building components without finishes and show elements of the construction such as walls, floors, roofs, spandrel panels, lintels (with or without sunshading) and stairs. These drawings serve as a means of communication between the members of the design team and the contractor(s), and are used for actually carrying out the construction work on site. The layers (loadbearing, insulating, protective) are shown when they can be reasonably represented at this scale. The surface finishes are defined via legends (texts). The plinth-wall, wall-floor, wall-roof junction details plus openings etc. are shown schematically (continuity of layers). Thin layers such as plaster etc. are ignored. The windows may be shown simplified: frame and lights together as a box; where necessary, frame and lights are distinguished on elevations and the type of opening indicated.

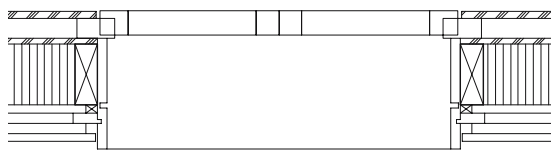
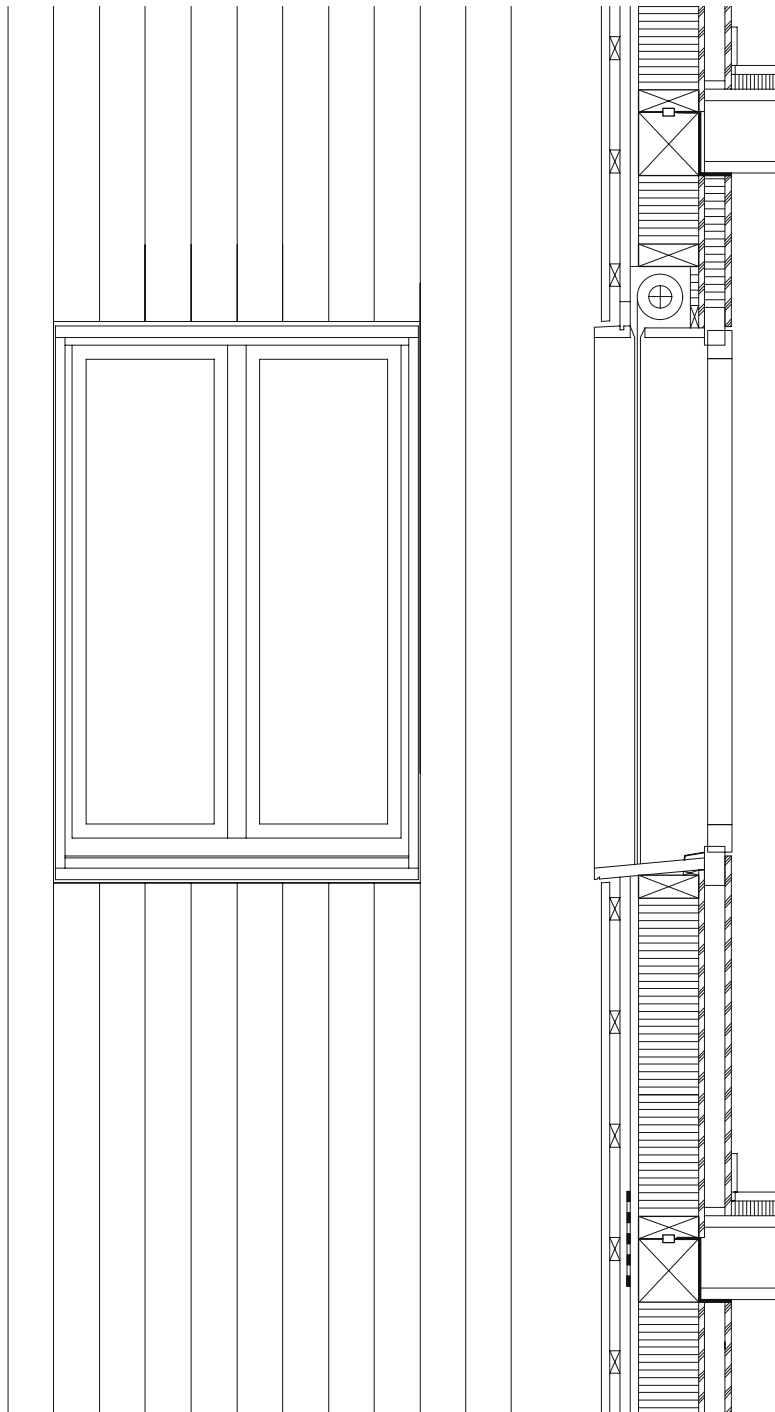
Type of sunshading, internal or external.

Floor/roof construction described in text.

### Dimensions on working drawings

Dimensions are arranged in a hierarchical form beginning with the principal dimensions furthest from the component, parts nearer to the component and details closest to the component. Dimension lines should not cross one another. The working drawings are usually dimensioned in metres rounded off to the nearest half a centimetre (e.g. 3.96<sup>5</sup>). All dimensions less than one metre are given in centimetres (e.g. 55). On detail drawings with higher accuracy requirements dimensions can also be specified in millimetres (e.g. metalwork drawings). It is important to ensure that the units of measurement remain the same throughout and a suitable note appears in the title block (e.g. all dimensions in mm).





Plan, section, scale 1:20

**Detail drawings, scale 1:20**

The detail drawings should be regarded as supplementing the 1:50 working drawings. Every layer is shown and marked/hatched/shaded accordingly. Loadbearing parts of the construction are indicated by means of thicker lines. Junctions such as floor bearings are to be drawn and annotated in detail. Windows are shown schematically with frame and lights by means of individual boxes. All parts of construction such as sunshading with guide tracks, battens, window sills/boards, etc. must be clearly identifiable.

The floor construction is to be drawn showing all layers, including junctions and terminations. If special fittings are included (e.g. underfloor heating pipes), then these should be mentioned.

See to the following catalogue of building components for further examples of drawings. The building components are in some instances shown with too much detail. Freehand sketches may be more abstract. The layout of the drawing must always be considered first.

- Size of drawings, size of paper
- Alignment of plan, section, elevation

**General remarks on representation in drawings**

Many companies (e.g. window manufacturers) provide detail drawings in various data formats. These are highly detailed (1:1). They are included at this scale and are often too precise at the other scales involved. The abstract means of representation mentioned above are generally adequate.

The person producing the drawing should always consider for whom the drawing is intended and what information that person needs. Wherever possible, standard paper sizes are used:

<i>Format</i>	<i>Dimensions in mm</i>	
DIN A4	210 x	297
DIN A3	297 x	420
DIN A2	420 x	594
DIN A1	594 x	841
DIN A0	841 x	1189




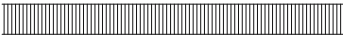



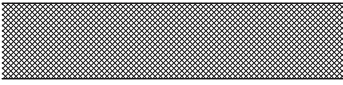
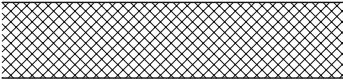
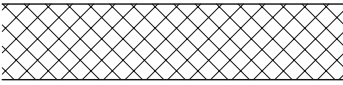


Exchange of drawings between specialists and members of the design team can take place using various formats: DXF, DWG.

Drawing information included in title block:

- Client
- Person responsible for the drawing
- Content of the drawing
- Scale
- Scale bar for reduced drawings
- North arrow
- $\pm 0.00$  = metres above sea level

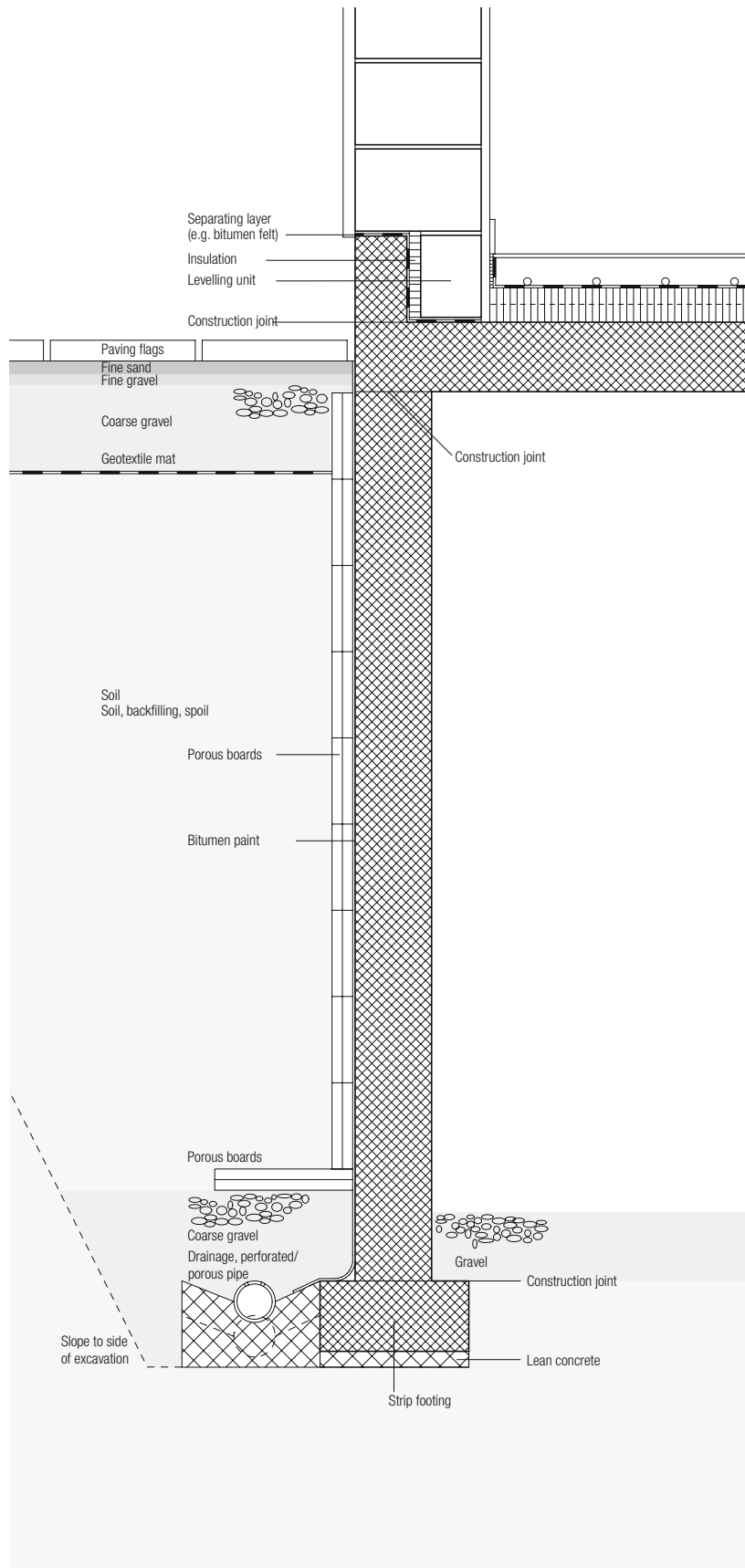
**Symbols**

Legend for the catalogue of components

	Vapour barrier/check
	Waterproofing, airtight membrane
	Separating layer
	Impact sound insulation
	Thermal insulation
	Thermal insulation, impervious to vapour
	Thermal insulation, waterproof
	Reconstituted stone
	In situ concrete
	Lean concrete
	Wood-based board
	Section solid timber

## Plinth, single-leaf masonry

1:20



### Wall construction

- Render	35 mm
- Single-leaf masonry, 36.5 x 24.8 x 23.8 cm	365 mm
- Plaster	25 mm
<i>Total</i>	<i>425 mm</i>

### Floor construction

- Hard-fired floor tiles	10 mm
- Tile adhesive	5 mm
- Screed with underfloor heating	80 mm
- Separating layer (e.g. 1 mm plastic sheet)	
- Thermal insulation, vapourproof (e.g. cellular glass)	100 mm
- Concrete slab over basement	200 mm
<i>Total</i>	<i>395 mm</i>

### Wall construction, damp basement

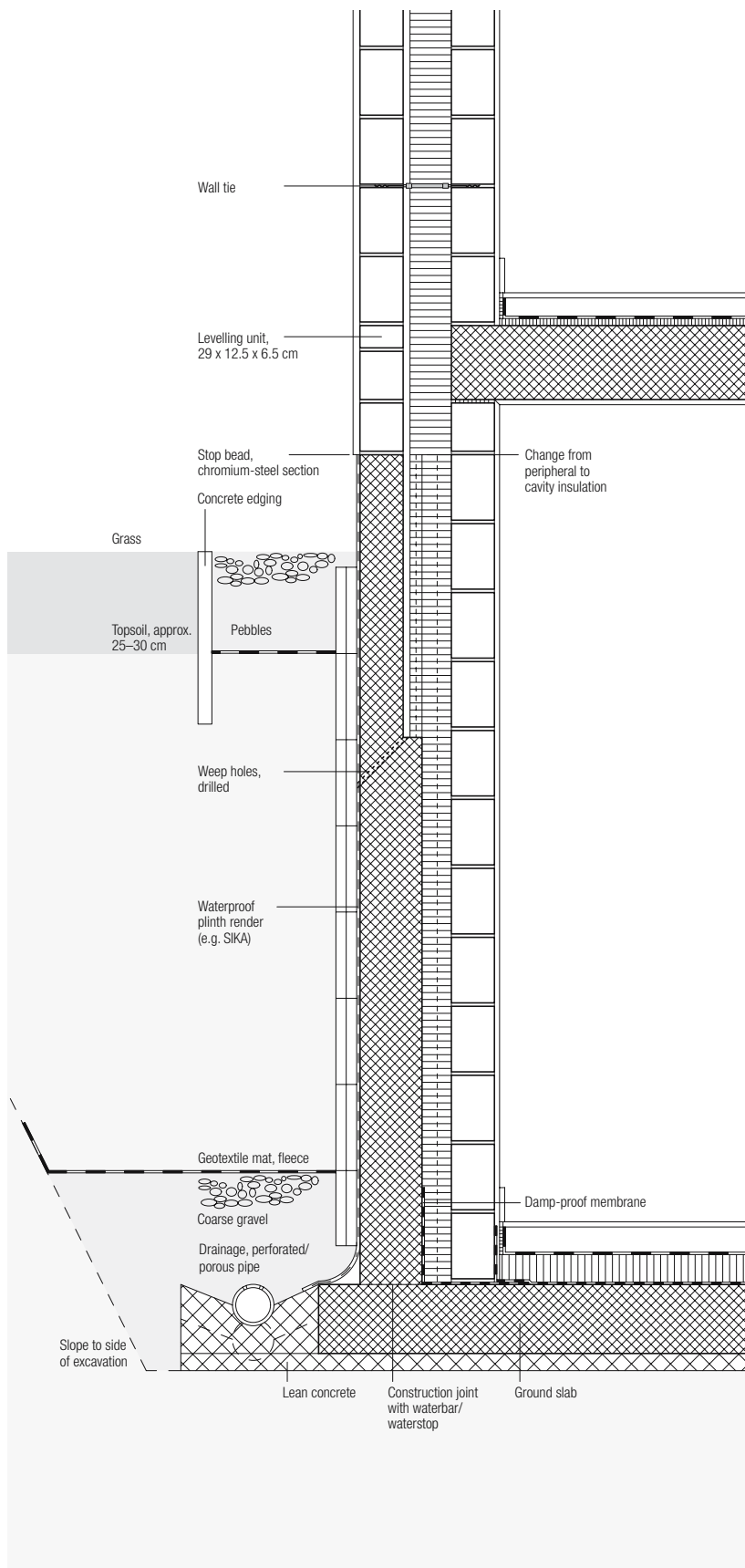
- Porous boards	60 mm
- Waterproofing (e.g. bitumen paint)	2 mm
- In situ concrete wall	220 mm
<i>Total</i>	<i>282 mm</i>

### Floor construction, damp basement

- Layer of stones (e.g. rounded gravel)	200 mm
---	--------

## Plinth, double-leaf masonry, rendered

1:20



### Wall construction

- Render	20 mm
- Clay masonry, B, 29 x 12.5 x 19 cm	125 mm
- Cavity (construction tolerance)	20 mm
- Thermal insulation (e.g. rockwool)	120 mm
- Clay masonry, B 0, 29 x 12.5 x 19 cm	125 mm
- Plaster	15 mm
<i>Total</i>	<i>425 mm</i>

### Floor construction

- Ready-to-lay parquet flooring	15 mm
- Screed	60 mm
- Separating layer (e.g. 1 mm plastic sheet)	
- Impact sound insulation	20 mm
- Concrete slab over basement	210 mm
- Plaster to soffit	10 mm
<i>Total</i>	<i>315 mm</i>

### Wall construction, heated basement

- Porous boards	60 mm
- Waterproof plinth render	10 mm
- In situ concrete wall	180 mm
- Thermal insulation (vapourproof)	60 mm
- Clay masonry, B, 25 x 12 x 14 cm	120 mm
- Plaster	10 mm
<i>Total</i>	<i>440 mm</i>

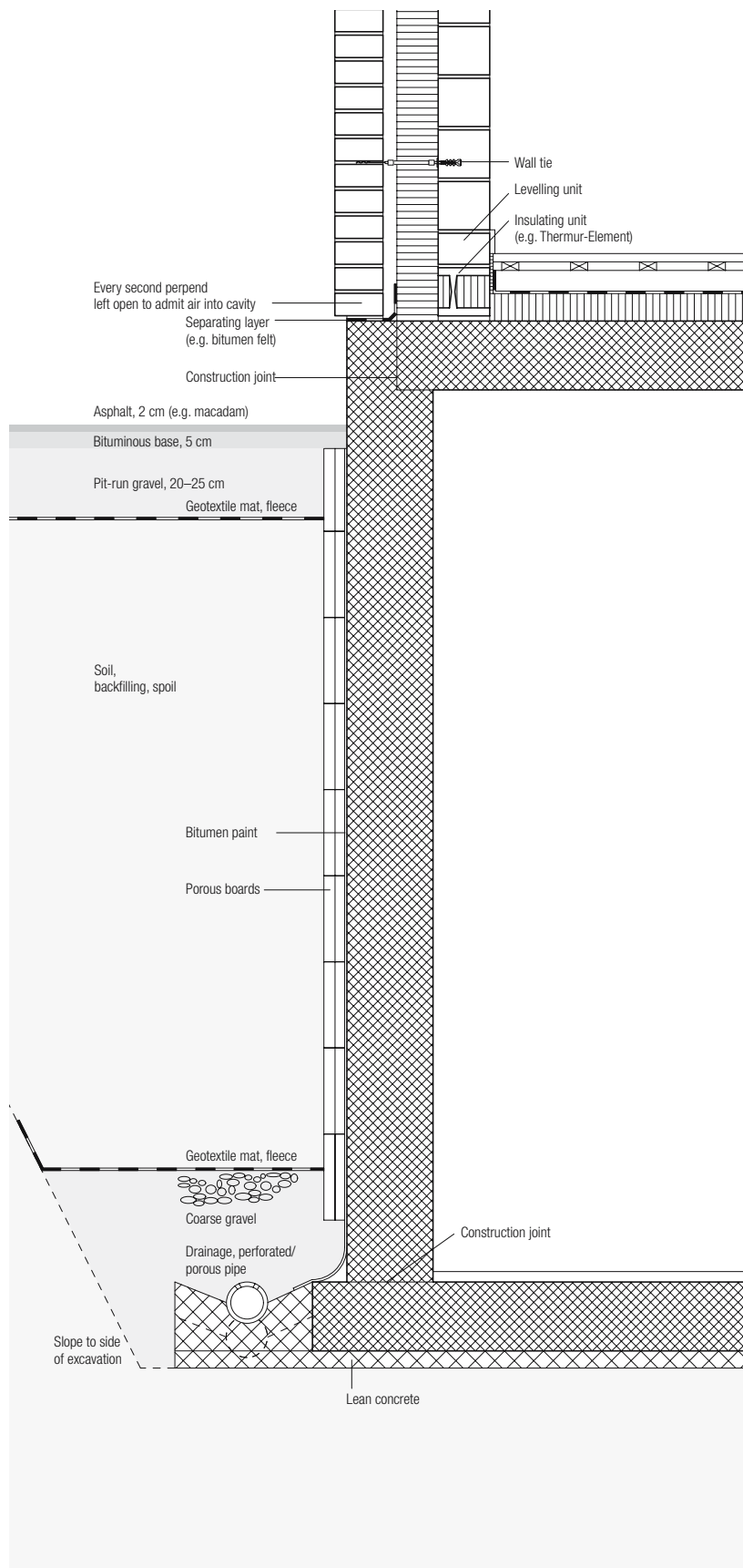
### Floor construction, heated basement

- Ready-to-lay parquet flooring	15 mm
- Screed	80 mm
- Thermal insulation (e.g. cellular glass, expanded polystyrene)	80 mm
- Damp-proof membrane (e.g. Robit)	
- Concrete ground slab	200 mm
- Lean concrete	50 mm
<i>Total</i>	<i>425 mm</i>



## Plinth, facing masonry

1:20

**Wall construction**

- Clay masonry, BS, course 1, 29 x 14 x 6.5 cm
- Clay masonry, BS, course 2, 14 x 14 x 6.5 cm  
(Variations: diverse facing masonry modules, pre-fabricated concrete bricks or elements, etc.) 140 mm
- Ventilated cavity min. 40 mm
- Thermal insulation (e.g. rockwool) 120 mm
- Clay masonry, BS, 25 x 15 x 14 cm 150 mm
- Total* 450 mm

**Floor construction**

- Wooden floorboards 24 mm
- Battens 30 mm
- Layer of felt 2 mm
- Screed 60 mm
- Separating layer (e.g. 1 mm plastic sheet) 80 mm
- Thermal insulation, vapourproof 200 mm
- Concrete slab over basement 200 mm
- Total* 396 mm

**Wall construction, unheated basement**

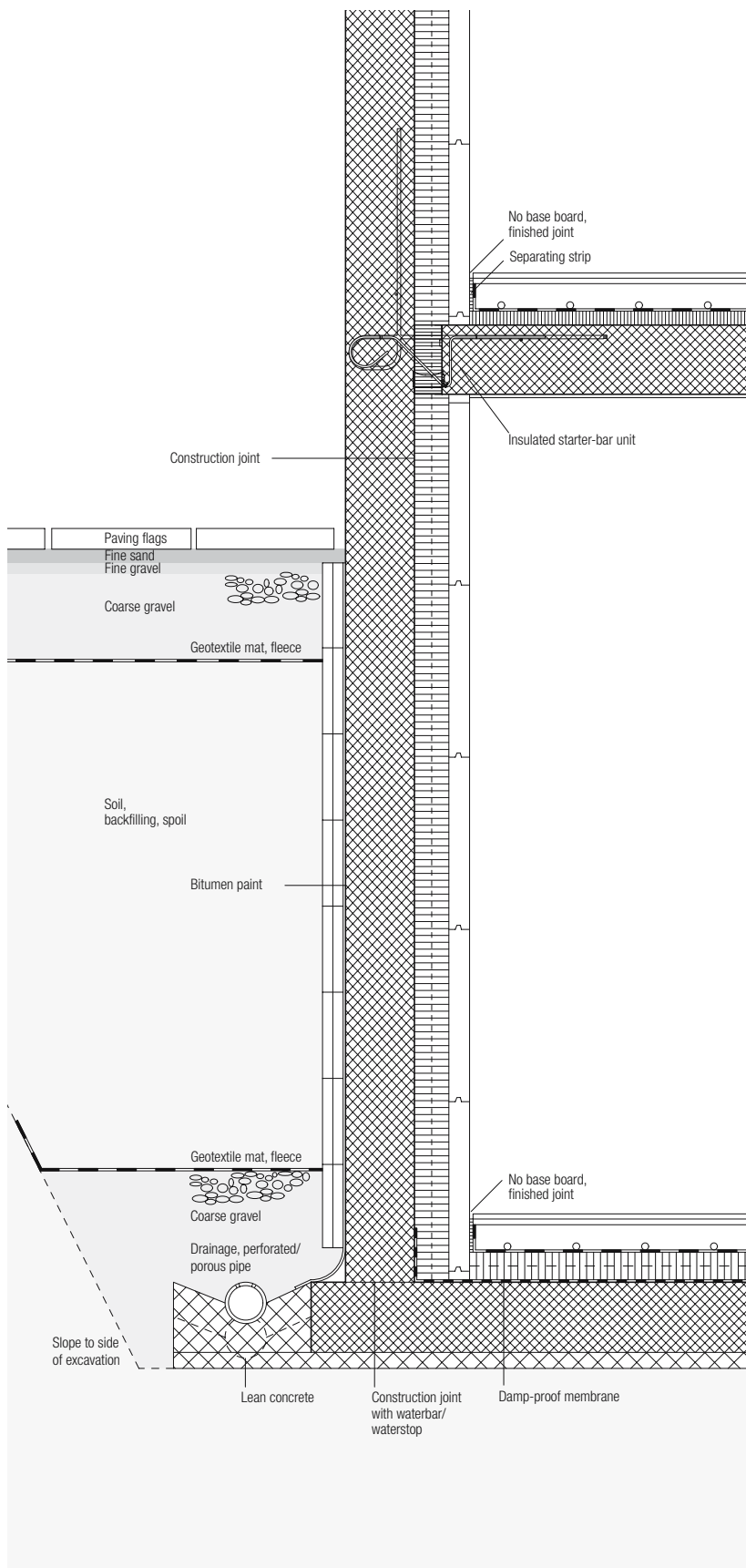
- Porous boards 60 mm
- Waterproofing (e.g. bitumen paint) 2 mm
- In situ concrete wall 240 mm
- Total* 302 mm

**Floor construction, unheated basement**

- Screed 30 mm
- Concrete ground slab 200 mm
- Lean concrete 50 mm
- Total* 280 mm

## Plinth, fair-face concrete with internal insulation

1:20

**Wall construction**

- Fair-face concrete, coloured	220 mm
- Thermal insulation, vapourproof (e.g. cellular glass)	100 mm
- Gypsum boards, plaster skim/paint finish	60 mm
<i>Total</i>	<i>380 mm</i>

**Floor construction**

- Stone floor tiles	15 mm
- Mortar bed	15 mm
- Screed with underfloor heating	80 mm
- Separating layer (1 mm plastic sheet)	
- Impact sound insulation	40 mm
- Concrete slab over basement	200 mm
- Plaster to soffit	10 mm
<i>Total</i>	<i>360 mm</i>

**Wall construction, heated basement**

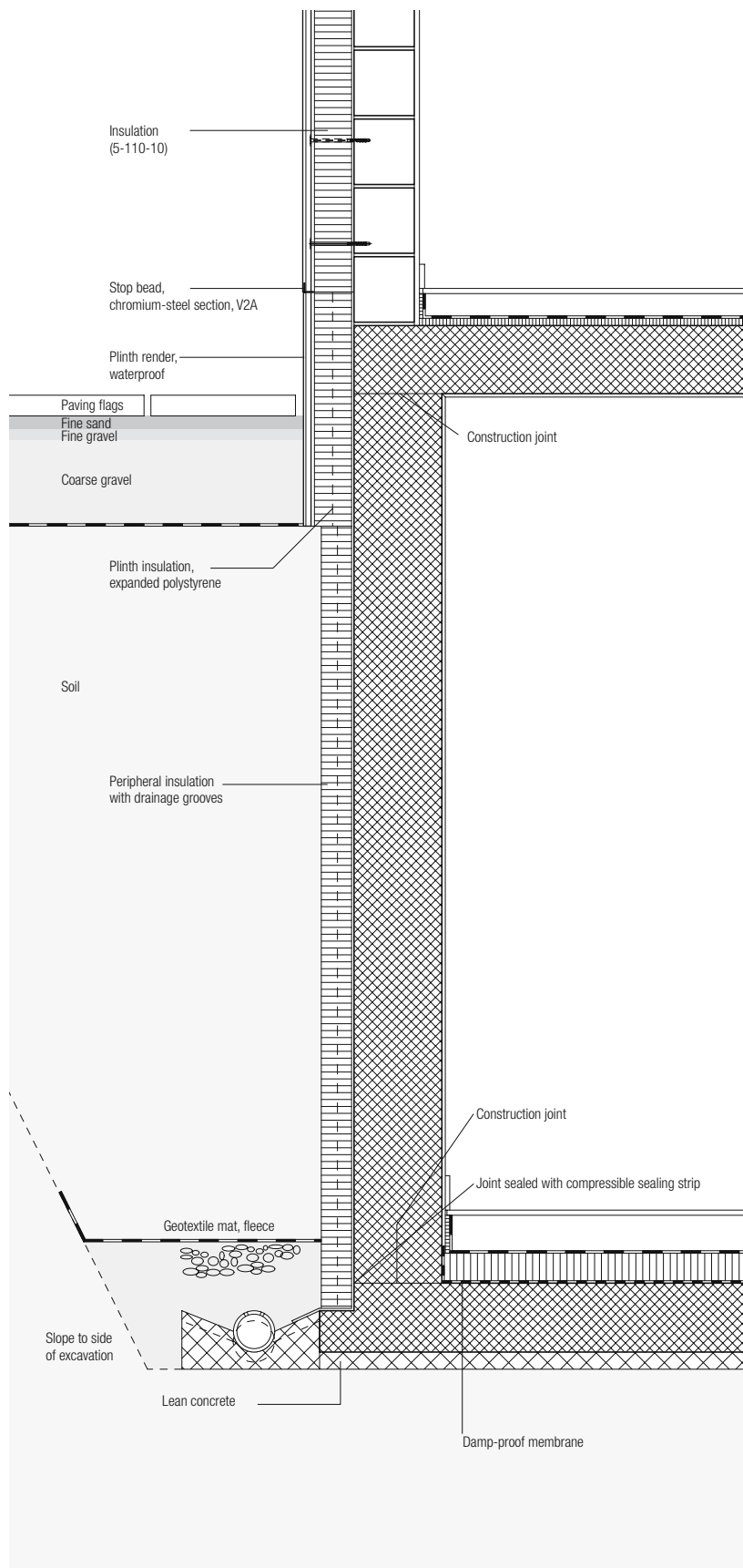
- Porous boards	60 mm
- Concrete with water-repelling admixture (e.g. Efa-Füller)	220 mm
- Thermal insulation, vapourproof (e.g. cellular glass)	100 mm
- Gypsum boards, plaster skim/paint finish	60 mm
<i>Total</i>	<i>440 mm</i>

**Floor construction, heated basement**

- Stone floor tiles	15 mm
- Mortar bed	15 mm
- Screed with underfloor heating	80 mm
- Thermal insulation, waterproof (e.g. cellular glass)	80 mm
- Damp-proof membrane (e.g. Robit)	
- Concrete ground slab	200 mm
- Lean concrete	50 mm
<i>Total</i>	<i>440 mm</i>

## Plinth, external insulation, rendered

1:20



### Wall construction

- e.g. Wancor-Therm K
- Mineral render finish coat (coloured or painted) 2 mm
- Bonding render (with glass mat inlay over entire surface) 4 mm
- Mineral render undercoat 20 mm
- Insulation board 5-110-10 (3-layer board), fixed with plastic fasteners 125 mm
- Clay masonry, B, 29 x 17.5 x 19 cm 175 mm
- Plaster 15 mm
- Total* 341 mm

### Floor construction

- Magnesite flooring (seamless) 15 mm
- Screed 65 mm
- Separating layer (e.g. 1 mm plastic sheet) 20 mm
- Impact sound insulation 200 mm
- Concrete slab over basement 10 mm
- Plaster to soffit 10 mm
- Total* 310 mm

### Wall construction, heated basement

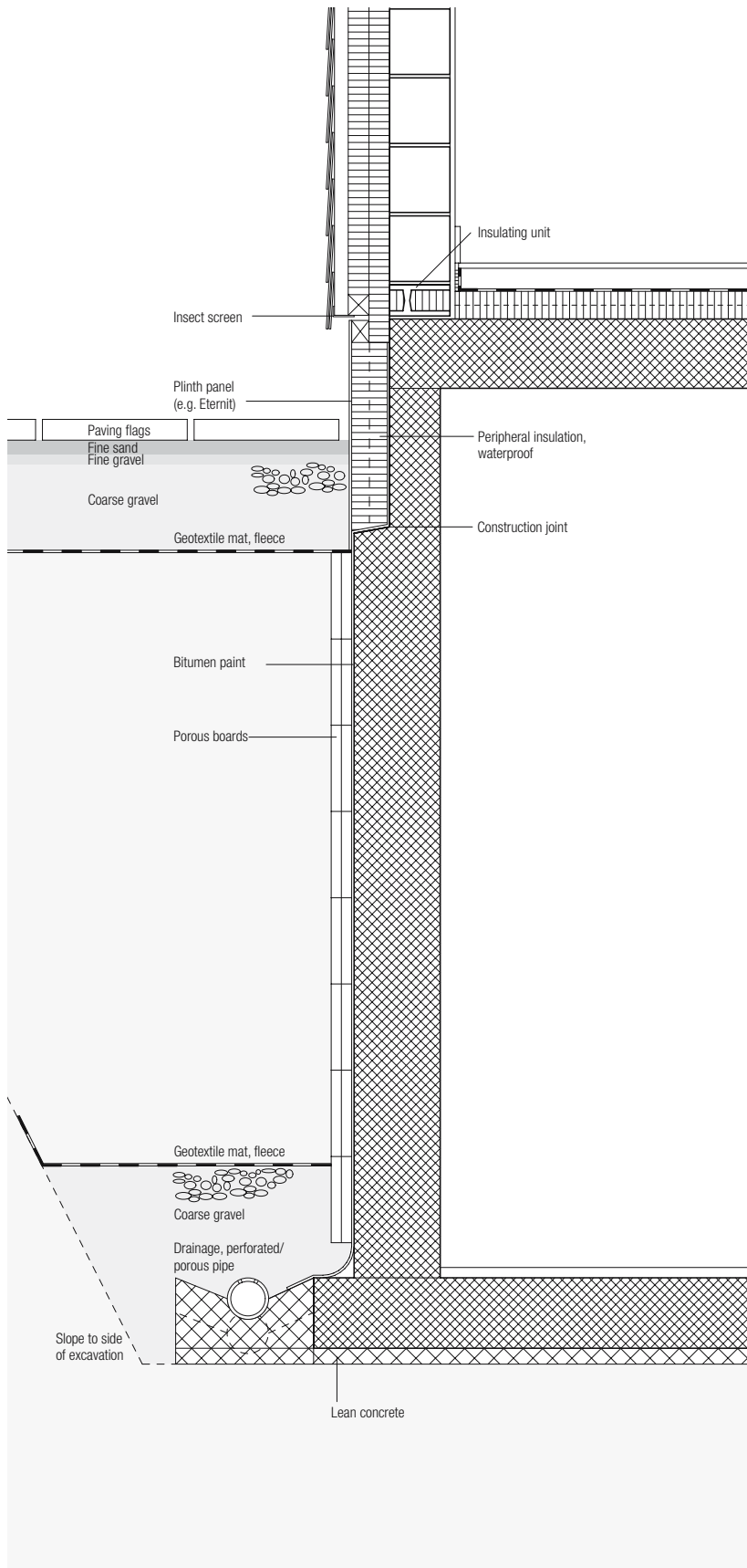
- Mortar coat (waterproof) 3 mm
- Peripheral insulation with drainage grooves 80 mm
- Waterproofing (e.g. bitumen paint) 2 mm
- In situ concrete wall 240 mm
- Plaster 10 mm
- Total* 335 mm

### Floor construction, heated basement

- Magnesite flooring 15 mm
- Screed 80 mm
- Separating layer (e.g. 1 mm plastic sheet) 80 mm
- Insulation (e.g. Floormate 200) 200 mm
- Damp-proof membrane (e.g. Robit) 50 mm
- Concrete ground slab 200 mm
- Lean concrete 50 mm
- Total* 425 mm

## Plinth, external cladding, lightweight

1:20



### Wall construction

- Cladding in medium and large format  
e.g. Eternit slates, rectangular double-lap  
arrangement, 300 x 600 mm 10 mm
- Ventilated cavity (40 x 70 mm vertical battens) 40 mm
- Thermal insulation, 2 layers each 60 mm,  
with 60 x 60 mm battens in both directions 120 mm
- Clay masonry, B, 29 x 17.5 x 19 cm 175 mm
- Plaster 15 mm
- Total 360 mm*

### Floor construction

- Ready-to-lay parquet flooring 15 mm
- Screed 60 mm
- Separating layer (e.g. 1 mm plastic sheet)
- Thermal insulation, vapourproof  
(e.g. expanded polystyrene) 80 mm
- Concrete slab over basement 200 mm
- Total 355 mm*

### Wall construction, unheated basement

- Porous boards 60 mm
- Waterproofing (e.g. bitumen paint) 3 mm
- In situ concrete wall 260 mm
- Total 323 mm*

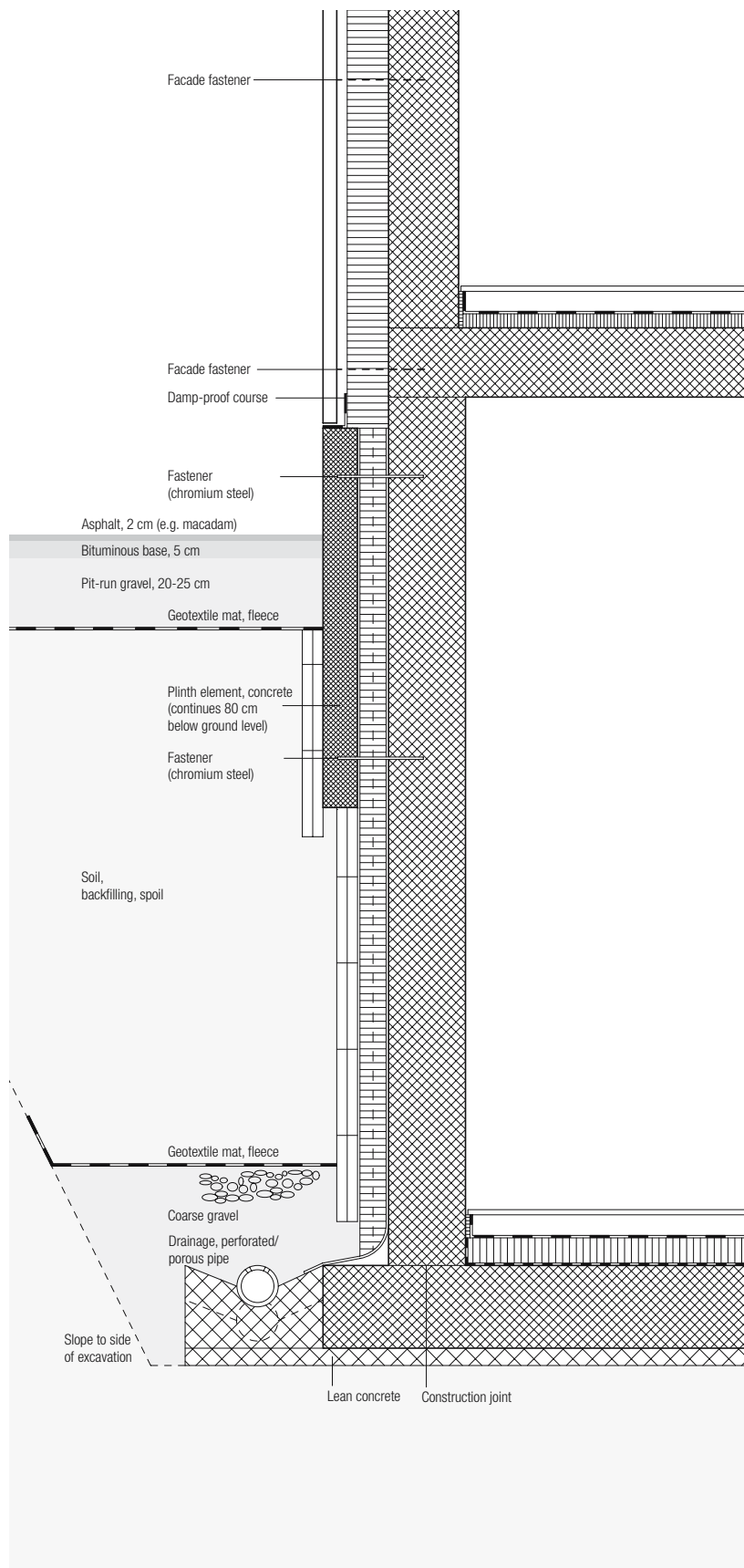
### Floor construction, unheated basement

- Screed 30 mm
- Concrete ground slab, roughened 200 mm
- Lean concrete 50 mm
- Total 280 mm*



## Plinth, external cladding, heavyweight

1:20



### Wall construction

- Stone slabs (e.g. slate)	20–40 mm
- Ventilated cavity	30 mm
- Thermal insulation	120 mm
- Fair-face concrete internally	200 mm
<i>Total</i>	<i>370–390 mm</i>

### Floor construction

- Ready-to-lay parquet flooring	15 mm
- Screed	80 mm
- Separating layer (e.g. 1 mm plastic sheet)	
- Impact sound insulation	40 mm
- Concrete slab over basement	200 mm
<i>Total</i>	<i>335 mm</i>

### Wall construction, heated basement

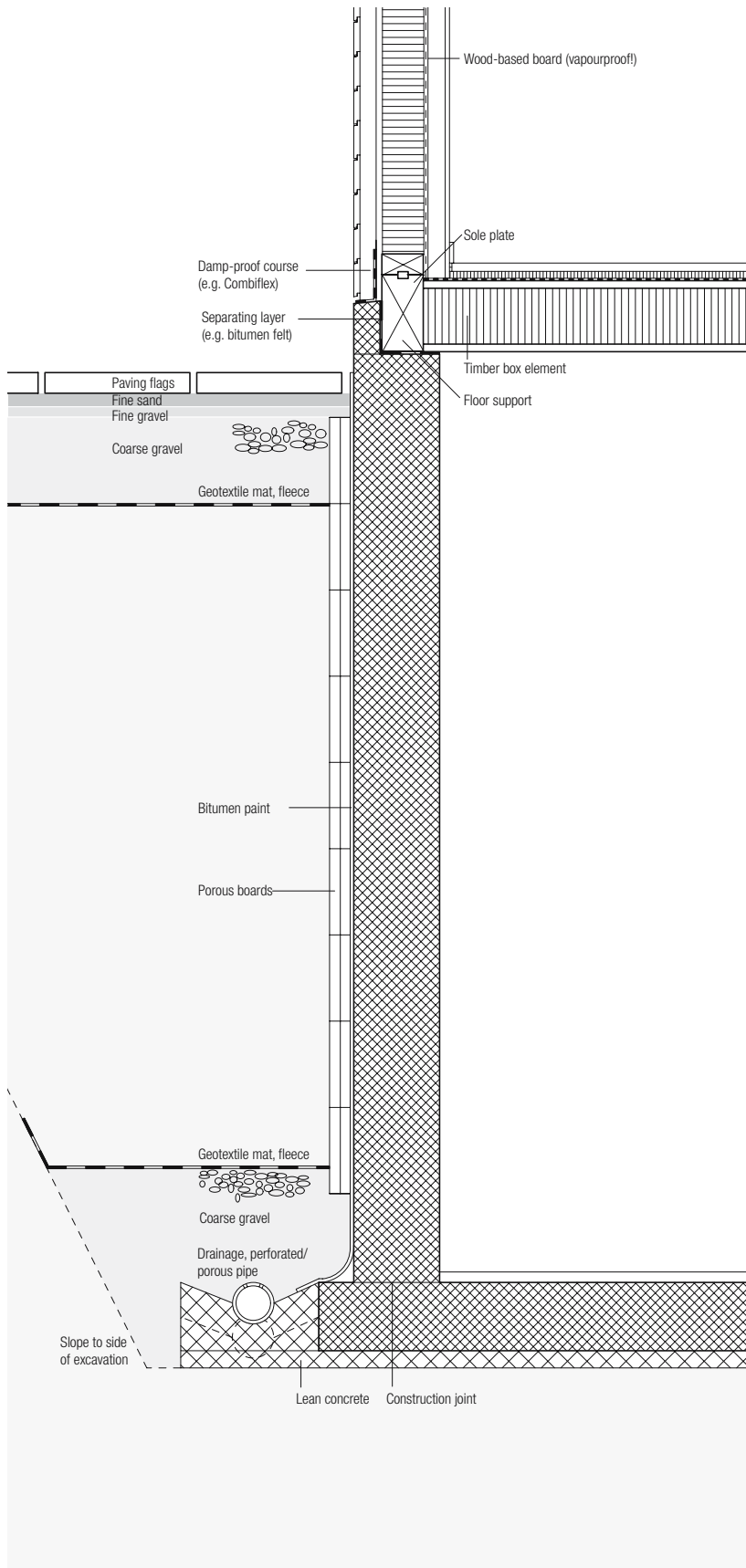
- Plinth element (precast concrete)	100 mm
- Peripheral insulation	80 mm
- Waterproofing (e.g. bitumen paint)	2 mm
- In situ concrete wall	220 mm
<i>Total</i>	<i>402 mm</i>

### Floor construction, heated basement

- Ready-to-lay parquet flooring	15 mm
- Screed	80 mm
- Separating layer (e.g. 1 mm plastic sheet)	
- Insulation (e.g. cellular glass)	80 mm
- Damp-proof membrane (e.g. Robit)	
- Concrete ground slab	240 mm
- Lean concrete	50 mm
<i>Total</i>	<i>465 mm</i>

## Plinth, timber platform frame construction

1:20

**Wall construction**

- Horizontal boards	24 mm
- Vertical battens (ventilated cavity)	40 mm
- Bitumen-impregnated softboard (airtight membrane)	18 mm
- Timber studding, insulation (e.g. Isofloc)	120 mm
- Wood-based board (plywood, vapourproof!)	12 mm
- Vertical battens (space for services)	50 mm
- Wood-cement particleboard (e.g. Fermacell) or fibre-reinforced plasterboard (e.g. SasmoX)	12 mm
<b>Total</b>	<b>276 mm</b>

**Floor construction**

- 3-ply core plywood, floating, tongue and groove	27 mm
- Impact sound insulation	20 mm
- Vapour barrier	
- Lignatur timber box element, soffit left exposed	220 mm
<b>Total</b>	<b>267 mm</b>

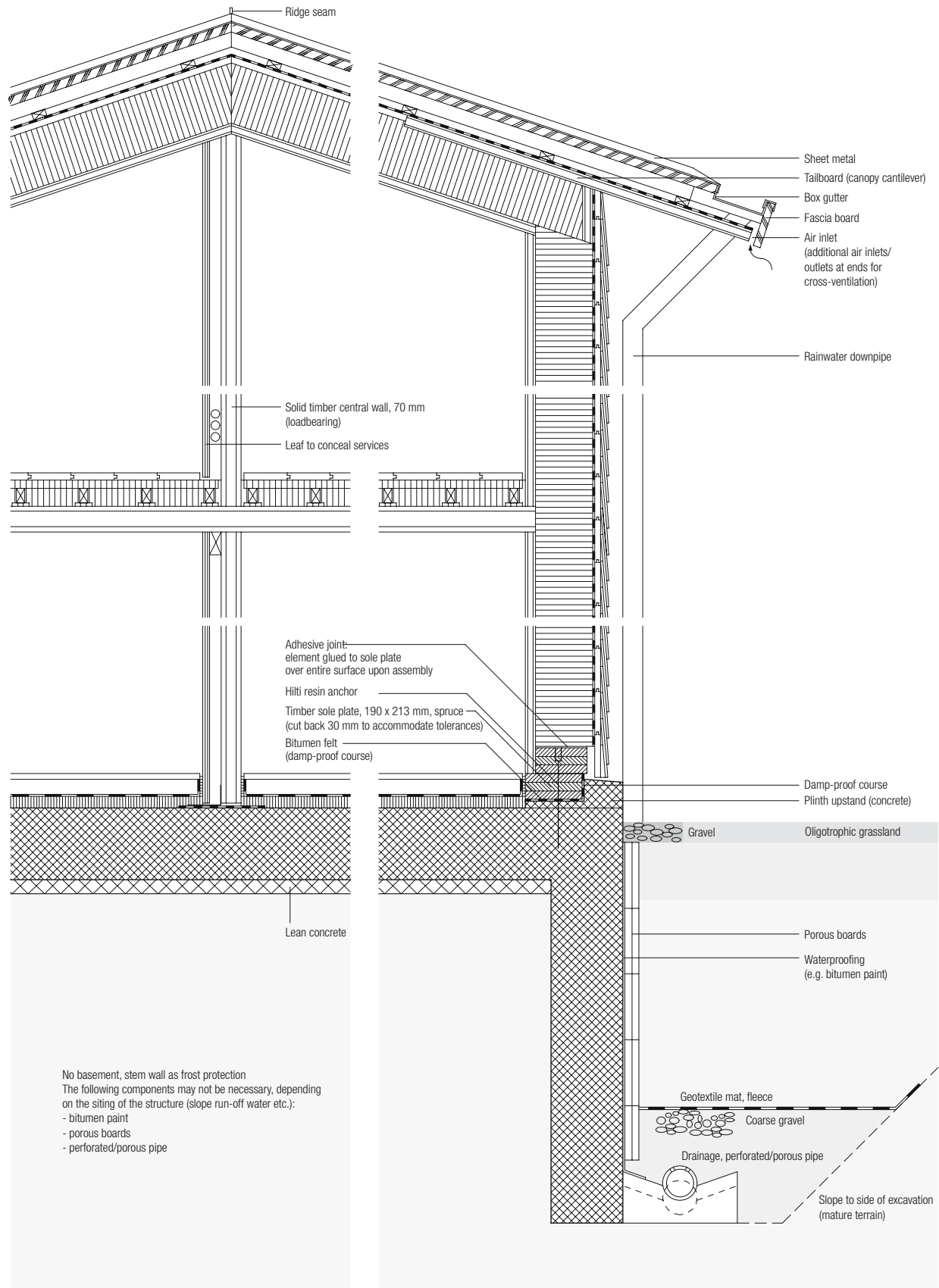
**Wall construction, unheated basement**

- Porous boards	60 mm
- Waterproofing (e.g. bitumen paint)	2 mm
- In situ concrete wall	240 mm
<b>Total</b>	<b>302 mm</b>

**Floor construction, unheated basement**

- Screed	30 mm
- Concrete ground slab	200 mm
- Lean concrete	50 mm
<b>Total</b>	<b>280 mm</b>

**Plinth – Roof: solid timber panel construction**  
1:20





Figs 1 and 2: Solid timber panel construction, completed with shingle cladding (top); erecting the panels (bottom)

Bearth & Deplazes: private house (Bearth-Candinas), Sumvitg (CH), 1998

#### Roof construction

- Sheet metal	0.6 mm
- Roof decking	30 mm
- Counter battens 50 x 80 mm (ventilated cavity)	80 mm
- Timber blocks for cross-ventilation, 30 x 50 mm	30 mm
- Secondary waterproofing/covering layer	3 mm
- Softboard	22 mm
- Solid timber ribs, 40 x 200 mm, with thermal insulation in between	200 mm
- Solid timber panel	35 mm
<i>Total</i>	<i>400 mm</i>

#### Floor construction, upper floors

- Solid timber floorboards (tongue and groove, concealed nailing)	24 mm
- Counter battens, 40 x 30 mm (with insulation in between)	30 mm
- Battens, 50 x 30 mm (with insulation in between)	50 mm
- Rubber strips as separating layer beneath battens (for impact sound insulation)	10 mm
- Solid timber panel (span: 3 m)	90 mm
<i>Total</i>	<i>204 mm</i>

#### Wall construction

- Larch shingles (without ventilated cavity), 3 layers	20 mm
- Spruce boards (tongue and groove), horizontal	20 mm
- Airtight membrane	
- Thermal insulation (around transverse ribs)	200 mm
- Solid timber panel (loadbearing, incl. vapour check function due to adhesive)	35 mm
<i>Total</i>	<i>275 mm</i>

#### Floor construction, ground floor

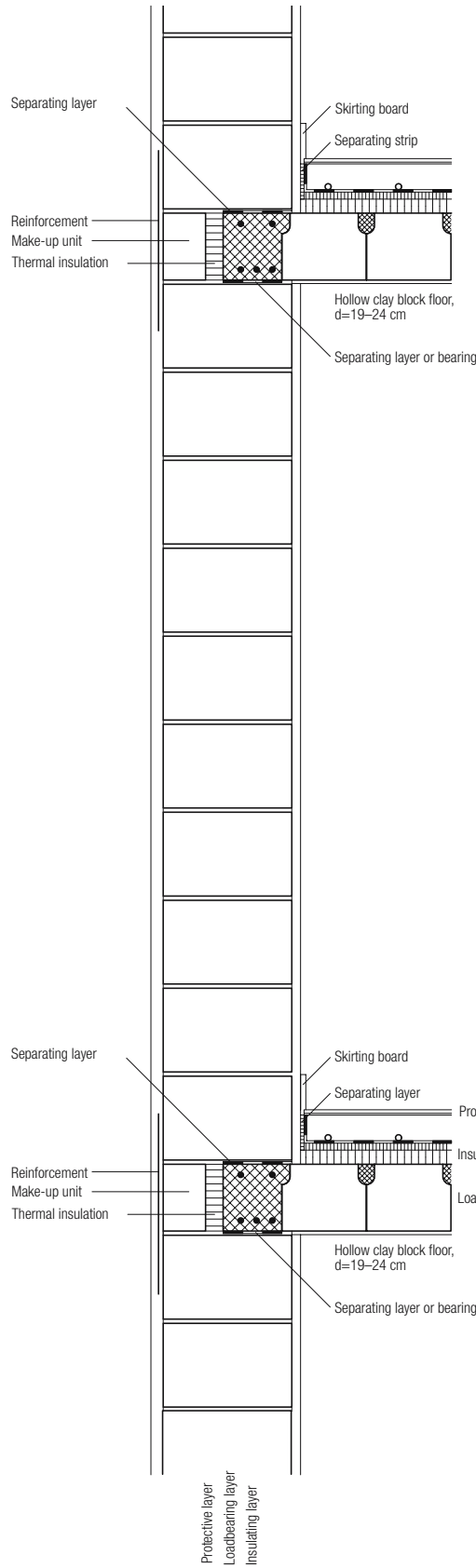
- Hard-fired floor tiles	30 mm
- Screed (with underfloor heating)	60 mm
- Separating layer (fleece)	2 mm
- Impact sound insulation	40 mm
- Reinforced concrete	250 mm
- Lean concrete	50 mm
<i>Total</i>	<i>432 mm</i>

*Example:*

*Bearth & Deplazes: private house (Bearth-Candinas), Sumvitg (CH), 1998*



**Single-leaf masonry, rendered**  
1:20



Section

**Wall construction**

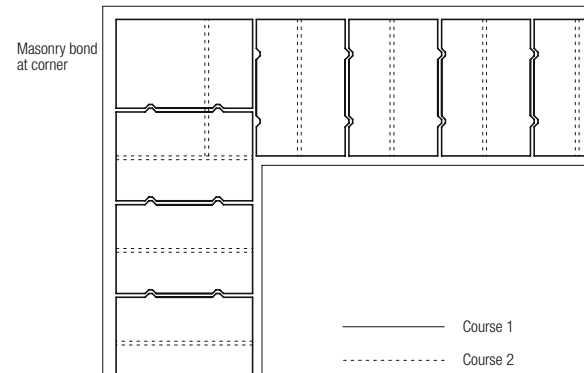
- Render	35 mm
- Single-leaf masonry, 36.5 x 24.8 x 23.8 cm	365 mm
- Plaster	25 mm
<b>Total</b>	<b>425 mm</b>

**Floor construction**

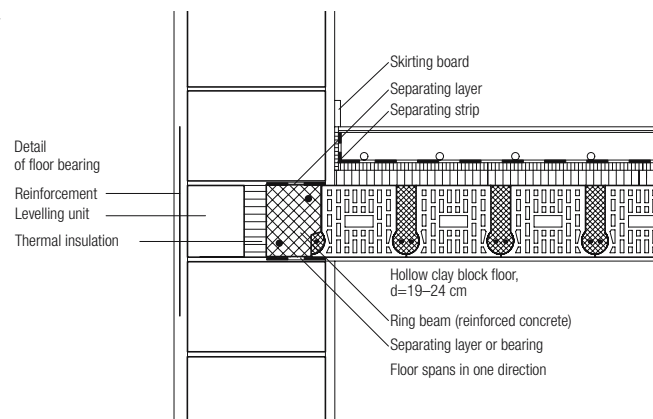
- Hard-fired floor tiles	10 mm
- Tile adhesive	5 mm
- Screed (floating) with underfloor heating	80 mm
- Separating layer (e.g. 1 mm plastic sheet)	
- Impact sound insulation	20 mm
- Thermal insulation	40 mm
- Hollow clay block floor with ring beam (1-way span)	195 mm
- Plaster to soffit	10 mm
<b>Total</b>	<b>360 mm</b>

Example:

*Giuliani & Hönger and Doetsch & Roth:  
Kupper apartment block, Erlenbach (CH), 1993–1996*

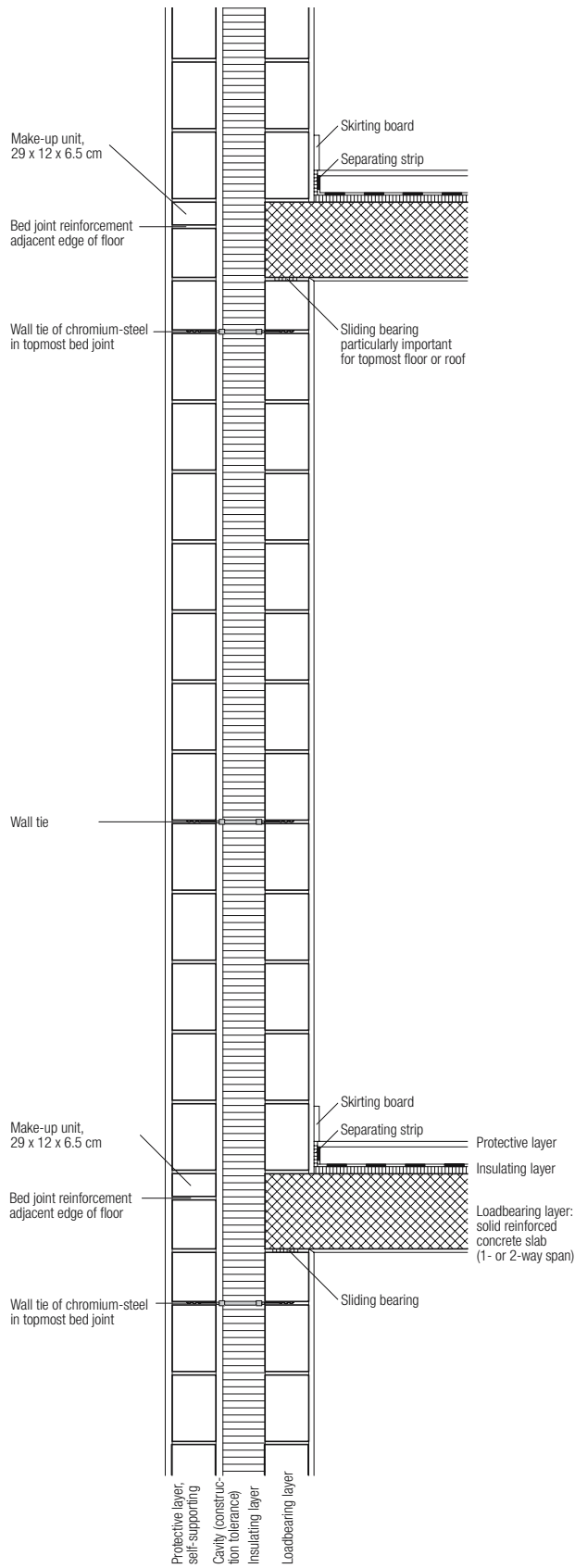


Plan



Longitudinal section

**Double-leaf masonry, rendered**  
1:20



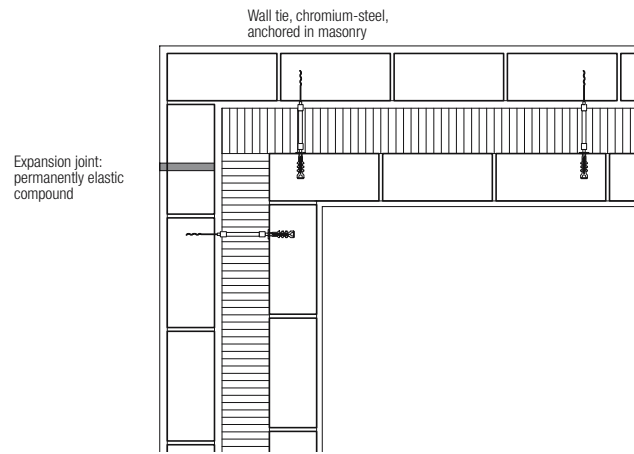
Section

**Wall construction**

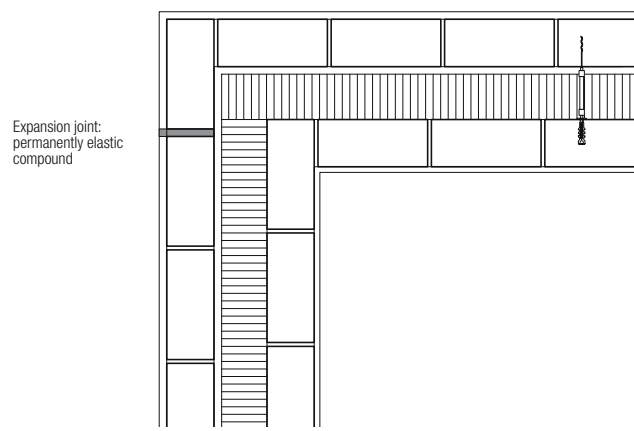
- Render	20 mm
- Clay masonry, BN, 29 x 12.5 x 19 cm	125 mm
- Ventilated cavity (construction tolerance)	20 mm
- Thermal insulation (e.g. rockwool)	120 mm
- Clay masonry, BN, 29 x 12.5 x 19 cm	125 mm
- Plaster	15 mm
<b>Total</b>	<b>425 mm</b>

**Floor construction**

- Ready-to-lay parquet flooring	15 mm
- Screed, floating	60 mm
- Separating layer (e.g. 1 mm plastic sheet)	
- Impact sound insulation	20 mm
- Concrete slab (depth according to structural analysis, 1- or 2-way span)	210 mm
- Plaster to soffit	10 mm
<b>Total</b>	<b>315 mm</b>

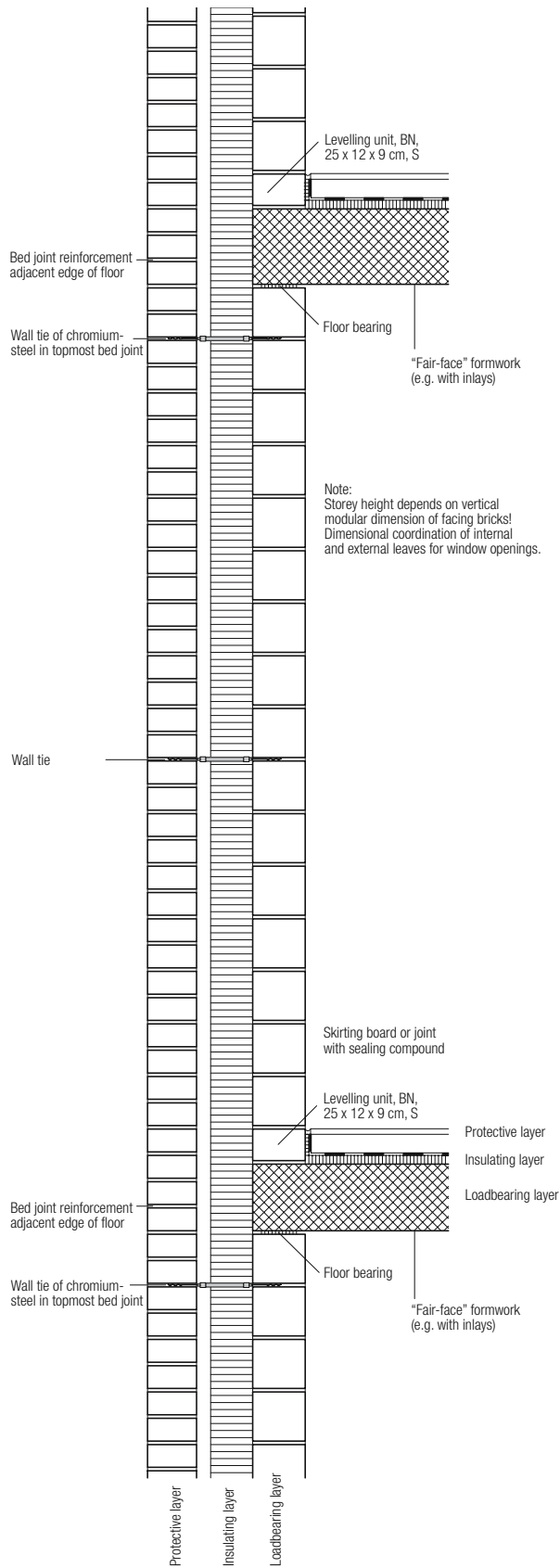


Plan, course 1



Plan, course 2

**Facing masonry**  
1:20



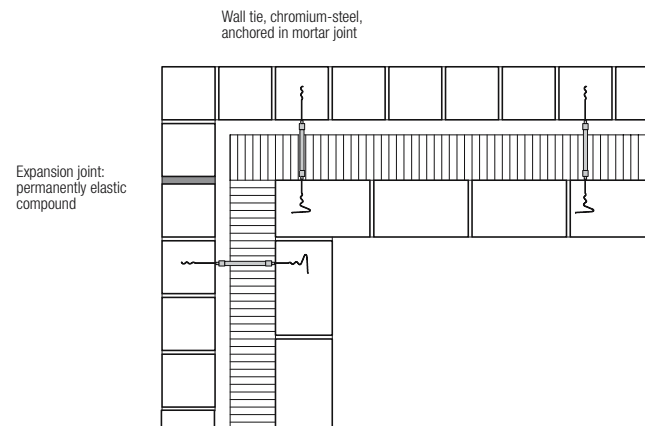
Section

**Wall construction**

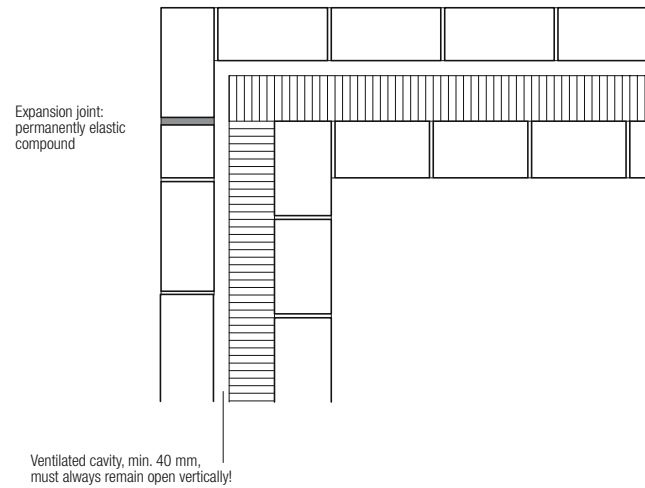
- Clay masonry, BS, course 1, 29 x 14 x 6.5 cm
- Clay masonry, BS, course 2, 14 x 14 x 6.5 cm
- 140 mm
- (Variations: diverse facing masonry modules, prefabricated concrete bricks or elements, etc.)
- Ventilated cavity, min. 40 mm
- Thermal insulation (e.g. rockwool) 120 mm
- Clay masonry, BS, 25 x 15 x 14 cm 150 mm
- Total** 450 mm

**Floor construction**

- Ready-to-lay parquet flooring 15 mm
- Screed, floating 60 mm
- Separating layer (e.g. 1 mm plastic sheet)
- Impact sound insulation 20 mm
- Fair-face concrete slab 200 mm
- Total** 295 mm



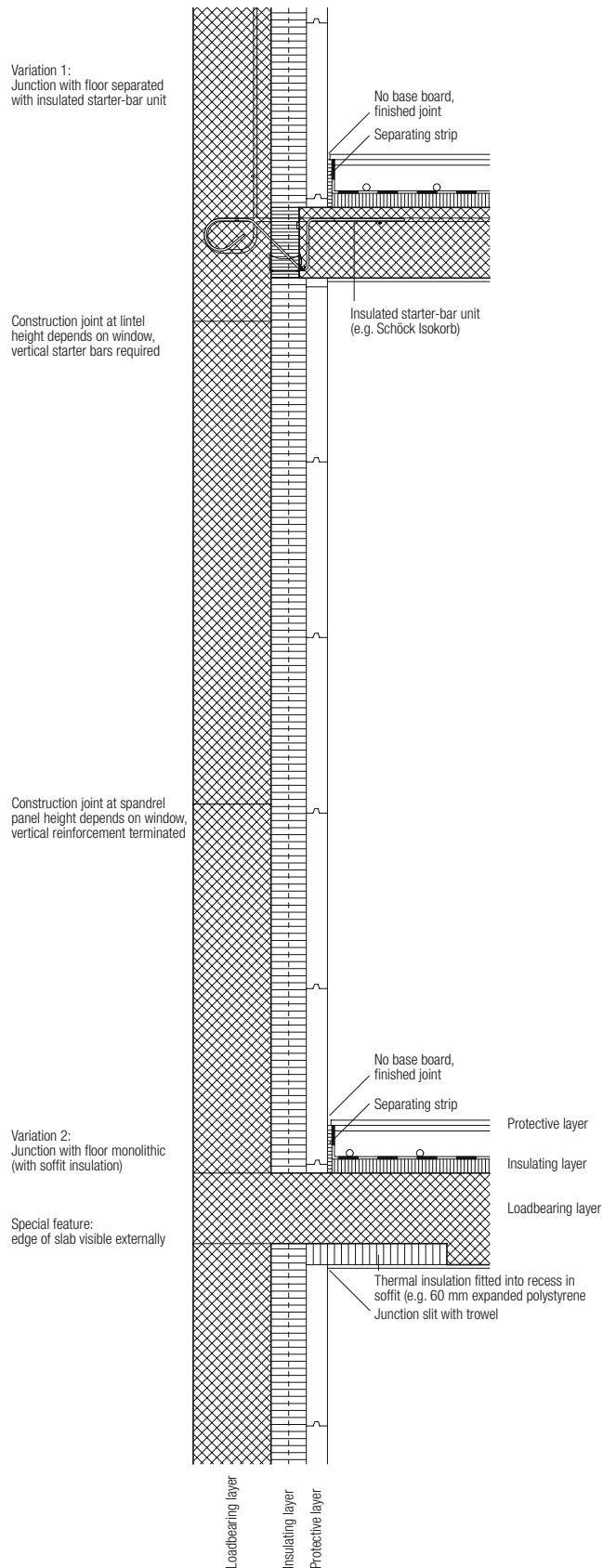
Plan, course 1



Plan, course 2

## Fair-face concrete with internal insulation

1:20



Section

## Wall construction

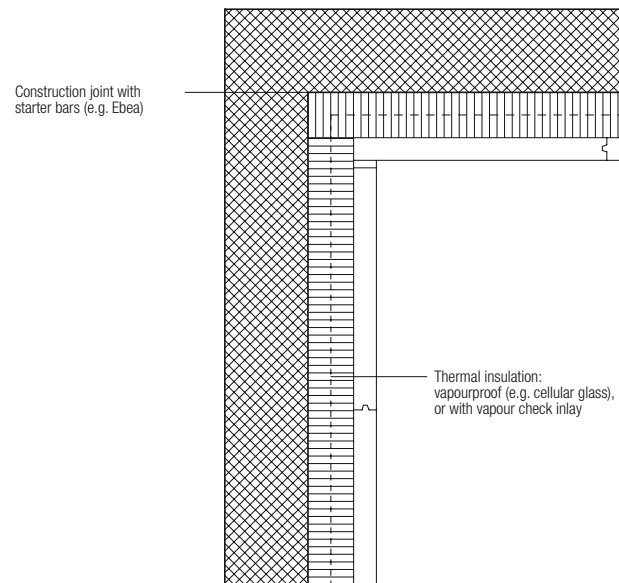
- Fair-face concrete, coloured	220 mm
- Thermal insulation, vapourproof (e.g. cellular glass)	100 mm
- Gypsum boards, plaster skim/paint finish	60 mm
<i>Total</i>	<i>380 mm</i>

## Floor construction

- Stone flags	15 mm
- Mortar bed	15 mm
- Screed with underfloor heating (floating)	80 mm
- Separating layer (1 mm plastic sheet)	
- Impact sound insulation	40 mm
- Concrete slab	200 mm
- Plaster to soffit	10 mm
<i>Total</i>	<i>360 mm</i>

## Example:

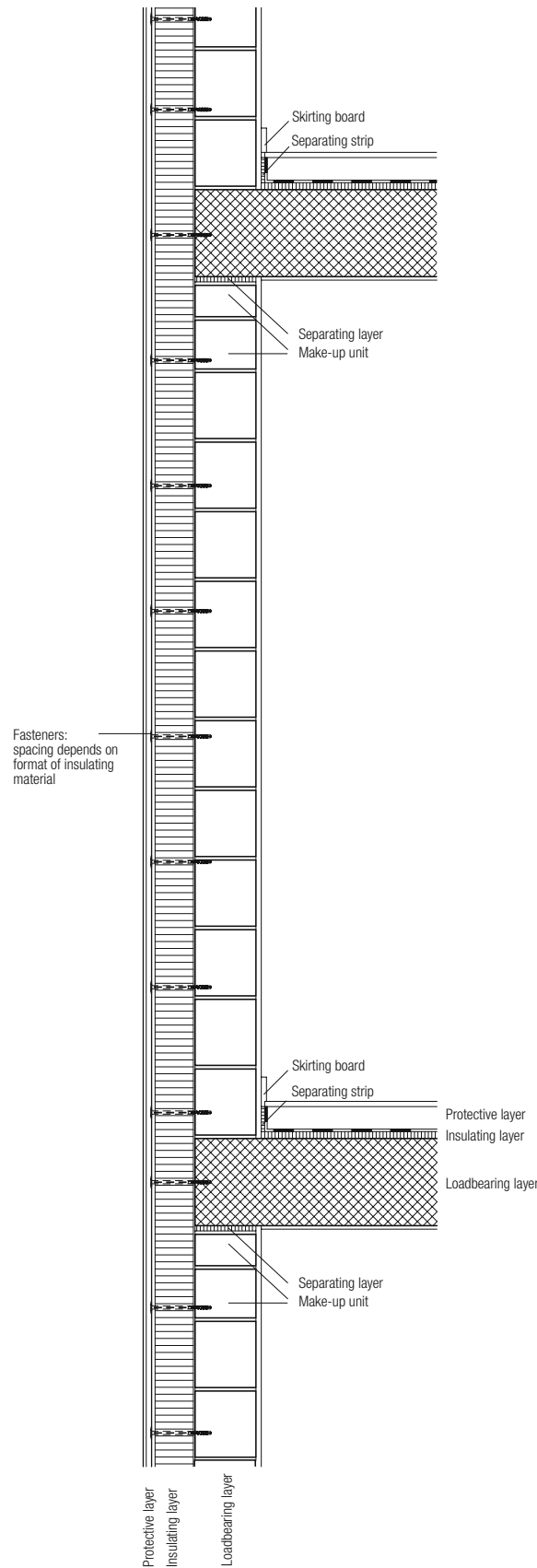
*Diener & Diener: Steinenvorstadt mixed residential and  
commercial development, Basel (CH), 1995*



Plan



**External insulation, rendered**  
1:20



**Section**

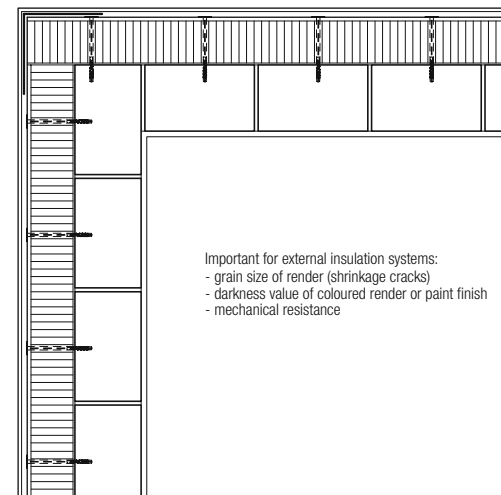
**Wall construction**

- e.g. Wancor-Therm K
- Mineral render finish coat (coloured or painted) 2 mm
- Bonding render (with glass mat inlay over entire surface) 4 mm
- Mineral render undercoat 20 mm
- Insulation board 5-110-10 (3-layer board), fixed with plastic fasteners 125 mm
- Clay masonry, B, 29 x 17.5 x 19 cm 175 mm
- Plaster 15 mm
- Total 341 mm*

**Floor construction**

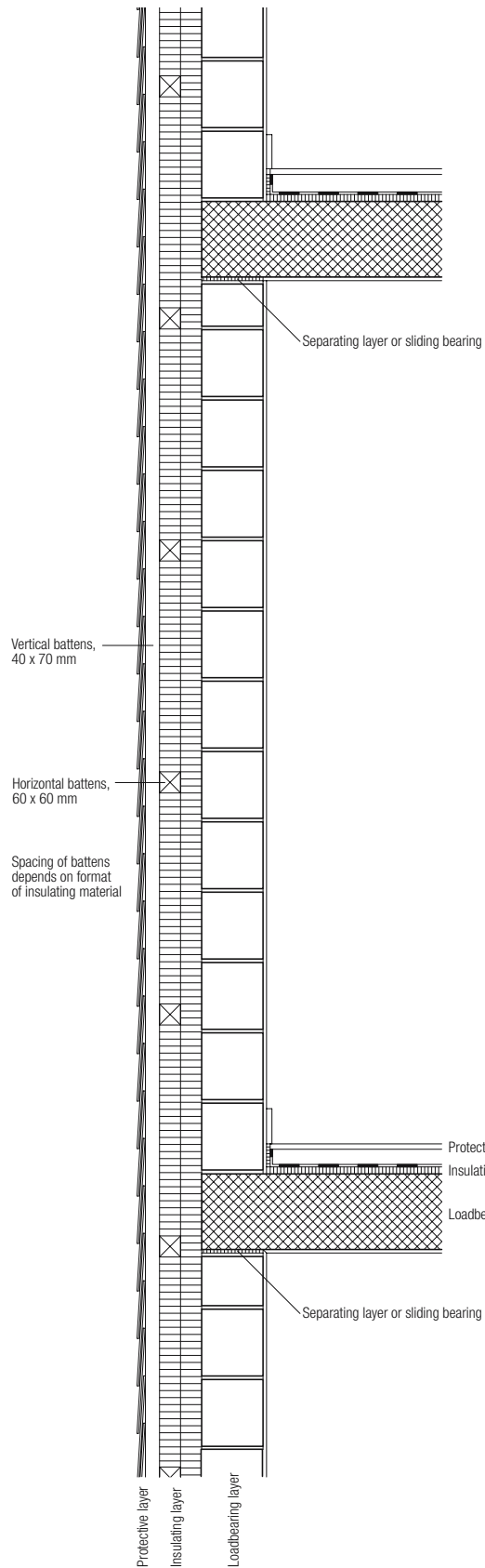
- Magnesite flooring (seamless) 15 mm
- Screed 65 mm
- Separating layer (e.g. 1 mm plastic sheet) 20 mm
- Impact sound insulation 200 mm
- Concrete slab 200 mm
- Plaster to soffit 10 mm
- Total 310 mm*

Mesh embedded to protect corner



**Plan**

**External cladding, lightweight**  
1:20



**Wall construction**

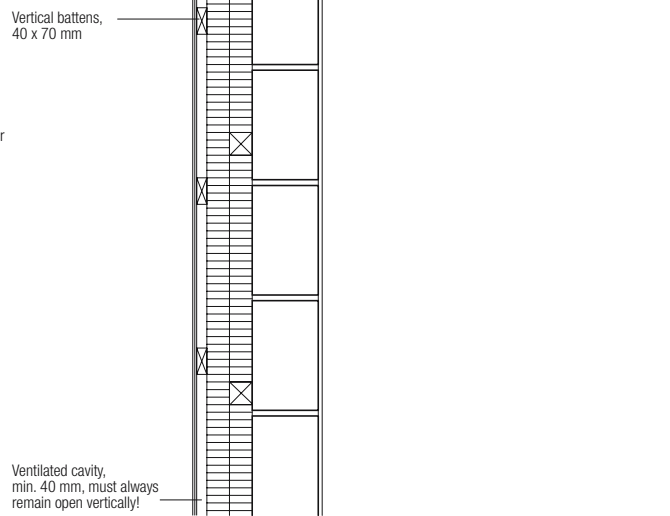
- Cladding in medium and large format  
e.g. Eternit slates, rectangular double-lap arrangement, 300 x 600 x 5 mm 10 mm
- Variations:*  
*timber weatherboarding, 24 mm*  
*panels, e.g. sheet metal, Eternit, timber*
- Ventilated cavity, (40 x 70 mm vertical battens) 40 mm
- Variations for small formats:*  
*slates, Eternit triple-lap arrangement*  
*clay, ceramics,*  
*horizontal battens, 30 x 50 mm*
- Thermal insulation, 2 layers each 60 mm  
on grid of 60 x 60 mm battens 120 mm
- Clay masonry, B, 29 x 17.5 x 19 cm 175 mm
- Plaster 15 mm
- Total* 360 mm

**Floor construction**

- Ready-to-lay parquet flooring 15 mm
- Screed 60 mm
- Separating layer (e.g. 1 mm plastic sheet)
- Impact sound insulation 20 mm
- Concrete slab 200 mm
- Total* 295 mm

Note: The battens (vertical, optional additional horizontal battens, so-called counter battens) depend on the cladding format.

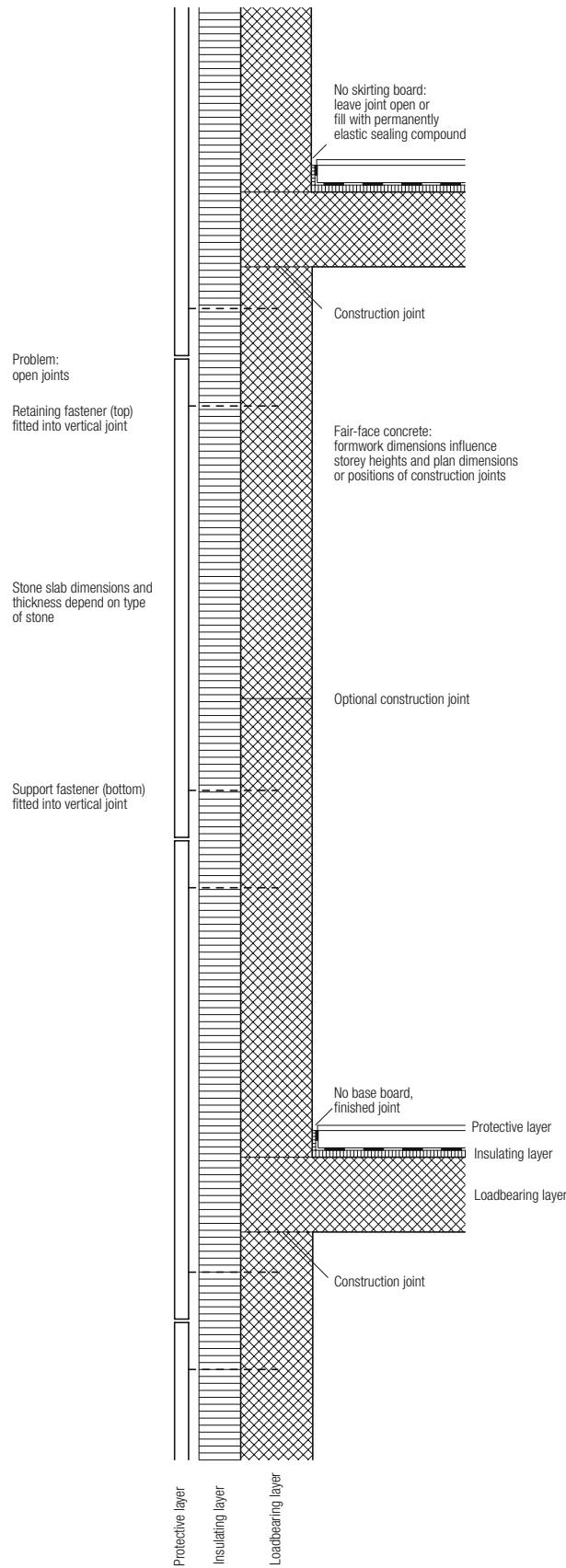
Please note:  
Cladding corner detail  
(diverse options)



Section

Plan

**External cladding, heavyweight**  
1:20



Section

**Wall construction**

- Stone slabs (e.g. slate)	20-40 mm
- Ventilated cavity	30 mm
- Thermal insulation	120 mm
- Fair-face concrete internally	200 mm
<b>Total</b>	<b>390 mm</b>

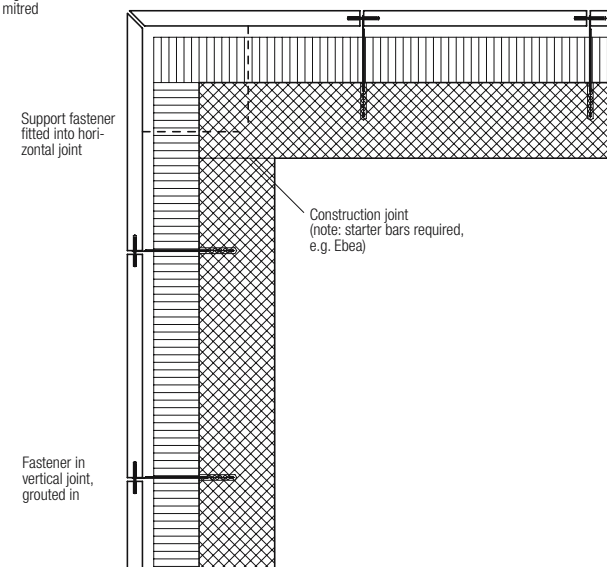
**Floor construction**

- Ready-to-lay parquet flooring	15 mm
- Screed	60 mm
- Separating layer (e.g. 1 mm plastic sheet)	
- Impact sound insulation	20 mm
- Concrete slab	200 mm
<b>Total</b>	<b>295 mm</b>

Important for non-self-supporting external cladding:  
- fixed with retaining and support fasteners

Important for self-supporting external cladding:  
- fixed for stability  
(Reference example: private house "In den Lachen" [architects: Beath & Deplazes], Chur; precast fair-face concrete facade elements)

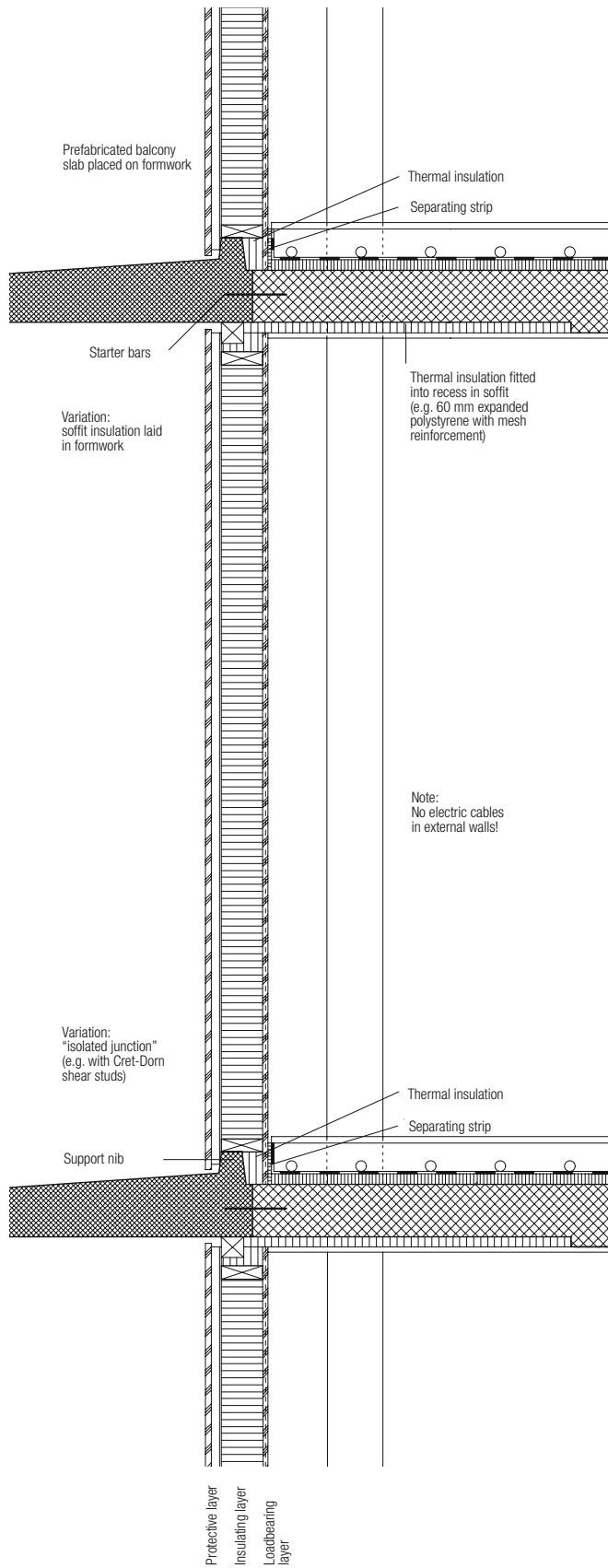
Corner detail, e.g. stone slabs mitred



Plan

### Non-loadbearing external wall

1:20



#### Wall construction (timber box-frame construction)

- Wood-cement particleboard (e.g. Duripanel, for painting)	20 mm
- Ventilated cavity	25 mm
- Hardboard	8 mm
- Thermal insulation (cellulose wool, e.g. Isofloc)	120 mm
- Plywood (vapour check)	15 mm
<b>Total</b>	<b>188 mm</b>

#### Floor construction

- Ready-to-lay parquet flooring	20 mm
- Screed (with underfloor heating)	80 mm
- Separating layer (e.g. 1 mm plastic sheet)	
- Impact sound insulation	30 mm
- Concrete slab	180 mm
- Thermal insulation (e.g. expanded polystyrene)	30 mm
- Plaster to soffit	10 mm
<b>Total</b>	<b>350 mm</b>

Example:  
Morger & Degelo: Müllheimer-Strasse residential development, Basel (CH), 1993

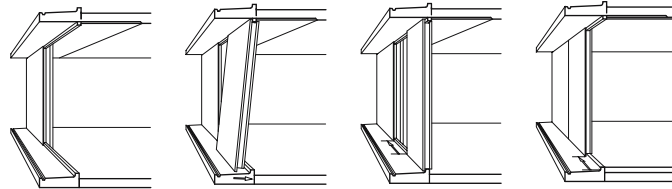
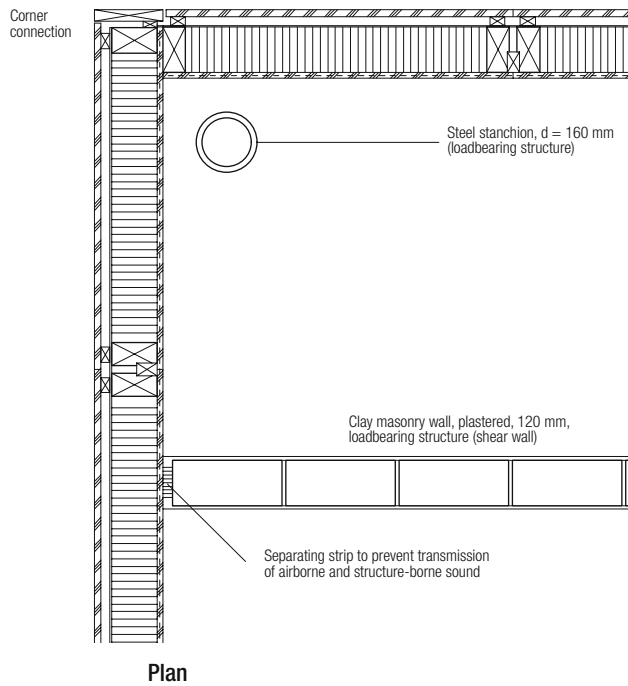
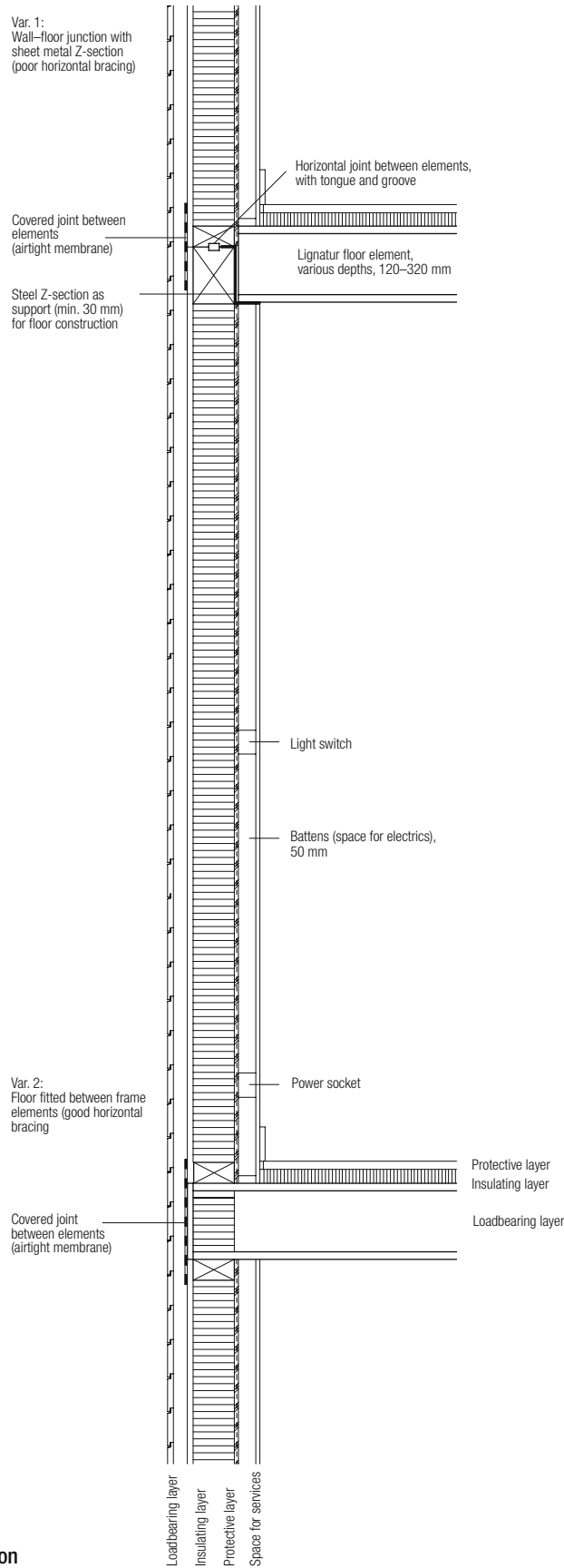


Fig. 1: Erection and fixing of a facade element





### Timber platform frame construction 1:20



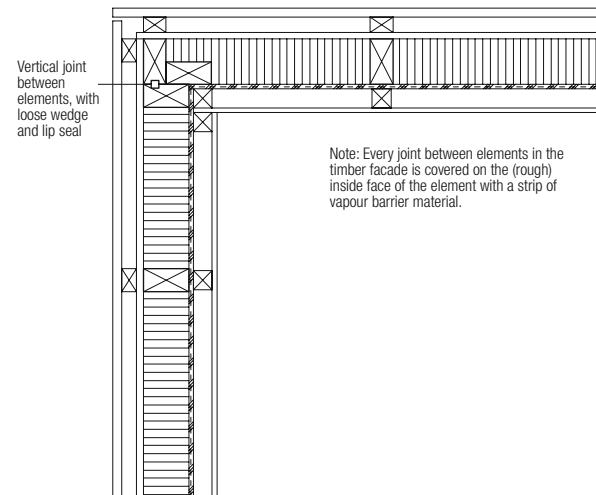
Section

#### Wall construction

- Horizontal boards	24 mm
- Vertical battens (ventilated cavity)	40 mm
- Bitumen-impregnated softboard (airtight membrane)	18 mm
- Timber studding, insulation (cellulose wool, e.g. Isofloc)	120 mm
- Wood-based board (plywood, vapourproof)	12 mm
- Vertical battens (space for services)	50 mm
- Wood-cement particleboard or fibre-reinforced plasterboard	12 mm
<b>Total</b>	<b>276 mm</b>

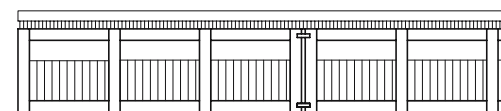
#### Floor construction

- 3-ply core plywood, floating, with tongue and groove	27 mm
- Impact sound insulation	40 mm
- Lignatur timber box element, soffit left exposed	220 mm
<b>Total</b>	<b>287 mm</b>



Plan

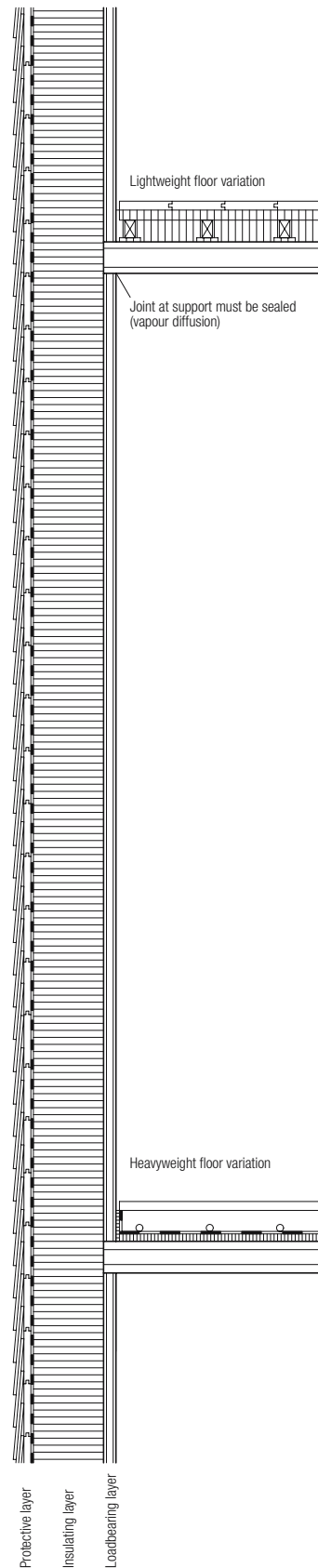
Lignatur element, 100 cm wide, insulated or uninsulated, depth depends on span



Schematic section

## Solid timber panel construction

1:20



Section

**Wall construction**

- Larch shingles (without ventilated cavity), double-lap arrangement 20 mm
- Spruce boards (tongue and groove), horizontal 20 mm
- Airtight membrane
- Thermal insulation (around the transverse ribs) 200 mm
- Solid timber panel (loadbearing, incl. vapour check function due to adhesive) 35 mm
- Total* 275 mm

**Floor construction, "lightweight"**

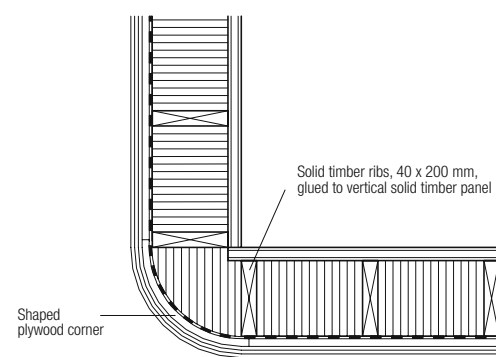
- Solid timber floorboards (tongue and groove, concealed nailing) 24 mm
- Counter battens, 40 x 30 mm (with insulation between) 30 mm
- Battens, 50 x 30 mm (with insulation in between) 50 mm
- Rubber strips as separating layer beneath battens (for impact sound insulation) 10 mm
- Solid timber panel (span: 3 m) 90 mm
- Total* 204 mm

**Floor construction, "heavyweight"**

- Hard-fired floor tiles 30 mm
- Screed (with underfloor heating) 60 mm
- Separating layer (fleece) 2 mm
- Impact sound insulation 40 mm
- Solid timber panel (span: 3 m) 90 mm
- Total* 222 mm

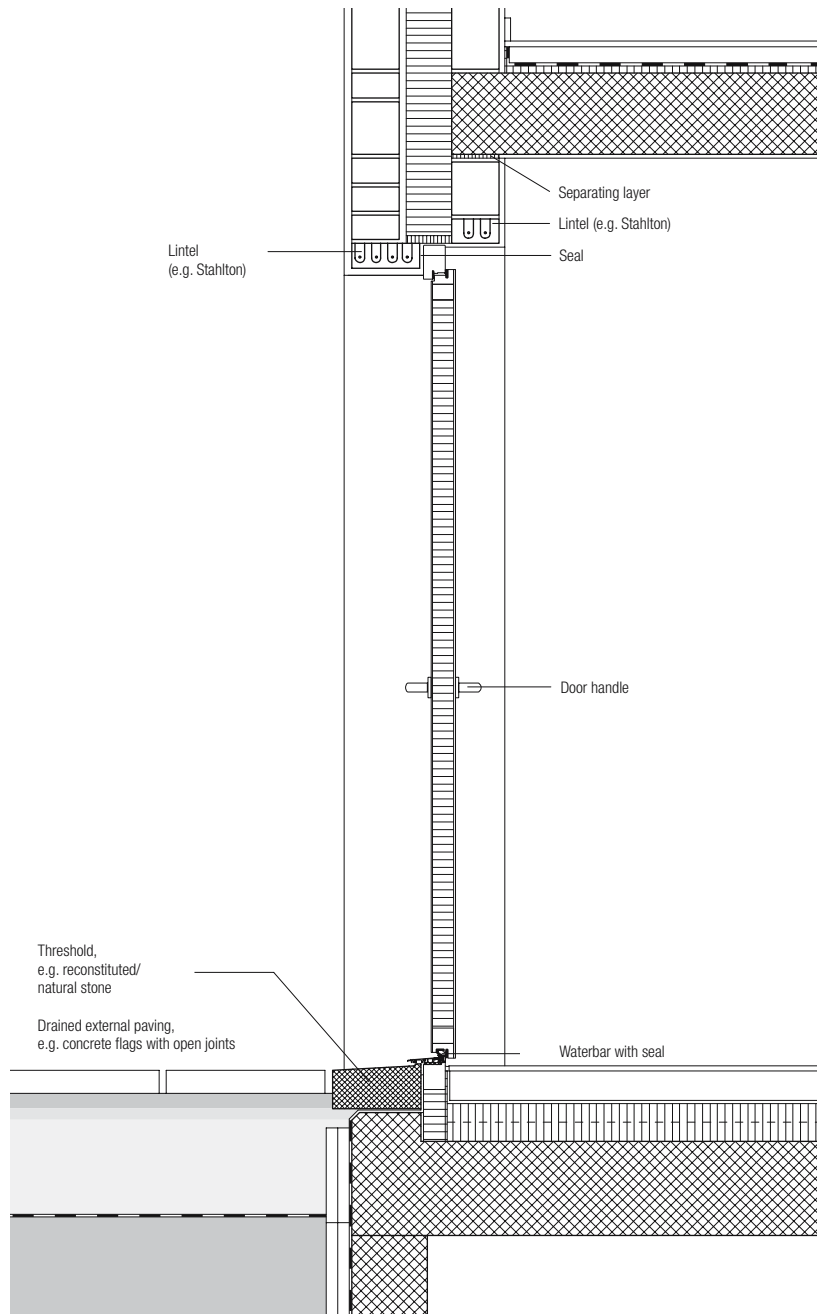
*Example:*

*Bearth & Deplazes: private house (Bearth-Candinas), Sumvitg (CH), 1998*

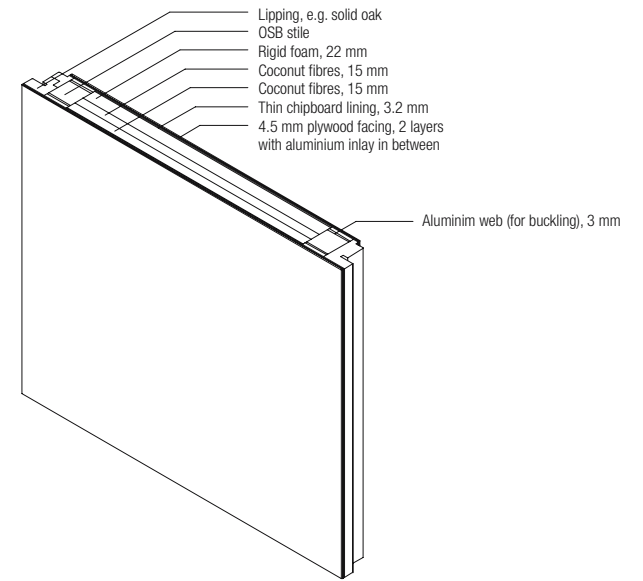


Plan

**Hinged door, external – wood**  
1:20

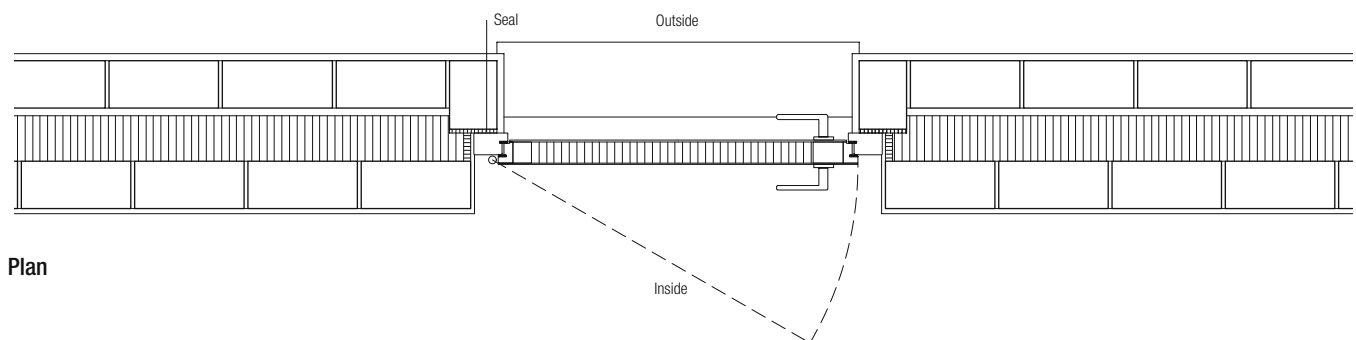


Entrance door with frame, double-leaf masonry, rendered hinges on left, opening inwards rebated leaf, including thermal and sound insulation frame and leaf designed for fire resistance class T 30



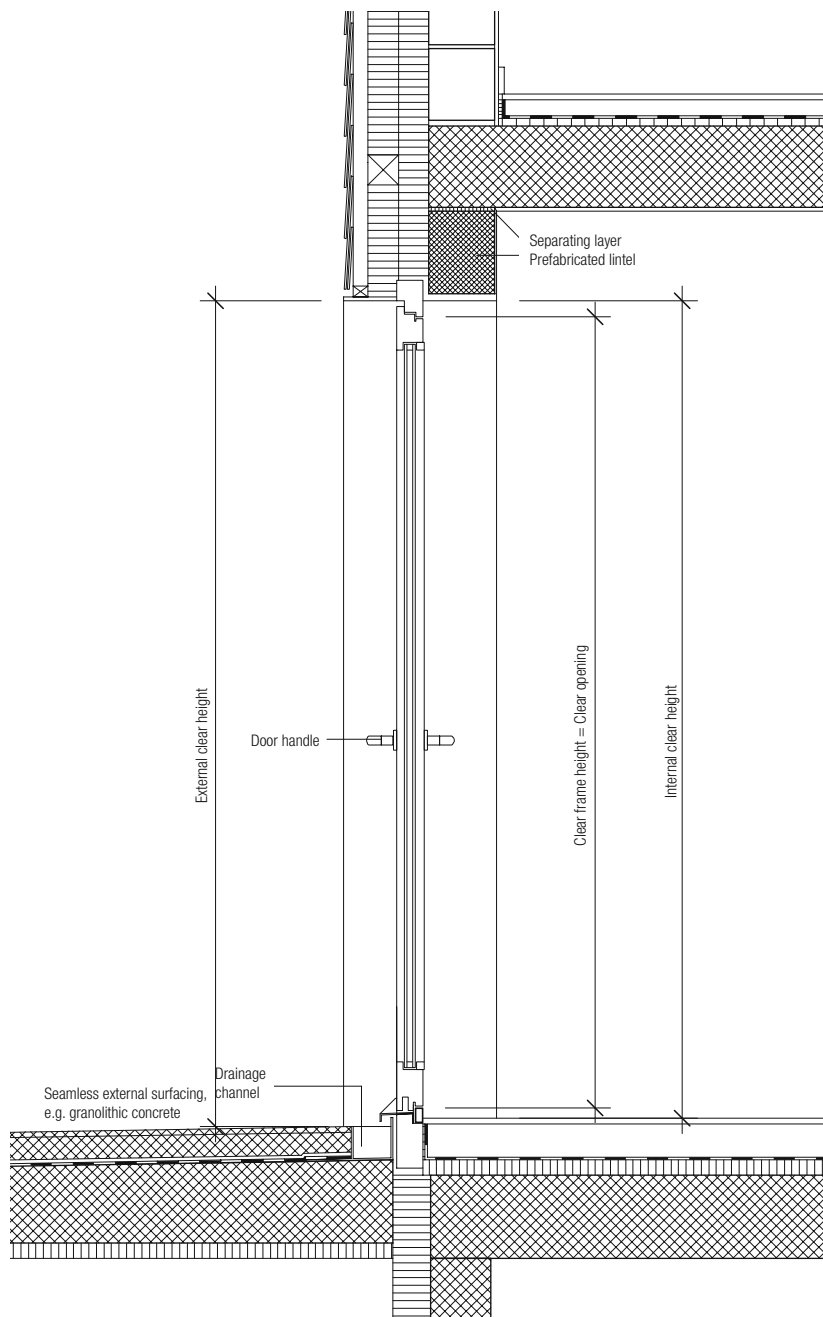
Leaf construction: Riwag-Isotherm 65 mm  
Facing for painting or with various wood veneer finishes

Section



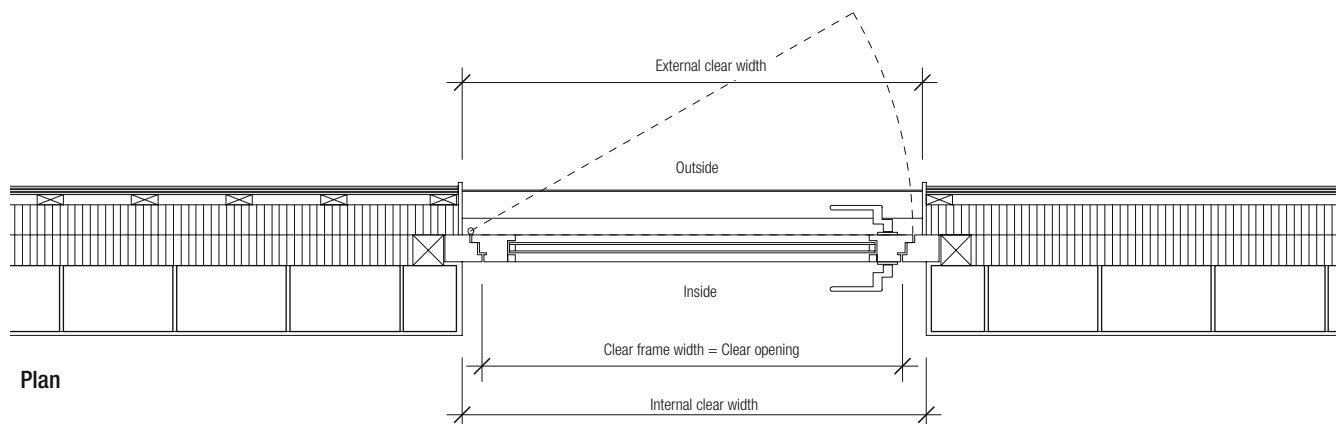
Plan

**Hinged door, external – wood/glass**  
1:20



Entrance door  
with frame, external cladding, lightweight  
hinges on right, opening outwards  
glazed leaf, rebated, fits flush with frame

**Section**

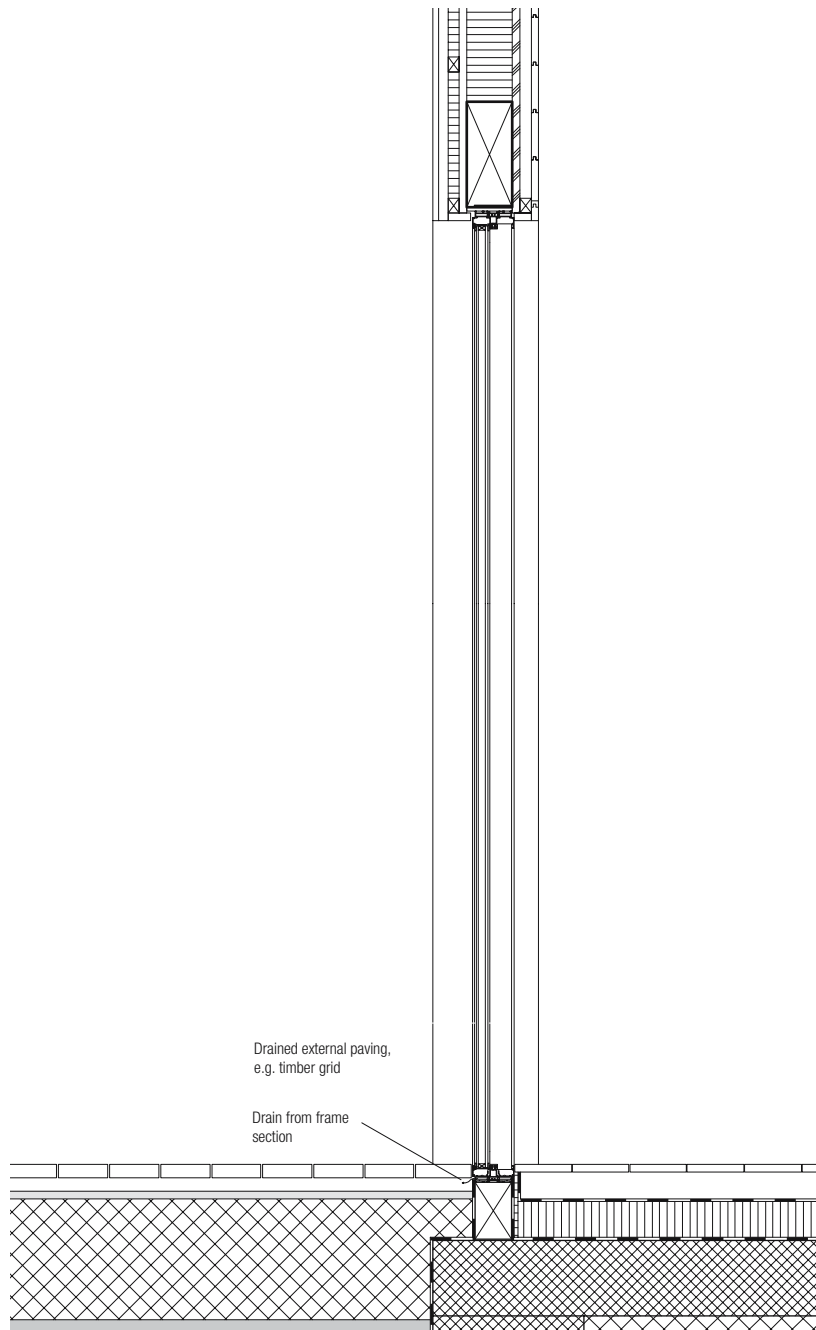


**Plan**

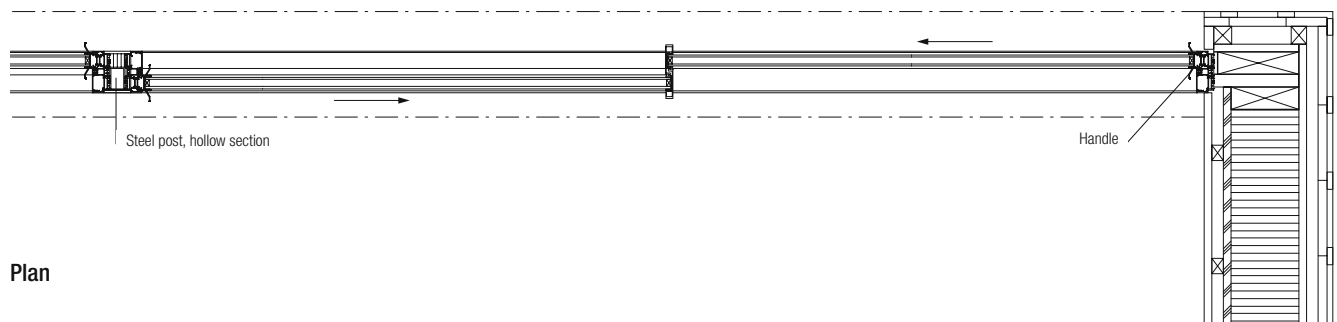


## Sliding door, external – metal/glass

1:20



Section



Plan

Glazed patio door  
 Special design, brand: "sky-frame"  
 Double sliding aluminium door with thermal break

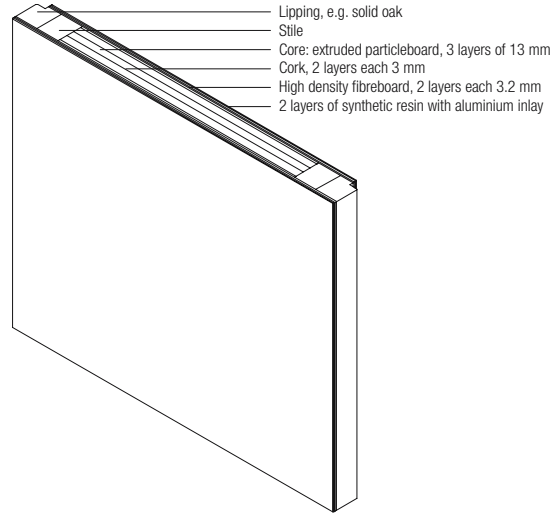
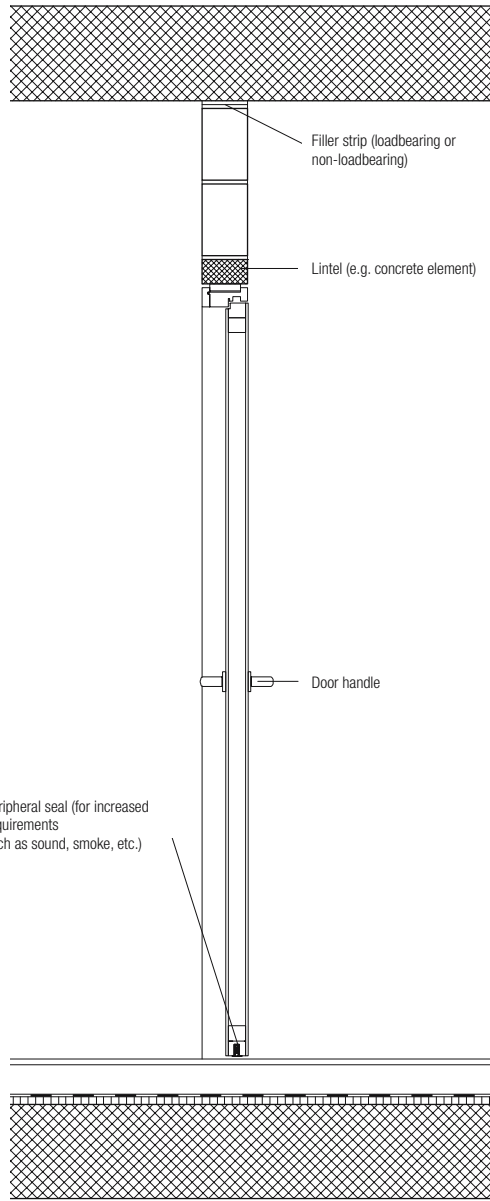
Glass elements attached to aluminium frame fitted into threshold, jambs and head. The sliding elements run on ball-bearing trolleys with little rolling resistance.



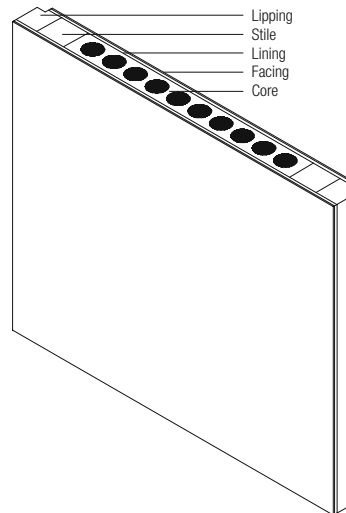
Fig. 1: Peter Kunz: private house, Winterthur (CH), 2003

**Hinged door, internal – wood**  
1:20

Internal door  
with frame fitted in opening, facing brickwork  
hinges on left  
leaf fits flush with frame, rebated



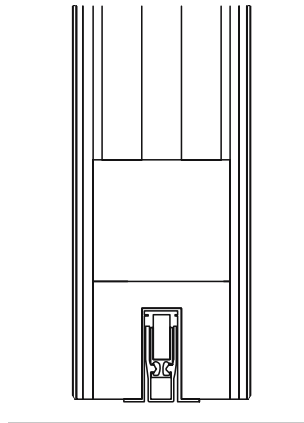
Leaf construction: Riwag-AluMax 59 mm  
Facing: high density fibreboard, high sound reduction index,  $R_w = 42$  dB



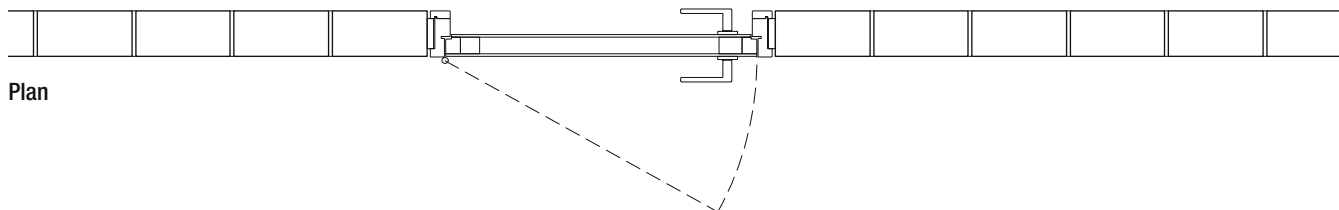
Leaf construction: **cellular-core door**  
Facing for painting, for low sound insulation requirements

Peripheral seal (for increased requirements such as sound, smoke, etc.)

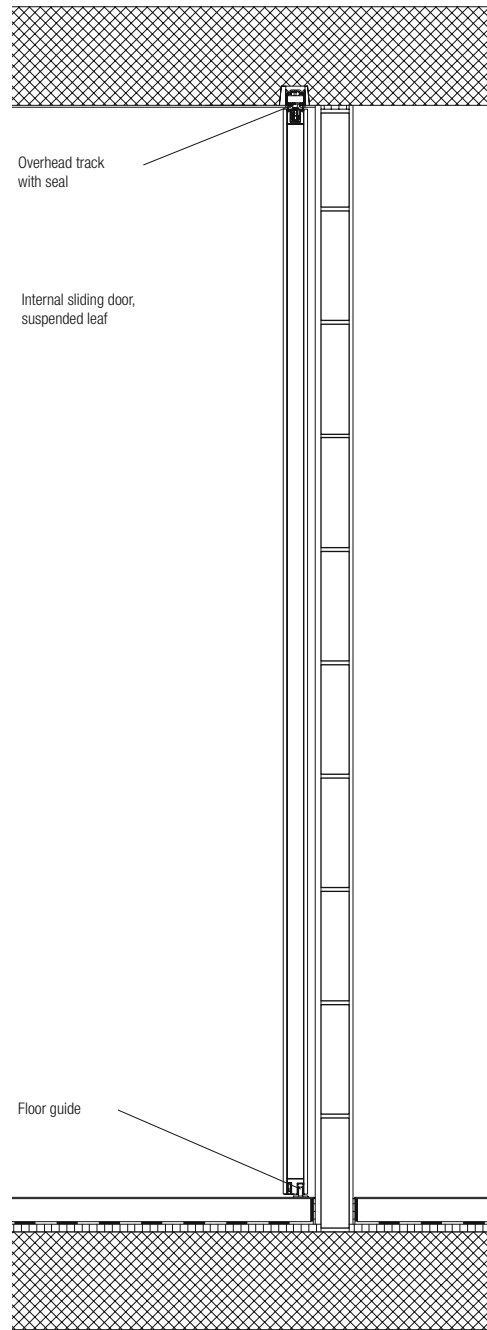
**Section**



**Plan**

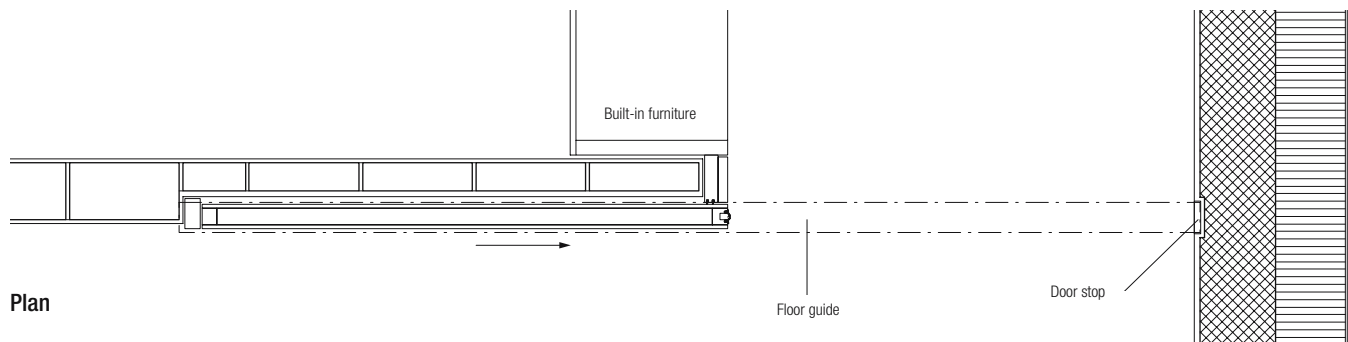


**Sliding door, internal – wood**  
1:20



Internal door  
single leaf, fitted into a slot in the wall  
for low sound insulation requirements

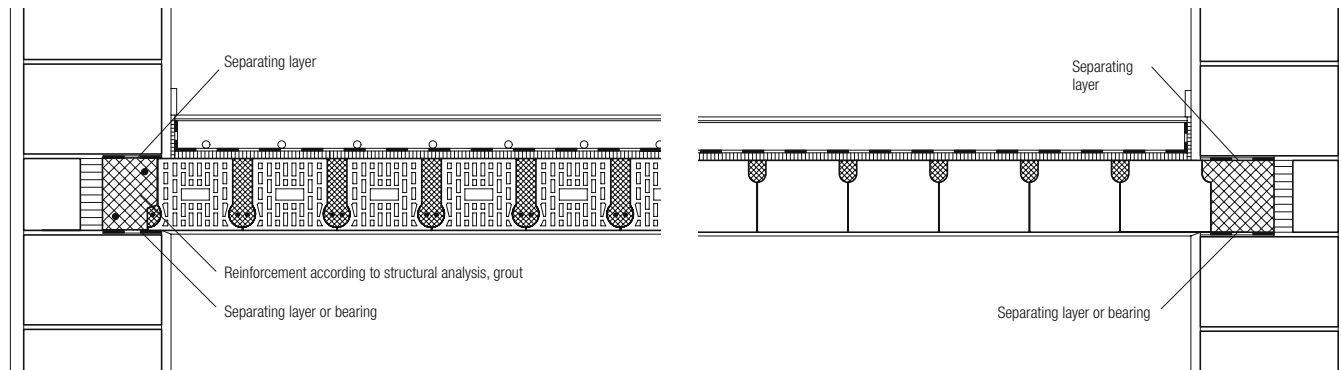
**Section**



**Plan**

## Hollow clay block floor

1:20



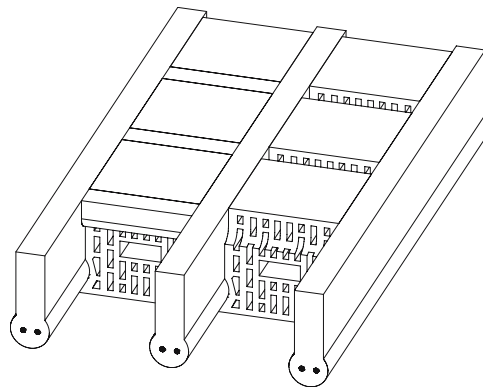
### Wall construction

#### Single-leaf masonry

- Render	35 mm
- Single-leaf masonry, 36.5 x 24.8 x 23.8 cm	365 mm
- Plaster	25 mm

### Floor construction

- Floor covering, e.g. plain clay tiles	10 mm
- Tile adhesive	1–2 mm
- Screed with underfloor heating	80 mm
- Separating layer (e.g. 1 mm plastic sheet)	
- Impact sound insulation	20 mm
- Hollow clay block floor	190–240 mm
- Plaster to soffit	10 mm



### Structure

- 1-way span (2-way possible: waffle systems)
- Same material for the soffit
- No concrete topping required
- Cantilevers not possible
- Not suitable for point loads
- Elements up to 6.6 m long in widths from 1 to 2.5 m (e.g. Bricosol)

### Features

- Adaptable flooring system
- No formwork
- Little propping needed
- Dry construction, can be installed any time of the year
- Can carry loads the next day

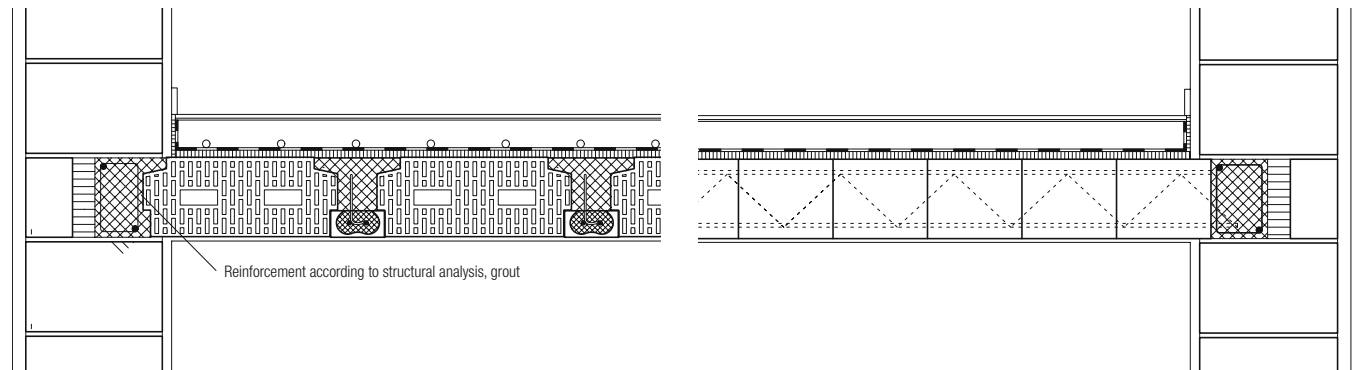


Fig. 1: Top: hollow clay blocks and reinforced concrete ribs;  
bottom: erection of factory-prefabricated elements (here: Bricosol products)



## Hourdis-type hollow clay block floor

1:20



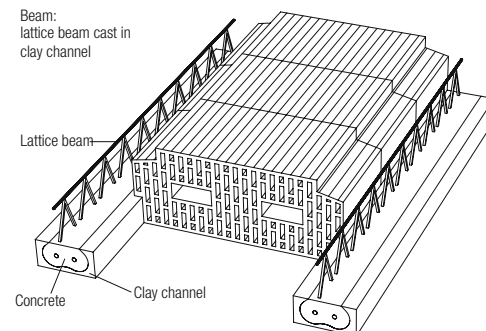
### Wall construction

#### Single-leaf masonry

- Render 35 mm
- Single-leaf masonry, 36.5 x 24.8 x 23.8 cm 365 mm
- Plaster 25 mm

### Floor construction

- Floor covering, e.g. plain clay tiles 10 mm
- Tile adhesive
- Screed with underfloor heating 80 mm
- Separating layer (e.g. 1 mm plastic sheet)
- Impact sound insulation 20 mm
- Hourdis-type hollow clay block floor 210–250 mm
- Plaster to soffit 10 mm



### Structure

- 1-way span (2-way possible: waffle systems)
- Same material for the soffit
- With or without concrete topping, depending on loads
- Cantilevers not possible
- Not suitable for point loads
- Span with in situ reinforcement: up to 7 m
- Span with prestressing: up to 7.5 m

### Features

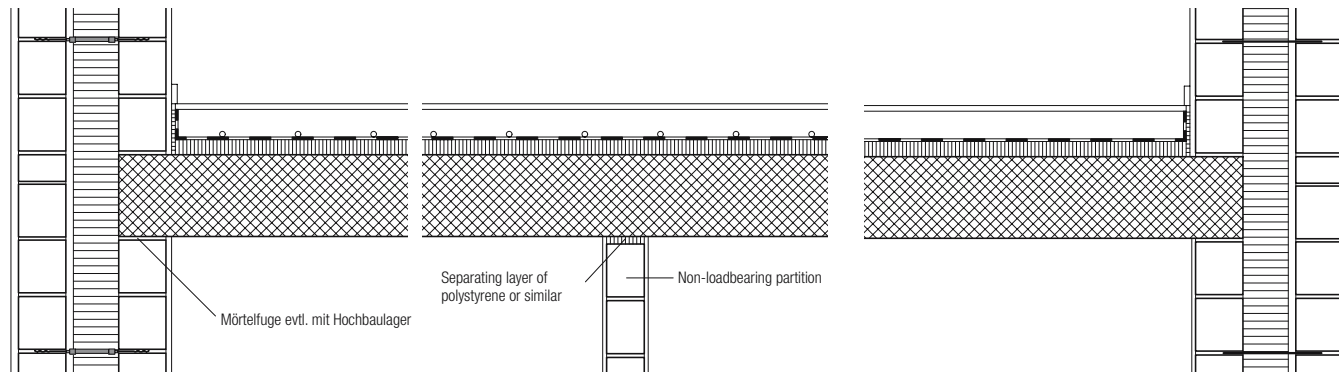
- In situ reinforcement: adaptable flooring system
- Prestressed: beams (tension chords) are prestressed; most systems fall into this category.
- No formwork
- Little propping needed



Fig. 2: Fitting the individual Hourdis-type elements between the reinforced concrete beams

## Solid concrete slab

1:20



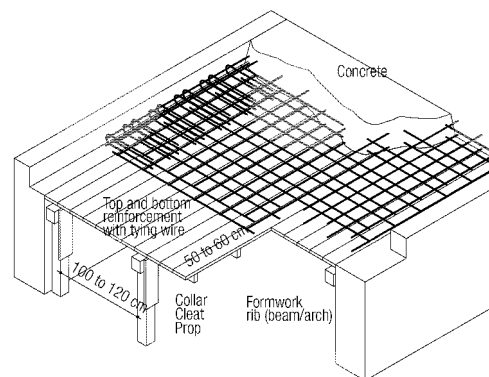
### Wall construction

*Double-leaf masonry, rendered*

- Render	20 mm
- Modular masonry units	125 mm
- Cavity (construction tolerance)	20 mm
- Thermal insulation	120 mm
- Modular masonry units	125 mm
- Plaster	15 mm

### Floor construction

- Floor covering, e.g. ready-to-lay parquet flooring	15 mm
- Screed with underfloor heating	80 mm
- Separating layer (e.g. 1 mm plastic sheet)	
- Impact sound insulation	40 mm
- In situ solid concrete slab with glaze finish (depth of slab depends on span)	210 mm



### Structure

- 1- or 2-way spans
- Economic spans:
  - up to approx. 5 m simply supported
  - up to approx. 7 m continuous
- Estimate of structural depth:
  - $d/L = 1/30$  for rectangular slabs
  - $d/L = 1/35$  for square slabs

### Features

- High material consumption in relation to span
- Wet construction

### Formwork

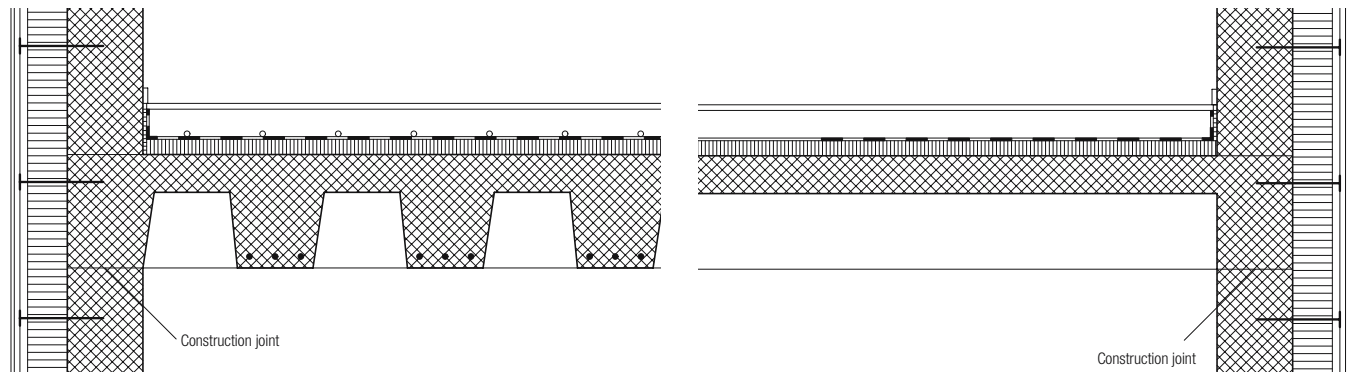
- In situ concrete: considerable propping and formwork requirements



Fig. 3: Prior to pouring the concrete: formwork, reinforcement and any services (electric cables, water pipes, ventilation ducts, etc.) that are to be cast in

## Ribbed concrete slab

1:20



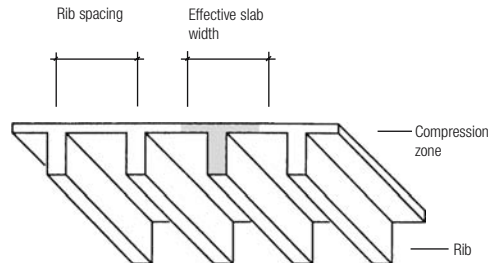
### Wall construction

*External insulation, rendered*

- Mineral render finish coat	2 mm
- Bonding render	4 mm
- Mineral render undercoat	20 mm
- Insulation	125 mm
- Concrete (loadbearing layer)	200 mm
- Bonding coat	
- Plaster	15 mm

### Floor construction

- Floor covering, e.g. stone tiles	15 mm
- Tile adhesive (thick- or thin-bed)	3–5 mm
- Screed with underfloor heating	80 mm
- Separating layer (1 mm plastic sheet)	
- Impact sound insulation	40 mm
- Ribbed concrete slab	
(depth of slab depends on span)	varies



### Structure

- 1-way span
- Weight-savings compared to a solid slab
- Spans:
  - 4–12 m simply supported
  - 5–20 m continuous
- Depths:
  - slab 5 to 8 cm
  - ribs 30 to max. 90 cm
- Services may be routed between the ribs

### Performance

- Mass–surface area ratio is good for heat storage capacity

### Features, formwork

- Extra formwork required in tension zone
- Prefabricated formwork:
  - reusable formwork
  - average formwork requirements
- In situ formwork: increased formwork requirements
- Prefabrication: lightweight “ribbed slab” elements constructed under factory conditions

### Sound

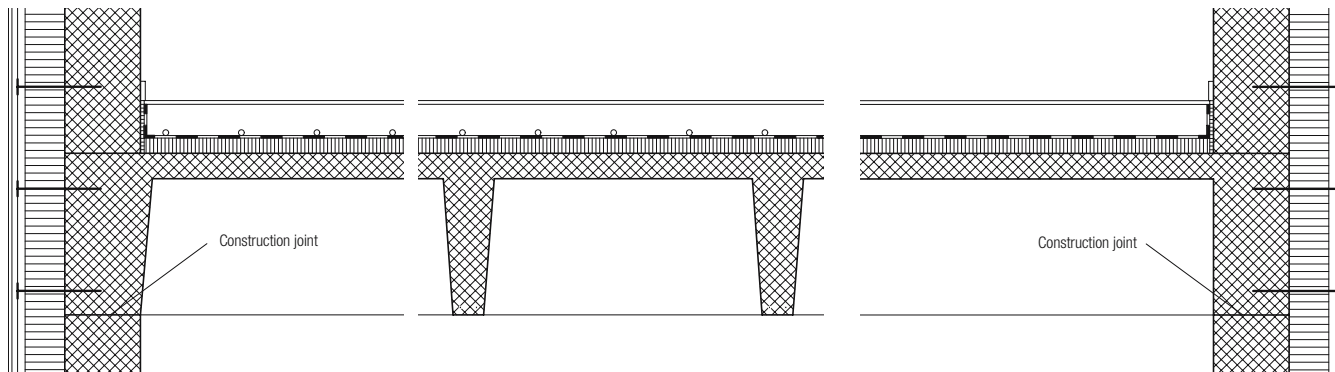
- Large surface area (surface texture) improves internal acoustics



Fig. 4: Bearth & Deplazes: School with hall, Vella (CH), 1997

## Concrete waffle slab

1:20



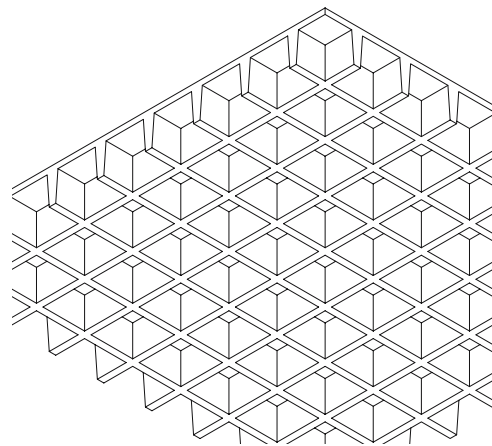
### Wall construction

*External insulation, rendered*

- Mineral render finish coat	2 mm
- Bonding render	4 mm
- Mineral render undercoat	20 mm
- Insulation board 5-110-10 (3-layer board), fixed with plastic fasteners	125 mm
- Concrete (loadbearing layer)	200 mm
- Bonding coat	
- Plaster	15 mm

### Floor construction

- Floor covering, e.g. hard-fired floor tiles	15 mm
- Tile adhesive	3–5 mm
- Screed with underfloor heating	80 mm
- Separating layer (e.g. 1 mm plastic sheet)	
- Impact sound insulation	40 mm
- Concrete waffle slab	varies



### Structure

- 2-way span
- Modularity
- Appropriate choice of rib depth enables large spans

### Features

- Low material consumption (in situ concrete)
- High formwork requirements when constructed in situ

### Formwork variations

- Gypsum, timber, steel or plastic waffle formers on boarding
- Reusable prefabricated formwork elements
- Permanent formwork (e.g. Durisol), tapering waffle formers ease striking

### Sound

- Large surface area (surface texture) improves internal acoustics

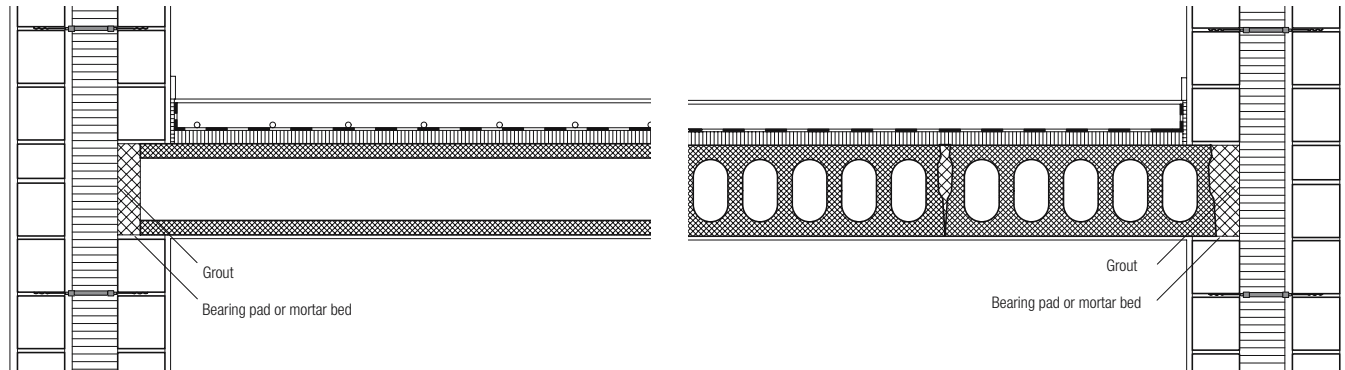


Fig. 5: Louis I. Kahn: Yale University Art Gallery, New Haven (USA), 1953



**Hollow-core concrete slab**

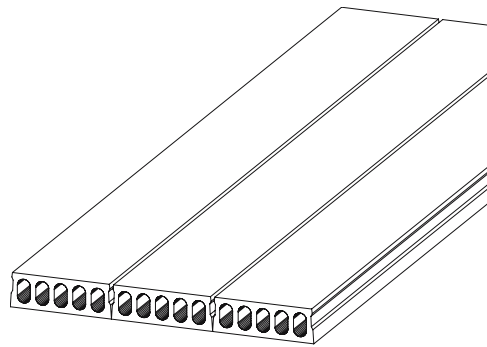
1:20

**Wall construction***Double-leaf masonry, rendered*

- Render	20 mm
- Modular masonry units	125 mm
- Cavity (construction tolerance)	20 mm
- Thermal insulation	120 mm
- Modular masonry units	125 mm
- Plaster	15 mm

**Floor construction**

- Floor covering, e.g. linoleum	5 mm
- Screed with underfloor heating	80 mm
- Separating layer (e.g. 1 mm plastic sheet)	
- Impact sound insulation	40 mm
- Hollow-core concrete unit	120–300 mm
- Bonding coat	
- Plaster to soffit	10 mm

**Structure**

- 1-way span, but not identifiable as such
- Spans up to 12 m
- Depths up to 300 mm

**Features**

- Prefabrication
- Short erection time
- Dry construction: short drying time
- Dry erection

**Formwork**

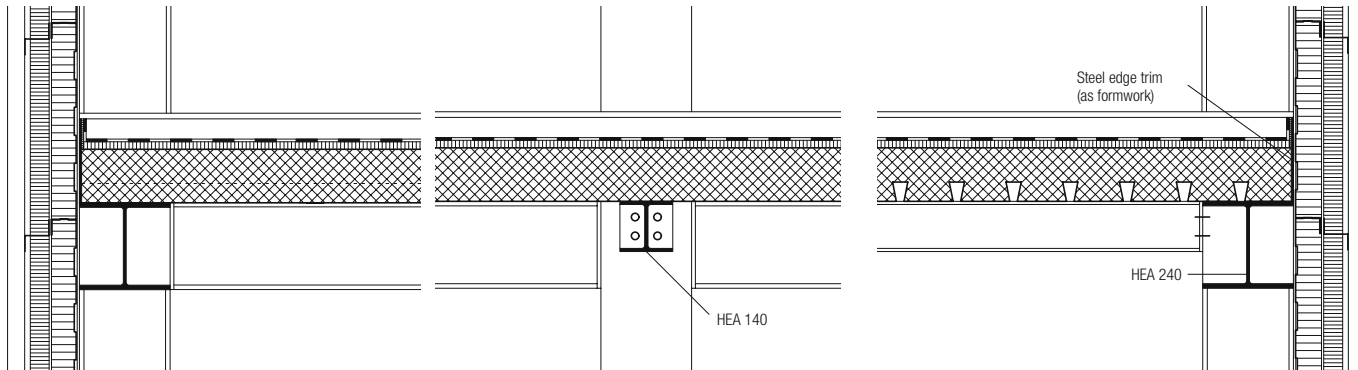
- No propping necessary
- Smooth soffit



Fig. 6: The concrete elements are lifted into position with a crane.

## Composite slab, profiled metal sheeting–concrete

1:20



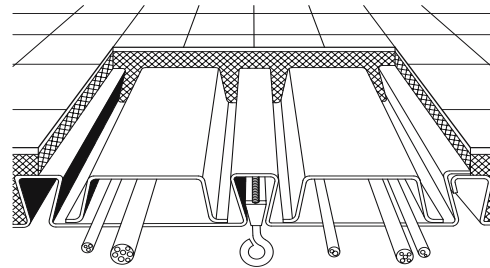
### Wall construction

#### External cladding, with ventilated cavity

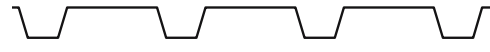
- Corrugated metal sheeting, galvanised	varies
- Ventilated cavity (vertical sheeting)	>40 mm
- Thermal insulation	50 mm
- Thermal insulation in sheet steel trays (galvanised)	80 mm
- Steel columns, steel beams	varies

### Floor construction

- Floor covering, e.g. magnesite	10 mm
- Screed	60 mm
- Separating layer (e.g. 1 mm plastic sheet)	
- Impact sound insulation	20 mm
- Reinforced concrete topping	130–180 mm
- Profiled metal sheeting	
- Steel primary/secondary beams (e.g. HEA or HEB sections)	varies



Holorib® metal sheeting



Trapezoidal metal sheeting

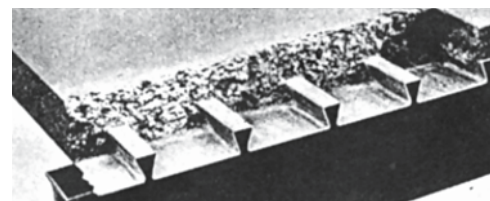
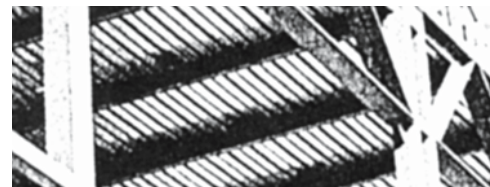


Fig. 7: (top) Soffit of profiled metal sheeting; (bottom) profiled metal sheeting with concrete topping

### Structure

- 1-way span
- Profiled metal sheeting, reinforced concrete topping
- Relatively good fire resistance
- Provides ducting for services
- Span in direction of profiling without supporting construction (primary/secondary beams): up to 6 m
- Structural depth: 13–22 cm; concrete topping: 8–20 cm

### Features

- Little propping needed
- Reduces the work on site

### Formwork

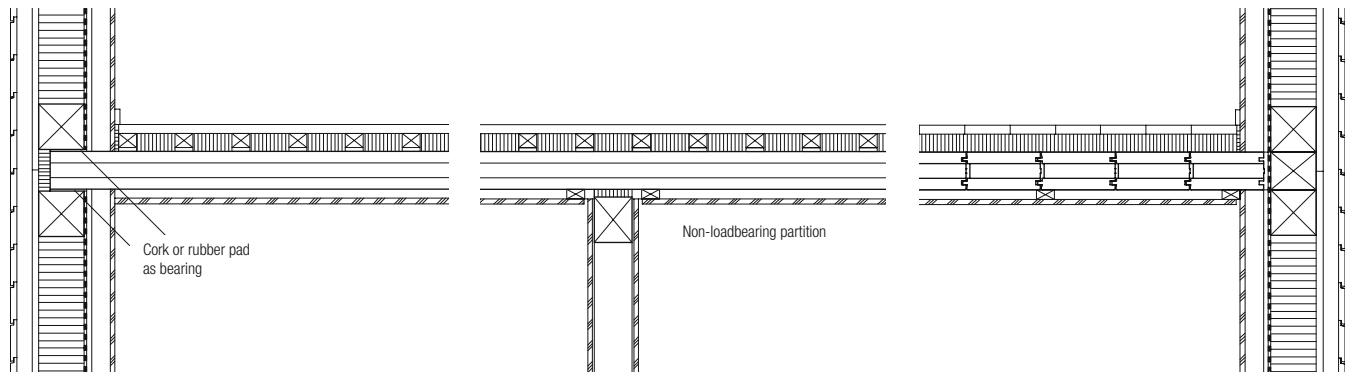
- No formwork or main reinforcement
- Low handling weight

### Sound

- Good airborne and impact sound insulation
- Beware of flanking transmissions!

**Solid timber floor**

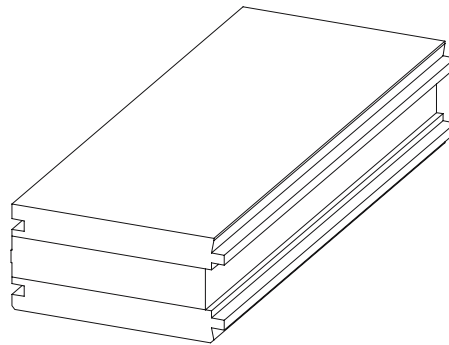
1:20

**Wall construction***Platform frame construction*

- Weatherboarding	24 mm
- Battens, ventilated cavity	40 mm
- Softboard (airtight membrane)	18 mm
- Thermal insulation, frame	120 mm
- Vapour check	
- Plain angled connections	
- Battens (space for services)	50 mm
- Wood-cement particleboard	12 mm

**Floor construction**

- Wooden floorboards	24 mm
- Impact sound insulation, counter battens	40 mm
- Rubber strips as separating layer beneath battens (for impact sound insulation)	
- Solid timber floor (depth depends on span)	80–120 mm
- Battens	24 mm
- Wood-cement particleboard	15 mm

**Structure**

- 1-way span
- Rigid floor without vibration problems
- Spans of 4–5 m
- Depths of 80–120 mm, hollow elements over 120 mm
- Relatively large mass (good inertia)

**Features**

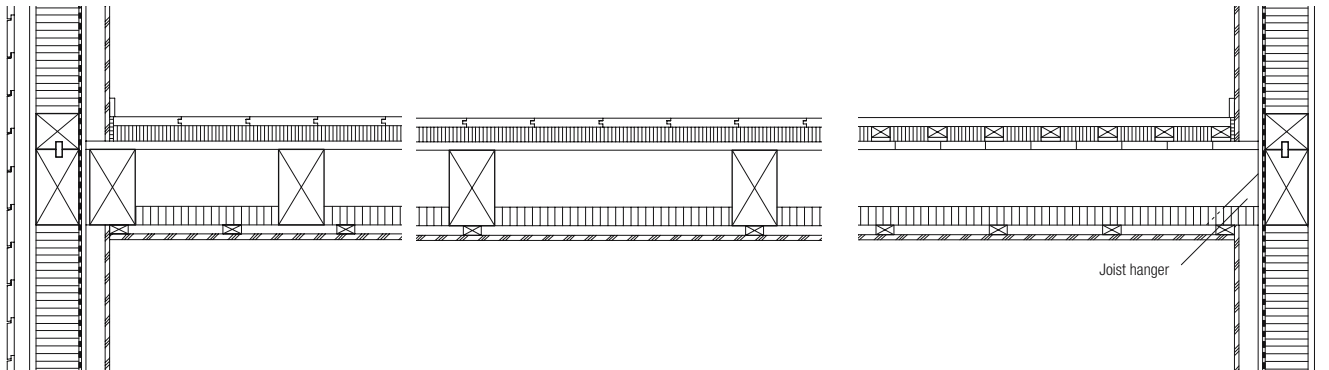
- Prefabricated glued individual solid timber elements
- Dry construction
- Simple assembly
- Fast assembly
- simultaneous planning and construction not possible!



Fig. 8: Staggered positioning of solid timber elements

## Timber joist floor

1:20



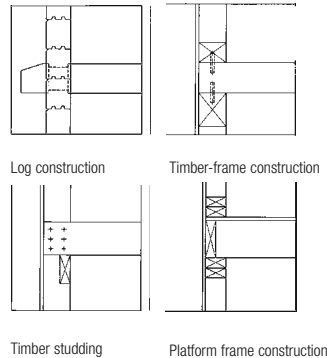
### Wall construction

#### Platform frame construction

- Weatherboarding	24 mm
- Battens, ventilated cavity	40 mm
- Softboard (airtight membrane)	18 mm
- Thermal insulation, frame	120 mm
- Vapour check	
- Plain angled connections	
- Battens (space for services)	50 mm
- Wood-cement particleboard	12 mm

### Floor construction

- Wooden floorboards (tongue and groove)	24 mm
- Impact sound insulation, battens, rubber strips as separating layer beneath battens (for impact sound insulation)	40 mm
- Counter-floor (e.g. diagonal boarding with butt joints)	20 mm
- Joists (depth depends on span)	200 mm
- Joist dimensions	120 x 200 mm
- Sound insulation	50 mm
- Battens	24 mm
- Wood-cement particleboard	15 mm



Timber studding      Platform frame construction

Fig. 9: Various types of timber construction



Fig. 10: Daniele Marques: private house (Ober-Riffig), Emmenbrücke (CH), 1993

### Structure

- 1-way span
- Joist spacing: 50–80 cm
- Susceptible to vibration
- Greater load-carrying capacity when joist ends are built in
- Additional measures, e.g. diagonal boarding (counter-floor, soffit) required in order to achieve stiffening effect
- Spans: up to 5 m

### Features

- Dry construction
- Simple assembly
- Fast assembly
- Labour-intensive

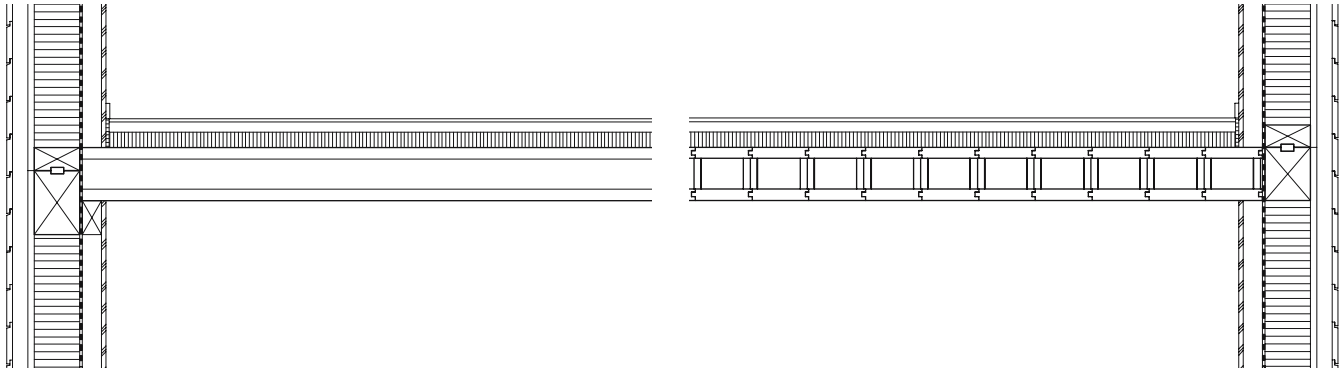
### Sound

- Problematic airborne and impact sound insulation



## Timber box element floor

1:20



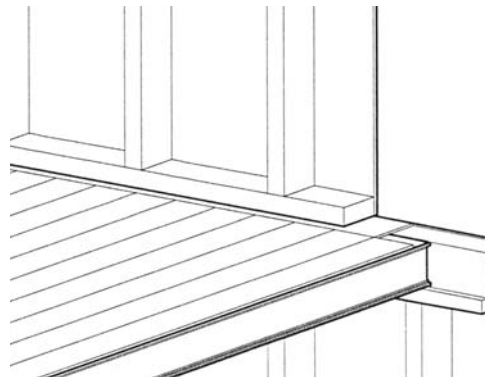
### Wall construction

#### Platform frame construction

- Weatherboarding	24 mm
- Battens, ventilated cavity	40 mm
- Softboard (airtight membrane)	18 mm
- Thermal insulation, frame	120 mm
- Vapour check	
- Plain angled connections	
- Battens (space for services)	50 mm
- Wood-cement particleboard	12 mm

### Floor construction

- Floor covering, e.g. ready-to-lay	10 mm
- parquet flooring	27 mm
- 3-ply core plywood	40 mm
- Impact sound insulation, 2 layers each 20 mm	120–320 mm
- Timber box element floor on supporting members (structural depth depends on span)	
- Glaze finish	



### Structure

- Timber box elements made from solid planks (e.g. Lignatur)
- High loadbearing capacity coupled with low self-weight
- 1-way span
- Rigid floor without vibration problems
- Spans of 4–8 m
- Depths of 12–32 cm

### Features

- Simple erection
- Dry construction
- Timber box elements prefabricated individually or in larger subassemblies
- Fast erection

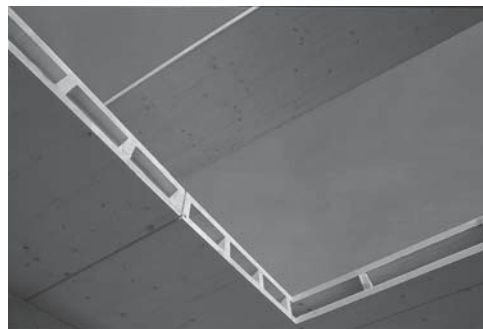
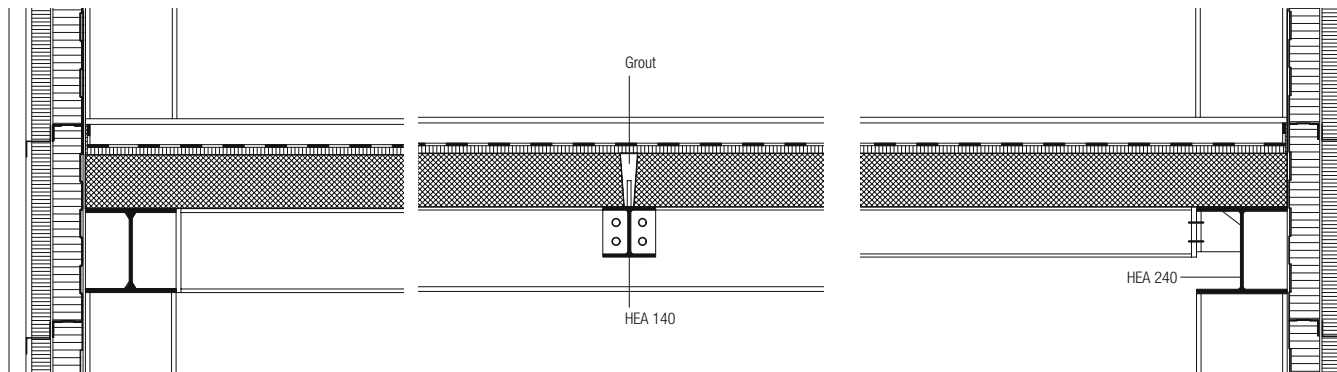


Fig. 11: Opening in timber box element floor, with voids not yet closed off

## Steel floor

1:20



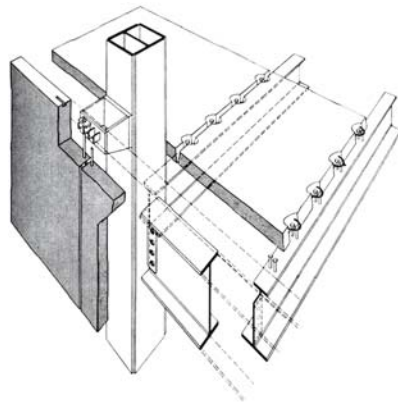
### Wall construction

*External cladding, with ventilated cavity*

- Corrugated metal sheeting, galvanised varies
- Ventilated cavity (vertical sheeting) > 40 mm
- Thermal insulation 50 mm
- Thermal insulation in sheet steel trays (galvanised) 80 mm
- Steel columns, steel beams varies

### Floor construction

- Floor covering, e.g. magnesite 10 mm
- Screed 60 mm
- Separating layer (e.g. 1 mm plastic sheet)
- Impact sound insulation 20 mm
- Concrete 150–300 mm
- Steel primary/secondary beams (e.g. HEA or HEB sections) varies



### Structure

- 1-way span
- Modularity (for standard plate widths)
- Prefabrication
- Services can be routed along steel beams
- Low weight
- Steel beams limit fire resistance
- Spans of up to 6 m

### Features

- Dry construction
- No formwork and no propping
- Fast assembly

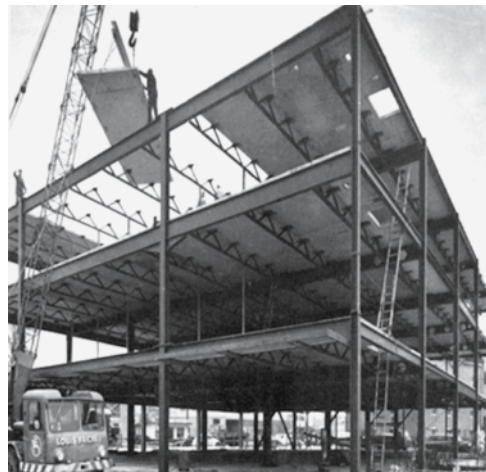


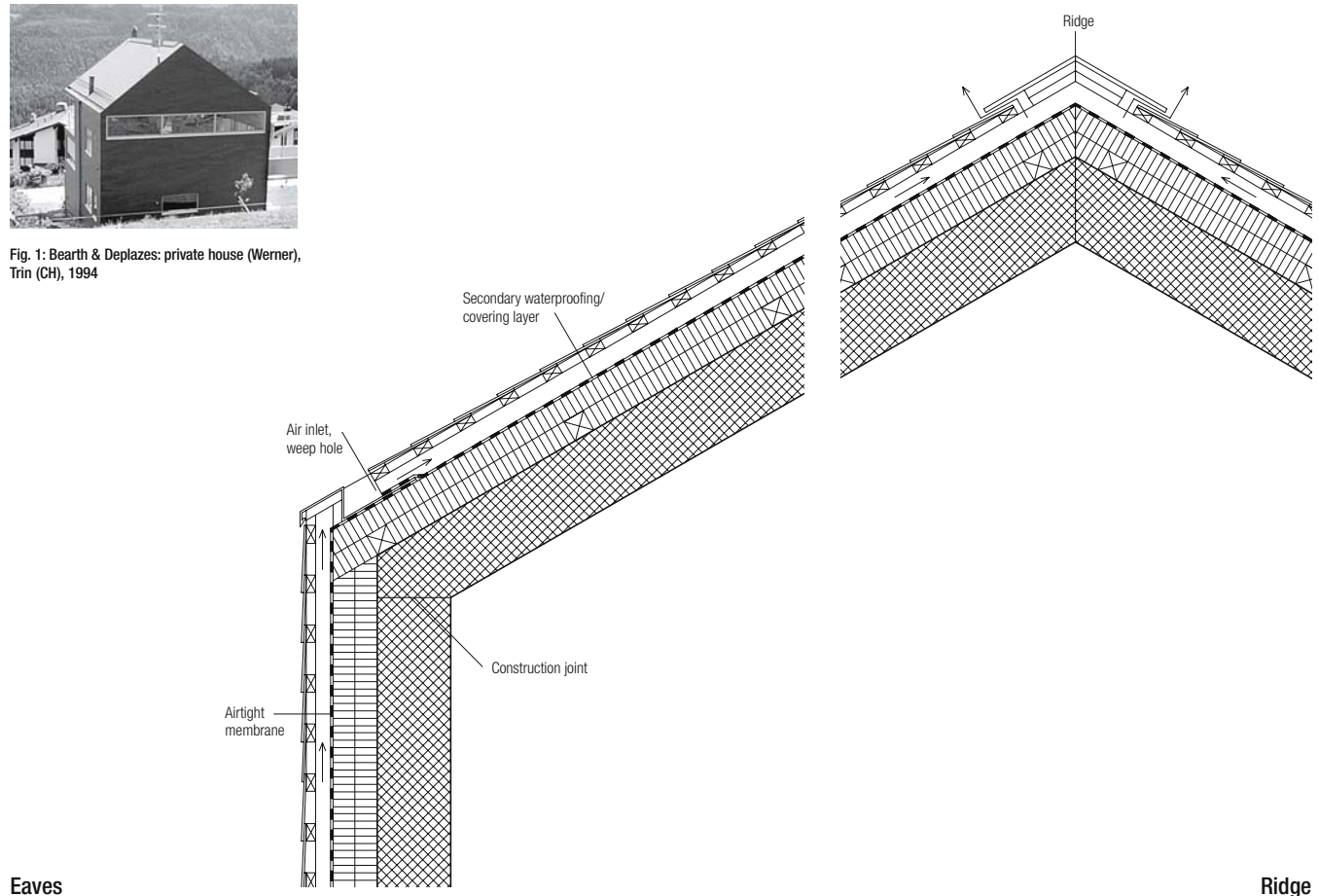
Fig. 12: Primary structure of (solid) rolled sections, secondary structure of (open) lattice beams

**Pitched roof – warm deck**

Fibre-cement – external cladding, lightweight

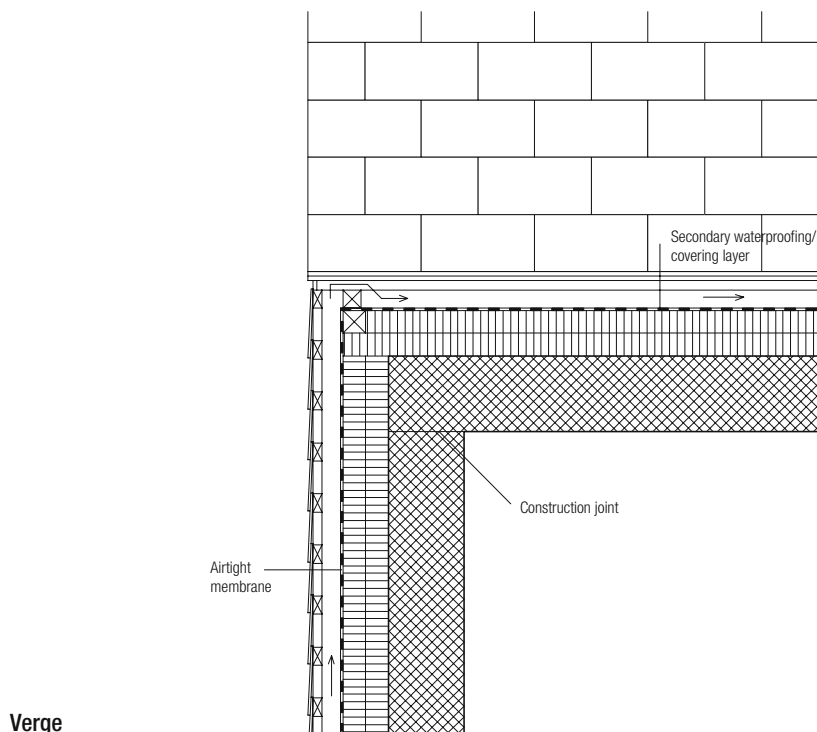


Fig. 1: Bearth & Deplazes: private house (Werner), Trin (CH), 1994



Eaves

Ridge



Verge

**Roof construction**

- Slates (Eternit)	approx. 3.5 mm
- Battens, 24 x 48 mm	24 mm
- Counter battens, 48 x 48 mm, ventilated cavity	48 mm
- Secondary waterproofing/covering layer on battens	3 mm
- Thermal insulation and battens (in both directions)	120 mm
- Concrete roof	200 mm
<i>Total</i>	<i>approx. 400 mm</i>

**Wall construction**

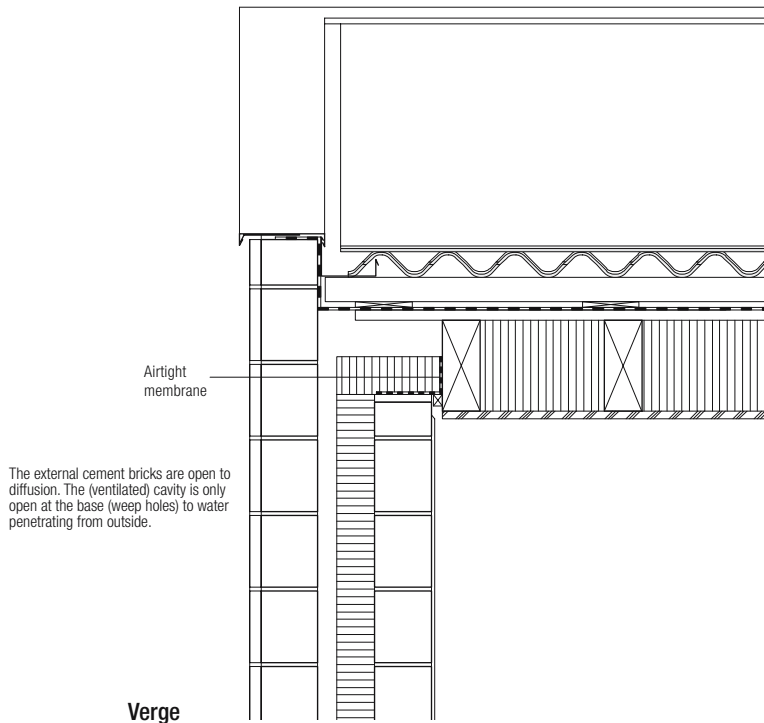
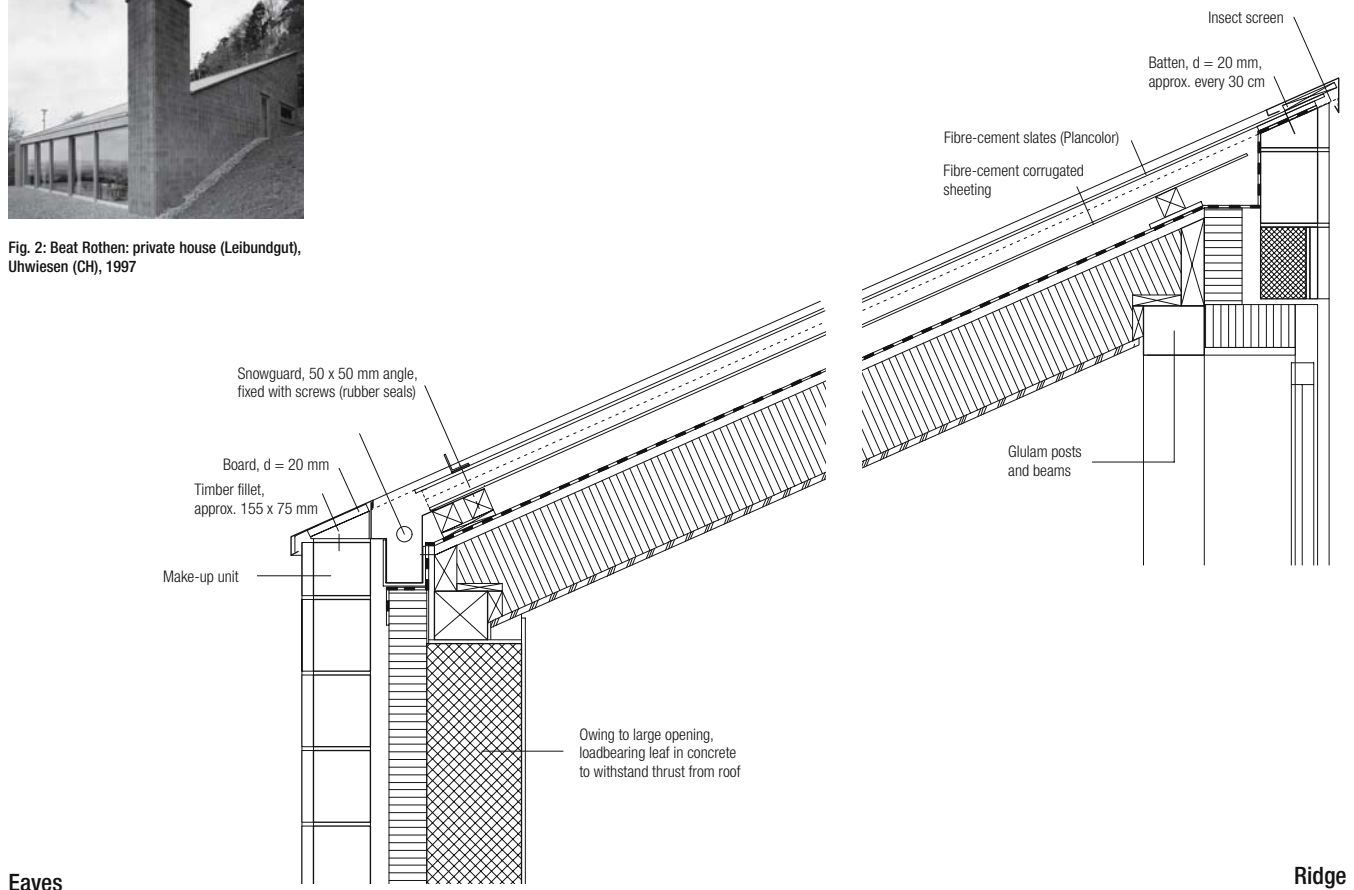
- Slates	35 mm
- Battens	24 mm
- Counter battens, ventilated cavity	48 mm
- Airtight membrane	1 mm
- Thermal insulation and battens (in both directions)	120 mm
- Concrete wall	200 mm
<i>Total</i>	<i>428 mm</i>

## Pitched roof – warm deck, monopitch roof

### Fibre-cement – facing masonry



Fig. 2: Beat Rothen: private house (Leibundgut), Uhwiesen (CH), 1997



#### Roof construction

- Roof covering: Eternit "Integraldach" system	
- Fibre-cement slates (Plancolor)	7 mm
- Secondary waterproofing/covering layer of fibre-cement corrugated sheeting (Welleternit)	57 mm
- Horizontal battens, 60 x 60 mm	60 mm
- Birdsmouth rafter connection	20 mm
- Secondary waterproofing/covering layer (Pavatex)	
- Rupli timber elements: Gutex softboard, structural timber members with Isofloc thermal insulation in between, 3-ply core plywood spruce (vapourproof)	260 mm
<i>Total</i>	<i>404 mm</i>

#### Wall construction

- Facing masonry, cement bricks, 18 x 19 x 30 cm	180 mm
- Cavity	50 mm
- Thermal insulation	100 mm
- Clay masonry	150 mm
- Plaster	10 mm
<i>Total</i>	<i>490 mm</i>

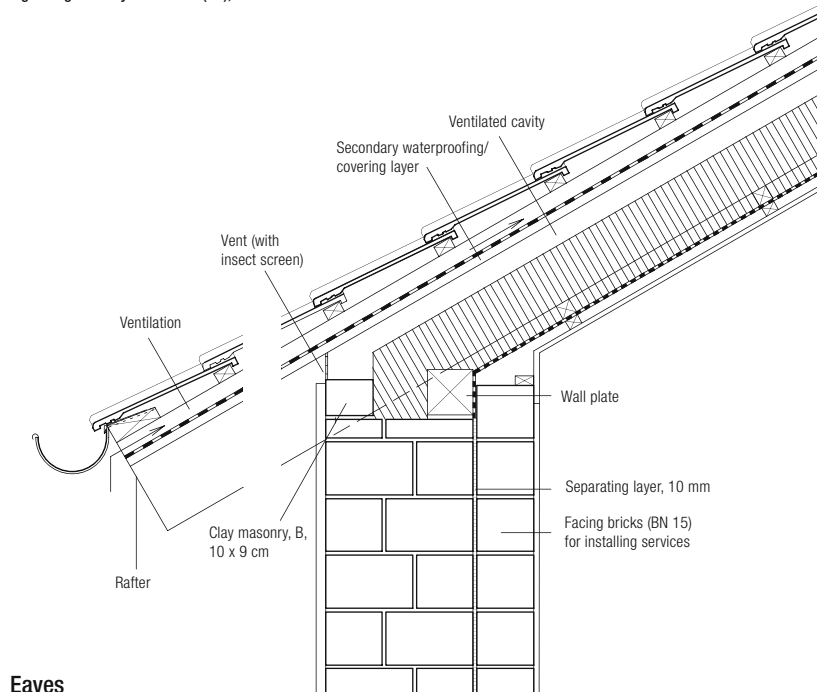


**Pitched roof – cold deck**

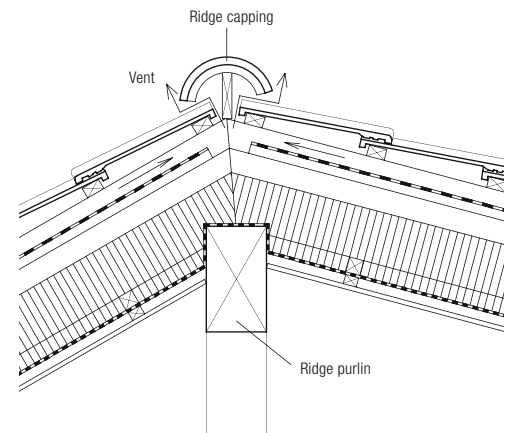
Roof tiles – masonry in brickwork bond



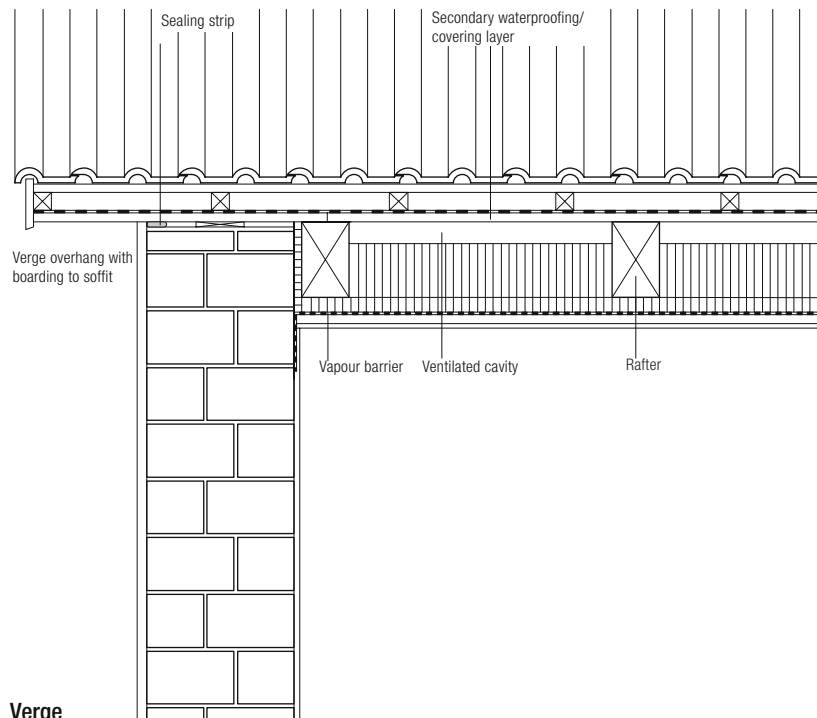
Fig. 3: Gigon & Guyer: House C (CH), 1994



Eaves



Ridge



Verge

**Roof construction**

- Concrete interlocking tiles	approx. 70 mm
- Tiling battens, 30 x 50 mm	30 mm
- Counter battens, 45 x 50 mm	45 mm
- Seamless secondary waterproofing/covering layer on roof decking	22 mm
- Ventilating cavity	60 mm
- Thermal insulation, rockwool	140 mm
- Thermal insulation, rockwool	40 mm
- Vapour barrier	
- Battens, 24 x 48	24 mm
- Lining (plasterboard)	12.5 mm
<i>Total</i>	<i>approx. 440 mm</i>

**Wall construction**

- Render	25 mm
- Masonry in brickwork bond, Optitherm 15 and 23	390 mm
- Plaster	15 mm
<i>Total</i>	<i>430 mm</i>

## Pitched roof – cold deck

Sheet metal – single-leaf masonry

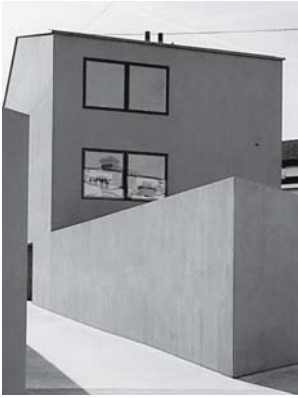
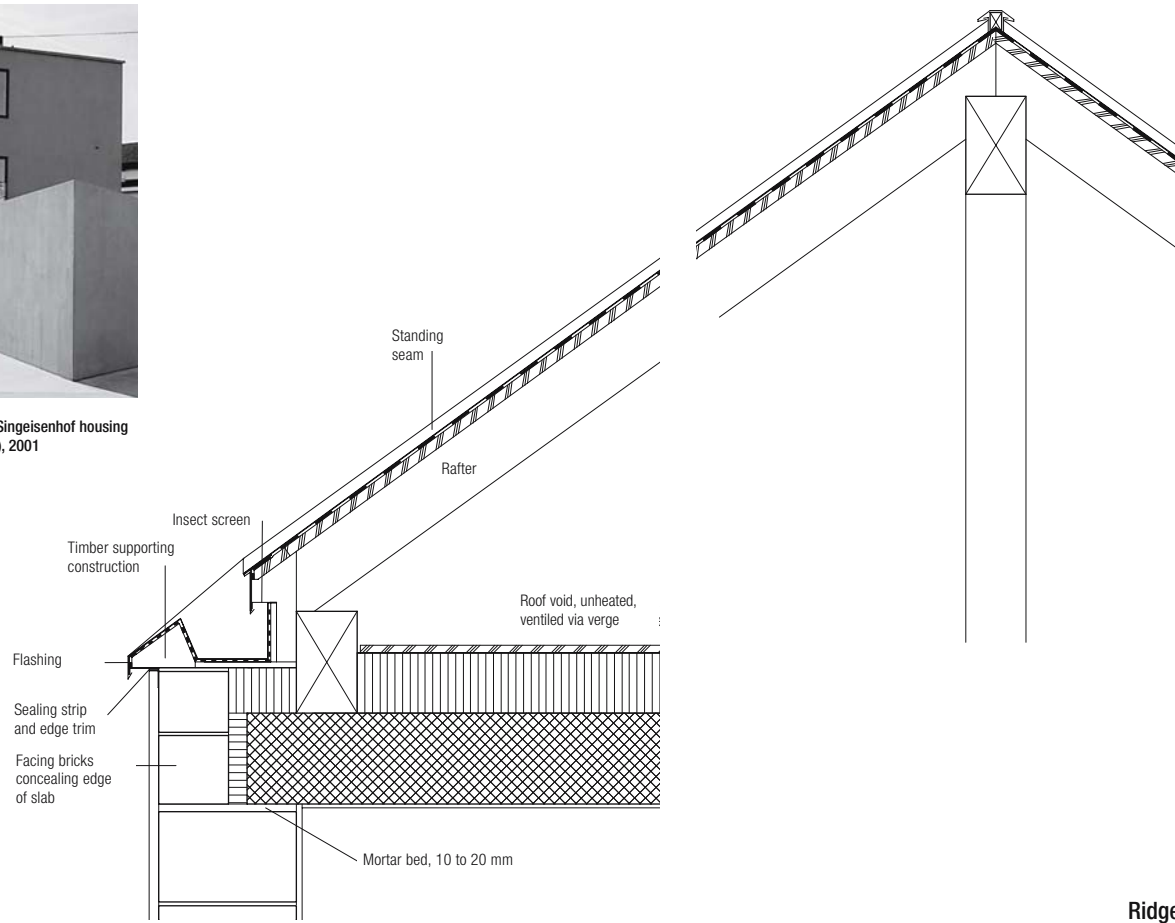
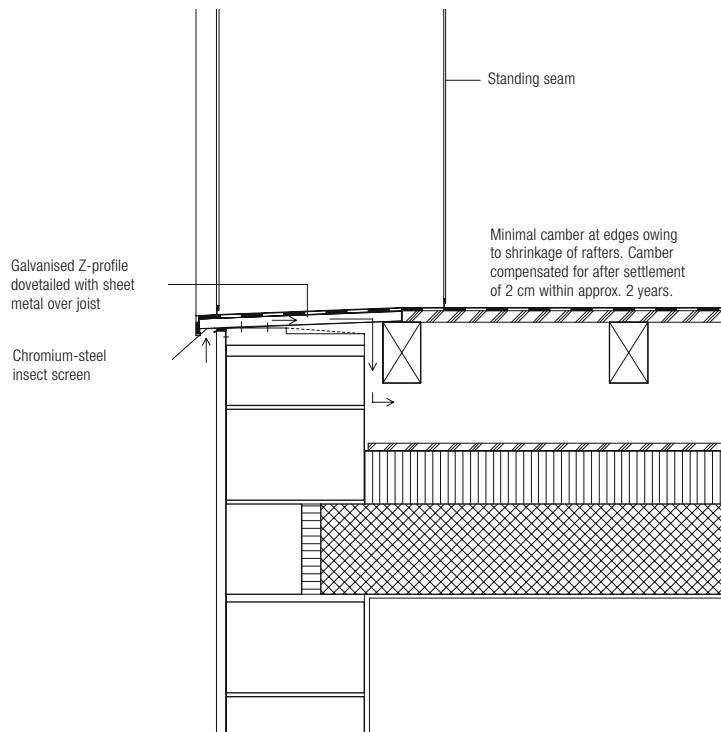


Fig. 4: Morger & Degelo: Singeisenhof housing development, Riehen (CH), 2001



Eaves

Ridge



Verge

**Roof construction (cold deck)**

- Sheet copper, in bays with standing seams	0.6 mm
- Secondary waterproofing/covering layer, F3 film	
- Roof decking	27 mm
- Rafters, 100 x 160 mm	160 mm
<i>Total</i>	<i>188 mm</i>

**Floor construction (insulated)**

- Chipboard	20 mm
- Insulation, rockwool	160 mm
- Concrete slab	240 mm
- Plaster	10 mm
<i>Total</i>	<i>430 mm</i>

**Wall construction**

- Render	25 mm
- Single-leaf masonry, ThermoCellit	365 mm
- Plaster	15 mm
<i>Total</i>	<i>405 mm</i>

## Flat roof – warm deck

Bitumen – double-leaf masonry, rendered

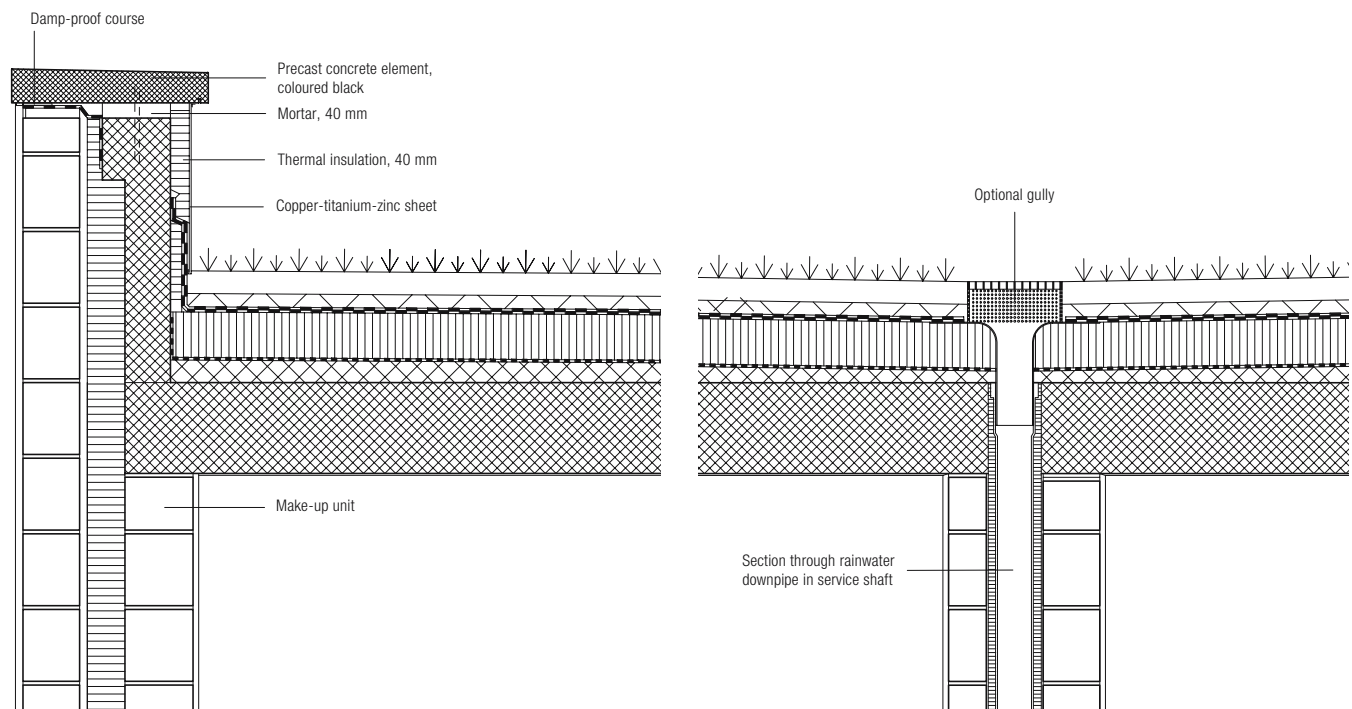


Fig. 5: Ackermann & Friedli: Ackermännli School, Basel (CH), 1996

**Roof construction**

- Topsoil	60 mm
- Drainage/protection mat	35 mm
- Calendered polymeric roofing, 2 layers	
- Thermal insulation	120 mm
- Vapour barrier (Reasons: residual moisture in concrete, temporary roof during construction, protection, against vapour diffusion, especially at cracks and penetrations)	
- Screed laid to falls	30–60 mm
- Concrete slab	240 mm
- Plaster	5 mm
<i>Total</i>	<i>490–520 mm</i>

**Wall construction**

- Render	20 mm
- Clay masonry, B, 29 x 15 x 19 cm	150 mm
- Cavity (construction tolerance)	20 mm
- Thermal insulation	100 mm
- Clay masonry, B, 29 x 17.5 x 19 cm	175 mm
- Plaster	15 mm
<i>Total</i>	<i>480 mm</i>

## Flat roof – warm deck

Bitumen – fair-face concrete with internal insulation

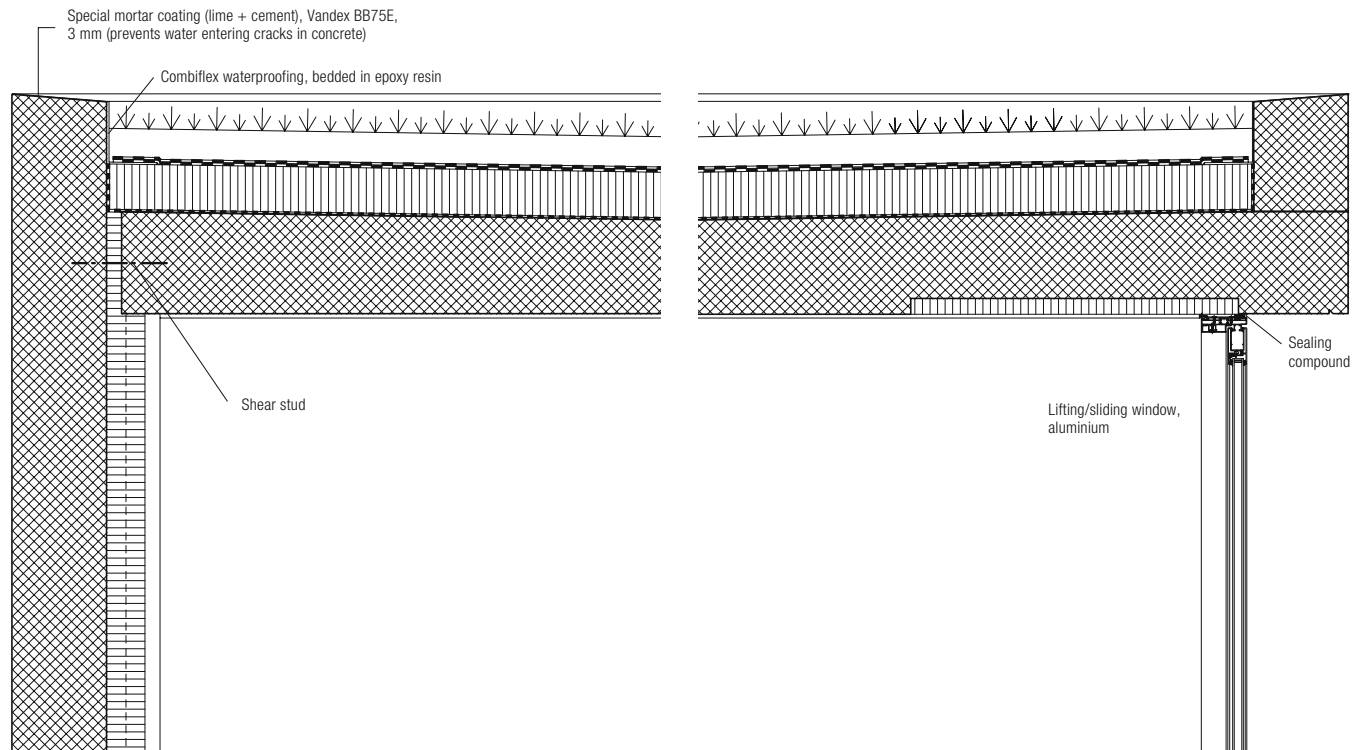


Fig. 6: Morger & Degelo: private house (Müller), Staufen (CH), 1999

### Roof construction

- Substrate for extensive planting	80 mm
- Bitumen roofing felt, 2 layers, EP3, EP4 (root-resistant)	7 mm
- Thermal insulation	120 mm
- Vapour barrier (Reasons: residual moisture in concrete, temporary roof during construction, protection, against vapour diffusion, especially at cracks and penetrations)	
- Concrete slab laid to falls	200–270 mm
- Plaster	5–10 mm
<i>Total</i>	<i>412–487 mm</i>

### Wall construction

- Fair-face concrete	250 mm
- Internal insulation, extruded polystyrene	100 mm
- Plasterboard	40 mm
<i>Total</i>	<i>390 mm</i>



## Flat roof – warm deck

Plastics – external cladding, heavyweight

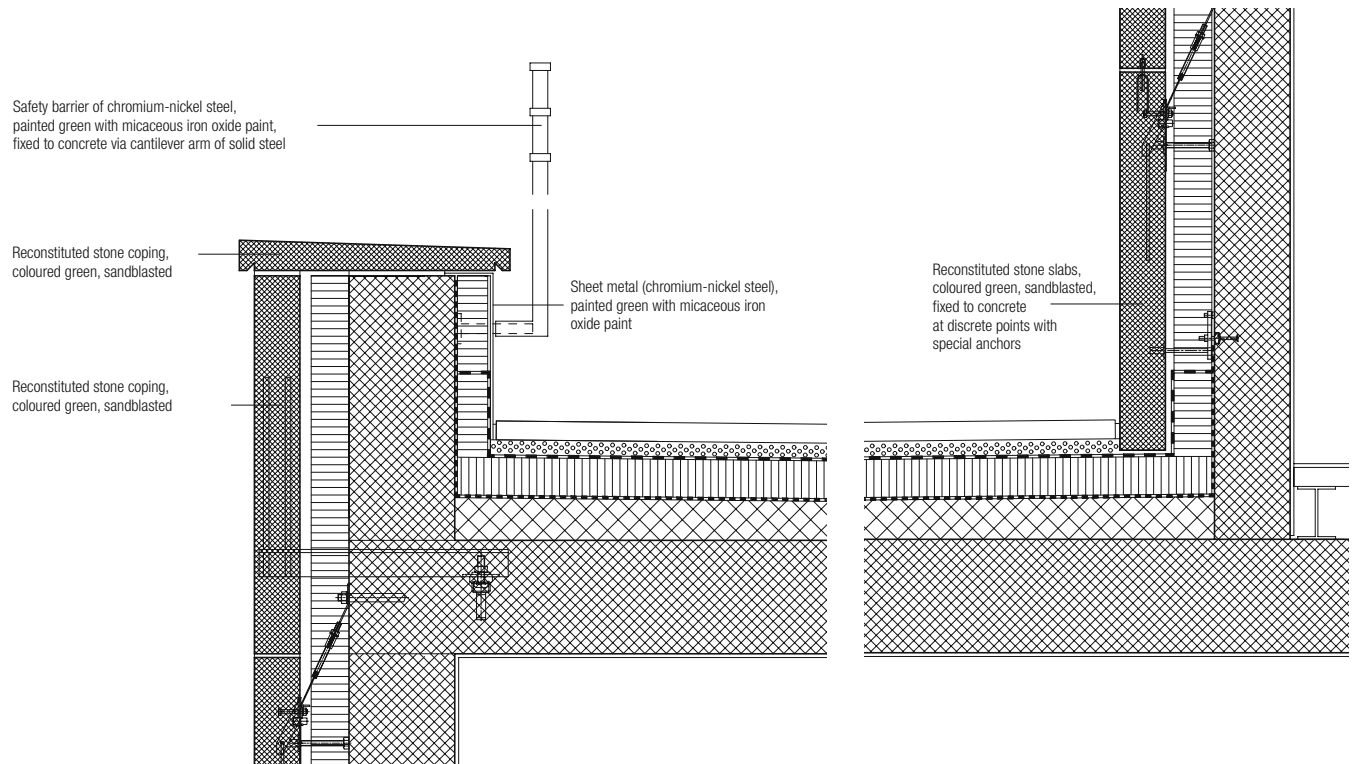


Fig. 7: Diener & Diener: Warteckhof mixed residential and commercial development, Basel (CH), 1996

**Roof construction**

- Concrete flags	50 mm
- Gravel	40 mm
- Synthetic roofing felt	
- Thermal insulation	100 mm
- Vapour barrier	
- Screed laid to falls	20–80 mm
- Concrete slab	300 mm
- Plaster	5–10 mm
<i>Total</i>	<i>515–580 mm</i>

**Wall construction**

- Reconstituted stone slabs, coloured green, sandblasted	120 mm
- Cavity (construction tolerance)	30 mm
- Thermal insulation	100 mm
- Concrete wall	200 mm
- Plaster	10 mm
<i>Total</i>	<i>460 mm</i>

## Flat roof – warm deck, e.g. KompaktDach

Bitumen – non-loadbearing external wall

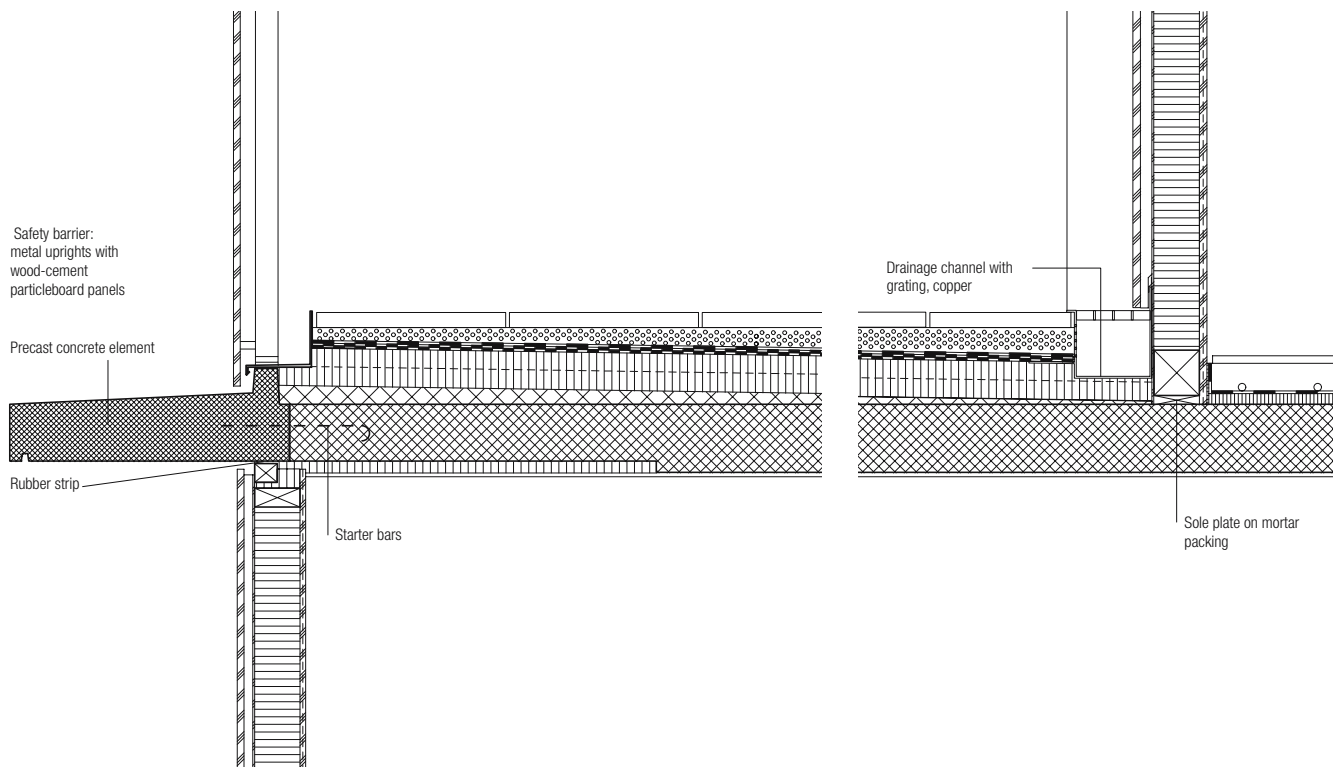


Fig. 8: Morger & Degelo: publicly assisted housing, Basel (CH), 1993

### Terrace construction

- Concrete flags laid horizontally	40 mm
- Chippings (to compensate for falls)	min. 30 mm
- Protective fleece	
- Waterproofing, 2 layers, bituminous, fully bonded	
- Cellular glass laid in hot bitumen	100 mm
- Screed laid to falls, 1.5%	20–60 mm
- Concrete slab	180 mm
- Plaster	10 mm
<i>Total</i>	<i>380–420 mm</i>

### Wall construction

- Wood-cement particleboard	18 mm
- Ventilated cavity	23 mm
- Hardboard	5 mm
- Thermal insulation	120 mm
- Plywood	15 mm
<i>Total</i>	<i>181 mm</i>

**Flat roof – upside-down roof**

Bitumen – external insulation, rendered

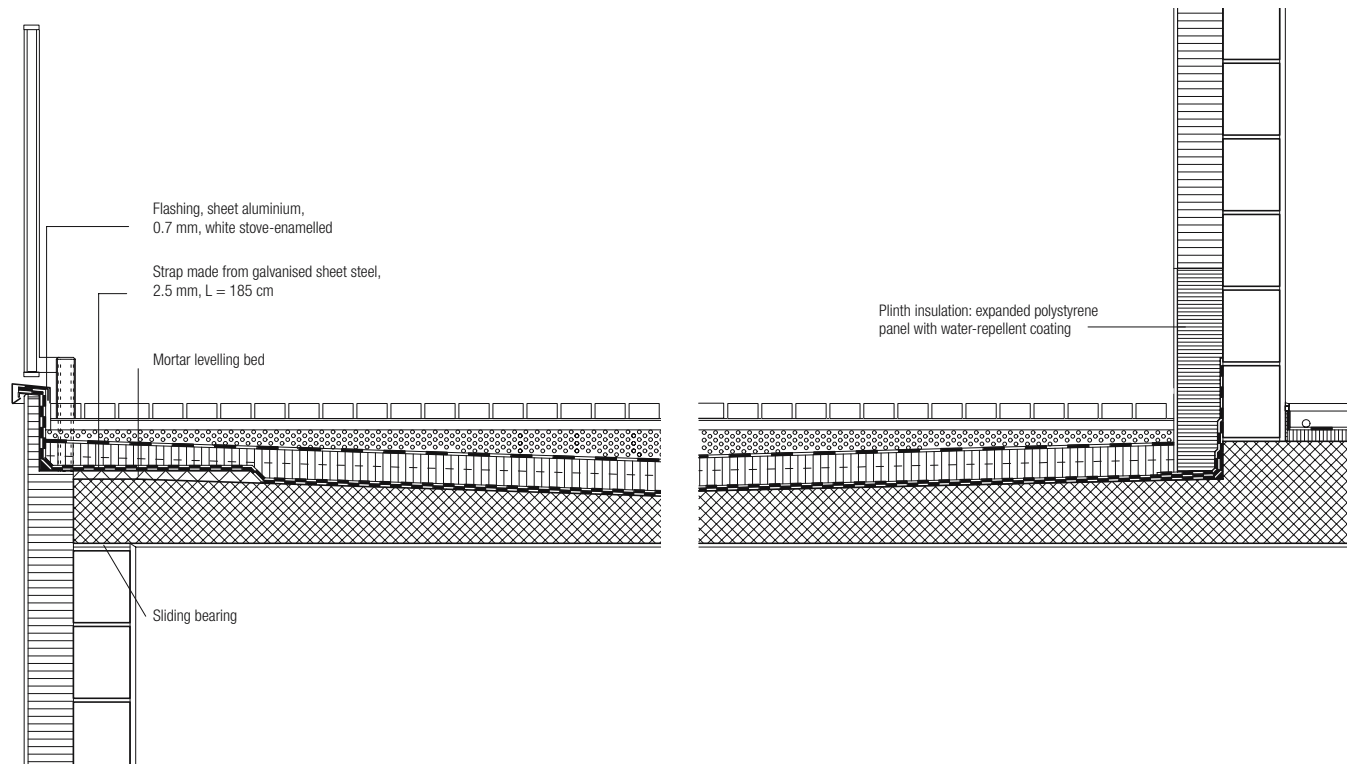


Fig. 9: Oliver Schwarz architectural practice:  
Peter apartment block, Rüslikon (CH), 1997

**Roof construction**

- Okoume battens	40 mm
- Okoume supporting battens	30 mm
- Fine chippings, bonded	40–90 mm
- Protective fleece	
- Thermal insulation, expanded polystyrene	80 mm
- Calendered polymeric roofing, 2 layers	
- Concrete slab laid to falls	120–170 mm
- Plaster	5–10 mm
<i>Total</i>	<i>315–420 mm</i>

**Wall construction**

- Render (depends on system)	5 mm
- External insulation, extruded polystyrene	120 mm
- Clay masonry	150 mm
- Plaster	15 mm
<i>Total</i>	<i>290 mm</i>

## Flat roof – cold deck, uncoated roof

### Bitumen – timber platform frame construction

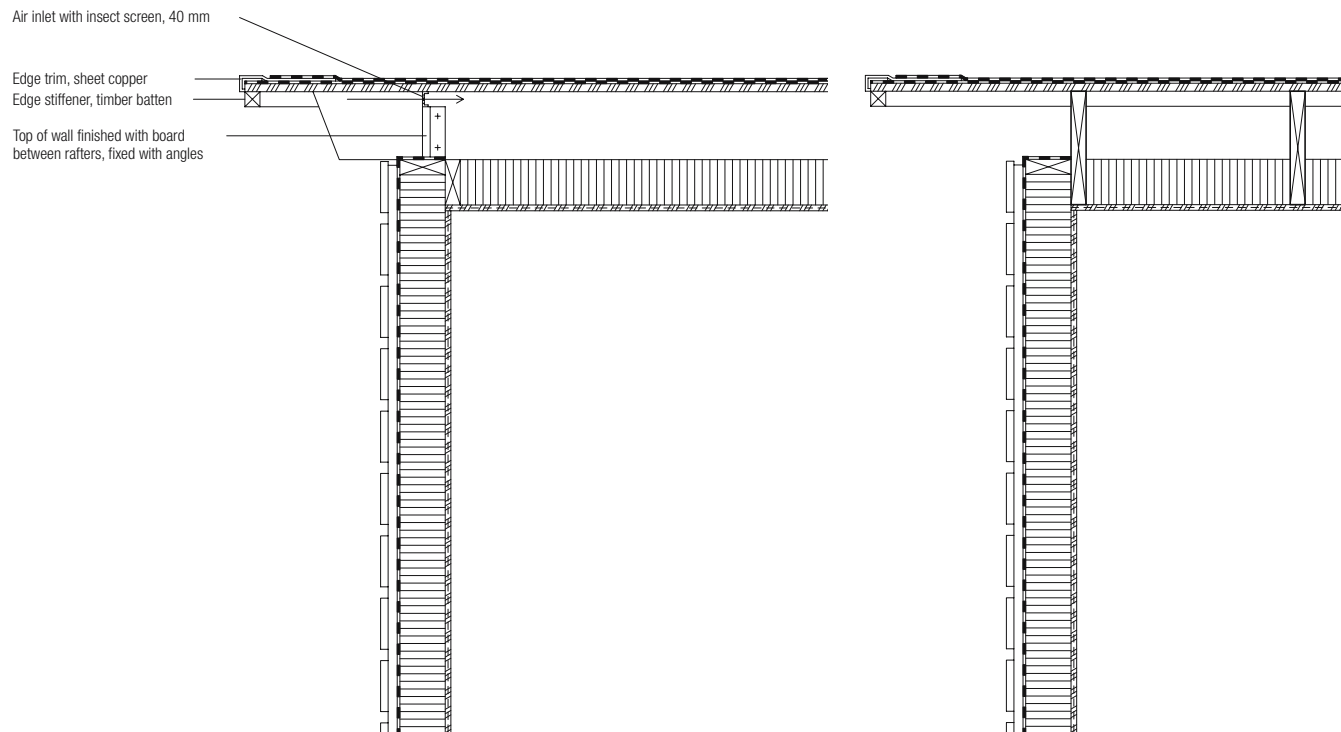


Fig. 10: Morger & Degelo: temporary nursery school, Basel (CH), 1993

#### Roof construction

- Granule-surfaced bitumen felt, 2 layers	
- Plywood	21 mm
- Timber joists, 40 x 300 mm with 180 mm cavity, and 120 mm thermal insulation in between	300 mm
- Plywood (airtight membrane)	15 mm
<i>Total</i>	<i>336 mm</i>

#### Wall construction

- Horizontal boarding externally, rough finish	21 mm
- Vertical boarding with ventilated cavity	24 mm
- Protective layer to thermal insulation	
- Timber frame, with thermal insulation in between	120mm
- Plywood (airtight membrane)	15 mm
<i>Total</i>	<i>180 mm</i>

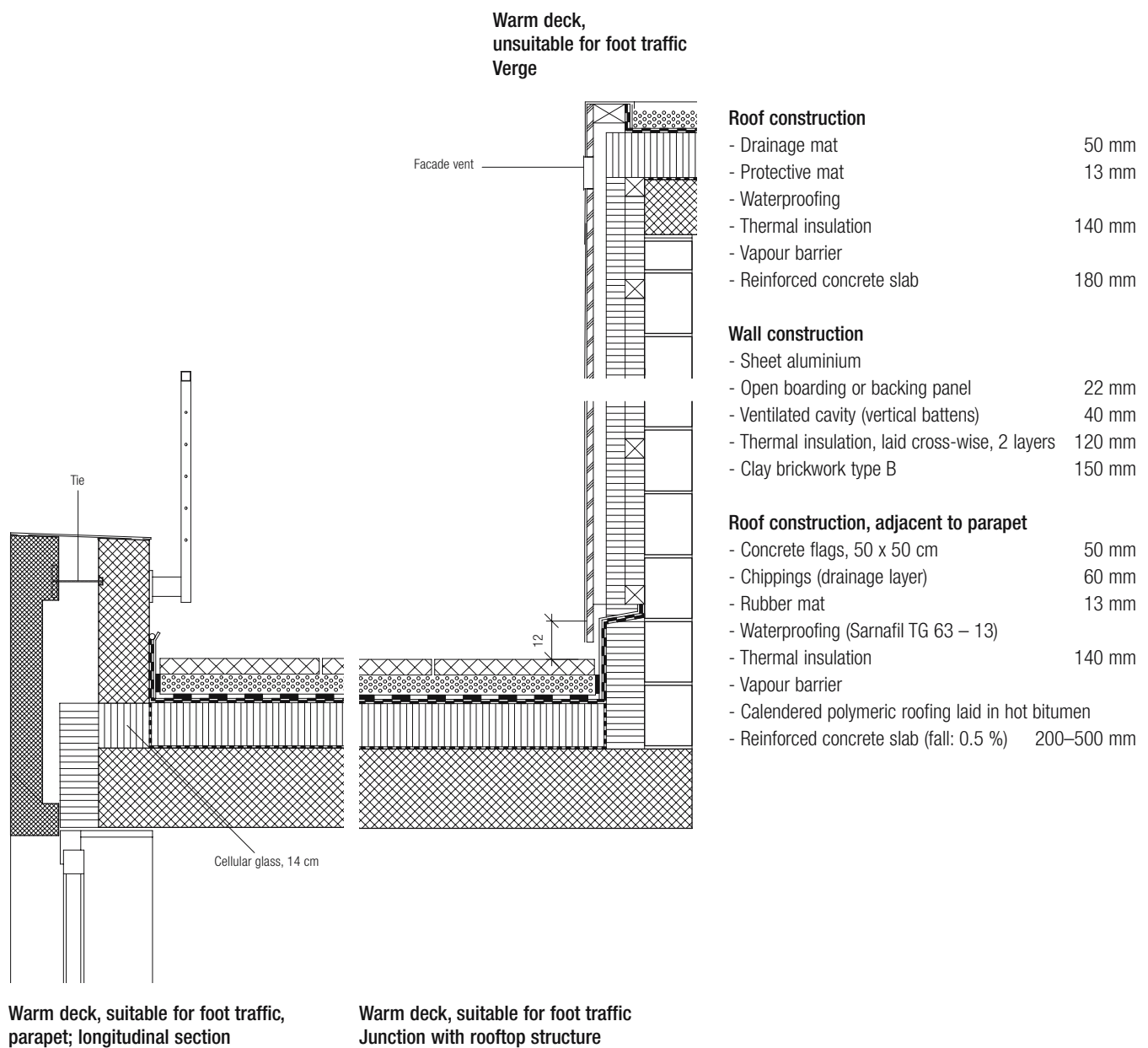


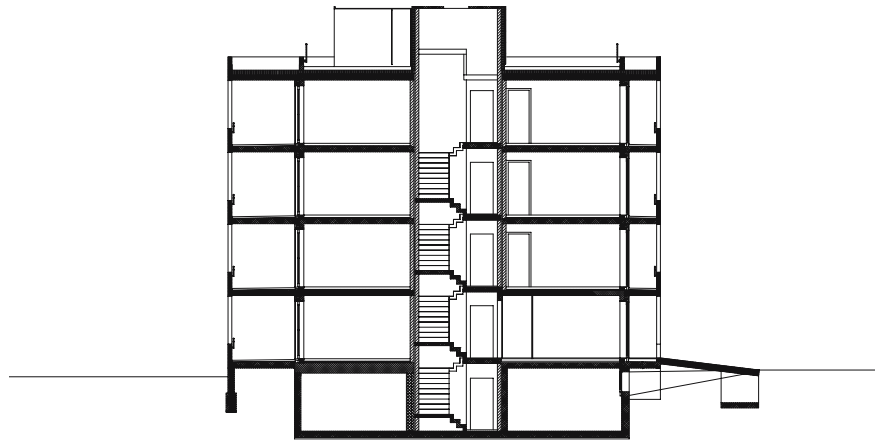
## Flat roof – warm deck

suitable/unsuitable for foot traffic

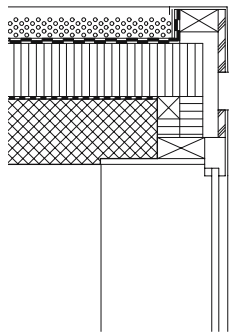


Fig. 11: Bearth & Deplazes: private house  
"In den Lachen", Chur (CH), 1997



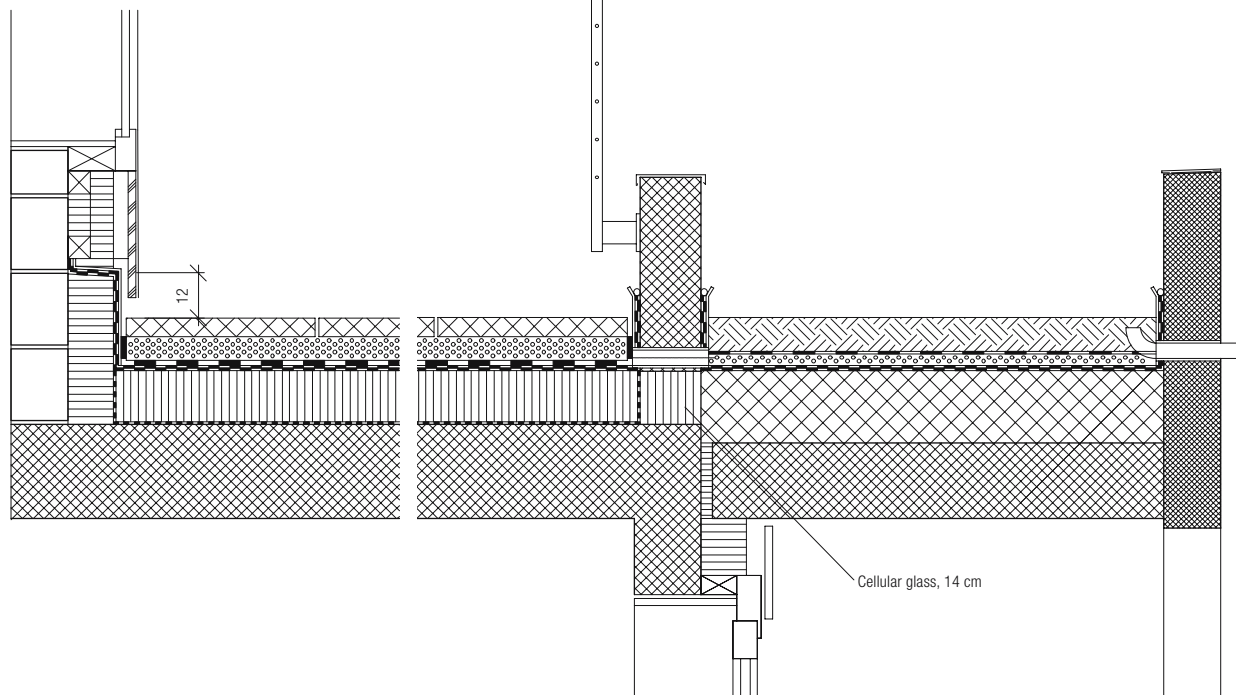


Section



**Roof construction, perimeter strip**

- Vegetation layer (humus, topsoil, for extensive planting) 90 mm
- Chippings (drainage layer) (expanded clay, d = 5 mm) 60 mm
- Separating and protective layer
- Protective waterproofing (rubber mat, Sarnafil TG 63 – 13)
- Screed laid to falls, 1.5 % 190 mm
- Reinforced concrete slab 200 mm



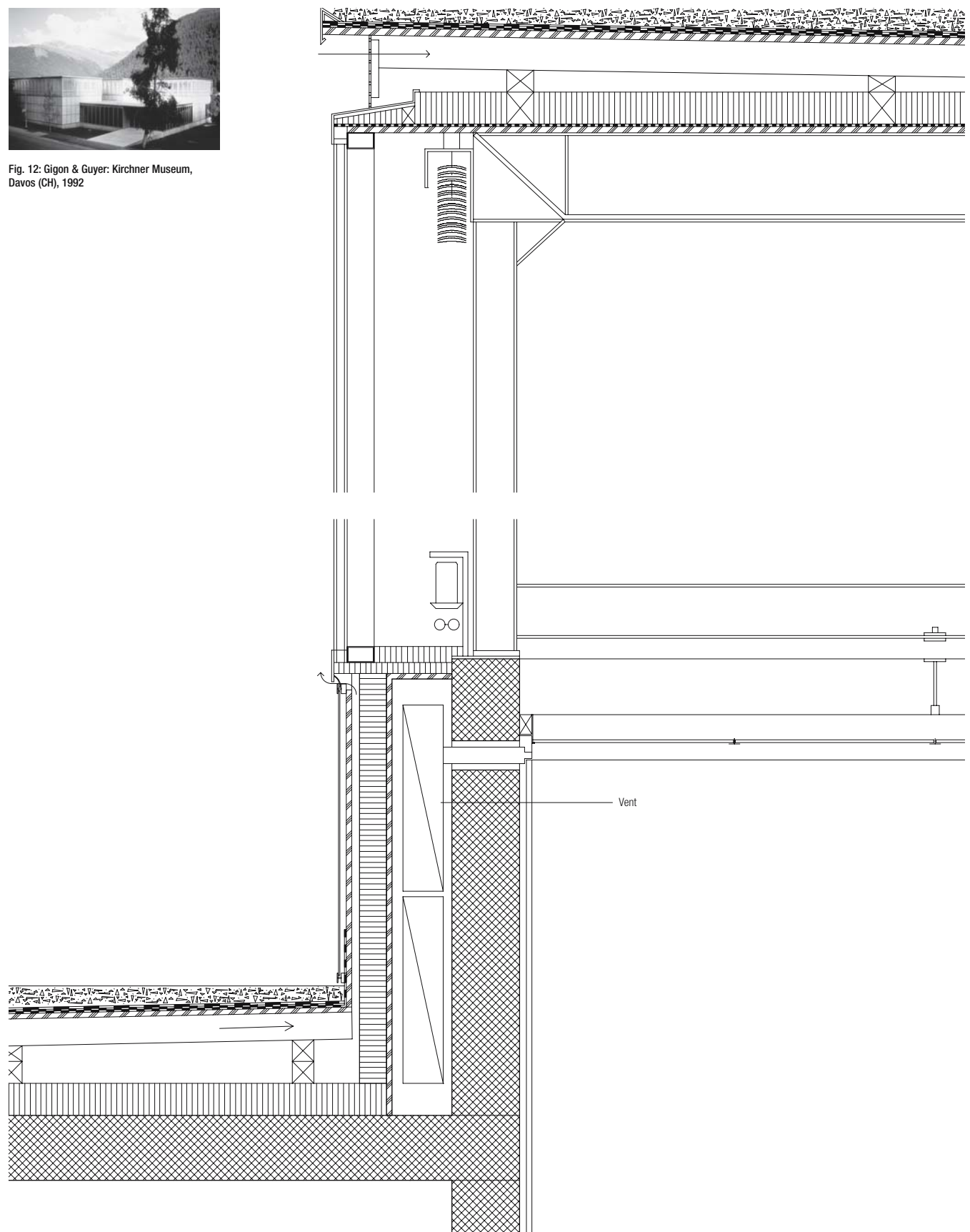
Warm deck, suitable for foot traffic, terrace

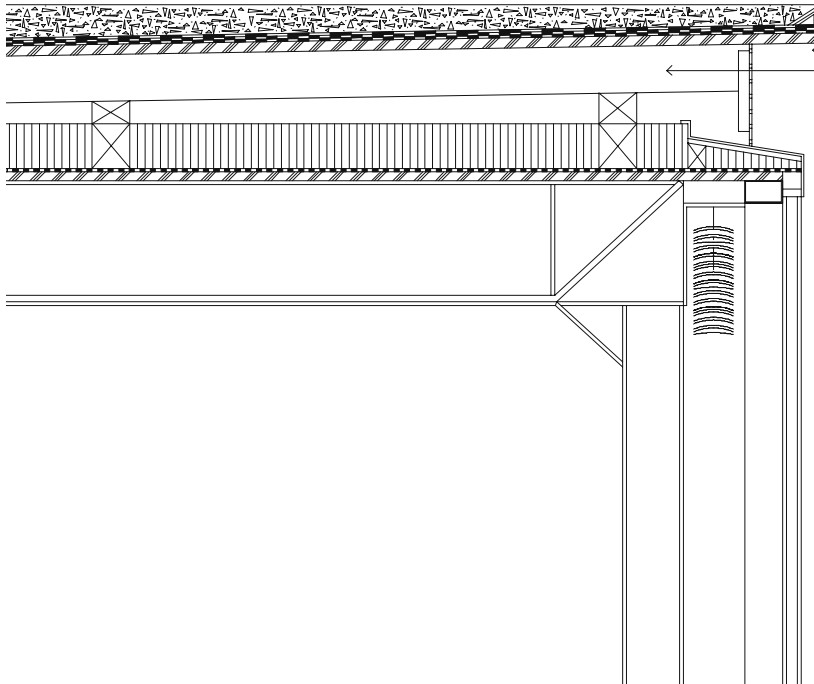
Roof, perimeter strip, with planting Section

## Flat roof – cold deck



Fig. 12: Gigon & Guyer: Kirchner Museum, Davos (CH), 1992

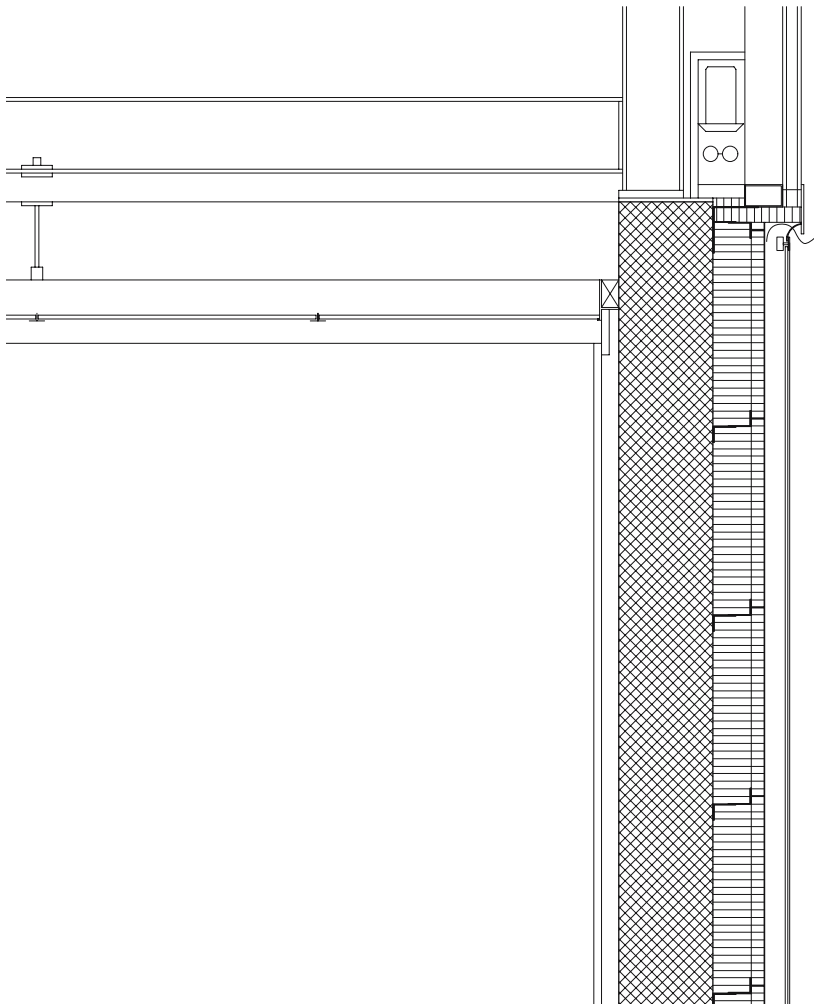


**Roof construction**

- Clear recycled glass 60 mm
- Protective mat 10 mm
- Roof finish: calendered polymeric roofing, 2 layers
- Timber boarding 27 mm
- Rafters, 100 x 120 mm 120 mm
- Timber sole plates, 100 x 120 mm 120 mm
- Insulation, e.g. rockwool 120 mm
- Vapour barrier
- Novophen board 25 mm
- Steel beam, IPE 330 330 mm
- Gypsum ceiling, white 15 mm

**Wall construction**

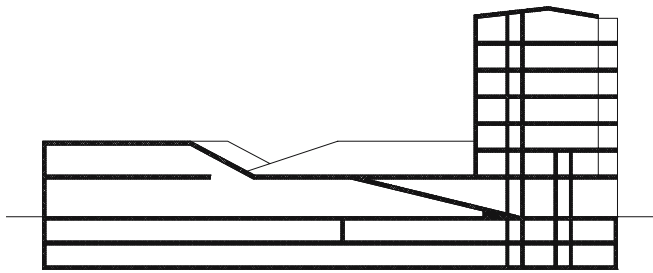
- Insulating glazing, extra-clear, acid-etched, "Silverstar" 2 x 6 mm
- Chromium-steel capping
- 2-part louvre blind
- Convectors, white, 70 x 100 mm 100 mm
- Steel stanchion, HEB 160 160 mm

**Wall construction, ventilated facade**

- Glass, spec. 33, hardened, acid-etched 6 mm
- Chromium-steel capping
- Ventilation cavity
- Supporting framework: aluminium sections, white, wood cement particleboard, white 35 mm
- Insulation, e.g. rockwool 100 mm
- Concrete 250 mm
- Fermacell boards on battens 15 mm
- Plaster with mineral paint finish



**Flat roof – upside-down roof**  
with rooftop planting



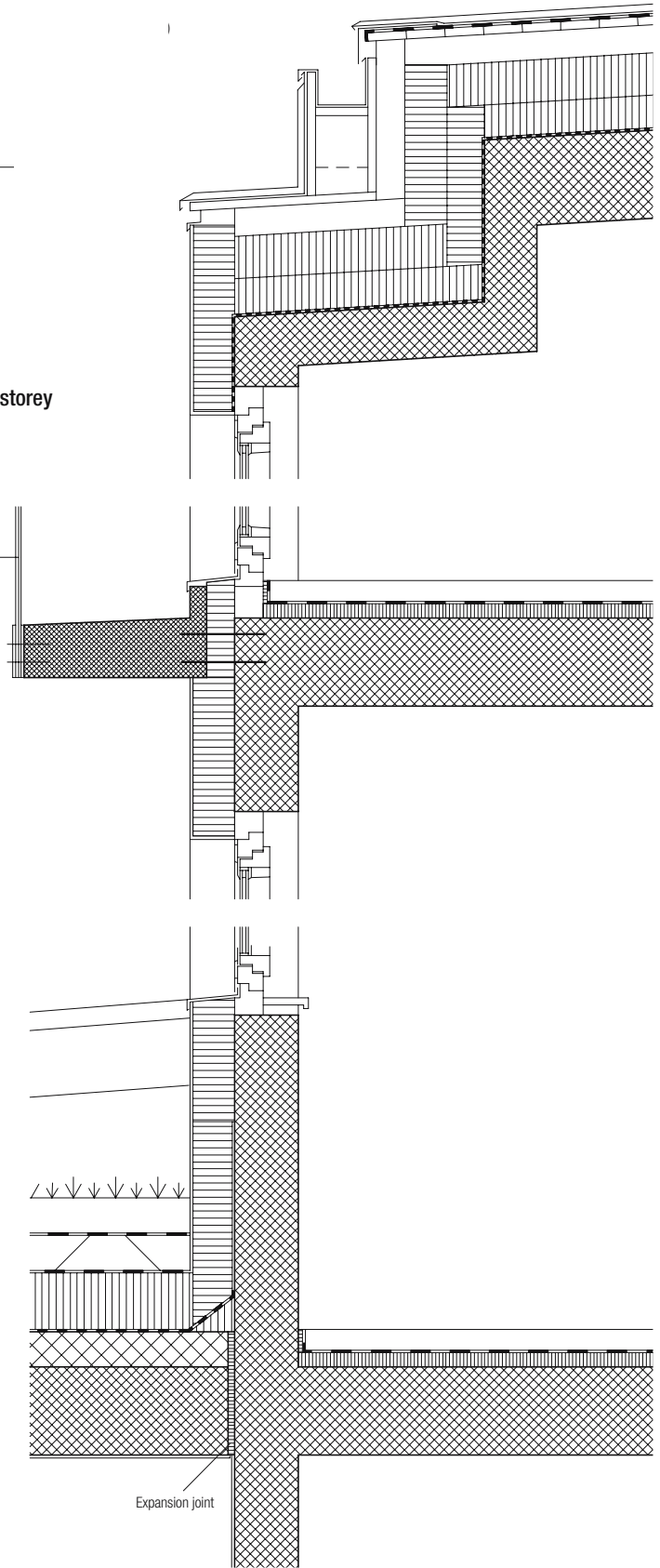
Section, 1:750



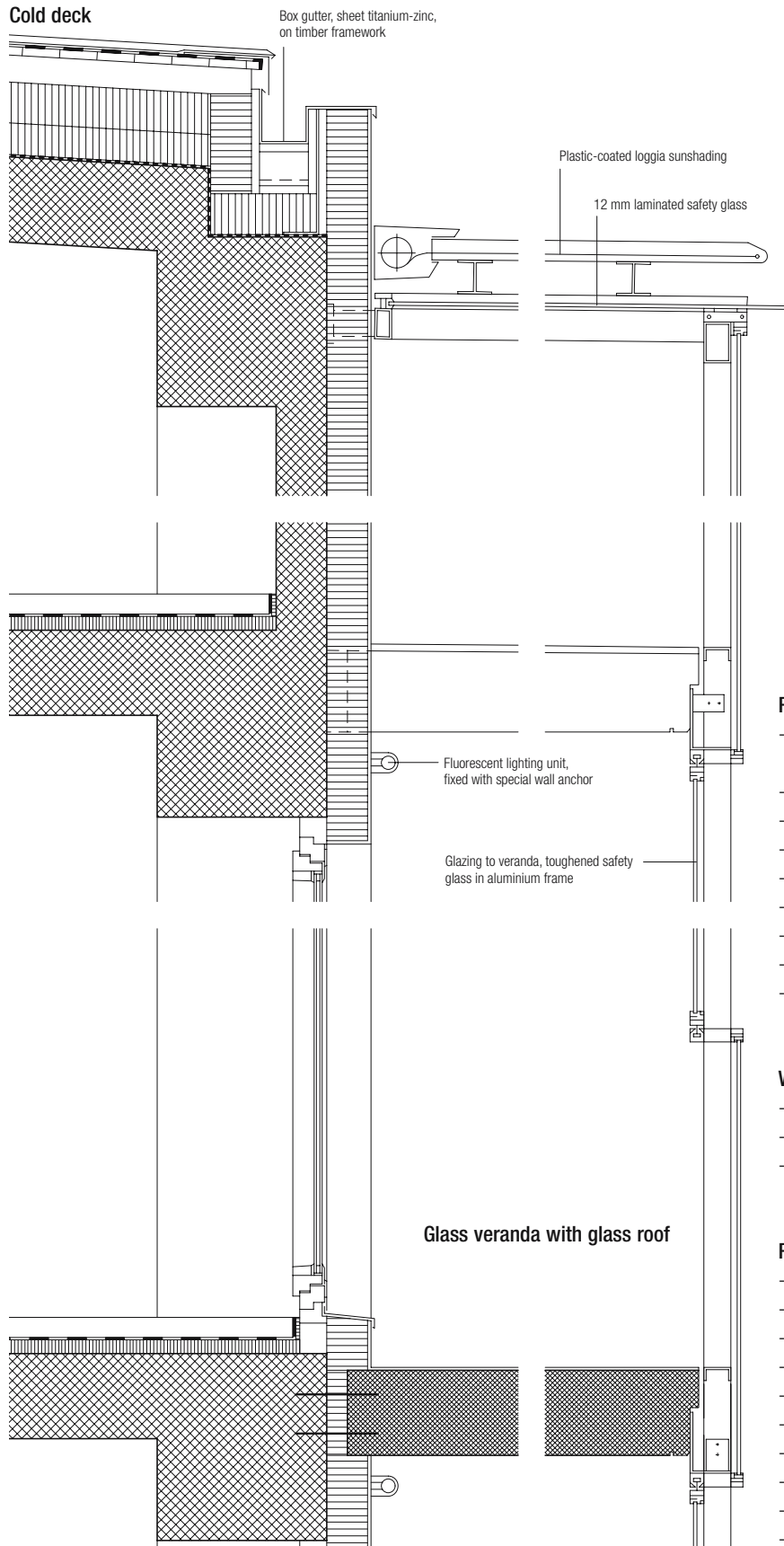
Fig. 13: Delugan & Meissl: mixed residential and office development, Vienna (A), 2001

Top storey

Safety barrier,  
16 mm laminated safety glass,  
rigid base fixing



Upside-down roof with  
rooftop planting



**Roof construction, cold deck**

- Sheet titanium-zinc  
(standing seam roof with sealing tape in seam)
- Separating layer
- Roof decking 24 mm
- Rafters, 50 x 280 mm 280 mm
- Ventilated cavity 80 mm
- Thermal insulation, mineral felt 120 mm
- Thermal insulation, mineral felt 100 mm
- Vapour barrier
- Reinforced concrete, plaster skim finish  
to soffit 250 mm

**Wall construction**

- Synthetic resin render 5 mm
- Thermal insulation, extruded polystyrene 120 mm
- Reinforced concrete, plaster skim finish  
internally 160 mm

**Roof construction, upside-down roof**

- Vegetation layer 100 mm
- Filter fleece
- Drainage layer 100 mm
- Filter fleece
- Thermal insulation, extruded polystyrene 160 mm
- Root barrier
- Bitumen roofing felt
- Screed laid to falls 40–150 mm
- Reinforced concrete slab 250 mm
- Plaster 10 mm

# APPENDIX

---

---

[Further reading](#)  
[Picture credits](#)  
[Index](#)  
[Thanks](#)

## Further reading

### I. Theory and history of design

- Centre Georges Pompidou (pub.): *L'art de l'ingénieur: constructeur, entrepreneur, inventeur*, Paris, 1997
- Edward R. Ford: *The Details of Modern Architecture I & II*, Cambridge, Mass., 1990; Basel, Boston, Berlin, 1994
- Kenneth Frampton: *Studies in Tectonic Culture*, Harvard, 1985
- Rainer Graefe (ed.): *Zur Geschichte des Konstruierens*, Stuttgart, 1989
- Hans Kollhoff (ed.): *Über Tektonik in der Baukunst*, Braunschweig, Wiesbaden, 1993
- Miron Mislin: *Geschichte der Baukonstruktion und Bautechnik*, vol. 1: *Antike bis Renaissance*, vol. 2: *Barock bis Neuzeit*, Düsseldorf, 1997
- Christian Norberg-Schulz: *Logik der Baukunst*, Bauwelt Fundamente, vol. 15, Berlin, 1965
- Gottfried Semper: *Style: Style in the Technical and Tectonic Arts; Or, Practical Aesthetics*, Harry Francis Mallgrave (ed.), Los Angeles, 2004
- Konrad Wachsmann: *The Turning Point in Building*, Stuttgart, 1989

### II. General design textbooks

- Oskar Büttner, Erhard Hampe: *Bauwerk Tragwerk Tragstruktur*, Berlin, 1985
- Heino Engel: *Tragsysteme*, Ostfildern-Ruit, 1997
- Ruedi Hungerbühler: *Konstruktion im Hochbau. Rohbauelemente, Montagebau, Aufbau*, Zürich, Dietikon, 1983
- Interkantoniales Lehrmittel Kollegium: *Konstruktionslehre Hochbau*, vol. 1 and vol. 2, Zürich, 2001
- Pier Luigi Nervi: *Neue Strukturen*, Stuttgart, 1963
- Ernst Neufert: *Bauentwurfslehre*, Braunschweig, Wiesbaden, 2002
- Dietrich Neumann, Ulrich Weinbrenner: *Frick/Knöll/Baukonstruktionslehre*, vol. 1, Stuttgart, Leipzig, Wiesbaden, 2002
- Dietrich Neumann, Ulrich Weinbrenner, Ulf Hestermann, Ludwig Rongen: *Frick/Knöll/Baukonstruktionslehre*, vol. 2, Stuttgart, Leipzig, Wiesbaden, 2003
- Heinz Ronner: *Baukonstruktion im Kontext des architektonischen Entwerfens. Decke, Boden*, Basel, 1991
- Heinz Ronner: *Baukonstruktion im Kontext des architektonischen Entwerfens. Haus, Dächer*, Basel, 1991
- Heinz Ronner: *Baukonstruktion im Kontext des architektonischen Entwerfens. Haus, Sockel*, Basel, 1991
- Heinz Ronner: *Baukonstruktion im Kontext des architektonischen Entwerfens. Öffnungen*, Basel, 1991
- Heinz Ronner: *Baukonstruktion im Kontext des architektonischen Entwerfens. Wand, Mauer*, Basel, 1991
- Heinz Ronner, Fredi Kölliker, Emil Rysler: *Baukonstruktion im Kontext des architektonischen Entwerfens. Zirkulation, Baustuktur, Zahn der Zeit*, Basel, 1994
- Arthur Rüegg, Swiss Federal Institute of Technology Chair of Architecture and Technology III+IV, current lecture manuscripts

- Heinrich Schmitt, Andreas Heene: *Hochbaukonstruktion. Die Bauteile und das Bauegefüge, Grundlagen des heutigen Bauens*, Wiesbaden, 2001
- René Vitton: *Bâtir – Manuel de la construction*, Lausanne, 1996
- Pierre Zoelly: *Terratektur – Einstieg in die unterirdische Architektur*, Basel, 1989

### III. Construction methods

- Joachim Achtziger, Günter Pfeifer, Rolf Ramcke, Konrad Zilch: *Masonry Construction Manual*, Basel, 2001
- David P. Billington: *Robert Maillart and the Art of Reinforced Concrete*, Cambridge, Mass., 1991
- Hans Busso von Busse, Nils Valerian Waubke, Rudolf Grimme, Jürgen Mertins: *Atlas Flache Dächer, Nutzbare Flächen*, Basel, 2000
- Cleo Baldon, Ib Melchior: *Steps & Stairways*, New York, 1989
- Gert Chesi: *Architektur und Mythos – Lehmbauten in Afrika*, Innsbruck, 1995
- August Ferdinand Fleischinger, W. A. Becker: *Die Mauer-Verbände. Klassische Vorlagenbücher für den Praktiker*, vol. 6, Hannover, 1993
- Karl-Heinz Götz, Dieter Hoor: *Holzbau Atlas*, Munich, 1978
- Wolfram Graubner: *Holzverbindungen – Gegenüberstellungen japanischer und europäischer Lösungen*, Stuttgart, 1986
- Friedrich Grimm: *Konstruieren mit Walzprofilen*, Berlin, 2003
- Herbert and Astrid Gruber: *Bauen mit Stroh*, Staufen i. Brsg., 2000
- Franz Hart, Walter Henn, Hansjürgen Sontag: *Stahlbau Atlas: Geschossbauten*, Munich, 1982
- Thomas Herzog, Roland Krippner, Werner Lang: *Facade Construction Manual*, Basel, 2004
- Friedbert Kind-Barkauskas, Bruno Kauhsen, Stefan Polónyi, Jörg Brandt: *Concrete Construction Manual*, Basel, 2002
- Ulrich Knaack: *Konstruktiver Glasbau*, Cologne, 1998
- Josef Kolb: *Systembau mit Holz*, Zürich, 1992
- Heinz W. Krewinkel: *Glass Buildings – Material, Structure and Detail*, Basel, 1998
- Julius Natterer, Thomas Herzog, Michael Volz, Wolfgang Winter: *Timber Construction Manual*, Basel, 2003
- Günter Pfeifer, Antje Liebers, Holger Reiners: *Der neue Holzbau*, Munich, 1998
- Andrew Plumridge, Wim Meulenkamp: *Brickwork: Architecture & Design*, New York, 1993
- Eckhard Reyer, Kai Schild, Stefan Völkner: *Kompendium der Dämmstoffe*, Stuttgart, 2002
- Christian Schittich, Dieter Balkow, Gerald Staib, Matthias Schuler, Werner Sobek: *Glass Construction Manual*, Basel, 1998
- Fritz Schumacher: *Das Wesen des neuzeitlichen Backsteinbaues*, Munich, 1985

- Helmut C. Schulitz, Werner Sobek, Karl Habermann: *Steel Construction Manual*, Basel, 2001
- Eberhard Schunck, Hans Jochen Oster, Rainer Barthel, Kurt Kiessl: *Roof Construction Manual – Pitched Roofs*, Basel, 2002
- Swiss School of Engineering for the Wood Industry: *Mehrgeschossiger Holzhausbau*, Biel, 1997
- John A. Templer: *The Staircase: Studies of Hazards, Falls, and Safer Design*, Cambridge, 1992
- René Walther: *Bauen mit Beton – Einführung für Architekten und Bauingenieure*, Berlin, 1997
- Michael Wigginton: *Glass in Architecture*, London, 2002
- Klaus Zwerger: *Wood and Wood Joints*, Basel, 1997



## Picture credits

## Introduction

- 12.2: Wolfgang Lauber (ed.): *Architektur der Dogon – Traditioneller Lehm- und Kunst der Mali*, Prestel Verlag, Munich, 1998, p. 58.  
Photo: Wolfgang Lauber.
- 12.3: Joachim Achtziger, Günter Pfeifer, Rolf Ramcke, Konrad Zilch: *Masonry Construction Manual*, Birkhäuser Publishers, Basel, 2001, p. 30.  
Photo: Ulrike Enders.
- 12.4: Source unknown
- 12.5: Source unknown
- 12.6: Annegret Burg: *Kollhoff – Architekten Kollhoff und Timmermann*, Birkhäuser Publishers, Basel, 1998, p. 63. Photo: Schwendinger & Büttner.

## MATERIALS – MODULES

## Masonry

- 23.1: Ekkehard Mai (ed.): *Das Capriccio als Kunstprinzip*, SKIRA Verlag, Milan, 1996.
- 24.2–24.5: Photo: Ákos Moravánszky.
- 25.6: *Detail*, No. 1/2. Munich, 2002, p. 30.
- 25.7–26.11: Photo: Ákos Moravánszky.
- 27.12: *SITE: Architecture as Art*, Academy Editions, London, 1980, p. 36. Photo: SITE, courtesy Ronald Feldman Fine Arts, New York.
- 27.13: Photo: Ákos Moravánszky.
- 27.14: John Wilton-Ely: *Giovanni Battista Piranesi – Vision und Werk*, Hirmer Verlag, Munich, 1978, p. 62.
- 27.15: Photo: Ákos Moravánszky.
- 28.16: Werner Lindner, Friedrich Tamms: *Mauerwerk*, Alfred Metzner Verlag, Berlin, 1938, p. 132.
- 28.17–30.21: Photo: Ákos Moravánszky.
- 30.22: *Detail*, No. 1/2. Munich, 2002, p. 38.
- 30.23: Photo: Ákos Moravánszky.
- 30.24: Eladio Dieste: *La Estructura Cerámica*. Bogotá, 1987, p. 132, Fig. 14.
- 31.25–31.26: Photo: Ákos Moravánszky.
- 32.27: Source unknown
- 32.28–30: Photo: Stahlton AG, Zürich.
- 33–34.31: Swiss Brickmaking Association: *Clay Products*, Zürich, 1998, p. 3–8.
- 35.32: Andrew Plumridge, Wim Meulenkamp: *Brickwork: Architecture & Design*, New York, 1993, p. 83.
- 35.33: Joachim Achtziger, Günter Pfeifer, Rolf Ramcke, Konrad Zilch: *Masonry Construction Manual*, Birkhäuser Publishers, Basel, 2001, p. 79.
- 36.34–35: Prof. Deplazes. Graphic: Maud Châtelet.
- 38.36: Werner Blaser: *Mies van der Rohe – Die Kunst der Struktur*, Artemis Verlag, Zürich, 1996, p. 20/21.
- 39.37–40.43: Prof. Deplazes.  
Graphic: Barbara Wiskemann.
- 40.44: Andrew Plumridge, Wim Meulenkamp: *Brickwork: Architecture & Design*, New York, 1993, p. 81.
- 40.45: Annegret Burg: *Kollhoff – Architekten Kollhoff und Timmermann*, Birkhäuser Publishers, Basel, 1998, p. 92.
- 40.46: Prof. Deplazes.
- 40.47: Joachim Achtziger, Günter Pfeifer, Rolf Ramcke, Konrad Zilch: *Masonry Construction Manual*, Birkhäuser Publishers, Basel, 2001, p. 39.  
Photo: Rolf Ramcke.
- 41.48–50: Prof. Deplazes. Graphic: Barbara Wiskemann.
- 41.51: Andrew Plumridge, Wim Meulenkamp: *Brickwork: Architecture & Design*, New York, 1993, p. 86.
- 41.52: August Ferdinand Fleischinger, W. A. Becker: *Die Mauer-Verbände. Klassische Vorlagenbücher für den Praktiker*, vol. 6, Verlag Th. Schäfer, Hannover, 1993, pl. 2. Photo: August Ferdinand Fleischinger, W. A. Becker.
- 41.53–54: Joachim Achtziger, Günter Pfeifer, Rolf Ramcke, Konrad Zilch: *Masonry Construction Manual*, Birkhäuser Publishers, Basel, 2001, p. 101, p. 35.
- 42.55–57: Keller AG brickworks, catalogue: *Wall ties*, 9/98. Pfungen, 1998, p. 6 and p. 1.
- 42.58 left and right: Keller AG brickworks, catalogue: *Wall ties*, 9/99. Pfungen, 1999, p. 1.
- 43.59: Source unknown
- 43.60: Source unknown
- 44.61: Maija Holma, Markku Lahti: *Alvar Aalto – eine sensiblere Struktur für das Leben*, Rakennustieto Oy, Helsinki, 1996, p. 85. Photo: Maija Holma.
- 45.62: Fritz Schumacher: *Das Wesen des neuzeitlichen Backsteinbaues*, Callwey Verlag, Munich, 1985, p. 103.
- 45.63: Photo: Hild und K Architekten, Munich.
- 46.64: Piergiacomo Bucciarelli: *Fritz Höger: hanseatischer Baumeister, 1877–1949*, Vice Versa Verlag, Berlin, 1992, p. 41.
- 46.65: Wilfried Wang: *Architect Sigurd Lewerentz*, Arkitekturmuseet Archivet Stockholm. Buggförlaget, 1997, vol. 1, photos of the work, p. 168. Photo: Fabio Galli.
- 47.66: Heinz Ronner: *Wand, Mauer*, Birkhäuser Publishers, Basel, 1991, p. 49.
- 47.67: Wolfgang Voigt (ed.): *Heinz Bienefeld, 1926–1995*, vol. 3, Deutsches Architektur Museum, exhibition catalogue. Frankfurt a. M., 1999, p. 100.  
Photo: Lukas Roth.
- 48.68: Photo: Ralph Feiner.
- 48.69: Annegret Burg: *Kollhoff – Architekten Kollhoff und Timmermann*, Birkhäuser Publishers, Basel, 1998, p. 82. Photo: Heinrich Helfenstein.
- 48.70: Alejandro de la Sota: *Alejandro de la Sota Architect*, Ediciones Pronaos, Madrid, 1989, p. 35.  
Photo: Alejandro de la Sota.
- 49.71 left and right: Benedetto Gravagnuolo: *Adolf Loos – Theory and Works*, Löcker Verlag, Vienna, 1982, p. 195.
- 49.72 top: H. Allen Brooks: *The Le Corbusier Archive: Le Corbusier*. Ahmedabad, 1953–1960, Le Corbusier Foundation, Paris, 1983, p. 118.

- 49.72 bottom: Willy Boesiger: *Le Corbusier + Son Atelier Rue De Sevres 35 – Œuvre Complète*, 1952–57, Editions Girsberger. Zürich, 1957, p. 116.
- 50.73: Joachim Driller: *Marcel Breuer: Die Wohnhäuser 1923–1973*, Deutsche Verlags-Anstalt. Munich, 1998, p. 155.
- 50.74: David Masello: *Marcel Breuer & Herbert Beckhard – Die Landhäuser, 1945–1984*, Birkhäuser Publishers. Basel, 1996, p. 14. Photo: Museum of Modern Art, N.Y.
- 51.75 left and right: Jonas Geist: *Karl Friedrich Schinkel – Die Bauakademie. Eine Vergegenwärtigung*, S. Fischer Verlag. Frankfurt a. M., 1993, p. 53 and p. 40.
- 52.76–77: Keller AG brickworks, Pfungen, catalogue: *preton-Wandelemente*, Merkur Druck. Langental, 2000.
- 53.78: Burkard, Meyer & Partner, Baden. Photo: Reinhard Zimmermann.
- 53.79–80: Burkard, Meyer & Partner, Baden.
- 53.81: Burkard, Meyer & Partner, Baden. Graphic: preton, Wandelemente.
- 54.82–83: Hans Kollhoff.
- 55.84: Peter Nigst (ed.): *Rafael Moneo. Bauen für die Stadt*, Gerd Hatje Verlag. Stuttgart, 1993, p. 51. Photo: Rafael Moneo.
- 55.85 left: *El Croquis*, Nos 19–22, El Croquis Editorial. Madrid, 1985, p. 108.
- 55.85 right: Luis Fernandez-Galiano (ed.): *A&V Monografias de Arquitectura y Vivienda*, No. 36. Madrid, 1992, p. 9.
- 55.86: Photo: Rafael Moneo.
- Concrete**
- 56.1: James Gilchrist Wilson: *Sichtflächen des Betons*, Bauverlag. Wiesbaden-Berlin, 1967, p. 41.
- 57.2: Philip Jodidio: *Tadao Ando*, Taschen-Verlag. Cologne, 1997, p. 68. Photo: Tomio Ohashi.
- 58.3: Thomas Boga: *Die Architektur von Rudolf Olgiati*, gta Verlag. Zürich, 1977, p. 181.
- 59.4: Centre Georges Pompidou (ed.): *L'art de l'ingénieur: constructeur, entrepreneur, inventeur*, Editions du Centre Georges Pompidou. Paris, 1997, p. 80.
- 59.5: Hazan Institut Français d'Architecture: *Le Béton en représentation*, Editions Hazan. Paris, 1993, p. 136. Photo: A. Jesta, Gênes, épreuve 28 x 23 cm. © Fonds Perret (535 AP) et Hennebique (761 fa).
- 59.6: Potsdam Astrophysical Institute: *Der Einsteinturm in Potsdam – Architektur und Astrophysik*. Ars Nicolai. Berlin, 1995, p. 101.
- 60.7: W. Schrämli: *Beton-Praxis: der Weg zum dauerhaften Beton*, HOLCIM (Schweiz) AG. Zürich, 1997, p. 24.
- 61.8–11: Loco citato, p. 14.
- 62.12: Loco citato, p. 15.
- 63.13: René Walther: *Bauen mit Beton – Einführung für Architekten und Bauingenieure*, Ernst und Sohn Verlag. Berlin, 1997, p. 125.
- 63.14: Photo: Holzco-Doka Schalungstechnik, Niderhasli.
- 63.15: René Walther: Loco citato, p. 121.
- 64.16–17: Roland Schmitt: *Die Schalungstechnik – Systeme, Einsatz und Logistik*, Ernst und Sohn Verlag. Berlin, 2001, p. 266 and p. 512.
- 65.18: W. Schrämli: *Beton-Praxis: der Weg zum dauerhaften Beton*, HOLCIM (Schweiz) AG. Zürich, 1997, p. 47.
- 65.19–20: Prof. Deplazes. Graphic: Maud Châtelet.
- 66.21: Technical Research & Advice Centre of the Swiss Cement Industry: *Cement Bulletin*, No. 16. Wildeg, 1987.
- 67.22: Rudolf Olgiati: *Eine Streitschrift*, Verlag Magazin + Buch. Stuttgart, 1994, p. 26. Photo: Judith M. Gieshuber.
- 67.23: Friedbert Kind-Barkauskas, Bruno Kauhsen, Stefan Polónyi, Jörg Brandt: *Concrete Construction Manual*, Birkhäuser Publishers. Basel, 2002, p. 193. Photo: Christian Schittich.
- 68.24–25: James G. Wilson: *Sichtflächen des Betons*, Bauverlag. Wiesbaden-Berlin, 1967, p. 45.
- 68.26: David Bruce Brownlee, David G. De Long: *Louis I. Kahn – In the Realm of Architecture*, The Museum of Contemporary Art. Los Angeles, 1991, pp. 182–83. Photo: Grant Mudford.
- 68.27: Günter Rapp: *Technik des Sichtbetons*, Beton-Verlag. Düsseldorf, 1969, p. 21. © Verlag Bau und Technik.
- 68.28: Loco citato, p. 216.
- 68.29: Loco citato, p. 226.
- 69.30: Prof. Keller, Faculty of Building Physics, Swiss Federal Institute of Technology, Zürich.
- 69.31: Prof. Deplazes. Photo: Thomas Melliger.
- 69.32: Prof. Keller, Faculty of Building Physics, Swiss Federal Institute of Technology, Zürich.
- 69.33: Photo: Schöck-ebea AG, Aarau.
- 69.34–35: Graphic: Aschwanden AG, Lyss.
- 69.36: Prof. Keller, Faculty of Building Physics, Swiss Federal Institute of Technology, Zürich.
- 69.37–71.40: Prof. Deplazes. Graphic: Thomas Melliger.
- 70.41–42: Graphic: Halfen Deha, Dällikon.
- 70.43 Photos: Elemente AG, Vellheim.
- 71.44–47: Prof. Deplazes. Graphic: Thomas Melliger.
- 71.48: Graphic: Halfen Deha, Dällikon.
- 71.49: Prof. Deplazes. Photos: Thomas Melliger.
- 72.50: Prof. Deplazes.
- 73.51: René Walther: *Bauen mit Beton – Einführung für Architekten und Bauingenieure*, Ernst und Sohn Verlag. Berlin, 1997, p. 140.
- 73.52: Friedbert Kind-Barkauskas, Bruno Kauhsen, Stefan Polónyi, Jörg Brandt: *Concrete Construction Manual*, Birkhäuser Publishers, 2002, p. 271.
- 73.53: Loco citato, p. 60.
- 73.54: Loco citato, p. 206.
- 74.55: René Walther: *Bauen mit Beton – Einführung für Architekten und Bauingenieure*, Ernst und Sohn Verlag. Berlin, 1997, p. 309.
- 74.56: Loco citato, p. 181.
- 74.57: Institut Français D'Architecture (ed.): *Les Frères Perret*, Editions Norma. Paris, 2000, p. 94. © Auguste Perret, UFSE, SAIF, 2004.
- 74.58: Herman Hertzberger: *Lessons for Students in Architecture*, 010 Publishers. Rotterdam, 1998, p. 128. Photo: Jan Versnel.
- 75.59–61: Heino Engel: *Tragsysteme*, Hatje Verlag. Ostfildern-Ruit, 1997, p. 207.

- 75.62: Otto Künzle: *Tragkonstruktionen IV. Sommersemester 2. Jahreskurs – Stahlbeton*, Faculty of Architecture, Swiss Federal Institute of Technology, Zürich, p. 138.
- 75.63: Friedbert Kind-Barkauskas, Bruno Kauhsen, Stefan Polónyi, Jörg Brandt: *Concrete Construction Manual*, Birkhäuser Publishers. Basel 2002, p. 21.
- 75.64: Johann Christoph Bürkle: *Morger & Degelo Architekten*, Niggli Verlag. Sulgen, 2000, p. 141. Photo: Michael Fontana.
- 76.65–66: René Walther: *Bauen mit Beton – Einführung für Architekten und Bauingenieure*, Ernst und Sohn Verlag. Berlin, 1997, p. 251.
- 76.67: Loco citato, p. 253.
- 76.68: Christoph Luchsinger: *Hans Hofmann – vom Neuen Bauen zur neuen Baukunst*, gta Verlag. Zürich, 1985, p. 112.
- 76.69: David P. Billington: *Robert Maillart and the Art of Reinforced Concrete*, Cambridge, Mass., 1991, p. 105.
- 76.70: Ekkehard Ramm, E. Schunck, (eds.): *Heinz Isler – Schalen*. Exhibition Catalogue, Gesellschaft für Ingenieurbaukunst, Swiss Federal Institute of Technology, Zürich, 2002, p. 61. © Gesellschaft für Ingenieurbaukunst.
- 76.71: René Walther: Loco citato, p. 262.
- Timber**
- 78.1, 80.2: Bearth + Deplazes. Photo: Timo Allemann.
- 80.3: Josef Kolb: *Systembau mit Holz*, Baufachverlag. Zürich, 1992, p. 23.
- 81.4–5: Bearth + Deplazes.
- 82.6: Lignum, Swiss Timber Study Group, Zürich.
- 83.7: Prof. Deplazes. Graphic: Maud Châtelet.
- 83.8: Prof. Deplazes.
- 83.9: Prof. Deplazes. Graphic: Maud Châtelet.
- 83.10–11: Swiss standard SIA 265/1: Holzbau: Schnittarten. 4.2262 Kantholz und Latten, Schweizer Ingenieur- und Architektenverein. Zürich, p. 52.
- 84.12: Photos: Lignum, Swiss Timber Study Group, catalogue: *Lignatec 10/2000. Holzfaserprodukte*. Zürich, 2000, p. 4.
- 85.13: Karl-Heinz Götz, Dieter Hoor: *Holzba Atlas*, Institut für internationale Architektur-Dokumentation. Munich, 1978, p. 21.
- 85.14: Prof. Deplazes. Graphic: Daniel Gut.
- 85.15: Karl-Heinz Götz, Dieter Hoor, Loco citato.
- 86.16: Günter Pfeifer, Antje Liebers, Holger Reiners: *Der neue Holzbau*, Callwey Verlag. Munich, 1998, p. 15.
- 86.17: Prof. Deplazes. Graphic: Maud Châtelet.
- 86.18: Günter Pfeifer, Antje Liebers, Holger Reiners: *Der neue Holzbau*, Callwey Verlag. Munich, 1998, p. 19.
- 86.19: *Detail*, No. 1. Munich, 2001, p. 94.
- 87.20 top: Günter Pfeifer, Antje Liebers, Holger Reiners: *Der neue Holzbau*, Callwey Verlag. Munich, 1998, p. 24.
- 87.20 bottom: Photo: Boromir Radovic.
- 87.21–22: *Detail*, No. 1. Munich, 2001, p. 97. Photo: Borimir Radovic.
- 88.23: Günter Pfeifer, Antje Liebers, Holger Reiners: *Der neue Holzbau*, Callwey Verlag. Munich, 1998, p. 26.
- 88.24: Pavatex Gmbh, Leutkirch.
- 88.25: Günter Pfeifer, Antje Liebers, Holger Reiners: *Der neue Holzbau*, Callwey Verlag. Munich, 1998, p. 26.
- 89.26: Prof. Deplazes. Graphic: Maud Châtelet.
- 89.27: Finnforest Merk Dickholz GmbH, catalogue: *LenoTec-Massivbau*. Aichach, 2001, p. 15.
- 90.28: Pius Schuler AG, Rothenturm: Wood Industry Catalogue, p. 159.
- 90.29–30: Tschopp Holzbau: *BRESTA catalogue*. Hochdorf.
- 91.31: Prof. Deplazes. Graphic: Maud Châtelet.
- 91.32: Ligu, das Holzbaulement, Kirchlinteln.
- 92.33–34: Lignatur AG, Waldstatt.
- 93.35: STEKO Holzbausysteme AG, Uttwil, Catalogue: *STEKO – Systembeschreibung, Planung, Konstruktion*, Kesswil.
- 94.36: Finnforest Merk Dickholz GmbH, Catalogue: *LenoTec-Bausystem*, Aichbach, 2001, p. 12.
- 94.37: Woodwelding SA, Zürich.
- 95.38: Prof. Deplazes. Graphic: Daniel Gut.
- 96.39–41: Josef Kolb: *Systembau mit Holz*, Baufachverlag. Zürich, 1992, p. 15.
- 97.42: Prof. Deplazes. Graphic: Daniel Gut.
- 98.43–44: Josef Kolb: Loco citato, p. 15.
- 99.45: Bearth + Deplazes.
- 99.46: Josef Kolb: Loco citato, p. 80.
- 99.47: Bearth + Deplazes.
- 100.48: Holzforum, Bern.
- 100.49–50: Prof. Deplazes. Graphic: Daniel Gut.
- 102.51: Bearth + Deplazes.
- 103.52: Prof. Deplazes.
- 104.53–58: Christoph Henrichsen: “Die Werkstätten am Grossschrein von Ise”, in: *Detail*, No. 10. Munich, 2002, p. 1285 and p. 1288.
- 106.59: Reyner Banham, Hiroyuki Suzuki: *Modernes Bauen in Japan*, Deutsche Verlags-Anstalt. Stuttgart, 1987, p. 109.
- 106.60: Photo: Website. No longer available.
- 107.61: Reyner Banham, Hiroyuki Suzuki: *Modernes Bauen in Japan*, Deutsche Verlags-Anstalt. Stuttgart, 1987, p. 109.
- 107.62 top and bottom: Arthur Drexler: *The Architecture of Japan*, The Museum of Modern Art. New York, 1944, p. 18.
- 108.63: Urs Meister: “Die Fäden des Netzes”, in: *tec21*, No. 21. Zürich, 2001, p. 19. Photo: Urs Meister.
- 108.64–65: Wolfram Graubner: *Holzverbindungen – Gegenüberstellungen japanischer und europäischer Lösungen*, Deutsche Verlags-Anstalt. Stuttgart, 1984, p. 71 and p. 43.
- 109.66: Urs Meister: “Die Fäden des Netzes”, in: *tec21*, No. 21. Zürich, 2001, p. 24. Photo: Urs Meister.

- 109.67: Arthur Drexler: *The Architecture of Japan*, The Museum of Modern Art. New York, 1944, p. 84.
- 109.68: Klaus Zwerger: *Wood and Wood Joints*, Birkhäuser Publishers. Basel, 1997, p. 146.  
Photo: Bunhazai Kenzo, Butsu Hozon Gi, Jiutsu Kyshai.
- 110.69: Reyner Banham, Hiroyuki Suzuki: *Modernes Bauen in Japan*, Deutsche Verlags-Anstalt. Stuttgart, 1987, p. 108.
- 110.70: Arthur Drexler: *The Architecture of Japan*, The Museum of Modern Art. New York, 1944, p. 67.
- 110.71: Urs Meister: "Die Fäden des Netzes", in: *tec21*, No. 21. Zürich, 2001, p. 25.
- 111.72: Loco citato, p. 23. Photo: Urs Meister.
- 111.73: Arthur Drexler: *The Architecture of Japan*, The Museum of Modern Art. New York, 1944, p. 149.
- 111.74: Leaflet from the Schaffhausen New Art Gallery, Raussmüller Collection. Basel. Setting: Carl Andre: Shiloh, 1980, 91 x 563 x 563 cm, courtesy Raussmüller Collection.
- 112.75–76: Photo: Urs Meister.
- Steel**
- 113.1: *tec21*, No. 23. Zürich, 2003, p. 14.  
Photo: Georg Aerni.
- 113.2: *Archithese*, No. 6, Niggli Verlag. Sulgen, 1994, p. 70. Photo: Hans Ruedi Disch.
- 114.3: Helmut C. Schulitz, Werner Sobek, Karl Habermann: *Steel Construction Manual*, Birkhäuser Publishers. Basel, 2001, p. 47. Photo: Deutsches Museum, Munich.
- 114.4: Loco citato, p. 27. Photo: Bavaria State Library, Munich.
- 114.5: Roland Rohn, Swiss Steel Association (pub.): *Bauen in Stahl*, Swiss Steel Association. Zürich, 1956, p. 200.
- 115.6: Hans Frei: *Louis Henry Sullivan*, Artemis Verlag. Zürich, 1992, p. 127.
- 115.7: Cocoon Vision AG, Basel.
- 115.8: Manfred Sack: *Richard Neutra*, Studio Paperback. Birkhäuser Publishers, 1994, p. 38.
- 116.9: Johann Christoph Bürkle: *Wohnhäuser der klassischen Moderne*, Deutsche Verlags-Anstalt. Stuttgart, 1994, p. 100.
- 116.10: Loco citato, p. 101.
- 116.11: Anatxu Zabalbeascoa: *Houses of the Century*, Editorial Gustavo Gili. Barcelona, 1998, p. 100.  
Photo: Scot Frances.
- 116.12: Maurice Besset: *Le Corbusier*, Skira Verlag. Geneva, 1987, p. 155.
- 117.13: Swiss Steel Association (ed.): *Bauen in Stahl*, Swiss Steel Building Centre. Zürich, 1956, p. 291.
- 117.14–15: Laurence Allégret, V. Vaudou: *Jean Prouvé et Paris*, Editions du Pavillon de l'Arsenal. Paris, 2001, p. 282 and p. 283.
- 117.16: Helmut C. Schulitz, Werner Sobek, Karl Habermann: *Steel Construction Manual*, Birkhäuser Publishers. Basel, 2001, p. 269. (Original: Solothurn Art Society [ed.]: *Fritz Haller – Bauen und Forschen*. Solothurn, 1988). Photo: Christian Moser.
- 118.17–18: Coosje van Bruggen, Frank O. Gehry: *Guggenheim Museum Bilbao*, Guggenheim Museum Publications. New York, 2000, title page and p. 159.
- 119.19–20: Photo: Christian Richters.
- 119.21: Bell-Pottinger, London. Photo: Nigel Young
- 120.22: Friedrich Grimm: *Konstruieren mit Walzprofilen*, Ernst und Sohn Verlag. Berlin, 2003, p. 9.
- 121.23–123.30: Prof. Deplazes. Graphic: Alois Diethelm.
- 123.31: Swiss Central Office for Structural Steelwork (SZS), draft, 9 June 2004.
- 124.32: Prof. Deplazes. Graphic: Alois Diethelm.
- 125.33–34: Swiss Central Office for Structural Steelwork (SZS), Manual: *C8 – Konstruktive Details im Stahlhochbau*. Zürich, 1973.
- 126.35–36: Prof. Deplazes. Graphic: Alois Diethelm.
- 127.37: Tuchs Schmid Engineering AG, Nüssli Special Events AG, JAKEM AG (ed.), brochure: *Monolith – Augenblick und Ewigkeit*, 2002.
- 127.38: Franz Hart, Walter Henn, Hansjürgen Sontag: *Stahlbau Atlas: Geschossbauten*. Institut für internationale Architektur-Dokumentation. Munich, 1982, p. 274 and p. 276.
- 128.39–40: Prof. Deplazes. Graphic: Alois Diethelm.
- 129.41–44: Friedrich Grimm: *Konstruieren mit Walzprofilen*. Ernst und Sohn Verlag. Berlin, 2003, p. 55 and p. 86.
- 130.45–46: Prof. Deplazes. Graphic: Alois Diethelm.
- 131.47: Friedrich Grimm: *Konstruieren mit Walzprofilen*, Ernst und Sohn Verlag. Berlin, 2003, p. 84.
- 131.48–49: Loco citato, p. 81.
- 131.50: Loco citato, p. 80.
- 132.51: Prof. Deplazes.
- 133.52: *Detail*, No. 4. Munich, 1999, p. 626.
- 133.53–55: Laurence Allégret, V. Vaudou: *Jean Prouvé et Paris*, Editions du Pavillon de l'Arsenal. Paris, 2001, p. 195 and p. 262. Photo: Centre Pompidou.
- 133.56: Loco citato, p. 153.
- 134.57–58: *Werk, Bauen & Wohnen*, No. 11. Zürich, 2000, p. 32.
- 134.59: *Architektur Aktuell*, 230/231. Springer Verlag. Vienna, 1999, p. 124. Photo: Georg Marterer.
- 134.60: Loco citato, p. 56. Photo: Philippe Ruault.
- 135.61: Esther McCoy, Peter J. Blake: *Craig Ellwood*, Hennessey & Ingalls. Santa Monica, 1997, p. 99 and p. 101.
- 135.62: Gerhard Mack: *Herzog & de Meuron, 1989–1991*, vol. 2, Birkhäuser Publishers. Basel, 1991, p. 25.
- 135.63: Richard Levene, Fernando Márquez Cecilia: *El Croquis 86*, El Croquis Editorial. Madrid, 1998, p. 87.
- 135.64: Esther McCoy, Peter J. Blake: *Craig Ellwood*, Hennessey & Ingalls. Santa Monica, 1997, p. 99 and p. 101.



- 135.65: Gerhard Mack: *Herzog & de Meuron, 1989–1991*, vol. 2, Birkhäuser Publishers. Basel, 1991, p. 16.
- 135.66: Richard Levene, Fernando Márquez Cecilia: *El Croquis 86*, El Croquis Editorial. Madrid, 1998, p. 75. Photo: Hisao Suzuki.
- 136.67: Helmut C. Schulitz, Werner Sobek, Karl Haberman: *Steel Construction Manual*, Birkhäuser Publishers. Basel, 2001, p. 129.
- 136.68–69: Deyan Sudjic: *Norman Foster, Richard Rogers, James Stirling*, Thames and Hudson. London, 1986, p. 100 and p. 101. Photo: Richard Bryant.
- 136.70: Heinz W. Krewinkel: *Glass Buildings – Material, Structure and Detail*, Birkhäuser Publishers. Basel, 1998, p. 27.
- 136.71: Oskar Büttner, Erhard Hampe: *Bauwerk, Tragwerk, Tragstruktur*, Ernst und Sohn Verlag. Berlin, 1985, p. 263.
- 137.72 a and b: *Detail*, No. 7. Munich, 2001, p. 1267 and p. 1277.
- 137.73: Internet: Source no longer available.
- 137.74: Norman Foster: *Foster Catalogue*, 2001, Prestel Verlag. Munich, 2001, p. 96.
- 137.75: Rainer Graefe (ed.): *Vladimir G. Suchoy, 1853–1939. Die Kunst der sparsamen Konstruktion*, Deutsche Verlags-Anstalt. Stuttgart, 1990, p. 97.
- 138.76 a: "Pier Luigi Nervi" in: *Process Architecture*, No. 23. Tokyo, 1981, p. 100.
- 138.76 b: Loco citato, p. 103.
- 138.77: Helmut C. Schulitz, Werner Sobek, Karl Haberman: *Steel Construction Manual*, Birkhäuser Publishers. Basel, 2001, p. 326. Photo: Richard Bryant.
- 138.78: *A&V Monografias de Arquitectura y Vivienda*, No. 36. Madrid, 1992, p. 44.
- 138.79: Kenneth Powell: *Stansted – Norman Foster & the Architecture of Flight*, A Blueprint Monograph, Fourth Estate. London, 1992, p. 76 and p. 77. Photo: Richard Bryant, Philip Sayer.
- 138.80: *A&V Monografias de Arquitectura y Vivienda*, No. 36. Madrid, 1992, p. 48.
- 143.10–11: Prof. Deplazes.
- 143.12: Prof. Deplazes. Graphic: Maud Châtelet.
- 144.13: Saint-Gobain Isover Austria AG, Stockerau.
- 144.14: Deutsche Foamglas GmbH, Haan.
- 144.15: Styrofoam, Berlin.
- 144.16: Pavatex GmbH, Leutkirch.
- 144.17: Deutsche Rockwool, Gladbeck.
- 144.18: Styropor (BASF), Ludwigshafen.
- 144.19: Swisspor AG, Steinhausen.
- 144.20: Isofloc AG, Bütschwil.
- 144–145.21: Eckhard Reyer, Kai Schild, Stefan Völkner: *Kompendium der Dämmstoffe*, Fraunhofer IRB Verlag. Stuttgart, 2002.
- 146.22–23: Prof. Deplazes.

### Glass

- 147.1–2: Sigmar Spauszus, Jürgen D. Schnapp: *Glas allgemeinverständlich – eine Einführung in Theorie und Praxis*, VEB Fachbuchverlag. Leipzig, 1977.
- 148.3: Bregenz Art Gallery (ed.): *Nachtwallfahrtskapelle Locherboden*, Hatje Cantz Verlag. Stuttgart, 1997, p. 67.
- 148.4: Michael Wigginton: *Glass in Architecture*, London, 2002, p. 53.
- 148.5: Rolf Toman (ed.): *Die Kunst der Gotik*, Könemann Verlag. Cologne, 1998, p. 85. Photo: Achim Bednorz.
- 149.6: Ulrich Knaack: *Konstruktiver Glasbau*, Rudolf Müller Verlag. Cologne, 1998, p. 51.
- 149.7: Jeannine Fiedler, Peter Feierabend: *Bauhaus*, Könemann Verlag. Cologne, 1999, p. 222. Photo: Markus Hawlik/Bauhaus Archive Berlin.
- 150.8: Thomas L. Schumacher: *Il Danteum di Terragni*, . . . Officina Edizioni. Rome, 1980.
- 150.9: Ulrich Knaack: *Konstruktiver Glasbau*, Rudolf Müller Verlag. Cologne, 1998, p. 20.

### ELEMENTS

#### Foundation – Plinth

- 139.1: Prof. Deplazes.
- 139.2 top and bottom: Lucerne Architecture Gallery; Toni Haefliger, Heinz Huesler, Heinz Wirz: *Herzog & de Meuron – Das neue Suva-Haus in Basel, 1988–1993*, Edition Architekturgalerie. Luzern, 1994, p. 32, p. 33 and p. 47. Photo: Toni Haefliger. Courtesy 2004 Architekturgalerie Luzern
- 140.3: Prof. Deplazes. Graphic: Eva Geering.
- 141.4: Jeffrey Kipnis: *Philip Johnson – Recent Work*, Academy Editions. London, 1996, p. 30.
- 142.5: Atelier Werner Schmidt, Areal Fabrica, Trun.
- 142.6: Herbert & Astrid Gruber: *Bauen mit Stroh*, Oekobuch. Staufeu i. Brsg., 2000, p. 11.
- 143.7: Photo: Dietrich Schwarz.
- 143.8: Prof. Deplazes. Graphic: Maud Châtelet.
- 143.9: Ernst Schweizer AG, Heddingen.
- 153.1: From the James Bond 007 film "You only live twice", Eon Productions, Pinewood Studios, Buckinghamshire, UK, 1967.
- 153.2: Werner Cords-Parchim: *Das Handbuch des Landbaumeisters*, Neumann Verlag. Radebeul, 1969, p. 148.
- 153.3–4: Prof. Deplazes. Graphic: Alois Diethelm.
- 154.5: GA architect, No. 16, "Tadao Ando, Vol. 3., 1994–2000", Tokyo, 2000, p. 27.
- 154.6: Prof. Deplazes. Graphic: Alois Diethelm.
- 154.7: Pierre Zoelly: *Terratektur – Einstieg in die unterirdische Architektur*, Birkhäuser Publishers. Basel, 1981, p. 123.
- 154.8: *El Croquis*, "Tadao Ando 1983–2000", El Croquis Editorial. Madrid, 2000, p. 108. Photo: Hiroshi Ueda.
- 155.9: Henri Stierlin (ed.): *Architektur der Welt: Griechenland*, Taschen Verlag. Cologne, 1980, p. 159. Photo: Henri Stierlin.

- 155.10: *Der Architekt*, No. 11, Bonn, 1991, p. 554.
- 155.11: Peter Meili: *Manuscripts for lecture on building underground*, Inst. für Strassen- & Untertagebau, Swiss Federal Institute of Technology, Zürich, 1975, p. 92 and p. 93.
- 155.12: Martin Hervé: *Guide de l'architecture moderne à Paris*, Editions Alternatives. Paris, 1990, p. 63.
- 156.13: *Werk*, No. 1. Zürich, 1962, p. 45.  
Photo: Alfred Hablützel.
- 156.14: Birgit Abrecht: *Architekturführer Island*, Deutsche Verlags-Anstalt. Munich, 2000, p. 14.
- 156.15–16: *Archithese*, No. 1, Niggli Verlag. Sulgen, 2001, p. 12.
- 156.17: Photo: Adrian Kramp.
- 157.18: Oscar Riera Ojeda (ed.): *Ten Houses – Eduardo Souto de Moura*, Rockport Publishers. Gloucester, 1998, p. 84. Photo: Luis Ferreira Alves.
- 157.19: *Werk, Bauen & Wohnen*, No. 10, Zürich, 1975, p. 882. Photo: Henri Stierlin.
- 157.20 left and right: Vincenzo Albertini, Antonio Baldi, Clemente Esposito: *Naples, the Rediscovered City*, Associazione Napoli Sotterranea. Napoli, 1996, p. 41 and p. 133.
- 157.21: Prof. Deplazes. Graphic: Alois Diethelm.
- 158.22–23: Georg Gerster: *Kirchen im Fels*, Atlantis Verlag. Zürich, 1972, p. 13 and p. 104.  
Graphic: Albert Gerster.
- 158.24: John Carmody, Raymond Sterling: *Earth Sheltered Housing Design*, New York, 1985, p. 139.
- 158.25: Jean-Paul Loubes: *Maisons creusées du fleuve jaune*, Ed. Créaphis. Paris, 1988, p. 108.
- 158.26: John Carmody, Raymond Sterling: *Loco citato*, p. 139.
- 159.27: *Werk, Bauen & Wohnen*, No. 10, Zürich, 1975, p. 888, revised by the editor.
- 159.28: Pierre Zoelly: *Terratektur – Einstieg in die unterirdische Architektur*, Birkhäuser Publishers. Basel, 1989, p. 98.
- 159.29: Prof. Deplazes. Graphic: Alois Diethelm.
- 159.30: Photo & graphic: Christian Kerez.
- 160.31: Rolf H. Ruebener: *Grundbautechnik für Architekten*, Werner-Verlag. Düsseldorf, 1985, p. 122.
- 160.32 top and bottom: *Daidalos*, issue 48, "Sous Terrain", Bertelsmann. Berlin, 1993, p. 63 and p. 65.
- 161.33: Prof. Deplazes. Photo: Janet Schacke.
- 161.34: IPG Keller AG, Kreuzlingen. Graphic: Rainer Keller.
- 161.35–164.43: Prof. Deplazes. Graphic/Photo: Thomas Melliger.
- 163.44: Heinz Ronner: *Baukonstruktion im Kontext des architektonischen Entwerfens. Haus – Sockel*, Birkhäuser Publishers. Basel, 1991, p. 45. Graphic: Heinz Ronner.
- 163.45: Prof. Deplazes.
- 163.46–47: Graphic: Heinz Ronner.
- 163.48: Heinz Ronner: *Baukonstruktion im Kontext des architektonischen Entwerfens. Haus – Sockel*, Birkhäuser Publishers. Basel, 1991, p. 46. Graphic: Heinz Ronner.
- 164.49–167.54: Prof. Deplazes. Graphic: Thomas Wirz.
- 166.55: Source unknown
- 166.56: Prof. Deplazes. Graphic: Alois Diethelm.
- 166.57: Peter Blake: *Philip Johnson*, Studio Paperback, Birkhäuser Publishers. Basel, 1996, p. 59.
- 166.58: Jean-Marie Pérouse de Montclos: *Histoire de l'architecture française – De la Renaissance à la Révolution*, Edition Mengès. Paris, 1995, p. 301.  
Photo: Caroline Rose.
- 166.59: Diener & Diener, Basel.  
Photo: Hans Ruedi Disch.
- 167.60–61: Professur Deplazes. Photo: Alois Diethelm.
- 167.62: Werner Oechslin (ed.): *Daniele Marques*, gta Verlag. Zürich, 2003, p. 55.  
Photo: Christian Kerez.
- 167.63: *Loco citato*, p. 54. Photo: Christian Kerez.
- 167.64: Friedbert Kind-Barkauskas, Bruno Kauhsen, Stefan Polónyi, Jörg Brandt: *Concrete Construction Manual*, Birkhäuser Publishers. Basel, 2002, p. 217.  
Photo: Heinrich Helfenstein.
- 168.65: Photo: Gion A. Caminada.
- 168.66: Dolf Schnebli, Tobias Amman, Flora Ruchat-Roncati: *Werkverzeichnis, 1984–1990*. Zürich, Agno, Verscio, 1991, p. 97. Photo: Heinrich Helfenstein.
- 168.67: Prof. Deplazes. Photo: Alois Diethelm.
- 168.68: Peter Zumthor: *Peter Zumthor Häuser, 1979–1997*, Birkhäuser Publishers. Basel, 1999, p. 108.  
Photo: Helen Binet.
- 168.69: Prof. Deplazes. Graphic: Alois Diethelm.
- 169.70: Prof. Deplazes.

#### Wall

- 170.1: Biblioteca Nazionale Centrale, reprod. with kind permission of the Ministero per i Beni e le Attività Culturali, Italy.
- 170.2: Winfried Nerdinger: *Gottfried Semper, 1803–1879*. Architektur und Wissenschaft, Prestel Verlag/gta. Munich, Zürich, 2003, p. 112.
- 171.3: © Staatliche Museen zu Berlin, Kupferstichkabinett; Karl Friedrich Schinkel, Collection of Architectural Designs.
- 171.4: Eugène Emmanuel Viollet-le-Duc: *Entretiens sur l'architecture*, Morel et Cie Editeurs. Paris, 1864–1872, Atlas, pl. XXXVI.
- 171.5: Robert Gargiani: *August Perret*, Gallimard/Electa. Milan, 1993, p. 77. Photo: Robert Gargiani.
- 172.6: *Loco citato*, p. 62. Photo: Robert Gargiani.
- 172.7: Chup Friemert: *Die gläserne Arche. Kristallpalast London, 1851 & 1854*, Prestel Verlag. Munich, 1984, p. 134.
- 172.8: Winfried Nerdinger: *Der Architekt Walter Gropius*, Gebr. Mann Verlag. Berlin, 1996, p. 35. Photo: Albert Renger-Patzsch; © VG Bild-Kunst, Bonn.
- 173.9: Theo van Doesburg: *Theo van Doesburg. Peintre et architecte*, Gallimard/Electa. Paris, 1993, p. 119.
- 173.10: Carsten-Peter Warncke: *De Stijl, 1917–1931*,

- Benedikt Taschen Verlag. Cologne, 1990, p. 136.  
Photo: Frank van den Oudsten/Lenneke Büller, Amsterdam.
- 174.11: Jonathan M. Woodham: *Twentieth-century ornament*, Rizzoli. New York, 1990, p. 11.
- 174.12: Alexander Koch: *Die deutsche Kunst und Dekoration*, vol. 10, Koch Verlag. Darmstadt, 1902.
- 174.13: Stanislaus von Moos: *Venturi, Rauch & Scott Brown*, Verlag Schirmer Mosel. Munich, 1987, p. 203
- Opening**
- 175.1: *Daidalos*, issue No. 13, Bertelsmann Fachzeitschriften. Berlin, 1984, p. 64. Fig.: Franz Louis Catel: "Schinkel in Neapel" (1824).
- 176.2: Loco citato, p. 66. Photo: Le Corbusier Foundation, Paris.
- 176.3: Loco citato, p. 66.
- 177.4: Le Corbusier: *Almanach D'Architecture Moderne*, Crés. Paris, 1926, p. 92. Photo: Le Corbusier/Le Corbusier Foundation, Paris.
- 178.5: *Daidalos*, issue No. 13, Bertelsmann Fachzeitschriften. Berlin, 1984, p. 68. Fig.: Le Corbusier, Richter & Gut Collection, Lausanne.
- 178.6: Loco citato, p. 68. Sketch: Le Corbusier.
- 178.7: Loco citato, p. 68. Fig.: Le Corbusier Foundation, Paris.
- 179.8: Loco citato, p. 69. Fig.: Le Corbusier Foundation, Paris.
- 180.9: Loco citato, p. 71. Fig.: Le Corbusier Foundation, Paris. (Original: Le Corbusier: *Almanach D'Architecture Moderne*. Paris, 1925, p. 95).
- 180.10–11: Loco citato, p. 70. Sketch: Le Corbusier. (original: *Une petite Maison*, 1923, Les Carnets de la recherche patiente, Editions Girsberger. Zürich, 1954).
- 181.12: Loco citato, p. 72. Photo: Le Corbusier Foundation, Paris. (Original: Le Corbusier: *Almanach D'Architecture Moderne*. Paris, 1925, p. 94).
- 181.14: Loco citato, p. 73. Photo: Bruno Reichlin.
- 181.15–16: Loco citato, p. 72 and p. 78. Sketch: Le Corbusier. (Original: *Une petite Maison*, 1923, Les Carnets de la recherche patiente, Editions Girsberger. Zürich, 1954).
- 183.16: Loco citato, p. 74. Fig.: Kaspar David Friedrich.
- 183.17: Loco citato, p. 74. Fig.: Henri Matisse.
- 183.18: Loco citato, p. 74. Fig.: Robert Delaunay.
- 183.19: Loco citato, p. 77. Fig.: Max Beckmann.
- 183.20: Loco citato, p. 75. Fig.: Paul Klee.
- 183.21: Loco citato, p. 75. Fig.: Henri Matisse.
- 183.22: Loco citato, p. 75. Fig.: Joseph Albers.
- 184.23–191.30: Prof. Deplazes.
- 192.31–32: Prof. Deplazes. Photo: Christoph Elsener.
- 192.33: Thomas Boga: *Die Architektur von Rudolf Olgiati*, gta Verlag. Zürich, 1977, p. 172.
- 192.34: Alejandro de la Sota: *Alejandro de la Sota Architect*, Ediciones Pronaos. Madrid, 1989, p. 85. Photo: Alejandro de la Sota.
- 192.35: Thomas Boga: *Die Architektur von Rudolf Olgiati*, gta Verlag. Zürich, 1977, p. 172.
- 193.36: Franceso Català-Roca, Xavier Monteys: *La Arquitectura de los años cincuenta en Barcelona*, Secretaria General Técnica, Centro de Publicaciones. Madrid, 1987, p. 78. Photo: Franceso Català-Roca.
- 193.37: Source unknown
- 193.38: Gerhard Mack: *Herzog & de Meuron – The Complete Works Volume 1: 1978–1988*, Birkhäuser Publishers. Basel, 1997, p. 67. Photo: Margherita Spiluttini.
- 193.39: Loco citato, p. 62.
- 193.40: Hans Helbling: *Otto Rudolf Salvisberg, 1882–1940*, "Estratto dal fascicolo No. 17 della rivista Architetti". Florence, 1953, p. 12. © Institut für Geschichte und Theorie der Architektur (gta) – ETH Zürich.
- 195.41: *Process Architecture*, No. 11: "Harry Weese", Process Architecture Publishing. Tokyo, 1979, p. 107.
- 195.42–43: *Werk, Bauen & Wohnen*, No. 1/2, Zürich, 2001, p. 166. Photo: Hans Ruedi Disch.
- 195.44: Centre Georges Pompidou (ed.): *Louis I. Kahn – Le monde de l'architecte*, Editions du Centre Georges Pompidou. Paris, 1992, p. 129.
- 196.45–46: Raul Rispa (ed.): *Barragan – Das Gesamtwerk*, Birkhäuser Publishers. Basel, 1996, p. 142.
- 196.47–48: Bo & Wohlert.
- 196.49: Oscar Riera Ojeda (ed.): *Ten Houses – Eduardo Souto de Moura*, Rockport Publishers. Gloucester, 1998, p. 38. Photo: Luis Ferreira Alves.
- 196.50: Arthur Rüegg: "Farbkonzepte und Farbskalen in der Moderne", in: *Daidalos*. Architektur – Kunst – Kultur: "In Farbe", No. 51, Bertelsmann. Berlin, 1994, p. 74. Photo: Arthur Rüegg.
- 196.51: Edoardo Gellner: *Alte Bauernhäuser in den Dolomiten. Die ländliche Architektur der venetianischen Alpen*, Callwey Munich, 1989 (1st ed.: Edizioni Dolomiti, 1988), p. 252. IUAV – Archivio Progetti, Fondo Edoardo Gellner.
- 196.52: Catherine Donzel, Alexis Gregory, Marc Walter: *Grand American Hotels*, The Vendom Press. New York, 1989, p. 176.
- 196.53: Annegret Burg: *Kollhoff – Architekten Kollhoff und Timmermann*, Birkhäuser Publishers. Basel, 1998, p. 67. Photo: Heinrich Helfenstein.
- 197.54: Prof. Deplazes. Graphic: Christine Enzmann.
- 197.55–60: Prof. Deplazes. Graphic: Thomas Melliger.
- 198.61–70: Prof. Deplazes. Graphic: Christine Enzmann.
- 199.71: Hermann Forster Rohr- & Profiltechnik AG, Arbon.
- 199.72: Opo Oeschger AG, Kloten. Hermann Forster Rohr- & Profiltechnik AG, Arbon.
- 200.73: Prof. Deplazes.
- 201.74–75: Prof. Deplazes. Photo: Patric Allemann.
- 201.76: Willy Boesiger, Hans Girsberger: *Le Corbusier, 1910–65*, Birkhäuser Publishers. Basel, 1967, p. 143.
- 202.77: *El Croquis*, No. 102: "Annette Gigon/Mike Guyer, 1989–2000", El Croquis Editorial. Madrid, 2000, p. 180.

- 202.78–82: Prof. Deplazes. Graphic: Patric Allemann.
- 202.83: Johann Christoph Bürkle, Ruggero Tropeano: *Ein Prototyp des neuen Bauens in Zürich – die Rotach-Häuser*, gta Verlag, exhibition catalogue. Zürich, 1994, p. 75. Photo: M. Grasser, C. Eckert.
- 203.84: *Werk, Bauen & Wohnen*, No. 10, Zürich, 1997, p. 51.
- 203.85: Lisbeth Waechter-Boehm: *Baumschlager & Eberle: Bauten und Projekte, 1996–2002*, Springer Verlag. Vienna, 2003, p. 135. Photo: Eduard Huber.
- 203.86: Photo: Ernst Gisel.
- 204.87: *Archithese*, No. 2, Niggli Verlag. Sulgen, 2000, p. 15. Photo: Mechthild Heuser.
- 204.88: Markku Lahti: *Alvar Aalto – elämälle herkempi rakenne*, Rakennustieto Oy. Helsinki, 1996, p. 71. Photo: Maija Holma.
- Floor**
- 205.1: Gesellschaft für Ingenieurbaukunst: *Robert Maillart: Betonvirtuose*, Vdf Verlag. Zürich, 1996, p. 48. Photo: Robert Maillart.
- 206.2: Pier Luigi Nervi: *Gestalten in Beton, Zum Werk von Pier Luigi Nervi*, Rudolf Müller Verlag. Cologne, 1989.
- 206.3: Jürgen Joedike: *Bürobauten*, Verlag Arthur Niggli. Teufen, 1959, p. 58.
- 206.4: Otto Frei, Bodo Rasch: *Gestalt finden*, Edition Axel Menges. Munich, 1992, p. 209. Photo: Otto Frei, Bodo Rasch.
- 206.5–6: Exhibition catalogue: *Alvar Aalto in seven buildings*, Museum of Finnish Architecture. Helsinki, 1998, p. 39 and p. 28.
- 207.7: Jürgen Joedike: *Bürobauten*, Verlag Arthur Niggli. Teufen, 1959, p. 66. Photo: Aero Saarinen.
- 207.8–9: Pier Luigi Nervi: *Neue Strukturen*, Hatje Verlag. Stuttgart, 1963, p. 24 and p. 25. Photo: Pier Luigi Nervi.
- 207.10: Renzo Piano: *Carnet de travail*, Editions du Seuil. Paris, 1997, p. 41. Fig.: Renzo Piano, Richard Rogers.
- 208.11: Michel Ragon: *Goldberg dans la ville*, Paris Art Center. Paris, 1985, p. 31.
- 208.12: Jürgen Joedike: *Bürobauten*, Verlag Arthur Niggli. Teufen, 1959, p. 198. Photo: Hideo Kosaka.
- 208.13: Rem Koolhaas: *Delirious New York*, 010 Publishers. Rotterdam, 1994, p. 83.
- 209.14: *El Croquis*, No. 111, El Croquis Editorial. Madrid, 2002, p. 47.
- 209.15: Doris Weigel: *Die Einraumwohnung als räumliches Manifest der Moderne*, Edition Argus. Schliengen, 1996, p. 75, © Albertina Vienna. Photo: Adolf Loos.
- 210.16: Claude Parent: *Entrelacs de l'oblique*, in the series: Collections Architecture "Les Hommes", Editions du moniteur. Paris, 1981, p. 52. Fig.: Claude Parent, Paul Virilio.
- 210.17: Loco citato, p. 146.
- 210.18: *a+u*, No. 342, Tokyo, 1999/03, pp. 111/113. Photo: Christian Richters.
- 210.19: Source unknown
- 210.20: *2G – revista internacional de arquitectura*, No. 16, Editorial Gustavo Gili. Barcelona, 2000, p. 51.
- Roof**
- 213.1–3: Prof. Deplazes. Graphic: Thomas Wirz.
214. 4–218.16: Prof. Deplazes. Graphic: Daniel Gut.
- 219.17: Gerda Wangerin, Gerhard Weiss: *Heinrich Tesse-now, Ein Baumeister, 1876–1950, Leben – Lehre – Werk*, Verlag Richard Bacht. Essen, 1976, p. 212.
- 219.18: Conradin Clavuot.
- 219.19: Inge Beckel, Annemarie Bucher, Christoph Kübler: *Hans Leuzinger, 1887–1971 – pragmatisch modern*, gta Verlag. Zürich, 1993, p. 55.
- 219.20: Conradin Clavuot, Chur.
- 220.21–22: Prof. Deplazes. Photo: Christoph Elsener.
- 220.23: Source unknown
- 220.24: Source unknown
- 220.25: Wilfried Wang: *Herzog & de Meuron*, Studio Paperback, Birkhäuser Publishers. Basel, 1998, p. 67.
- 220.26: Terence Riley, Barry Bergdoll: *Mies in Berlin, 1907–1938*, Prestel Verlag. Munich, 2001, p. 359. Photo: David Hirsch.
- 221.27–29: Johann Christoph Bürkle: *Gigon Guyer Architekten – Arbeiten, 1989–2000*, Niggli. Sulgen, Zürich, 2000, p. 90, p. 85 and p. 186.
- 221.30–31: Photo: Ralph Feiner.
- 222.32: *Architecture*, No. 3: "Twentieth-Century Museums 1", Kimbell Art Museum. Forth Worth, 1999. Photo: Michael Badycomb.
- 222.33: David Bruce Brownlee, Grant Mudford, David G. De Long: *Louis I. Kahn – In the Realm of Architecture*, The Museum of Contemporary Art. Los Angeles, 1991, p. 397.
- 222.34: Philip Drew: "Sydney Opera House – Jørn Utzon", in: *Architecture In Detail*, Phaidon Press. London, 1995, p. 22. Fig.: Lindy Atkin.
- 222.35 top: *Archithese*, No. 5, Niggli Verlag. Sulgen, 2002, p. 33.
- 222.36 bottom: Allan Temko: *Eero Saarinen*, Georg Braziller Press. New York, 1962, fig. 101. Photo: Ezra Stoller.
- 222.37: Philip Drew: "Sydney Opera House – Jørn Utzon", in: *Architecture In Detail*, Phaidon Press. London, 1995, p. 18. Photo: Anthony Browell.
- 223.38–43: Prof. Deplazes. Graphic: Barbara Wiskemann.
- 223.44: Prof. Deplazes.
- 224.45–46: Prof. Deplazes. Graphic: Barbara Wiskemann.
- Stairs, lifts**
- 225.1: John Wilton-Ely: *Giovanni Battista Piranesi – Vision und Werk*, Hirmer Verlag. Munich, 1978, p. VIII.
- 225.2: Heinrich Klotz (ed.): *Haus-Rucker-Co, 1967 bis 1983*, Vieweg & Sohn Verlag. Braunschweig, Wiesbaden, 1984, p. 122.



- 225.3: Cleo Baldon, Ib Melchior: *Steps & Stairways*, Rizzoli International Publications. New York, 1989, p. 212. Photo: Eadweard Muybridge.
- 226.4: Jacques Sbriglio: *Immeuble 24 N.C. et appartement Le Corbusier*, Birkhäuser Publishers. Basel, 1996, title page. Photo: Le Corbusier Paris, Immeuble 24 rue Nungesser et Coli, appartement de Le Corbusier, 1931, © FLC L2(10)33.
- 226.5: Source unknown
- 226.6: Prof. Deplazes. Photos: Christoph Elsener.
- 226.7: Gerhard Mack: *Herzog & de Meuron – The Complete Works*, Volume 3., 1992–1996, Birkhäuser Publishers. Basel, 1996, p. 202.
- 227.8: John A. Templer: *The Staircase: Studies of Hazards, Falls, and Safer Design*, The MIT Press. Cambridge, Mass., 1992, p. 87.
- 227.9: *El Croquis*, No. 68/69, “Alvaro Siza, 1958–1994”, El Croquis Editorial. Madrid, 1997, p. 92. Photo: Roberto Collova.
- 227.10: John A. Templer: *The Staircase: history and theories*, The MIT Press. Cambridge, Mass. 1992, p. 141.
- 227.11: Frederick Gutheim: *Alvar Aalto*, George Braziller Press. New York, 1960, p. 34.
- 228.12: Fulvio Irace: *Gio Ponti – La casa all' italiana*, Electa. Milano, 1988, p. 164.
- 228.13: Richard Bösel, Christoph C. Frommel (ed.): *Borromini e l'Universo Barocco Documenti di Architettura*, Electa. Milano, 2000, p. 103.
- 228.14: Kurt Lustenberger: *Adolf Loos*, Zanichelli Editore. Bologna, 1998, p. 160.
- 228.15: *El Croquis*, “OMA – Rem Koolhaas, 1987–1998”, El Croquis Editorial. Madrid, 1998, p. 128.
- 229.16: Source unknown
- 229.17: Ivo Kranzfelder: *Edward Hopper, 1882–1967 – Vision de la réalité*, Taschen Verlag. Cologne, 1998, p. 129. Photo: VG Bild-Kunst, Bonn.
- 229.18: Peter Testa: *Alvaro Siza*, Studio Paperback, Birkhäuser Publishers. Basel, 1996, p. 50.
- 229.19: Henri Stierlin (ed.): *Architektur der Welt: Griechenland*, Taschen Verlag. Cologne, 1980, p. 150. Photo: Henri Stierlin.
- 230.20–231.21: Ernst Neufert: *Bauentwurfslehre*, Verlag Vieweg & Sohn. Braunschweig/Wiesbaden, 2002, p. 197 and p. 196.
- 232.22: Prof. Deplazes. Graphic: Daniel Gut.
- 233.23–25: Swiss standard SIA 358, 1996 ed.
- 234.26: *2G – revista internacional de arquitectura*, No. 3: “Sollerod City Hall”, Editorial Gustavo Gili. Barcelona, 1997, p. 41. Photo: Bernardo Jordi.
- 234.27–235.29: AS Aufzüge AG, St Gallen. Graphic: Nik Biedermann.
- 236.30–35: Burkard, Meyer & Partner, Baden.
- 237.36: Luis Fernandez-Galiano (ed.): *A&V Monografias de Arquitectura y Vivienda*, No. 77, “Herzog & de Meuron, 1980–2000”. Madrid, 1992, p. 9.
- 237.37–39: Source unknown
- 238.40–43: Otto Rudolf Salvisberg: *Architekt Professor O. R. Salvisberg, Zürich: Krankenhäuser in St Immer und Pruntrut, Fernheizkraftwerk und Maschinenlaboratorium der ETH*. Zürich, Hoffmann Verlag. Stuttgart, 1936, vol. 1. Photos: Otto Rudolf Salvisberg.
- 238.44: Claude Lichtenstein: *O. R. Salvisberg – Die andere Moderne*, gta Verlag. Zürich, 1995, p. 86.
- 239.45–46: *Archithese*, No. 6, Niggli. Sulgen, 1998, p. 60.
- 239.47–49: Conradin Clavuot, Chur.

## STRUCTURES

## Forms of construction

- 243.1: Source unknown
- 243.2: Helmut C. Schulitz, Werner Sobek, Karl Habermann: *Steel Construction Manual*, Birkhäuser Publishers. Basel, 2001, p. 72. Photo: Harry Callahan.
- 243.3: Stefan Grundmann: *Architekturführer Rom*, Edition Axel Menges. Stuttgart, 1997, p. 68.
- 244.4: William L. McDonald, John A. Pinto: *Hadrian's villa and its Legacy*, Yale University Press. New Haven, 1995, p. 90. Fig.: Michael Lawrence.
- 244.5: Kenneth Frampton: *Studies in Tectonic Culture*, Harvard, 1985, p. 177.
- 246.6: Prof. Deplazes. Photo: Christoph Wieser.
- 247.7: Henri Stierlin: *Islam – Frühe Bauwerke von Bagdad bis Córdoba*, Taschen Verlag. Cologne, 1996, p. 189. Photo: Henri Stierlin.
- 247.8: Loco citato, p. 188. Photo: Berengo Gardin.
- 247.9: Loco citato, p. 71.
- 247.10: Loco citato, p. 72. Photo: Henri Stierlin.
- 248.11–12: Kenneth Frampton: *Grundlagen der Architektur*, Oktagon Verlag. Munich/Stuttgart, 1993, p. 260 and p. 265.
- 248.13: Vincent Ligtelijn: *Aldo van Eyck – Werke*. Birkhäuser Publishers. Basel, 1989, p. 91.
- 248.14 top and right: Kenneth Frampton: *Grundlagen der Architektur*, Oktagon Verlag. Munich/Stuttgart, 1993, p. 54 and p. 55.
- 249.15: Prof. Deplazes. Photo: Christoph Wieser.
- 249.16–17: Prof. Deplazes.
- 250.18: Colin Rowe: *Die Mathematik der idealen Villa*, Birkhäuser Publishers. Basel, 1996, p. 25.
- 250.19: Jacques Lucan: *OMA – Rem Koolhaas*, Artemis Verlag. Zürich/Munich, 1991, p. 129.
- 250.20–21: Kurt Lustenberger: *Adolf Loos*, Studio Paperback, Birkhäuser Publishers. Basel, 1994, p. 160 and p. 161.
- 250.22: Heinrich Kulka: *Adolf Loos – Bauen in der Welt*, Verlag Anton Schroll & Co. Vienna, 1931, fig. 266.
- 251.23–25: Prof. Deplazes. Graphic: Alois Diethelm.
- 251.26: Prof. Deplazes.
- 251.27: dtv-Merian-Reiseführer: *Peking-Nordchina*, Deutscher Taschenbuch Verlag. Munich, 1990, p. 229.

- 251.28: Angelo Ambrosi, E. Degano, C. A. Zaccaria: *Architettura in pietra a secco*, Schena Editore. Fasano, 1990, p. 235.
- 252.29: Prof. Deplazes.
- 252.30: Gert Chesi: *Architektur und Mythos – Lehmbauten in Afrika*, Haymon-Verlag. Innsbruck, 1995, p. 202. Photo: Gert Chesi.
- 252.31 left: Prof. Deplazes. Graphic: Alois Diethelm.
- 252.31 right: Rainer Graefe (ed.): *Zur Geschichte des Konstruierens*, Fourier Verlag. Wiesbaden, 2000, p. 38. Nachbearbeitung: Prof. Deplazes.
- 252.32: Source unknown
- 252.33: Martin Grassnick (ed.): *Materialien zur Baugeschichte – Die Architektur des Mittelalters*, Vieweg Verlag. Braunschweig, Wiesbaden, 1990, MA 161.
- 252.34: Association of Swiss Cement, Lime & Gypsum Producers (ed.): *Bauen in Beton*, 1990/91. Zürich, 1991, p. 30. Photo: Atelier Kinold.
- 252.35: Prof. Deplazes. Graphic: Alois Diethelm.
- 253.36: Source unknown
- 253.37: Prof. Deplazes. Graphic: Alois Diethelm.
- 253.38: Centre Georges Pompidou (ed.): *Louis I. Kahn – Le Monde de l'architecte*, Editions du Centre Georges Pompidou. Paris, 1992, p. 245, © Kathleen James.
- 253.39: Willy Boesiger (ed.): *Le Corbusier – Oeuvre Complète*, 1952–1957, Birkhäuser Publishers. Basel, 1991, p. 213.
- 253.40: Prof. Deplazes. Graphic: Alois Diethelm.
- 254.41: Architettura Viva: *Pier Luigi Nervi, una scienza per l'architettura*, Istituto Mides. Rome, 1982, Project 13.
- 255.42: Prof. Deplazes. Graphic: Alois Diethelm.
- 255.43–45: Erwin Heinle, Jörg Schleich: *Kuppeln aller Zeiten – aller Kulturen*, Deutsche Verlags-Anstalt. Stuttgart, 1996, p. 224, p. 181 and p. 226.
- 255.46–47: *Archithese*, No. 5, Niggli Verlag. Sulgen, 1996, p. 6.
- 256.48: Jakob Hunziker: *Das Schweizerhaus*, vol. 2: "Das Tessin, Aarau", Verlag Sauerländer & Co.. Aarau, 1902, p. 25.
- 256.49: Photo: Christian Kerez.
- 257.50: Ateliers Jean Nouvel, Paris. Illustration: Vincent Lafont.
- 257.51: Paul Virilio: *Bunker-Archäologie*, Carl Hanser Verlag. Munich, 1992, p. 178.
- 257.52: Katharina Bürgin: *Objekte, 1992–1994*, Museum zu Allerheiligen. Schaffhausen, 1995, exhibition. Photo: Rolf Wessendorf.
- 258.53: Prof. Deplazes. Photo: L. Felder, M. Hauser, N. Di Iorio, M. Pausa.
- 258.54: Internet: Source unknown
- 258.55: Prof. Deplazes. Photo: L. Felder, M. Hauser, N. Di Iorio, M. Pausa.
- 259.56–57: Prof. Deplazes. Photo: Urs Meister.
- 259.58–261.70: Prof. Deplazes. Graphic/Photo: L. Felder, M. Hauser, N. Di Iorio, M. Pausa.
- 262.71: Anne and Keith McLachlan: *Tunisia Handbook*. Bath, Baufachverlag. Gütersloh, 1997. Graphic: Bath: Footprint Handbooks, 1997. Fig.: Bath: Footprint Handbooks.
- 263.72: Prof. Deplazes. Photo: Nik Biedermann.
- 263.73: Source unknown
- 263.74: David MacGibbon, Thomas Ross: *The castellated and domestic architecture of Scotland: from the twelfth to the eighteenth Century*, Davin Douglas Press. Edinburgh, 1887, Volume 1, p. 344.
- 263.75: Joachim Zeune: *Der schottische Burgenbau vom 15. bis 17. Jahrhundert*, Deutsches Burgen-institut. Marksburg über Braubach, 1989, fig. 116. Graphic: C. J. Tabraham.
- 264.76: Sigrid Barten: *Eduardo Chillida. Skulpturen aus Ton*, Museum Bellerive, exhibition catalogue. Zürich, 1996, p. 66. Photo: Marlen Perez.
- 264.77: Rolf Toman (ed.): *Die Kunst des Barock: Architektur, Skulptur, Malerei*, Könemann Verlagsgesellschaft. Cologne, 1997, p. 23.
- 264.78 Richard Fawcett: *Scottish Architecture from the Accession of the Stewarts to the Reformation 1371–1560*, Edinburgh University Press. Edinburgh, 1994, p. 240. Graphic: Richard Fawcett.
- 264.79: Rolf Gerber: *Louis I. Kahn's Interesse an schottischen Burgen*, E. Degen Foundation/Rolf Gerber. Swiss Federal Institute of Technology, Zürich, 2000, p. 51. Photo: Rolf Gerber.
- 265.80–83: Loco citato, p. 240. Graphic: Richard Fawcett.
- 265.84: Hermann Muthesius: *Das Englische Haus, Entwicklung, Bedingungen, Anlage, Aufbau, Einrichtung und Innenraum*, Ernst Wasmuth. Berlin, 1908, p. 78.
- 266.85: Rolf Gerber: *Louis I. Kahn's Interesse an schottischen Burgen*, E. Degen Foundation/Rolf Gerber. Swiss Federal Institute of Technology, Zürich, 2000. p. 64–66. Original: Royal Commission on the Ancient and Historical Monuments of Scotland, archives.
- 266.86–88: Prof. Deplazes. Graphic: Nik Biedermann.
- 267.89: David MacGibbon, Thomas Ross: *The castellated and domestic architecture of Scotland: from the twelfth to the eighteenth century*, Davin Douglas Press. Edinburgh, 1887, Volume 2, p. 116.
- 267.90: Loco citato, Volume 1, p. 189.
- 267.91: Prof. Deplazes.
- 267.92 top: Heinrich Kulka (ed.): *Adolf Loos – Das Werk des Architekten*, Verlag Anton Schroll & Co.. Vienna, 1931, fig. 229.
- 267.92 bottom: Loco citato, fig. 225.
- 268.93 top: Joseph Rykwert: *Louis I. Kahn*, H. N. Abrams. New York, 2001, p. 118 and p. 119. Photo: Roberto Schezen.
- 268.93 centre: David Bruce Brownlee, Grant Mudford, David. G. De Long: *Louis I. Kahn – In the Realm of Architecture*, The Museum of Contemporary Art. Los Angeles, 1991, p. 260. Photo Grant Mudford.
- 268.93 bottom: Joseph Rykwert: *Louis I. Kahn*, H. N. Abrams. New York, 2001, p. 116.
- 268.94: Loco citato, p. 121.
- 269.95–98: Hannes Rössler (ed.): *Minihäuser in Japan*,

- Verlag Anton Pustet. Salzburg, 2000. Figs: Kei Sugino.  
 269.99–102: Prof. Deplazes. Figs: Catherine Gay.  
 273.103: Botond Bognar: *World Cities Tokyo*, Academy Editions. Tottenham, 1996, p. 91. Graphic: Kisho Kurokawa.  
 273.104–105: Dominique Deshoulières: *Rob Mallet-Stevens – Architecte*, Archives d'Architecture Moderne. Brussels, 1980, p. 267 and p. 268.  
 273.106: Kisho Kurokawa: *Kisho Kurokawa*, CEP Edition. Paris, 1982, p. 21. Photo: Kisho Kurokawa.  
 274.107: Atelier 5, Bern.  
 274.108: Henri Stierlin: *Islam – Frühe Bauwerke von Bagdad bis Córdoba*, Taschen Verlag. Cologne, 1996, p. 152. Photo: Berengo Gardin.  
 274.109: Atelier 5, Bern. Photo: Leonardo Bezzola.  
 274.110: Henri Stierlin: *Islam – Frühe Bauwerke von Bagdad bis Córdoba*, Taschen Verlag. Cologne, 1996, p. 155.  
 275.111: Esther McCoy, Peter J. Blake: *Craig Ellwood*, Hennessey & Ingalls. Santa Monica, 1997, p. 35.  
 275.112: Patrik Gmür: *Artaria & Schmidt – Wohnhaus Schaeffer Riehen/Basel*, 1927/28, gta Verlag. Zürich, 1993, p. 16.  
 275.113: Hans Wichmann: *System-Design Fritz Haller*, Birkhäuser Publishers. Basel, 1989, p. 49.  
 275.114: Patrik Gmür: *Artaria & Schmidt – Wohnhaus Schaeffer Riehen/Basel*, 1927/28, gta Verlag. Zürich, 1993, p. 20.  
 276.115: Colin Rowe: *The Mathematics of the Ideal Villa*, Cambridge, Mass., 1982, p. 25.  
 276.116: Laura Miotto, Savina Nicolino: *Lina Bo Bardi, aprirsi all'accadimento*, Testo & Immagine. Torino, 1998, p. 7.  
 276.117: Werner Blaser: *Mies van der Rohe – Die Kunst der Struktur*, Artemis Verlag. Zürich, 1965, p. 155.  
 277.118: Hans Wichmann: *System-Design Fritz Haller*, Birkhäuser Publishers. Basel, 1989, p. 96 and p. 97. Photo: Therese Beyeler.  
 277.119: Loco citato, p. 70.  
 277.120: Source unknown  
 277.121: Source unknown  
 278.122–123: Prof. Deplazes. Graphic: Alois Diethelm.  
 278.124: Franz Carl Weber AG, Spreitenbach.  
 279.125: *Arch+*, No. 100/101, archplus Verlag. Aachen, 1989, p. 56.  
 279.126: *Detail*, No. 4, Munich, 2001, p. 660.  
 280.128 left: *Detail*, No. 4, Munich, 2001, p. 665 and p. 667.  
 280.127 right: *Detail*, No. 4, Munich, 2001, S. 667.  
 280.128 top: Kathryn Smith: *Schindler House*. Harry N. Abrams. New York, 2001, p. 31.  
 280.128 bottom: Source unknown  
 280.130: A. Schwabe: "Der heutige Stand des Raumzellenbaues", in: *Der Architekt*, Bonn, 1968, fig. 14. Photo: Werkfoto Bayer.  
 281.130: Prof. Deplazes. Graphic: Alois Diethelm.  
 281.131: James Stirling: *James Stirling – Buildings and Projects, 1950–1974*, New York, 1975, p. 147. Photo: Brecht-Einzig, London.  
 281.132: Blake Gopnick, Michael Sorkin: *Moshe Safdie – Habitat '67*, Montreal, Testo & Immagine. Torino, 1998, p. 82.  
 281.133: Loco citato, p. 10 and p. 11.  
 281.134: James Stirling: *James Stirling – Buildings and Projects, 1950–1974*, New York, 1975, p. 154.  
 281.135: Blake Gopnick, Michael Sorkin: *Moshe Safdie – Habitat '67*, Montreal, Testo & Immagine. Torino, 1998, p. 76.
- Building performance, energy**  
 282.1: Hans Kollhoff: *Hans Kollhoff – Architektur*, Prestel Verlag. Munich, 2002, p. 41. Photo: Ivan Nemeč.  
 282.2: Source unknown  
 282.3: Gert Chesi: *Architektur und Mythos – Leimbauten in Afrika*, Haymon-Verlag. Innsbruck, 1995, p. 14. Photo: Gert Chesi.  
 282.4: Loco citato, photo: Gert Chesi.  
 283.5: Source unknown  
 283.6: Karl Fritz Stöhr: *Die amerikanischen Turmbauten, die Gründe ihrer Entstehung, ihre Finanzierung, Konstruktion und Rentabilität*, Verlag R. Oldenbourg. Munich, Berlin, 1921, fig. 17. Photo: Karl Fritz Stöhr.  
 283.7: Source unknown  
 284.8: Richard Fawcett: *Scottish Architecture from the Accession of the Stewarts to the Reformation 1371–1560*, Edinburgh University Press. Edinburgh, 1994, p. 240.  
 284.9: Source unknown, revised by Prof. Deplazes.  
 285.10: Bearth + Deplazes. Photo: Ralph Feiner.  
 285.11: Bearth + Deplazes. Photo: Ralph Feiner.  
 286.12: Prof. Deplazes.  
 287.13–288.14: Prof. Deplazes. Graphic: Thomas Wirz.  
 288.15–16: Prof. Deplazes.  
 289.17: Prof. Deplazes. Graphic: Thomas Wirz.  
 289.18–19: Prof. Deplazes.  
 291.20–21: Bearth + Deplazes. Photo: Ralph Feiner.  
 292.22–23: Bearth + Deplazes.
- BUILDINGS**
- Selected projects**  
 295.1: *tec21*, No. 25, Zürich, 2002, p. 21. Photo: Ruedi Weidmann/tec 21.  
 296.2: Jürgen Joedicke: *Architekturgeschichte des 20. Jahrhunderts*, Karl Krämer Verlag. Stuttgart, 1990, p. 151.  
 296.3: Burkard, Meyer und Partner, Baden.  
 296.4: Burkard, Meyer und Partner, Baden. Photo: Reinhard Zimmermann.

- 296.5: François Wehrlin (ed.): *Kenzo Tange: 40 ans d'urbanisme et d'architecture*, Process Architecture Publishing. Tokyo, 1987, p. 101. Photo: Osamu Murai.
- 297.6: Bearth + Deplazes.
- 297.7–9: Prof. Deplazes. Graphic: Alois Diethelm.
- 297.10: Hans Wichmann: *System-Design Fritz Haller*, Birkhäuser Publishers. Basel, 1989, p. 132. Photo: Therese Beyeler.
- 298.11: Romaldo Giurgola, Jaimini Mehta: *Louis I. Kahn*, Artemis Verlag. Zürich, 1989, p. 61.
- 298.12: *Architectural Record*, McGraw-Hill. New York, Februar, 1947, p. 95.
- 298.13: Verein Deutscher Ingenieure (ed.): *Heizungsanlagen – Anleitung für Betrieb, Überwachung und Wartung*, VDI-Verlag. Düsseldorf, 1974, p. 3. Reproduced with kind permission of the publisher.
- 299.14–15: Johann Christoph Bürkle: *Wohnhäuser der klassischen Moderne*, Deutsche Verlags-Anstalt. Stuttgart, 1994, p. 100.
- 299.16: Loco citato, p. 128.
- 299.17: Paul Wijdeveld: *Ludwig Wittgenstein, Architekt*, Wiese Verlag. Basel, 1994, p. 124.
- 300.18–20: *Architectural Record*, McGraw-Hill. New York, December, 1960, p. 112 and p. 114.
- 300.21: *Arch+*, No. 93, archplus Verlag. Aachen, 1988, p. 79. Photo: Rayner Banham.
- 300.22: Source unknown
- 300.23: *Architectural Record*, McGraw-Hill. New York, February, 1960. Cover picture.
- 301.24: *The Progressive Architecture Library*, Reinold. New York, February, 1966, p. 145, p. 148 and p. 151.
- 301.25: *Architectural Form*. Tokyo, May, 1963, p. 129.
- 301.26: *The progressive architecture library*, Reinold. New York, February, 1966, p. 145, p. 148 and p. 151.
- 301.27: Abby Bussel: *SOM Evolutions*, Birkhäuser Publishers. Basel, 2000, p. 50 and p. 51. Photo: Ezra Stoller.
- 301.28: *Schweizerische Bauzeitung*, Zürich, 16 December, 1965, p. 920.
- 302.29: *Werk, Bauen & Wohnen*, No. 12, Zürich, 1964, p. 425.
- 302.30–31: *Schweizerische Bauzeitung*, Zürich, 16 December, 1965, p. 914.
- 302.32: *Archithese*, No. 1, Niggli Verlag. Sulgen, 2001, p. 53.
- 302.33: Istituto Lina Bo e P. M. Bardi (ed.): *Lina Bo Bardi*, Edizioni Charta. Milan, 1994, p. 104.
- 302.34: Herdeg Klaus: *Formal Structure in Indian Architecture*, Rizzoli Press. New York, 1990, p. 19, revised.
- 303.35: Burkard, Meyer und Partner, Baden. Photo: Reinhard Zimmermann.
- 303.36–304.40: Burkard, Meyer und Partner, Baden.
- 305.41–42: Burkard, Meyer und Partner, Baden. Photos: Reinhard Zimmermann.
- 305.43–44: Burkard, Meyer und Partner, Baden.
- 306.45: Burkard, Meyer und Partner, Baden. Photo: Reinhard Zimmermann.
- 306.46–47: Burkard, Meyer und Partner, Baden.
- 307.48–49: Prof. Deplazes. Photos: Alois Diethelm.
- 308.50–309.54: Prof. Deplazes. Photo/Graphic: Alois Diethelm.
- 309.55: Burkard, Meyer und Partner, Baden. Photo: Reinhard Zimmermann.
- 310.56–311.60: Prof. Deplazes. Graphic: Alois Diethelm.
- 311.61–62: Burkard, Meyer und Partner, Baden. Photos: Reinhard Zimmermann.
- 312.63–64: Prof. Deplazes. Graphic: Alois Diethelm.
- 313.65: Photo: Ralph Feiner.
- 313.66: *Detail*, No. 1/2, Munich, 2002, p. 63. Photo: Ralph Feiner.
- 313.67: Prof. Deplazes.
- 313.68: Photo: Ralph Feiner.
- 314.69–315.71: Prof. Deplazes.
- 315.72: Bearth + Deplazes.
- 316.73–74: Prof. Deplazes.
- 317.75: Photo: Ralph Feiner.
- 318.76: Prof. Deplazes.
- 318.77: Photo: Ralph Feiner.
- 318.78: Prof. Deplazes.
- 318.79: *Detail*, No. 1/2, Munich, 2002, p. 67. Photo: Ralph Feiner.
- 318.80: Prof. Deplazes.
- 319.81: Photo: Ralph Feiner.
- 319.82: Prof. Deplazes.
- 319.83: Photo: Ralph Feiner.
- 320.84–85: Photos: Bearth + Deplazes.
- 320.86: Prof. Deplazes.
- 321.87: Photo: Ralph Feiner.
- 321.88: Prof. Deplazes.
- 321.89: Gustav Fusch: *Über Hypokausten – Heizungen und mittelalterliche Heizungsanlagen*, Pfiemer Bauverlag. Wiesbaden, 1986, p. 13. Reprint of 1st edition, Jänecke Verlag, Hannover, 1910.
- 321.90: Loco citato, p. 21.
- 322.91–93: Peter Märkli, Zürich.
- 323.94–96: Prof. Deplazes.
- 324.97–100: Peter Märkli, Zürich.
- 325.101: Peter Märkli, Zürich. Revised by Prof. Deplazes.
- 325.102: Prof. Deplazes.
- 326.103–333.105: Peter Märkli, Zürich. Revised by Prof. Deplazes.
- 327.106: Peter Märkli, Zürich.
- 327.107–328.109: Peter Märkli, Zürich. Revised by Prof. Deplazes.
- 329.110–330.114: Prof. Deplazes.
- 330.115: Peter Märkli, Zürich. Revised by Prof. Deplazes.
- 330.116–331.119: Prof. Deplazes.
- 331.120: Peter Märkli, Zürich. Revised by Prof. Deplazes.
- 331.121–122: Prof. Deplazes.
- 332.123: Alberto Dell'Antonio: *Paspels, Valerio Olgiati*, Edition Dino Simonett. Zürich, 1998, p. 45. Photos: Heinrich Helfenstein, Valerio Olgiati, Mira Blau Architekten.
- 332.124: *Archithese*, No. 2, Niggli Verlag. Sulgen, 1997, p. 36. Graphic: Valerio Olgiatti.



- 333.125: *Archithese*, No. 3, Niggli Verlag, Sulgen, 1998, p. 66.  
 333.126: Valerio Olgiati, Zürich.  
 333.127: *Archithese*, No. 2, Niggli Verlag, Sulgen, 1997, p. 37.  
 333.128–129: *Archithese*, No. 3, Niggli Verlag, Sulgen, 1998, p. 66 and p. 67.  
 333.130–133: Valerio Olgiati, Zürich. Revised by Prof. Deplazes.  
 334.134–136: Gebhard Decasper, Ingenieur, Chur. Photos: Dickelmann.  
 335.138: Valerio Olgiati, Zürich.  
 335.139: Valerio Olgiati, Zürich. Revised by Prof. Deplazes.  
 336.140–141: Valerio Olgiati, Zürich.  
 336.142–338.145: Valerio Olgiati, Zürich. Revised by Prof. Deplazes.  
 338.146: Valerio Olgiati, Zürich.  
 339.147: Valerio Olgiati, Zürich. Revised by Prof. Deplazes.  
 339.148–149: Valerio Olgiati, Zürich.  
 340.150: Valerio Olgiati, Zürich. Revised by Prof. Deplazes.  
 340.151–152: Valerio Olgiati, Zürich.  
 341.153: *Archithese*, No. 1, Niggli Verlag, Sulgen, 2001, p. 50.  
 341.154: Loco citato, p. 53.  
 342.155: Loco citato, p. 52.  
 342.156: Loco citato, p. 51.  
 343.157–160: Loco citato, p. 53.  
 344.161–346.167: Miller & Maranta, Basel. Revised by Prof. Deplazes.  
 347.168–348.173: *Werk, Bauen & Wohnen*, No. 9, Zürich, 1997.  
 349.175: *Werk, Bauen & Wohnen*, No. 9, Zürich, 1997.  
 350.176: Giuliani Hönger, Zürich. Photo: Walter Mair.  
 350.177: Giuliani Hönger, Zürich.  
 351.178–355.192: Giuliani Hönger, Zürich. Photos: Walter Mair.  
 356/357.193: Giuliani Hönger, Zürich.  
 358.194: Giuliani Hönger, Zürich.  
 358.195: Giuliani Hönger, Zürich. Photo: Walter Mair.  
 359.196–360.197: Giuliani Hönger, Zürich.  
 361.198: Christoph Wieser: "Von Parks und Plätzen im Zentrum Zürich Nord", in: *Werk, Bauen & Wohnen*, No. 5, Zürich, 2003, p. 18. Photo: Ueli Roth.  
 361.199: Prof. Deplazes. Photo: Marius Hug.  
 362.200–364.209: Peter Märkli, Zürich.  
 365.210: Prof. Deplazes: photo: Marius Hug.  
 365.211: Peter Märkli, Zürich.  
 366.212–367.215: Peter Märkli, Zürich.  
 367.216: Prof. Deplazes. Photo: Marius Hug.  
 367.217–368.219: Peter Märkli, Zürich.  
 368.220: Prof. Deplazes. Photo: Marius Hug.  
 369.221: Peter Märkli, Zürich.  
 369.222–370.223: Prof. Deplazes. Photo: Marius Hug.  
 370.224–225: Peter Märkli, Zürich.  
 371.226: Prof. Deplazes. Photo: Marius Hug.  
 371.227–228: Peter Märkli, Zürich.  
 371.229: Prof. Deplazes. Photo: Marius Hug.  
 372.230–232: Peter Märkli, Zürich.  
 373.233–235: Prof. Deplazes. Photos: Marius Hug.  
 374.236: Photo: Ralph Feiner.  
 374.237: Prof. Deplazes.  
 375.238–239: Prof. Deplazes.  
 376.240–241: Photo: Ralph Feiner.  
 376.242: Prof. Deplazes.  
 377.243: Photo: Ralph Feiner.  
 377.244–378.245: Prof. Deplazes.  
 378.246: Photo: Ralph Feiner.  
 379.247: Prof. Deplazes.  
 380.248: Photo: Ralph Feiner.  
 380.249–250: *Detail*, No. 3, Munich, 2000, p. 384.  
 381.251: Photo: Ralph Feiner.  
 381.252: Prof. Deplazes.  
 381.253: Photo: Ralph Feiner.  
 382.254: *Glas und Praxis*, Glas Troesch AG Bützberg, 2000.  
 382.255: Prof. Deplazes.  
 383.256–257: Meili & Peter, Zürich. Photos: Georg Aerni.  
 383.258: Meili & Peter, Zürich. Revised by Prof. Deplazes.  
 384.259–385.265: Meili & Peter, Zürich. Revised by Prof. Deplazes.  
 386.266–267: Meili & Peter, Zürich.  
 386.268: Jürg Conzett, Chur.  
 387.269–270: Meili & Peter, Zürich. Photo: Georg Aerni.  
 387.271: Meili & Peter, Zürich. Revised by Prof. Deplazes.  
 388.272: Meili & Peter, Zürich. Revised by Prof. Deplazes.  
 388.273: Meili & Peter, Zürich.  
 388.274: Photo: Heinrich Helfenstein.  
 389.275: Photo: Georg Aerni.  
 390.276–392.282: Meili & Peter, Zürich.  
 393.283: Meili & Peter, Zürich. Photo: Andreas Schmidt.  
 393.284: Photo: Georg Aerni.  
 393.285: Meili & Peter, Zürich.  
 394.286: Photo: Ralph Feiner.  
 394.287: Prof. Deplazes.  
 395.288: Photo: Ralph Feiner.  
 395.289–294: Bearth + Deplazes.  
 396.295–296: Bearth + Deplazes. Graphic: Winterthur Holzbau.  
 396.297–299: Bearth + Deplazes.  
 397.300–301: Deplazes, Chair of Architecture.  
 397.302: Bearth + Deplazes. Photo: Ralph Feiner.  
 398.303–306: Photo: Ralph Feiner.

## CATALOGUE OF COMPONENTS

Unnumbered figures: Prof. Deplazes.

**Drawings**

401–406: All figures: Prof. Deplazes.

**Foundation – Plinth**

419.1: Bearth + Deplazes.

419.2: Photo: Ralph Feiner.

**Wall – Floor**

427.1: Prof. Deplazes. Graphic: Maud Châtelet.

**Opening**

452.1: Internet: [www.sky-frame.ch](http://www.sky-frame.ch). Photo: Peter Kunz.

**Floor**

455.1: Bricosol AG, Zürich.

456.2: Poropor. Hagapart AG, Zug. Catalogue.

457.3: Prof. Deplazes. Photo: Thomas Melliger.

458.4: Photo: Ralph Feiner.

459.5: Louis I. Kahn Collection.

460.6: Elementwerk Brun AG, Emmen.

461.7: Montana Bausysteme AG, Villmergen.

462.8: Lignatur AG, Waldstatt.

463.9: Valerio Olgiati, Zürich.

463.10: Werner Oechslin (ed.): *Daniele Marques*,  
gta Verlag, Zürich, 2003, p. 57.

464.11: Lignatur AG, Waldstatt.

465.12: Source unknown

**Roof – Parapet**

466.1: Photo: Ralph Feiner.

476.2: *Archithese*, No. 3, "Niederlande heute",  
Niggli Verlag, Sulgen, 1997, p. 65.

468.3: Johann Christoph Bürkle (ed.):  
*Gigon Guyer Architekten – Arbeiten, 1989–2000*,  
Niggli Verlag, Sulgen, Zürich, 2000, p. 73.

469.4: Morger & Degelo, Basel.

470.5: Photo: Heinrich Helfenstein.

471.6: Morger & Degelo, Basel. Photo: Ruedi Walti.

472.7: Diener & Diener, Basel. Photo: Hans Ruedi Disch.

473.8: Photo: Ruedi Walti.

474.9: Oliver Schwarz, Zürich.

475.10: Johann Christoph Bürkle: *Morger & Degelo*  
*Architekten*, Niggli Verlag, Sulgen, 2000, p. 19.  
Photo: Ruedi Walti.

476.11: Photo: Ralph Feiner.

478.12: Johann Christoph Bürkle (ed.):  
*Gigon Guyer Architekten – Arbeiten, 1989–2000*,  
Niggli Verlag, Sulgen, Zürich, 2000, p. 26/27.

480.13: *Detail*, No. 7/8, Munich, 2002, p. 931.

## Index

- active cross-section . . . . . 158, 159, 243  
 active form . . . . . 158–160, 243  
 aggregate . . . . . 29, 32, 60, 61, 66–68, 169, 390  
 airport . . . . . 138  
 air cavity . . . . . 36, 79, 174, 223  
 alcove . . . . . 147, 185, 264  
 all-in aggregate . . . . . 61  
 aluminium . . . . . 21, 133, 159, 186, 187, 200–203,  
 213, 214, 309, 310, 324, 329, 341, 370, 373, 378–381,  
 . . . . . 390, 391, 393, 476, 479  
 animal . . . . . 14, 22, 154, 212  
 apartment block . . . . . 26, 168, 171, 192, 196, 274, 420,  
 . . . . . 474  
 Art Nouveau . . . . . 173, 174  
 asphalt . . . . . 214, 322  
 atrium . . . . . 342, 345, 346, 351, 355  
 awning . . . . . 202, 203, 380, 381, 391
- balcony . . . . . 202, 203, 309, 311, 368  
 baldachin . . . . . 206  
 ballast . . . . . 214, 216, 217, 224, 390, 391, 393  
 balloon frame . . . . . 79, 96, 99, 117  
 balustrade . . . . . 299, 309, 310, 378  
 barrel-vaulted . . . . . 247, 249, 259  
 basement . . . . . 23, 37, 153, 160, 164–167, 169, 301,  
 303, 315, 316, 318, 319, 324, 326, 342, 377, 380, 386,  
 . . . . . 395, 410–417  
 basement garage . . . . . 75  
 batten . . . . . 213  
 beam . . . . . 17, 73, 89, 91, 92, 103, 108, 126–133, 135,  
 138, 170, 205, 220, 275, 277, 317, 318, 321, 347, 348,  
 . . . . . 383, 386, 390, 391, 393, 420, 479  
 bed joint . . . . . 37, 42  
 bending moment . . . . . 73  
 bitumen . . . . . 84, 88, 102, 214, 223, 339, 340, 390, 391,  
 397, 399, 417, 428, 447, 470, 471, 473, 474, 475, 481  
 bituminous roofing felt . . . . . 169  
 black box . . . . . 94, 95, 99–101, 146  
 board . . . . . 68, 70, 84–89, 93, 102, 317, 390, 391, 397,  
 . . . . . 409, 414, 417, 424, 428, 443, 447, 459, 479  
 bonding dimension . . . . . 35  
 box frame . . . . . 49, 241, 274  
 bracing . . . . . 74, 75, 79, 80, 84, 86, 87, 109, 118, 130,  
 . . . . . 134, 137, 148, 164, 165, 275–277, 377  
 brickwork . . . . . 25, 27–30, 35, 43, 45, 50, 51, 54–57, 59,  
 116, 278, 303, 306, 307, 310, 313, 315, 320, 321, 370,  
 . . . . . 468, 476  
 bridge . . . . . 57, 58, 69, 71, 135, 255, 265, 301, 348,  
 . . . . . 353, 367  
 brise-soleil . . . . . 200, 201  
 buckling . . . . . 12, 27, 36, 37, 73, 79, 85, 90, 97, 121,  
 . . . . . 159, 252  
 buckling load . . . . . 73  
 building envelope . . . . . 12, 46, 98, 116, 133, 136, 146,  
 147, 149, 159, 169, 200, 224, 280, 300, 311, 313, 315,  
 . . . . . 317, 320, 358  
 building performance . . . . . 32, 43, 46, 77, 79, 80,  
 89, 92–95, 114, 133, 139, 187, 201, 215, 217, 218,  
 . . . . . 279, 382  
 building services . . . . . 143, 207, 295, 296, 299–302, 321,  
 . . . . . 373, 375, 381, 382  
 bunker . . . . . 154, 255, 256  
 butt joint . . . . . 67, 89, 102
- calcium silicate . . . . . 32, 39, 405  
 canopy . . . . . 17, 138  
 cantilever . . . . . 75, 172  
 cast-in dowel . . . . . 71  
 castellated beam . . . . . 132  
 castle . . . . . 263–268  
 cast iron . . . . . 114, 248, 301  
 cave . . . . . 147, 155, 156, 158  
 ceiling . . . . . 114, 122, 130, 154, 170, 172, 180, 194–196,  
 199, 205–207, 265, 297, 299, 304, 360, 362, 369, 371,  
 . . . . . 375, 376, 388, 394, 398, 479  
 cellar . . . . . 80, 153, 299  
 cellular beam . . . . . 129  
 cement . . . . . 12, 32, 56, 57, 60–68, 80, 84, 87, 94, 200,  
 213, 223, 278, 299, 307, 324, 367, 388, 390, 391, 393,  
 399, 405, 417, 427, 428, 445, 447, 462–464, 466, 467,  
 . . . . . 473, 479  
 ceramics . . . . . 170, 425, 439  
 channel . . . . . 121, 135, 137  
 chipboard . . . . . 84, 87, 390, 391, 393, 469  
 chord . . . . . 136  
 church . . . . . 24–26, 30, 46, 158, 171, 193  
 cladding . . . . . 17, 46, 47, 51, 54, 69, 70, 71, 86, 90,  
 94–98, 100, 101, 113–117, 119, 122, 133, 135, 136,  
 139, 146, 166–168, 170, 171, 174, 200, 207, 221, 250,  
 277, 278, 299, 300, 345, 350, 358, 383, 396, 397, 399,  
 415, 416, 419, 425, 426, 438, 440, 461, 465, 466, 472  
 clay . . . . . 11–13, 17, 19, 21, 23, 24, 30, 32–35, 39, 43,  
 44, 46, 51, 53–55, 59, 60, 82, 96, 116, 156, 169, 171,  
 200, 205, 213, 224, 262, 264, 279, 280, 307, 315, 318,  
 . . . . . 320, 321, 399, 405, 420, 425, 439, 455, 456, 477  
 clay block . . . . . 35, 205, 420, 455, 456  
 clay brick . . . . . 23, 35, 43  
 climate . . . . . 14, 46, 82, 89, 113, 139, 140, 154, 156,  
 184, 212, 213, 218, 224, 295, 300, 307, 311, 321, 382  
 coarse aggregate . . . . . 66–68  
 cob . . . . . 12–14, 43, 57, 96, 252  
 cold deck . . . . . 213, 214, 218, 223, 224, 399, 468, 469,  
 . . . . . 475, 478, 481  
 column . . . . . 25, 51, 54, 58, 72, 73, 75, 77, 98, 105,  
 114, 118, 125, 126, 131, 133, 138, 153, 164, 165, 205,  
 248, 249, 250, 254, 255, 268, 274–277, 296, 300  
 column-and-slab system . . . . . 249, 250, 276  
 column head . . . . . 77, 164

- compartment . . . . . 49, 50, 243–250, 264, 276, 296  
 compartmentation . . . . . 49, 241, 273  
 composite action . . . . . 114, 127, 128, 134, 344  
 composite construction . . . . . 114  
 composite floor slab . . . . . 129, 131  
 composite slab . . . . . 130  
 compression . . . . . 14, 36, 37, 44, 46, 51, 55, 70, 73, 74,  
 . . . . . 76, 101, 121, 138, 140, 157, 163, 253, 268  
 compressive strength . . . . . 32, 40, 54, 58, 61, 82, 83, 140,  
 . . . . . 214, 215, 306, 367, 405  
 concrete additive . . . . . 62  
 concrete cover . . . . . 63, 127, 168  
 concrete topping . . . . . 126, 128, 130, 134, 455, 456, 461  
 condensation . . . . . 200, 213, 215, 216, 223  
 construction joint . . . . . 65, 109  
 contiguous bored piles . . . . . 159, 160  
 continuous beam . . . . . 73, 126  
 copper . . . . . 82, 211, 212, 318, 321, 398, 469  
 core . . . . . 12, 29, 39, 41, 43, 44, 53, 55, 57, 58, 74,  
 77, 79, 84, 86, 93, 118, 122, 130, 131, 134, 147, 148,  
 249, 250, 263, 273, 278, 279, 296, 297, 304, 315, 317,  
 347, 386, 388, 397, 399, 417, 428, 460, 464, 467  
 cornice . . . . . 211  
 corrosion . . . . . 63, 116, 127, 184, 186, 200  
 corrugated sheet . . . . . 63, 133  
 corrugated sheeting . . . . . 467  
 courtyard . . . . . 13, 67, 139, 155, 158, 193, 195, 206, 244,  
 . . . . . 258, 259, 262, 263, 302  
 Crystal Palace . . . . . 14, 115, 172  
 curtains . . . . . 181, 182, 200, 204, 269, 270, 371, 373  
 curtain wall . . . . . 15, 172, 173, 276, 278, 299, 358,  
 . . . . . 377, 378  
 custom prefabrication . . . . . 94, 100, 101  
  
 daylight . . . . . 138, 143, 154, 155, 166, 181, 184, 192,  
 193, 201–204, 222, 265, 318, 332, 360, 387, 395  
 decking . . . . . 86, 88, 92, 213, 214, 419, 468, 469, 481  
 deep beam . . . . . 386  
 deep foundation . . . . . 163  
 diagonals . . . . . 17, 118, 119, 135–137, 210  
 dimensional coordination . . . . . 36  
 dome . . . . . 15, 243, 245–248, 254  
 door . . . . . 21, 80, 111, 140, 151, 196–199, 202,  
 . . . . . 203, 253, 256, 259, 262, 318, 355, 394, 399  
 double-leaf masonry . . . . . 42, 47, 48, 79, 411, 432, 470  
 double-leaf wall . . . . . 36, 46, 143  
 double window . . . . . 200  
 drain . . . . . 169, 184, 186, 217, 266  
 drainage . . . . . 169, 214, 224, 271, 272, 369, 402, 414,  
 . . . . . 476, 477  
 driving rain . . . . . 47, 86, 184, 307, 329, 378  
 dry construction . . . . . 134, 455, 460, 462–464  
  
 earthwork . . . . . 13, 58  
  
 earth pressure . . . . . 158–160, 166–169  
 eaves . . . . . 42, 107, 161, 193, 212, 219, 224, 397  
 edge-fixed element . . . . . 90  
 Eiffel Tower . . . . . 14, 59, 137  
 entrance . . . . . 22, 25, 80, 107, 109, 110, 141, 154–157,  
 166, 172, 173, 193, 196, 221, 247, 255, 258, 269, 279,  
 301, 303, 313, 324, 328, 332, 342, 350–352, 355, 366,  
 . . . . . 373, 380, 381, 394, 395  
 erection . . . . . 14, 29, 44, 52, 63, 71, 79, 93, 96, 99, 101,  
 107, 116, 127, 136, 140, 253, 275, 277, 280, 370, 455,  
 . . . . . 460, 464  
 escape . . . . . 65, 122, 196, 265, 296, 297, 351, 365,  
 . . . . . 368, 386  
 escape route . . . . . 196, 365  
 excavation . . . . . 153, 155, 159, 161, 162, 166–169, 341  
 exposed concrete . . . . . 17, 47, 55–59, 64, 66, 67, 69  
  
 facade . . . . . 17, 24–26, 28, 30, 46, 50, 53, 54, 70, 71, 77,  
 79, 80, 86, 88–93, 98, 108–119, 126, 128, 134, 135,  
 137–139, 143, 148, 149, 161, 166–168, 172, 176, 185,  
 192–196, 200, 201, 203, 208, 211, 212, 220, 221, 224,  
 247, 260, 261, 265, 266, 268, 269, 274, 276, 277,  
 295–297, 299, 300, 301, 304, 306, 309–311, 327–329,  
 332, 334, 338, 341, 342, 345, 346, 350, 351, 355, 358,  
 359, 366, 368, 370, 371, 373, 374, 376–383, 390, 391,  
 . . . . . 393, 396–398, 407, 426, 427, 479  
 facing brickwork . . . . . 303, 313, 320  
 facing masonry . . . . . 29, 32, 35–38, 43–48, 56, 269, 307,  
 . . . . . 311, 399, 405, 412, 422, 434, 435, 467  
 fair-face concrete . . . . . 369, 373, 399, 405, 413, 416, 422,  
 . . . . . 423, 426, 437, 441, 471  
 fenêtre en longueur . . . . . 177, 180, 196  
 fibreboard . . . . . 78, 84, 88, 388  
 fibre-cement . . . . . 213, 223, 399, 466, 467  
 filigree construction . . . . . 13–15, 57, 58, 77, 113, 114,  
 . . . . . 133, 170, 174, 244, 245, 246  
 fine aggregate . . . . . 66  
 fire protection . . . . . 51, 75, 84, 113, 114, 121, 122, 127,  
 . . . . . 206, 245, 383, 388  
 fire-resistant . . . . . 115, 122, 187, 206, 386  
 fire resistance . . . . . 114, 122, 187, 405, 461, 465  
 flange . . . . . 120, 121, 127, 130, 131, 317, 348, 386  
 flat roof . . . . . 151, 214–218, 220, 224, 399, 470–476,  
 . . . . . 478, 480  
 flat slab . . . . . 72, 75  
 floor . . . . . 12, 15, 21, 26, 42, 44, 49, 50, 53, 54, 64, 67,  
 69, 73, 74, 77, 81, 88, 89, 92, 93, 100–102, 107, 111,  
 114, 122, 126–131, 134, 136, 142, 143, 146, 154–156,  
 158, 159, 163–168, 170, 172, 173, 176, 184, 185,  
 193–195, 198, 199, 201, 203, 205–210, 220, 221, 246,  
 248–251, 259, 261, 265–270, 273, 274, 275–277,  
 279–281, 296–309, 311, 314, 316–319, 321, 324–  
 326, 332–336, 342, 343, 347–349, 352–356, 358,  
 363, 364, 366, 367, 369, 370, 371, 373, 375, 376, 378,



- 382–386, 388, 393–396, 398, 399, 402, 403, 407, 408, 410, 413, 419, 420, 429, 455, 456, 459, 462, 463–465  
 floor construction . . . 127, 164, 165, 205, 207, 297, 408  
 folded plate . . . . . 76, 151, 221  
 form-finding . . . . . 57, 58, 76, 243  
 formwork . . . . . 55–59, 63–68, 70, 73–76, 86, 114, 117, 122, 126, 127, 134, 140, 160, 163–165, 169, 222, 253, 308, 327, 338, 341, 345, 355, 367, 455–459, 461, 465  
 foundation . . . . . 10, 25, 27, 35, 38, 48, 73, 114, 140, 142, . . . . . 162–165, 168, 222, 315, 367, 386  
 frame . . . . . 14, 17, 25, 49, 50, 51, 54, 58, 59, 74, 77–81, 94–102, 107, 113–118, 126, 128, 130, 134–136, 138, 146, 151, 156, 170–172, 177, 179, 180, 184–186, 192, 193, 196, 198–200, 205, 208, 221, 241, 243, 246, 252, 274–279, 301, 309–312, 319, 375, 378, 381, 386, 390, 391, 393, 395, 396, 398, 399, 407, 408, 417, 427, 428, . . . . . 445, 446, 462–464, 475  
 frame construction . . . . . 25, 49–51, 77, 79, 80, 96–101, 114, 115, 146, 170, 172, 198, 200, 274, 278, 279, 396, 398, 399, 407, 417, 427, 428, 445, 446, 462–464, 475  
 French window . . . . . 178, 309  
 frost heave . . . . . 163
- g-value . . . . . 187, 201, 382  
 gable . . . . . 108, 110, 112, 211  
 garden . . . . . 167, 178–180, 195, 220, 276, 306, 323  
 girder . . . . . 17, 135  
 glare . . . . . 151, 200, 201, 202–204, 319  
 glass . . . . . 11, 50, 62, 63, 74, 80, 115, 116, 121, 135, 139, 143, 144, 147–149, 151, 172, 173, 181, 187, 192, 199–201, 203, 214, 216, 218, 220, 224, 255, 279, 298, 299, 301, 310, 319, 321, 358, 366, 368, 373–375, 377–382, 394, 399, 410, 411, 413, 414, 416, 423, 424, . . . . . 437, 443, 473, 479, 481  
 glass wall . . . . . 172  
 glazing . . . . . 44, 98, 115, 119, 121, 134, 137, 148, 184–187, 195, 200, 203, 276, 301, 304, 310, 368, 373, . . . . . 379, 380, 382, 398, 479  
 glued laminated timber . . . . . 85, 91, 98, 248, 277, 383, . . . . . 386, 405  
 glulam . . . . . 77, 84, 85, 277, 318, 405  
 granite . . . . . 21  
 gravel . . . . . 57, 60, 61, 66, 161, 169, 214–217, 219, 224, . . . . . 303, 317, 318, 341, 410  
 grid . . . . . 13, 30, 51, 53, 73, 94, 97, 99, 100, 116, 119, 134, 136, 153, 158, 162, 220, 221, 248, 249, 254, 274–277, 296, 309, 311, 344, 358, 368, 371, 390, . . . . . 391, 393, 397, 425, 439  
 groundwater . . . . . 162, 163, 169  
 ground slab . . . . . 162–165, 169, 386, 411–417  
 gutter . . . . . 133, 219, 224, 397  
 gypsum . . . . . 60, 84, 262, 308, 369, 373, 390, 391, 393
- half-brick wall . . . . . 36
- hall . . . . . 31, 80, 107, 110, 166, 193, 211, 212, 222, 243, 246, 247, 249, 264–266, 268–270, 274, 301, 313, 324, . . . . . 341, 342, 344, 351, 361–369, 387, 389, 395, 458  
 handrail . . . . . 121  
 hardware . . . . . 151, 197–199  
 hardwood . . . . . 78, 82, 90, 91  
 header . . . . . 35, 36, 39–41, 44  
 heating . . . . . 31, 47, 60, 66, 116, 122, 143, 204, 207, 275, 295, 298, 299, 307, 321, 340–342, 360, 382, 408, 410, . . . . . 413, 419, 420, 423, 427, 429, 455–460  
 heat loss . . . . . 69  
 high-rise block . . . . . 54, 116, 194, 208, 301  
 high-rise building . . . . . 149, 249  
 hollow-core concrete slab . . . . . 460  
 hollow clay block floor . . . . . 420, 455  
 Holorib . . . . . 126, 127  
 horizontal strip window . . . . . 53, 193  
 house . . . . . 28, 30, 31, 45, 47, 49, 50, 57, 58, 106–112, 115, 116, 140–142, 154, 157, 160, 164–168, 173, 176, 192, 193, 195, 210, 222, 250, 257, 267, 269, 270, 275, . . . . . 276, 280, 302, 468  
 housebuilding . . . . . 14, 43, 107, 113, 115, 205, 268, 296  
 hut . . . . . 14, 170, 182, 243, 245, 295  
 hydrostatic pressure . . . . . 162, 163, 169, 224  
 hypocaust . . . . . 162, 163, 169, 224
- impact sound insulation . . . . . 88, 102, 214, 339, 358, 367, . . . . . 369, 419, 429, 461–463  
 infill . . . . . 15, 96, 114, 122, 128–131, 134, 170, 193, 222, . . . . . 250, 251, 275, 368, 370, 371, 390, 391  
 infrastructure . . . . . 12, 98, 138, 159, 207, 208, 272, 293, . . . . . 295–297, 299–301  
 insulated reinforcement . . . . . 69  
 insulating layer . . . . . 116  
 insulating material . . . . . 82, 91–93, 99–101, 140, 149, . . . . . 214, 224  
 insulation . . . . . 17, 25, 30, 32, 36, 42, 46–48, 50, 53, 54, 69, 71, 75, 77, 79–81, 84, 88–91, 93, 97, 98, 100–102, 114, 116, 130, 139, 140, 143, 144, 146, 164, 165, 168, 169, 174, 184, 187, 197, 198, 200, 203, 206, 213–218, 223, 224, 272, 278, 280, 295, 296, 300, 307–311, 317–319, 321, 333, 334, 339, 340, 358, 367, 369, 370, 371, 377, 379, 382, 390, 391, 393, 397, 399, 405, 409–417, 419–429, 433, 435–437, 439, 441, . . . . . 442, 445, 447, 449, 455–468, 470–476, 481  
 interior climate . . . . . 89, 307, 321, 382  
 interior layout . . . . . 159  
 International Style . . . . . 28, 50, 211  
 in situ concrete . . . . . 26, 53, 54, 63, 65, 67, 70, 73, 74, 114, 127, 131, 167, 169, 200, 220, 222, 274, 276, 280, . . . . . 325, 362, 367, 373, 375, 395, 459
- jamb . . . . . 93, 198  
 japanese house . . . . . 108, 111

- japanese housebuilding . . . . . 107
- joint . . . . . 26, 27, 35–37, 39, 42, 43, 45, 54, 65, 67, 71, 78, 85, 89, 93, 102, 108, 109, 151, 184, 194, 211, . . . . . 269, 350, 380, 436
- jointing . . . . . 37, 36, 43, 45, 52, 56, 77, 78, 109, 111, 170, . . . . . 174, 223, 251, 278, 300, 370, 373,
- joist . . . . . 13, 49, 98, 205, 248–250, 301, 399, 463
- junction . . . . . 13, 49, 98, 205, 248–250, 301, 399, 463
- landing . . . . . 196
- lantern light . . . . . 196
- lattice beam . . . . . 17, 135, 196
- lean concrete . . . . . 162, 169, 196, 369
- lesene . . . . . 196, 368
- lift . . . . . 43, 156, 196, 221, 257, 270, 296
- lighting . . . . . 147, 154, 160, 178, 194, 196, 204, 205, 206, 221, 269, 301, 318, 319, 329, 332, 365, 373, 377, 395
- lightwell . . . . . 166, 167, 196, 377
- linear member . . . . . 74, 78, 97, 196
- linear structural member . . . . . 196
- lining . . . . . 95, 100, 101, 102, 115, 155, 171, 196, 198, . . . . . 213, 221, 329, 345, 379, 380, 390, 391
- lintel . . . . . 32, 52, 93, 95, 184, 195, 196, 199, 202, 253, . . . . . 308, 310, 318, 386, 402
- loadbearing layer . . . . . 140, 143, 196, 200, 215, 216, . . . . . 217, 218, 224, 458, 459
- loadbearing structure . . . . . 12, 14, 26, 46, 49, 50, 53, 55, 58, 71, 75, 80, 98, 115, 116, 118, 122, 126, 128, 130, 133–135, 137, 139, 155, 160, 171, 193, 196, 205, 207, 223, 243, 245, 249, 250, 252, 253, 255, 266, 269, 270, 274–277, 278, 280, 281, 295–297, 300–302, 304, 306, 317, 332, 344, 355, 366, 370, 373, 375–378, 395, . . . . . 396, 398
- loam . . . . . 32, 35, 196
- loggia . . . . . 196, 201
- log construction . . . . . 98, 110, 463
- long-span roof . . . . . 76, 196
- long horizontal window . . . . . 180, 181, 196, 299
- long window . . . . . 151, 175–178, 180, 182, 196
- louvre blind . . . . . 196, 203, 479
- low-energy house . . . . . 196, 241
- masonry 12, 13, 17, 23–32, 35–57, 71, 79, 89, 94, 96, 117, 122, 139, 140, 142, 146, 167, 170, 171, 174, 184, 194, 196, 200, 219, 251, 255, 264, 269, 270, 272, 275, 278, 304, 306–311, 315–318, 320, 321, 325, 326, 370, 371, 399, 405, 410–412, 414, 415, 420–422, 424, 425, . . . . . 430–435, 439, 443, 455–457, 460, 467–470, 474
- masonry bond . . . . . 30, 35–39, 43, 45–47, 52, 142, 196, . . . . . 307, 320, 405
- masonry unit . . . . . 32, 35, 36, 39, 40, 42–44, 196, 278
- massive . . . . . 14, 27, 29, 30, 54, 55, 148, 170, 176, 196, . . . . . 222, 249, 255–257, 264, 265, 269, 302, 341
- massiveness . . . . . 13, 43, 46, 48, 196, 256, 264
- means of escape . . . . . 122, 196, 297
- medium density fibreboard . . . . . 78, 88, 196
- meltwater . . . . . 184, 196, 214, 224
- membrane . . . . . 24, 76, 79, 102, 116, 137, 164, 165, 169, 196, 200, 213, 218, 224, 377, 393, 409, 411, 413, 414, . . . . . 416, 417, 419, 428, 429, 449, 462–464, 466, 475
- Middle Ages . . . . . 158, 166, 196, 206, 244, 263, 320
- minergie standard . . . . . 196, 371
- Möbius strip . . . . . 196, 209, 210
- Modernism . . . . . 25, 28, 30, 43, 106, 111, 139, 156, 166, 168, 172, 174, 178, 196, 205–207, 211, 212, 298
- modular system . . . . . 43, 93, 196, 277
- moisture . . . . . 32, 52, 61, 63, 65, 66, 82, 83, 85–88, 110, 136, 140, 156, 163, 166–169, 184, 186, 196, 200, 213, . . . . . 214, 224, 307, 470, 471
- moisture content . . . . . 61, 82, 83, 85, 196
- monolith . . . . . 58, 196, 256, 345
- monolithic . . . . . 20, 46, 57, 58, 80, 139, 140, 146, 151, 157, 158, 192, 196, 200, 220–222, 256, 257, 269, . . . . . 278, 301, 315, 318, 320, 341, 344, 355, 382
- monopitch roof . . . . . 196, 399, 467
- mortar . . . . . 45, 196, 405, 413, 414, 423
- mosque . . . . . 15, 196
- mullion . . . . . 54, 196
- multistorey building . . . . . 122, 196, 251, 280
- museum . . . . . 55, 118, 160, 195, 196, 221, 222, 247, . . . . . 248, 257, 301, 302, 478
- natural ventilation . . . . . 110, 153, 166, 196, 360, 382
- Neues Bauen . . . . . 113, 115, 196, 211
- noise . . . . . 22, 156, 196, 200, 360
- nominal dimension . . . . . 196
- normal-weight concrete . . . . . 54, 196
- oil crisis . . . . . 25, 31, 46, 79, 116, 139, 142, 196, 298
- one-brick wall . . . . . 36, 37, 196
- one-way span . . . . . 75, 196, 277
- opening . . . . . 151, 175, 184–204, 382, 399, 430–449, 464
- opus caementitium . . . . . 196
- oriented strand board . . . . . 84, 87
- ornamentation . . . . . 23, 27, 28, 45, 48, 56, 118, 133, 148, . . . . . 171, 196, 212, 259
- pad foundation . . . . . 196
- panel construction . . . . . 17, 53, 80, 94, 95, 97, 99, 146, . . . . . 196, 279, 418, 419, 429, 448
- Pantheon . . . . . 154, 243, 252, 254
- parapet . . . . . 196, 224, 288, 289, 317, 399, 466–482
- particleboard . . . . . 87, 196, 417, 427, 428, 445, 447, . . . . . 462–464, 473, 479
- partition . . . . . 80, 170, 196
- pavilion . . . . . 50, 76, 136, 196
- peat . . . . . 156, 196
- permanent formwork . . . . . 55, 57, 114, 122, 126, 127,

- . . . . . 134, 140, 164, 165, 196, 253, 308  
 perpend . . . . . 35, 39, 196  
 pier . . . . . 138, 155, 196, 207, 254  
 pitched roof . . . . . 151, 213, 219, 223, 224, 399,  
 . . . . . 466–468, 469  
 plank . . . . . 90, 131, 196, 396  
 plan layout . . . . . 15, 49, 50, 80, 94, 96, 111, 114, 127,  
 159, 162, 196, 205, 247, 248, 269, 296, 297, 325,  
 . . . . . 351, 393  
 plan libre . . . . . 196, 205, 249, 393  
 plaster . . . . . 21, 23, 32, 43, 100, 122, 196, 257, 259, 262,  
 . . . . . 278–280, 307, 405, 407, 413, 423, 437, 481  
 plasterboard . . . . . 213, 304, 324, 417, 428, 468  
 plastered . . . . . 28, 32, 37, 46, 56, 69, 89, 325  
 plastic . . . . . 12, 15, 17, 19, 21, 22, 32, 42, 43, 46, 48, 57,  
 60, 61, 63, 64, 71, 77–80, 94, 129, 143, 162, 166, 169,  
 170, 186, 187, 198, 213, 255, 256, 279, 317, 318, 321,  
 410–416, 420, 421, 422, 423, 424, 425, 426, 427, 443,  
 . . . . . 455–461, 465  
 plate . . . . . 51, 74–79, 89, 95, 97–99, 102, 125, 127, 130,  
 131, 133, 135, 148, 151, 170, 171, 173, 199, 221, 250,  
 . . . . . 301, 317, 347, 348, 465  
 plate effect . . . . . 99, 348  
 platform frame . . . . . 77–80, 95, 97, 99–102, 114, 115,  
 146, 200, 278, 279, 395, 396, 398, 399, 407, 417, 428,  
 . . . . . 446, 475  
 plinth . . . . . 35, 54, 146, 166–168, 222, 255, 321, 368,  
 . . . . . 370, 371, 373, 390, 407, 411  
 plywood . . . . . 59, 64, 84, 86, 92, 93, 317, 386, 397, 417,  
 . . . . . 428, 464, 467  
 polyethylene . . . . . 308, 340, 369, 377, 390, 391, 393  
 polystyrene . . . . . 22, 70, 144, 169, 214, 217, 308, 309,  
 311, 317, 326, 369, 370, 411, 415, 427, 471, 474, 481  
 polyurethane . . . . . 140, 311  
 pore . . . . . 82, 373  
 post . . . . . 25, 166, 168, 174, 358, 378, 381, 383  
 Post-Modernism . . . . . 25, 166, 168, 174  
 precast concrete . . . . . 63, 64, 67, 70, 73–75, 167, 274,  
 . . . . . 300, 367, 368, 370, 373, 416  
 prefabrication . . . . . 17, 52, 55, 77, 116, 241, 278, 308,  
 . . . . . 396, 458, 460, 465  
 prestressed concrete . . . . . 76  
 profiled metal sheeting . . . . . 127, 461  
 protective layer . . . . . 54, 139, 140, 142, 215–218, 224, 477  
 punching shear . . . . . 75  
 purlin . . . . . 13, 132  
 PVC . . . . . 21, 186, 213, 214  
  
 radiation . . . . . 80, 86, 143, 186, 187, 200, 201, 203,  
 . . . . . 213–216, 218, 224, 299, 321, 382  
 rafter . . . . . 467  
 raft foundation . . . . . 163  
 railway sleeper house . . . . . 106–112  
 rain . . . . . 47, 86, 154, 184, 212–214, 219, 223, 224,  
 . . . . . 307, 329, 378  
 rainwater . . . . . 156, 184, 200, 219, 224  
 raking column . . . . . 118  
 ramp . . . . . 154, 402  
 rationalisation . . . . . 29, 53, 97, 115, 205, 212  
 reinforced concrete . . . . . 43, 46, 49, 51, 53, 56, 57, 59,  
 63, 72–74, 76, 77, 92, 114, 126, 129, 134, 164, 171,  
 173, 176, 194, 205, 209, 213, 216, 245, 246, 248, 249,  
 250, 253, 254, 272, 296, 297, 301, 304, 318, 347,  
 . . . . . 355, 455, 456, 461  
 reinforced masonry . . . . . 42  
 reinforcement . . . . . 42, 46, 52, 54, 55, 58, 59, 63, 64, 66,  
 69, 70, 72, 73, 75, 77, 84, 113, 114, 127, 131, 140,  
 149, 169, 200, 246, 252, 334, 344, 367, 456, 457, 461  
 release agent . . . . . 63–67  
 relief . . . . . 43, 45, 48, 50, 54, 115, 134, 170, 185, 300,  
 . . . . . 301, 309, 311, 320, 358, 381  
 render . . . . . 23, 27, 28, 32, 43, 44, 47, 80, 94, 96, 99,  
 115–117, 139, 142, 146, 154, 159, 167, 200, 209, 211,  
 224, 273, 275, 278, 280, 373, 383, 405, 411, 414, 424,  
 . . . . . 443, 458, 459, 481  
 rendered . . . . . 22, 24, 28, 32, 37, 46, 56, 59, 89, 115,  
 140, 142, 208, 212, 260, 275, 315, 368, 370, 371, 399,  
 411, 414, 420, 421, 424, 432, 442, 457–460, 470, 474  
 retaining wall . . . . . 159  
 rhombus . . . . . 118, 119, 137  
 ribbed concrete slab . . . . . 127  
 ribbed slab . . . . . 75, 79, 128–130, 458  
 ridge . . . . . 108, 212, 394  
 roller shutter . . . . . 202  
 roof 12–15, 23, 50, 73, 76, 86, 88–93, 106–108, 110–  
 112, 133, 135–138, 146, 151, 156–158, 161, 169, 184,  
 193, 206, 210–224, 243–248, 255, 256, 262, 269, 277,  
 279–281, 315, 317, 332, 334, 361, 368, 370, 386, 393,  
 . . . . . 396–399, 407, 466–481  
 rooflight . . . . . 318, 319  
 roof construction . . . . . 15, 135, 213, 215, 218, 223, 224,  
 . . . . . 247, 397, 407  
 roof covering . . . . . 108, 212, 213, 215, 216, 218, 223, 224  
 run-off water . . . . . 80, 162, 169  
  
 safety barrier . . . . . 310, 368, 378  
 sandwich element . . . . . 319  
 sandwich panel . . . . . 278  
 sawn timber . . . . . 77, 78, 97, 98  
 sawtooth roof . . . . . 221  
 scaffold . . . . . 54, 140, 141, 249, 251  
 scaffolding . . . . . 28, 272  
 school . . . . . 28, 69, 156, 167, 219, 275, 280, 301, 332,  
 . . . . . 341, 342, 344, 361–365, 367, 369, 371, 383, 475  
 screed . . . . . 130, 223, 299, 311, 324, 326, 369, 377  
 seal . . . . . 68, 169, 187, 198–200, 214  
 sealing . . . . . 68, 213, 214, 318, 405  
 secondary waterproofing/covering layer . . . . . 419, 466,

- . . . . . 467, 469  
 separating layer . . . 81, 213–217, 369, 377, 409–427,  
 . . . . . 429, 449, 455–461, 465, 481  
 services shaft . . . . . 300, 375  
 setting out . . . . . 161  
 shallow foundation . . . . . 163  
 shear . . . . . 36, 69, 73–76, 83, 91, 127, 129, 131, 137,  
 . . . . . 245, 249, 274, 306, 334, 344, 347, 349  
 shear stud . . . . . 129, 334  
 shear wall . . . . . 245, 274  
 sheathing . . . 77, 79, 80, 86, 87, 97, 99, 100, 102, 114  
 shell . . . . 12, 14, 25, 45, 53, 56, 58, 76, 94, 140, 142,  
 151, 162, 173, 182, 212, 213, 222, 243, 254, 263, 272,  
 . . . . . 277, 315, 320, 345  
 shell roof . . . . . 151, 222  
 shingles . . . . . 79, 80, 81, 108, 200, 223, 224, 419,  
 . . . . . 429, 449  
 sill . . . . . 45, 93, 184, 200, 308, 309  
 simply-supported . . . . . 73, 75, 151  
 single-leaf masonry . . . . . 146, 200, 410, 430, 469  
 single-leaf wall . . . . . 321  
 single-storey shed . . . . . 241, 277  
 skeleton . . . . . 13, 14, 58, 245  
 skyscraper . . . . . 25, 44, 54, 114, 207, 208  
 slab tectonics . . . . . 78–80, 94  
 slate . . . . . 219, 416, 426  
 slenderness . . . . . 73, 76, 115, 118  
 slenderness ratio . . . . . 76  
 sliding door . . . . . 76, 196, 197, 199  
 snow . . . . . 184, 203, 213, 214, 218, 219, 221, 224  
 soffit . . . . . 69, 127, 199, 202, 205–207, 222, 370,  
 373, 376, 379, 380, 388, 411, 413, 414, 417, 420, 421,  
 . . . . . 423, 424, 427, 428, 455, 456, 460, 463, 481  
 softwood . . . . . 78, 82, 88, 89, 91  
 soiling . . . . . 66, 168, 203, 213  
 solid construction . . . . 13–15, 57, 77–80, 89, 94, 98,  
 114, 154, 170, 173, 245, 246, 250–254, 282–285, 291  
 solid timber panel construction . . . . . 418, 448  
 solid timber wall panel . . . . . 80  
 sound insulation . . . . 32, 75, 81, 84, 88, 102, 114, 130,  
 184, 197, 198, 206, 214, 215, 278, 287, 289, 296, 311,  
 339, 358, 367, 369, 377, 390, 391, 393, 405, 409, 411,  
 . . . 413, 414, 416, 417, 419–429, 449, 450, 453–465  
 space frame . . . . . 58, 136, 151, 238, 277  
 spandrel panel . . . 53, 54, 195, 288, 289, 300, 371, 383,  
 . . . . . 386, 390, 391, 402  
 spatial plan . . . . . 209, 250, 267  
 spiral stairs . . . . . 265  
 split level . . . . . 228  
 sprayed concrete . . . . . 59, 62, 140, 141  
 stability . . . . 14, 36, 37, 43, 44, 46, 48, 50, 55, 77, 79,  
 83, 89, 109, 110, 112, 114, 117, 133, 134, 159, 164,  
 165, 245, 246, 249, 251, 252, 253, 255, 274, 276, 277,  
 . . . . . 282, 284, 311, 320, 321, 344, 386, 426  
 stair . . . . . 227, 231  
 staircase . . . . 151, 205, 220, 225–229, 232, 236–239,  
 . . . 265, 269, 273, 276, 279, 296, 342, 376, 377, 382  
 stairwell . . . . . 227, 232, 234, 237, 238  
 steel . . . . 17, 53, 54, 64, 113–116, 119–138, 186, 238,  
 248, 275, 317, 318, 319, 321, 368, 399, 405, 461,  
 . . . . . 465, 479  
 steel floor . . . . . 399, 465  
 steel frame . . . . . 113, 114, 116, 134, 135, 275, 319  
 stem wall . . . . . 163–165  
 stereotomy . . . . . 12–14, 23, 27, 77, 170, 282, 283  
 stone . . . . . 13, 14, 17, 21, 23, 24, 27–29, 32, 35, 57,  
 61, 71, 114, 115, 148, 154, 157, 159, 161, 166, 168,  
 174, 176, 193, 206, 211, 223, 224, 236, 251, 256, 262,  
 263, 282, 283, 288, 291, 350, 358, 369, 405, 409,  
 . . . . . 458, 472  
 straw . . . . . 107, 140, 142, 212, 262  
 stretcher . . . . . 32, 35, 36, 39, 40, 43, 44, 47  
 strip footing . . . . . 163–165  
 structural opening . . . . . 14, 15, 184, 198, 274, 402  
 structural shell . . . . . 12, 14, 56, 94, 162, 213, 285  
 structural steelwork . . . 15, 58, 98, 114, 115, 118, 120,  
 . . . . . 122, 123, 127, 135, 275, 277, 283  
 strut . . . . . 98  
 subsoil conditions . . . . . 136  
 substructure . . . . . 23, 106, 111, 153, 158, 166  
 sunlight . . . . 25, 50, 66, 151, 184, 200, 201, 203, 212,  
 . . . . . 221, 292, 319, 324, 329, 332, 381, 398  
 sunshade . . . . . 116, 200, 201  
 sunshading . . . . . 21, 201, 391  
 sunshine . . . . . 154, 223  
 superstructure . . . . . 27, 73, 111, 153, 155, 166, 168  
 support . . . . . 35, 42, 46, 51, 64, 69–71, 73, 75, 77,  
 80, 82, 117, 126, 127, 130, 131, 133, 154, 158, 163,  
 171, 205, 212, 234, 236, 239, 251, 262, 264, 277, 280,  
 . . . . . 289, 301, 317, 334, 347, 348, 386, 426  
 surface finish . . . . 32, 37, 43, 64, 73, 97, 99, 308, 367  
 survey . . . . . 271  
 suspended ceiling . . . . 122, 206, 207, 297, 360, 371,  
 . . . . . 375, 376  
 sustainability . . . . . 241, 282, 285  
 Swiss standard . . . . . 48, 61, 68, 83, 233, 271, 401  
 synthetic building material . . . . . 139  
 synthetic system . . . . . 79, 115, 146, 281, 283  
 system building . . . . . 241, 278  
  
 tatami mat . . . . . 67, 110, 111  
 tectonics . . . . 10–14, 19, 23, 57, 58, 77–80, 94, 148,  
 . . . . . 170, 250, 255, 282–284, 291  
 temperature . . . . 32, 42, 44, 69, 85, 87, 122, 143, 156,  
 158, 184, 200, 201, 203, 213, 218, 286, 290, 292, 299,  
 . . . . . 321, 360, 382  
 temple . . . . . 27, 157, 170  
 tensile strength . . . . . 44, 58, 61, 65, 82, 315



- tension . . . . . 26, 36, 58, 75, 76, 99, 101, 125, 139, 148,  
 . . . . . 246, 254, 282, 328, 456, 458  
 tent . . . . . 57, 107, 211, 221  
 terrace . . . . . 23, 211, 212, 220, 273, 288, 289, 305,  
 . . . . . 359, 477  
 terrain . . . . . 154, 156, 157, 163, 166–169, 209, 221, 249,  
 . . . . . 272, 323, 394, 407  
 terrazzo . . . . . 237  
 textile . . . . . 12–14, 24, 25, 48, 57, 78, 170, 171, 206,  
 . . . . . 207, 212, 270, 320  
 thermal bridge . . . . . 69, 70  
 thermal insulation . . . . . 25, 30, 32, 36, 46, 47, 53, 71, 77,  
 79, 88, 97, 101, 116, 139, 143, 164, 165, 168, 174,  
 184, 187, 203, 213–218, 223, 224, 280, 285–291, 295,  
 300, 307, 311, 317–319, 321, 334, 370, 371, 379,  
 . . . . . 382, 397, 405, 419, 467, 475  
 threshold . . . . . 45, 178, 196, 198, 256, 402, 452  
 tie . . . . . 23, 42, 57, 98, 252, 253  
 timber . . . . . 13, 17, 63, 67, 78, 80, 83, 84, 89, 96, 99,  
 100, 102, 146, 156, 213, 248, 383, 386, 396, 397, 399,  
 . . . . . 417, 419, 428, 447, 463, 464, 475, 479  
 timber-frame building . . . . . 96, 282  
 timber box element floor . . . . . 464  
 timber floor . . . . . 128, 399, 462  
 timber frame construction . . . . . 96  
 timber joist floor . . . . . 399, 463  
 timber stud construction . . . . . 96, 97, 99  
 tolerance . . . . . 36, 162, 184, 411, 421, 433, 457, 460,  
 . . . . . 470, 472  
 topography . . . . . 57, 106, 153, 155–157, 163, 168,  
 . . . . . 220–222, 332  
 topping . . . . . 126–128, 130, 134, 455, 456, 461  
 tower . . . . . 14, 59, 118, 119, 137, 263, 267, 273, 301, 302  
 tower house . . . . . 80, 241, 263–265, 267  
 transfer structure . . . . . 42, 301  
 transom . . . . . 116  
 transparent thermal insulation . . . . . 139, 143  
 transport . . . . . 52, 66, 78, 84, 85, 92, 95, 113, 114, 117,  
 . . . . . 162, 234, 280, 297, 321  
 trapezoidal profile metal sheet . . . . . 126  
 tree . . . . . 12, 82, 83, 104, 138, 195  
 trimmer . . . . . 91  
 truss . . . . . 15, 114, 135  
 trussed beam . . . . . 73  
 two-way span . . . . . 75, 277  
  
 U-value . . . . . 116, 187, 307, 382  
 ultraviolet radiation . . . . . 86, 186, 200, 214–216, 224  
 uncoated roof . . . . . 216, 224, 399, 475  
 underfloor heating . . . . . 295, 298, 299, 321, 340,  
 408, 410, 413, 419, 420, 423, 427, 429, 455–460  
 upside-down roof . . . . . 214, 217, 224, 399, 474, 480, 481  
  
 vapour barrier . . . . . 79, 81, 89, 90–93, 100, 101, 213,  
 . . . . . 215–218, 223, 224, 286, 289, 318  
 vapour check . . . . . 100, 174, 369, 419, 427, 429, 445,  
 . . . . . 447, 449  
 vapour diffusion . . . . . 46, 80, 163, 184, 200, 223, 224,  
 . . . . . 286, 307, 470, 471  
 vault . . . . . 15, 90, 137, 151, 153, 222, 245, 247, 253  
 veneer . . . . . 29, 84, 86, 88–90, 450  
 ventilated cavity . . . . . 286, 390, 391, 393, 397, 412, 415,  
 416, 421, 422, 425–427, 435, 439, 441, 445, 461, 465,  
 . . . . . 468, 473, 476, 481  
 ventilation . . . . . 80, 81, 99, 102, 110, 139, 153, 154, 166,  
 200, 205, 207, 213, 214, 218, 223, 272, 285, 290–292,  
 296, 297, 300, 301, 360, 373, 378–382, 390, 391, 397,  
 . . . . . 398, 419, 457  
 ventilation cavity . . . . . 80, 81, 102, 200, 218, 223, 397  
 veranda . . . . . 304, 305, 309, 311, 323, 324, 326, 328,  
 . . . . . 329, 481  
 villa . . . . . 111, 183, 196, 204, 220, 273, 299  
  
 waffle slab . . . . . 459  
 wall 12–15, 23–27, 35–37, 40–48, 50, 52–55, 64, 67,  
 69, 74, 76–82, 86, 89, 91, 93, 94, 96–98, 100–102,  
 107, 109, 114, 115, 121, 135, 136, 139, 140, 142, 143,  
 146–148, 151, 153, 159, 163–175, 184, 185, 192,  
 194–200, 202, 205–207, 210, 221, 224, 227, 235, 238,  
 239, 245–249, 251–255, 259, 262, 264–266, 268,  
 270, 274, 276, 278–283, 286, 288–292, 297, 299, 301,  
 306, 307, 311, 315, 317, 318, 320, 321, 324–327, 329,  
 334, 344, 345, 347–349, 355, 358, 367, 368, 371, 377,  
 378, 386, 396, 398, 399, 407, 410–412, 414–417, 427,  
 . . . . . 444, 448, 454, 466, 472, 473  
 wall construction . . . . . 13, 46, 139, 140, 288, 307, 318,  
 . . . . . 320, 321  
 wall plate . . . . . 50, 173, 347, 348  
 wall tie . . . . . 42  
 warm deck . . . . . 213–217, 223, 224, 399, 466, 467,  
 . . . . . 470–473, 476  
 water/cement ratio (w/c ratio) . . . . . 61, 66, 68  
 waterproofing 156, 184, 213–218, 223, 224, 318, 326,  
 . . . . . 377, 419, 466–469, 477  
 waterproofing layer . . . . . 214–217  
 wearing course . . . . . 214, 216, 224  
 weather . . . . . 14, 32, 36, 46, 52, 53, 60, 66, 77, 79, 86,  
 100, 110, 139, 140, 142, 143, 154, 162, 166–168, 178,  
 185, 200, 212, 213, 215, 224, 233, 278, 282, 284, 291,  
 . . . . . 292, 298, 328, 378, 398  
 weatherboarding . . . . . 425, 439  
 weatherstripping . . . . . 184  
 web . . . . . 73, 92, 103  
 wind . . . . . 70, 200, 224  
 window . . . . . 26, 46, 50, 53, 98, 115, 139, 143, 151, 172,  
 175–182, 184–187, 192–195, 200, 202, 203, 233,  
 253, 256, 264, 268, 278, 290, 292, 299, 300, 307–311,  
 318, 326, 329–331, 339, 340, 355, 358, 371, 379, 381,

..... 382, 391, 396–398, 408  
window frame . . . . . 115, 180, 200, 233, 381  
window reveal . . . . . 176  
wood welding . . . . . 94  
working drawing . . . . . 184, 325, 326, 335–340, 387,  
..... 388, 393  
workmanship . . . . . 28, 37, 48, 52, 53, 140, 278–280,  
..... 282, 290  
work size . . . . . 37  
  
zinc . . . . . 116, 211, 481

The translation of this book has been supported by:



---

**Element AG Tifers**

P. O. Box 107  
CH-1712 Tifers

Phone 026 494 77 77

Fax 026 494 77 78

[www.element.ch](http://www.element.ch)

[esat@element.ch](mailto:esat@element.ch)