

Basic nursing skills



Basic nursing skills

- Basic nursing procedures (washing, positioning, help with eating, excreting, moving etc.)
- Pain management
- Bedsores
- Measurements :
 - Blood pressure
 - Pulse
 - Temperature
 - EKG
 - Injections – i.m., s.c., i.v.

Basic nursing equipment

Bedpan

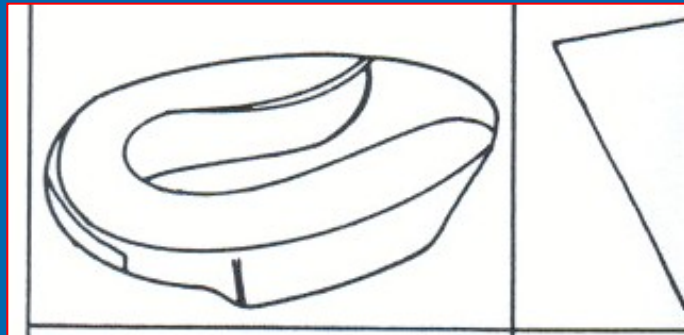

urinal

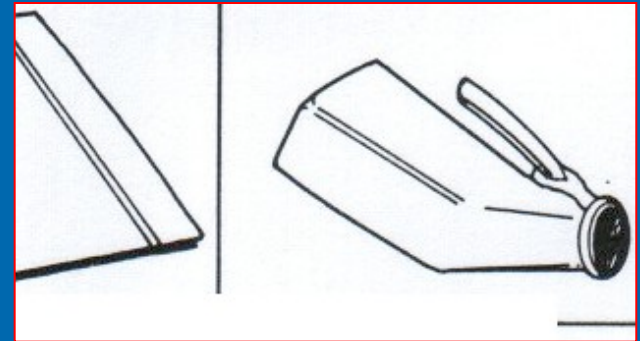

wash basin with soap and towel

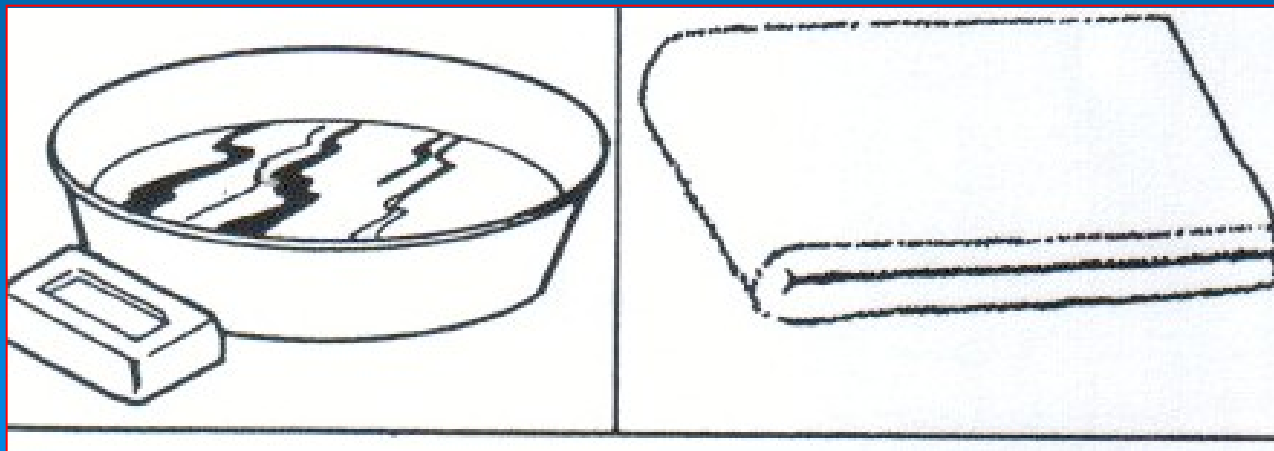

Help patients with excreting

How you can give the bedpan to the patients when is lying or sitting

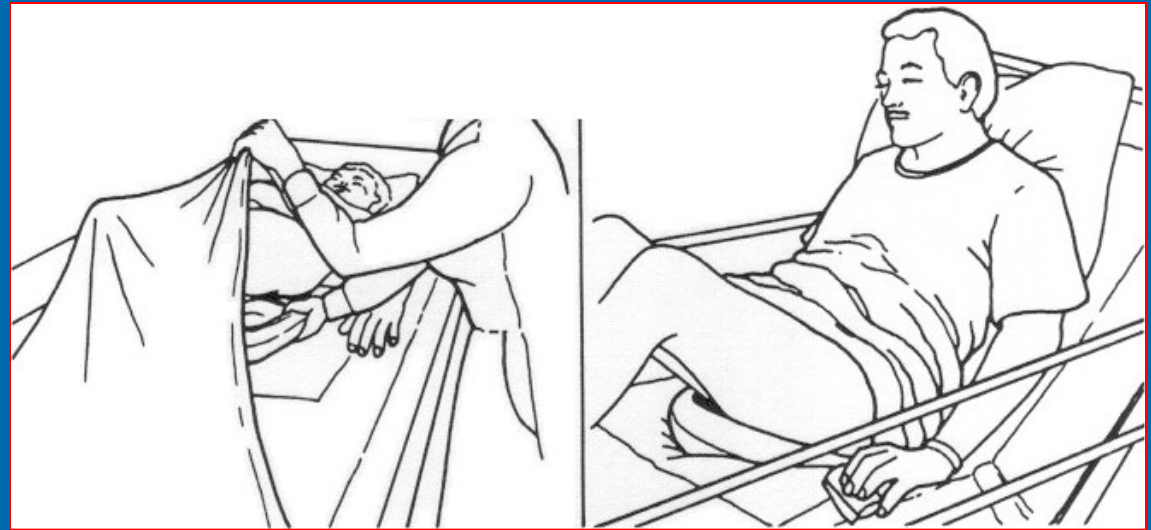

How you can give the bedpan to the patients when he cannot lift hipp

How to help patient with moving



Helping a patients to stand

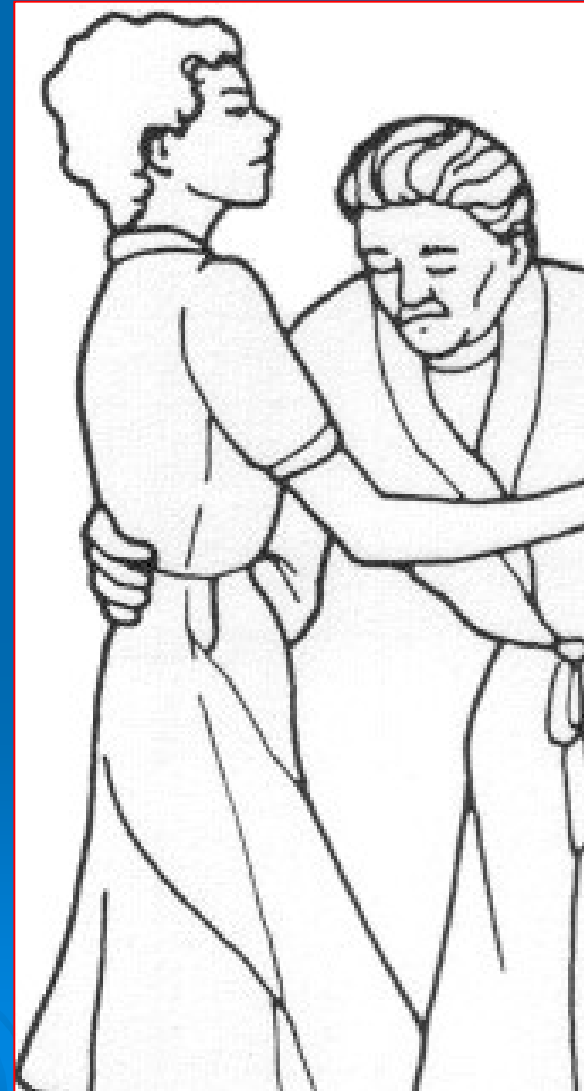

Positions in the bed

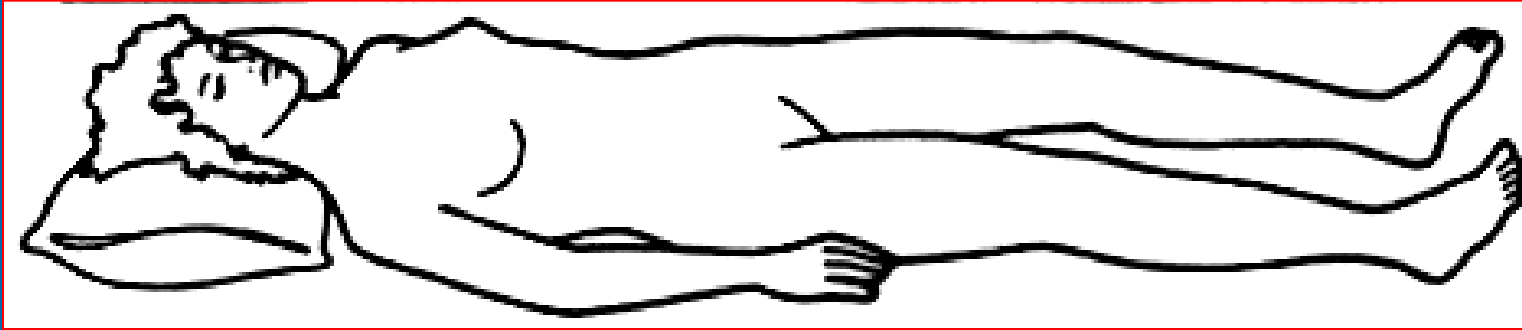

Supine – dorsal position

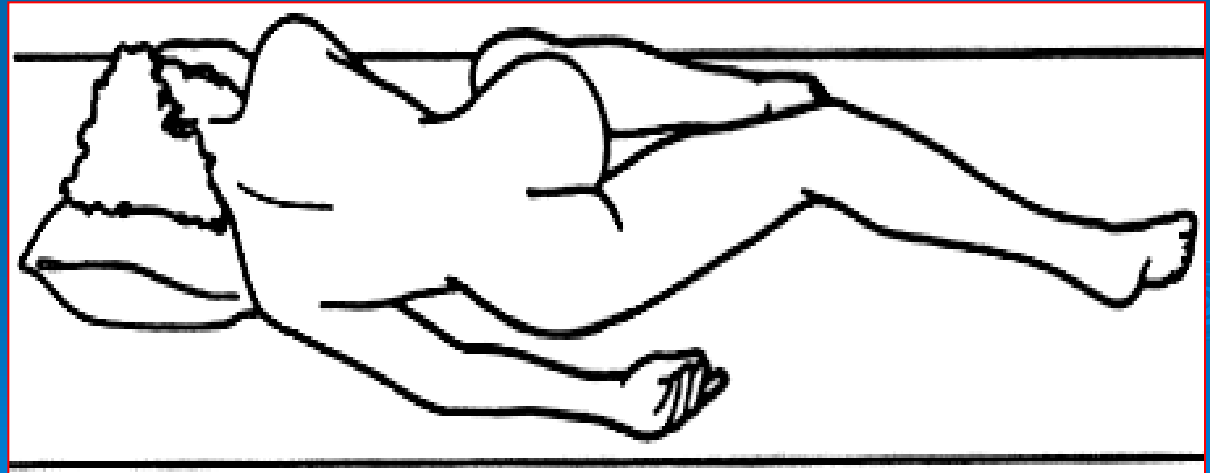

Sim's position also using for the rectal examination and rectal treatment

Positions in the bed

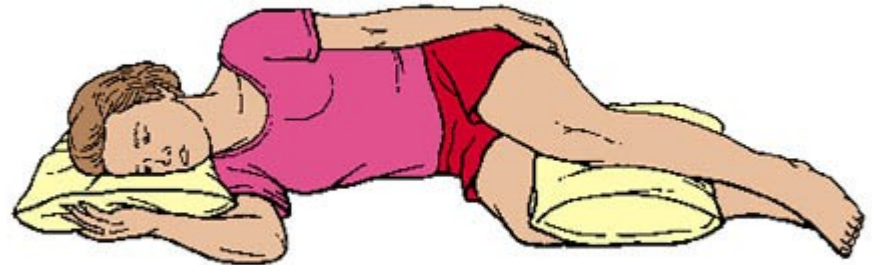
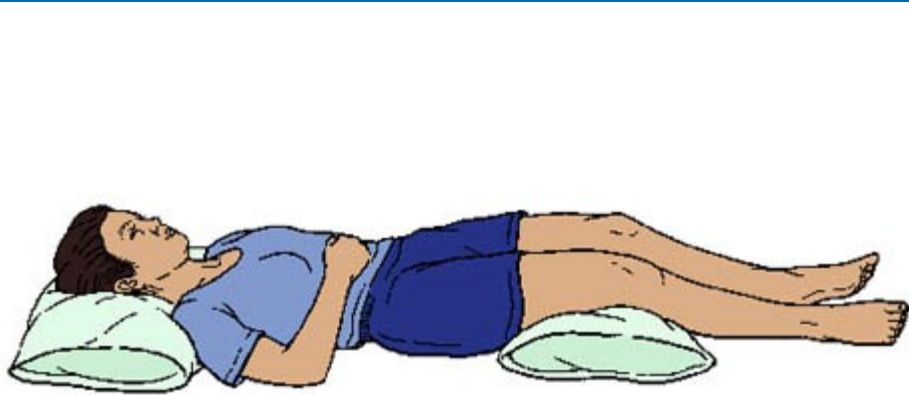

Positions in the bed



Fowler's position

Trendelenburgh position



Examination position

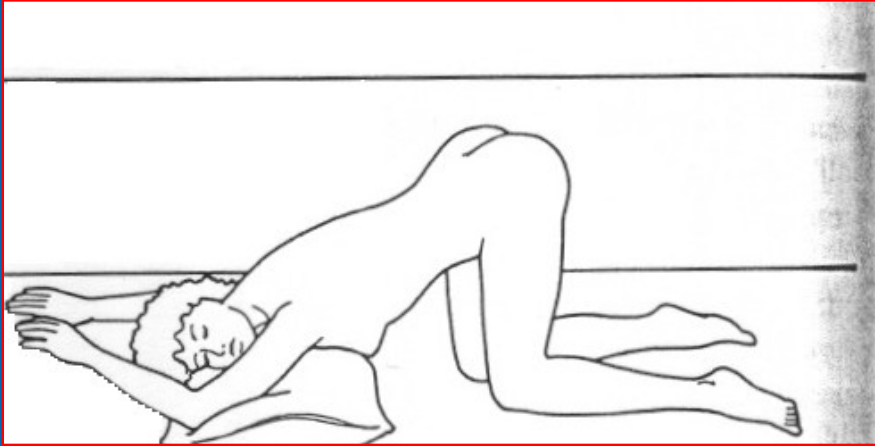

Knee-chest position
– used for rectal or vaginal examination

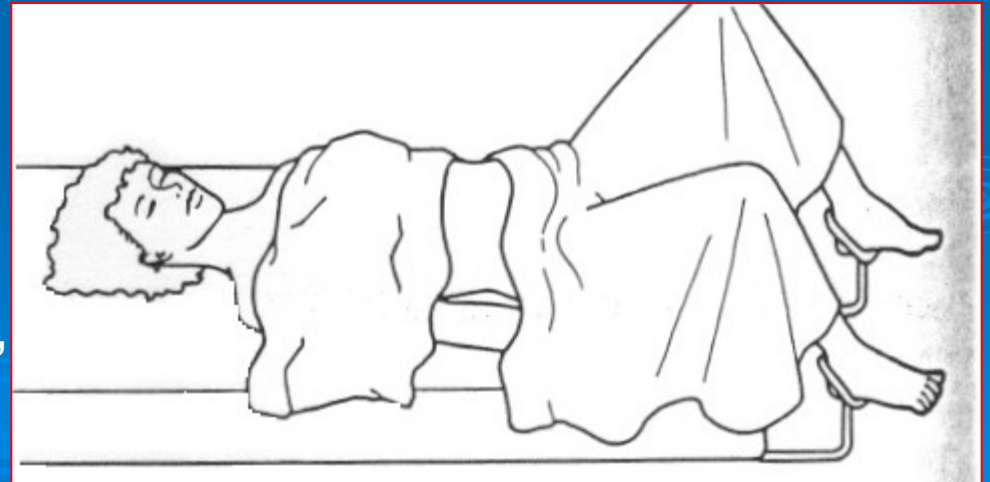

Lithotomy position – using for rectal, vaginal and bladder examination

