

UV VIS spektrometrie

molekulová absorpční spektrometrie

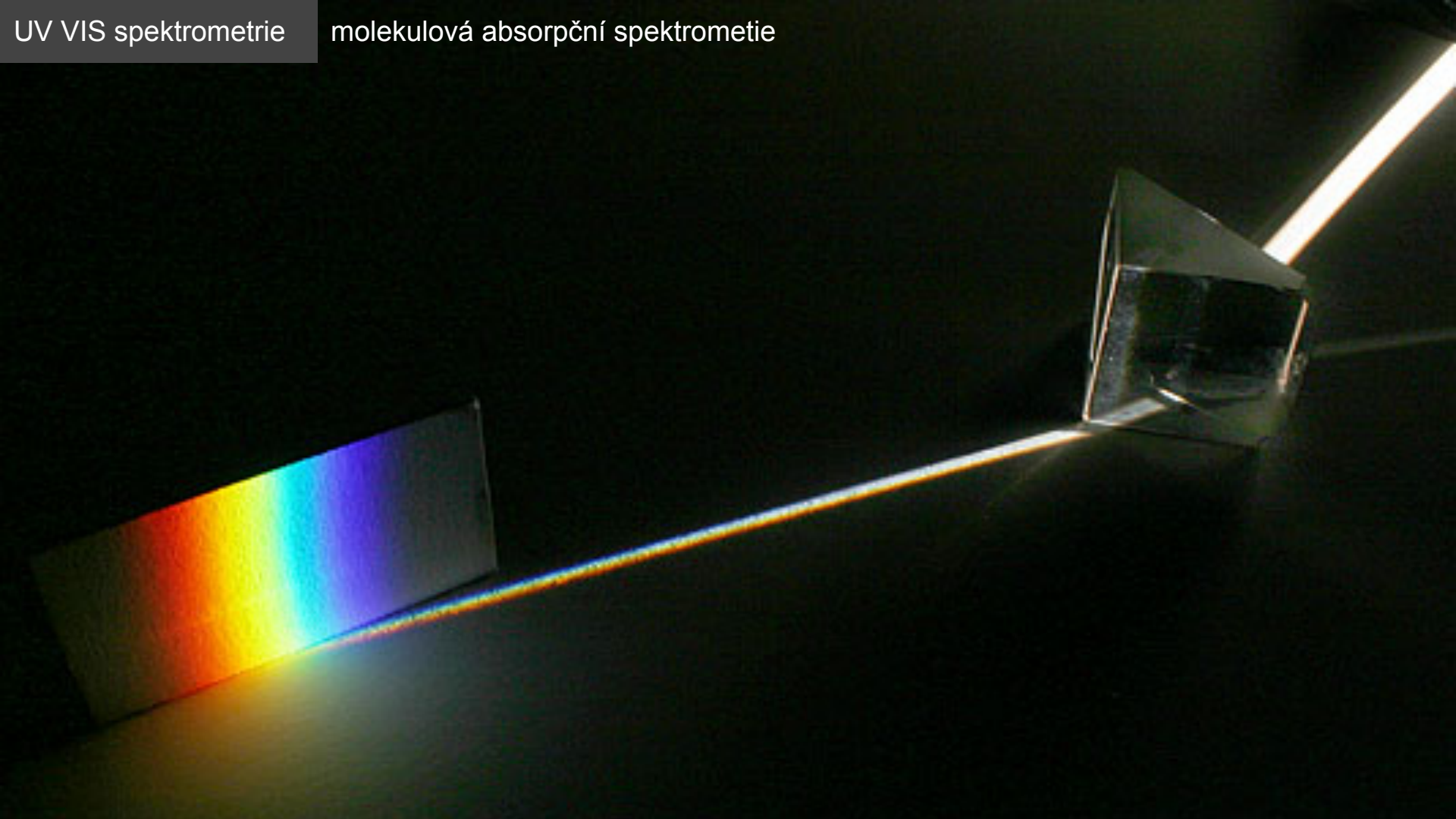

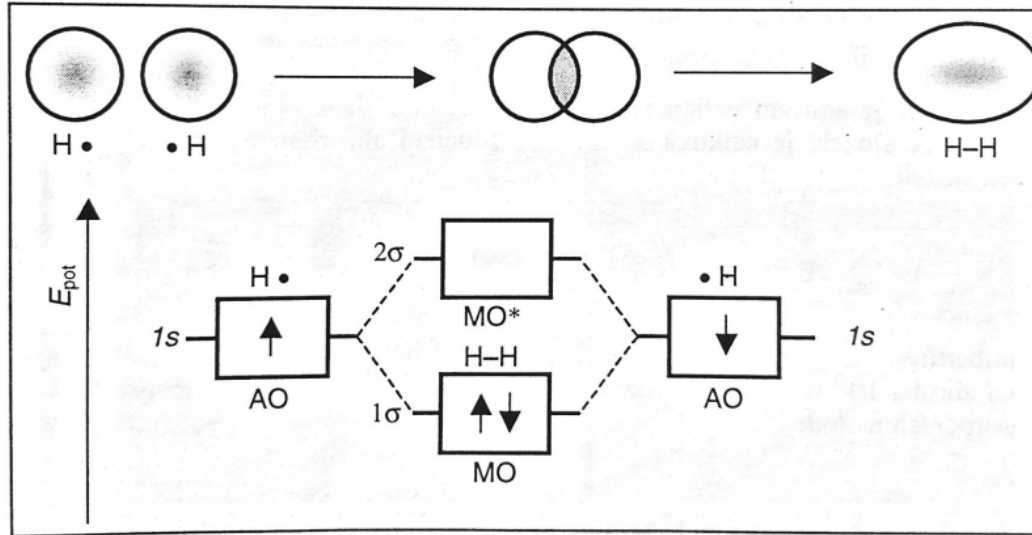

Označení	λ	Absorbující látky
Vzdálená ultrafialová oblast far UV (vakuová oblast)	<190 nm	nasyčené sloučeniny monoénové sloučeniny
Blízká ultrafialová oblast near UV	190-380 nm	polynenasycené a aromatické sloučeniny
Viditelná oblast VIS	380-780 nm	barevné látky

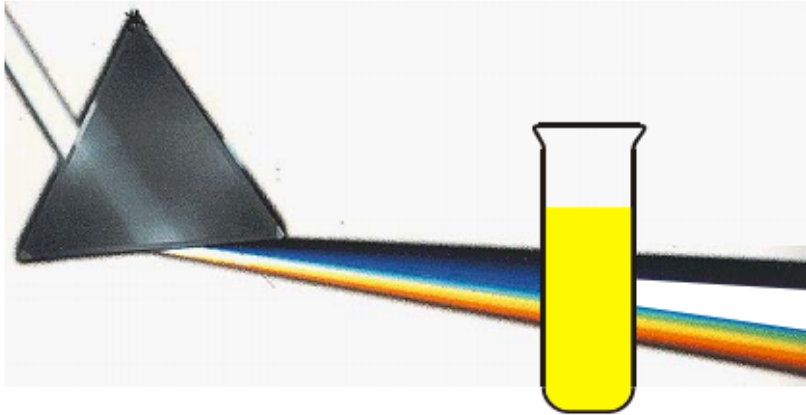

absorpce komplementární složky



koláč komplementárních barev

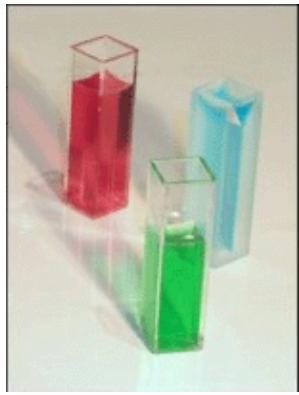
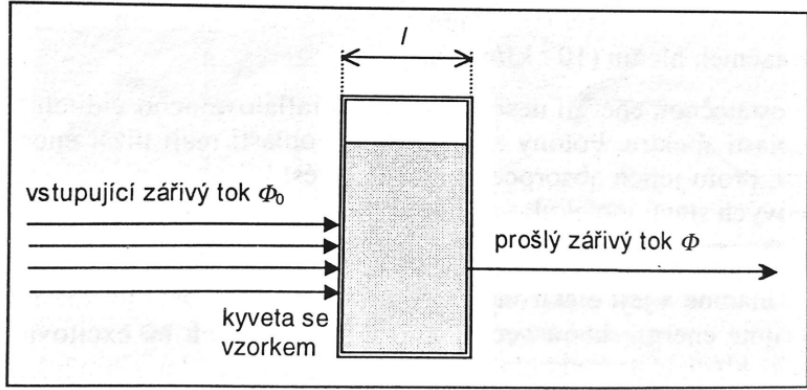

Transmittance

$$T = \frac{\Phi}{\Phi_0} \quad T = \frac{\Phi}{\Phi_0} 100 (\%)$$

Φ_0 dopadající zářivý

Φ prošlý zářivý tok

Absorbance

$$A = -\log T = \log \frac{\Phi_0}{\Phi}$$

$$A = \varepsilon \cdot c \cdot l$$

ε .. molární absorpční koeficient

c .. koncentrace

l .. délka optické dráhy

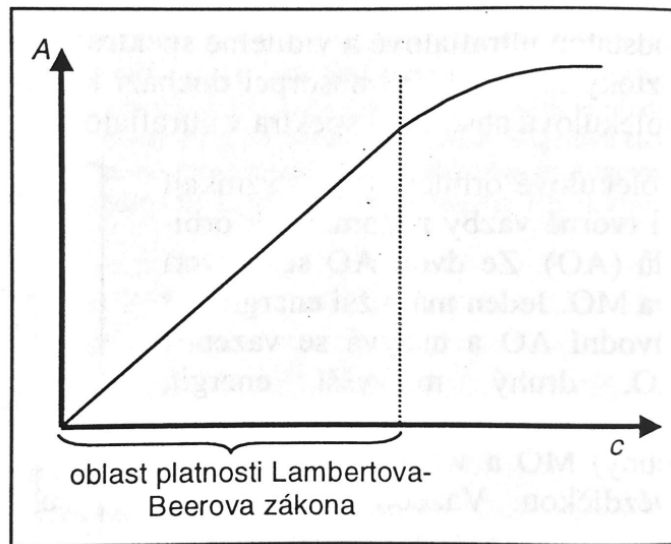
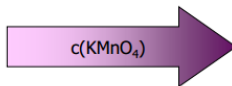

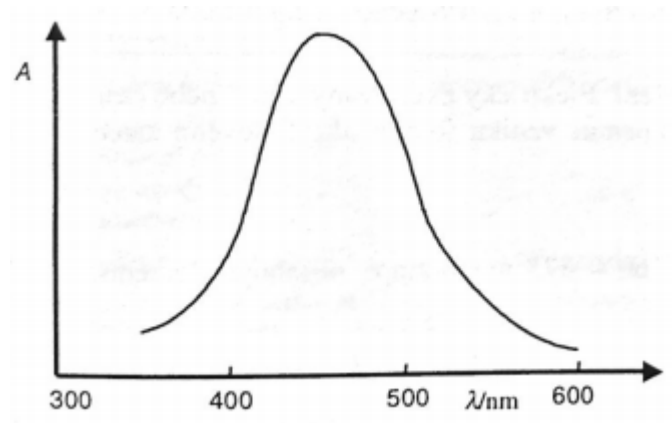

elektronové absorpční spektrum 4-chlor-2-nitrofenolu



schéma přechodů elektronu při absorpci UV/VIS



kolorimetr podle Wolffa

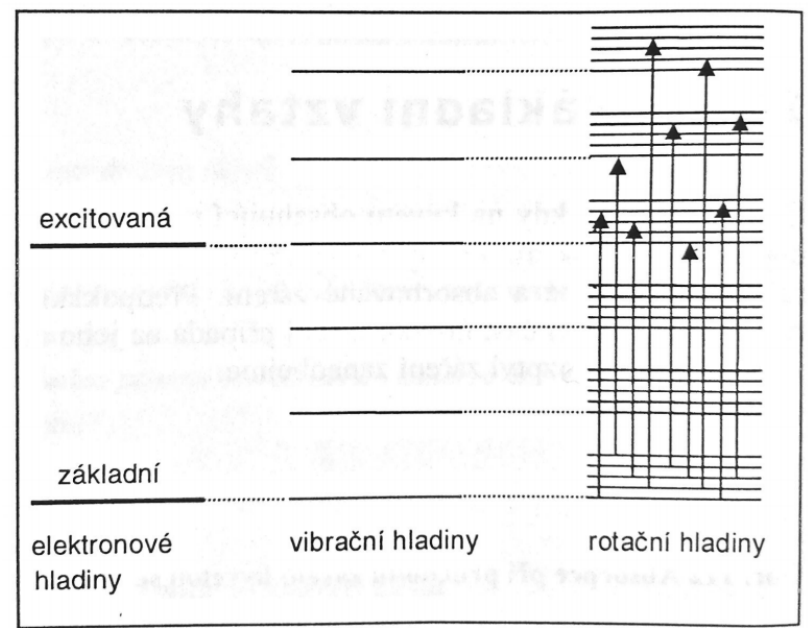
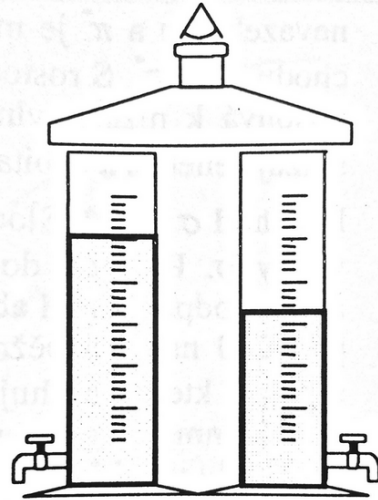
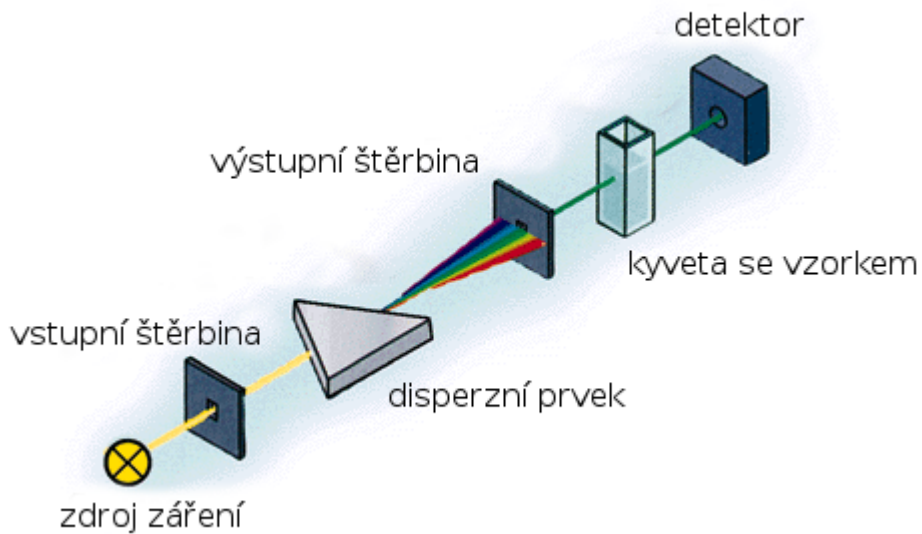

základní schéma spektrofotometru



UV VIS spektrometr

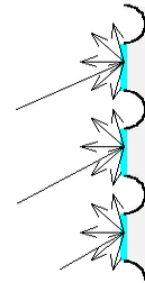
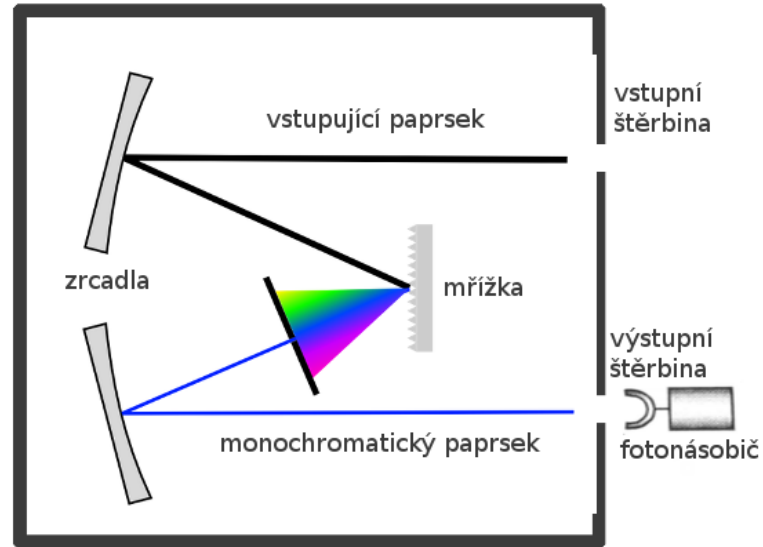

monochromátor konstrukce Czerny-Turner

