

# **SOMATOSENSORY AND VISCEROSENSORY PATHWAYS**

# SOMATOSENSORY SYSTEMS

- ❑ inform about objects around us through touch
- ❑ inform about position and movements of our body parts (proprioception)
- ❑ monitor the temperature
- ❑ inform about painful, itchy and tickling stimuli

The cell bodies of the first-order somatosensory afferent neurons are located in posterior root or cranial root ganglia

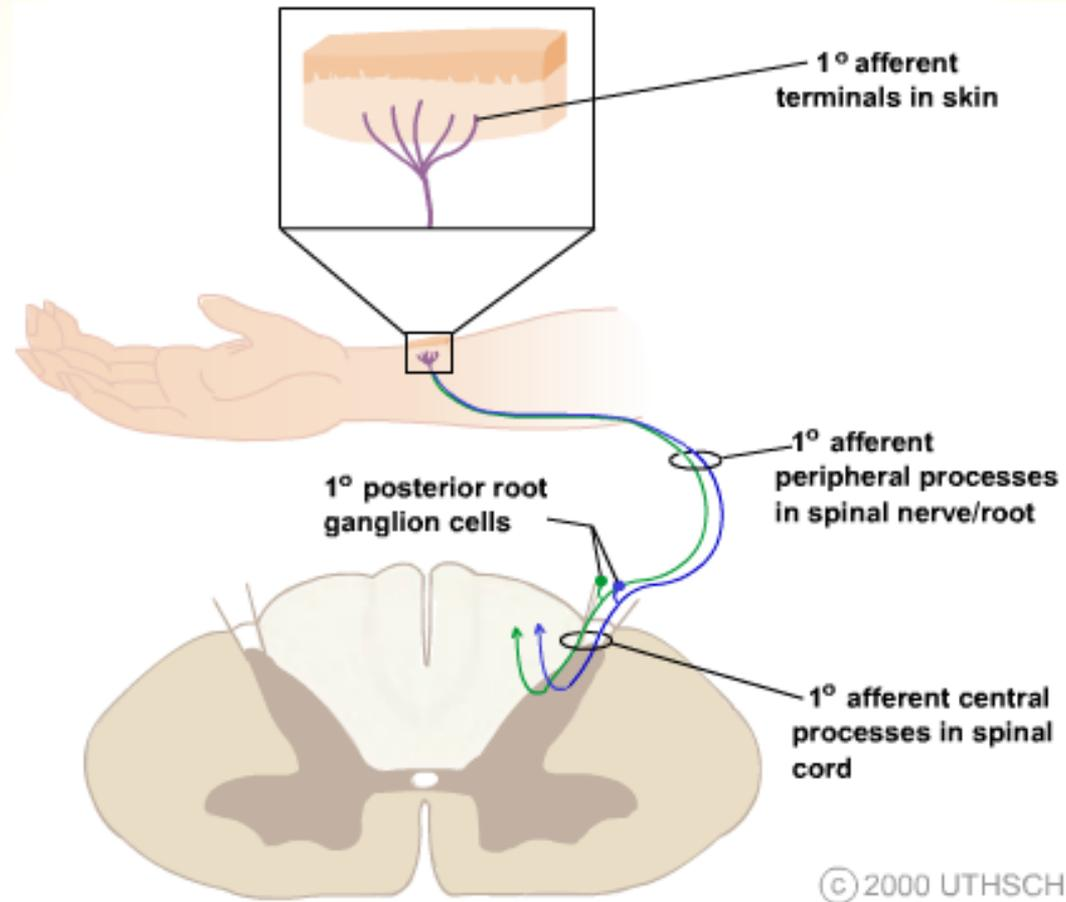

All the peripheral terminal branches of a 1° axon form only one type of somatosensory receptor.

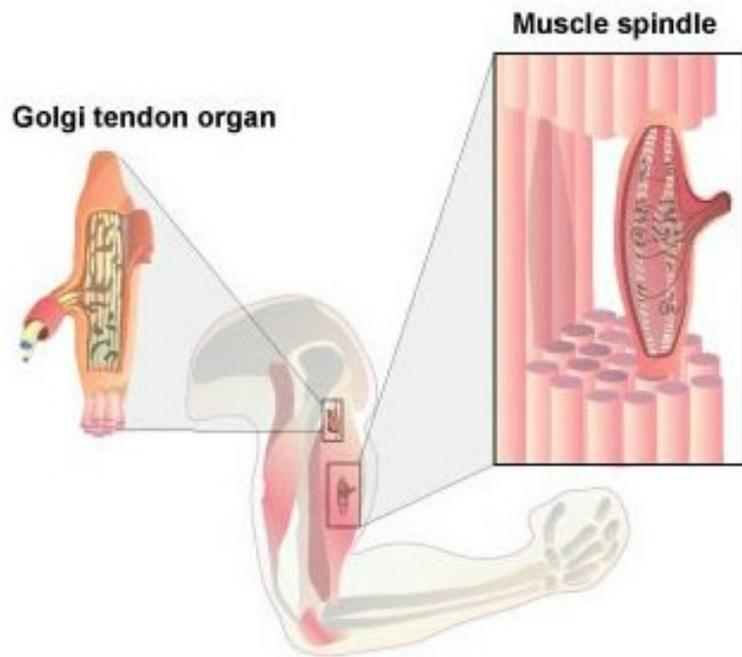
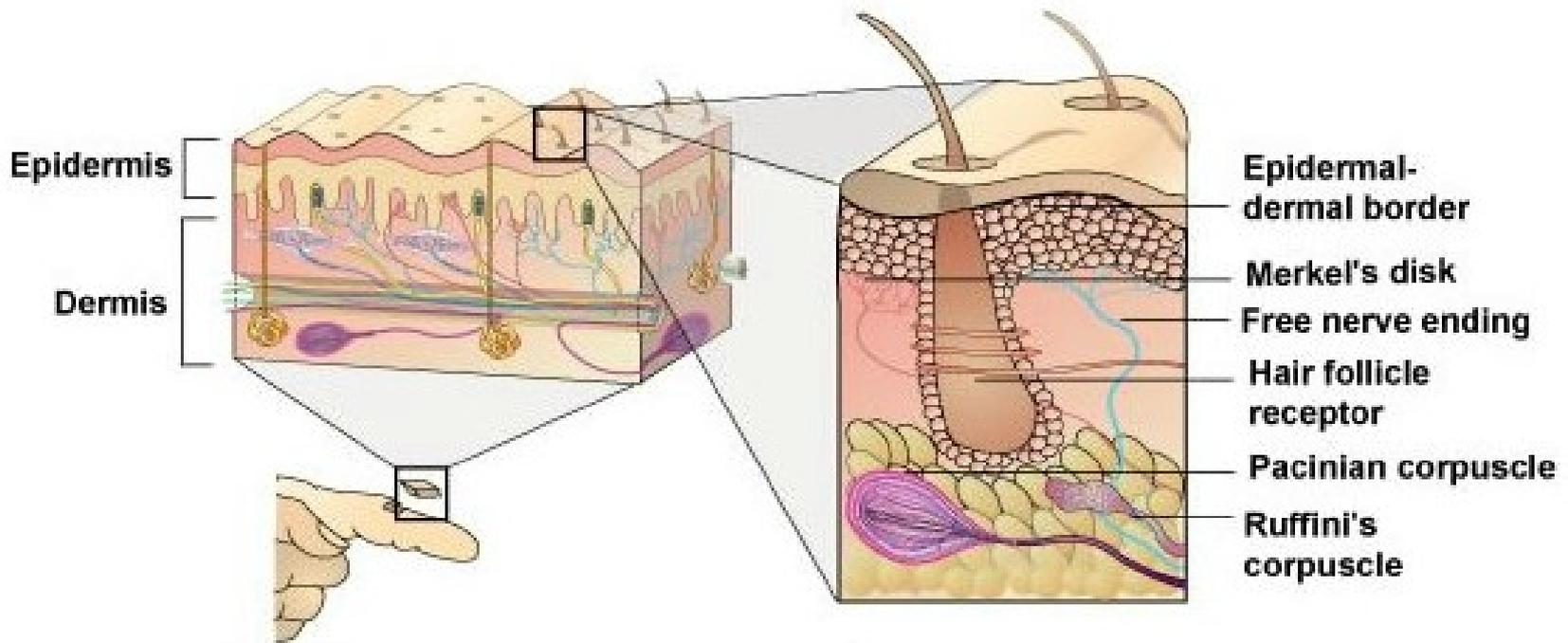

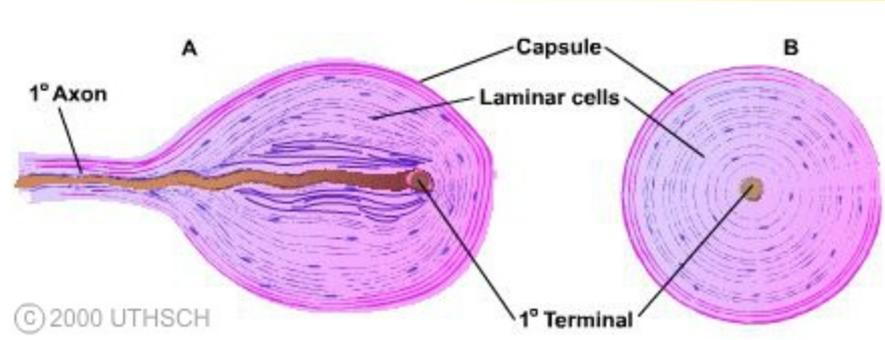
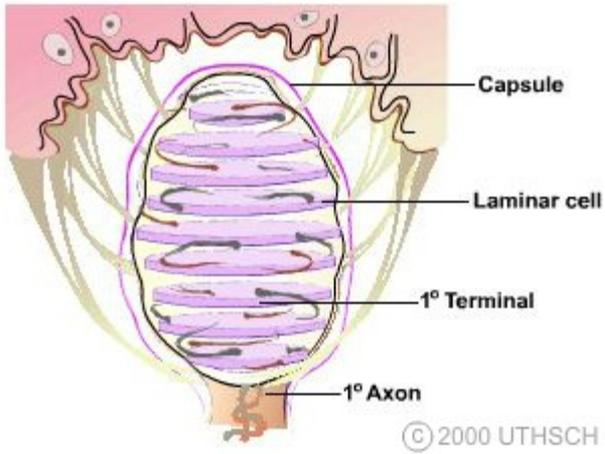

**Pacinian corpuscle**

**Meissner corpuscle**

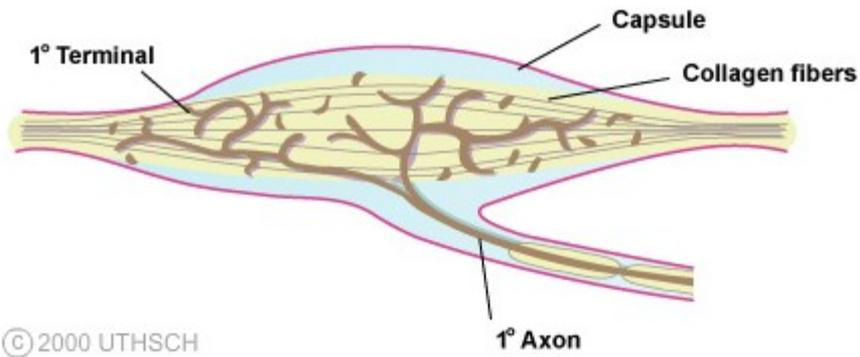

**Ruffini corpuscle**

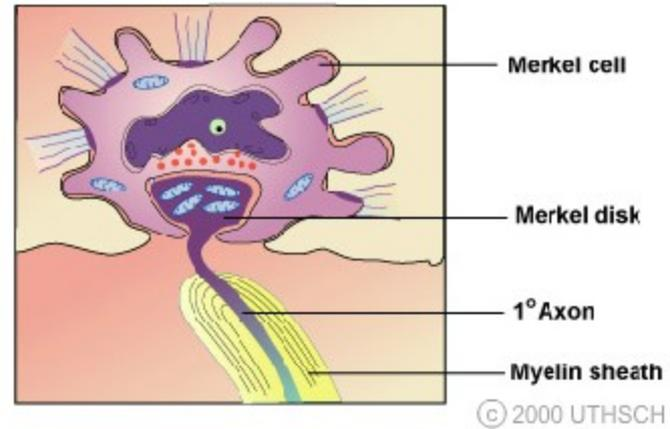

**Merkel complex**

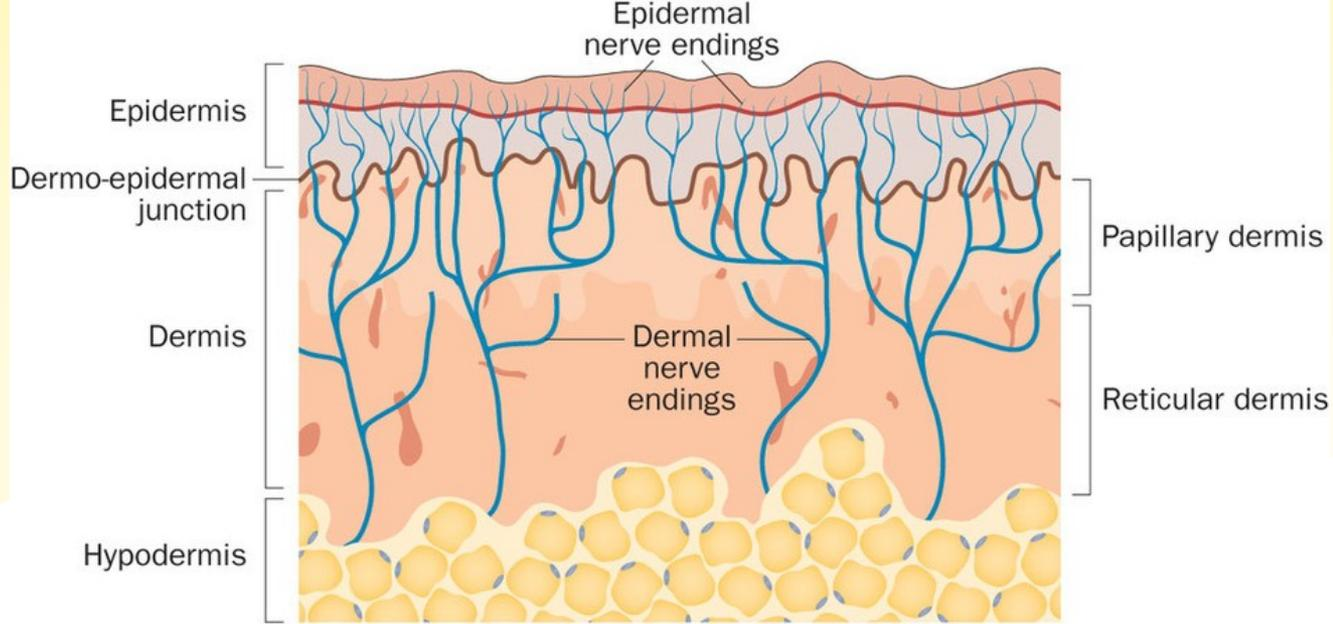

## Free nerve endings

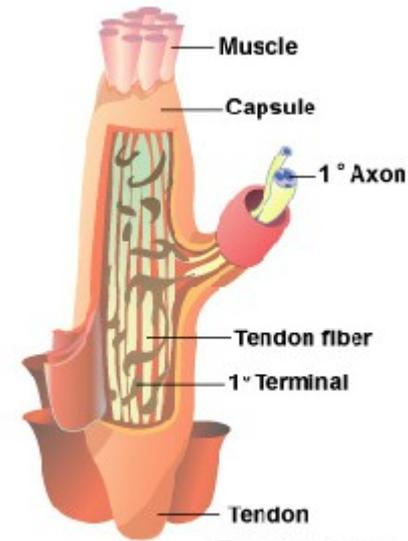
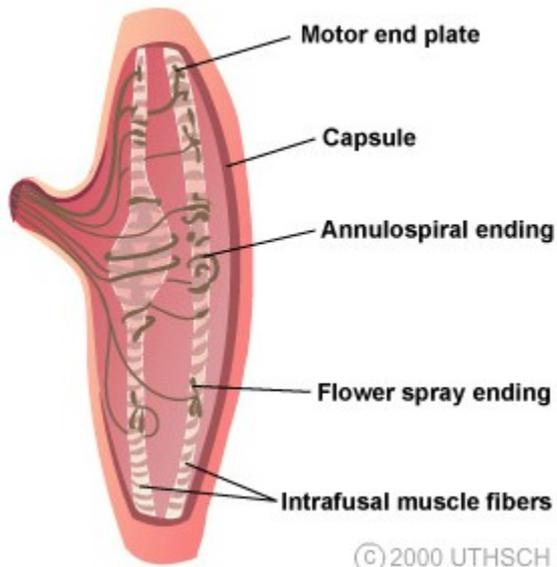

**Muscle spindle**

**Golgi tendon organ**

© 2000 UTHSCH

© 2000 UTHSCH

# Peripheral Somatosensory Axons

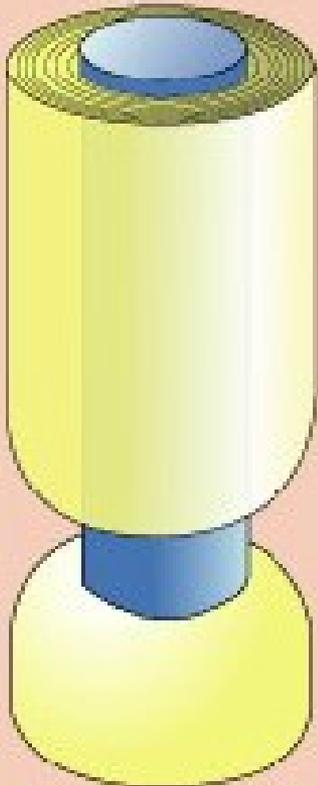
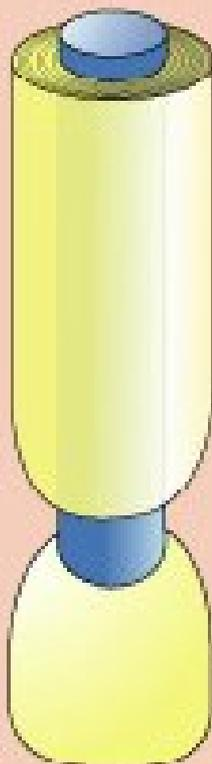
	$A\alpha$	$A\beta$	$A\delta$	C
1° Axon to skin				
1° Axon to muscle				
	<b>Group I</b>	<b>Group II</b>	<b>Group III</b>	<b>Group IV</b>
				
Diameter (um)	12-20	6-12	1-6	0.2-1.5
Speed(m/sec)	70-170	30-70	5-30	0.5-2
Sensory receptors	<b>Proprioceptors of skeletal muscle</b>	<b>Mechanoreceptors of skin</b>	<b>Pain, temperature</b>	<b>Temp, pain, itch</b>

The 1° afferent is a pseudounipolar neuron that has its cell body located in a peripheral (spinal or cranial) ganglion.

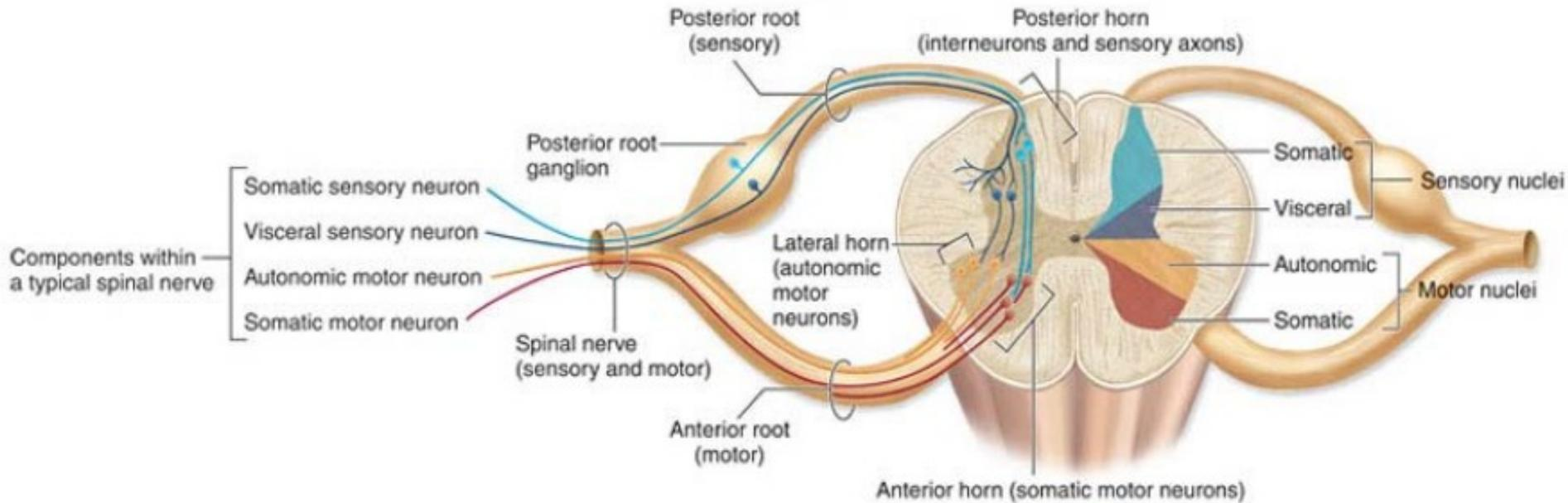

# Spinal cord gray matter

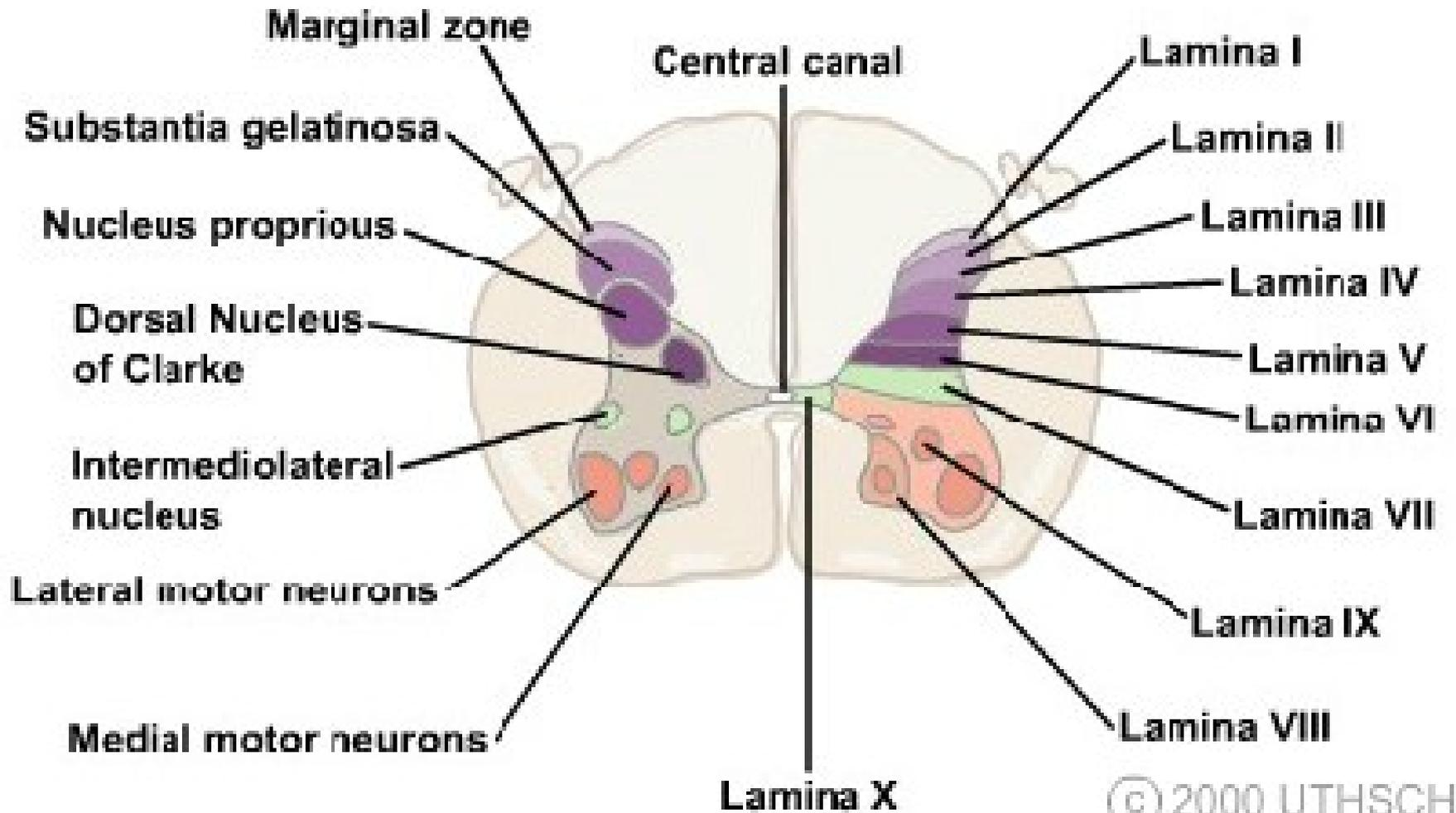

<b>lamina (Rexed 1952)</b>	<b>nuclei</b>
I	ncl. apicalis (ncl. posteromarginalis)
II + III	substantia gelatinosa Rollandi
IV + V	ncl. proprius
VI	ncl. thoracicus (Stilling – Clark's ncl.) C8-L3
VII	substantia intermedia
VIII	medial group of motoneurons
IX	lateral group of motoneurons
X	zona centralis, the grey substance around the central canal

# Spinal cord grey matter

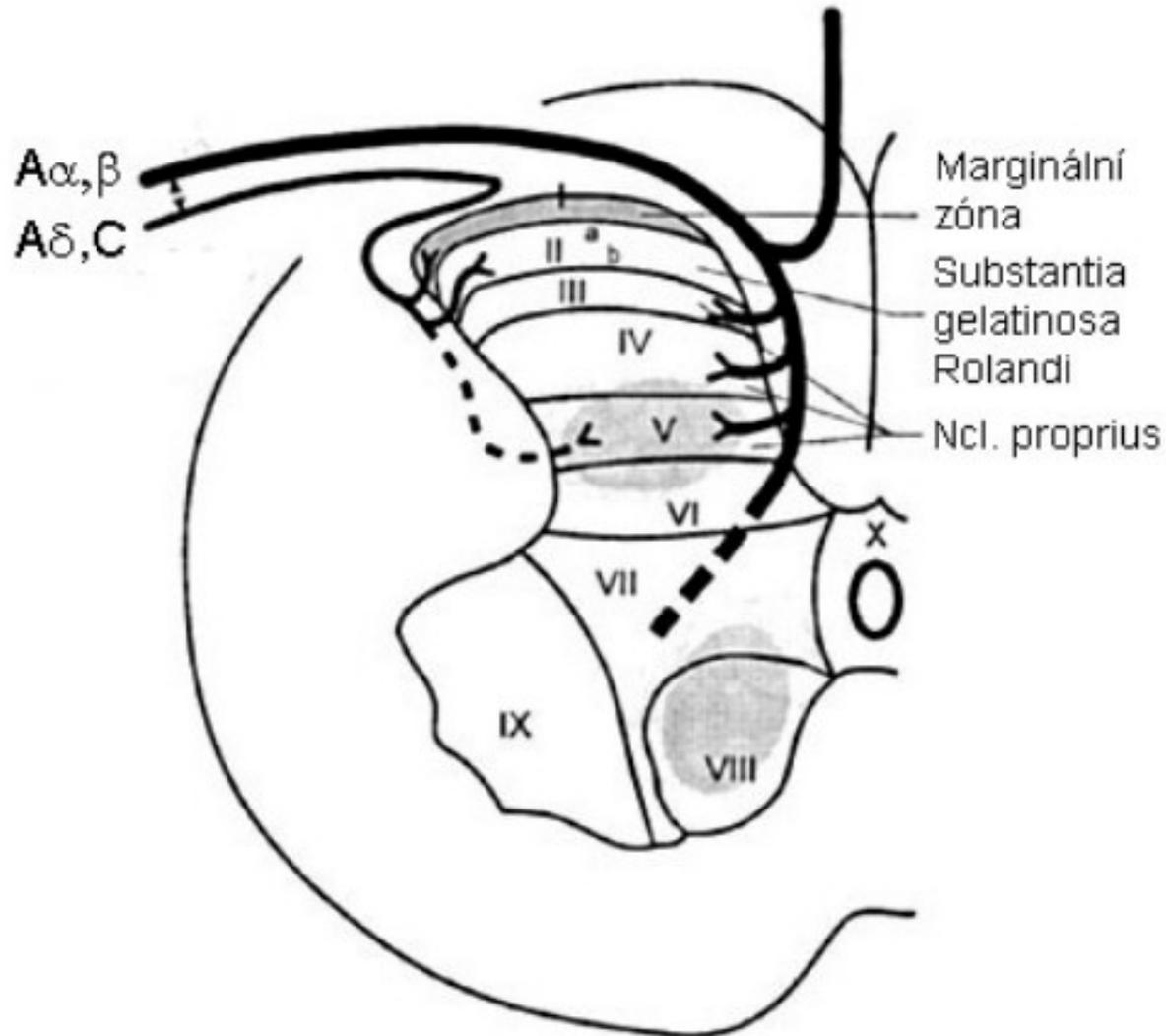

# Lemniscal system

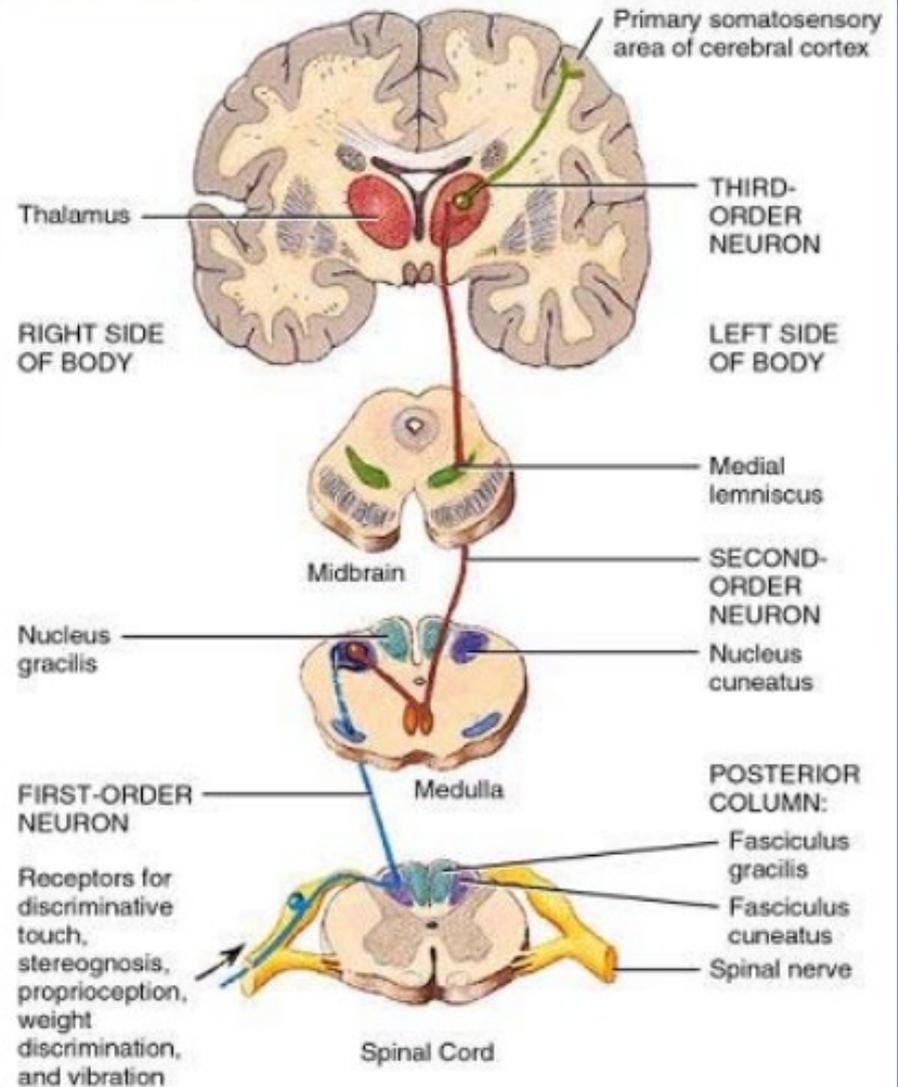
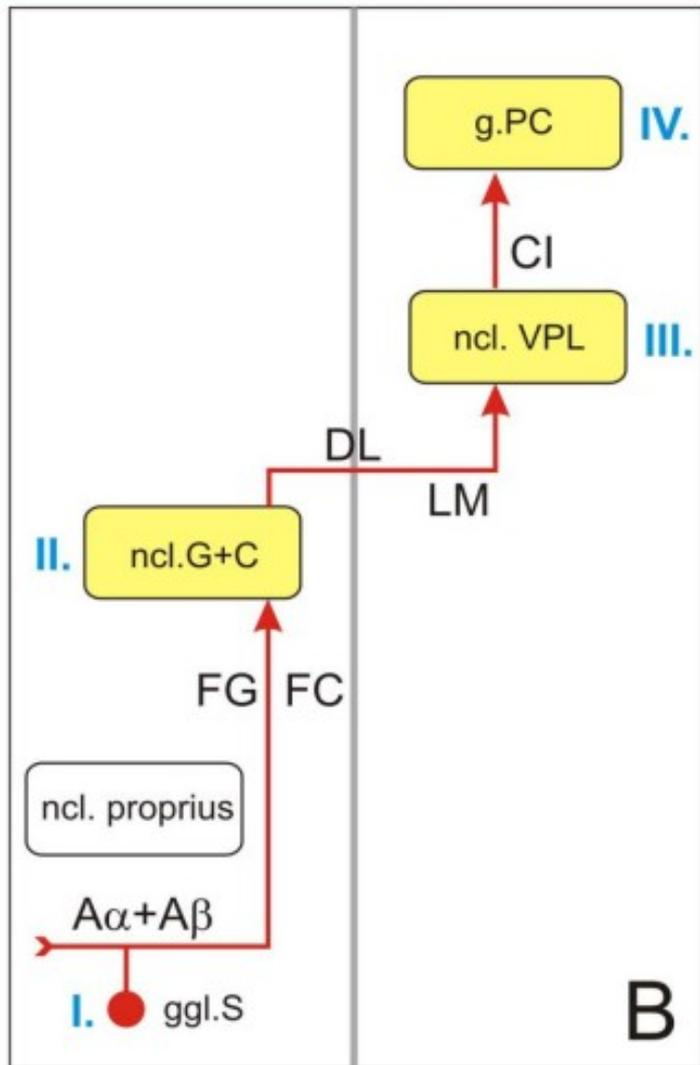

# Anterolateral system

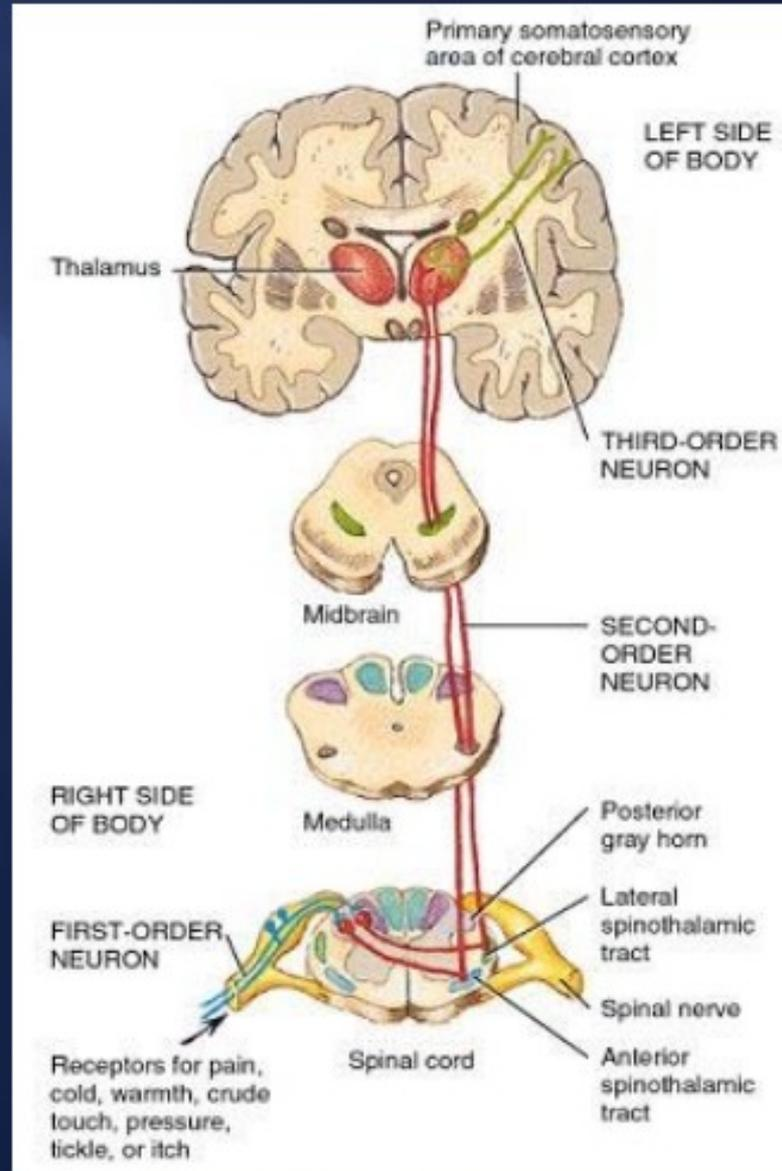
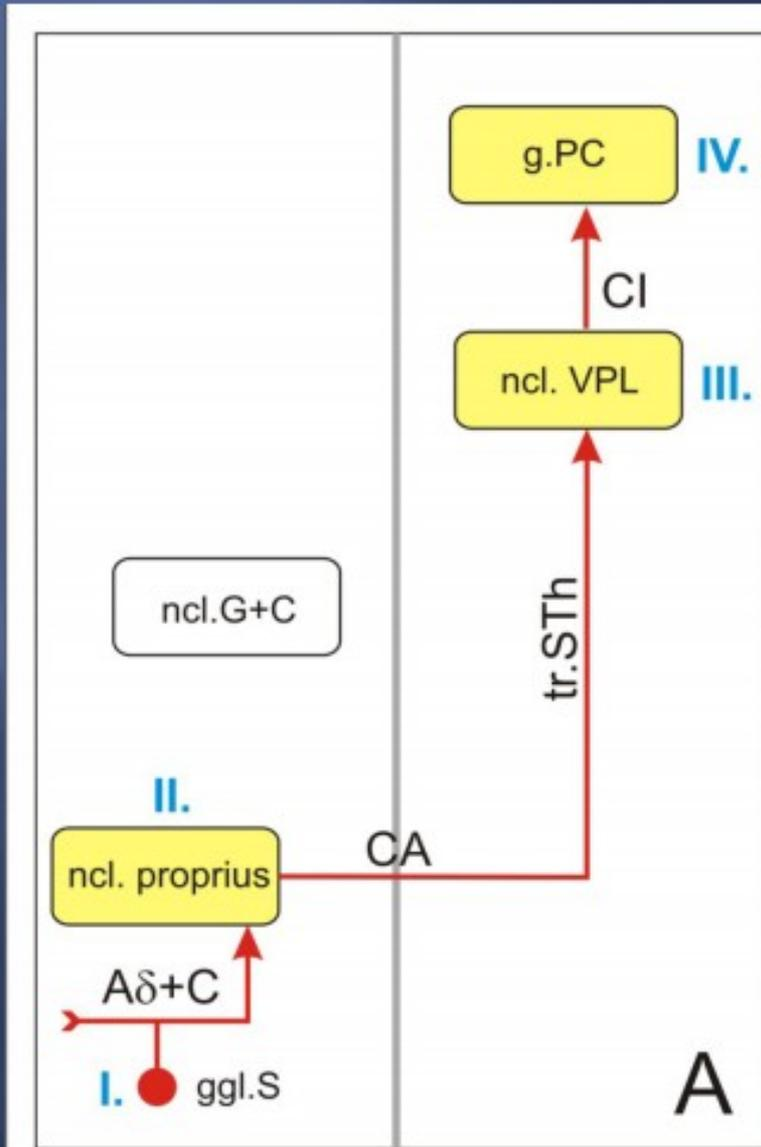

# Anterolateral system

- ❑ Anterior spinothalamic tract
- ❑ Lateral spinothalamic tract

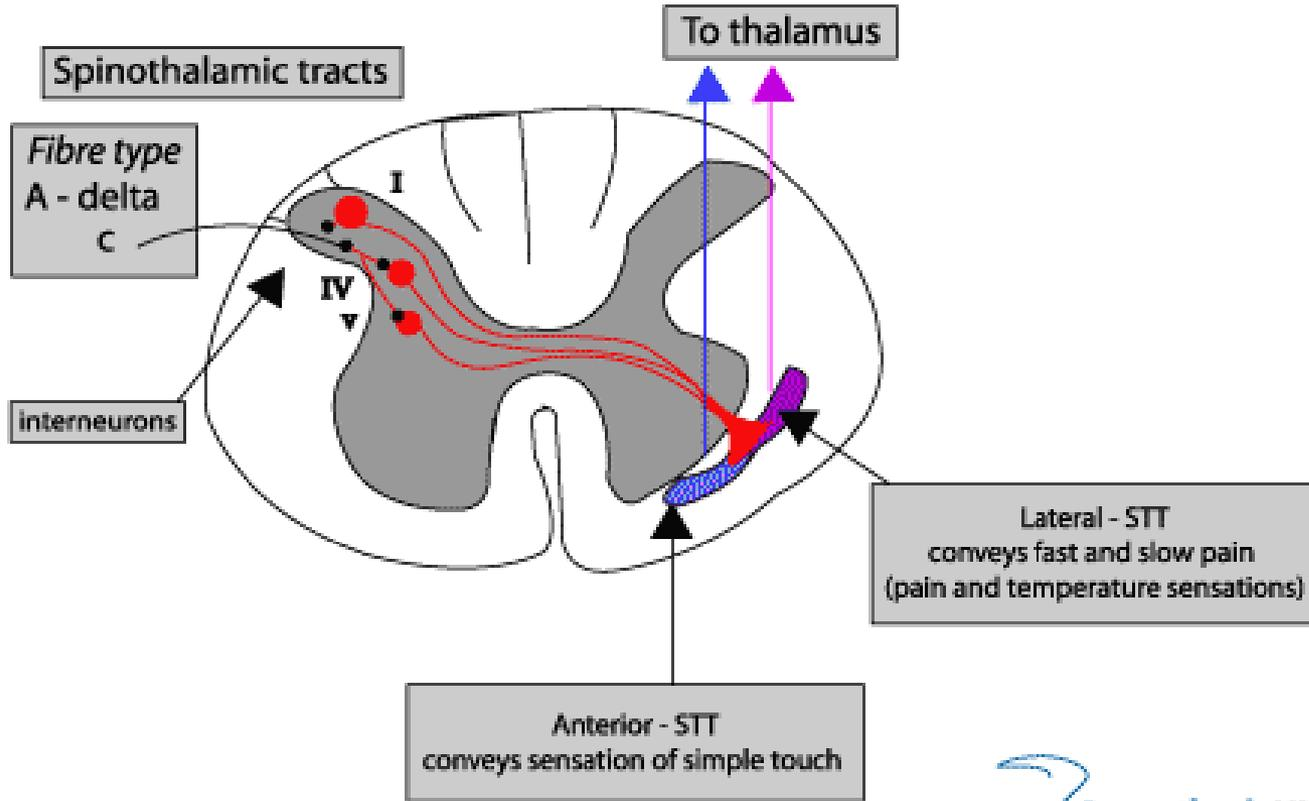

# Somatosensory pathways

## Lemniscal system

- younger
- perception with high discrimination ability
- discriminative touch, proprioception

## Anterolateral system (neospinothalamic pathway)

- older
- perception with low discrimination ability
- crude touch, pain and temperature

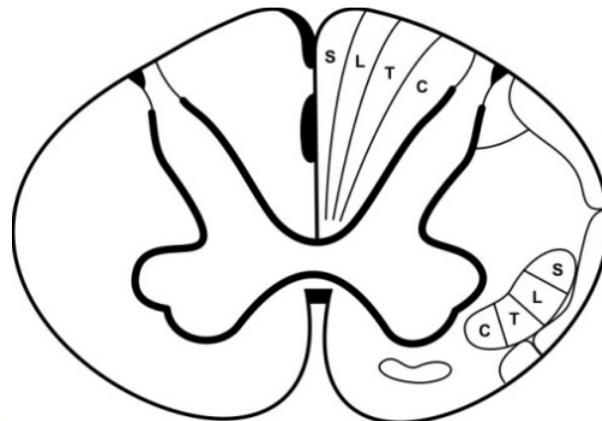

## Spinoreticular tract

(paleospinothalamic pathway)

- the oldest
- **not** somatotopically arranged
- arouses the cerebral cortex (ARAS)
- report to the limbic cortex about the nature of a stimulus

# Proprioception

- ❑ **static component of proprioception**
  - information from UL and LL mediates one pathway
- ❑ **dynamic (kinesthetic) component of proprioception**
  - information from UL and LL mediate separate pathways



**Spinal cord** - reflexes

**Cerebellum** - coordination of movements

**Cerebral cortex** - conscious proprioception

# Non-conscious proprioception

static

dynamic

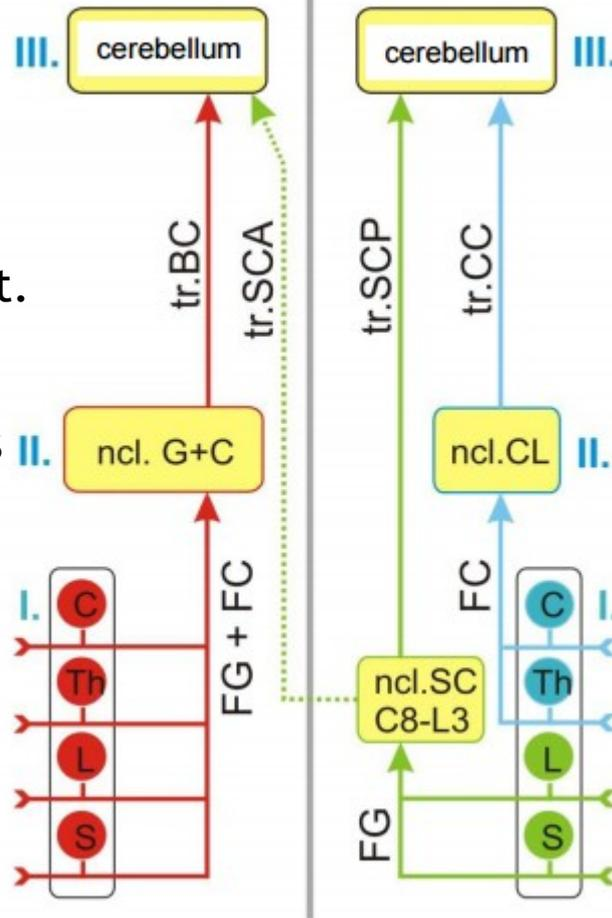

tr. bulbo cerebellaris  
tr. spinocerebellaris ant.

ncl. gracilis et cuneatus

fasciculus gracilis  
et cuneatus

tr. cuneocerebellaris  
tr. spinocerebellaris post.

ncl. cuneatus lateralis

fasciculus cuneatus

ncl. Stilling-Clark

fasciculus gracilis

# Conscious proprioception

## ❑ static proprioception

- DRG - fasciculus gracilis et cuneatus - gracile and cuneate (bulbar) nuclei - tr. bulbo-thalamo-corticalis - SI

## ❑ dynamic proprioception

- LL + caudal part of trunk  
tr. spinocerebellaris post - ncl. Z (rostral to gracile ncl.) - medial lemniscus - ncl. VPL thalami - SI
- UL + cranial part of trunk  
lateral cuneate ncl. - contralateral medial lemniscus - ncl. VPL thalami - SI

static

dynamic

gyrus postcentralis (SI)

tr. thalamocorticalis

tr. bulbothalamicus (lemn. med.)

ncl. gracilis et cuneatus

fasciculus gracilis  
et cuneatus

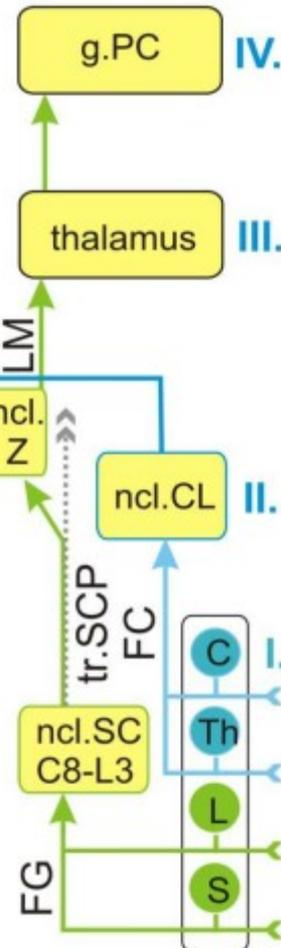
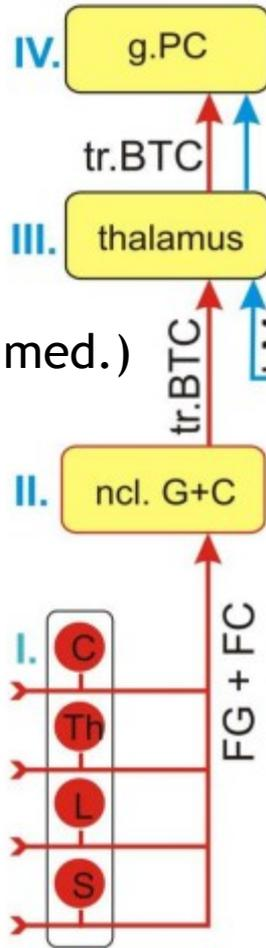

gyrus postcentralis (SI)

lemniscus medialis

ncl. cuneatus lateralis

fasciculus cuneatus  
tr. spinocerebell. post.

ncl. Stilling-Clark

fasciculus gracilis

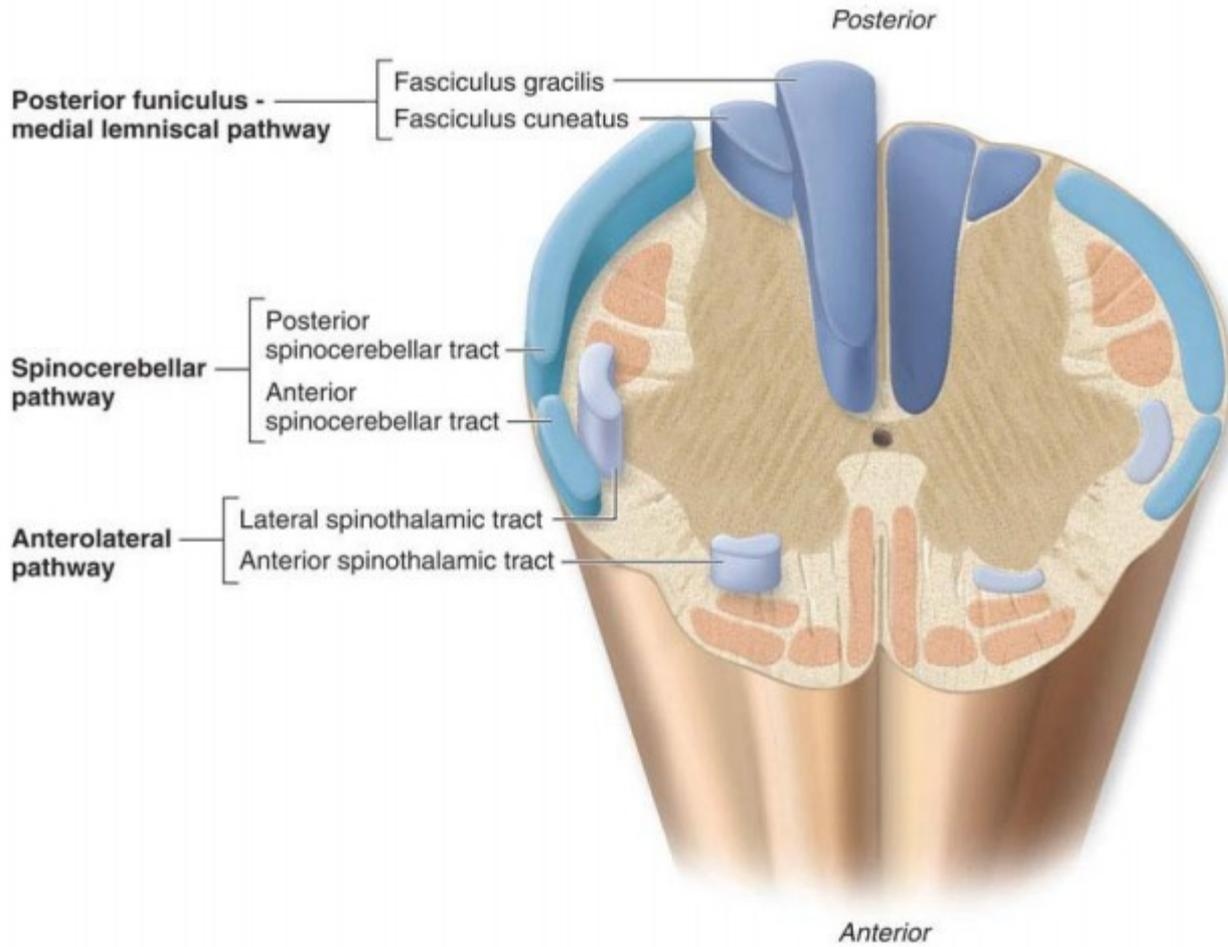

# CN V

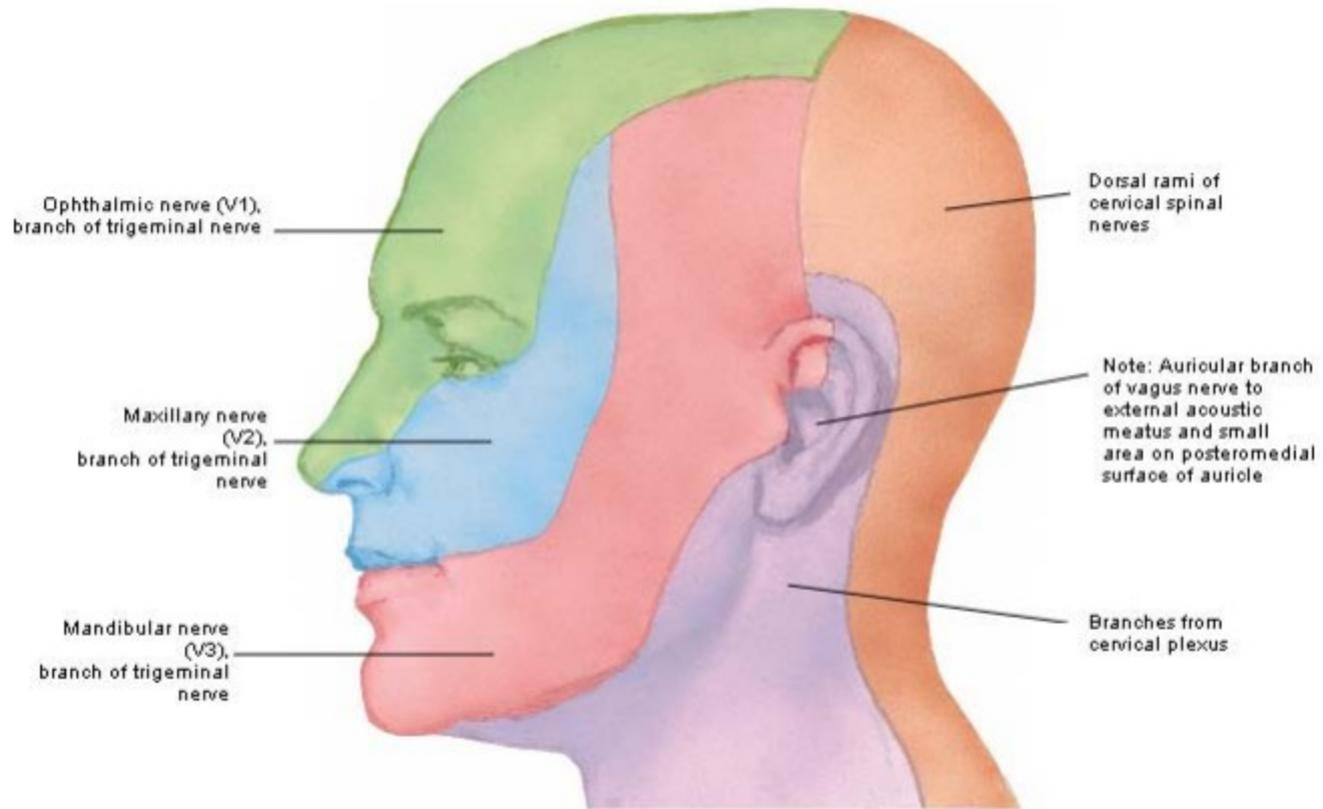

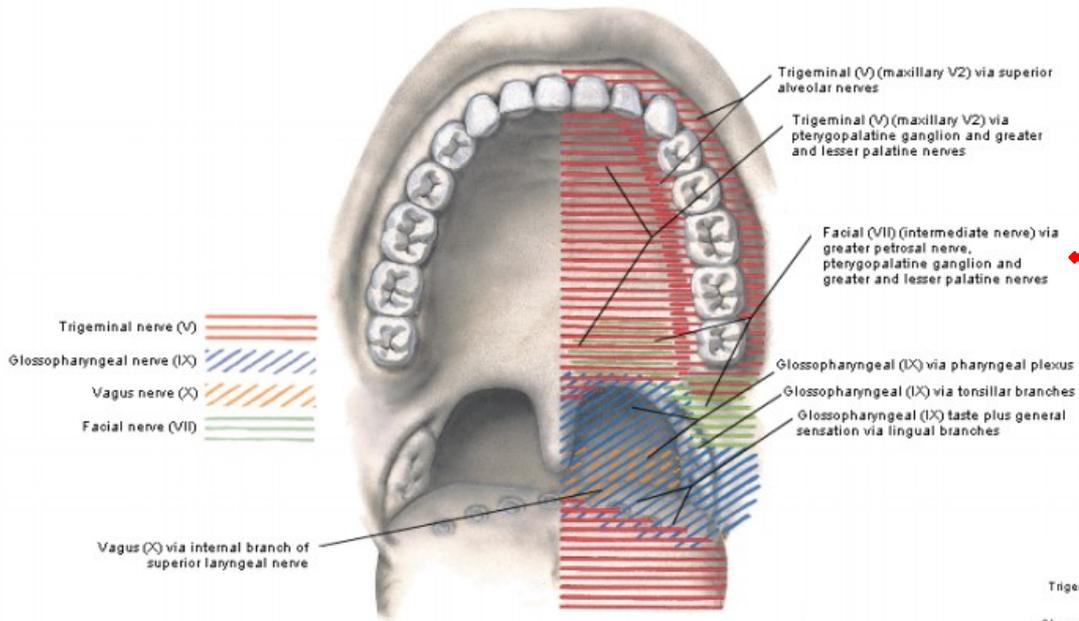

Maxillary nerve

Mandibular nerve

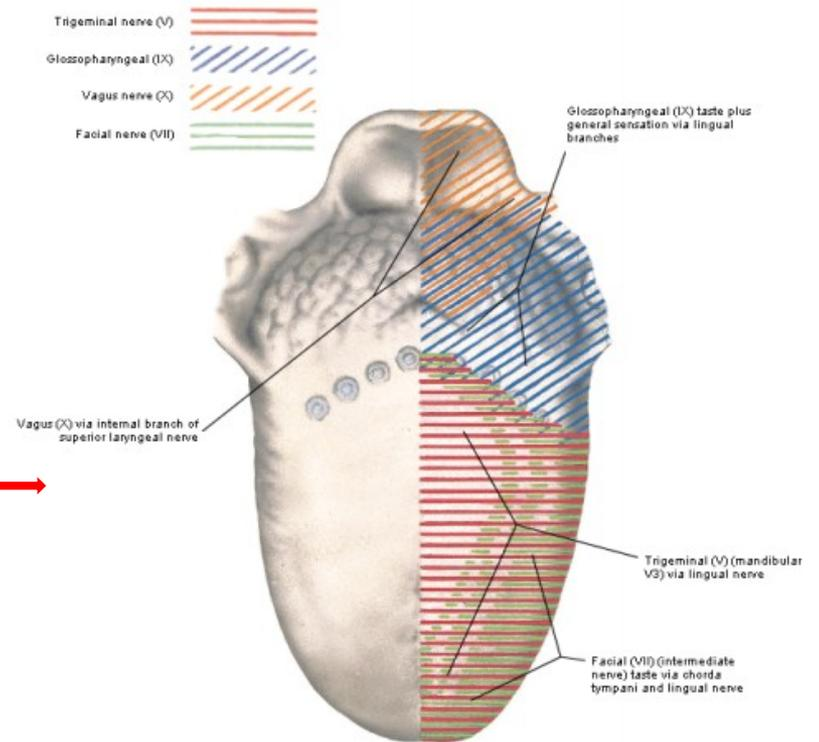

# CN V - pathways

- touch, pain and temperature
- touch (discriminative touch)
- proprioception (muscles, temporomandibular joint, teeth)

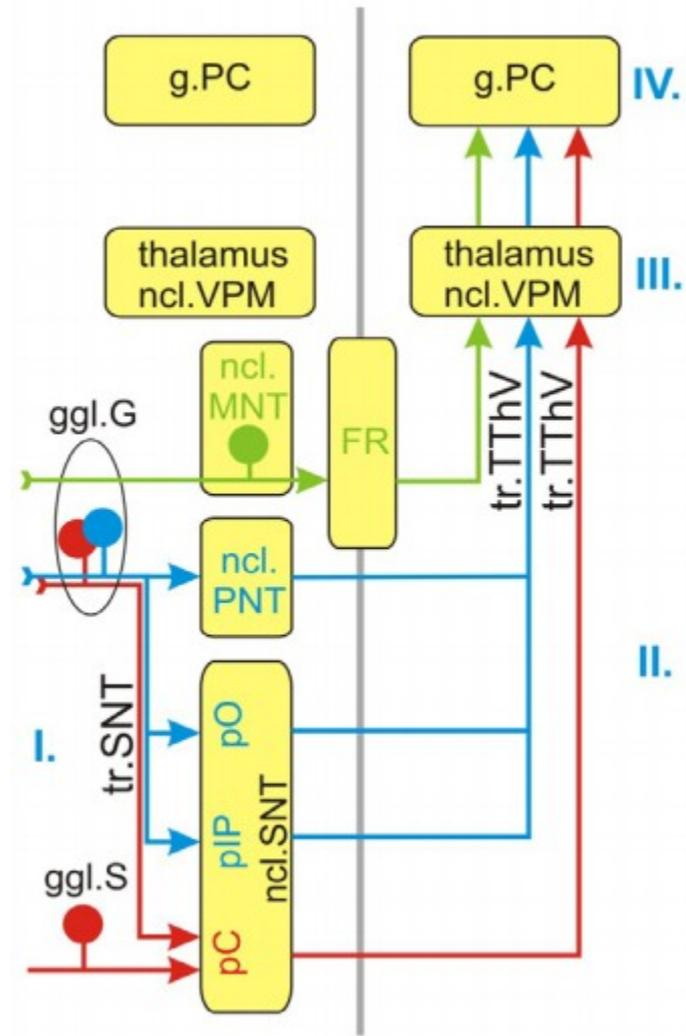

# CN V - spinal nucleus

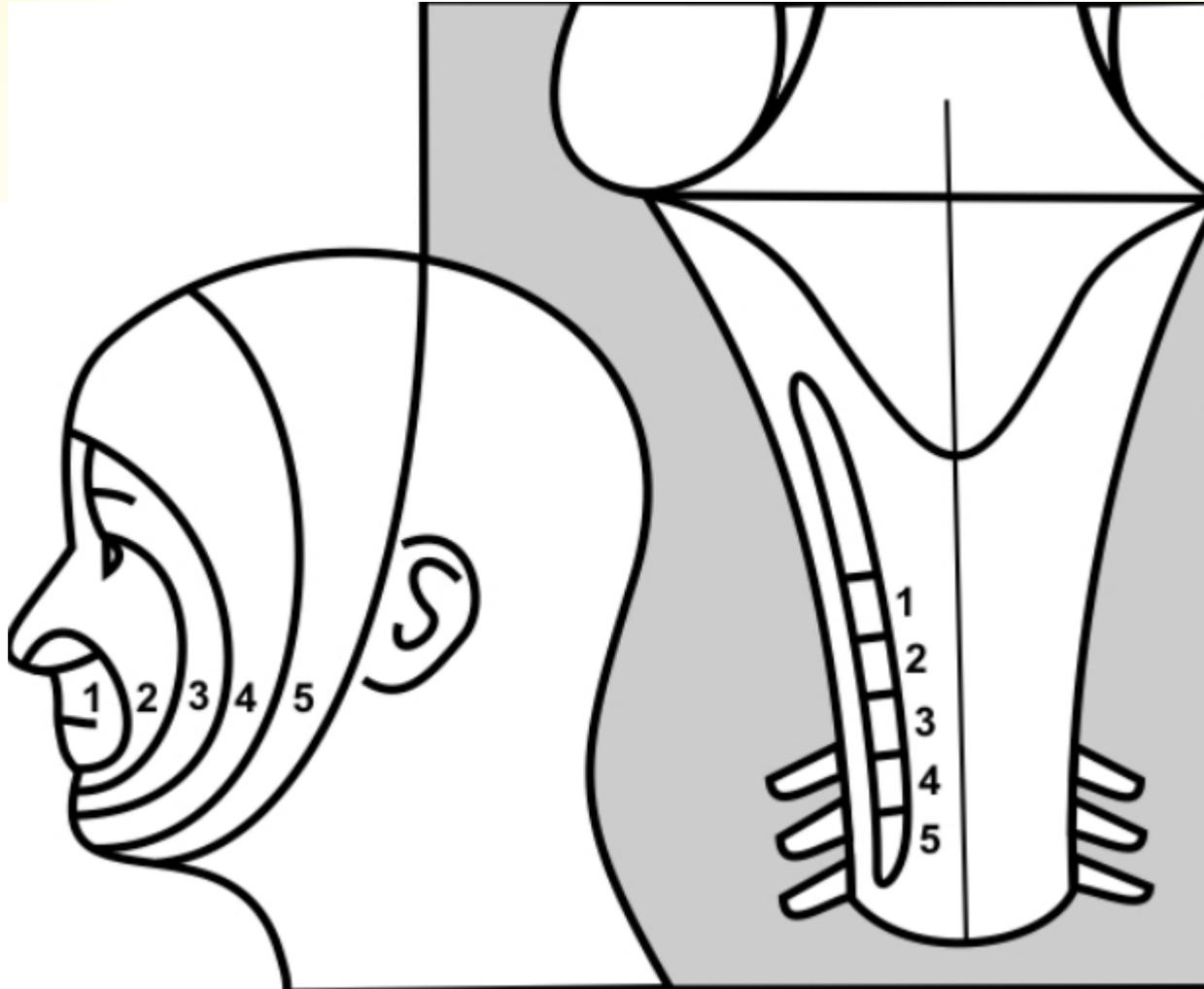

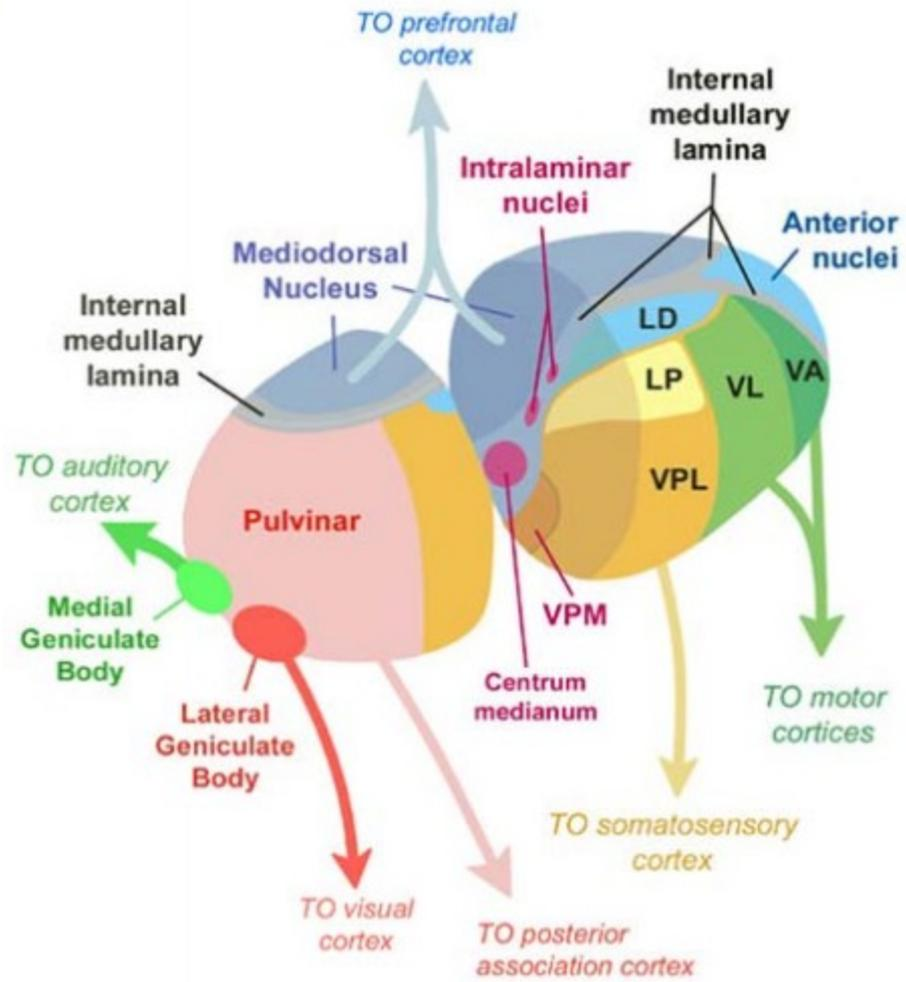

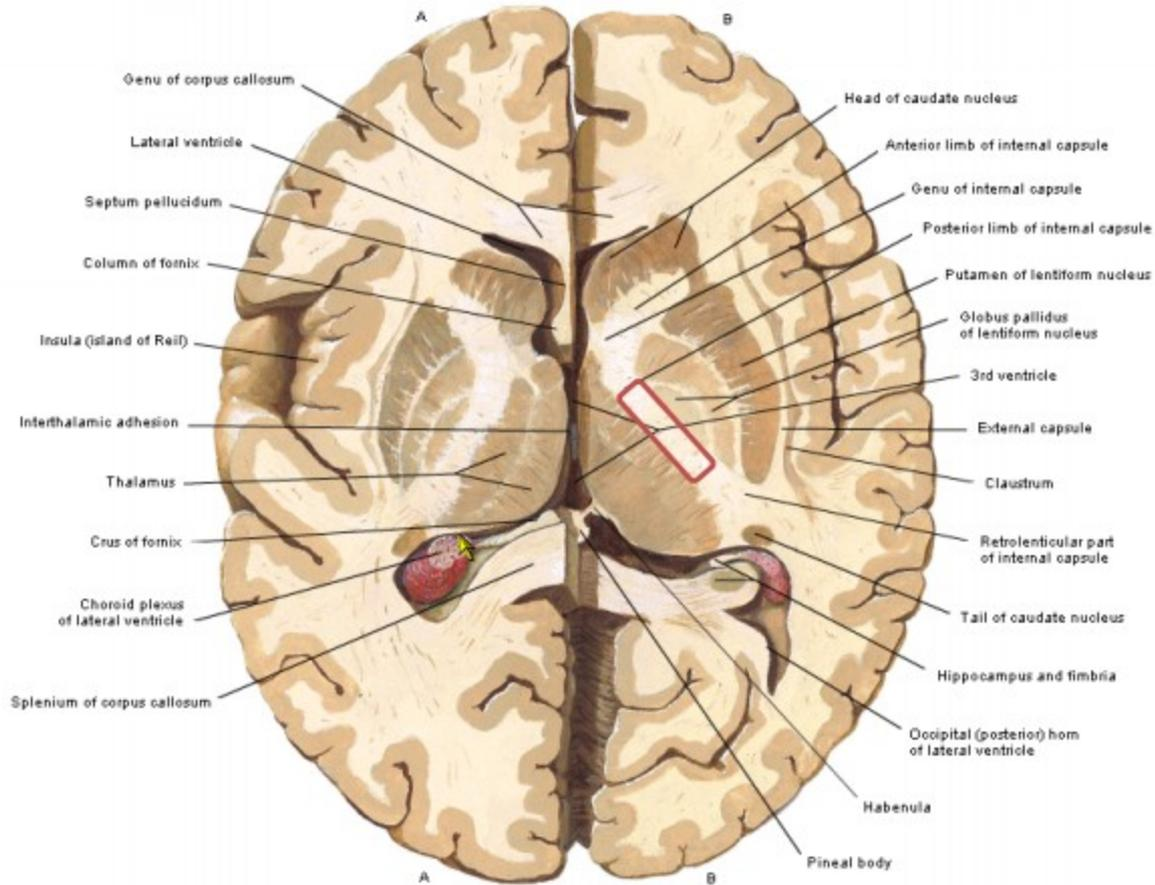

# Somatosensory cortex - a. 3,1,2

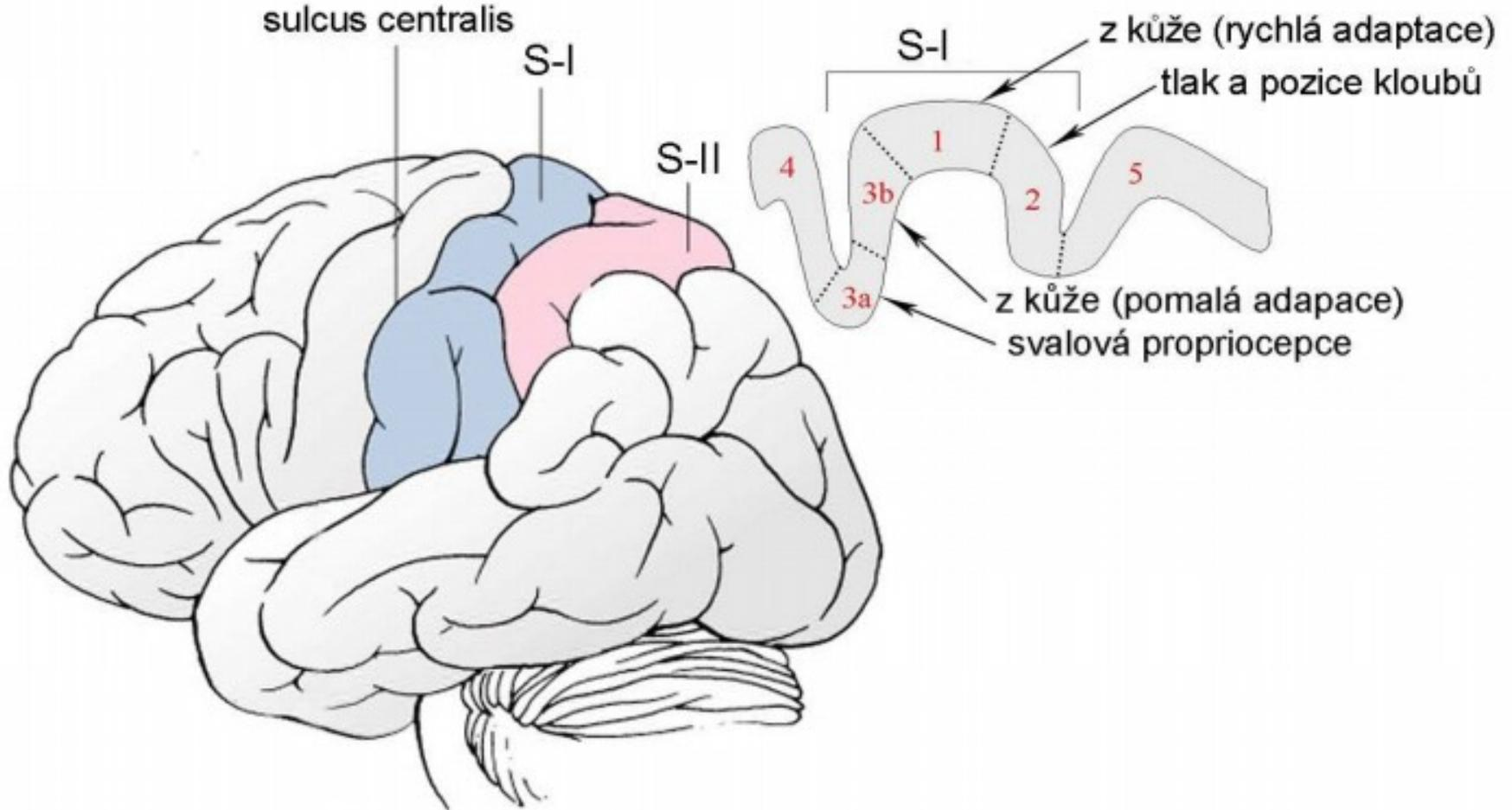

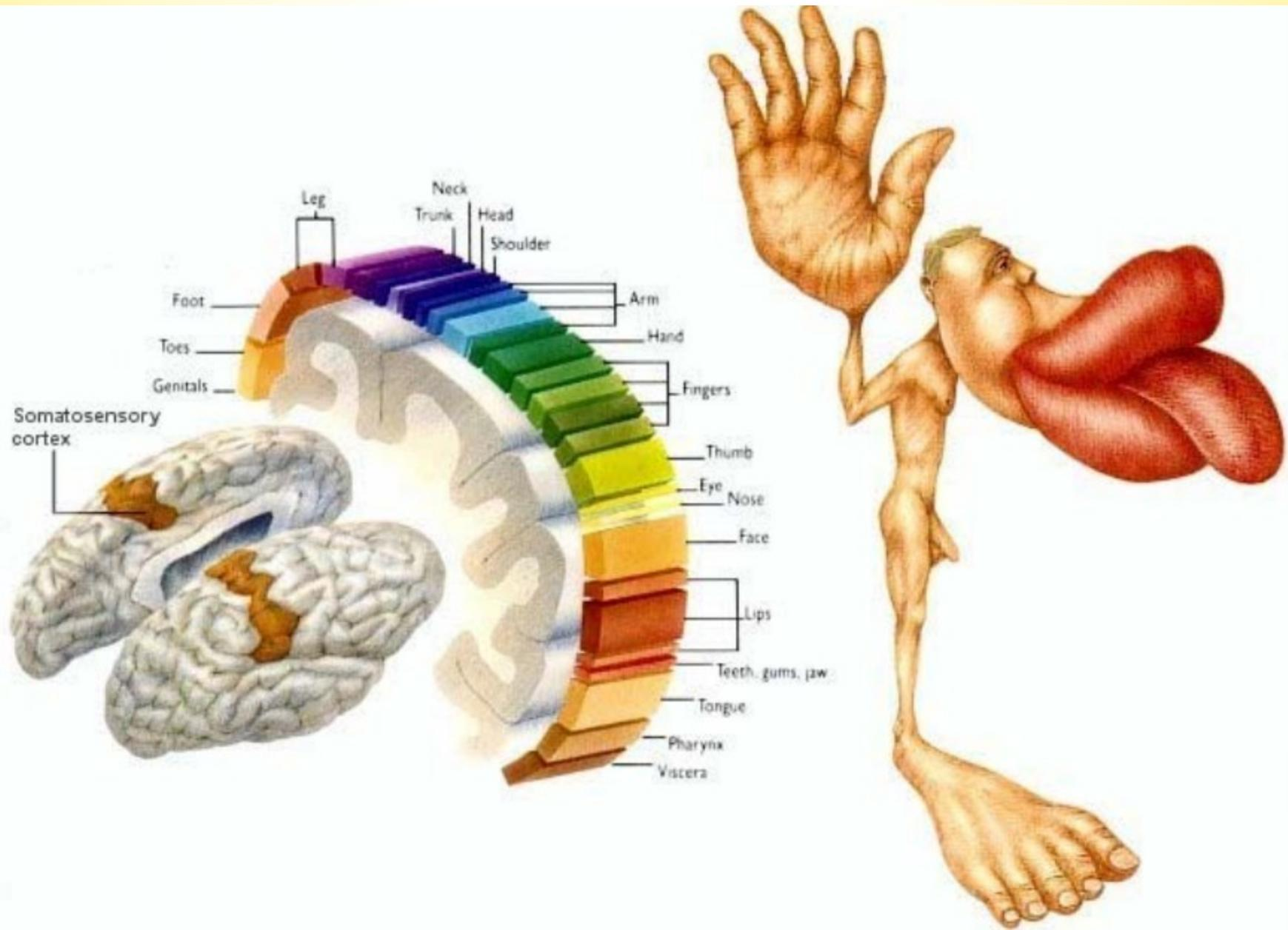

# Somatotopic organization

© 2000 UTHSCH

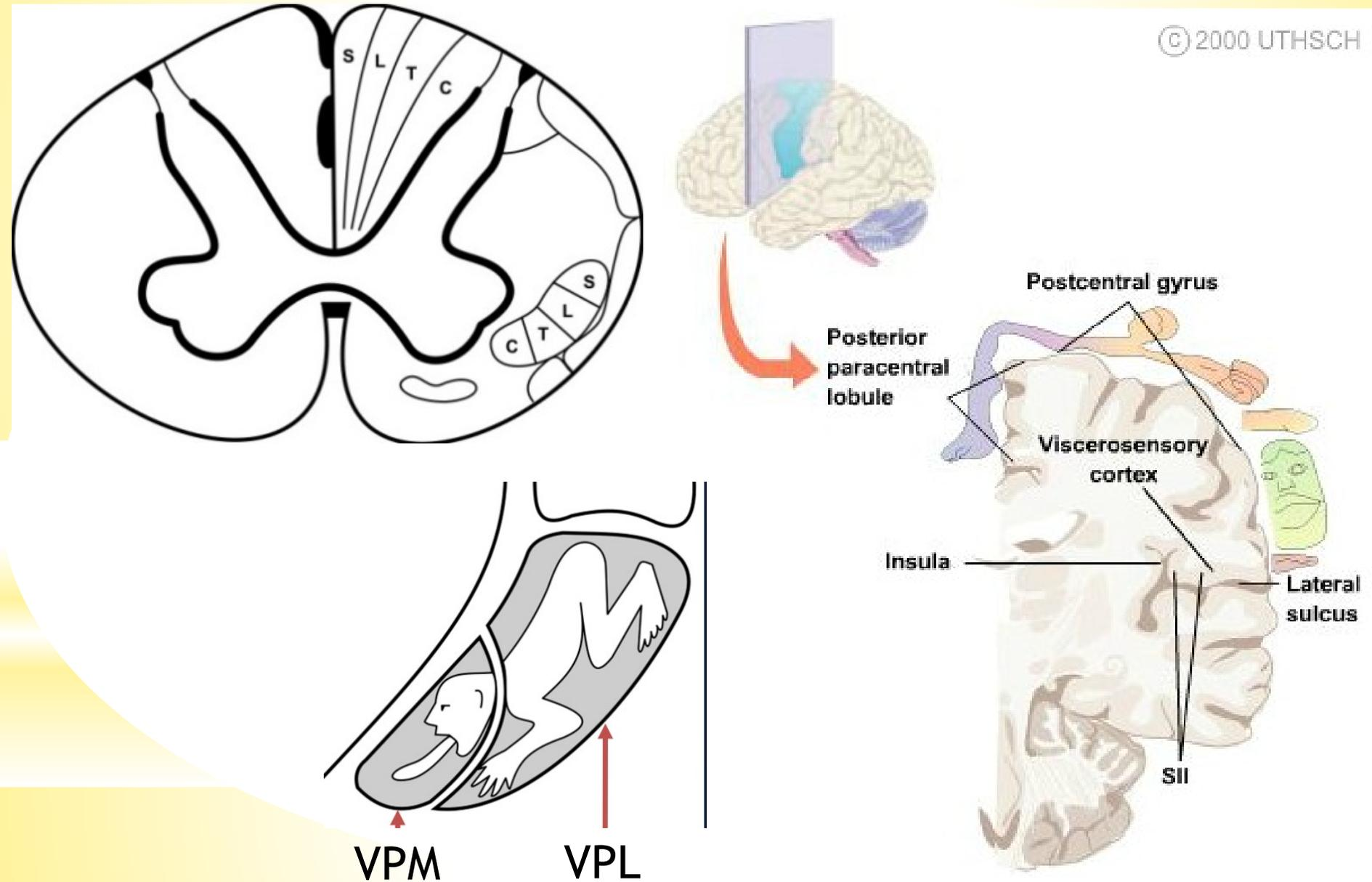

# VISCEROSENSORY PATHWAYS

- ❑ carry information from the thoracic, abdominal and pelvic cavities, and from the cardiovascular system
- ❑ utilize autonomic pathways to reach the CNS
- ❑ participate in important reflexes
- ❑ most of them end in the hypothalamus

# VS fibres in the parasympathetic nerves

- ❑ pseudounipolar neurons in the inferior ganglion of **CN IX**
  - mucosa of oropharynx → ncl. commissuralis  
(reflex contractions of pharyngeal muscles during swallowing)
  - carotid sinus (baroreceptor)
  - carotid body (chemoreceptor) → dorsal respiratory ncl.
  
- ❑ pseudounipolar neurons in the inferior ganglion of **CN X**
  - heart, respiratory organs and GIT → ncl. commissuralis
  - information about acidity of gastric juice → lateral hypothalamus (apestat)
  - aortic arch (baroreceptor)

# Solitary nucleus (ncl. of solitary tract)

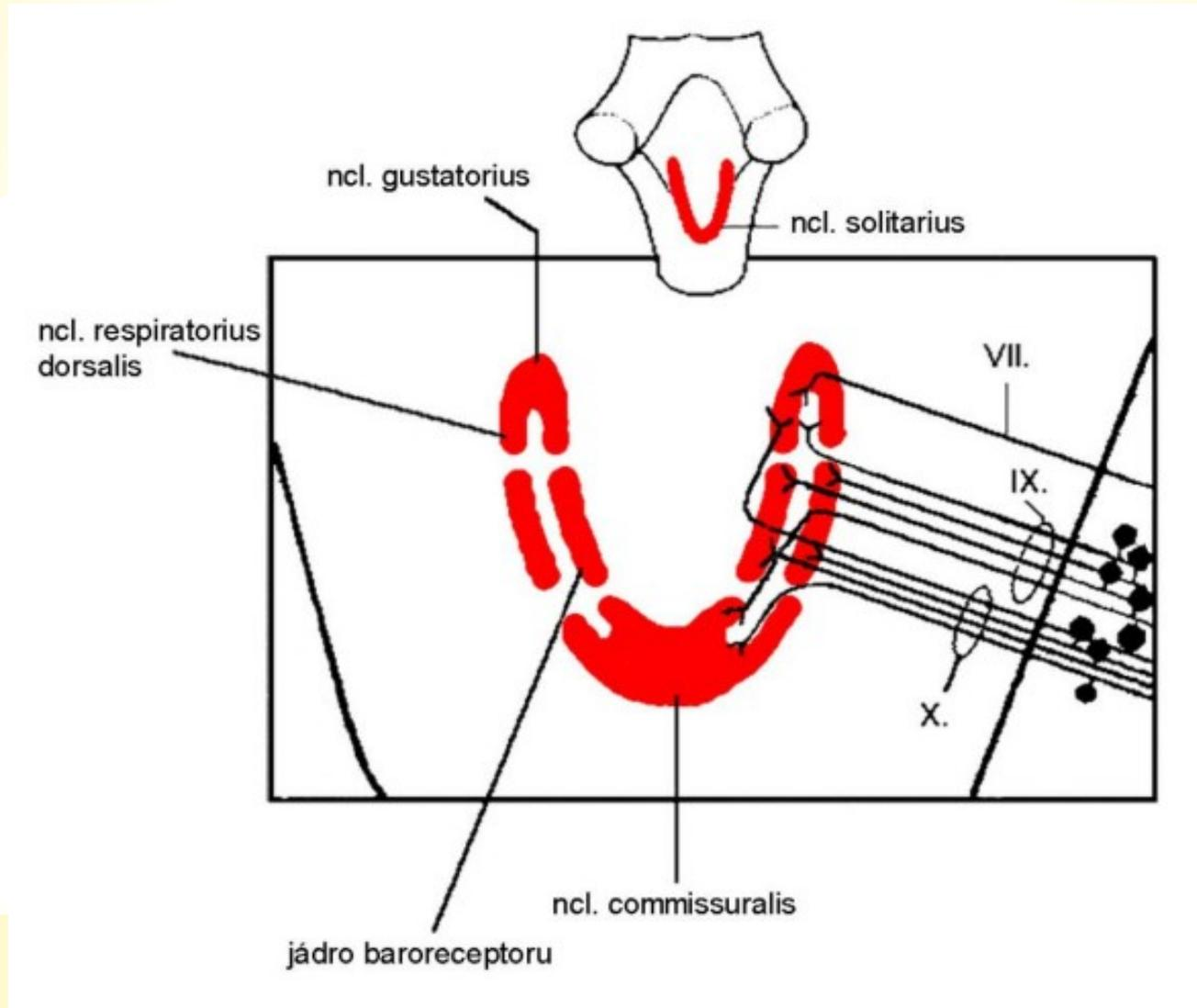

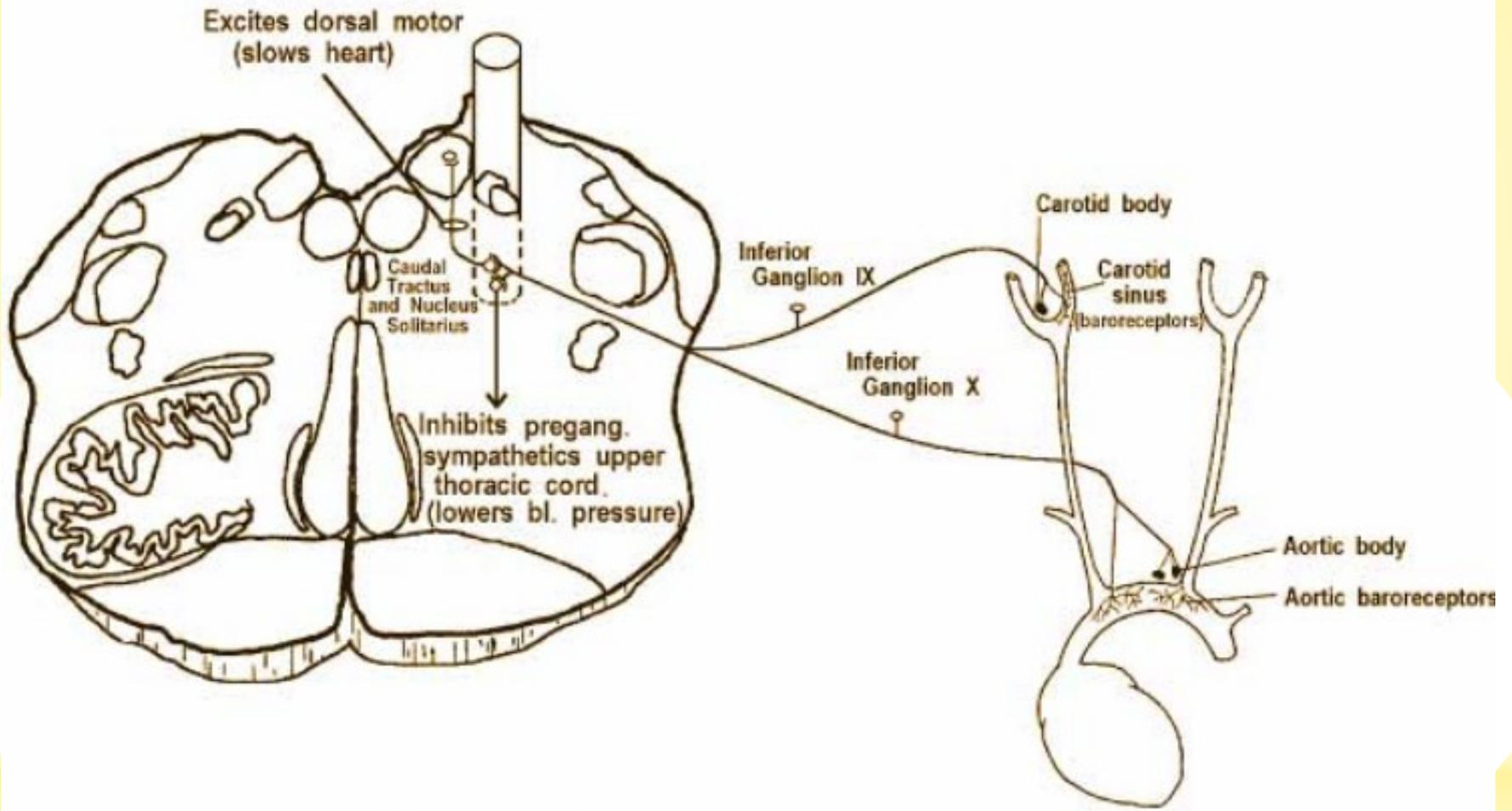

**BARORECEPTOR REFLEX**

# VS fibres in the sympathetic system

- ❑ information about pressure, vibrations, temperature and pain from visceral organs
- ❑ dorsal root ganglion
- ❑ ncl. proprius
- ❑ tr. spinothalamicus → ncl. ventralis posterolateralis thalami → somesthetic cortex
- ❑ tr. spinoreticularis

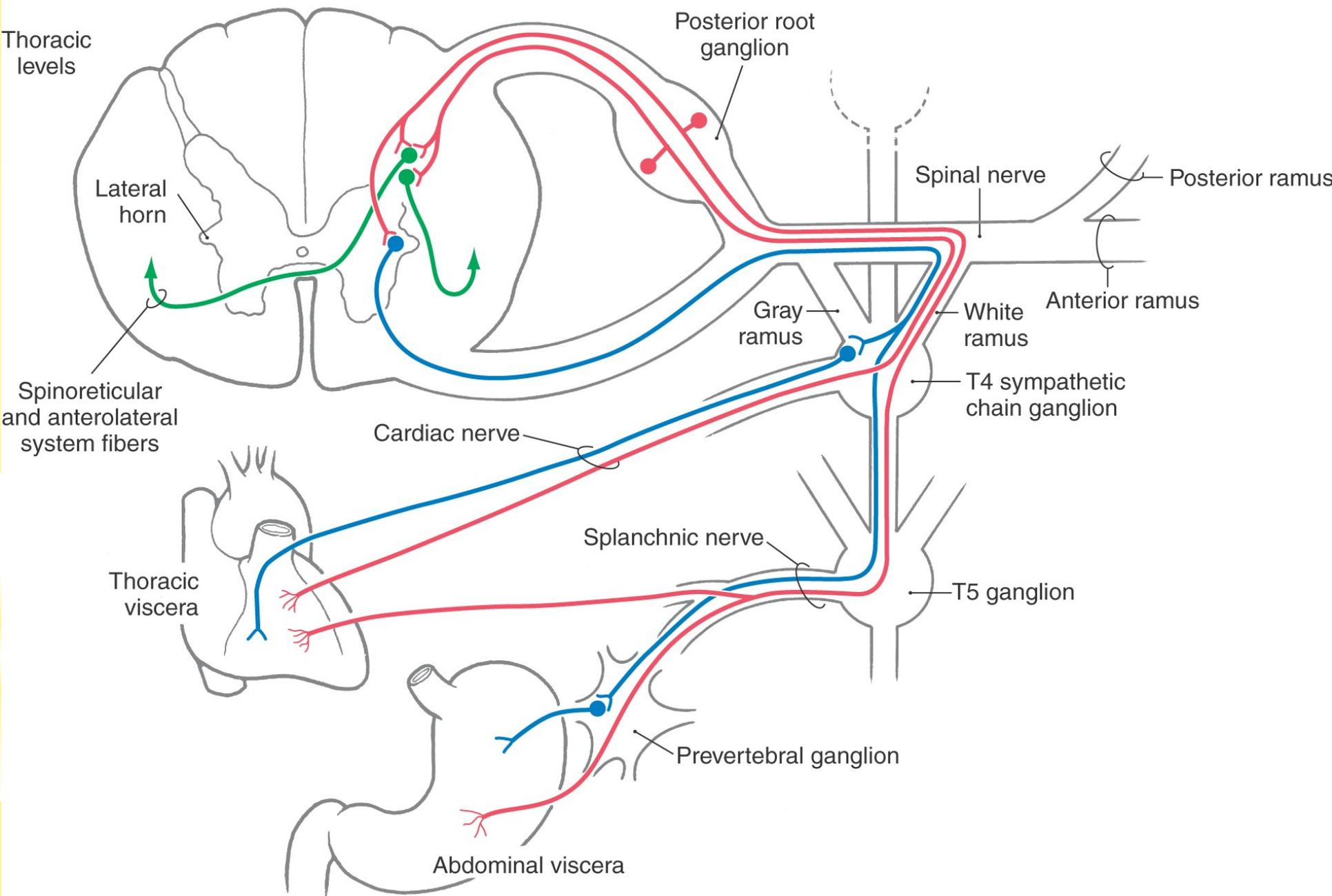

Illustrations were copied from:

**Neuroscience Online, the Open-Access Neuroscience  
Electronic Textbook**

Department of Neurobiology and Anatomy  
University of Texas Medical School at Houston