

VISUAL PATHWAYS

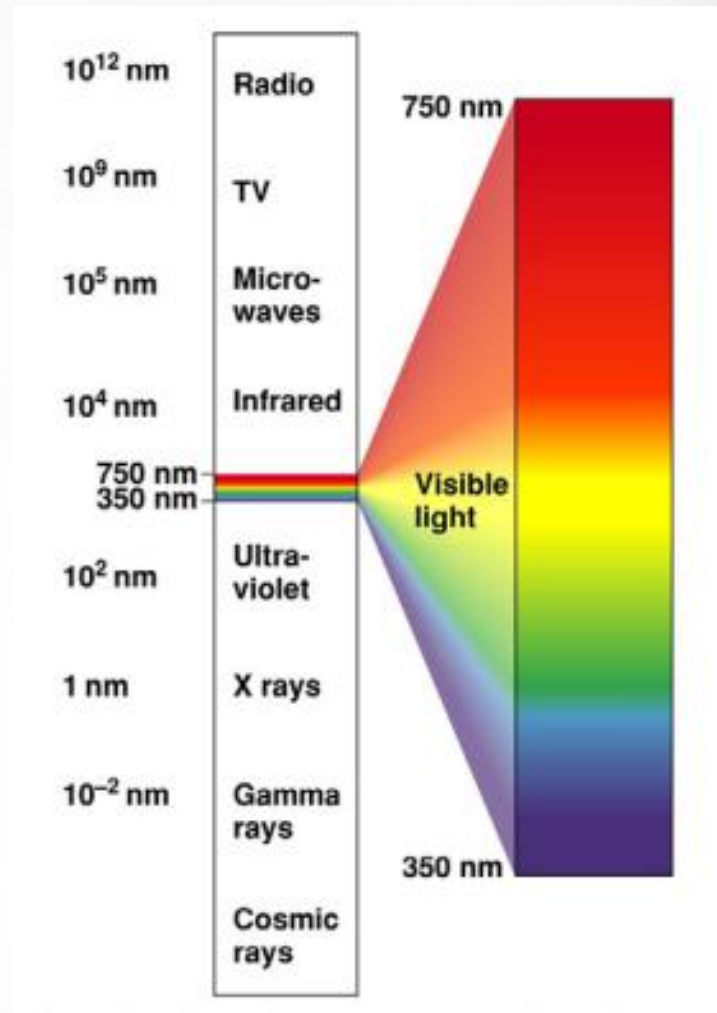

VISUAL SYSTEM

□ Perception of

- shape
- motion
- color

□ Two pathways

- retina - cortex
 - visual perception
- retina - brainstem, diencephalon
 - eye movements
 - circadian photoentrainment
 - accommodation
 - pupillary reflexes

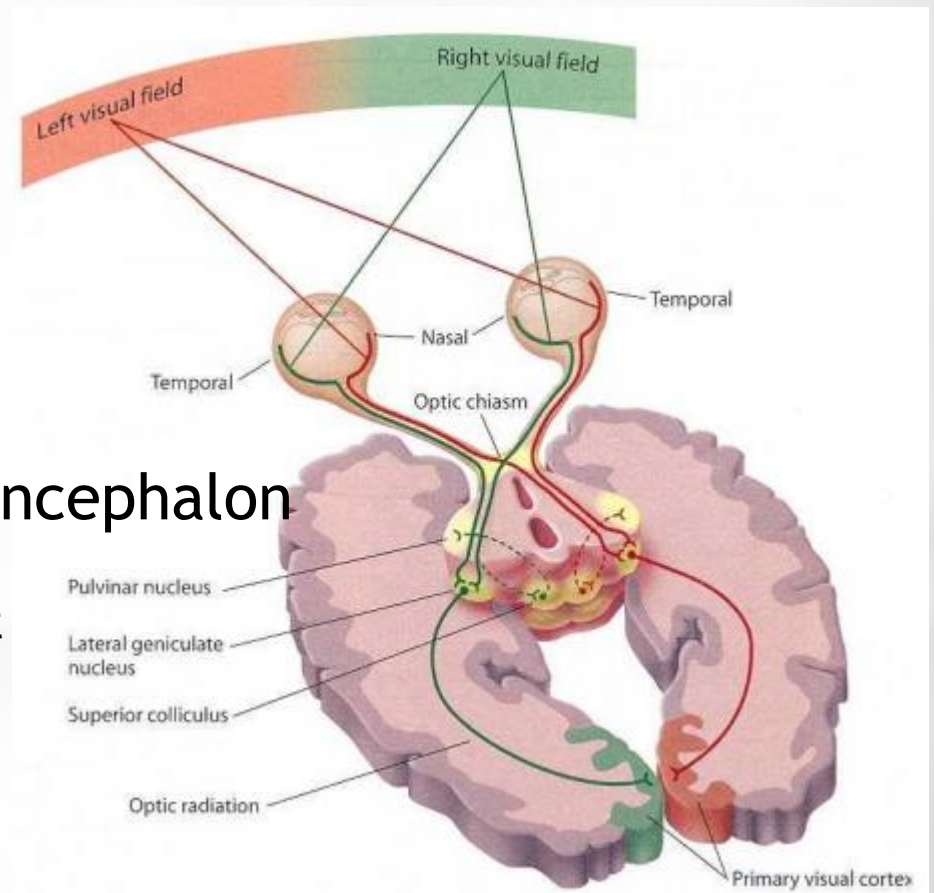

Light passes through the cornea, aqueous humor, lens, and vitreous body to form an image on the retina.

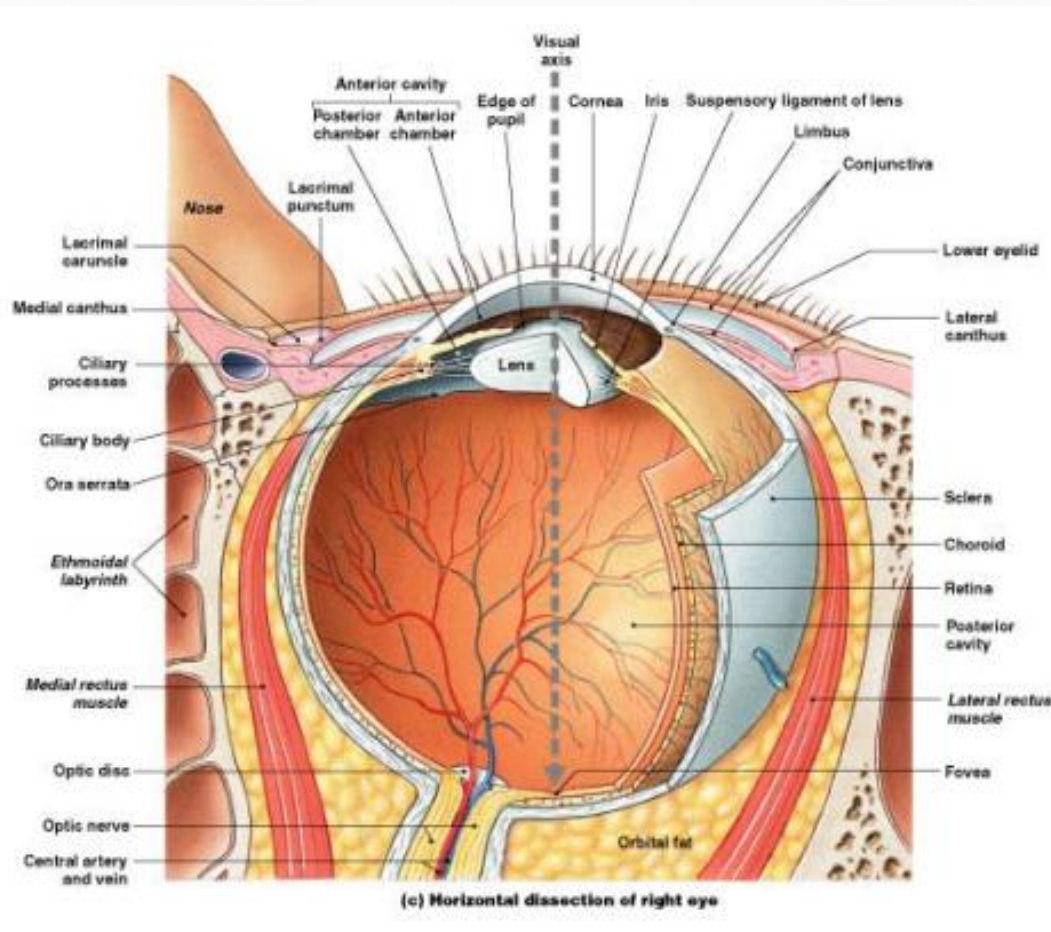

Macula lutea + fovea centralis = areas of the highest visual acuity

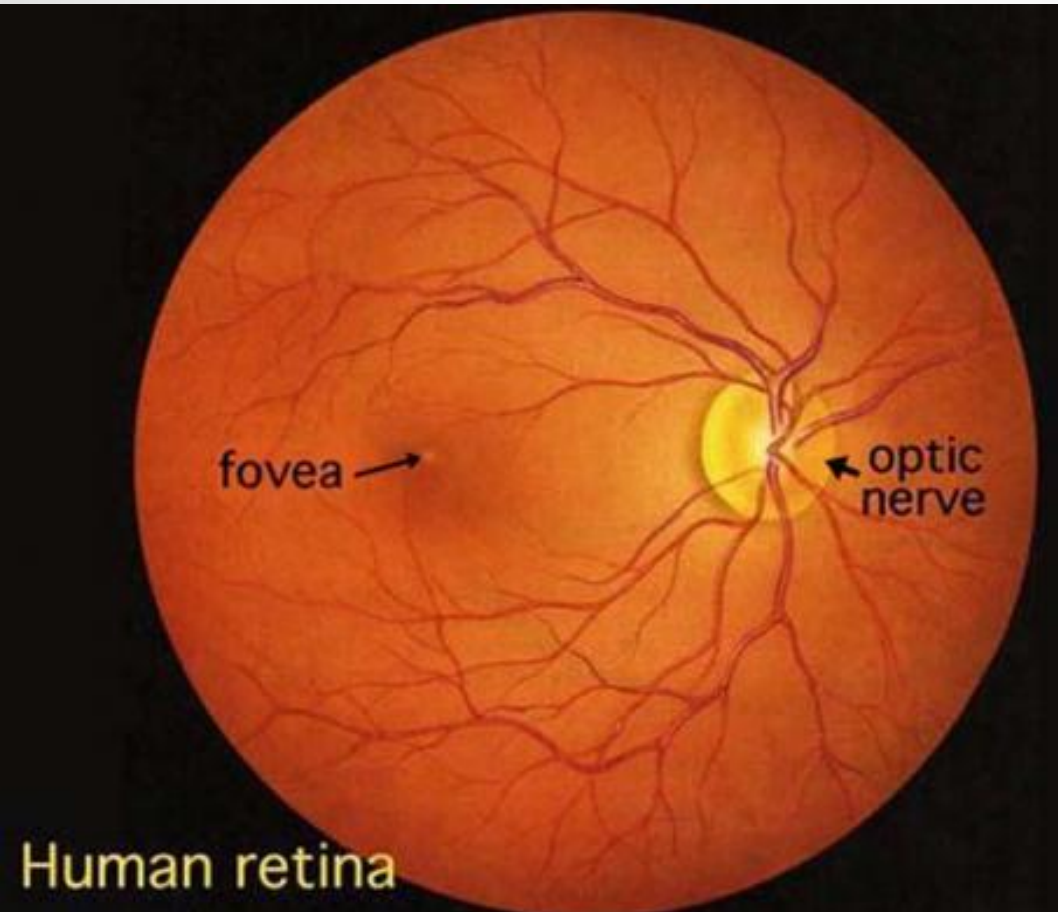

Fundus oculi

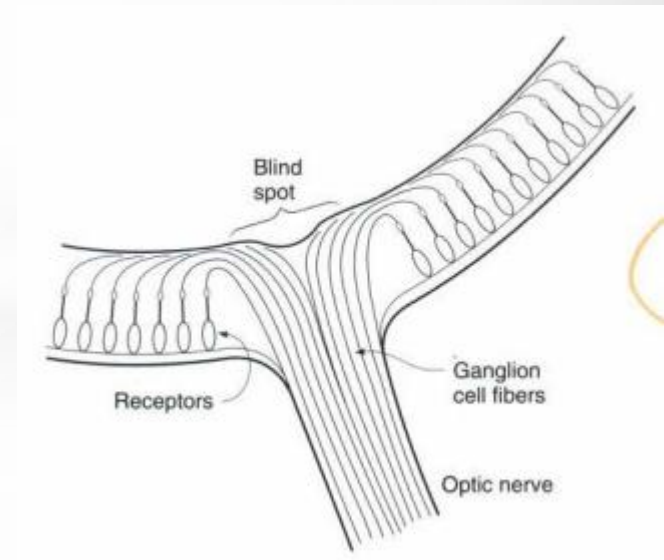
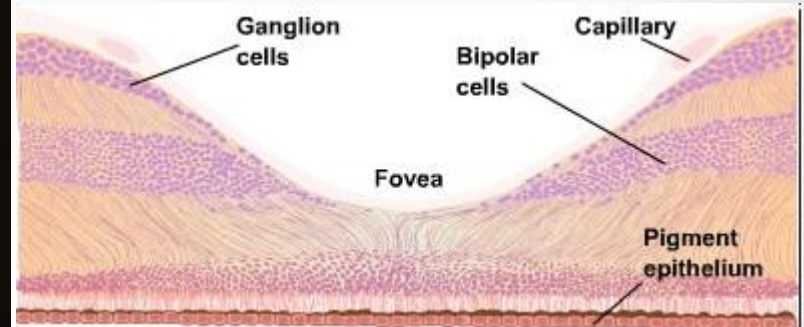

RETINA

10 layers: mainly separated by cell bodies (nuclear layers) and axons (plexiform layers)

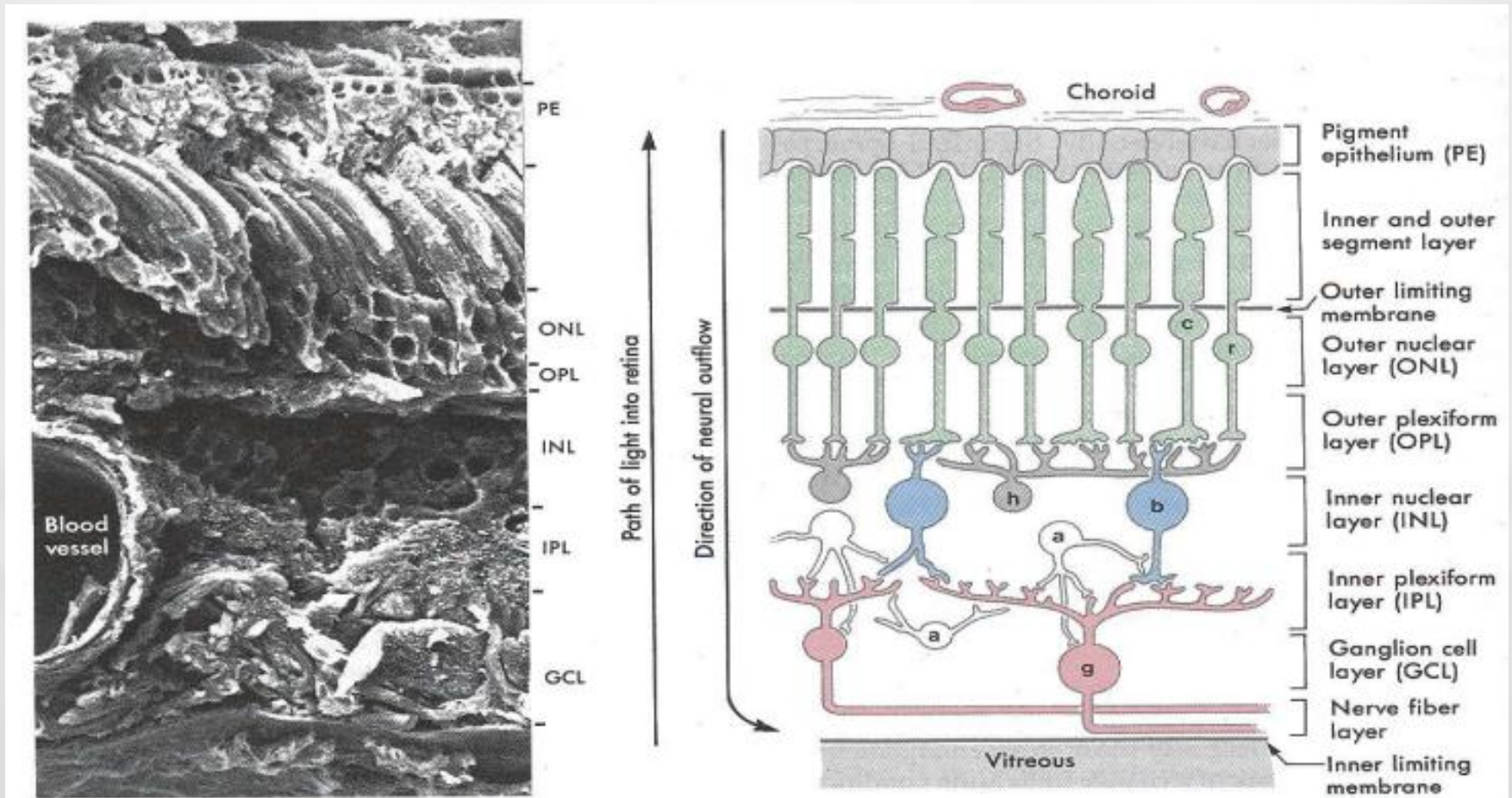

□ **5 main cell types:**

- photoreceptors
- bipolar cells
- horizontal cells
- amacrine cells
- ganglion cells

□ **Photoreceptors:**

- rods and cones
- involved in transduction converting the light signal into a nerve impulse

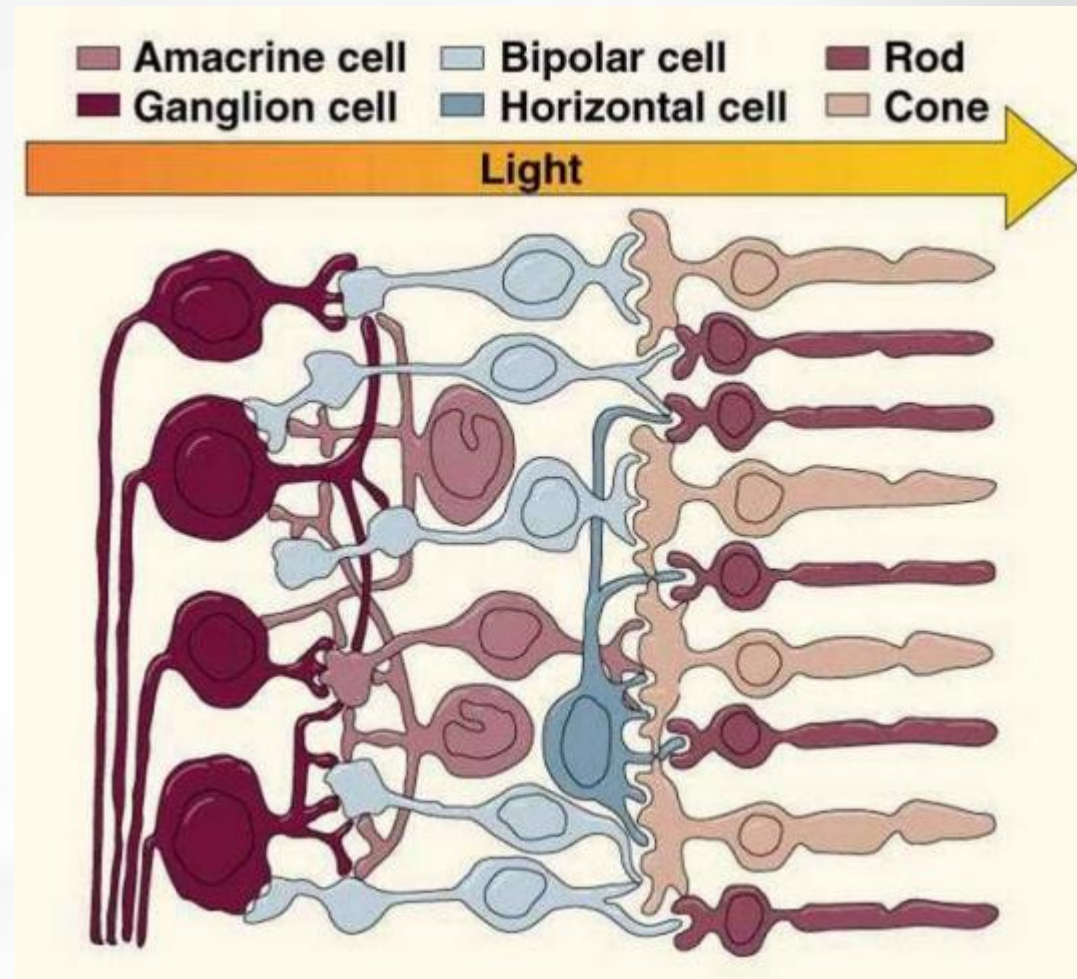

□ neurons with serial (vertical) connection

- the main visual pathway
- photoreceptors → bipolar cells → ganglion cells

□ neurons with parallel (horizontal) connection

- modulation of the visual information by retina
- horizontal cells
- amacrine cells

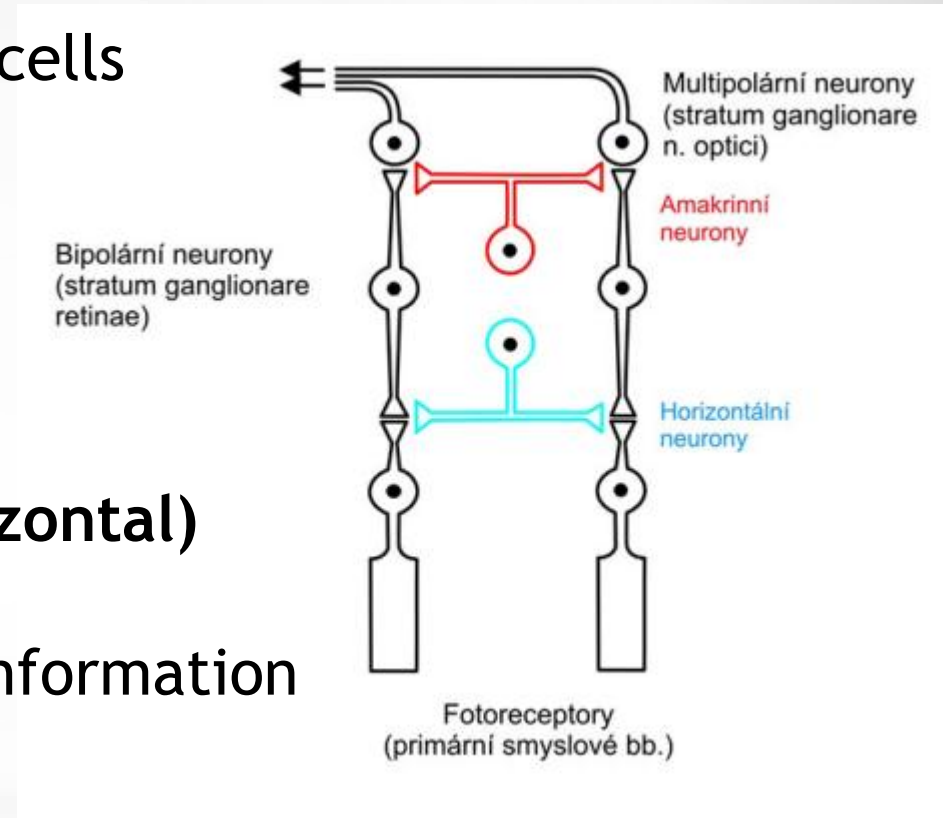

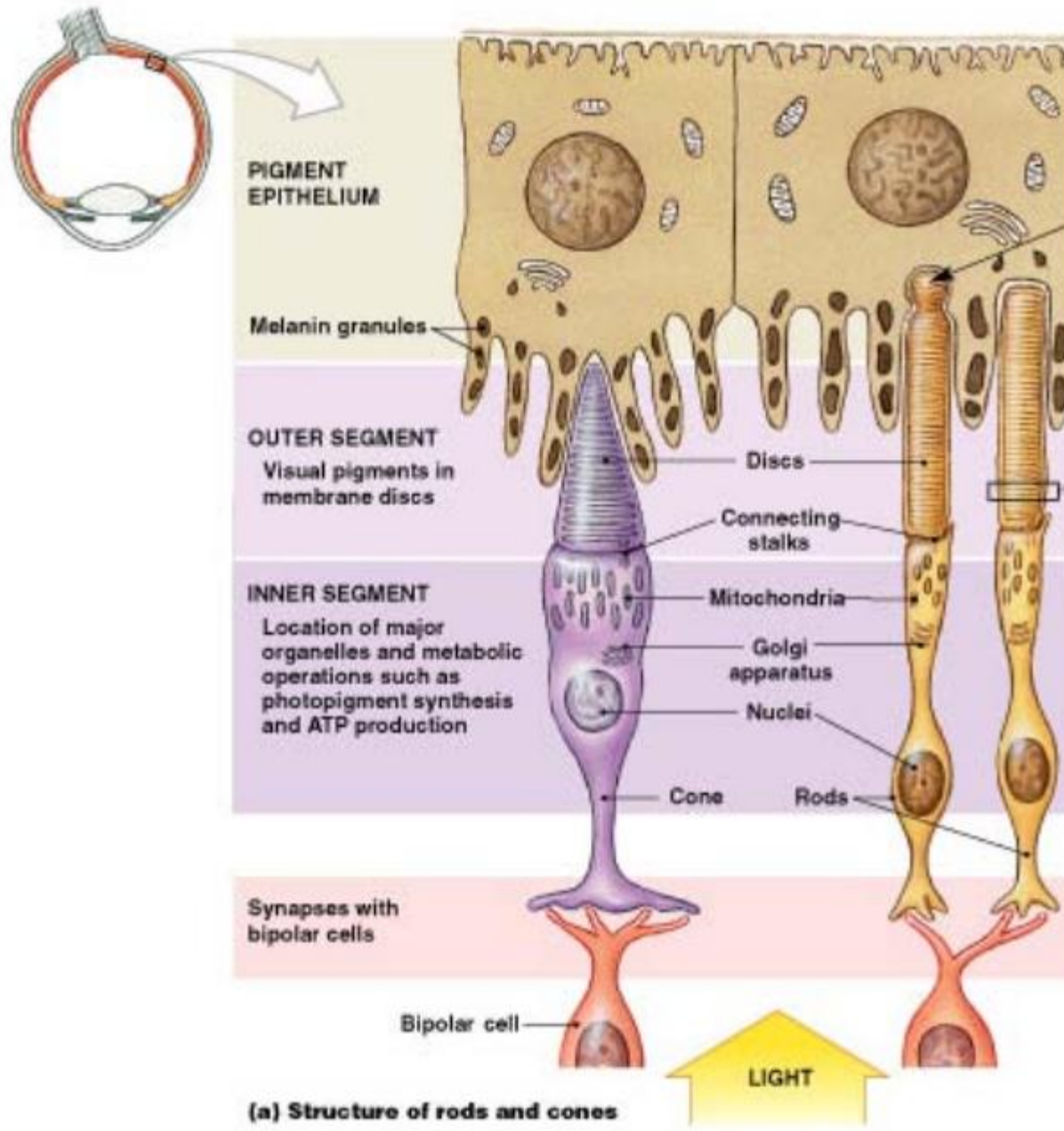

□ Cones (7 million)

- cluster at fovea (macula lutea)
- detect color in bright light = photopic vision

□ Rods (100 million)

- outside the fovea
- sensitive to shape and movement = scotopic vision

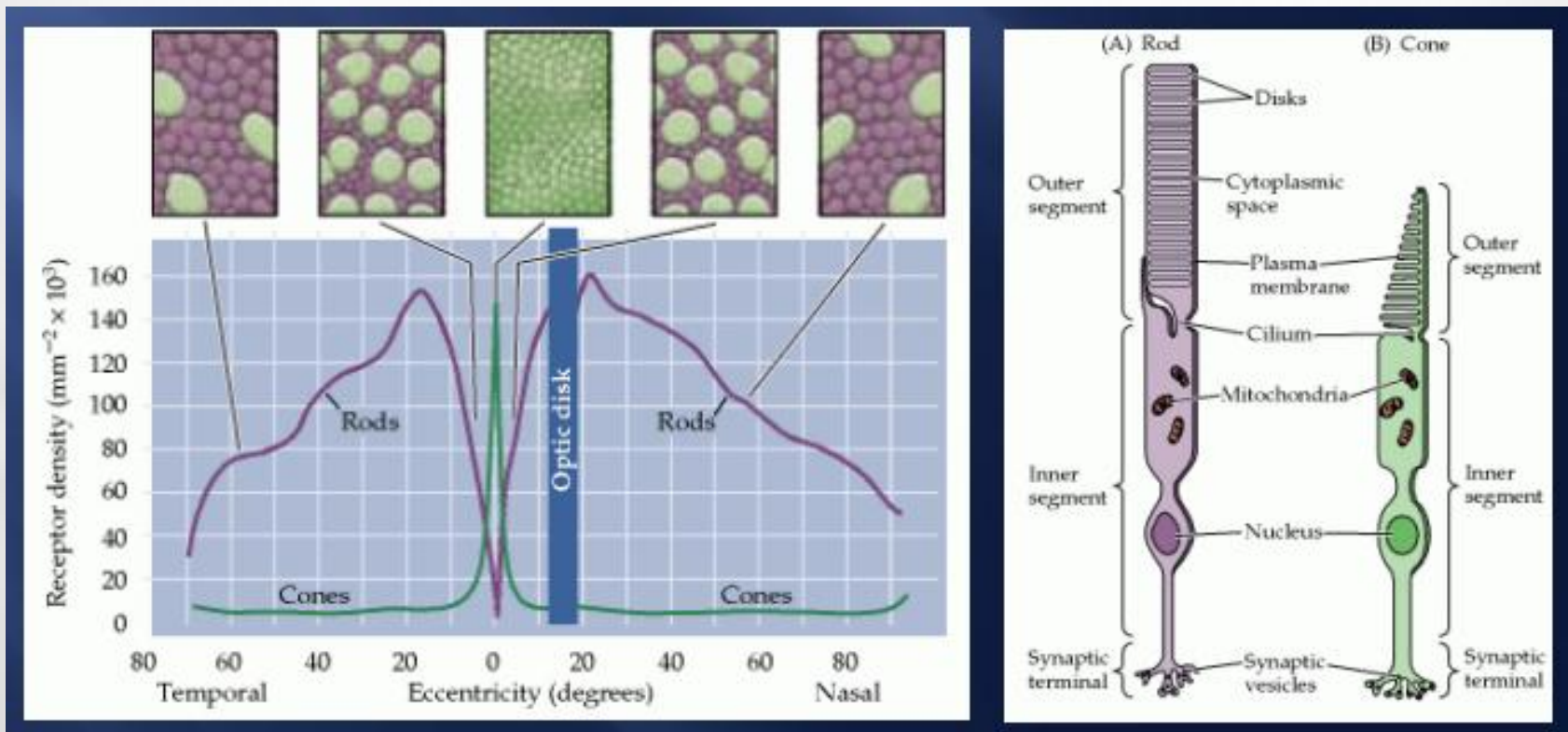

CONES

- ❑ 3 different types with three different photopigments: blue, green and red
- ❑ Each type is maximally sensitive to the wavelength that corresponds to the specific color range (spectral sensitivity)

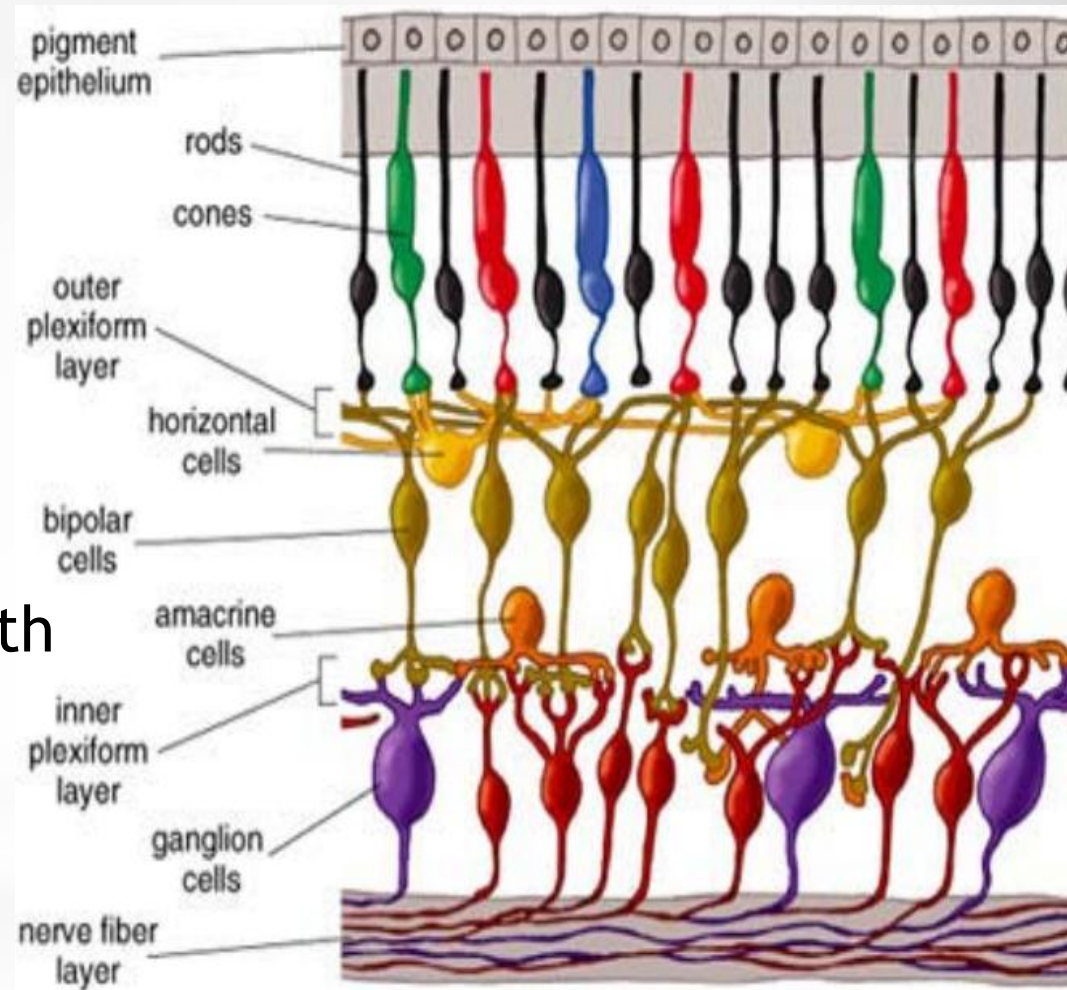

GANGLION CELLS

□ P cells (80%)

- ganglion cells that monitor cones
- smaller, more numerous
- axons end on parvocellular laminae of LGN
- provide information about fine detail and color

□ M cells (10%)

- ganglion cells that monitor rods
- relatively large
- axons end on magnocellular laminae of LGN
- provide information about a general form of an object, motion, and shadows in dim light

□ non-P non-M cells (10%)

- projection to subcortical nuclei, koniocellular cells of LGN

PRIMARY VISUAL PATHWAY

- ❑ The primary visual pathway connects the retina with lateral geniculate nucleus and primary visual cortex (retinogeniculostriate pathway)
- ❑ It is responsible for detection of shape, movement and color

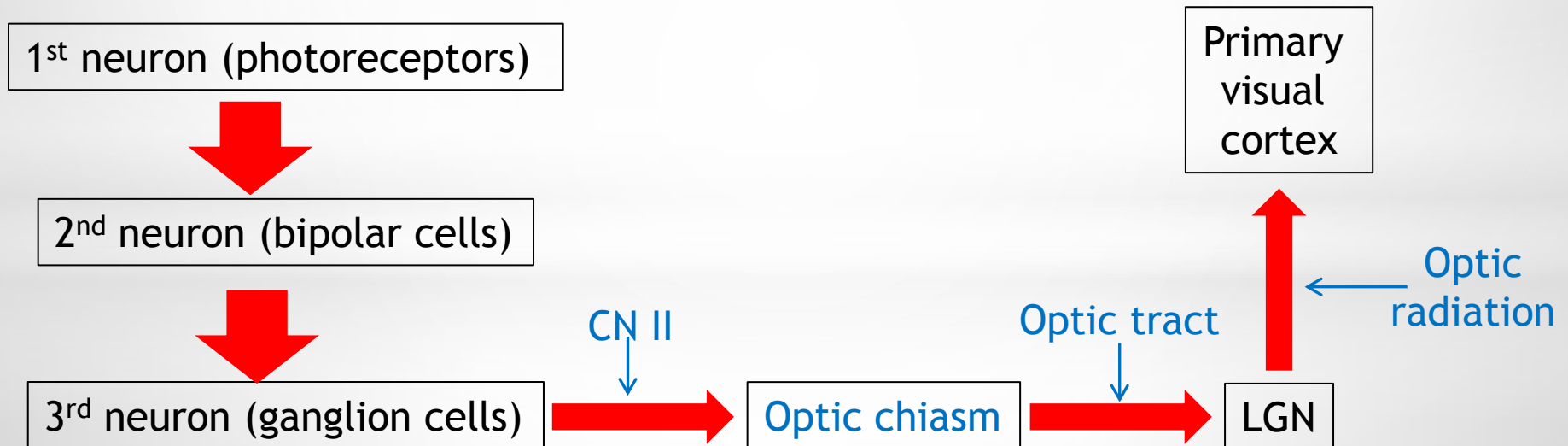

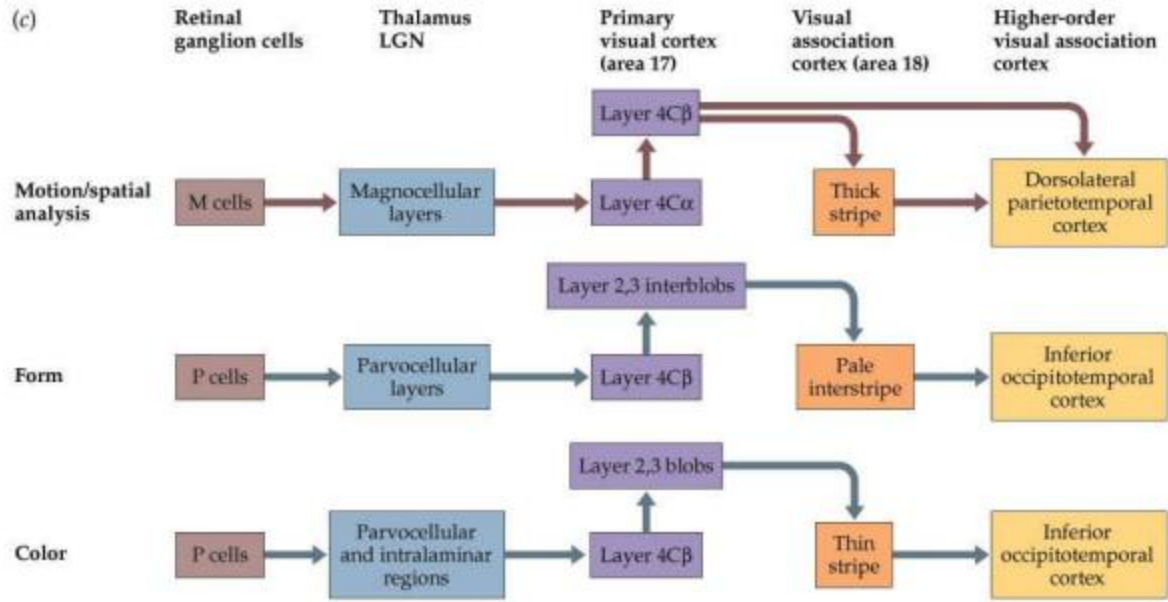
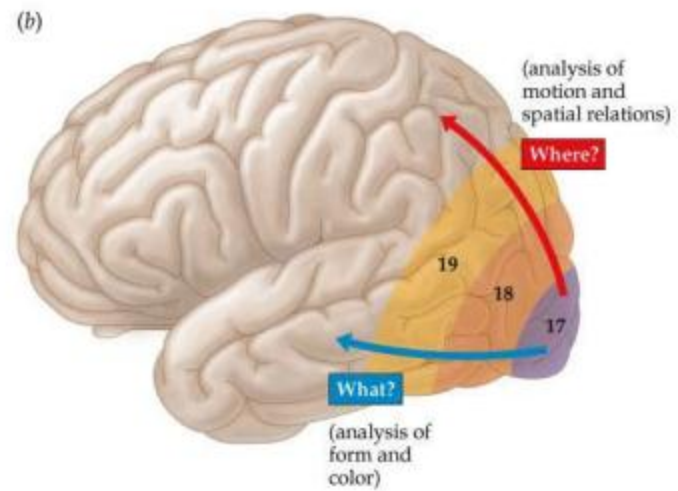
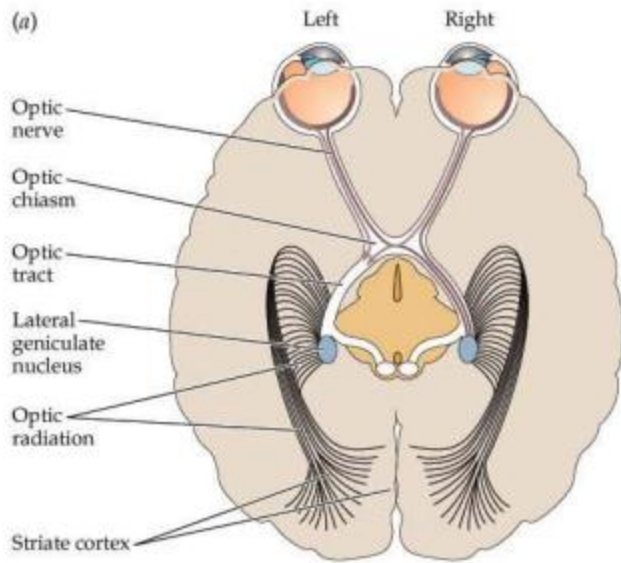

LATERAL GENICULATE NUCLEUS (LGN)

- ❑ LGN is composed of 6 layers
- ❑ Layers 1 and 2 contain larger neurons
- ❑ Layers 3 - 6 contain smaller neurons

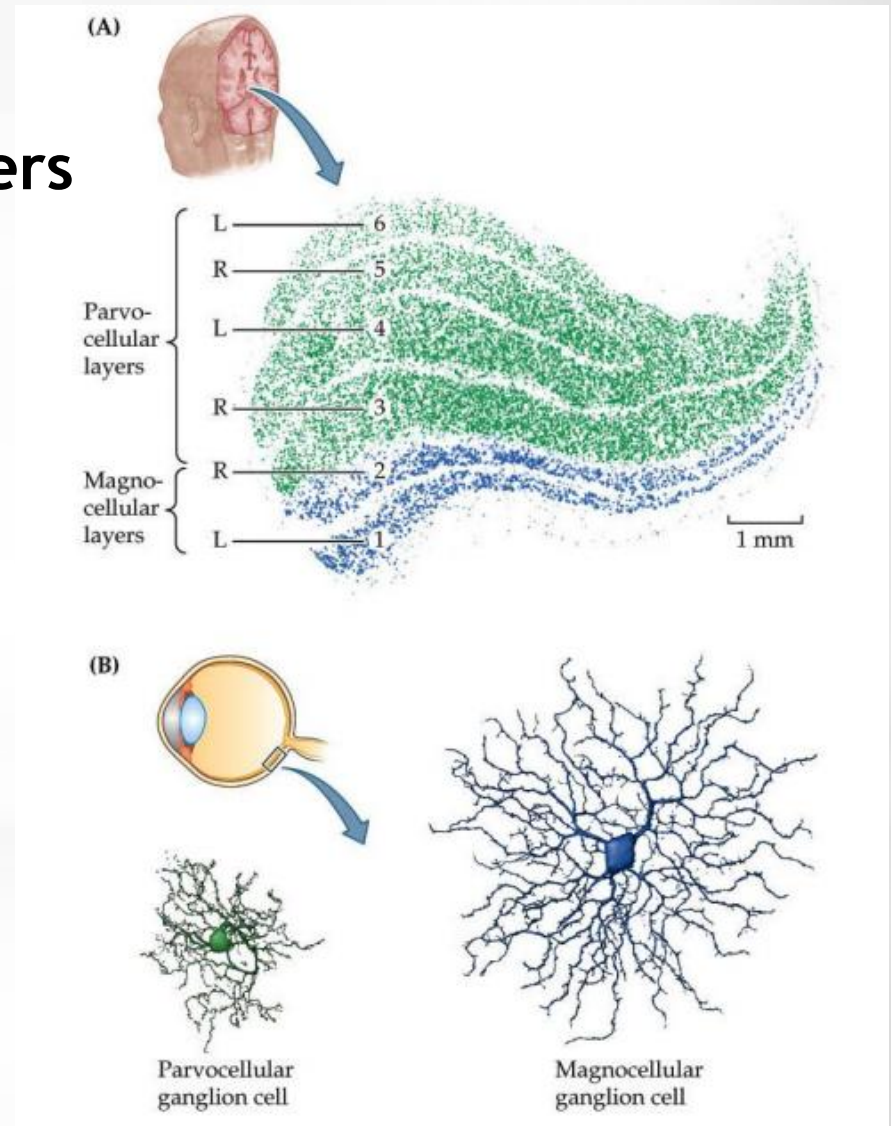

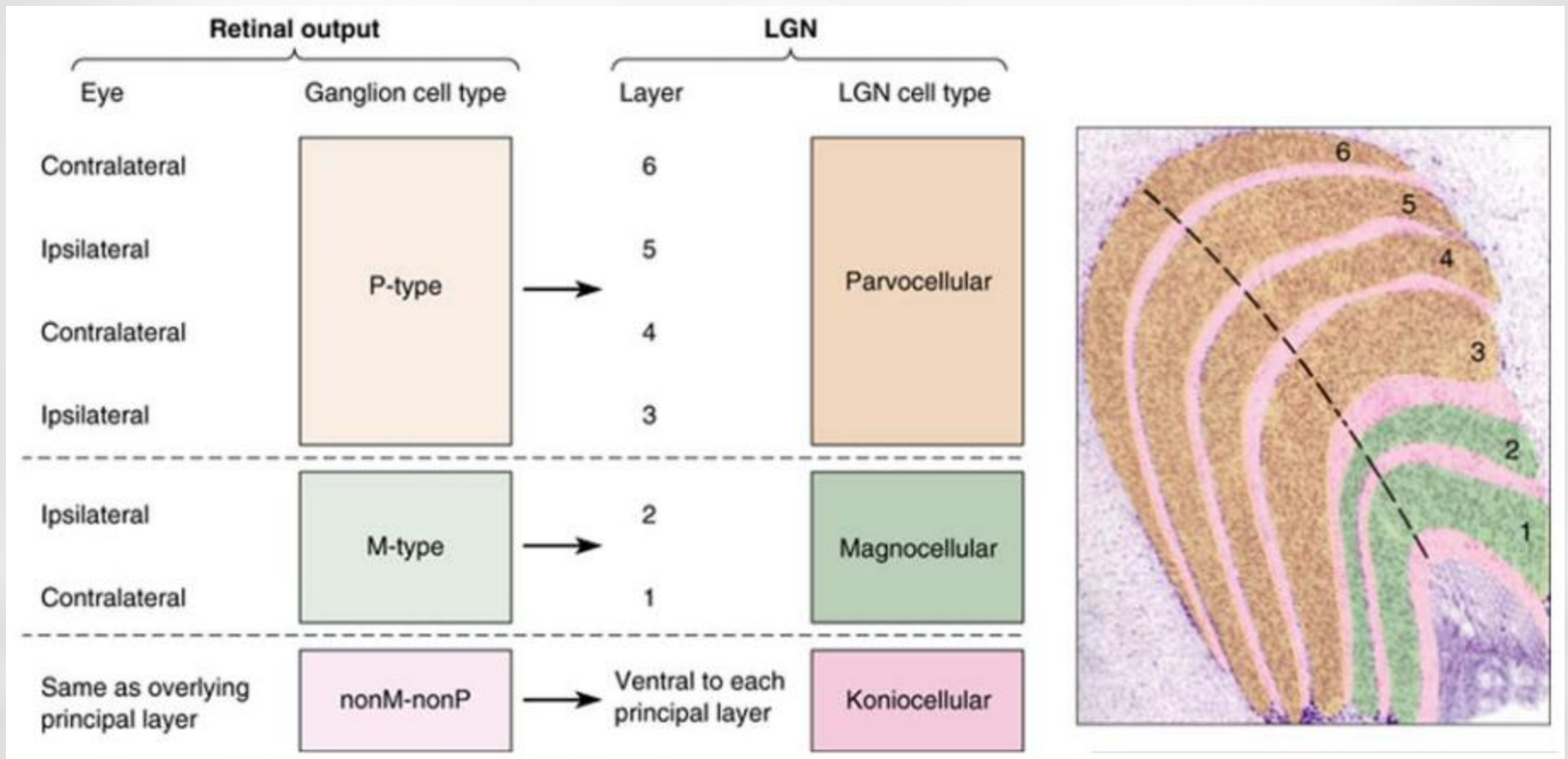

- ❑ LGN contains the topographic representation of what the retina “sees”. This **retinotopic** map is sent to the cortex.
- ❑ LGN modulates and regulates the flow of visual information to the primary visual cortex
- ❑ cortex can control efficiency of thalamic input

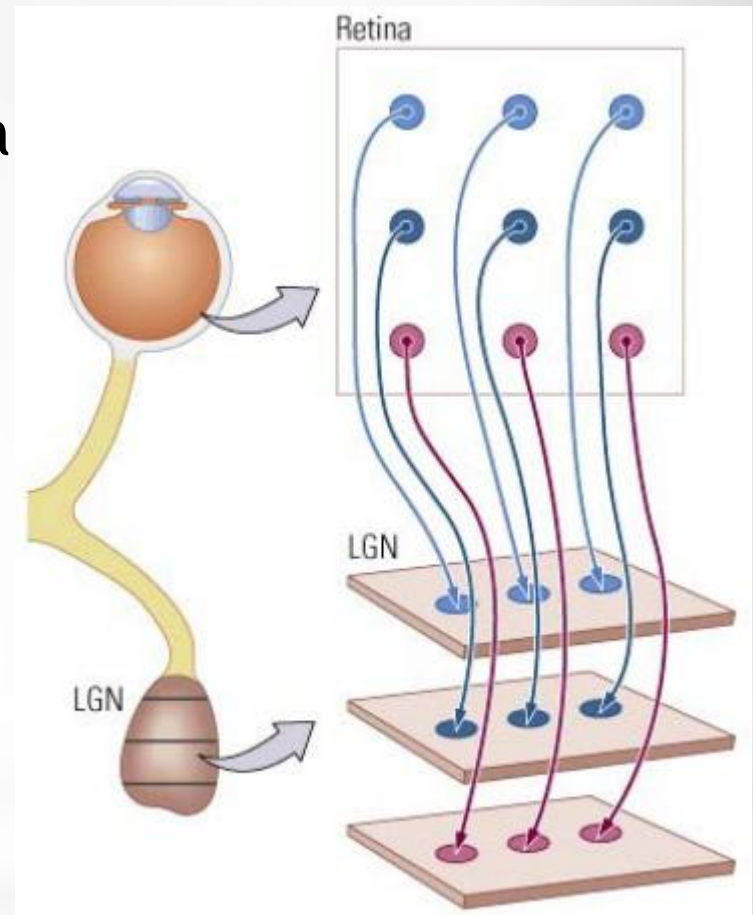

GENICULOSTRIATE PATHWAY

optic radiation (geniculocalcarine fibres) runs under the temporal lobe to the occipital lobe

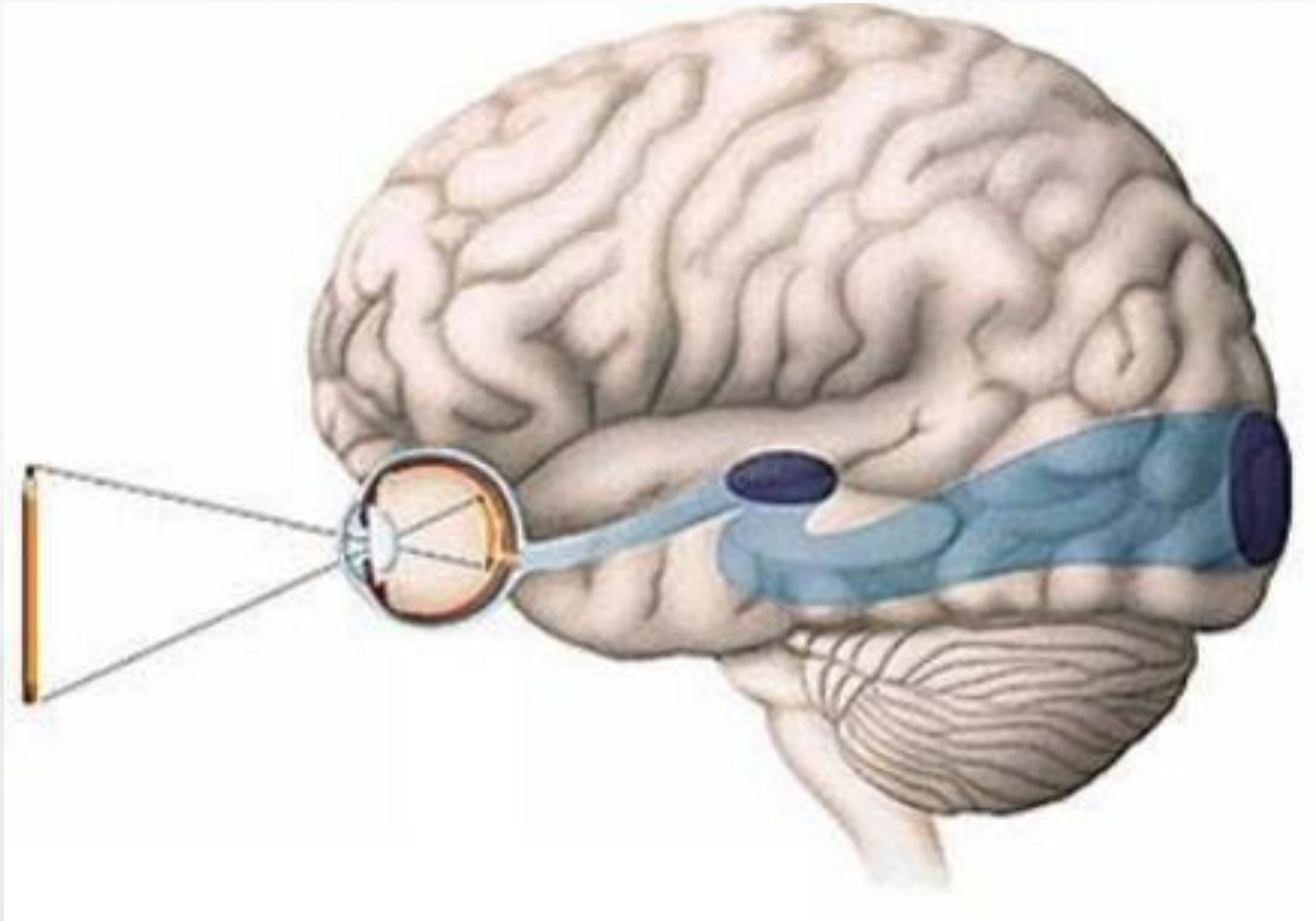

RETINOTOPIC REPRESENTATION

- ❑ Nasal and temporal visual fields
- ❑ Reversed to opposite halves of retinal representative fields (hemiretinas)
- ❑ Inverted and reversed
- ❑ Nasal visual fields project to temporal hemiretinas and their axons do not cross at the optic chiasm
- ❑ Temporal visual fields project to nasal hemiretinas and their axons cross at the optic chiasm

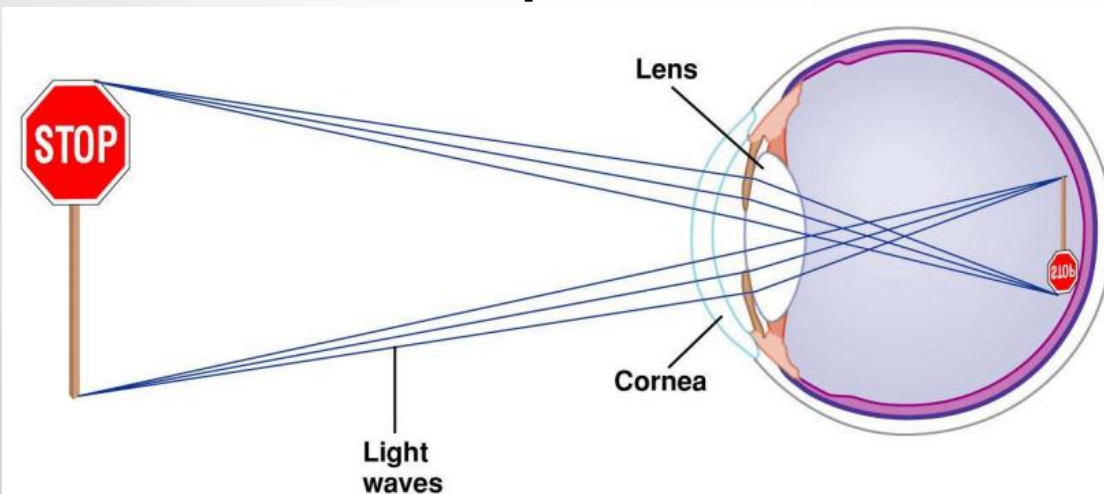
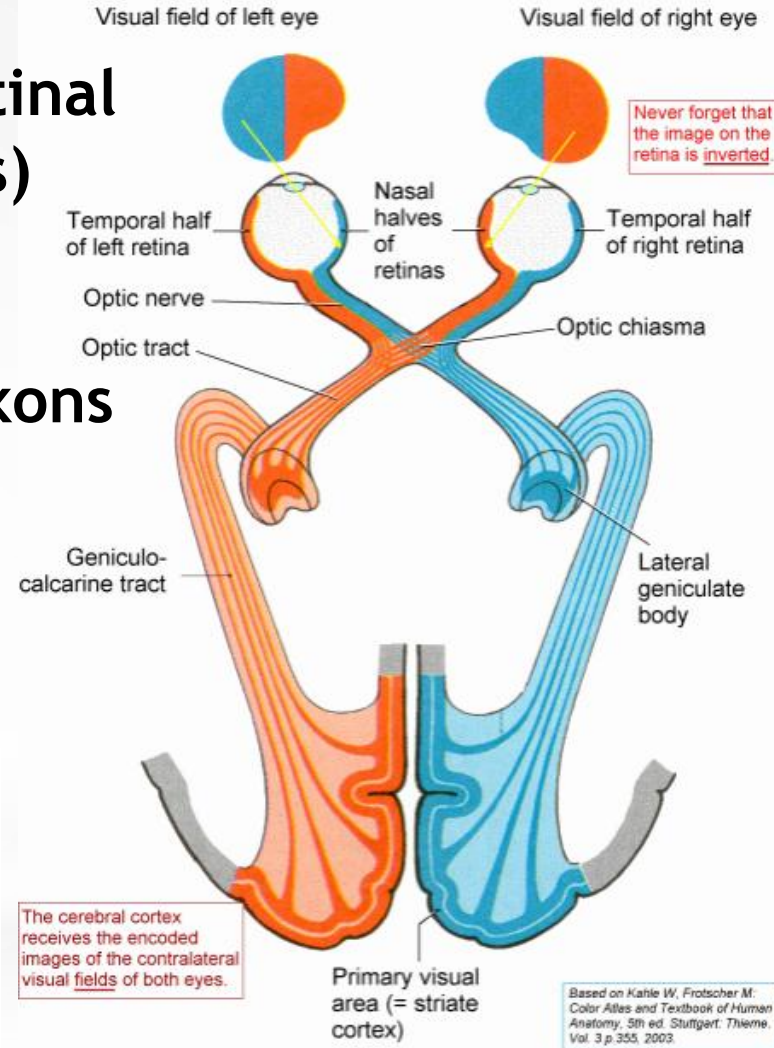

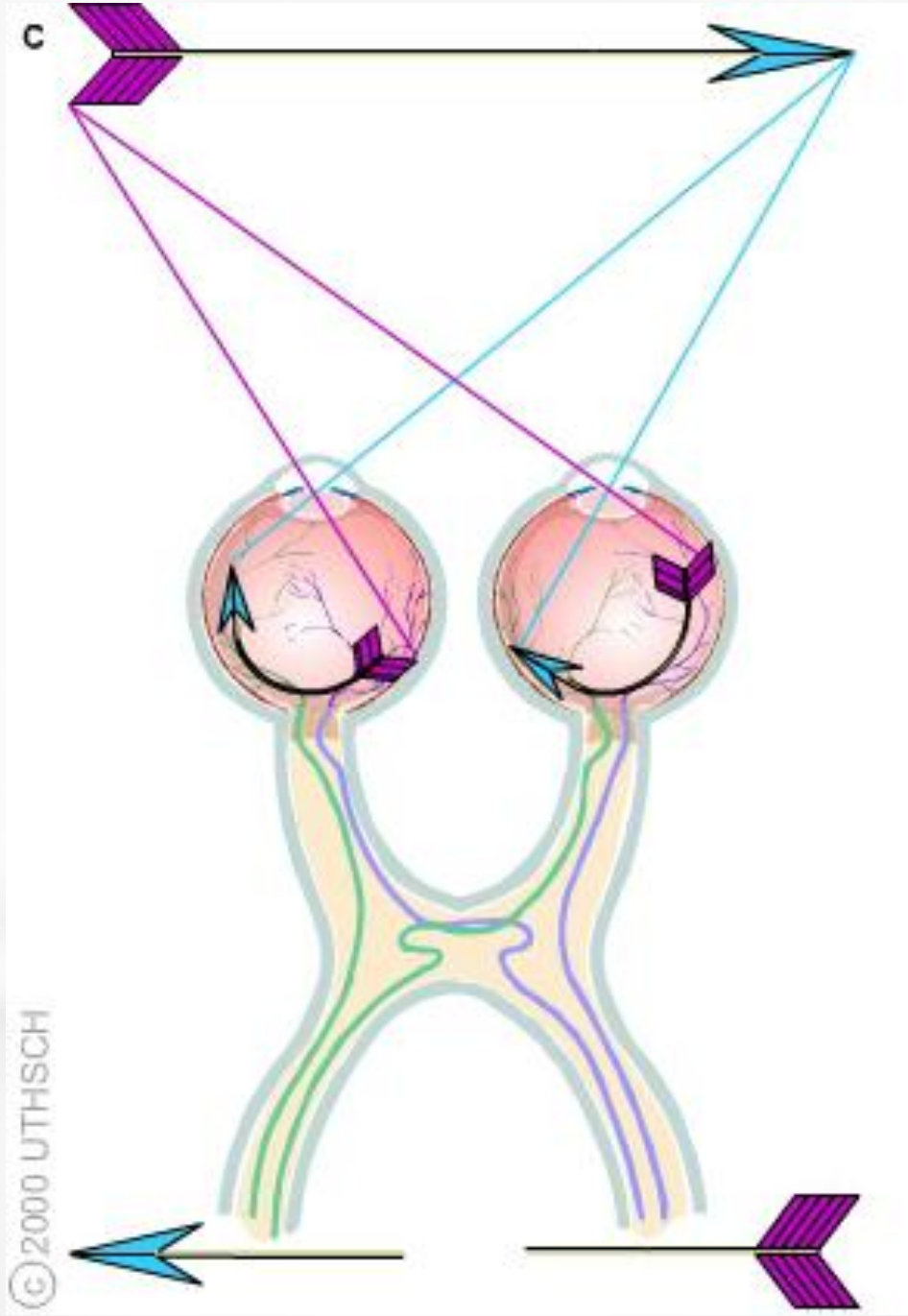

RETINOTOPY

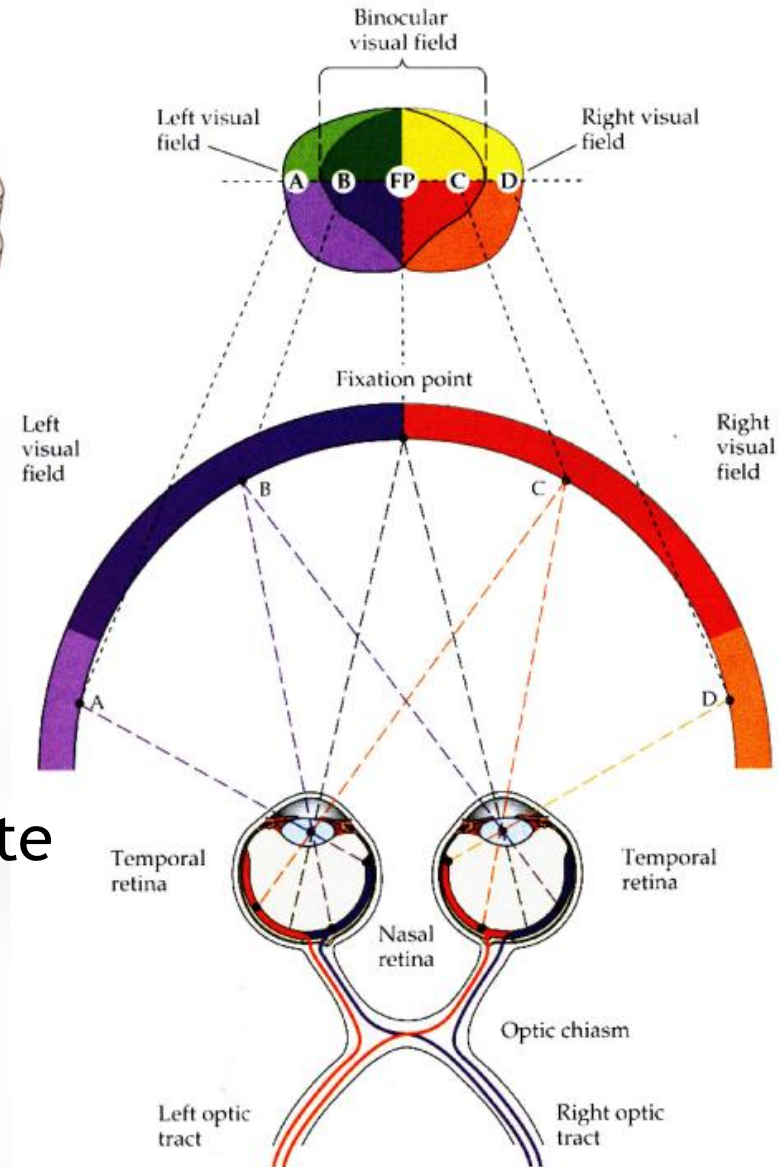
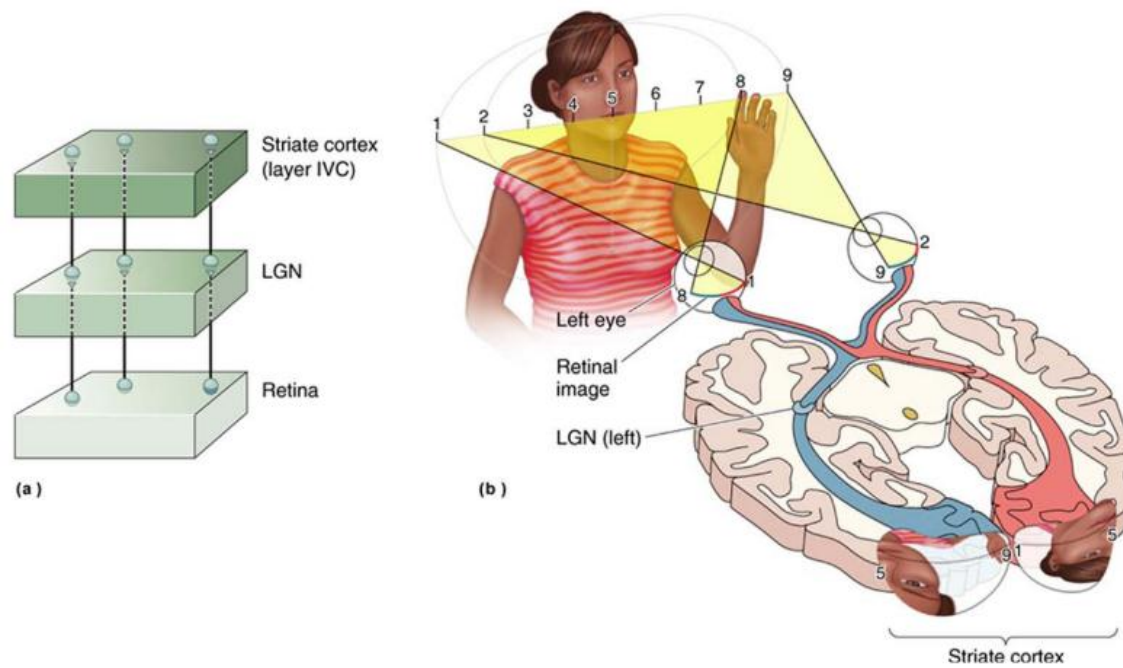

- ❑ Most of the visual field is shared by the two eyes (binocular field)
- ❑ Representation of different parts of the visual field is disproportionate in size

VISUAL CORTEX

(A) Medial view of functional areas

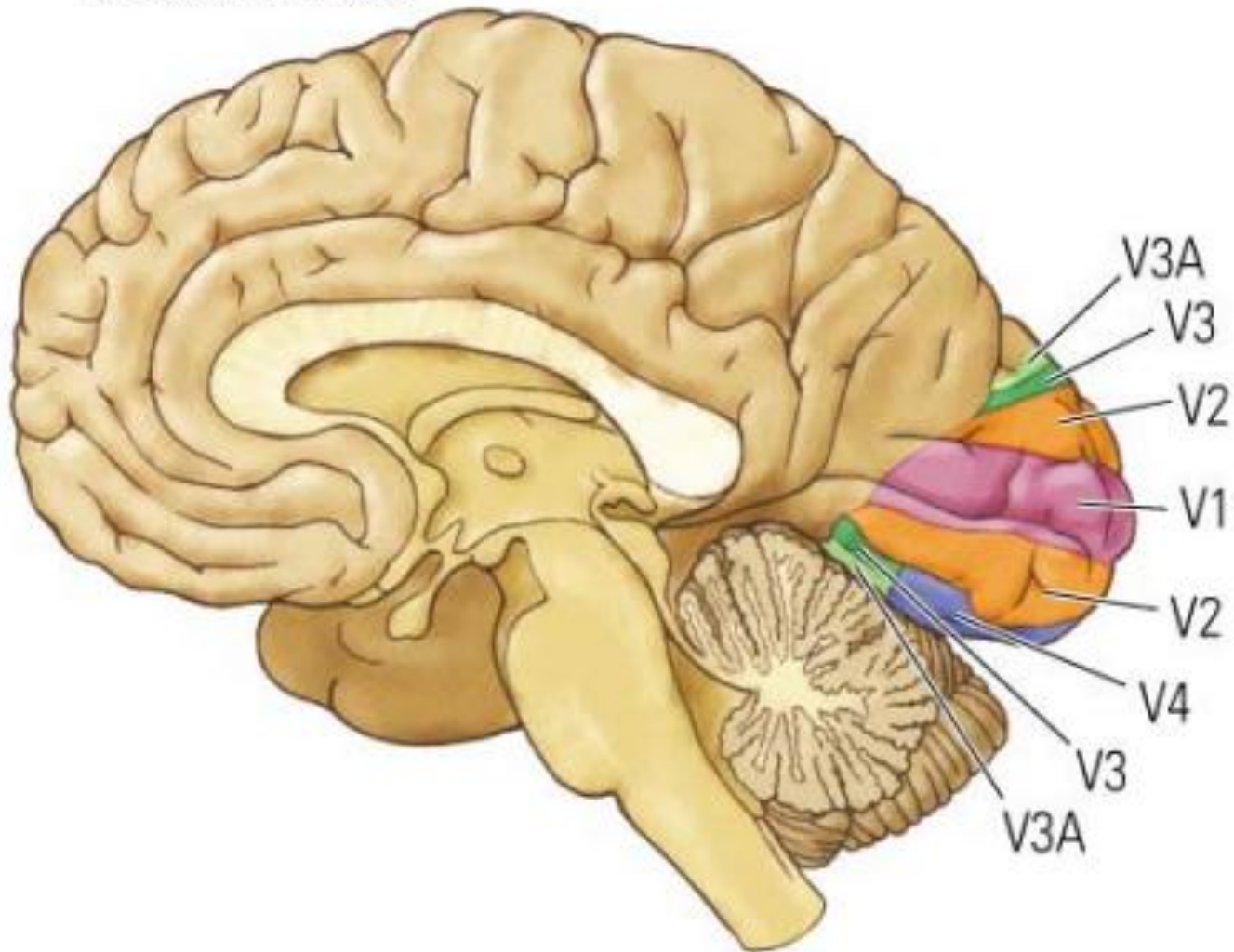

PRIMARY VISUAL CORTEX (V1)

- ❑ Most LGN axons terminate in V1
- ❑ All V1 neurons respond to visual stimuli exclusively
- ❑ Ablating V1 results in blindness in the contralesional hemifield (homonymous hemianopsia)

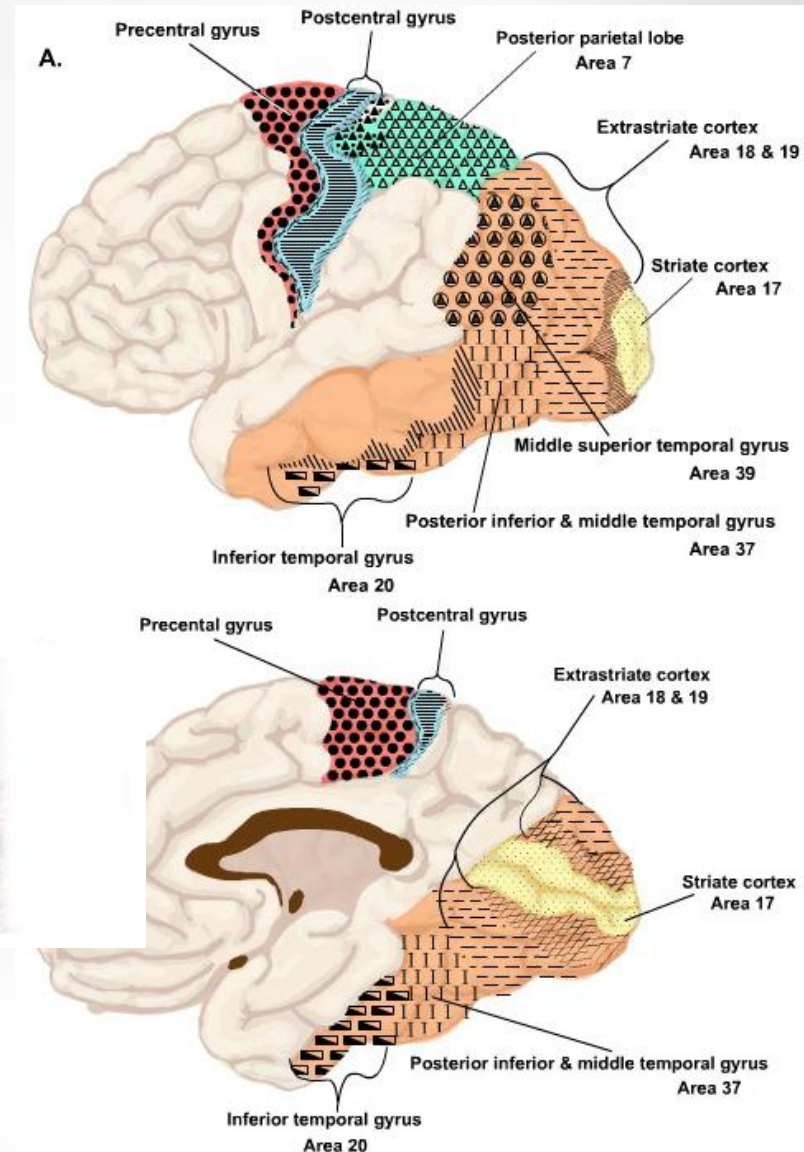

- ❑ Electrical stimulation of V1 elicits visual sensations

VISUAL ASSOCIATION CORTEX

Dorsal Stream

- spatial orientation
- binocular fusion/depth perception
- the location, the movement and the movement direction and velocity of objects in space

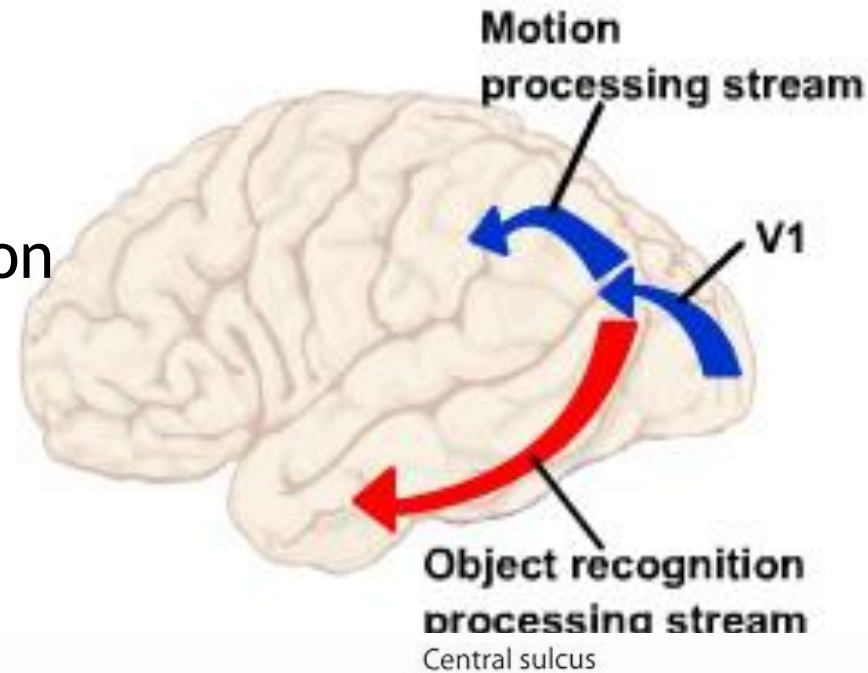

Ventral Stream

- recognize objects and colors
- read text
- learn and remember visual objects (e.g., words and their meanings)

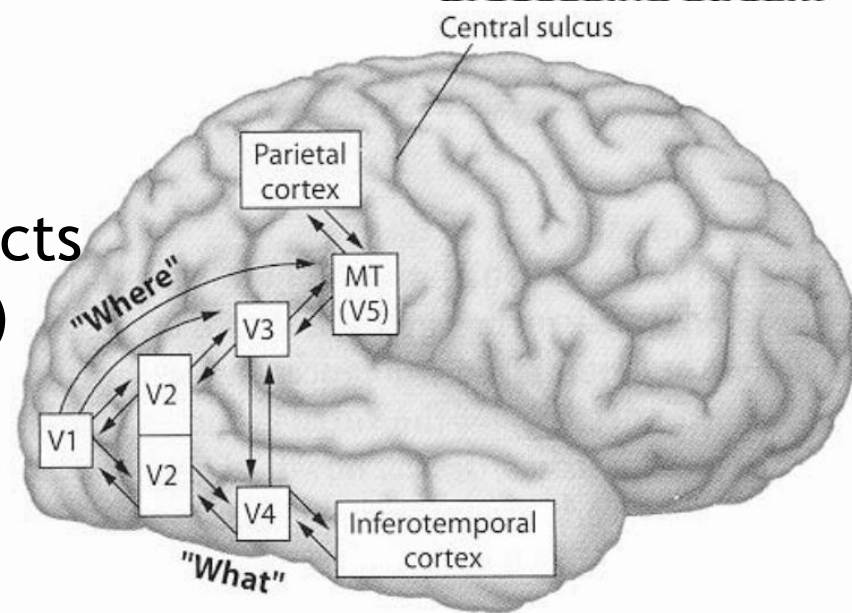

VISUAL PATHWAYS TO SUBCORTICAL STRUCTURES

- ❑ to the suprachiasmatic nucleus of hypothalamus
- ❑ to the pretectum of the midbrain
- ❑ to the superior colliculus

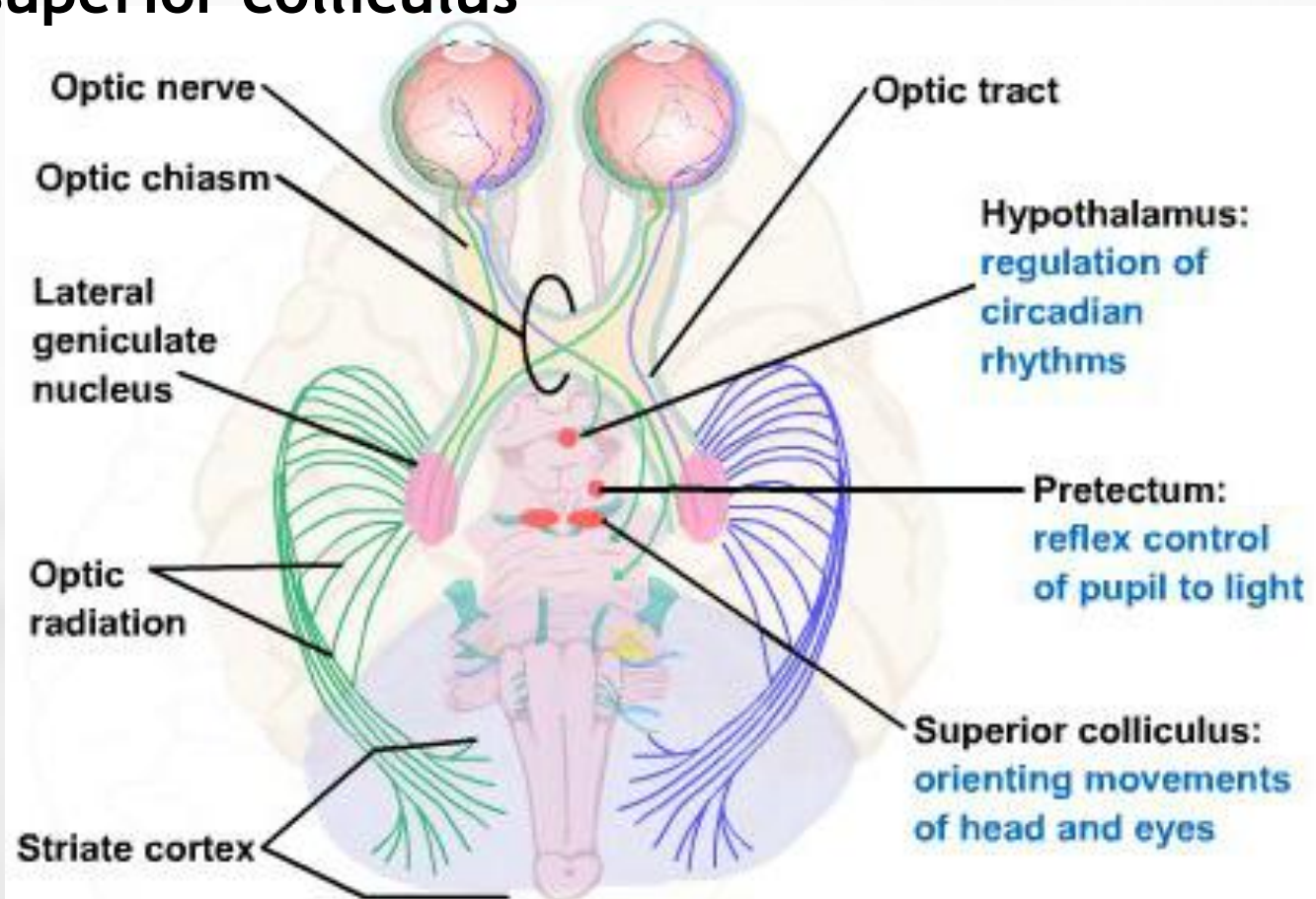

AUDITORY PATHWAY

1st order neuron

- bipolar neuron of the spiral ganglion
- dendrites make synapses with hair cells
- axons form the cochlear part of CN VIII

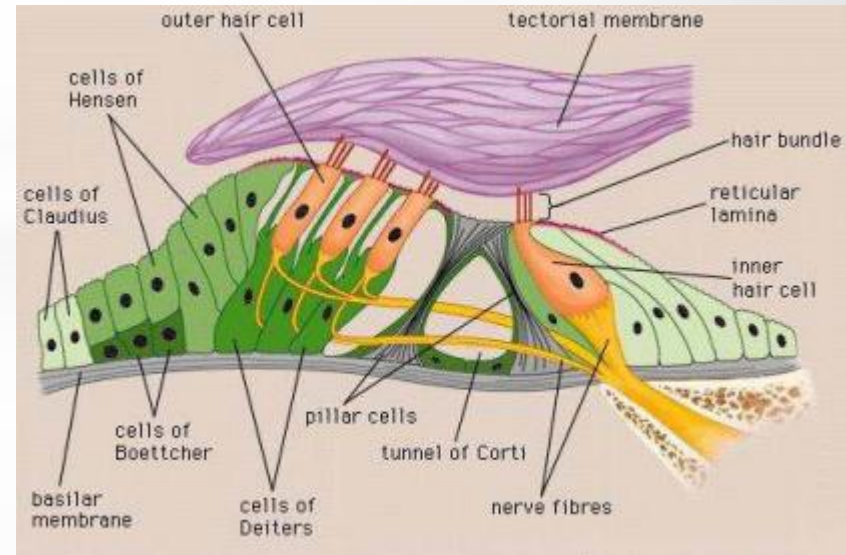
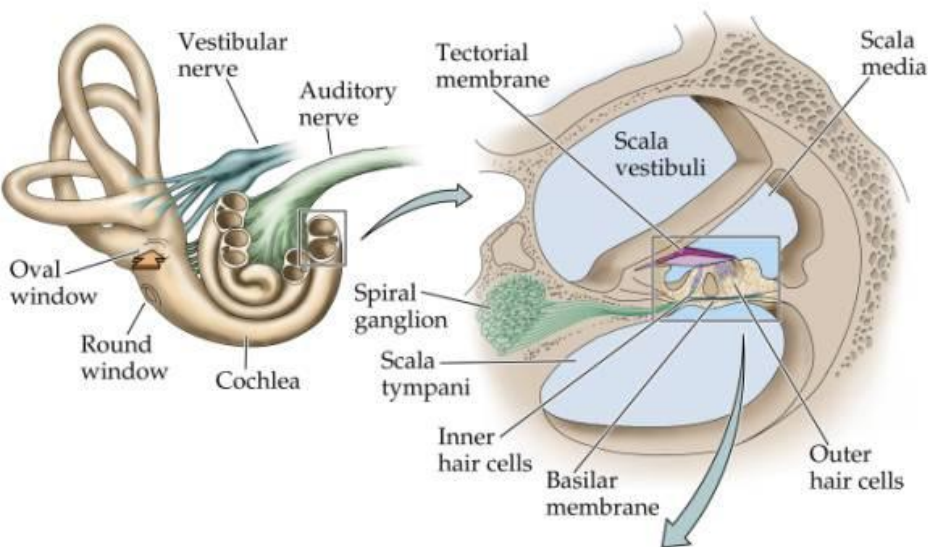

2nd order neuron

- ventral cochlear nucleus → trapezoid body → lateral lemniscus
- dorsal cochlear nucleus → lateral lemniscus

3rd order neuron

- nucleus of inferior colliculus
→ brachium c.i.

4th order neuron

- medial geniculate nucleus
→ radiatio acustica
(internal capsule)

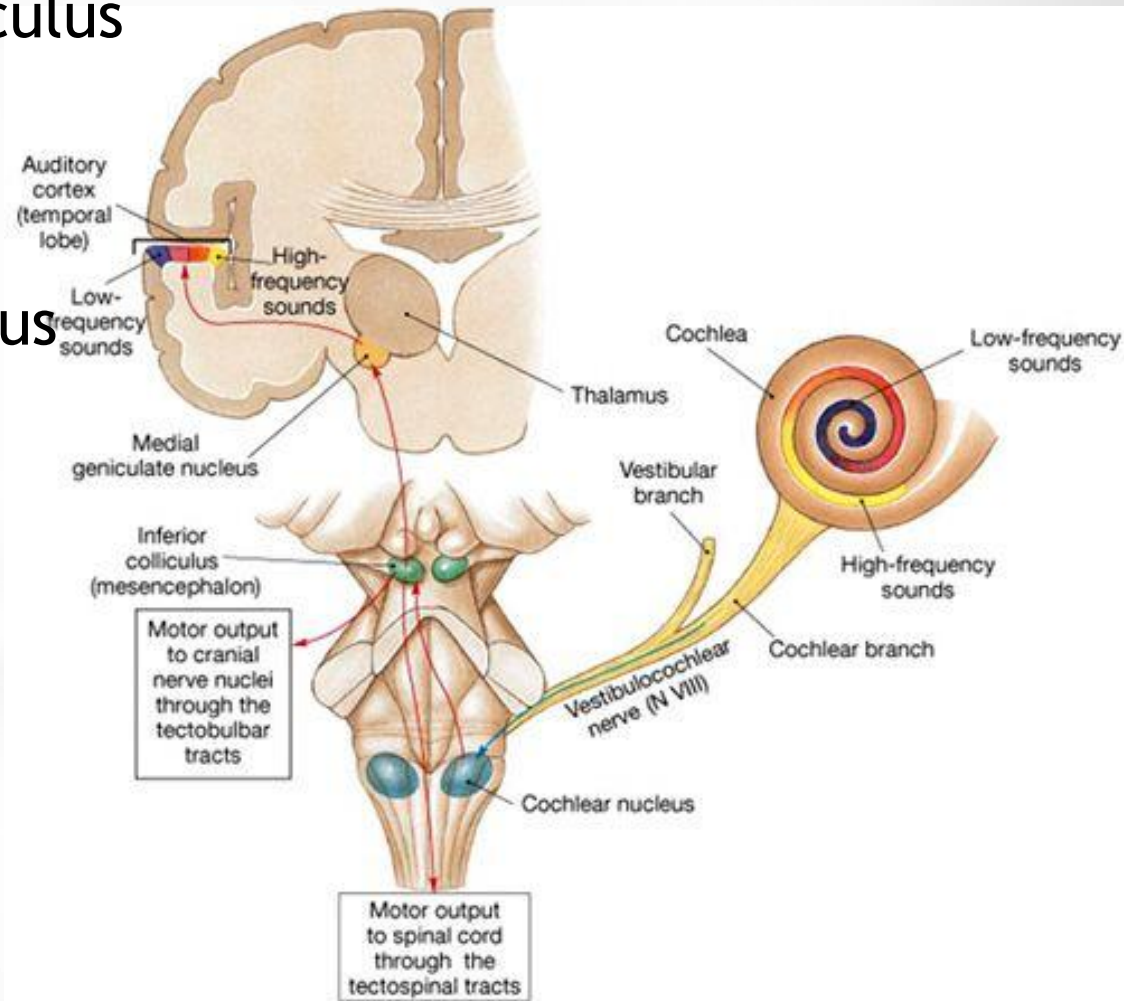

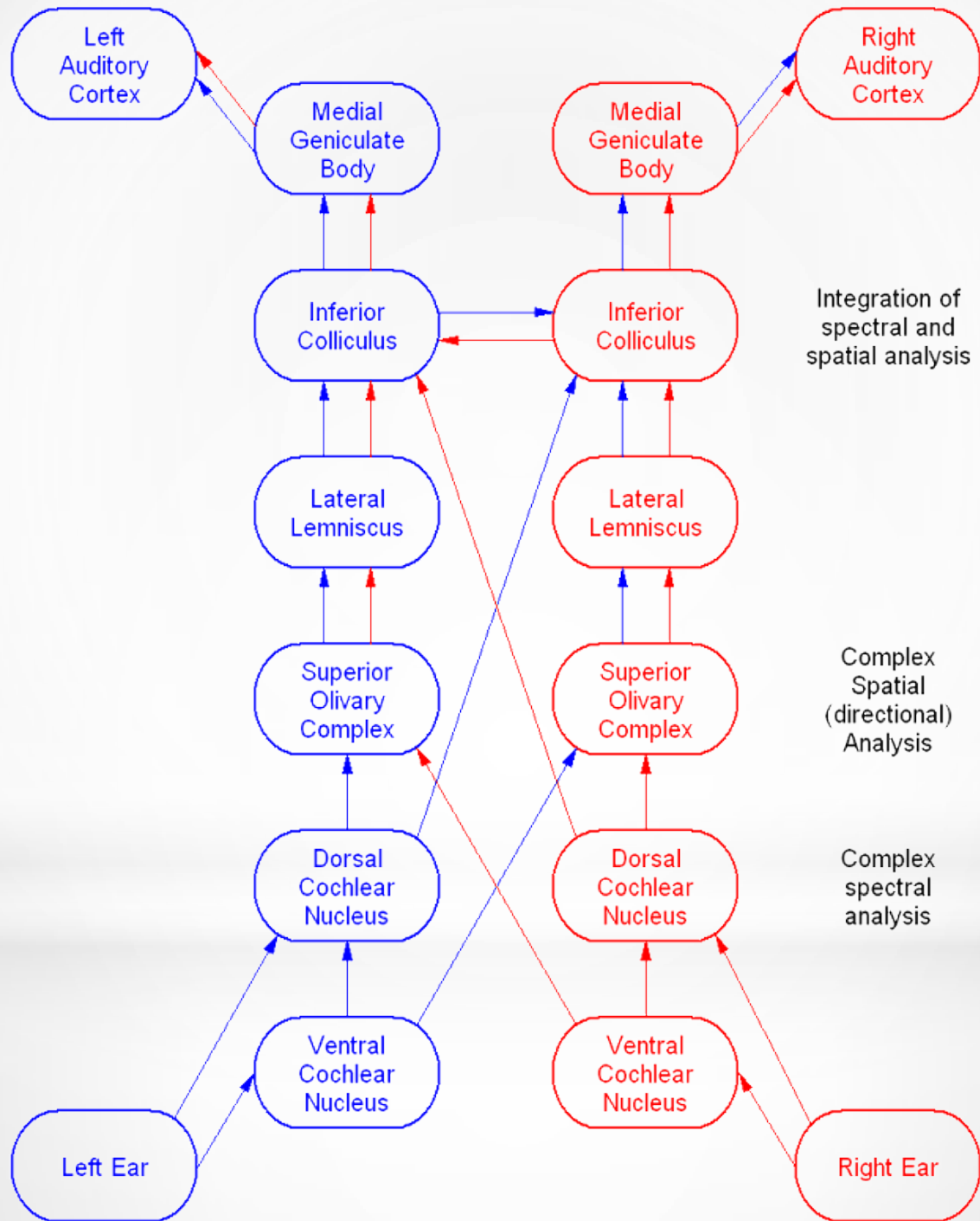

PRIMARY AUDITORY CORTEX

gyrus temporalis superior (gyri temporales transversi of Heschl)
- area 41 + 42

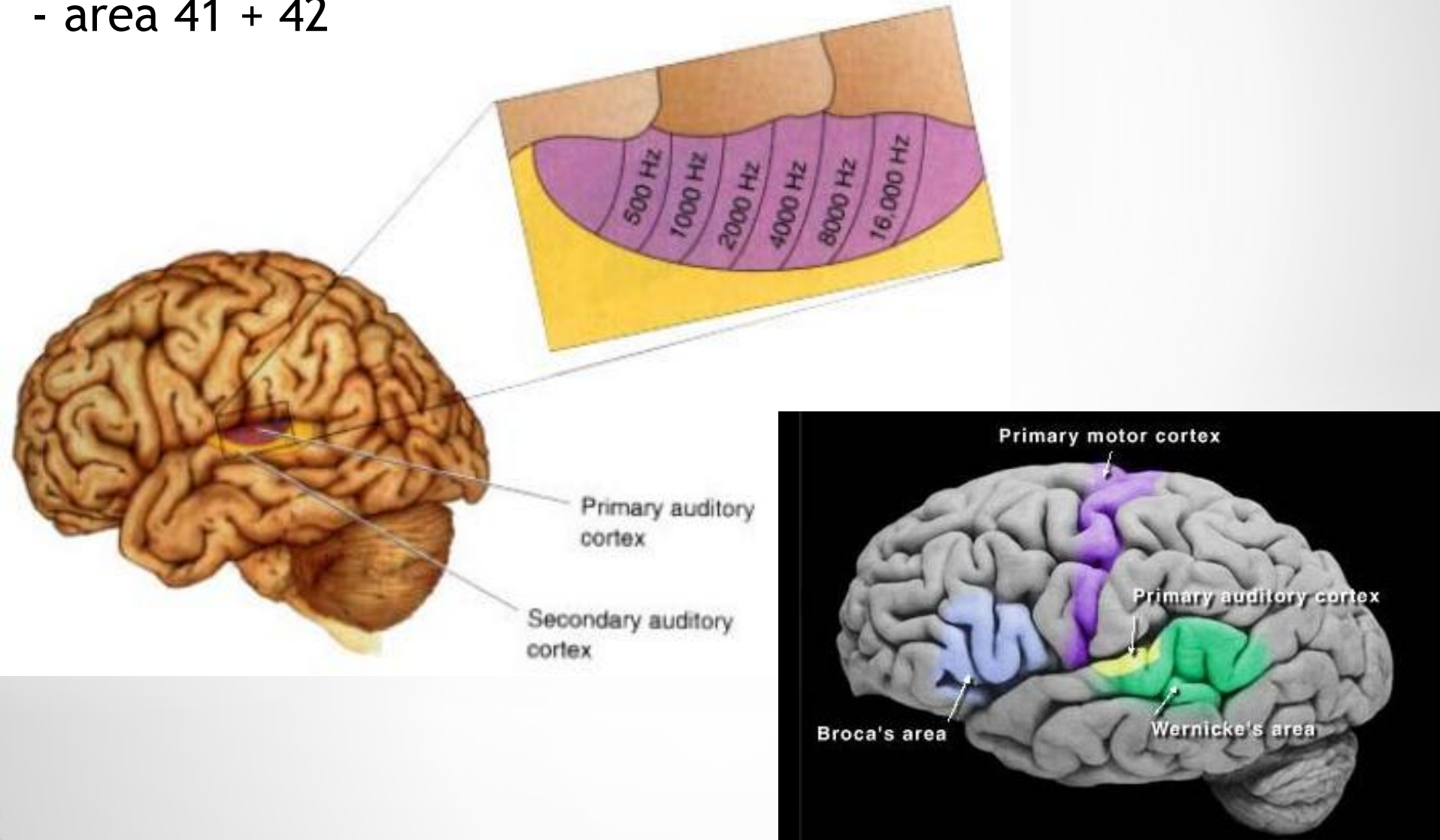

Two functionally significant features:

- ❑ tonotopical organization
- ❑ bilateral projection

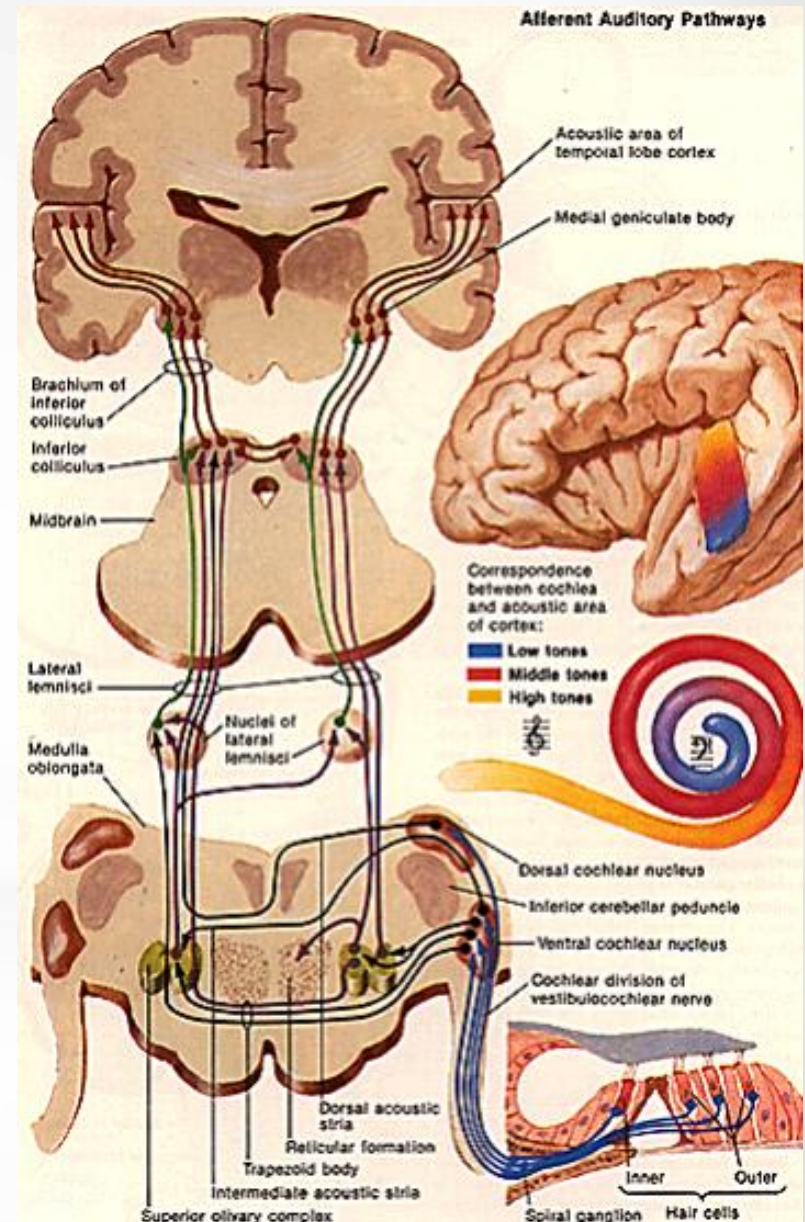

DESCENDING PATHWAYS

- ❑ feedback system processing ascending information
- ❑ enhance signals
- ❑ suppress noise
- ❑ mainly functions of the superior olivary complex
- ❑ focus on a particular speaker and inhibit other voices

The principal central connections of hearing.

Solid coloured lines show the ascending pathways to the primary auditory cortex.

Descending connections are represented by broken lines.

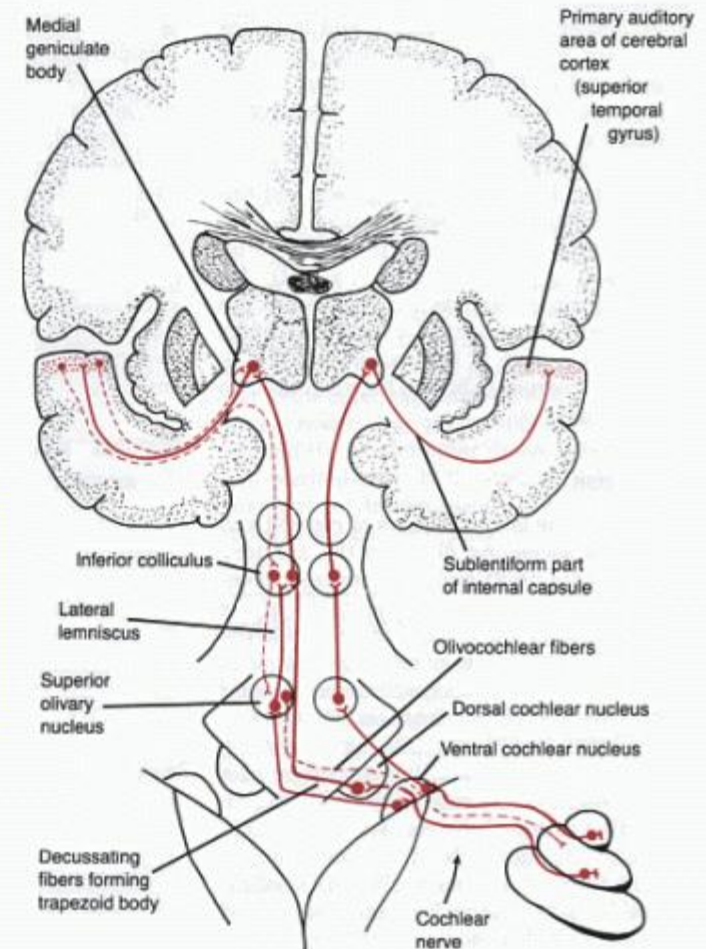

VESTIBULAR PATHWAYS

- ❑ changes in the motion of the head (kinetic) and in the position of the head with respect to gravity (static)
- ❑ 3 afferent sources: the eyes, general proprioceptive receptors throughout the body, and the vestibular receptors in the inner ear
- ❑ to maintain equilibrium, to direct the gaze of the eyes, and to preserve a constant plane of vision

VESTIBULAR APPARATUS

- ❑ Labyrinth of static apparatus
 - **macula utriculi** - orientation in horizontal position
 - **macula sacculi** - orientation in vertical position
- ❑ Labyrinth of kinetic apparatus
 - **cristae ampullares** of semicircular ducts

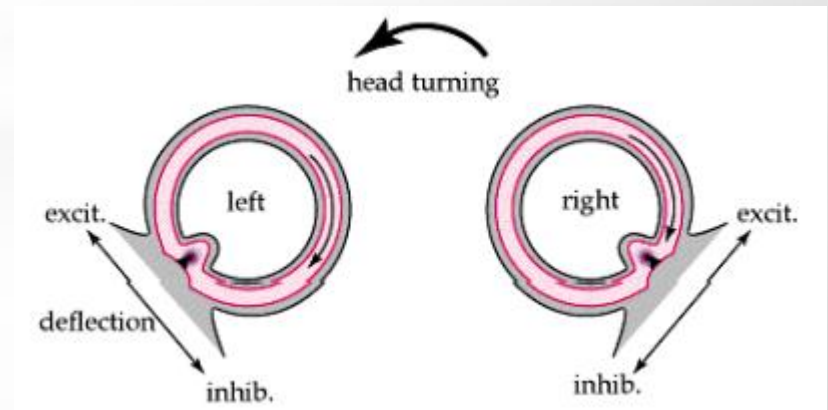

- ❑ Hair cells in the maculae of the saccule and the utricle respond to **linear acceleration** (gravity).
- ❑ Hair cells in the cristae ampullares in the semicircular ducts respond to **angular acceleration** (rotation of the head).

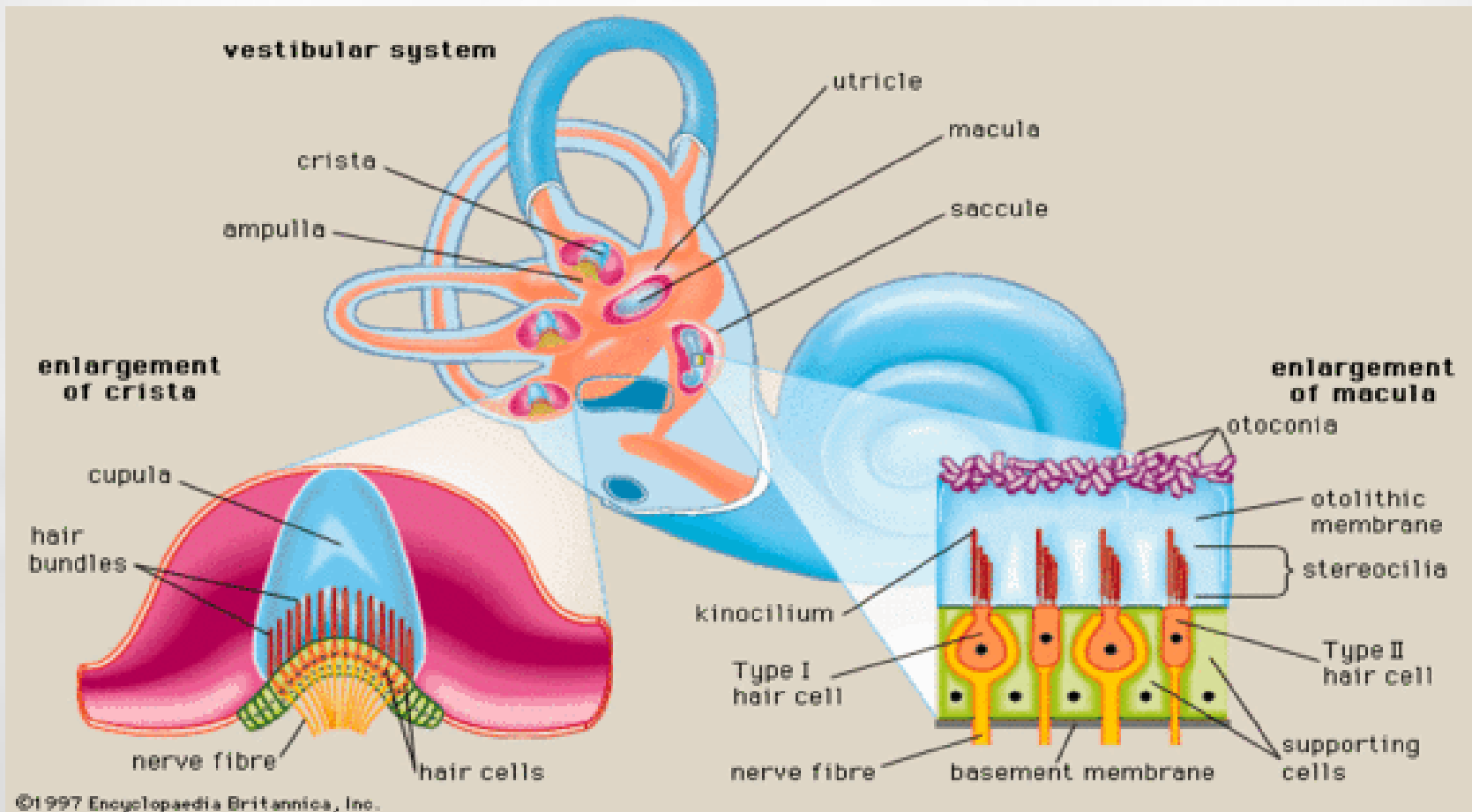

VESTIBULAR PATHWAY

□ **1st order neuron** - vestibular ganglion (utrículoampullar nerve, saccular nerve, posterior ampullar nerve)

□ **2nd order neuron** - vestibular nuclei (superior, inferior, medial, lateral)

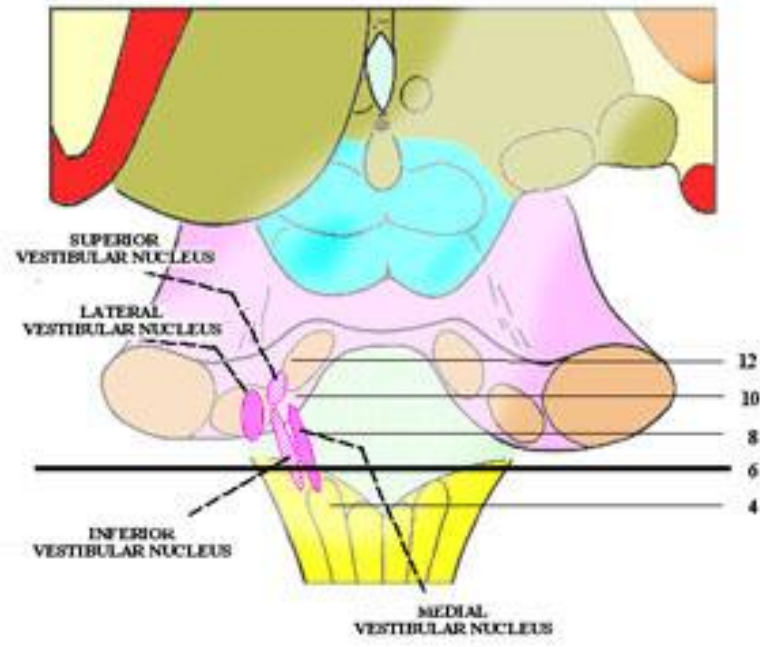
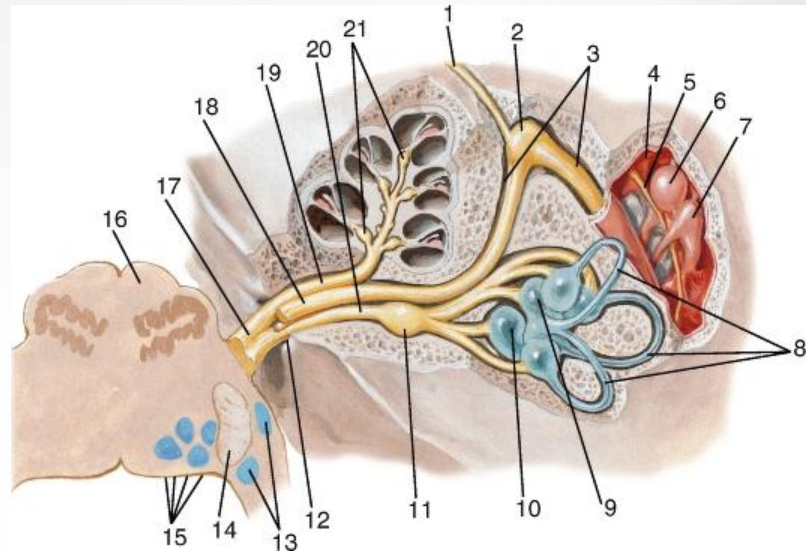

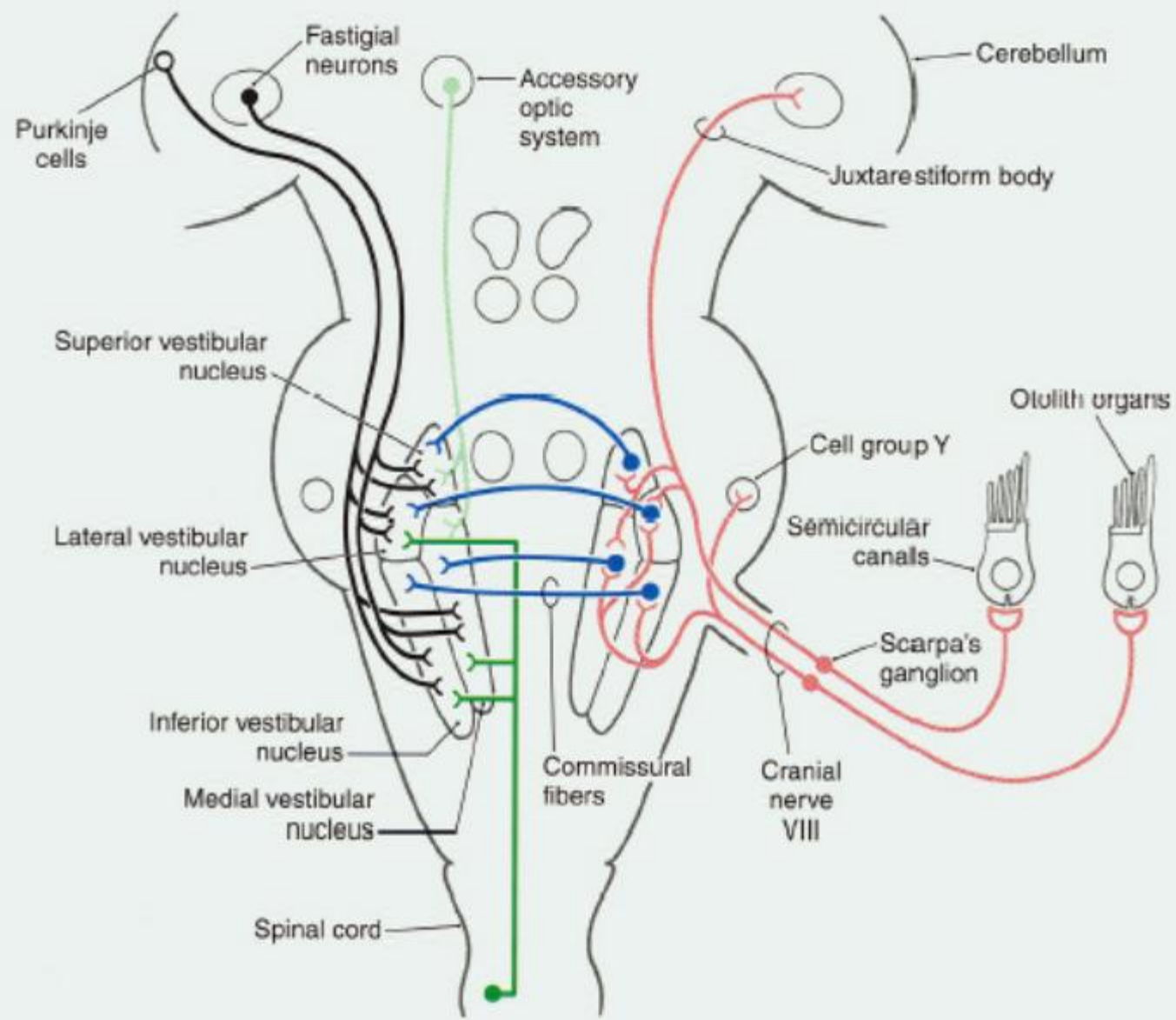

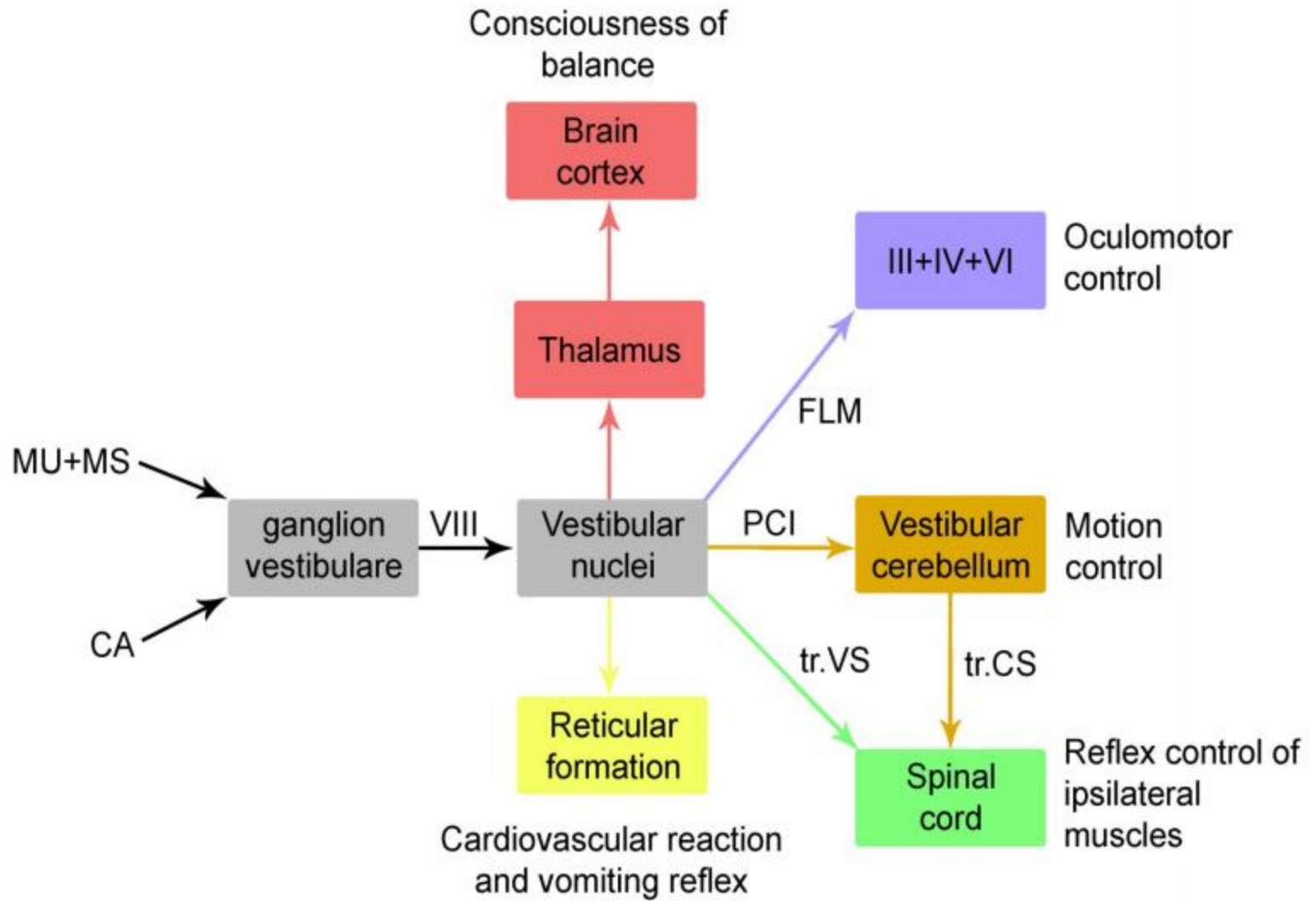

Connections with the cerebellum

- ❑ vestibular portion of the CN VIII - inferior cerebellar peduncles - ipsilateral vestibulocerebellum
- ❑ vestibular nuclei - inferior cerebellar peduncles - vestibulocerebellum

→ maintenance of balance

Connections with the spinal cord

to motoneurons that innervate axial and proximal limb muscles

□ lateral vestibulospinal tract

- from lateral vestibular nucleus
- uncrossed
- terminating at all levels of the spinal cord
- **excitatory influences for extensors**

□ medial vestibulospinal tract

- from medial vestibular nucleus
- uncrossed
- descends in the MLF
- terminates mainly at cervical levels
- **coordination of head position and eye movements**

Connections with the brain stem

- ascending portion of MLF
 - CN III, IV, VI
 - Darkschewitsch and Cajal nuclei
 - **coordination of eye movements in response to head movements**

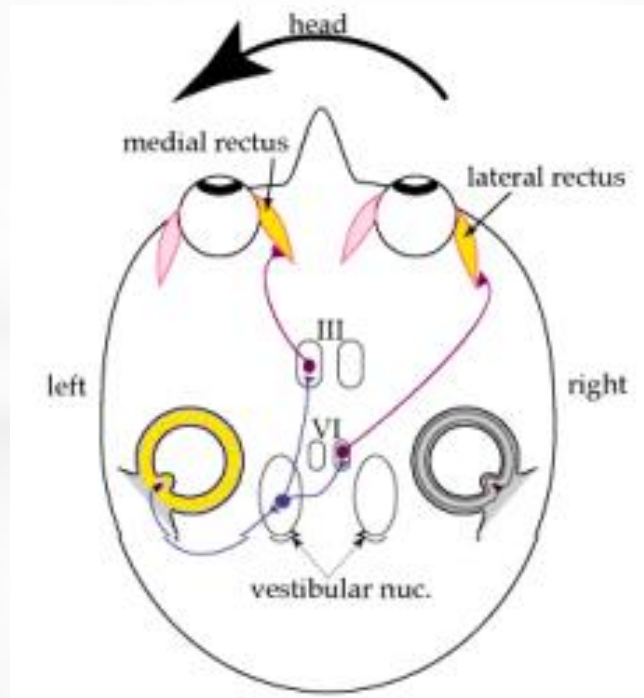

Connection with the thalamus (cortex)

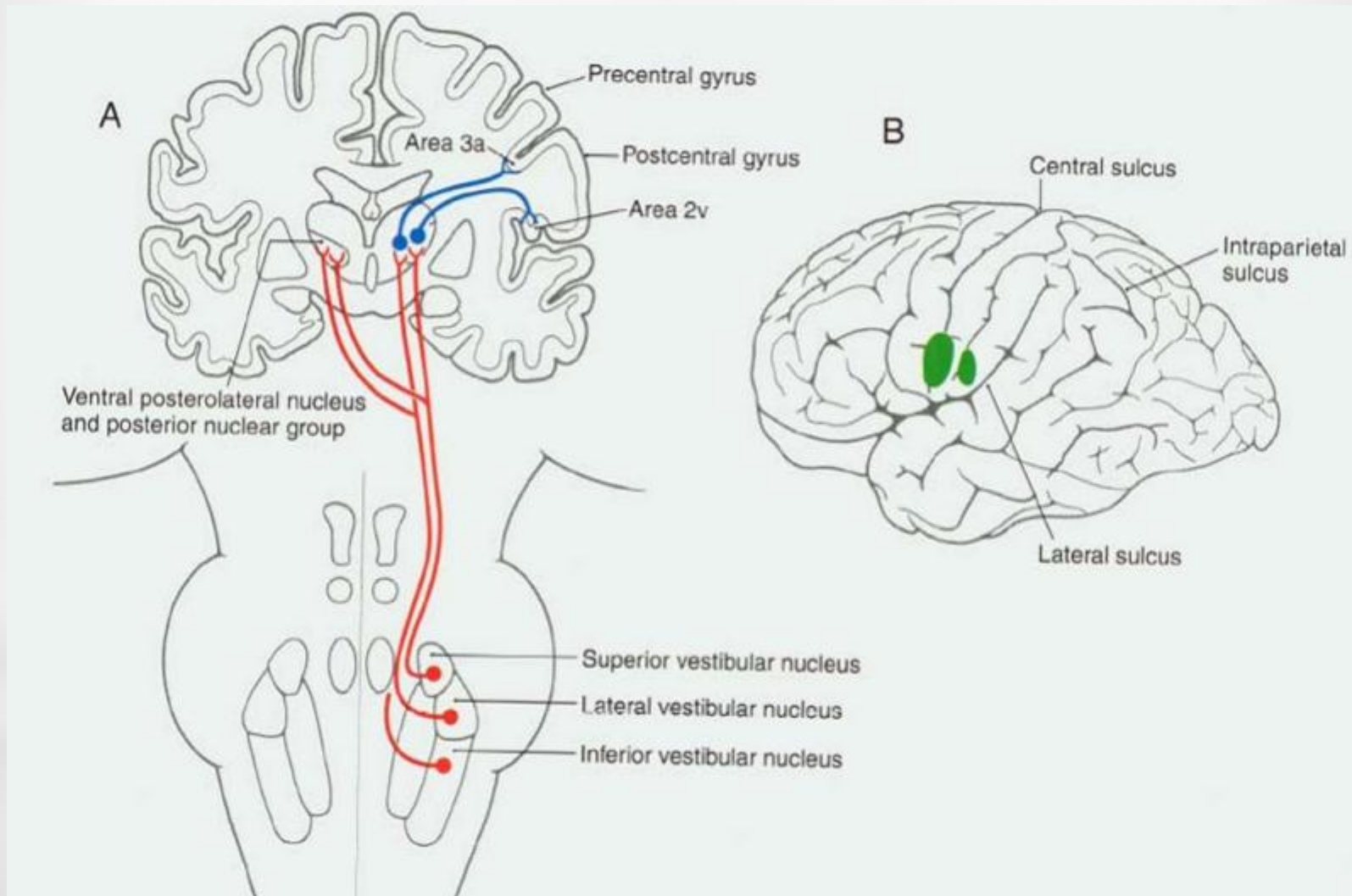

conscious perception of movement and gravity

OLFACTORY PATHWAY

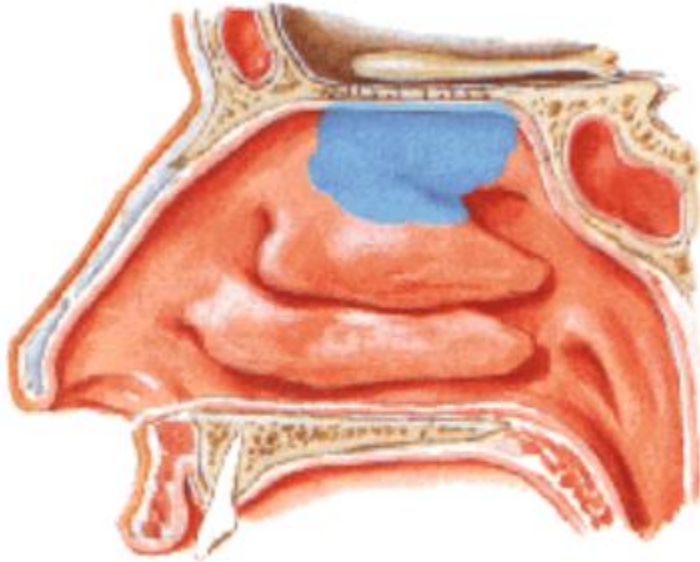

Lateral wall of nasal cavity

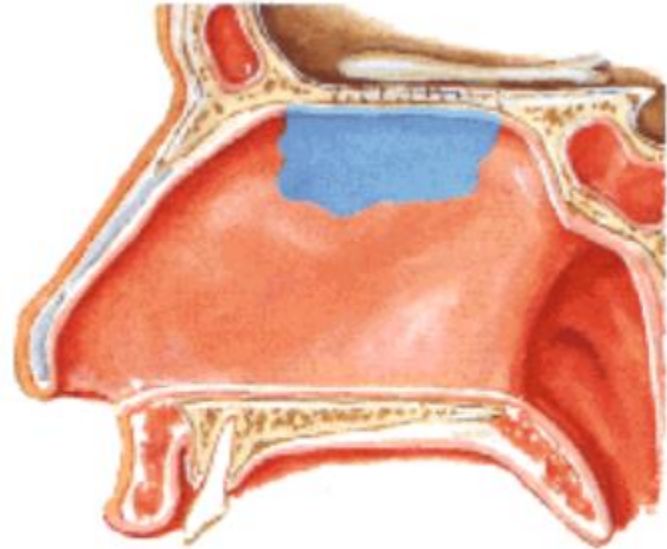

Nasal septum

Olfactory region

1st order neuron - bipolar olfactory neurons

2nd order neuron - mitral cells - olfactory tract

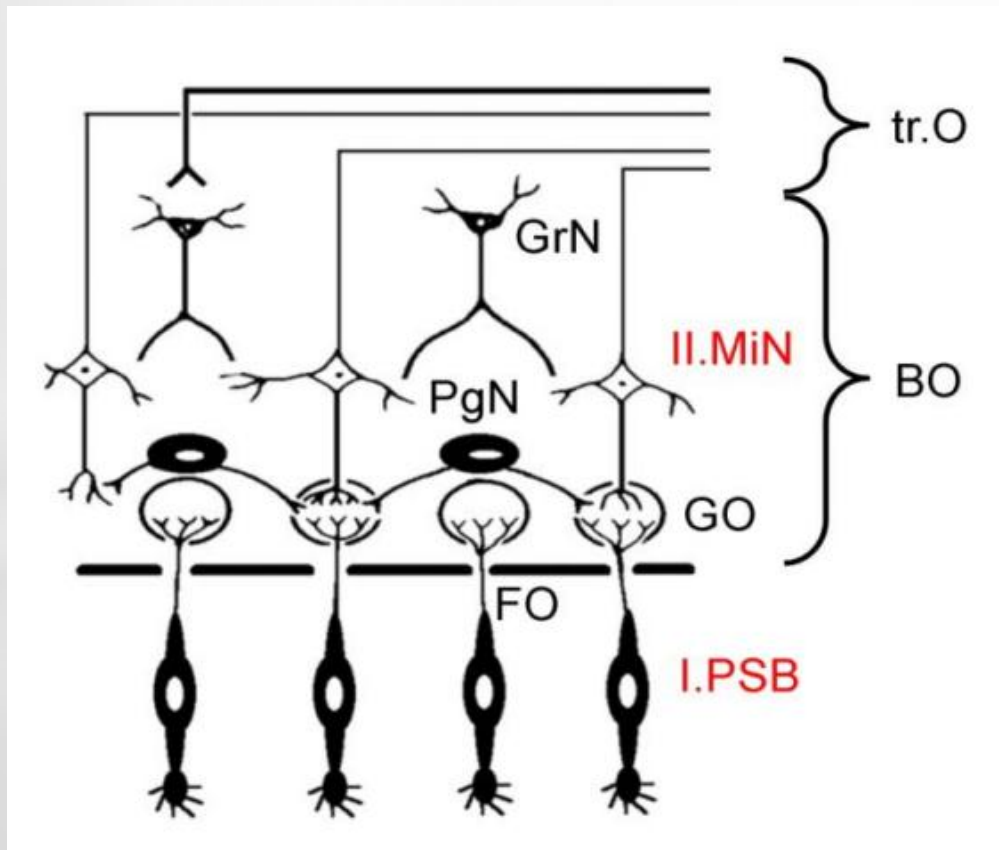
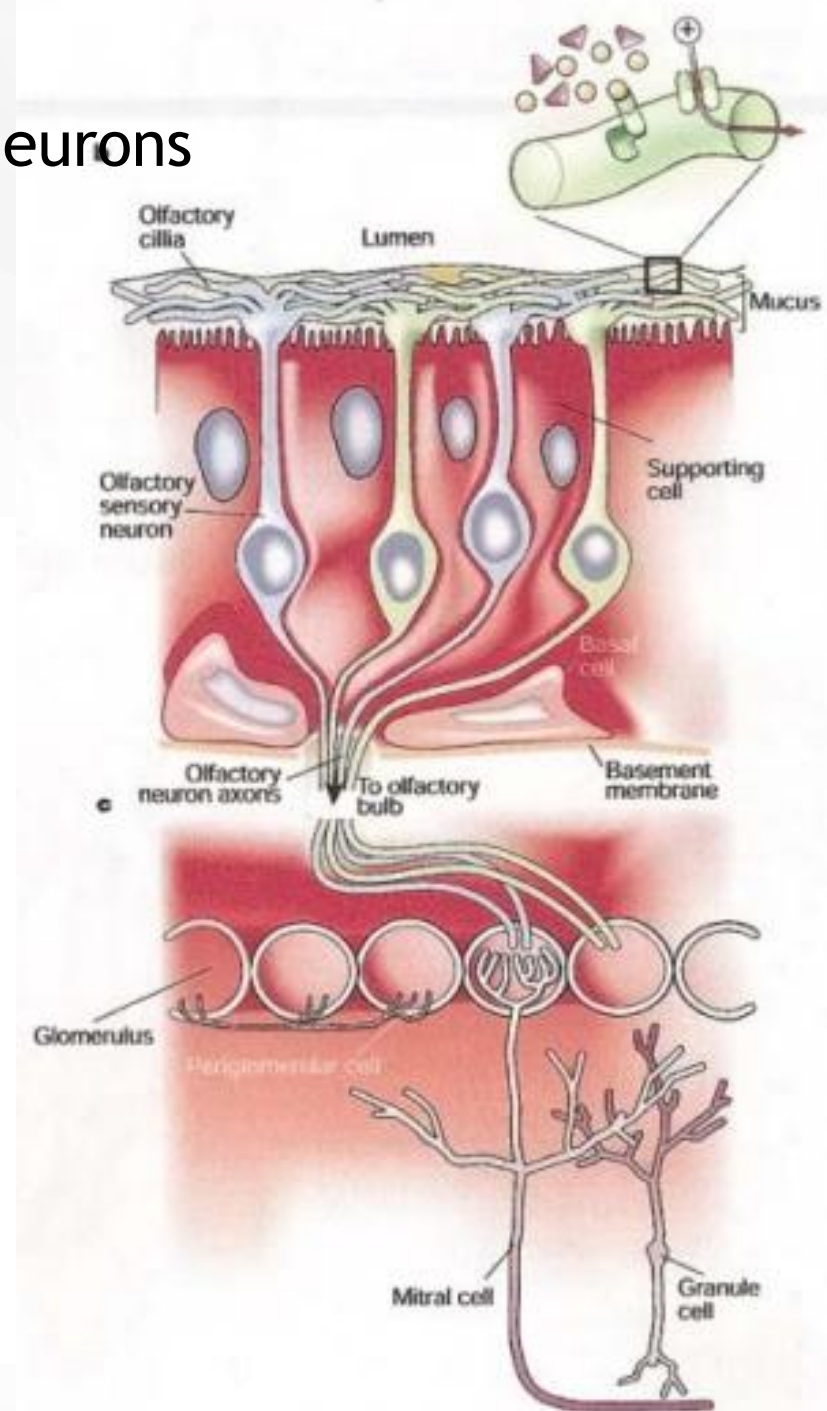

3rd order neuron - olfactory tubercle

4th order neuron - dorsomedial nucleus of thalamus

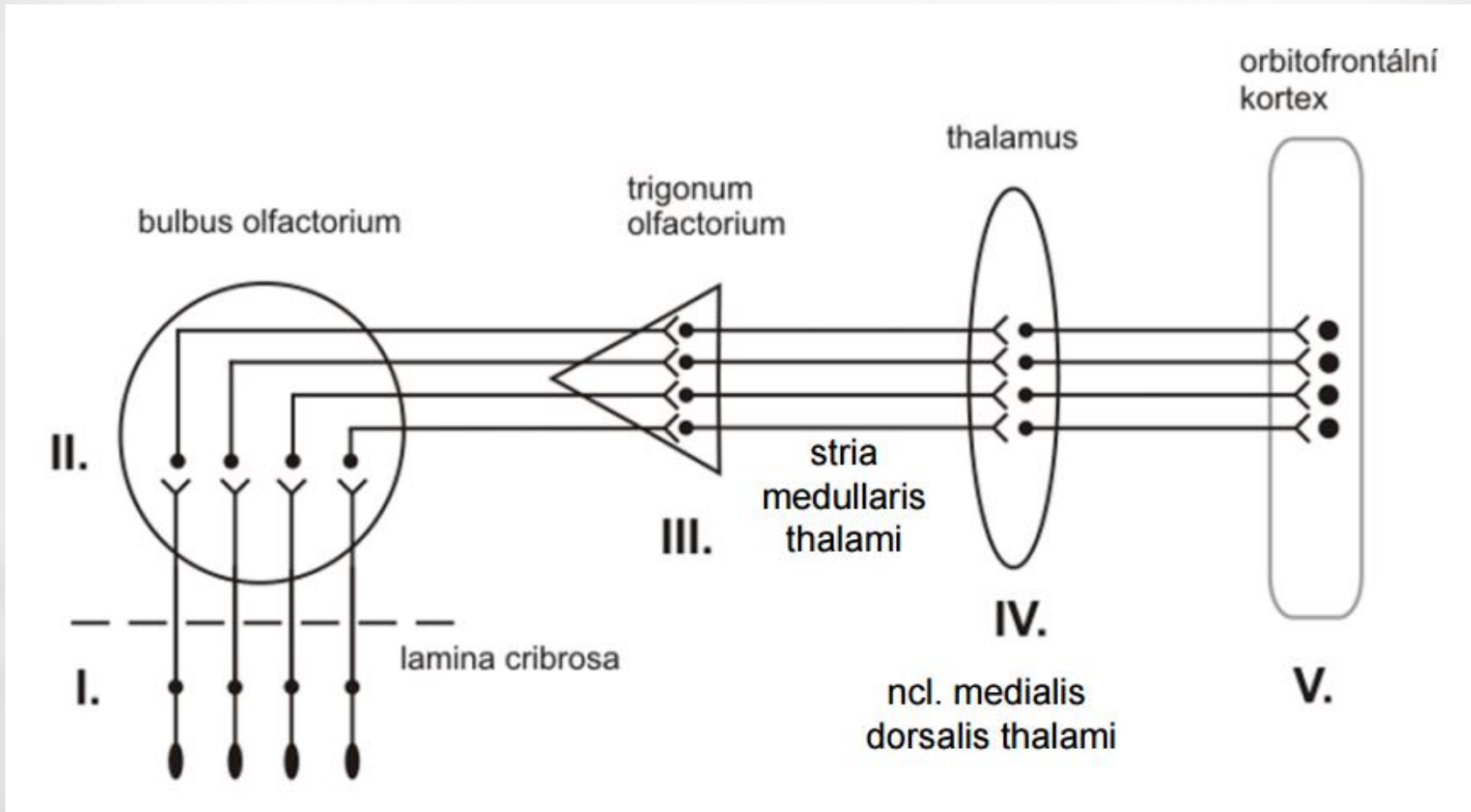

Orbitofrontal cortex (perception of olfactory information)

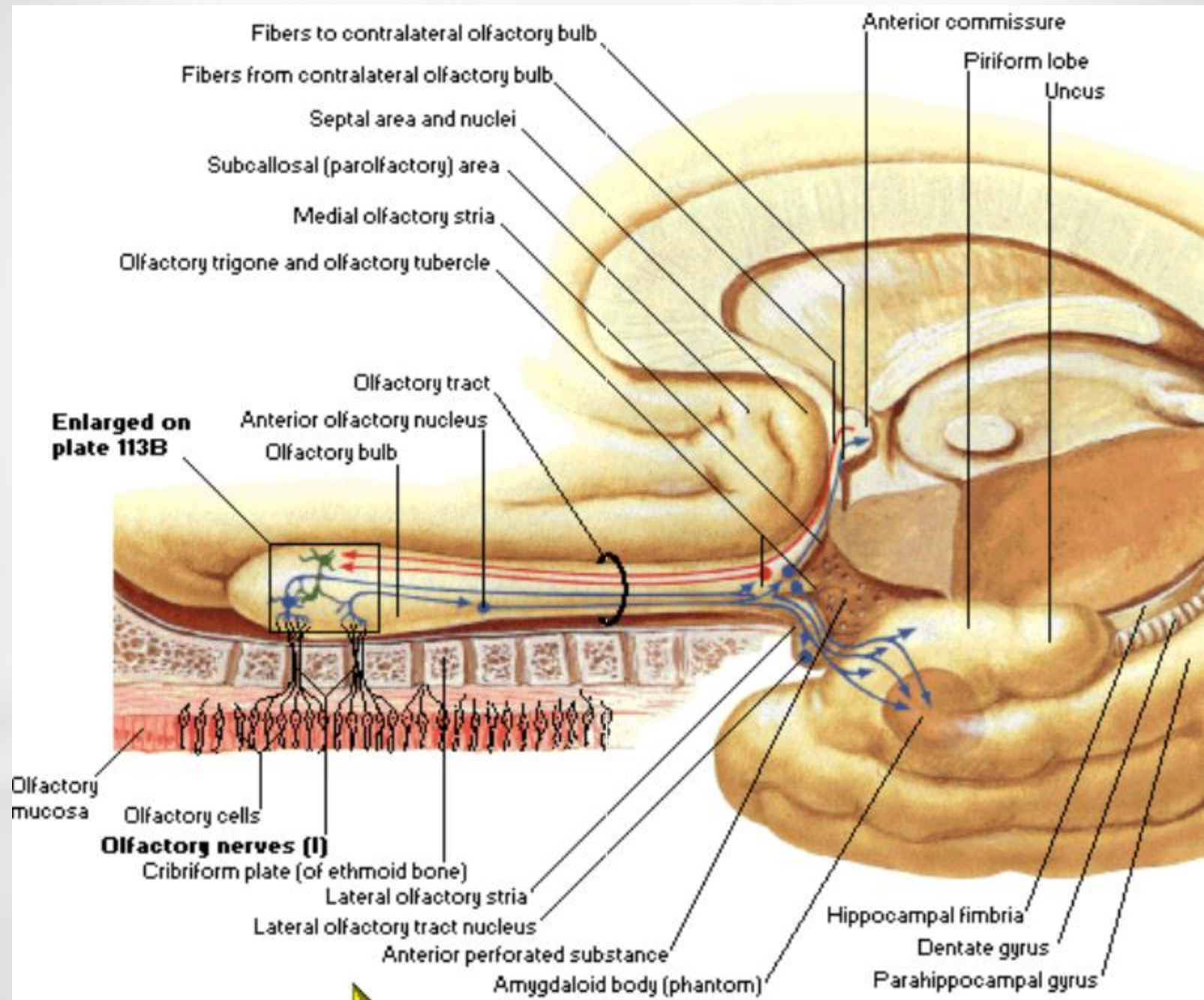

GUSTATORY PATHWAY

Taste buds

- ❑ receptor cells
(replaced about every 9-10 days
by differentiating basal cells)
- ❑ supportive columnar cells
- ❑ basal cells

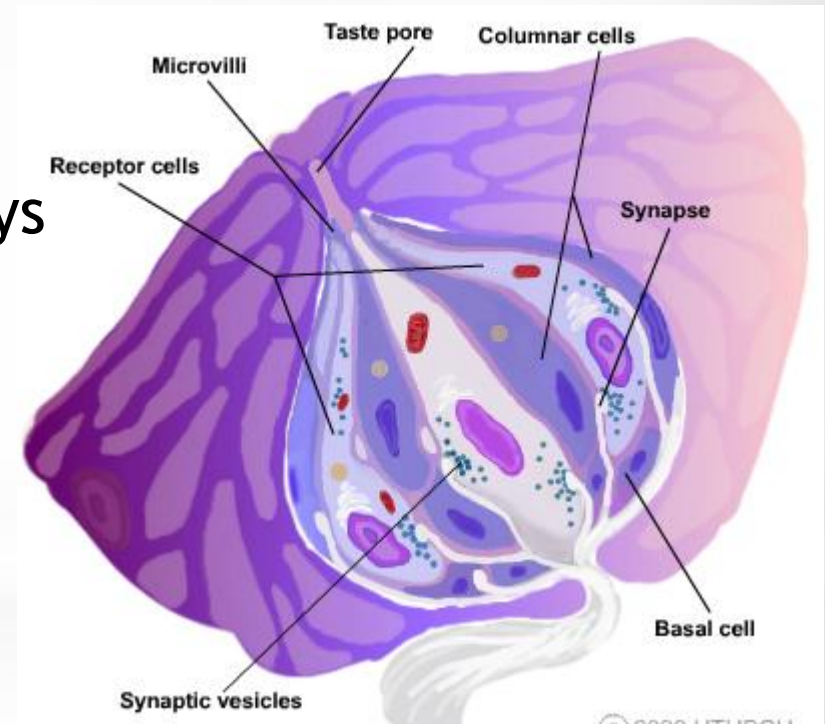

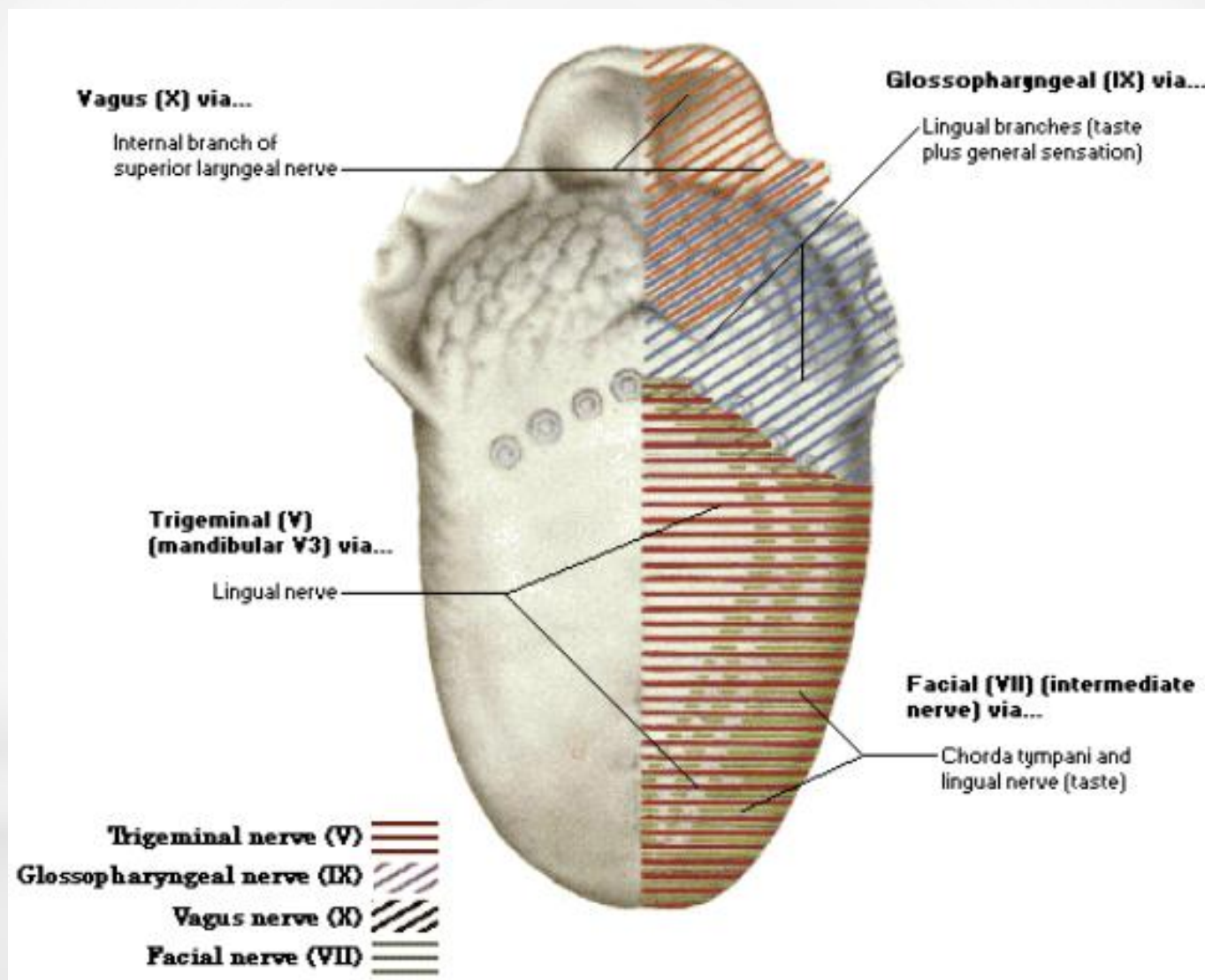

1st order neuron -

- CN VII -geniculate ganglion
 - via lingual nerve and chorda tympani
 - via greater petrosal nerve
- CN IX - inferior ganglion of CN IX
- CN X - inferior ganglion of CN X

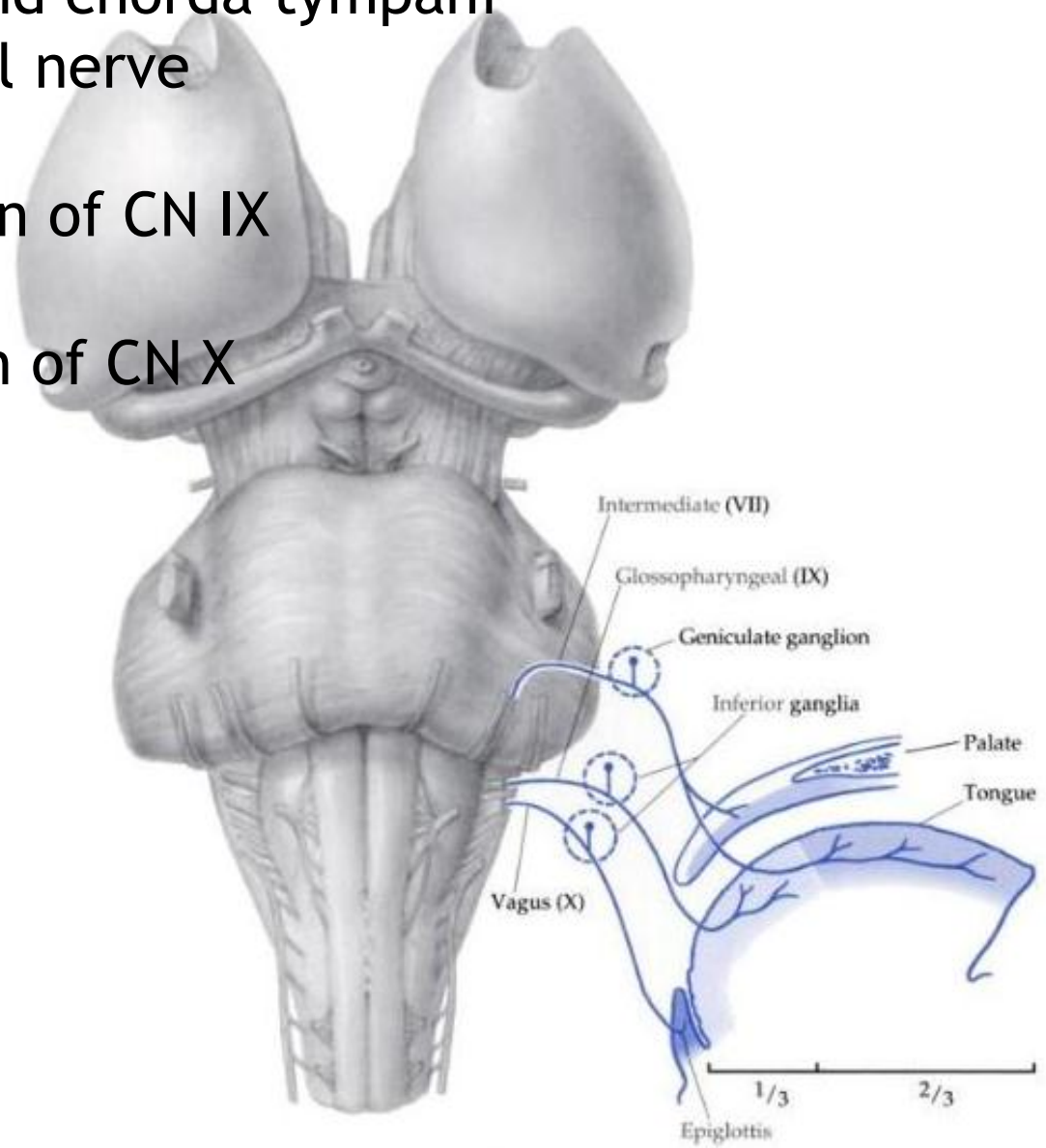

2nd order neuron - rostral part of the solitary nucleus
3rd order neuron - ventral posteromedial nucleus of thalamus

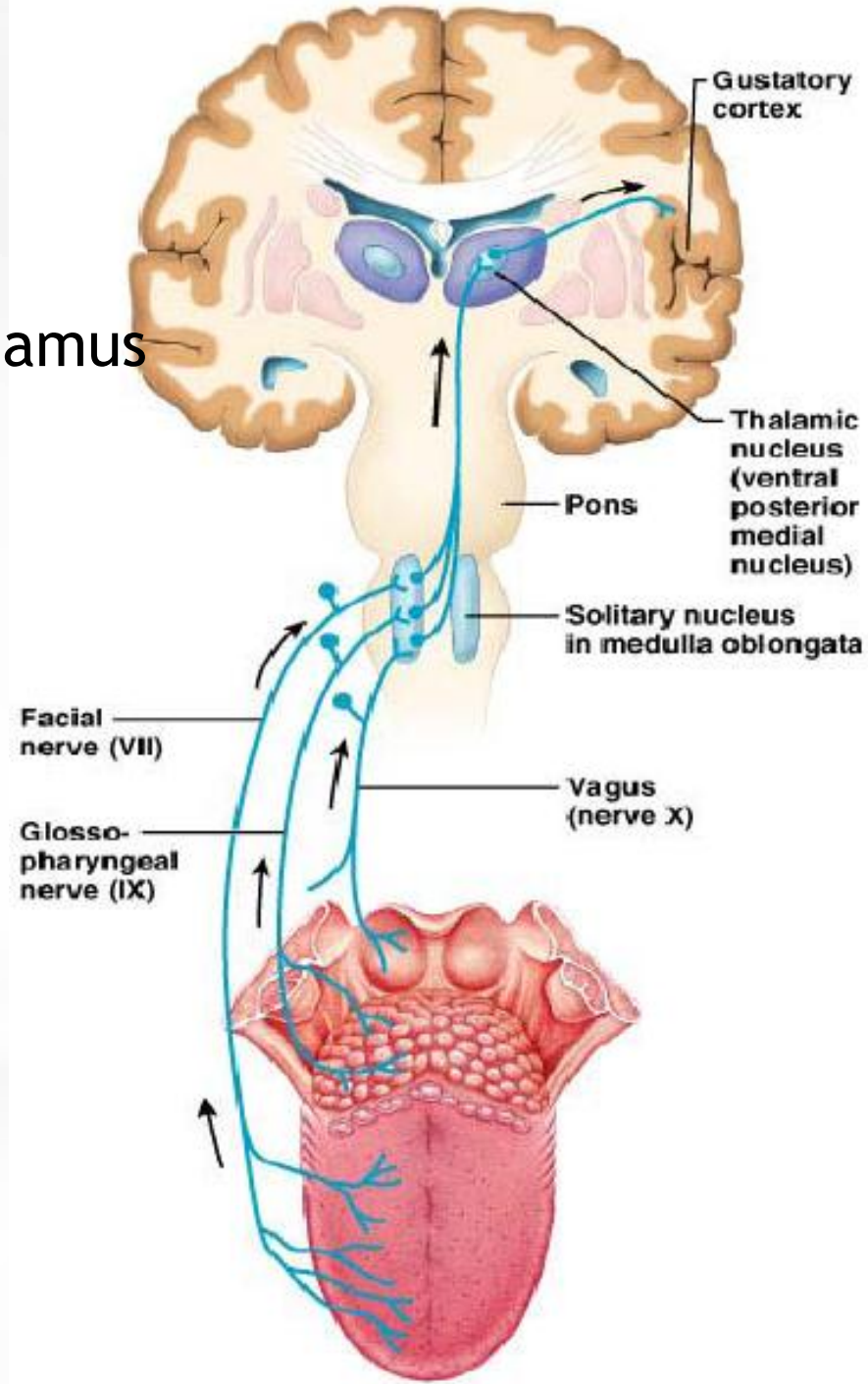

Primary gustatory cortex

- ❑ a. 43 in the postcentral gyrus
- ❑ insula

B

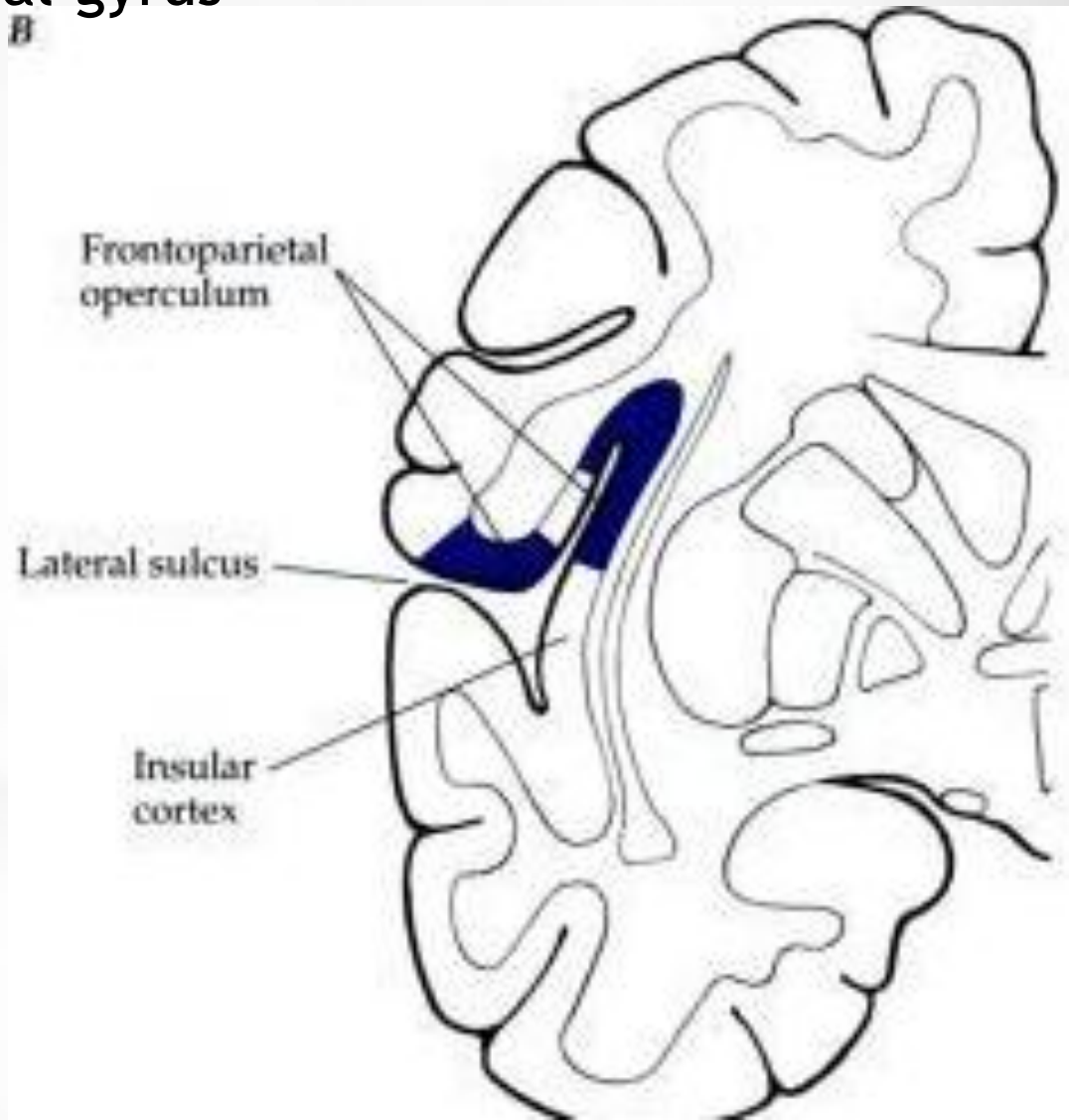

(b) Gustatory system

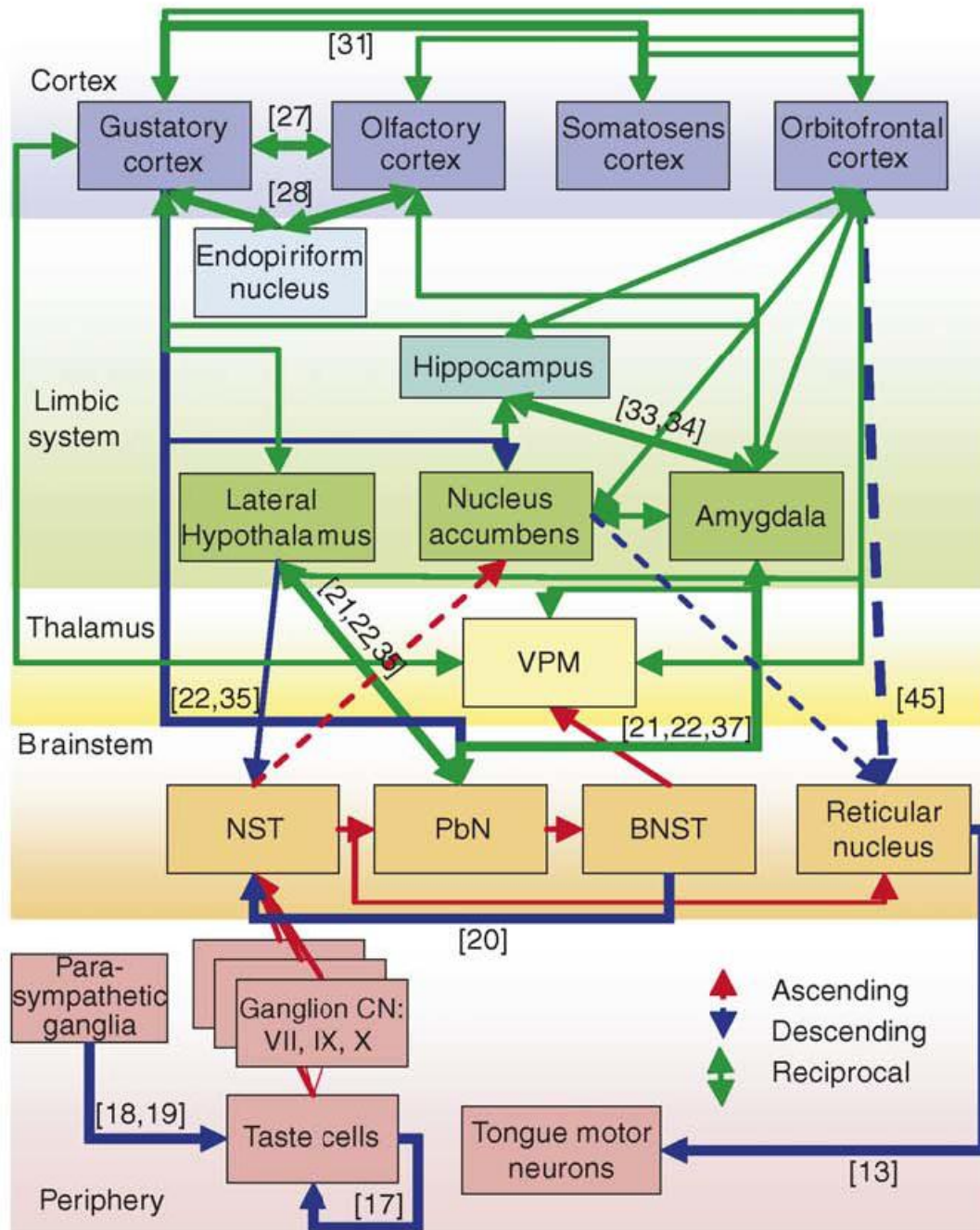

Illustrations were copied and lecture was prepared from:

Noback CH.R. et al: The Human Nervous System: Structure and Function. Humana Press, Totowa, New Jersey, Sixth ed.

Neuroscience Online, the Open-Access Neuroscience Electronic Textbook

[Department of Neurobiology and Anatomy](#)
[University of Texas Medical School at Houston](#)