

Buňka

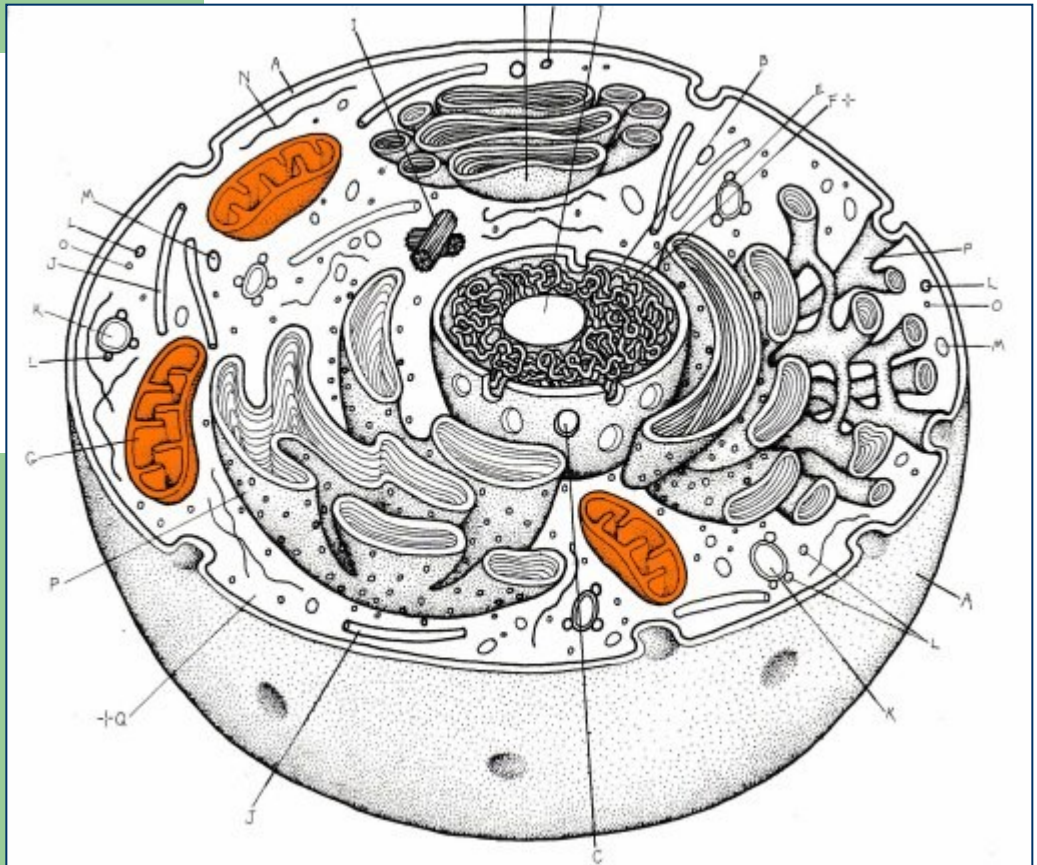

Základní funkční a morfologická jednotka mnohobuněčného organismu, schopná samostatné existence in vitro za vhodných podmínek

Stavba buňky

Buněčná membrána

BUŇKA

Protoplazma

cytoplazma

jádro

cytosol
organely
cytoskelet
inkluze

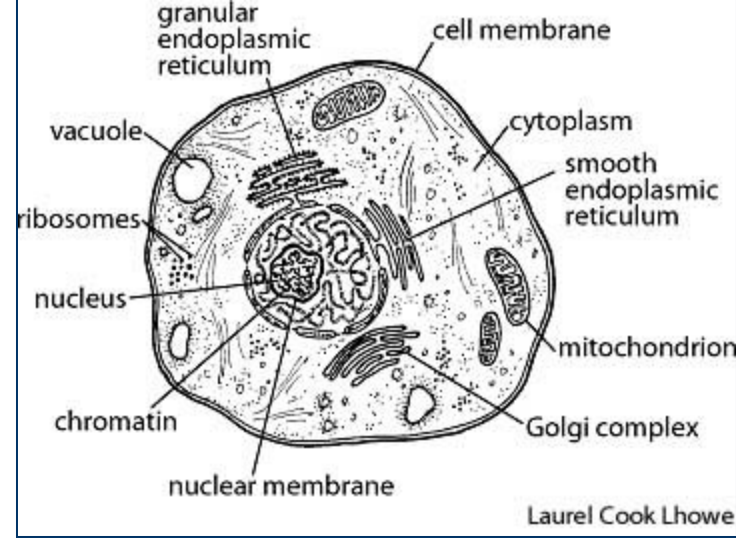

Přednáška: cytologie 2

- Buněčné organely
- Buněčné inkluze

- Povrch buňky
- Mezibuněčná spojení

Buněčné organely

- **jsou konstantní součásti cytoplazmy**
- **mají specifickou strukturu**
- **vyžadují přísun energie k vykonávání svých funkcí**

Buněčné organely

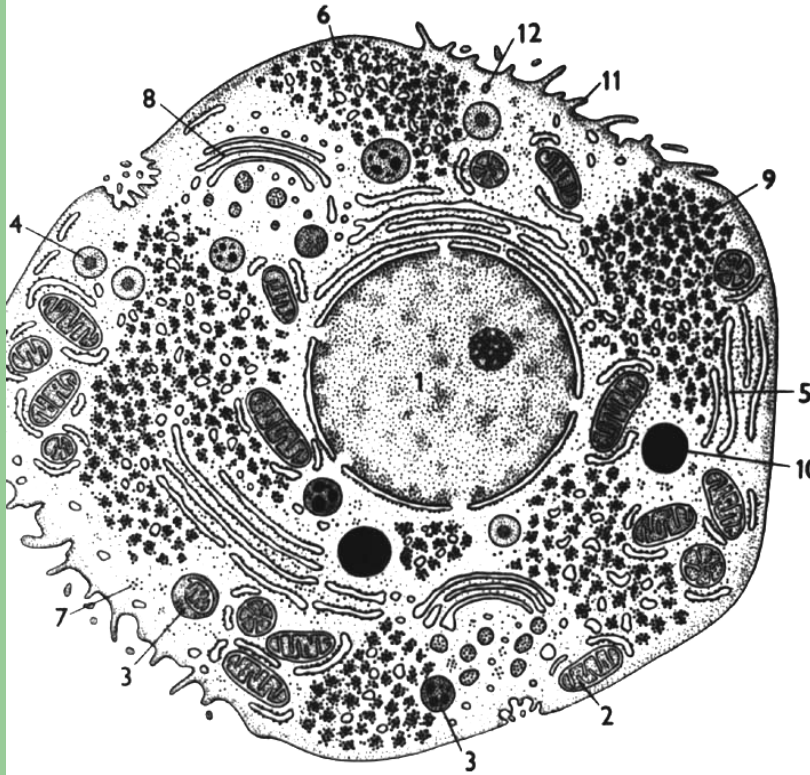

Membránové

- Mitochondrie
- Endoplazmatické retikulum
- Golgiho aparát
- Lyzosomy a endosomy
- Peroxisomy

Bez membrány

- Ribosomy
- Centrioly

Mitochondrie

- Tvar: kulatý, oválný (až vláknitý)
- Velikost: $\varnothing \sim 0,5 \mu\text{m}$, protáhlé 1-10 μm
- Počet: různý dle metabolické aktivity buňky a jejich nároků na dodání energie
(*např. v jaterní buňce 1000 – 2000 mitochondrií*)

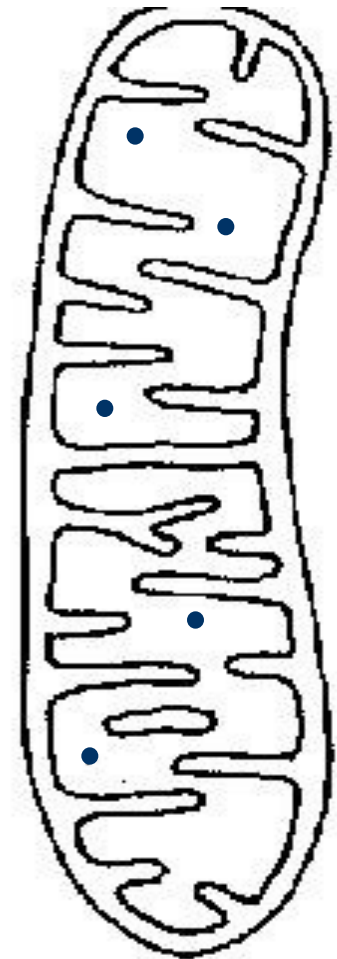

Stavba mitochondrie

Schéma struktury mitochondrie

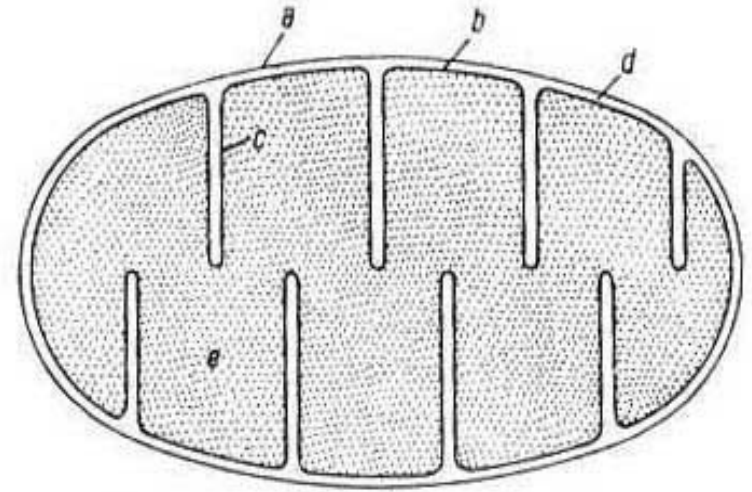

- Vnější membrána (hladká)
- Vnitřní membrána (s kristami)
- Cristae mitochondriales (+ elementární částice)
- Matrix (proteiny, DNA, RNA) – *semiautonomie*
- Mitochondriální tělíska (osmiofilní)
- Mitochondriální ribosomy

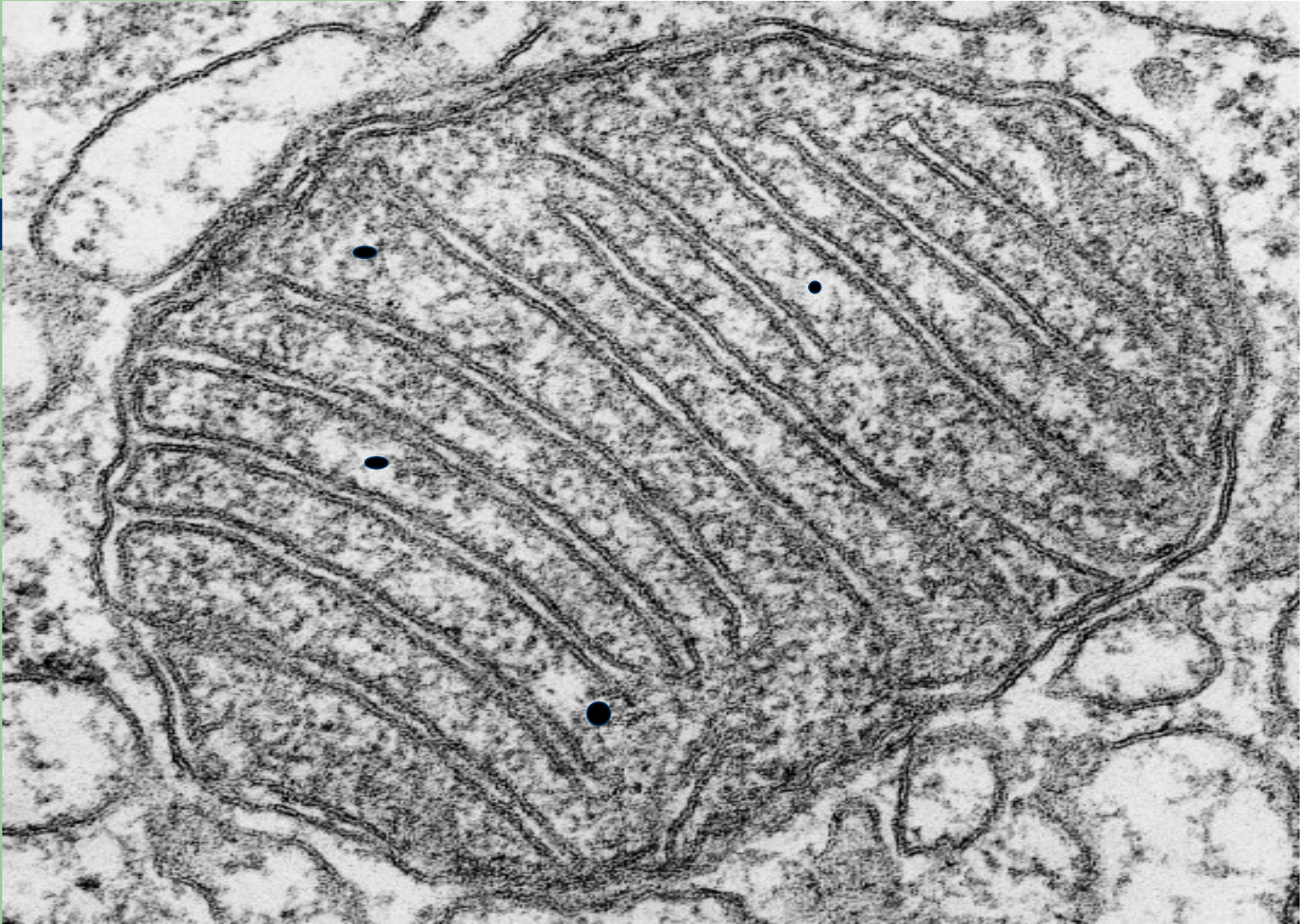

Mitochondriální kristy

hřebenovité kristy



tubulózní kristy

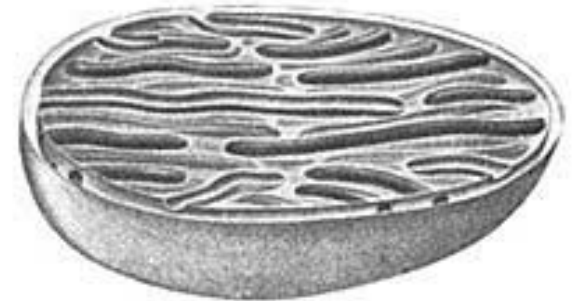

prizmatické
kristy

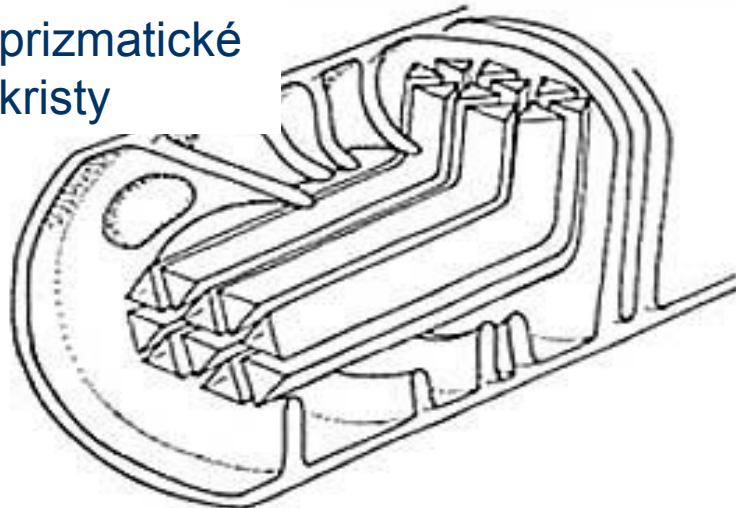

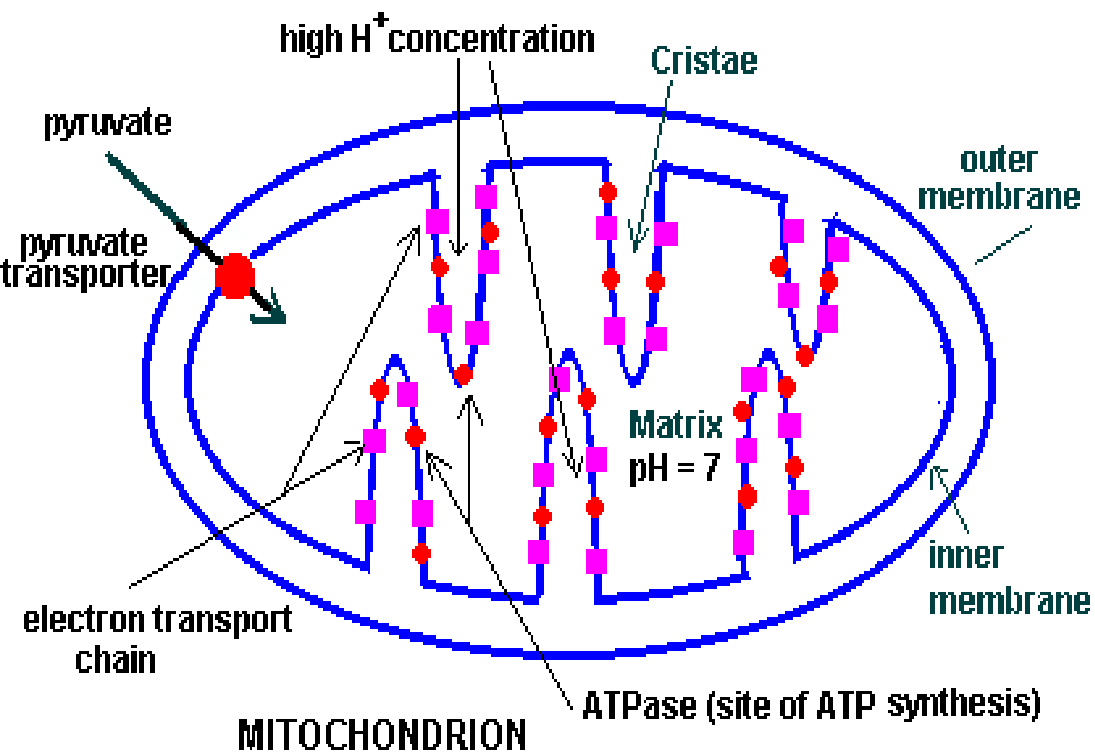

Funkce Mi

V matrix + elementárních částicích:

enzymy Krebsova cyklu,
dýchacího řetězce a oxidativní
fosforylace

Hlavní funkce Mi:

uvolňování energie z ATP

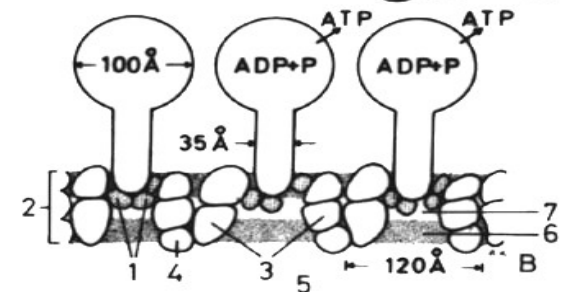
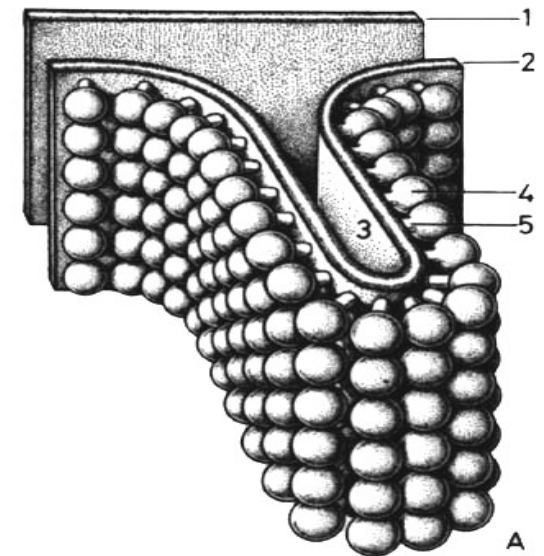

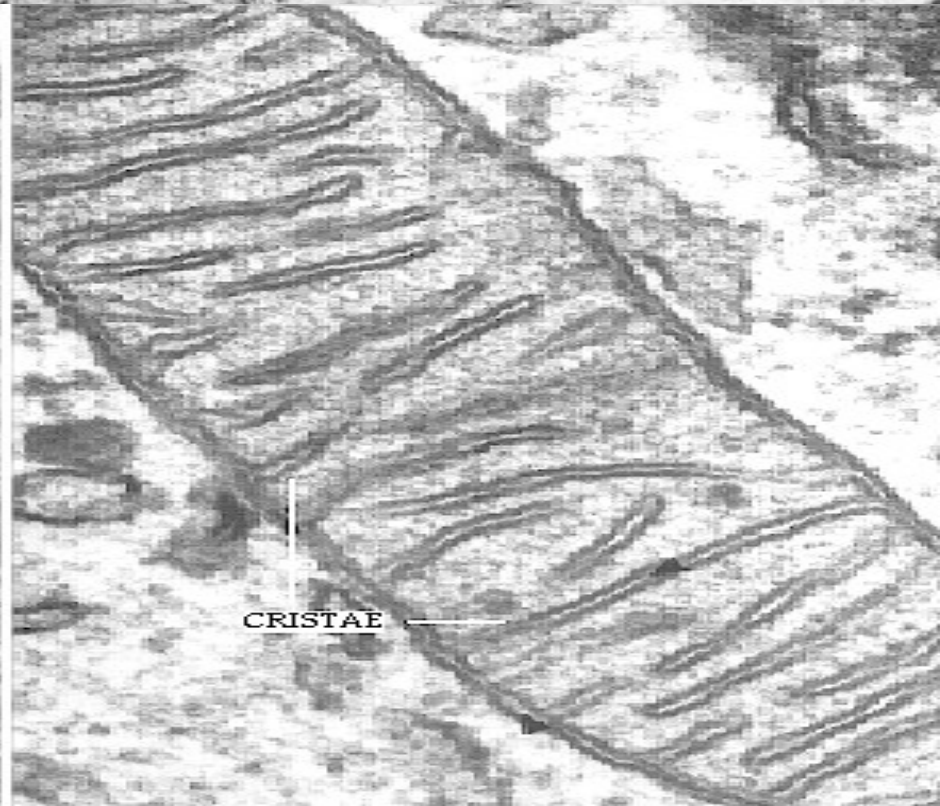
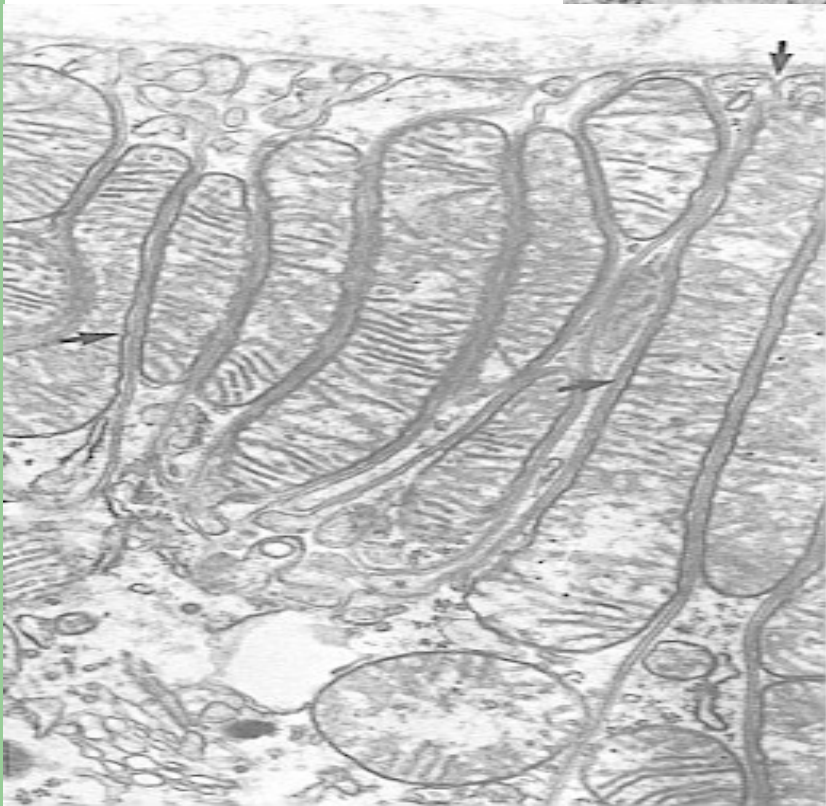
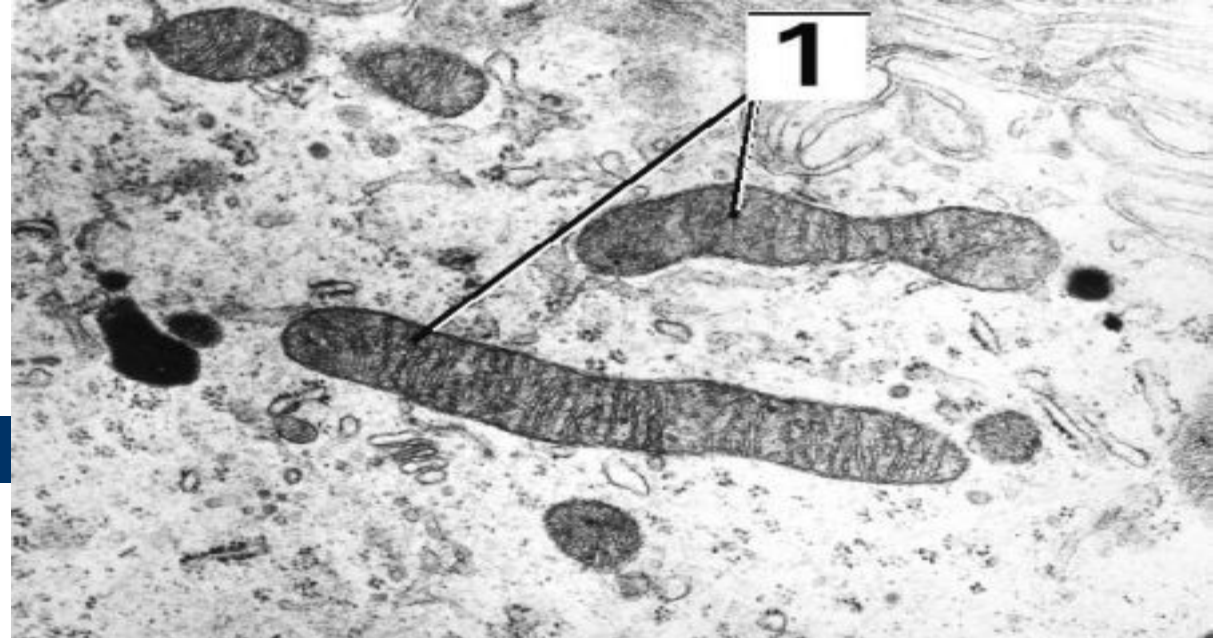
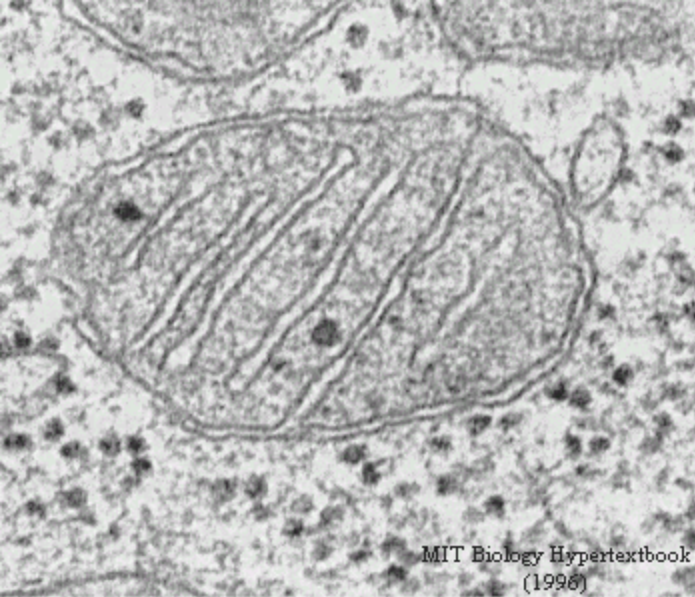

SHELF CRISTAE-MUSCLE

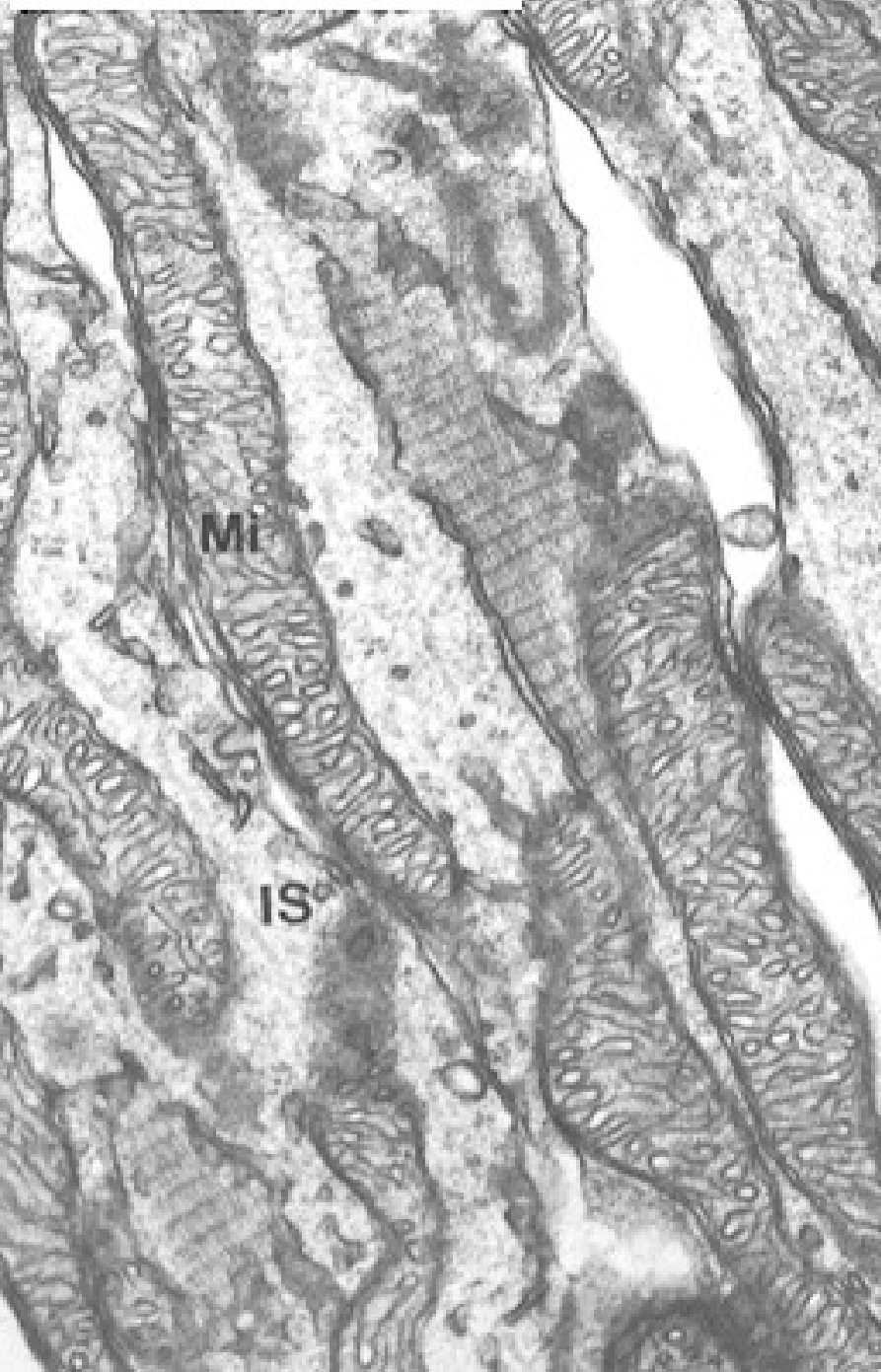

TUBULAR CRISTAE-ADRENAL

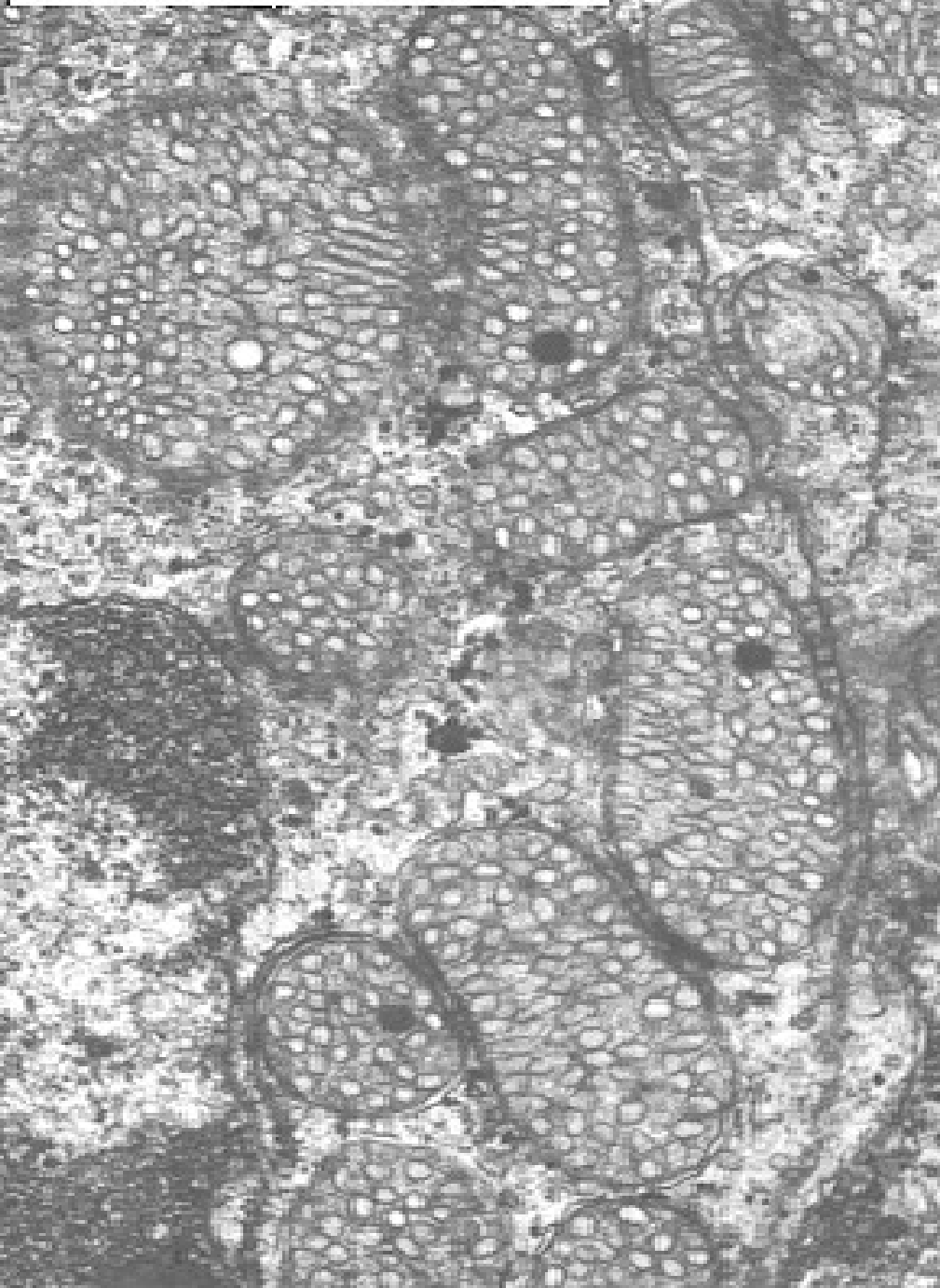

Ribosomy

- Tělísko složené ze 2 podjednotek
- Velikost ribosomu: ~20-25 nm Ø

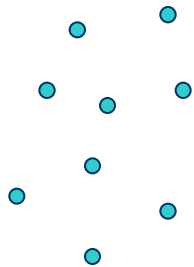

volné
ribosomy

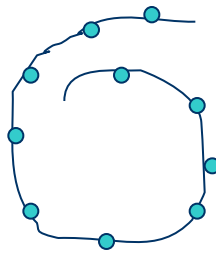

poly(ribo)somy

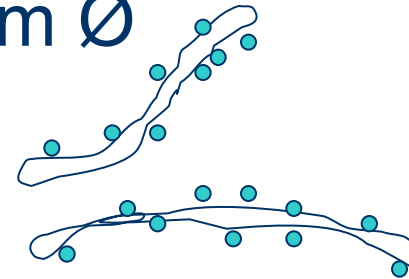

ribosomy na
endoplazmatickém
retikulu

Proteosyntéza „pro buňku“ a „na export“ (např. žlázové bb.)

Ribosom

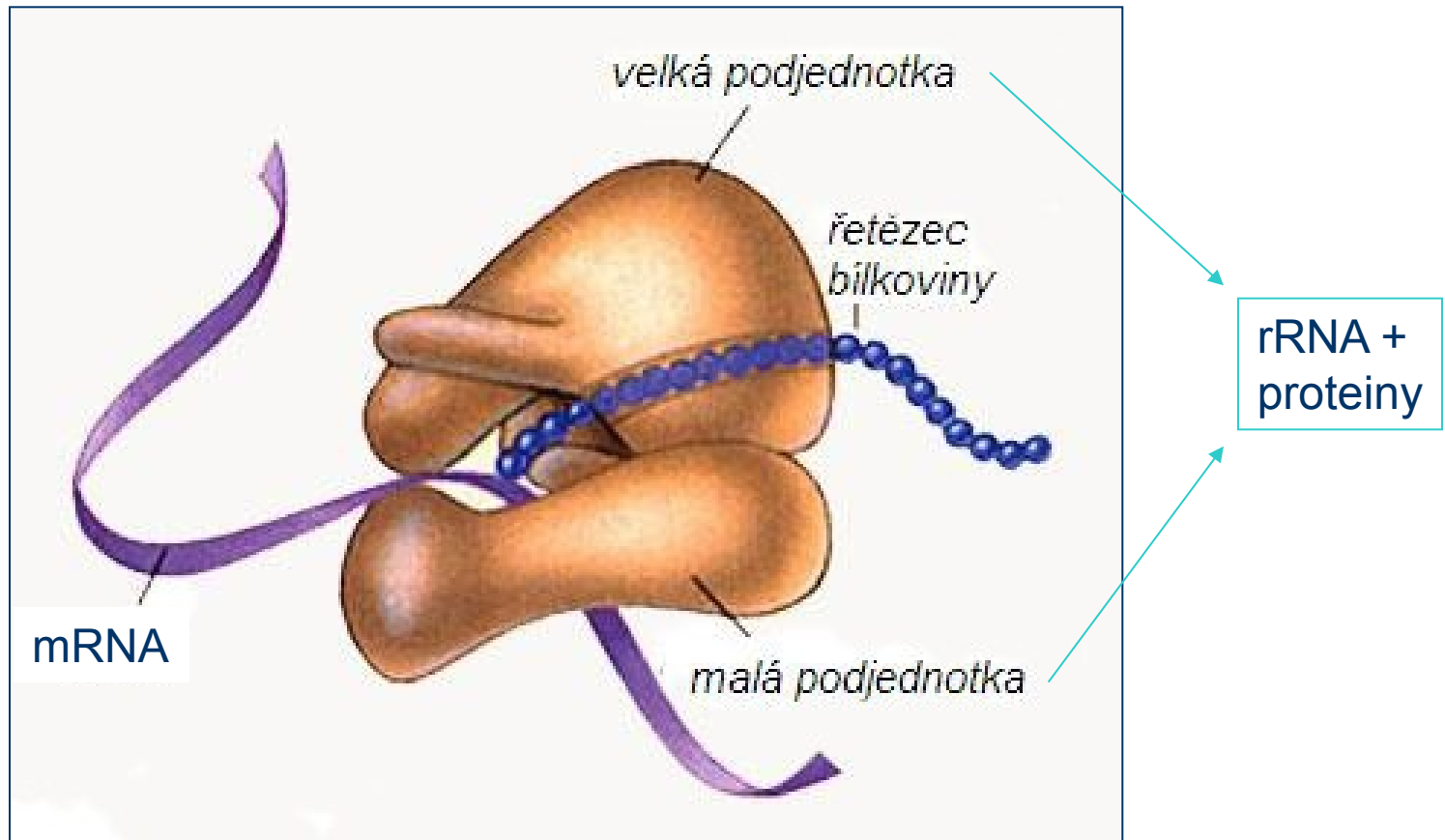
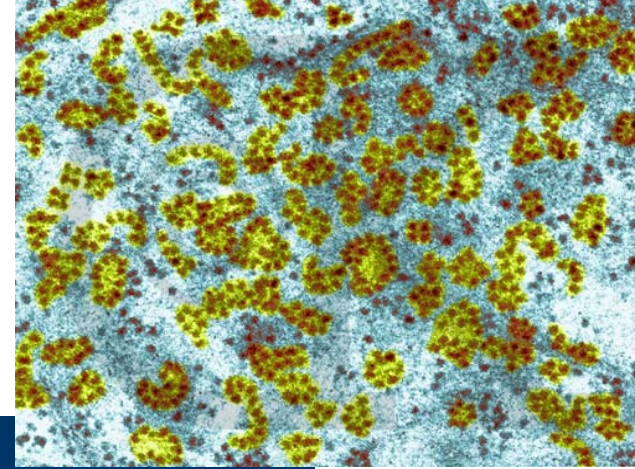

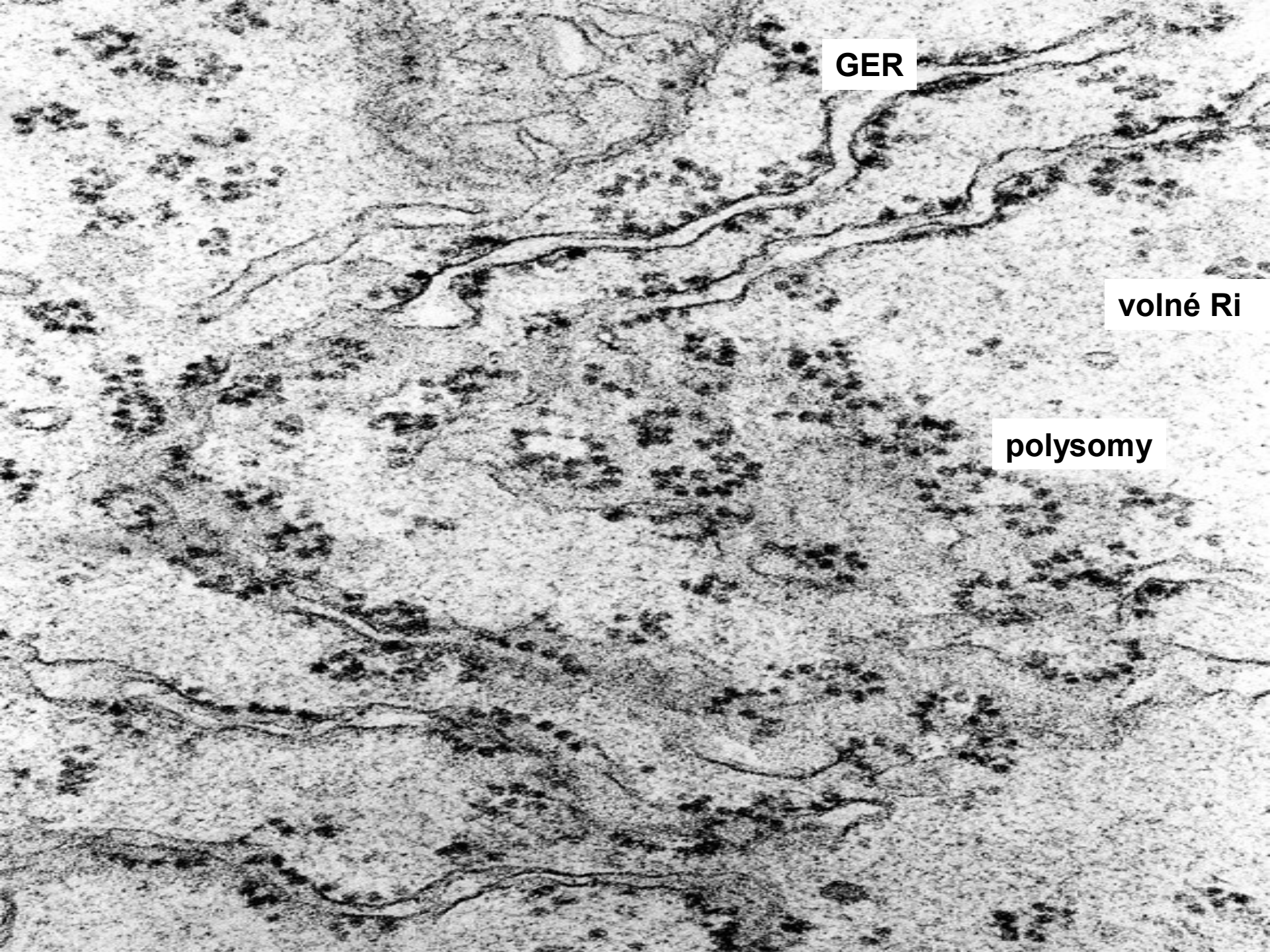

GER

volné Ri

polysomy

Endoplazmatické retikulum

členitý, 3D systém membrán
v cytoplazmě buňky – 2 formy:

- Zrnité (granulární) ER – GER:
systém plochých, anastomozujících cisteren +
(poly)ribosomy reverzibilně vázané
na membránu

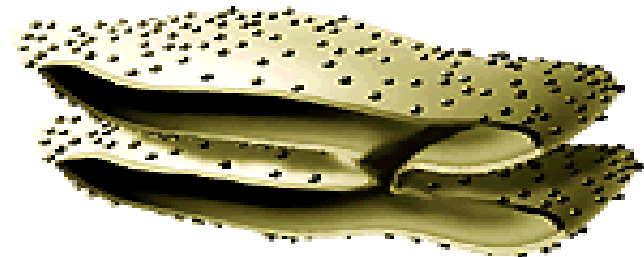

- Hladké (agranulární) ER – AER:
systém tubulů a váčků
s membránou bez ribosomů

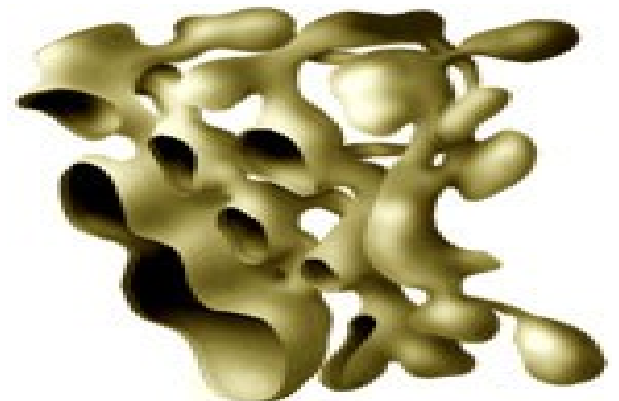

Komunikace GER s perinukleárním prostorem jaderného obalu

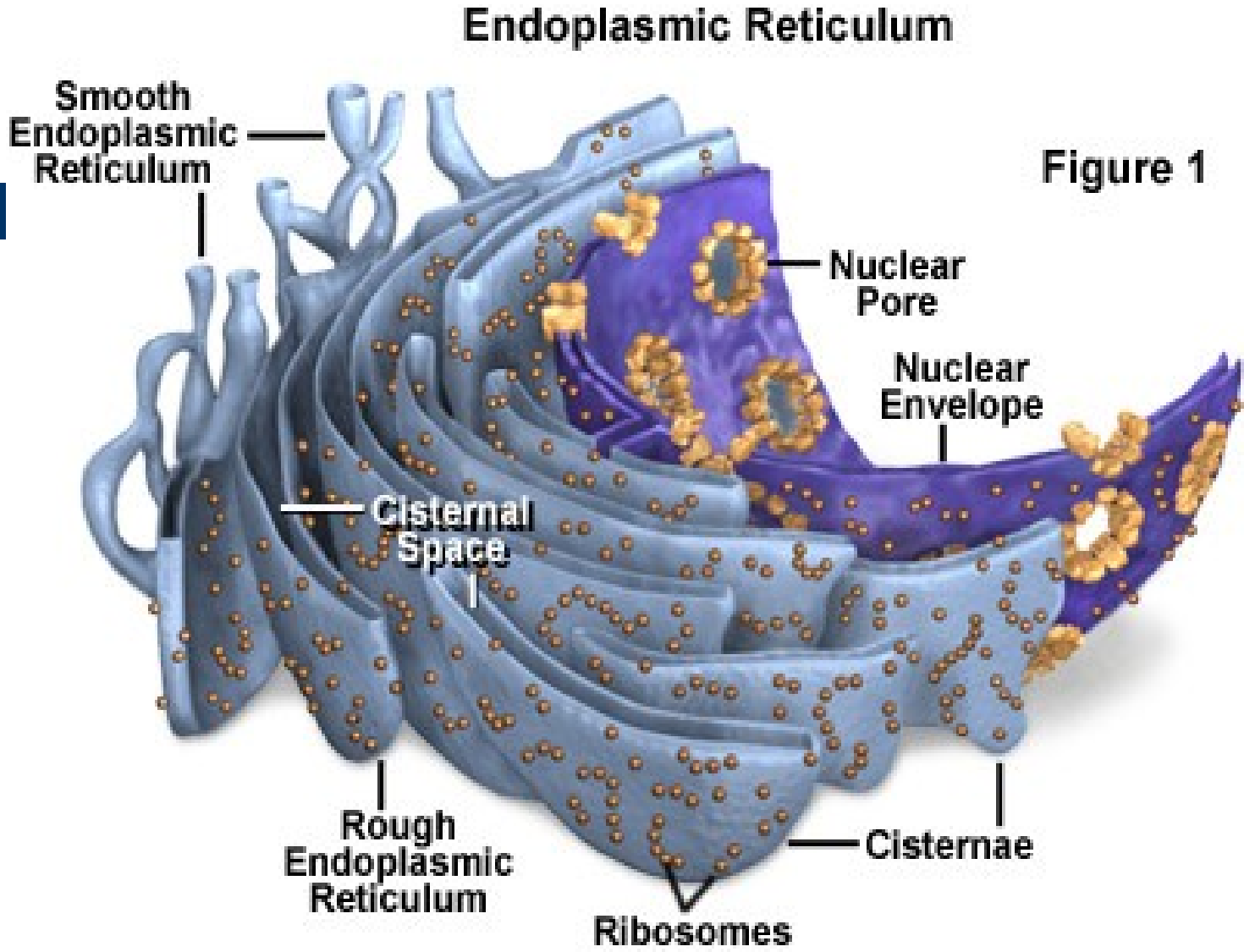
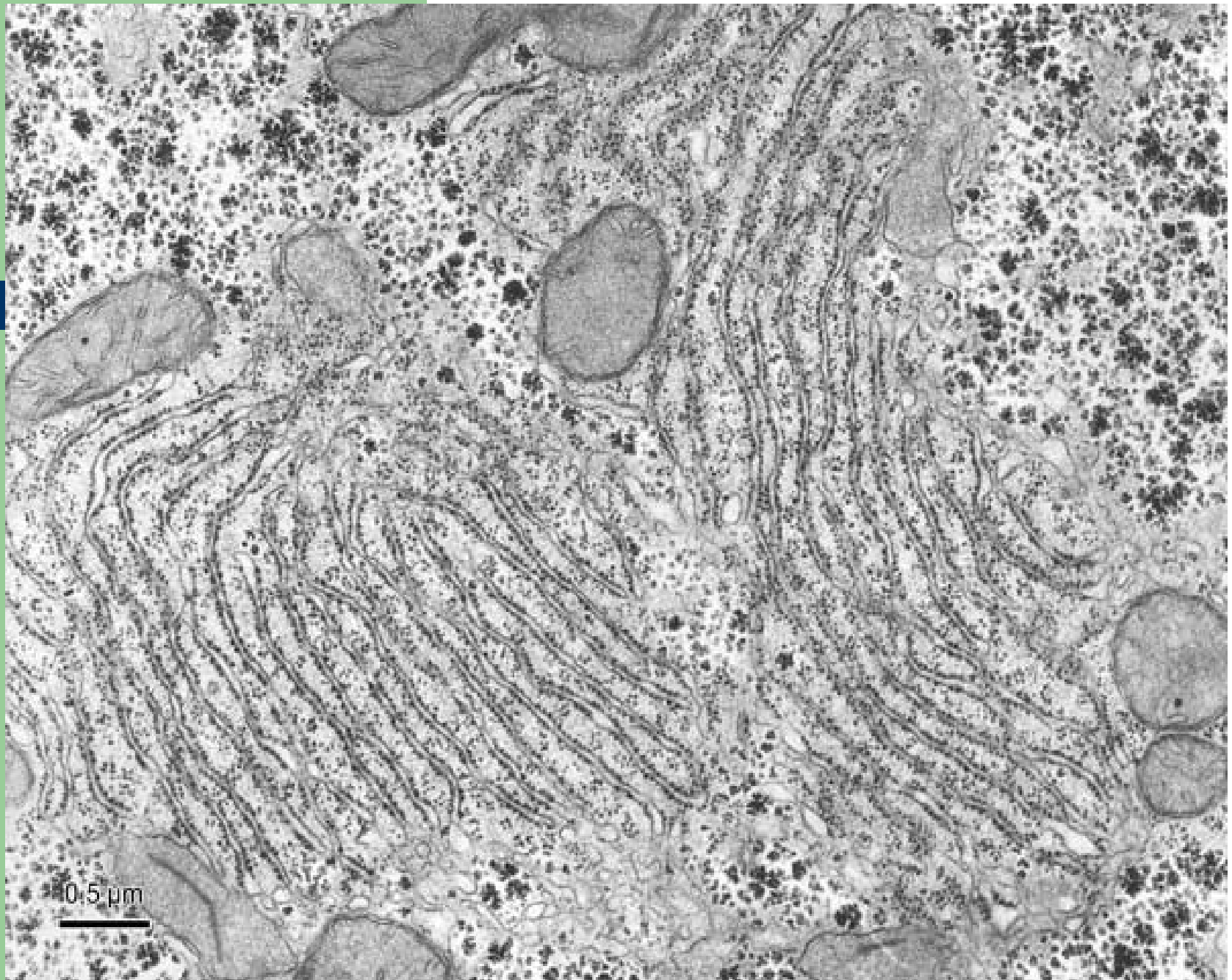
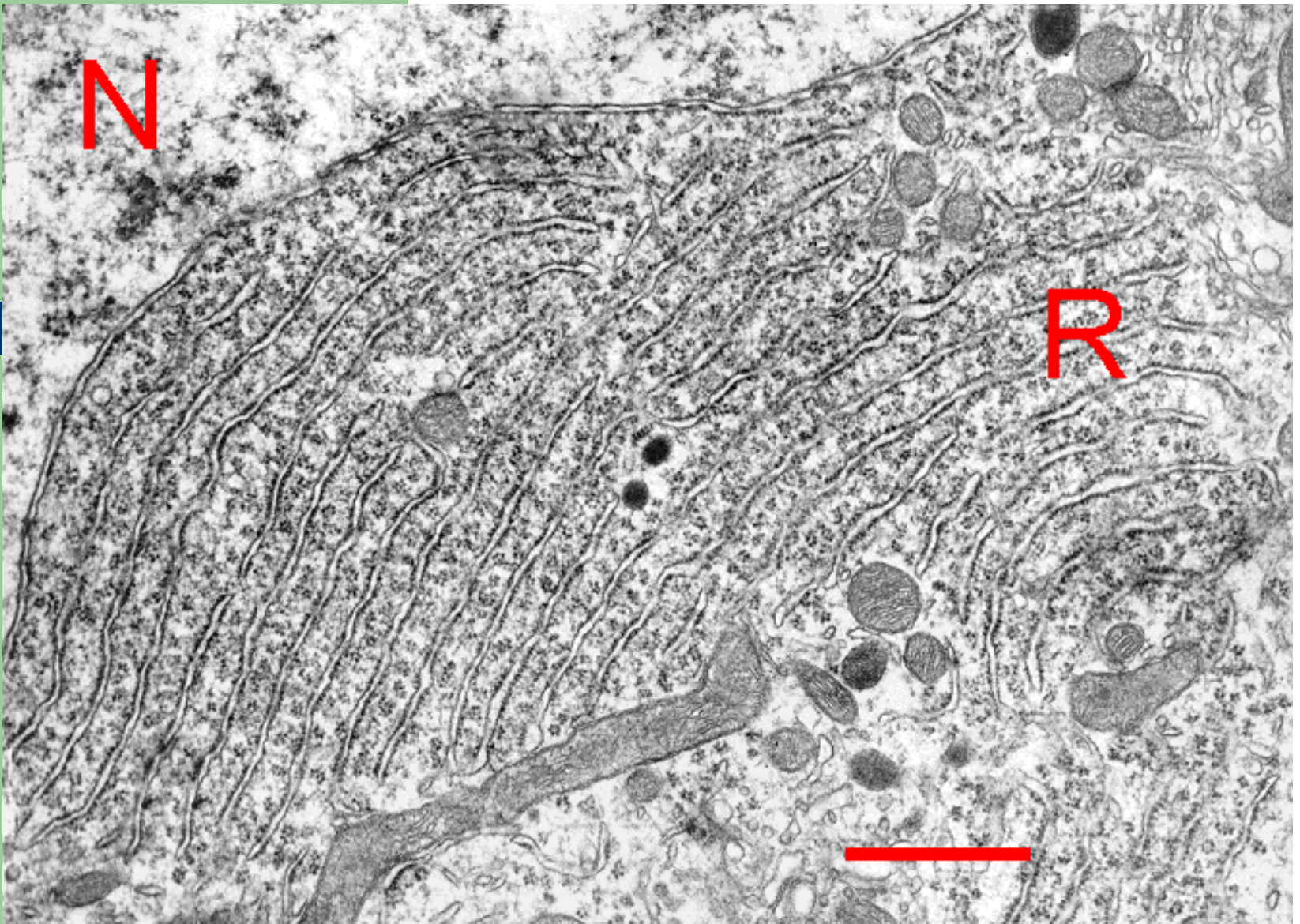

Figure 1





Granular endoplasmic reticulum (R) organized into parallel cisternae forming the *tigroid* (Nissl) substance. N - nucleus of the Purkinje cell. Scale = 1 μm . (Rabbit, cerebellar cortex.)

GER

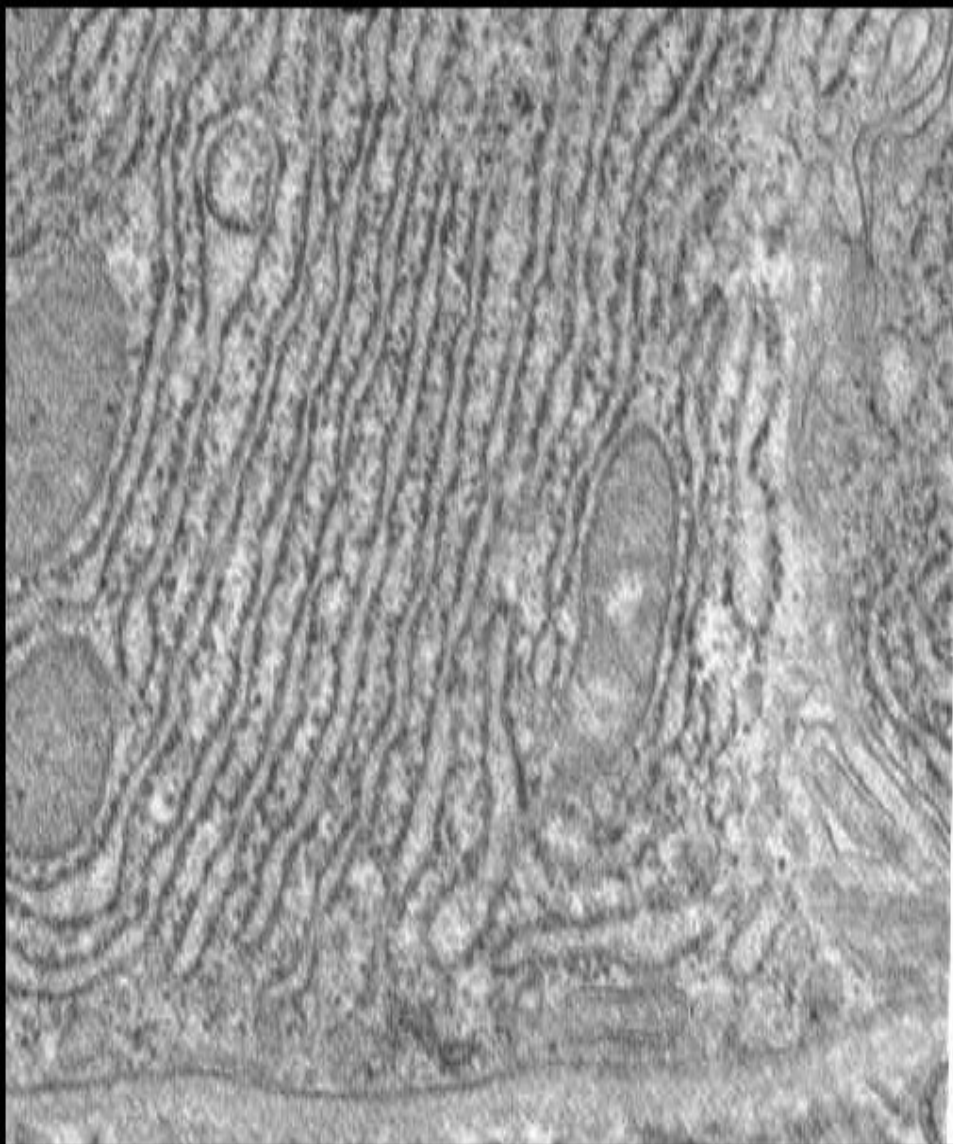

AER

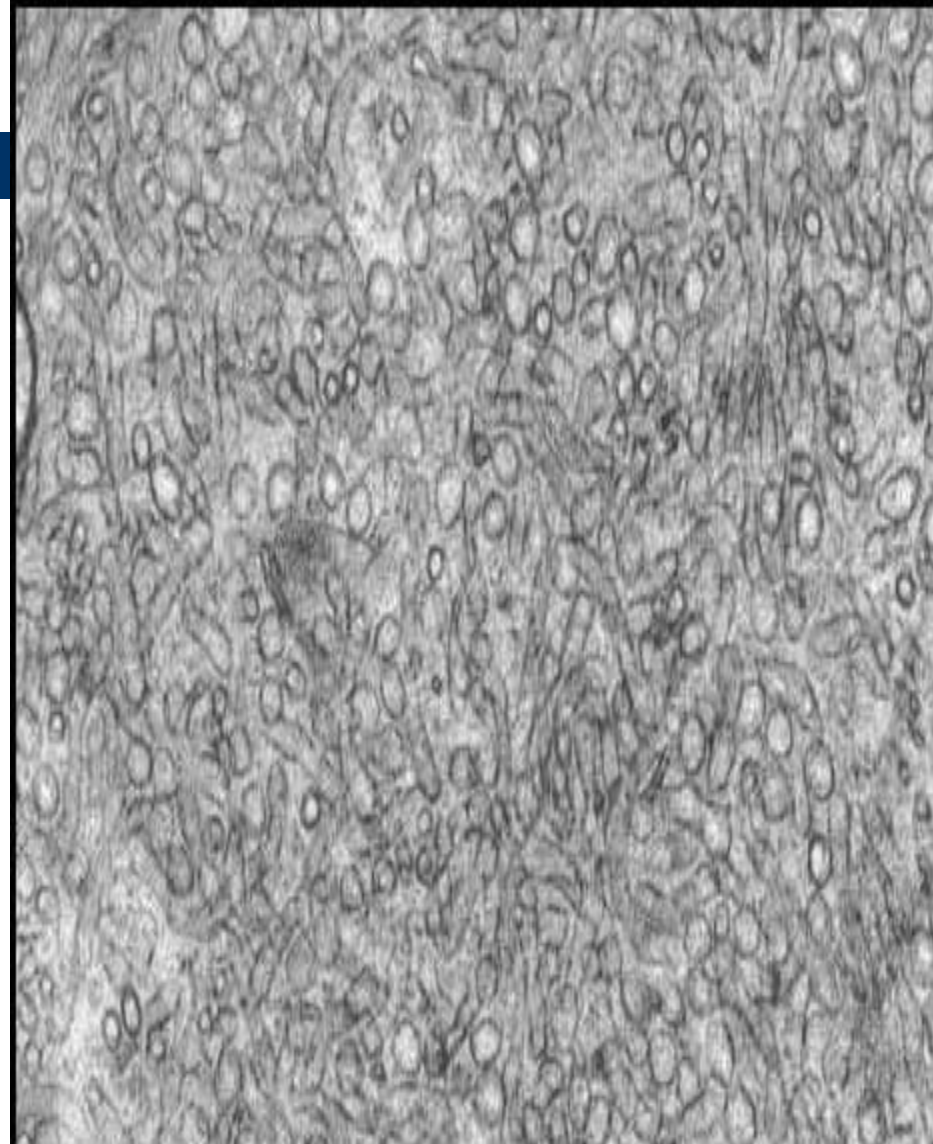

Funkce GER

- GER – proteosyntéza (Ri) a transport proteinů do GA (transportními váčky)
- v kooperaci s GA:
 - intracelulární skladování (např. v lyzosomech a specifických granulích leukocytů)
 - dočasné intracelulární skladování určené pro následný transport mimo buňku (sekreční zrna)

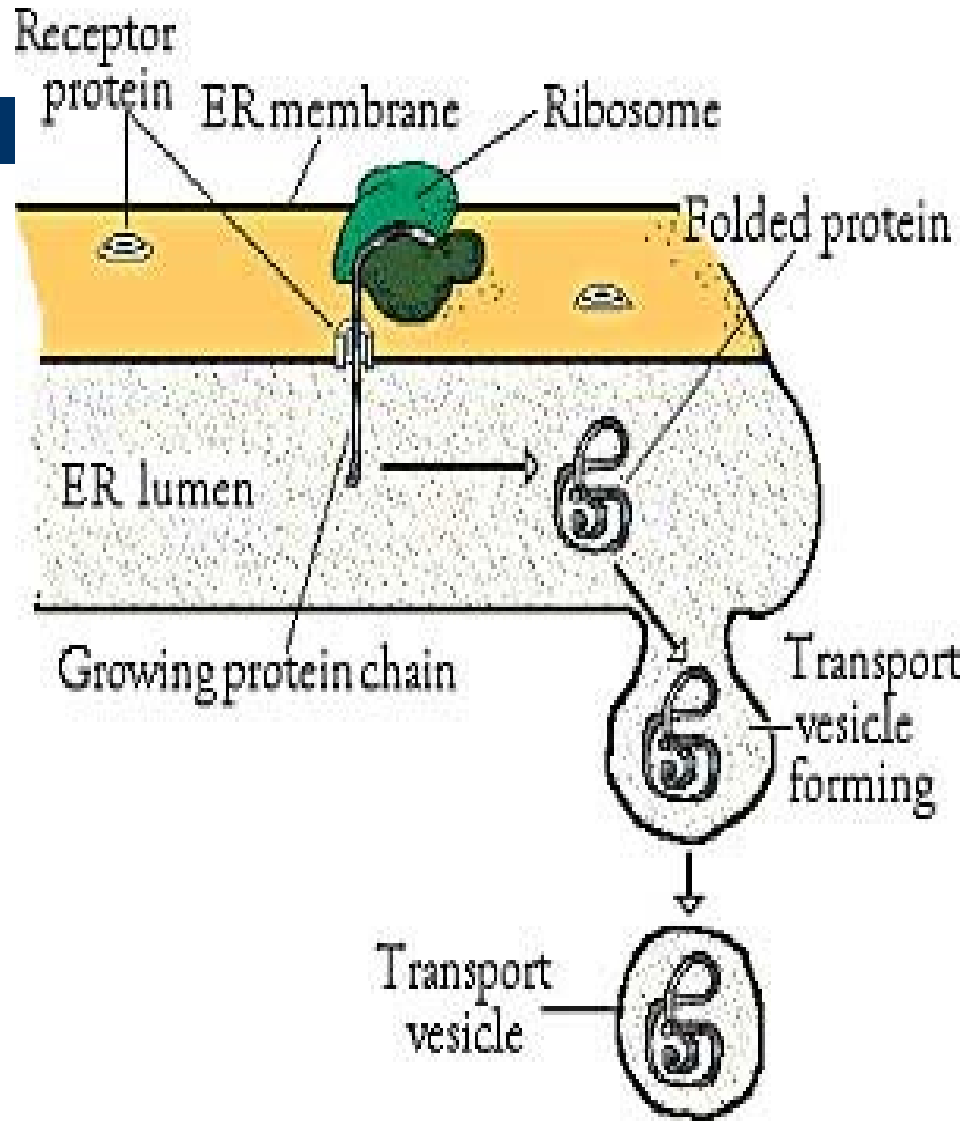

Funkce AER

- AER – v buňkách:
 - syntetizujících **steroidy** (bb. kůry nadledvin, Leydigovy buňky varlete, bb. žlutého tělíska)
 - odbourávajících **glykogen** (jaterní buňky)
 - syntetizujících **HCl** (krycí buňky žaludečních žláz)
 - svalových (jako tzv. sarkoplazmatické retikulum, které obsahuje **Ca ionty**)
 - podílí se na tvorbě membrán

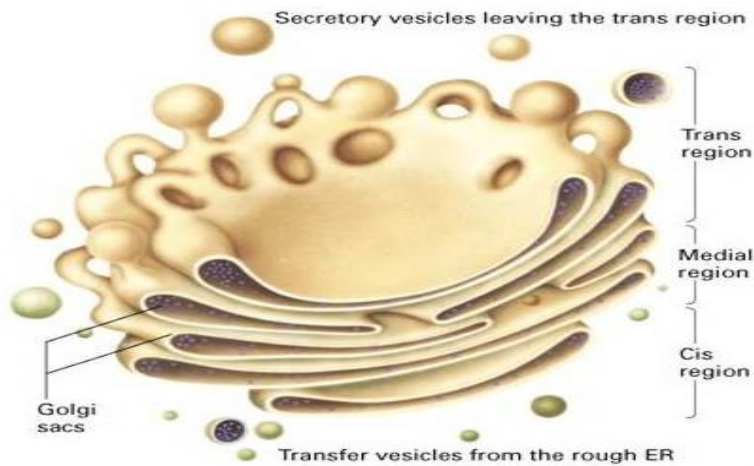

Golgiho aparát (GA)

- Systém hladkých membrán, ohraničujících:

1. cisterny (3-10)
(*dictyosom*)
2. vesikuly
3. vakuoly

Polarita GA: cis
trans

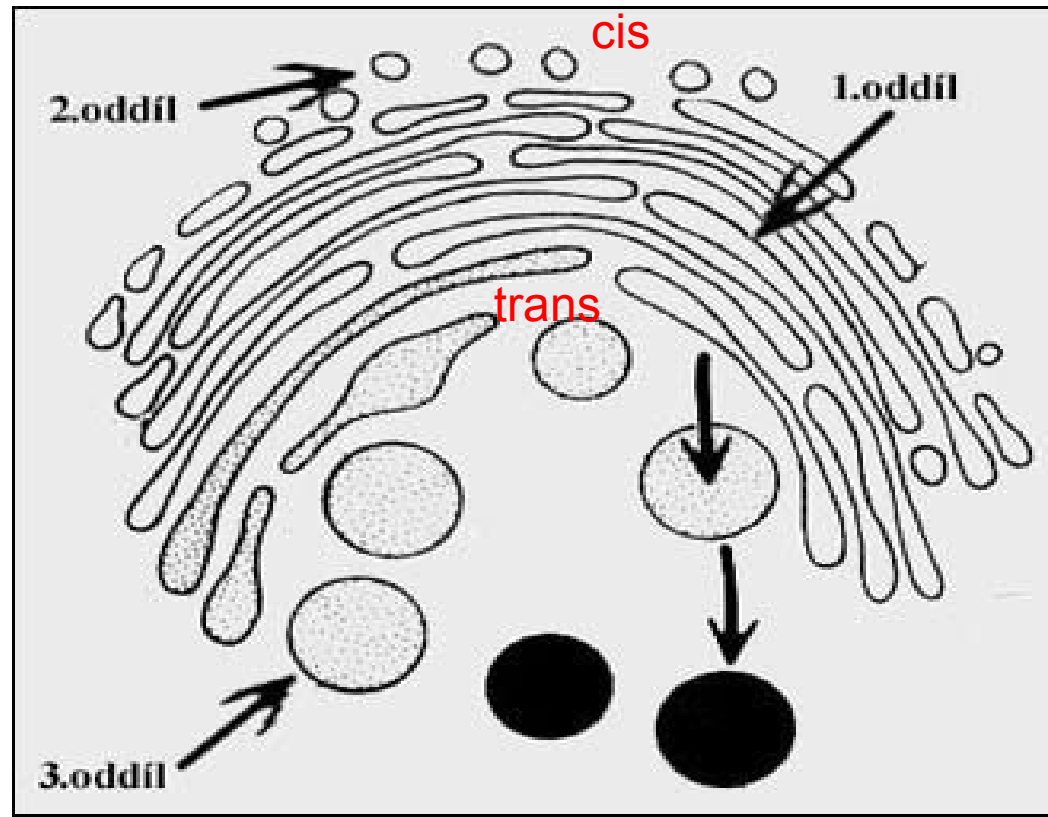

The Golgi Apparatus

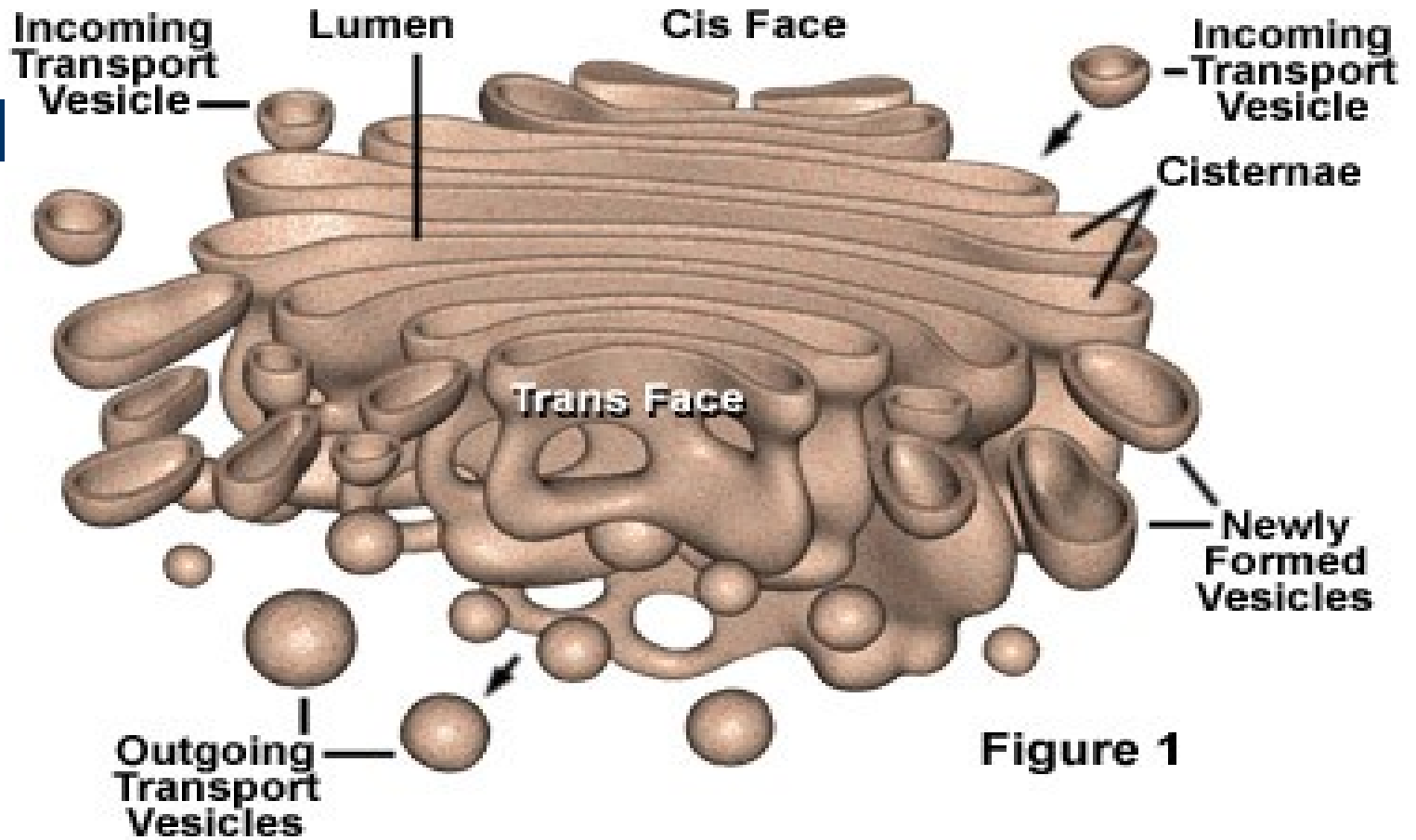
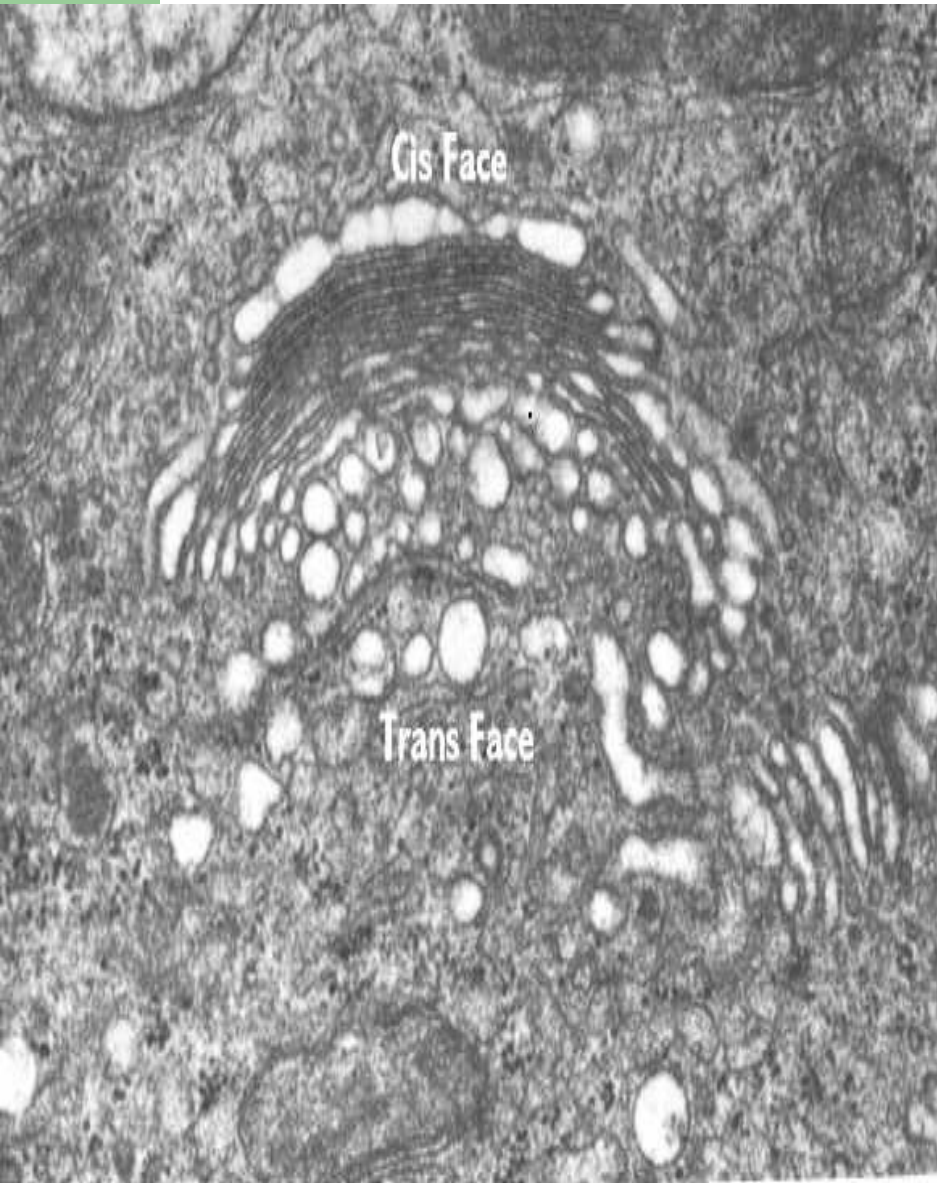

Figure 1

Funkční polarita GA



Transport proteinů z GER:

transportními váčky

Strana konvexní – cis face
(produkční /forming face/)

Strana konkávní – trans face
(maturační /maturing face/)

kondenzační vakuoly

sekreční zrna

lyzosomy

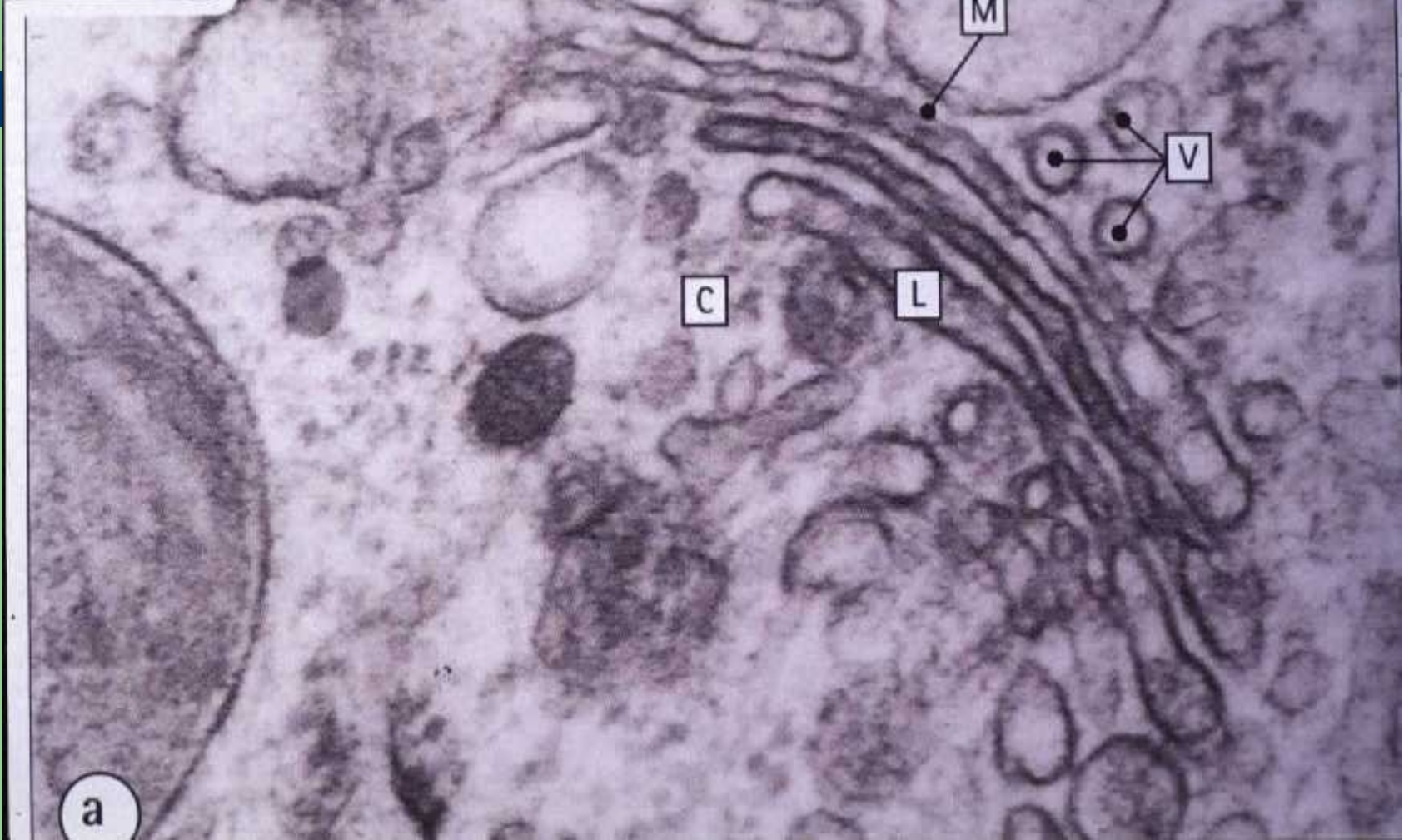

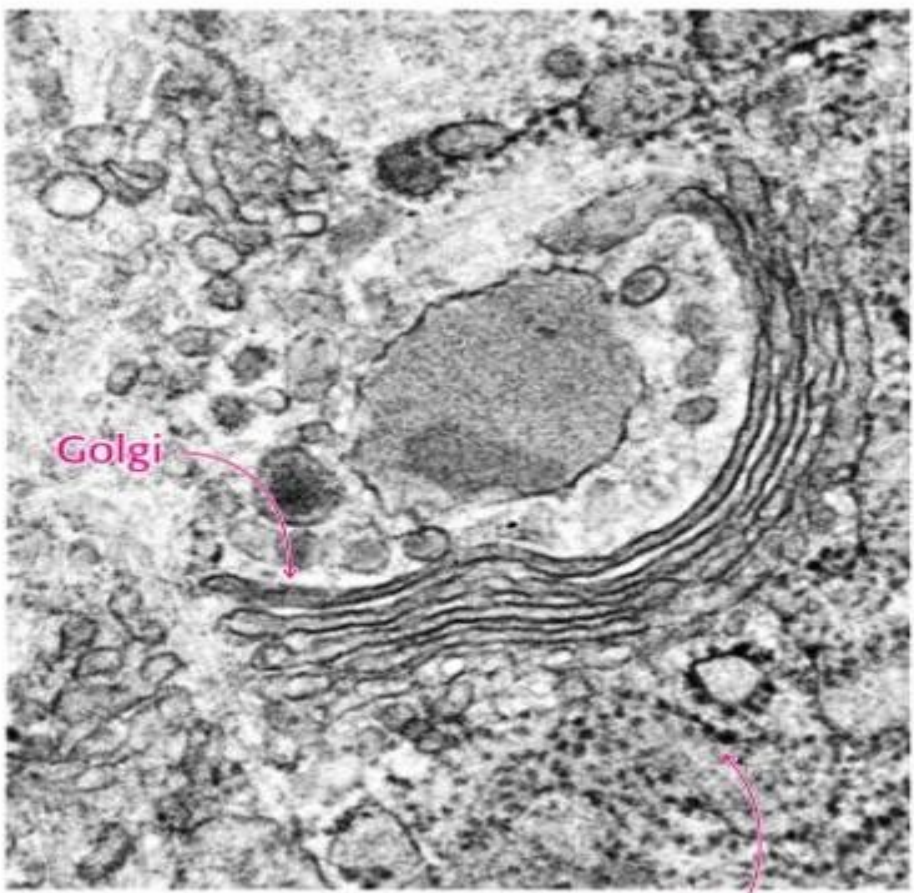

Golgi

Endoplasmic reticulum

Golgiho pole

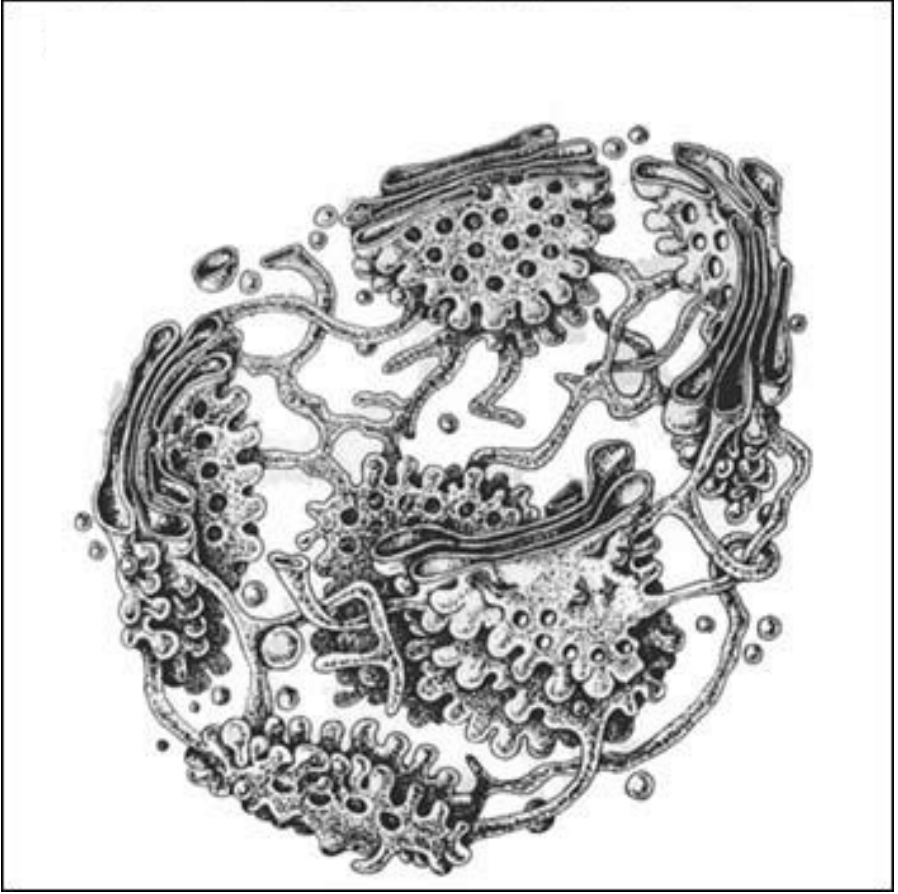

Extracellular space

rough
endoplasmic
reticulum

Membrane
retrieval

Constitutive
secretory
pathway

Cis
Golgi

Trans-
Golgi

Regulated secretory
pathway

Lysosome

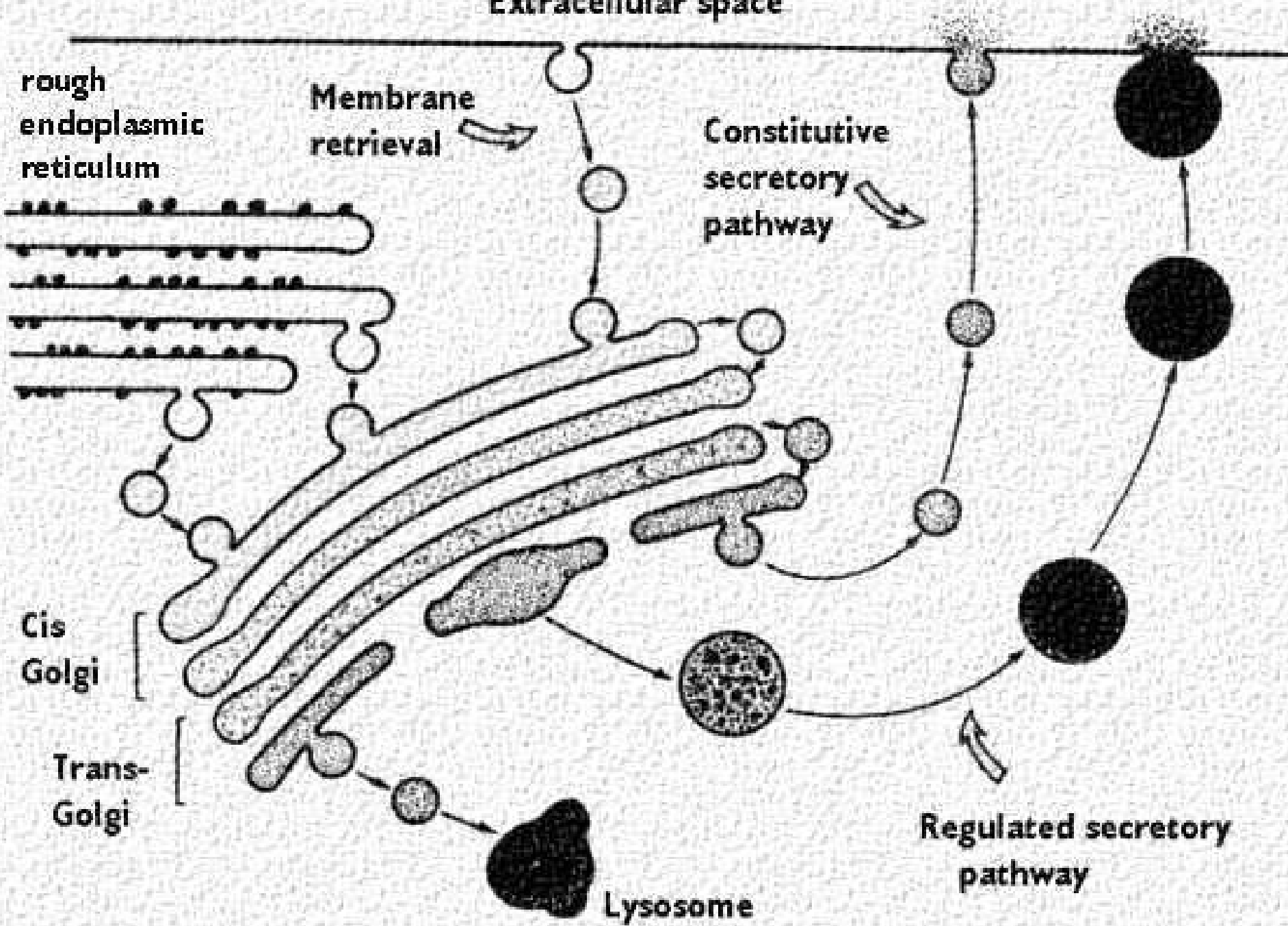

Funkce GA

- postsyntetická úprava a maturace proteinů (glykosylace, sulfatace, fosforylace),
- kondenzace a skladování sekrečních produktů
⇒ kondenzační vakuoly, sekreční granula,
- vznik akrozomálního váčku při přeměně spermatidy ve spermii,
- donor membrán (pro některé orgány).

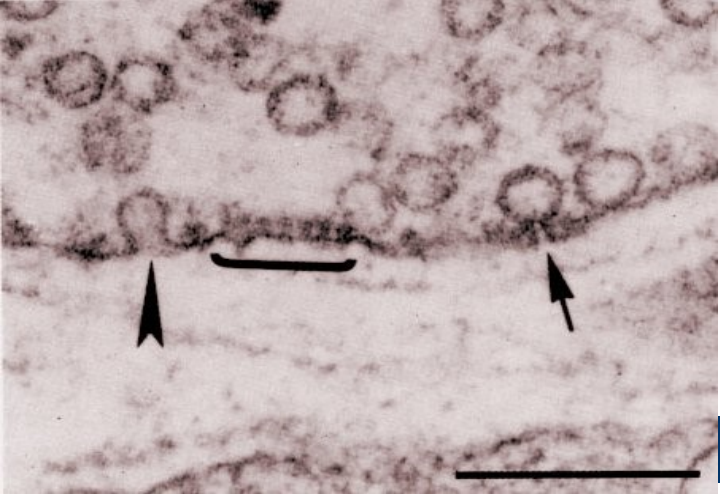

Lyzosomy a endosomy

- Endosomy: membránové váčky (Ø 20-150 nm) vstup do buňky – pinocytózou,



osud v buňce → transcytóza
→ fúze s Ly ⇒ sekundární Ly

Lyzosomy

- Váčky – od $0,5 \mu\text{m}$ \emptyset , jednoduchá membrána, matrix s hydrolytickými enzymy kyselého pH (kys. fosfatáza, karboxylesterhydrolázy, katepsiny, hyaluronidáza, nespecifická esteráza, lipáza, ribonukleáza, kolagenáza aj.)

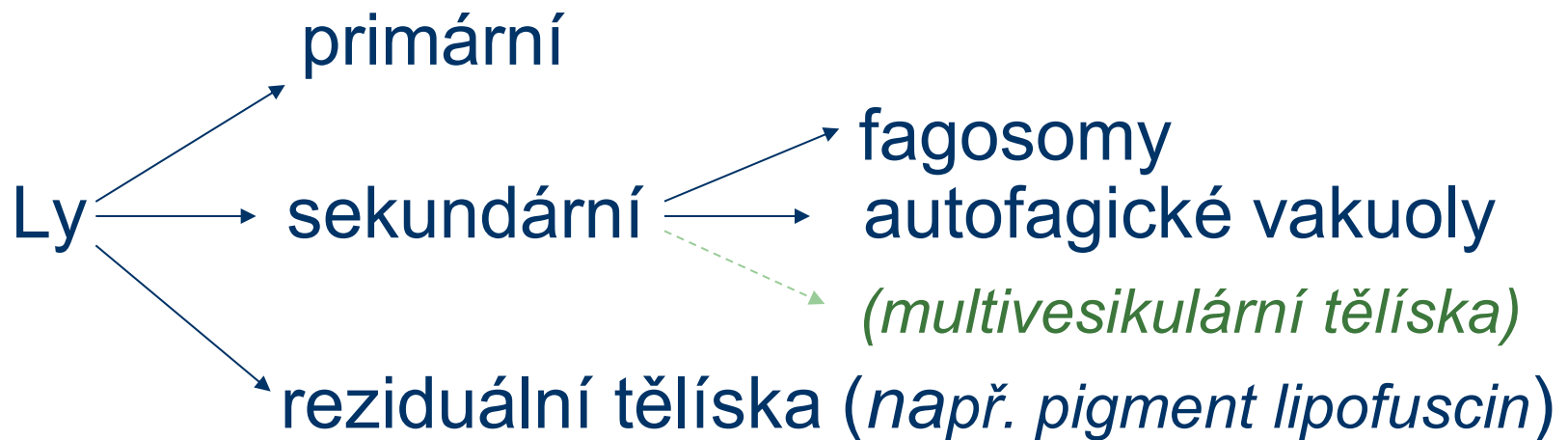

Lyzosomy

primární Ly ($0,5 \mu m$)

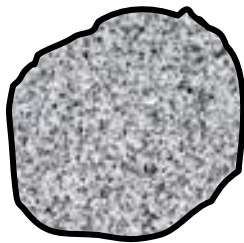

sekundární Ly

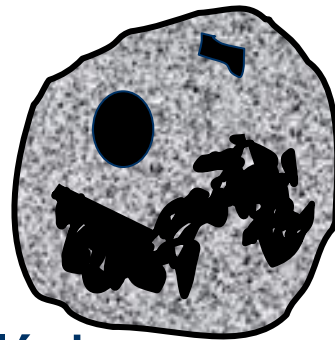

autofagická vakuola

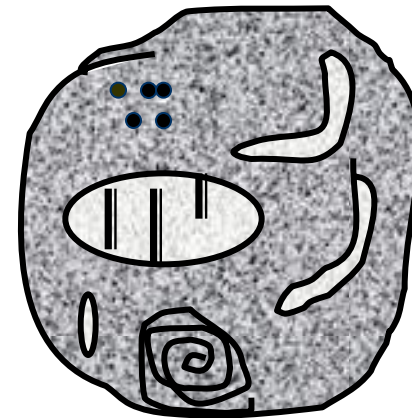

reziduální tělísko

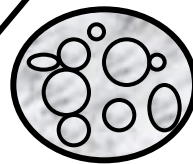
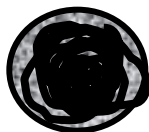

multives. tělísko

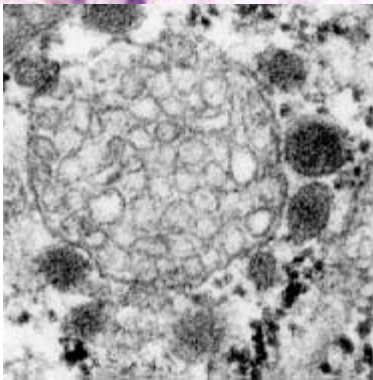
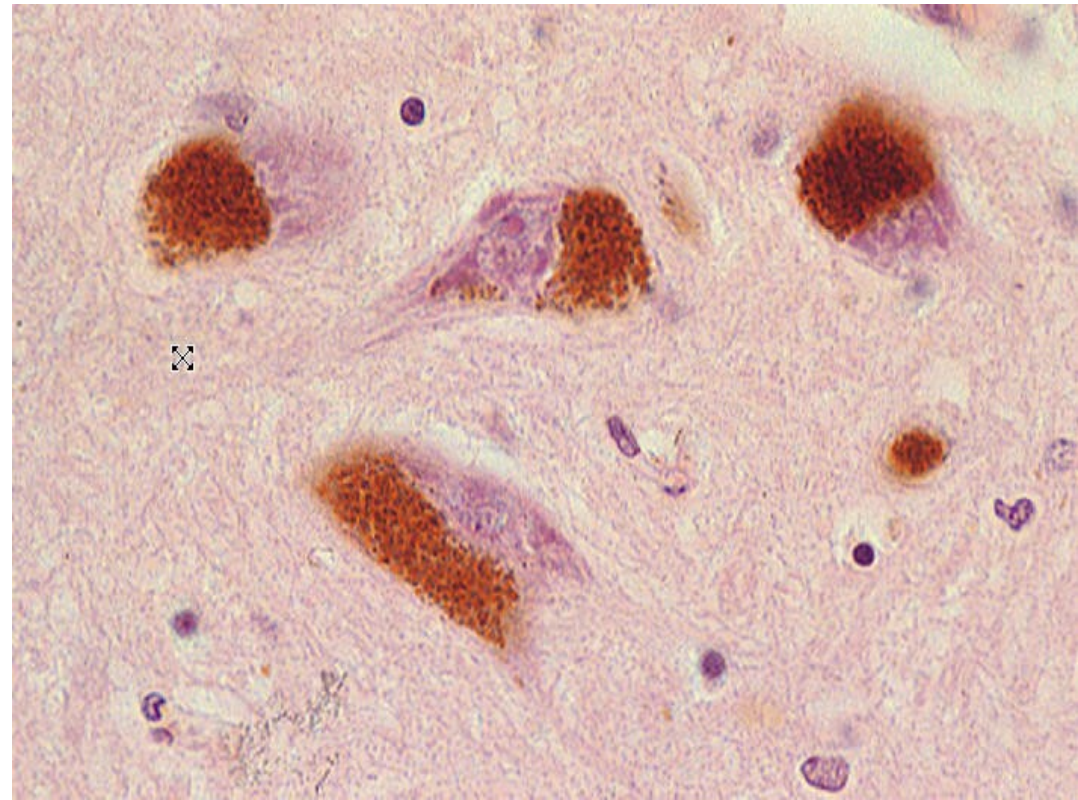
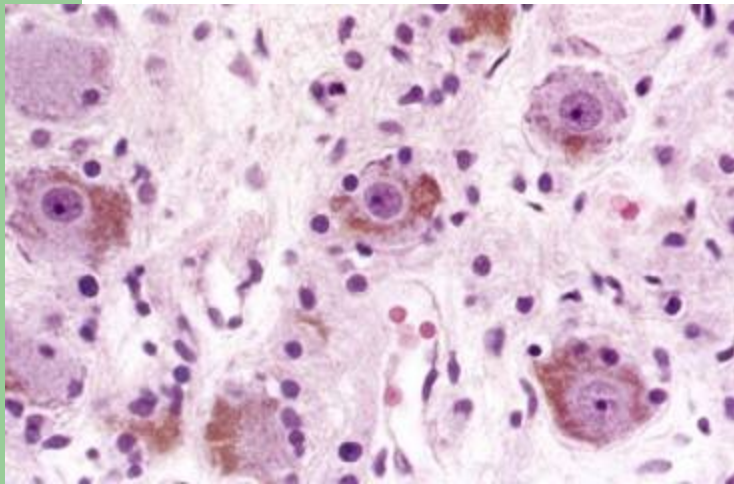
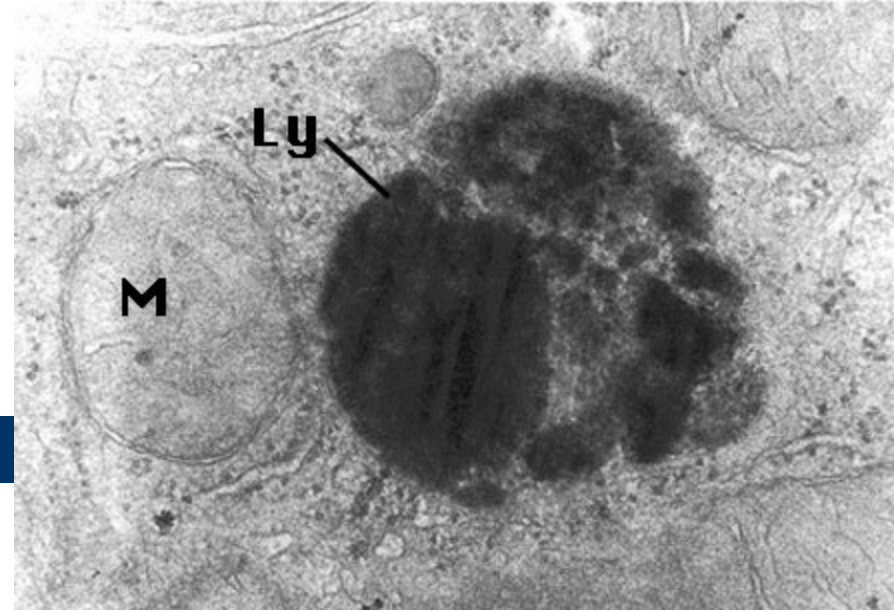
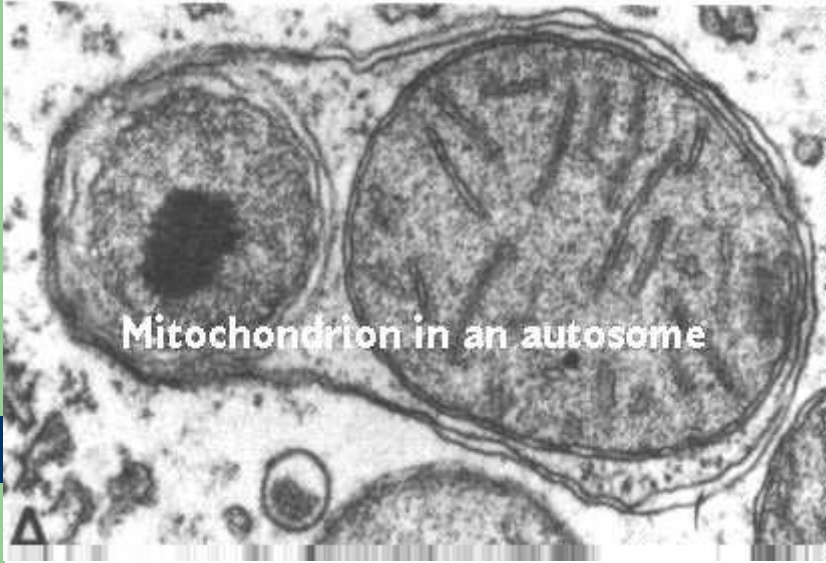

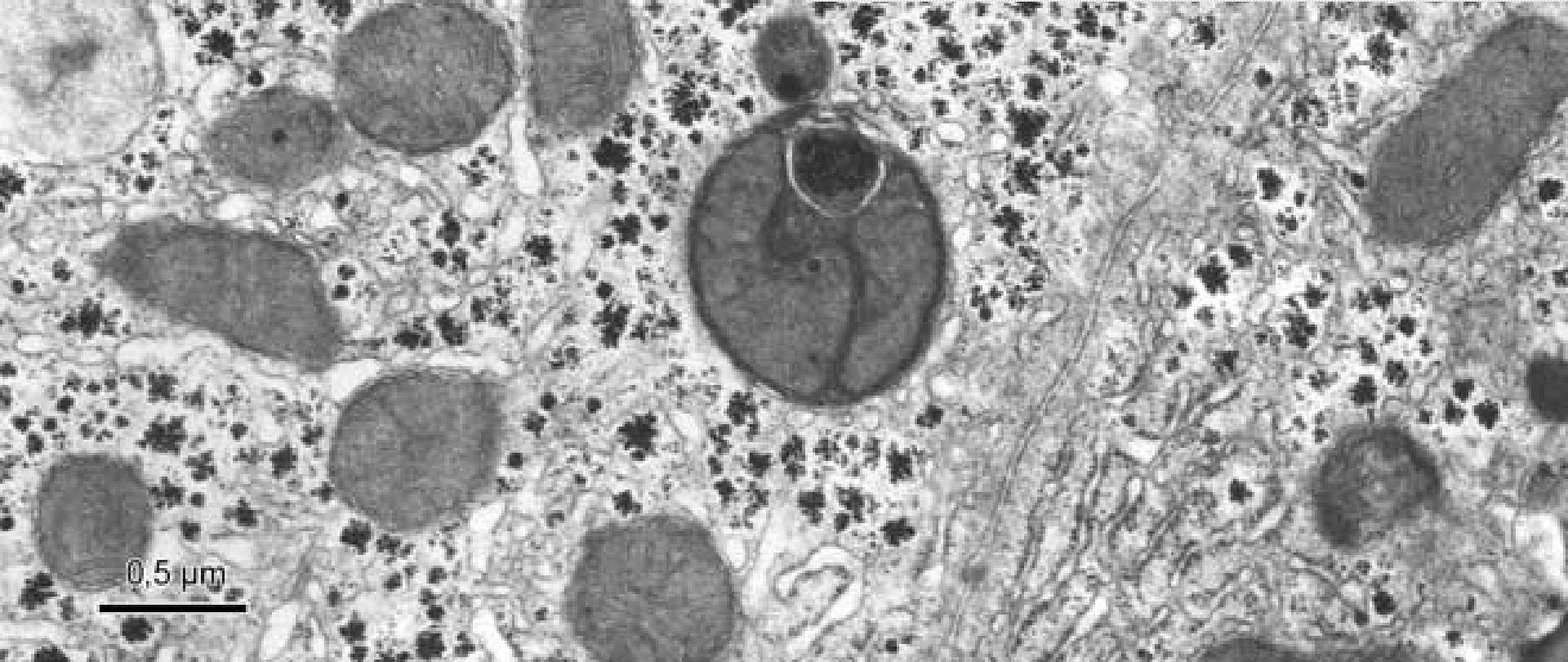
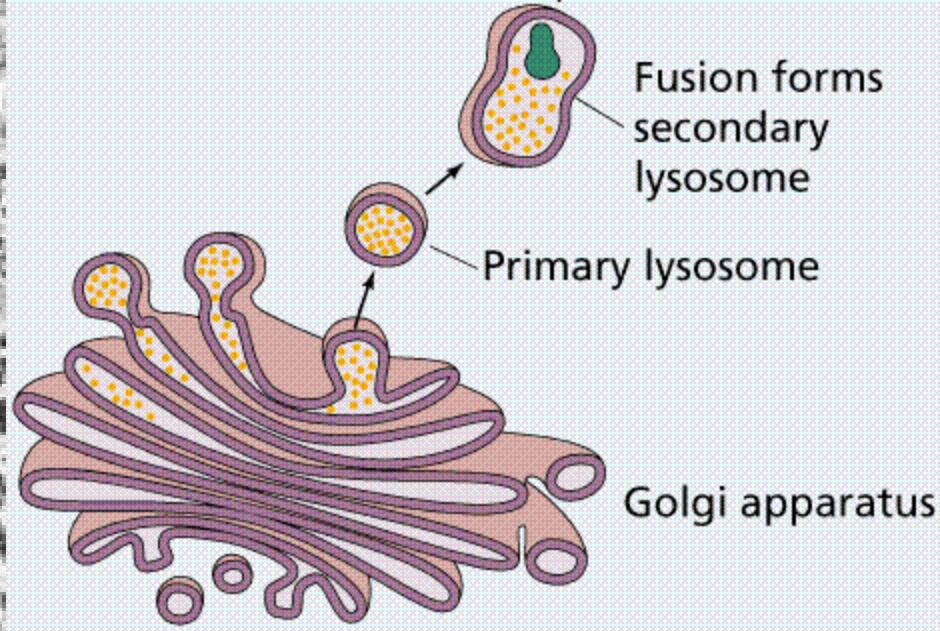
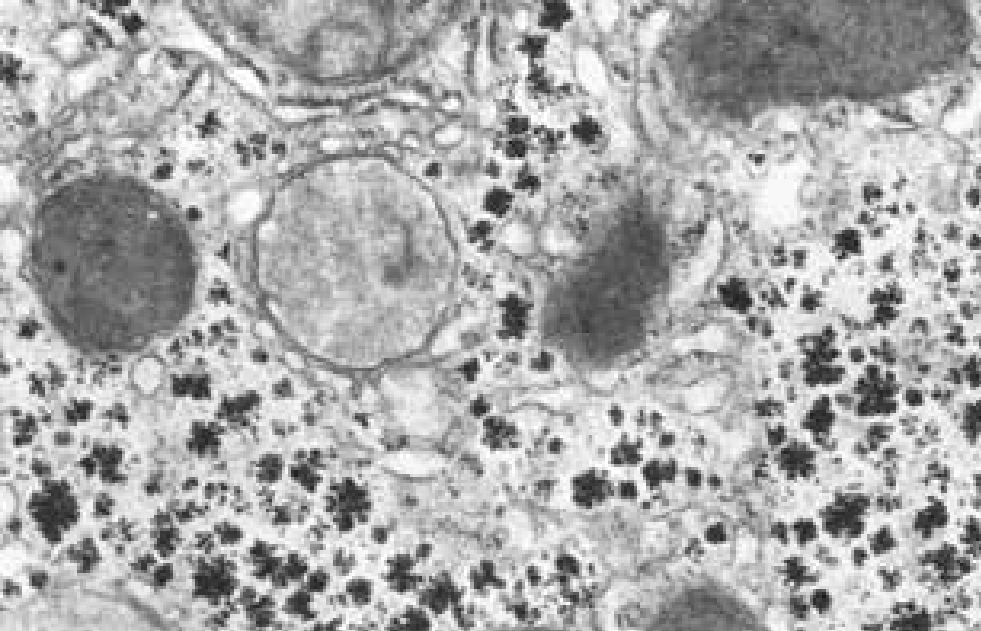

0,5 μm

Peroxisomy (mikrotělíska)

- Váčky – 0,1 - 0,5 μm \emptyset , jednoduchá membrána, matrix s oxidativními enzymy (peroxidáza, kataláza, urikáza aj.)

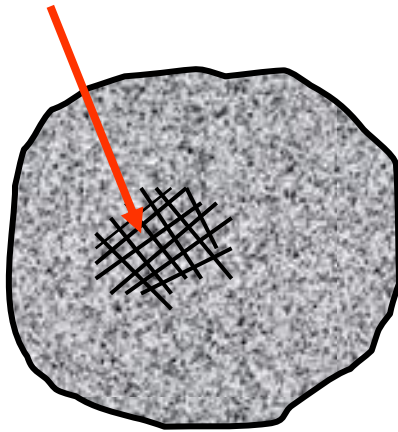

- [nukleoid = *krystaloid*]

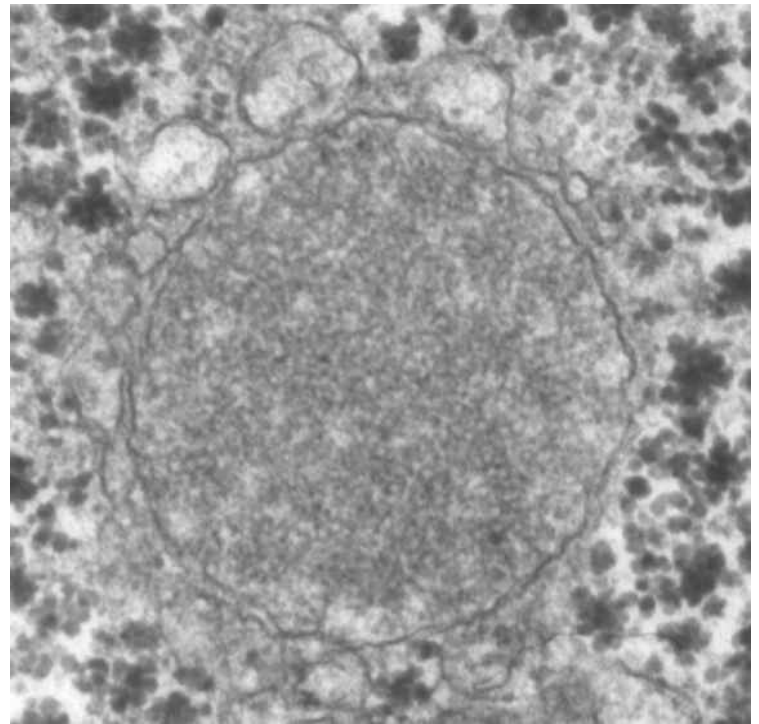

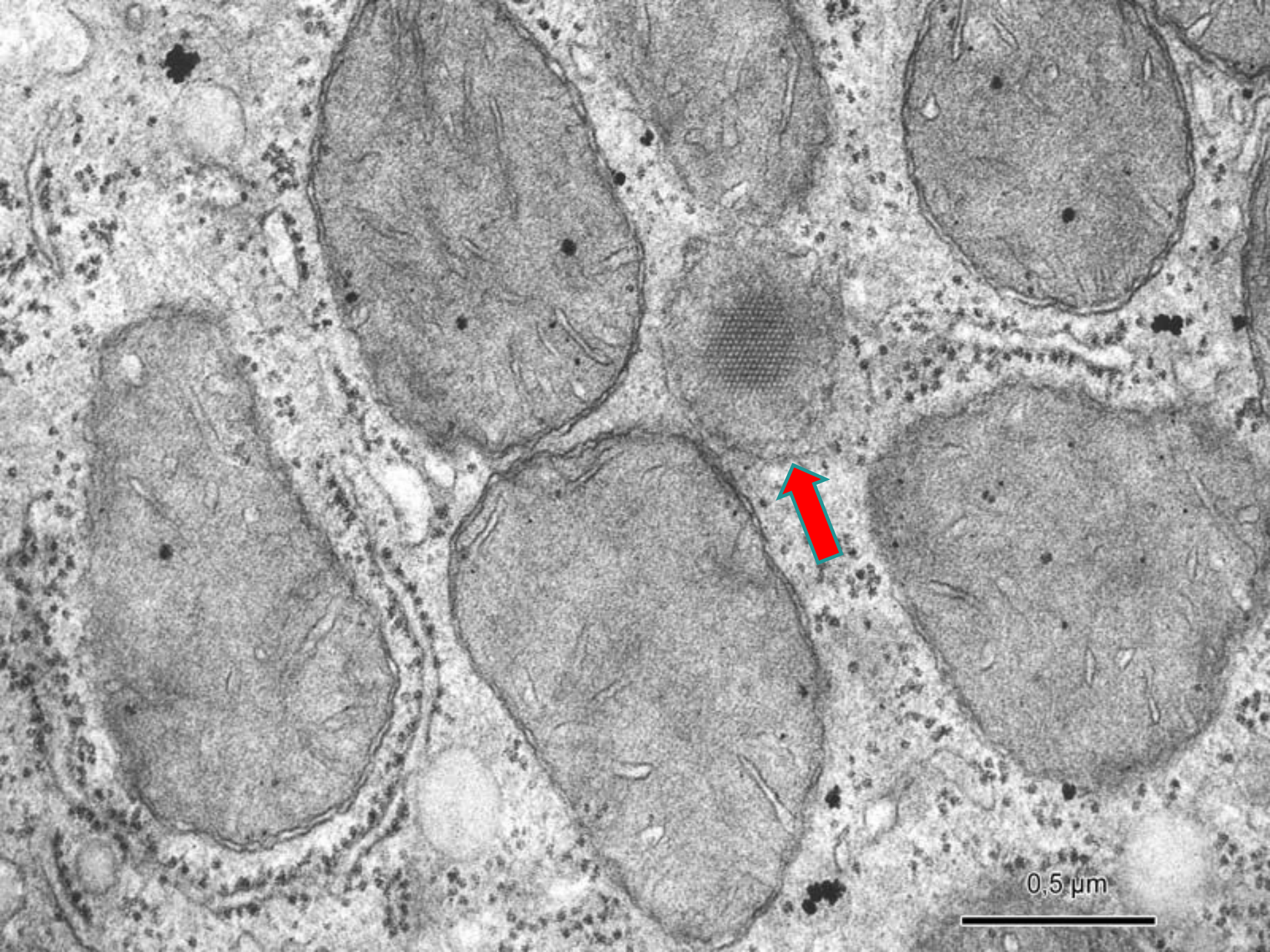

0,5 μm





Funkce lyzozomů a peroxisomů

- **Ly** – intracelulární digesce endo- a exogenního materiálu
- **Pe** – detoxikace (rozklad H_2O_2 , štěpení purinů a MK)
 - účast na syntéze žlučových kyselin
 - účast na syntéze fosfolipidů

Centriol

- Tvar: cylindr (válec)
- Velikost: \varnothing 0,2 μm , délka 0,3 - 0,5 μm
- Stavba: 9 tripletů mikrotubulů po obvodu stěny centriolu + matrix
- Výskyt v buňce (v interfázi): 1 pár centriolů [„T“] v oblasti cytoplazmy (PCM) = centrosom (blízko jádra)

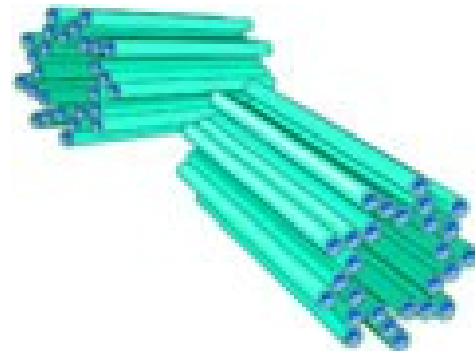
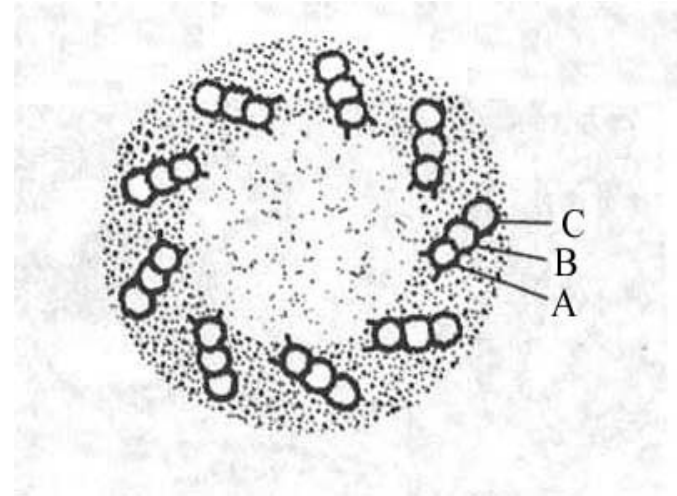

Struktura centriolu

a



b

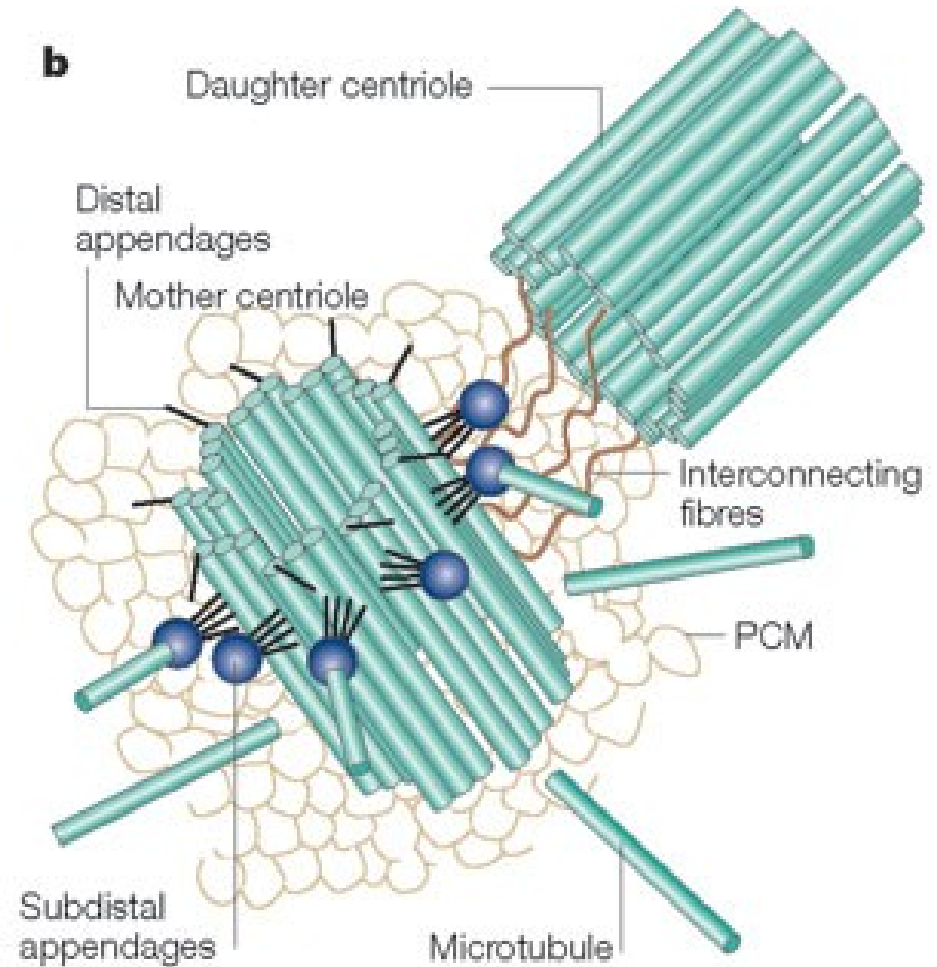

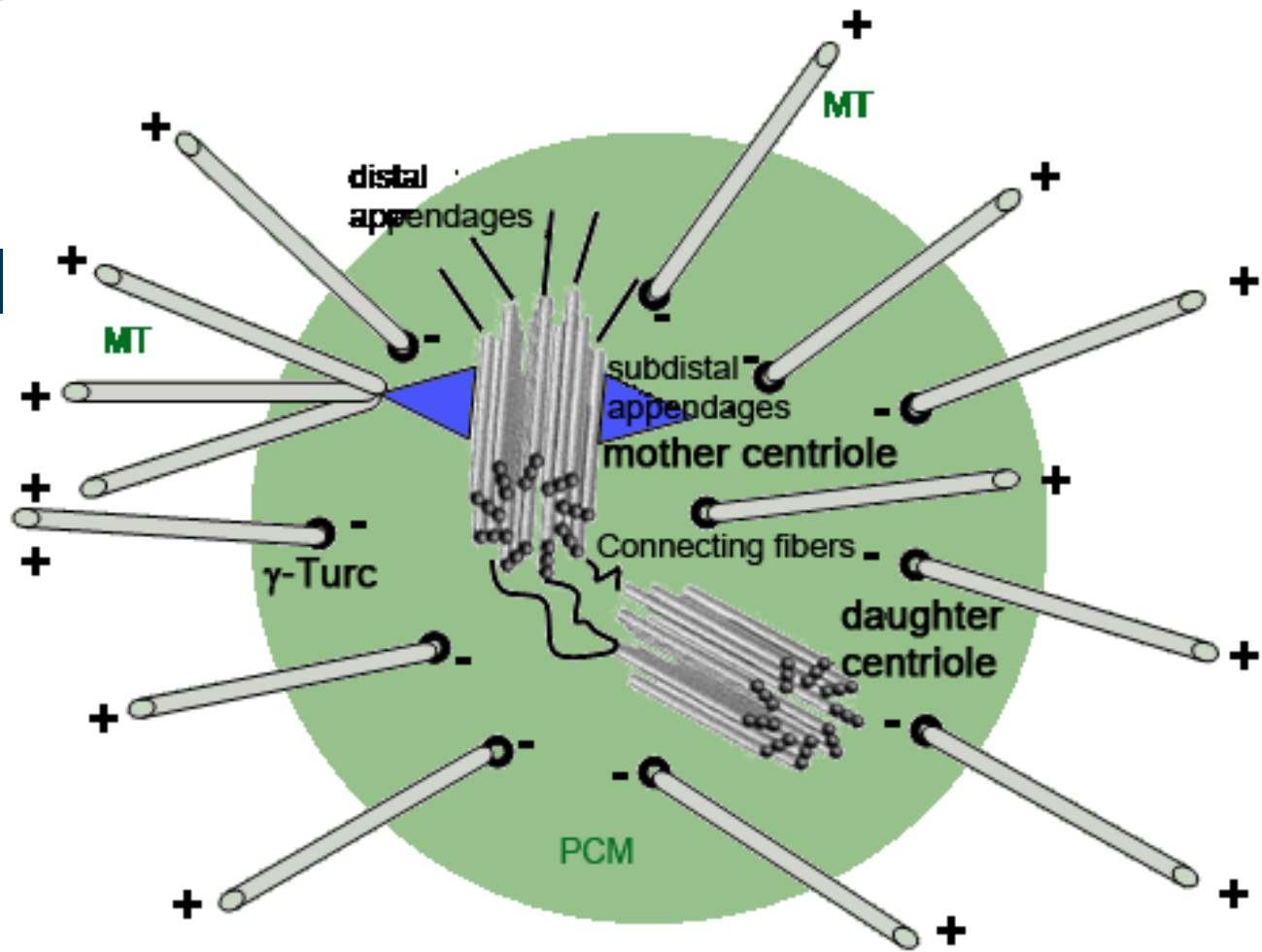

triplet mikrotubulů

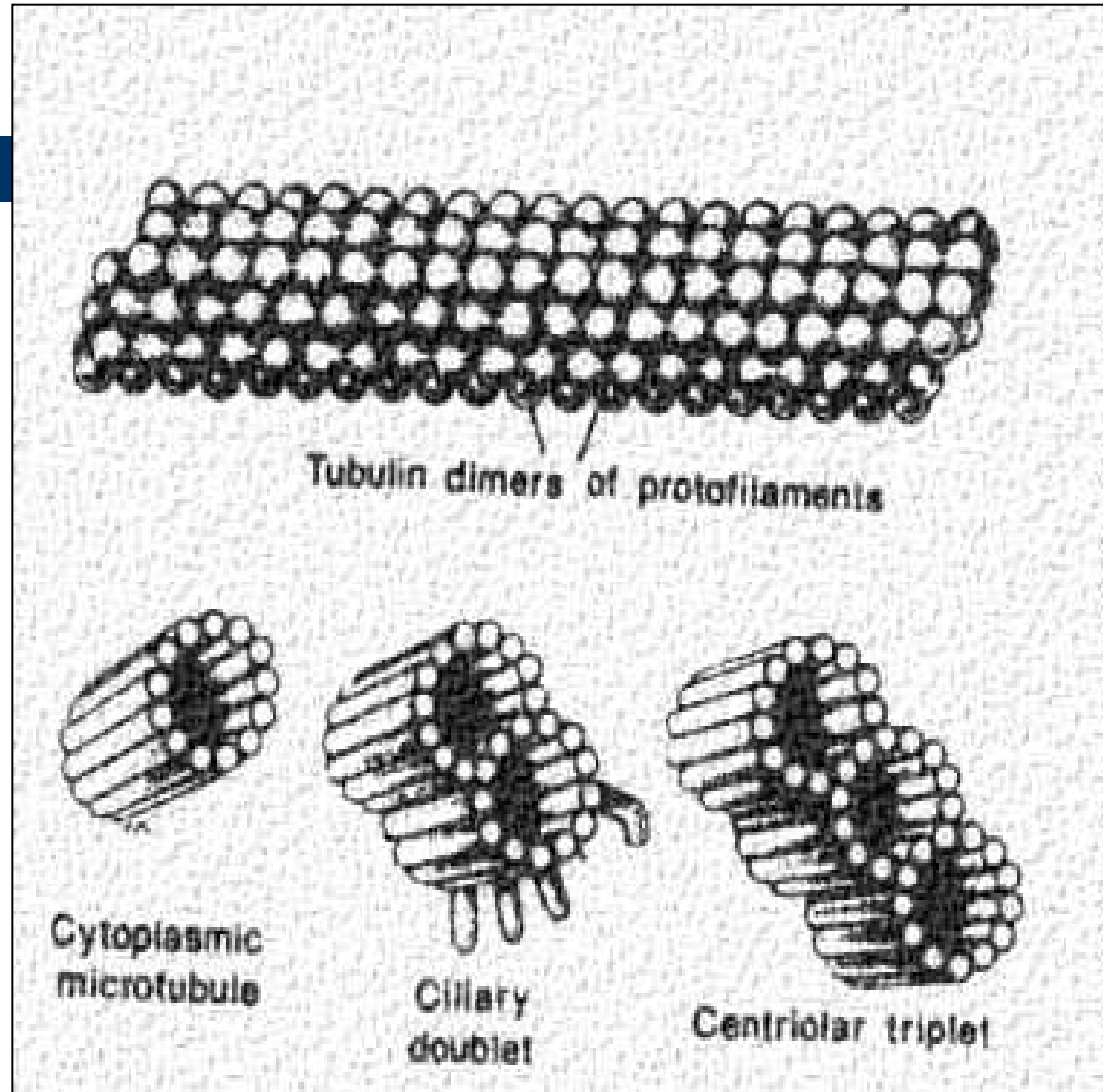
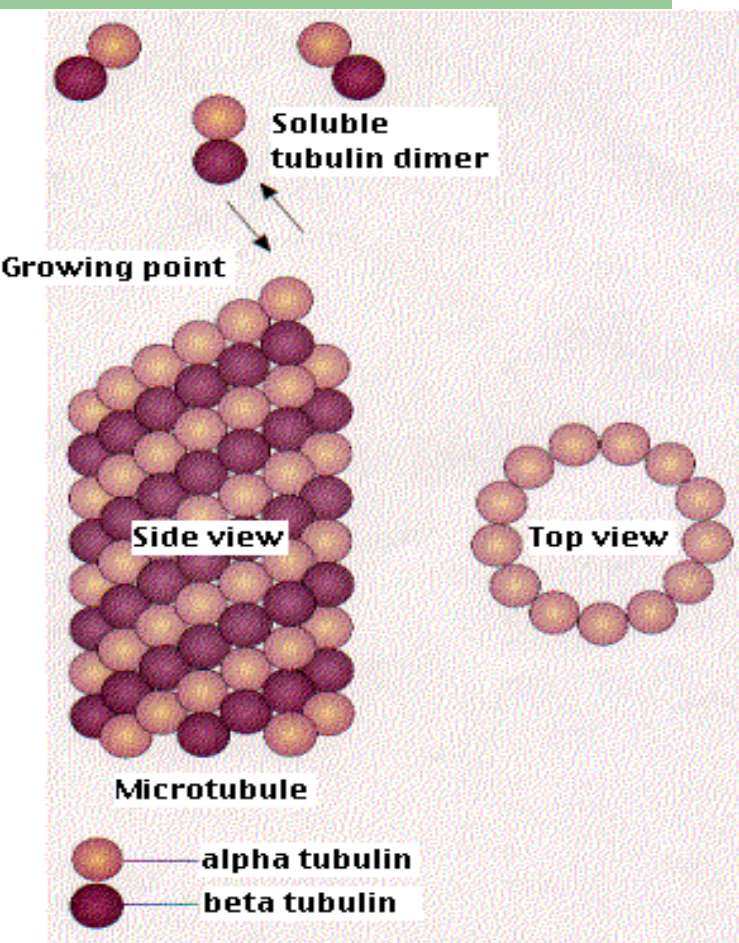

CCO

C B A mikrotubulus
10/10/13 protfilament

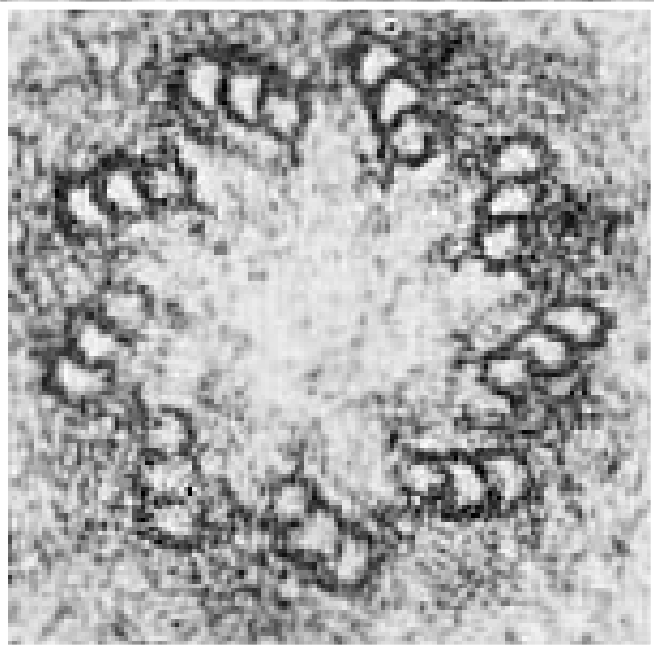
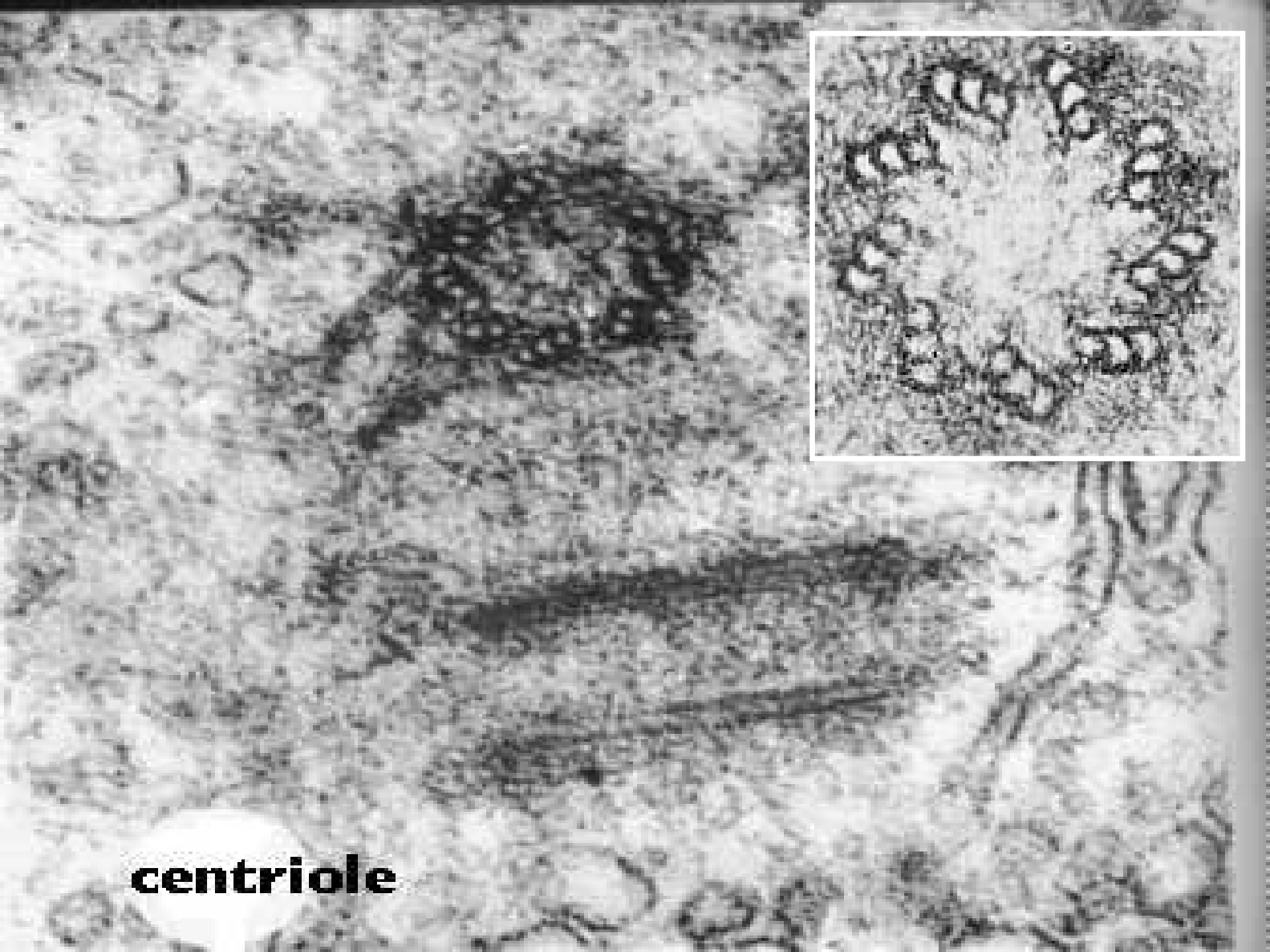

centriole

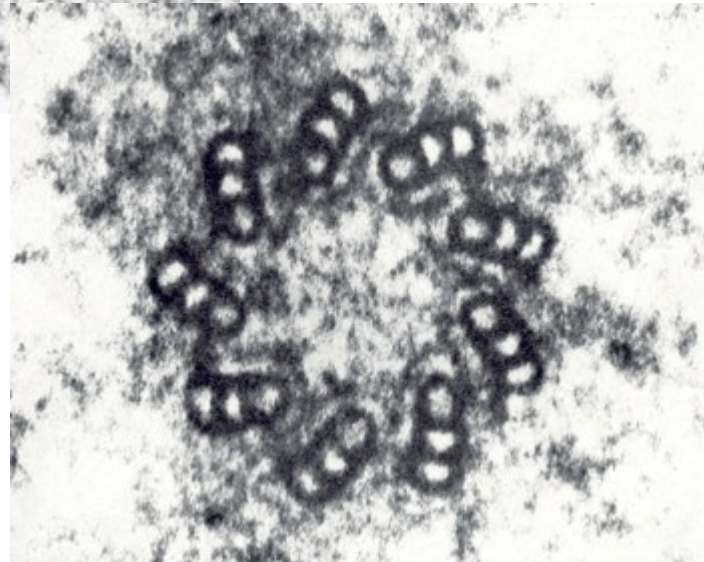
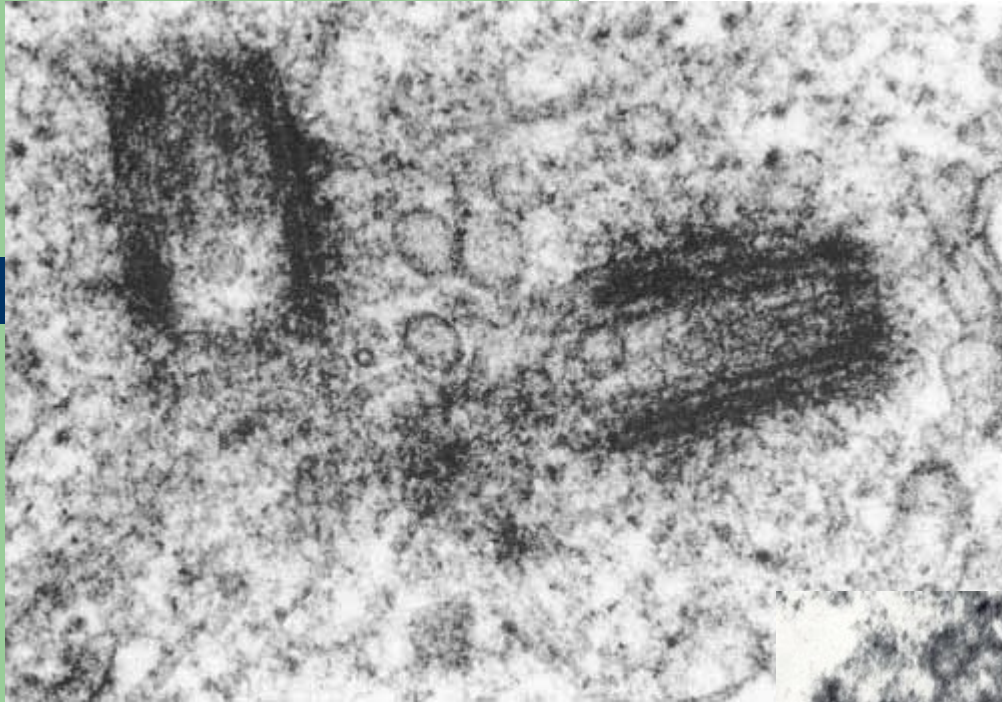

Funkce centriolů

Duplikace centriolů v průběhu dělení buňky

⇒ vznik dělicího vřeténka

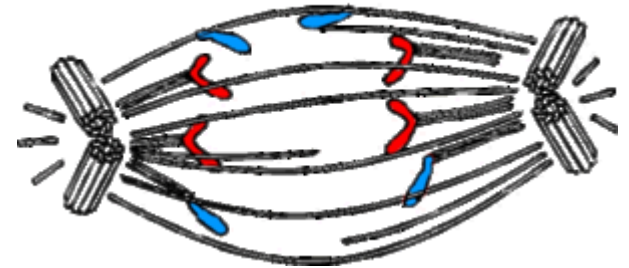

Mnohočetná replikace centriolů v průběhu ciliogeneze

⇒ vznik bazálních tělísek řasinek

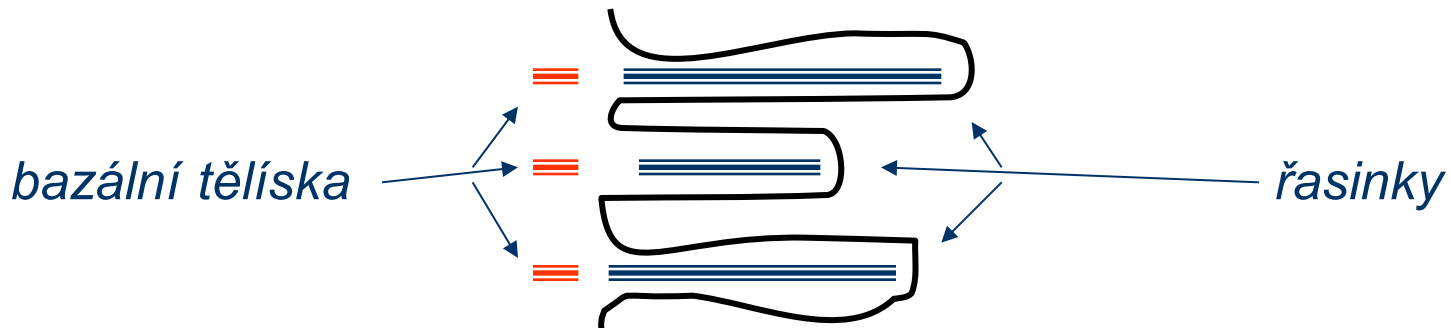

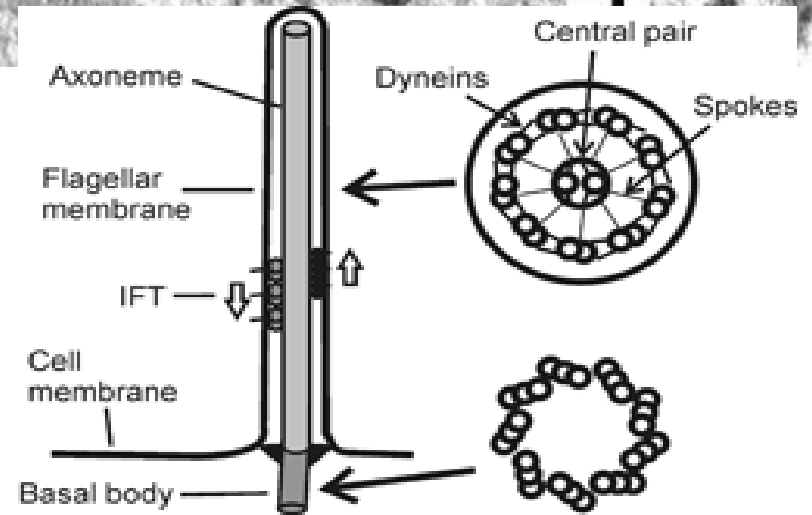
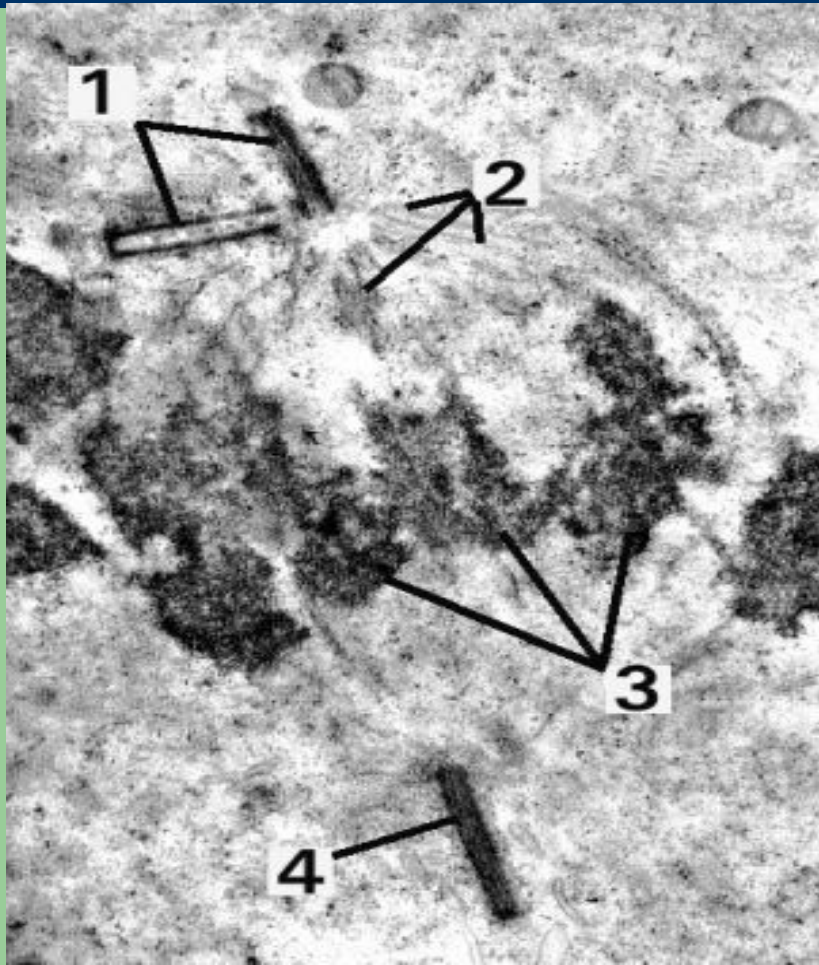
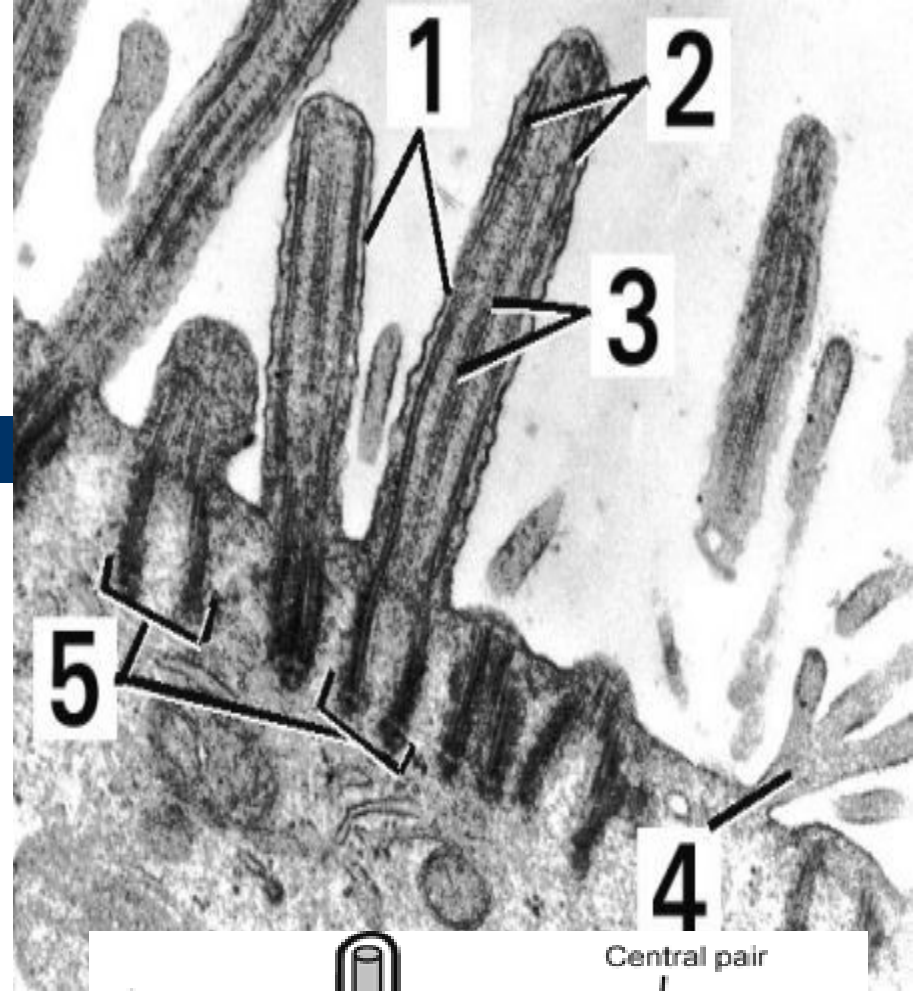

Inkluze

přechodné součásti buňky

- Sekreční granula
- Zásobní látky
 - glykogen
 - lipidové kapky
- Krystaly (proteiny)
- Pigmenty
 - endogenní
 - autogenní (melanin)
 - aj.
 - hematogenní
 - lipofuscin
 - exogenní – prach, barviva (karoteny), tetováž

Sekreční granula

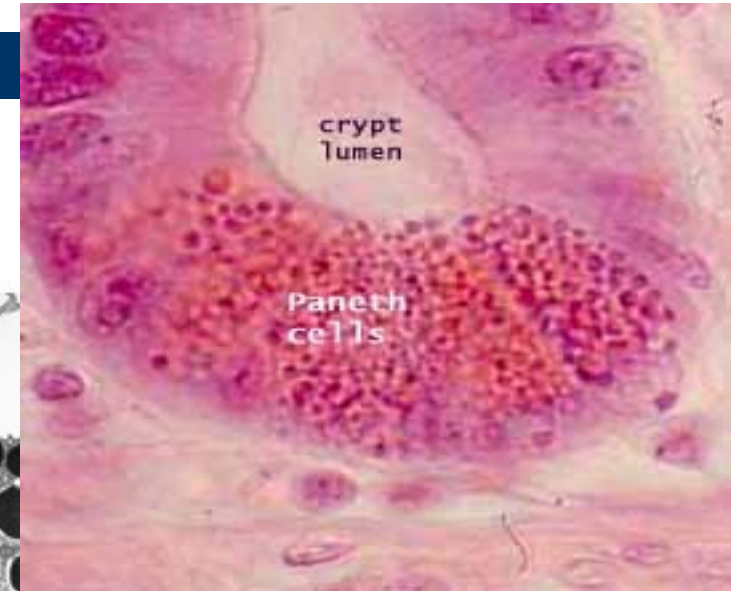
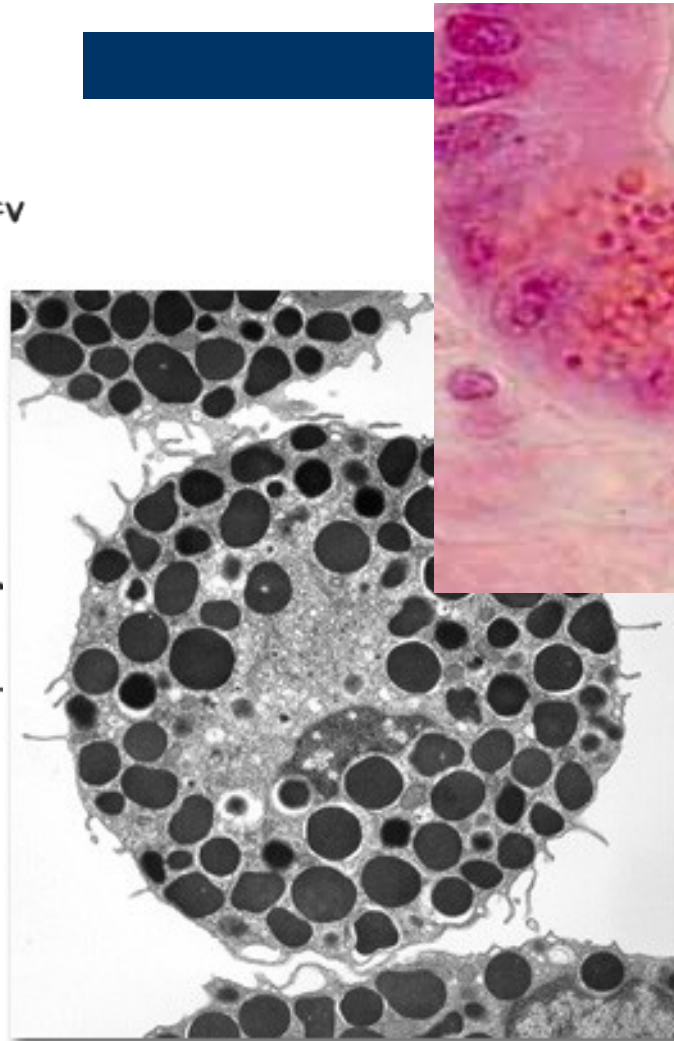
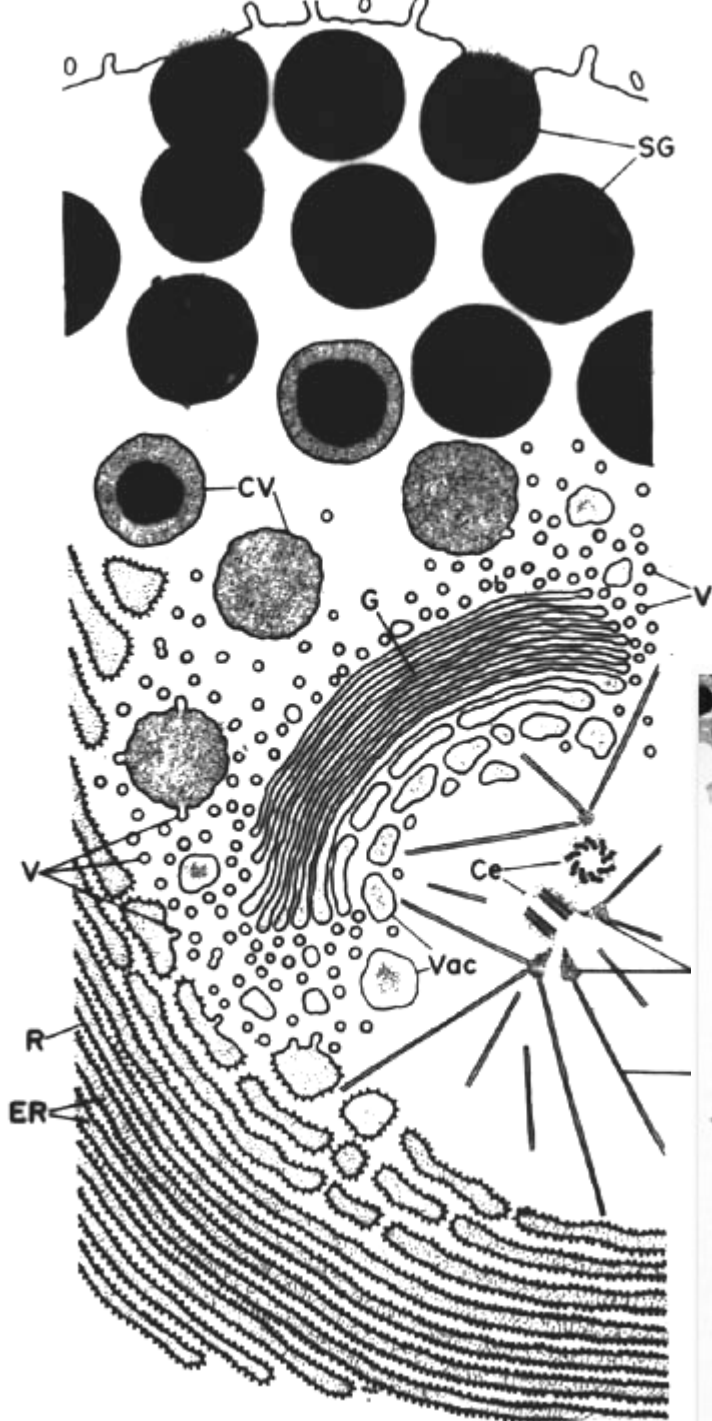

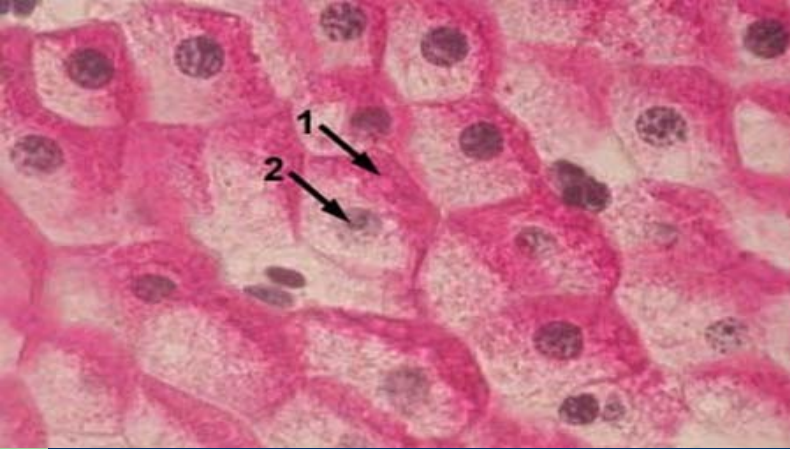

Glykogen

lineární, bohatě větvený polymer
složený z molekul glukózy

- β – granula (40 nm)

- α – granula (až 400 nm)

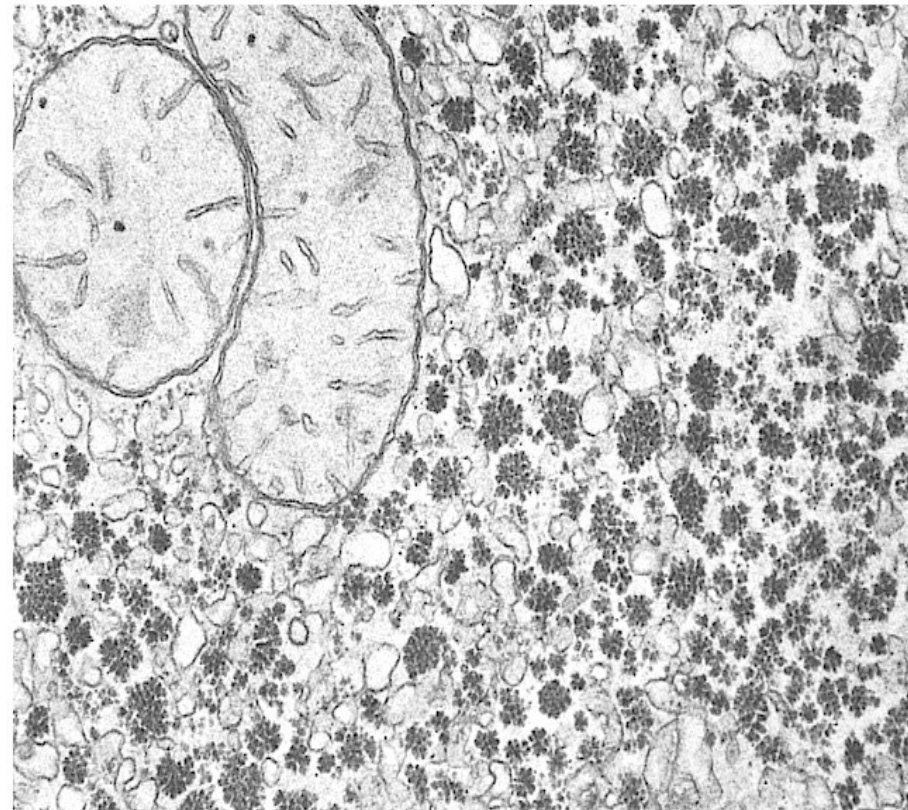
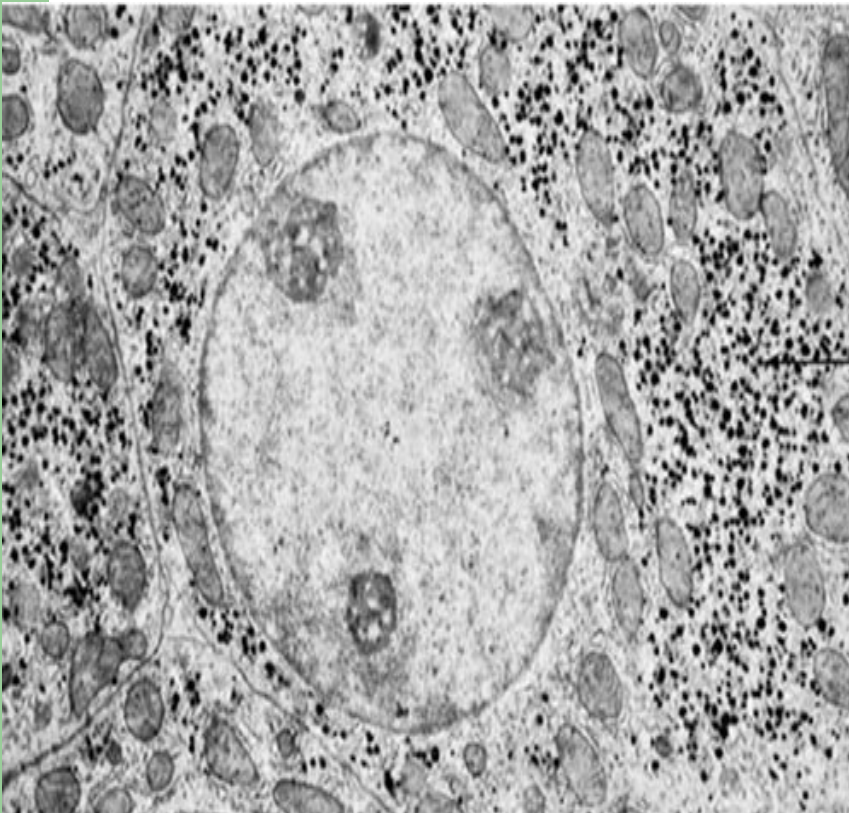



Lipidové kapky

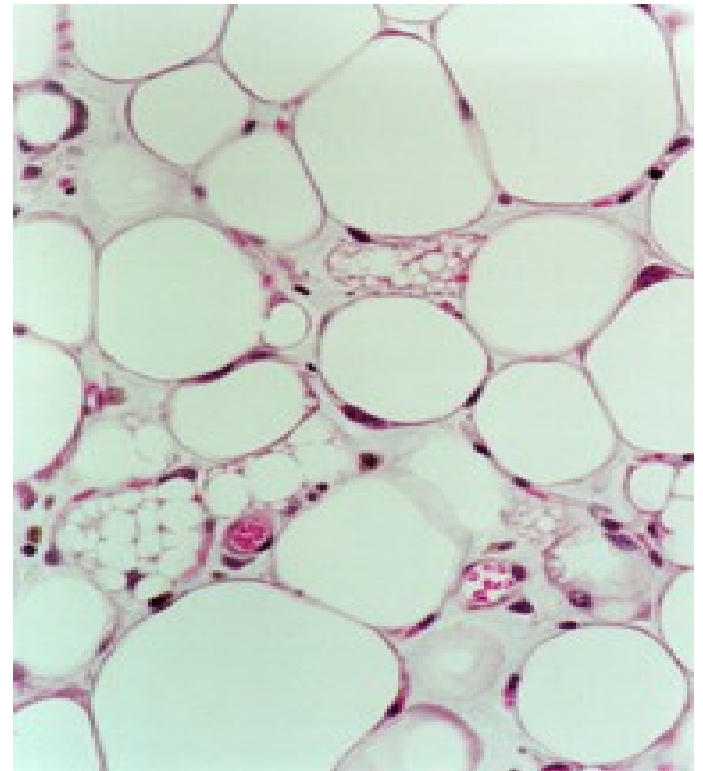
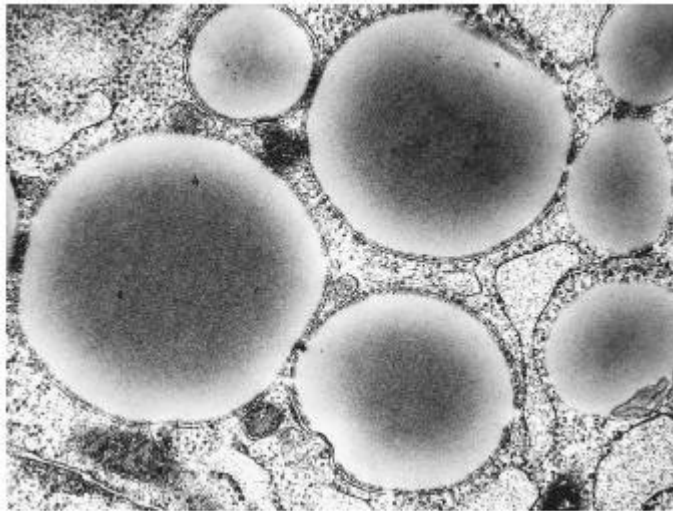

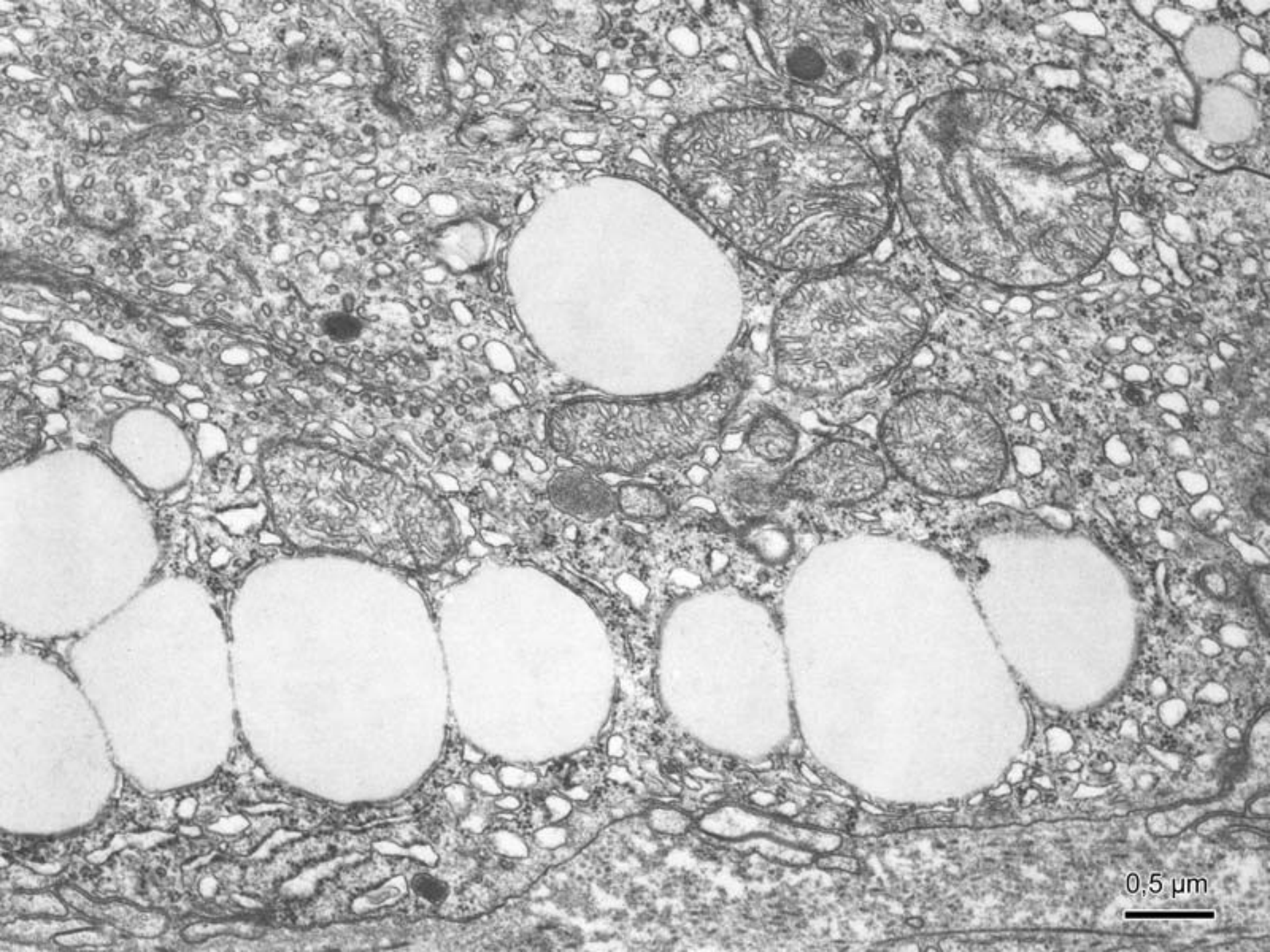

0,5 μm

Krystaly, pigmenty

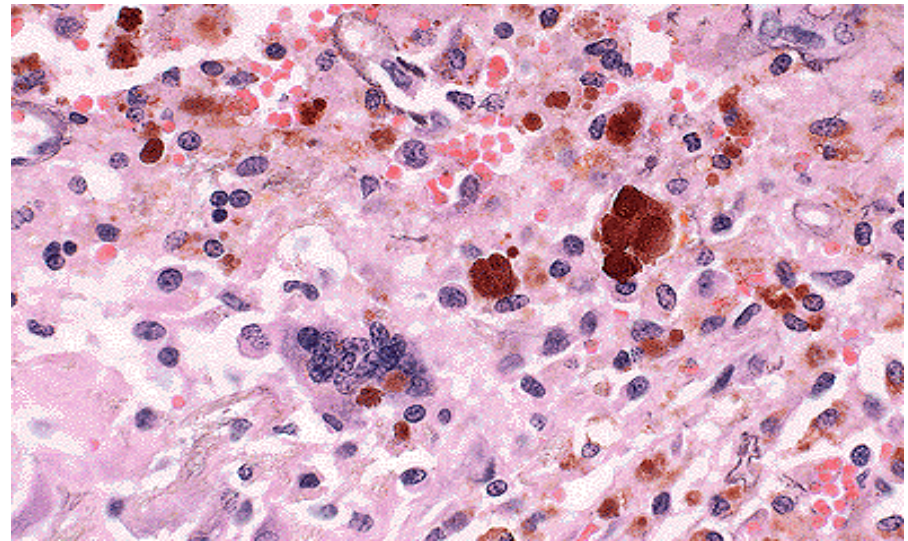
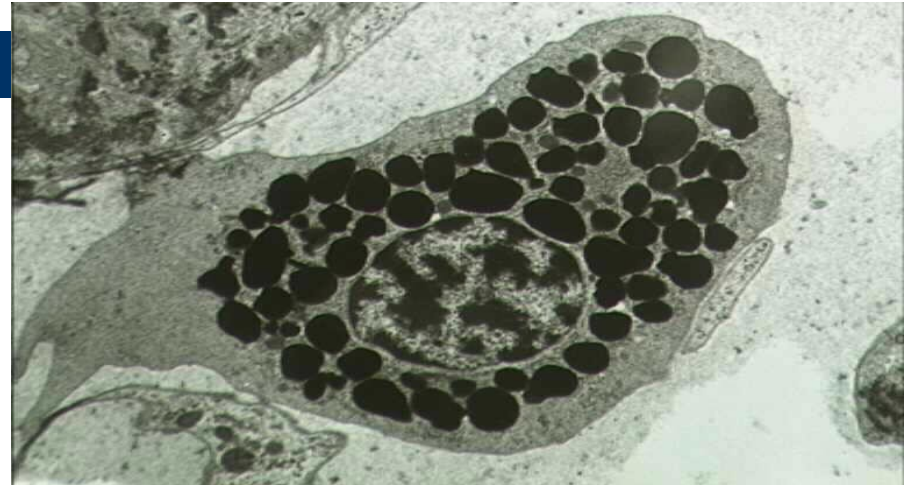
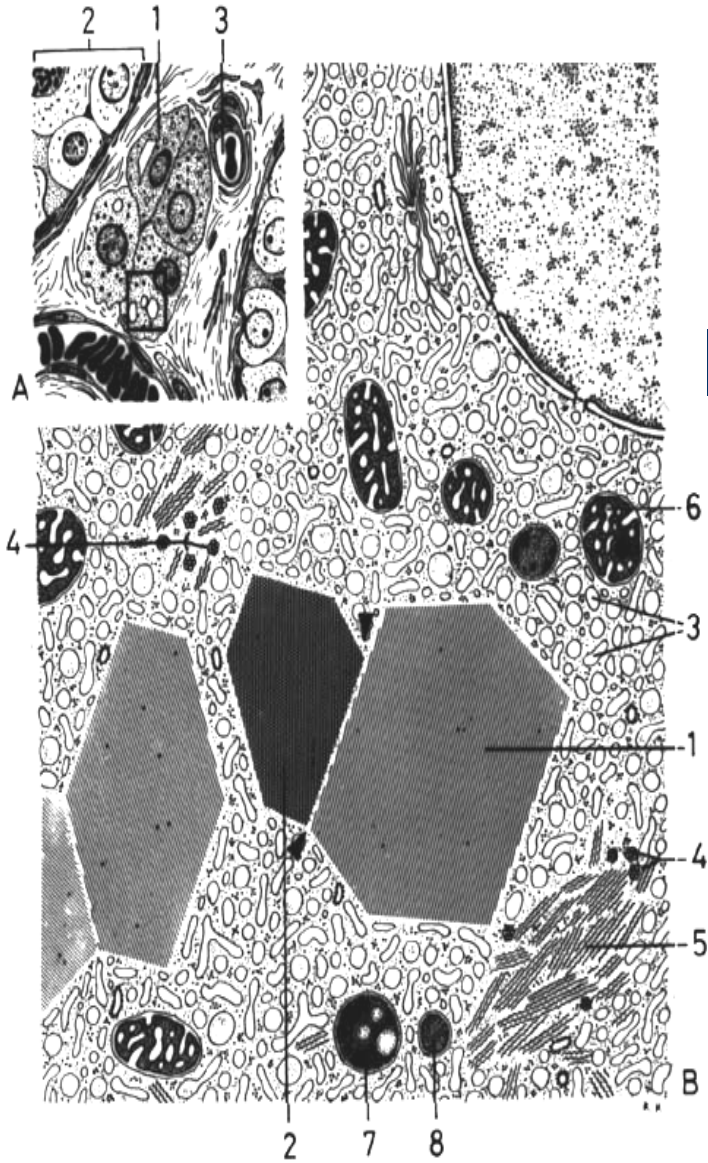

Buněčný povrch

- Volný povrch
 - hladký nebo s výběžky (mikroklky, řasinky, bičíky)
- Povrch přivrácený k jiné buňce (laterální)
 - mezibuněčné spoje
- Bazální povrch (přivrácený k nebuněčné struktuře – lamina basalis nebo bazální membrána – poloviční spoje (hemidesmosomy))

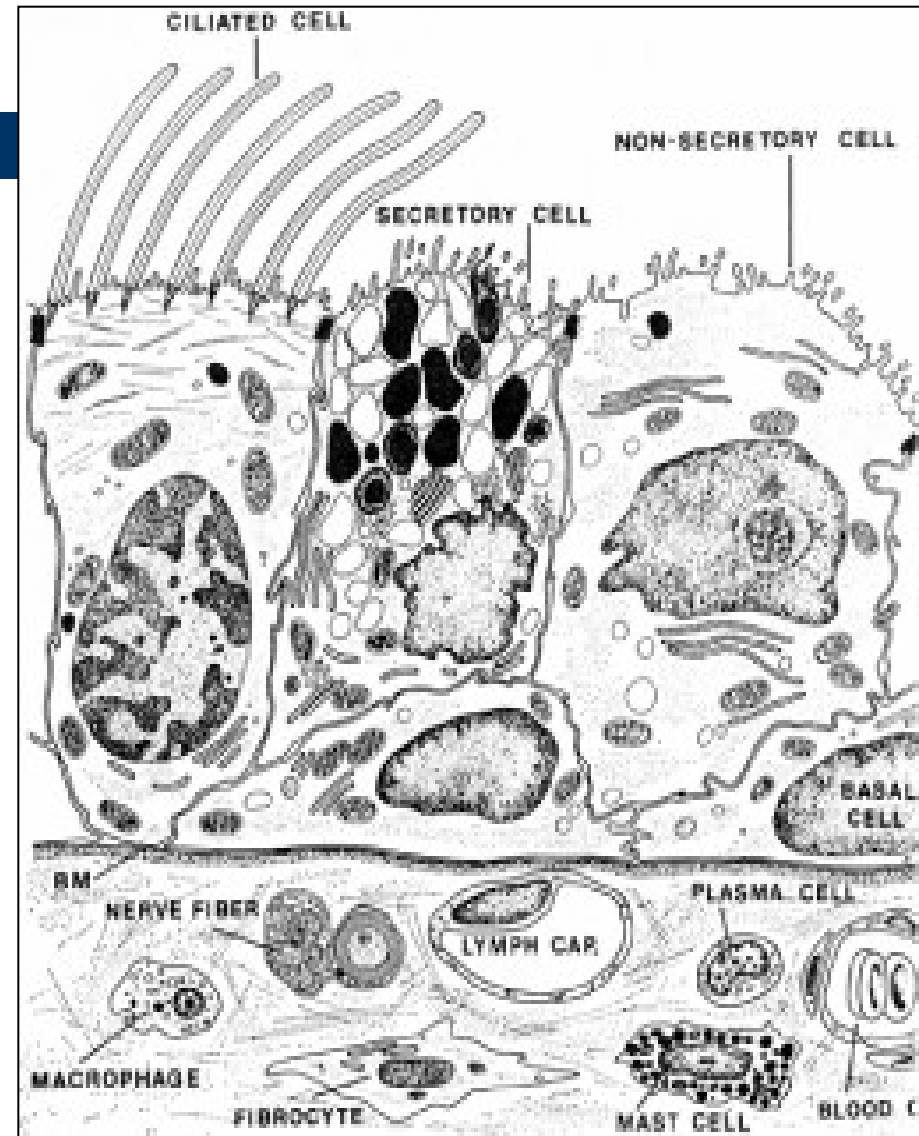

Volný povrch

- hladký (rovný nebo členitý – *např. pseudopodie*)
- mikroklky
- kinocilie, flagella

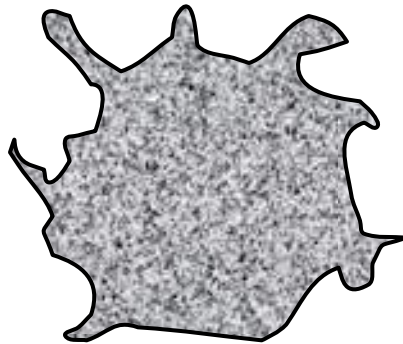
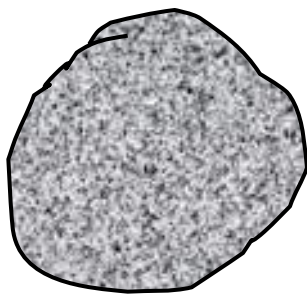

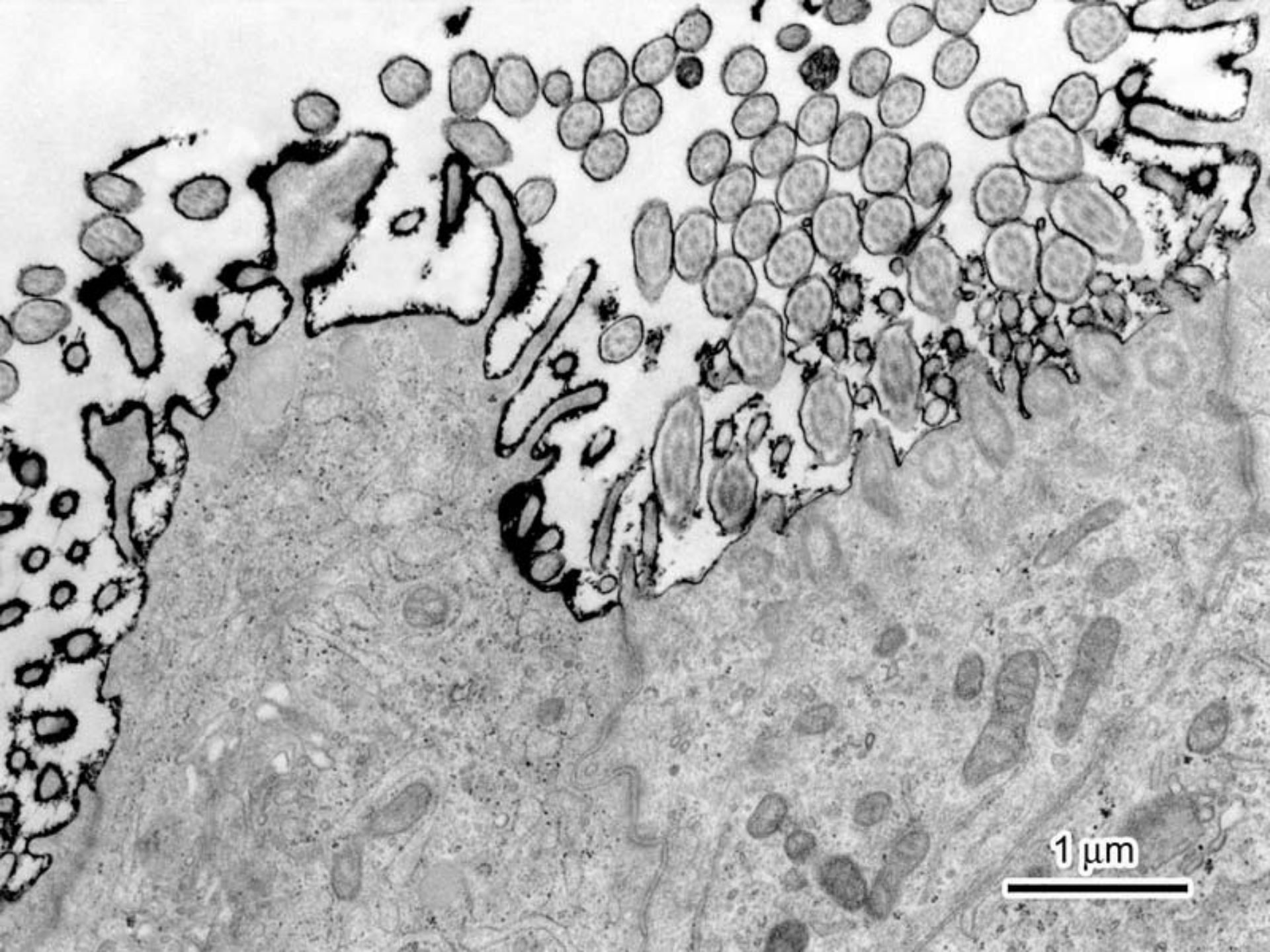

Mikroklky

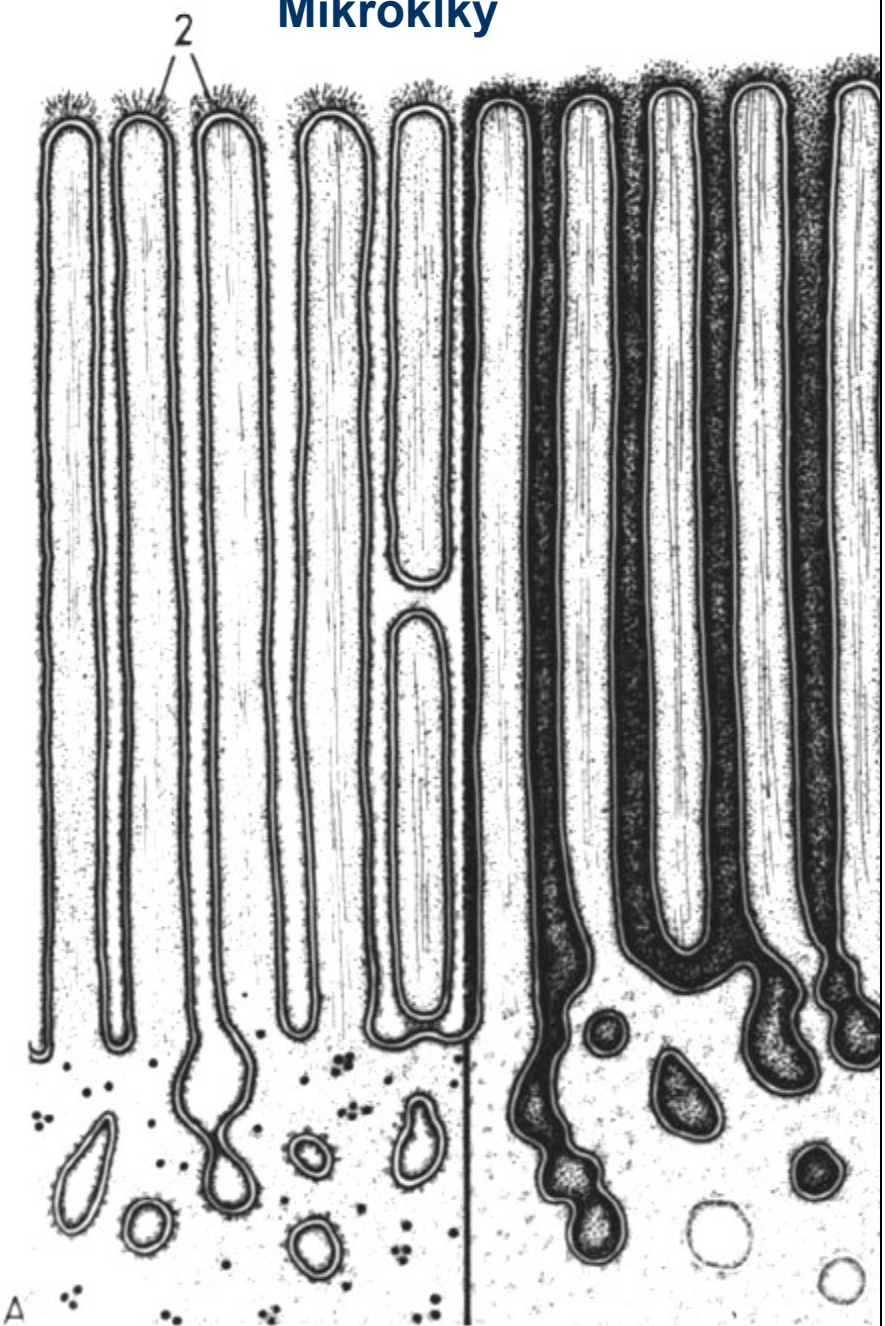

Řasinky (kinocilie)

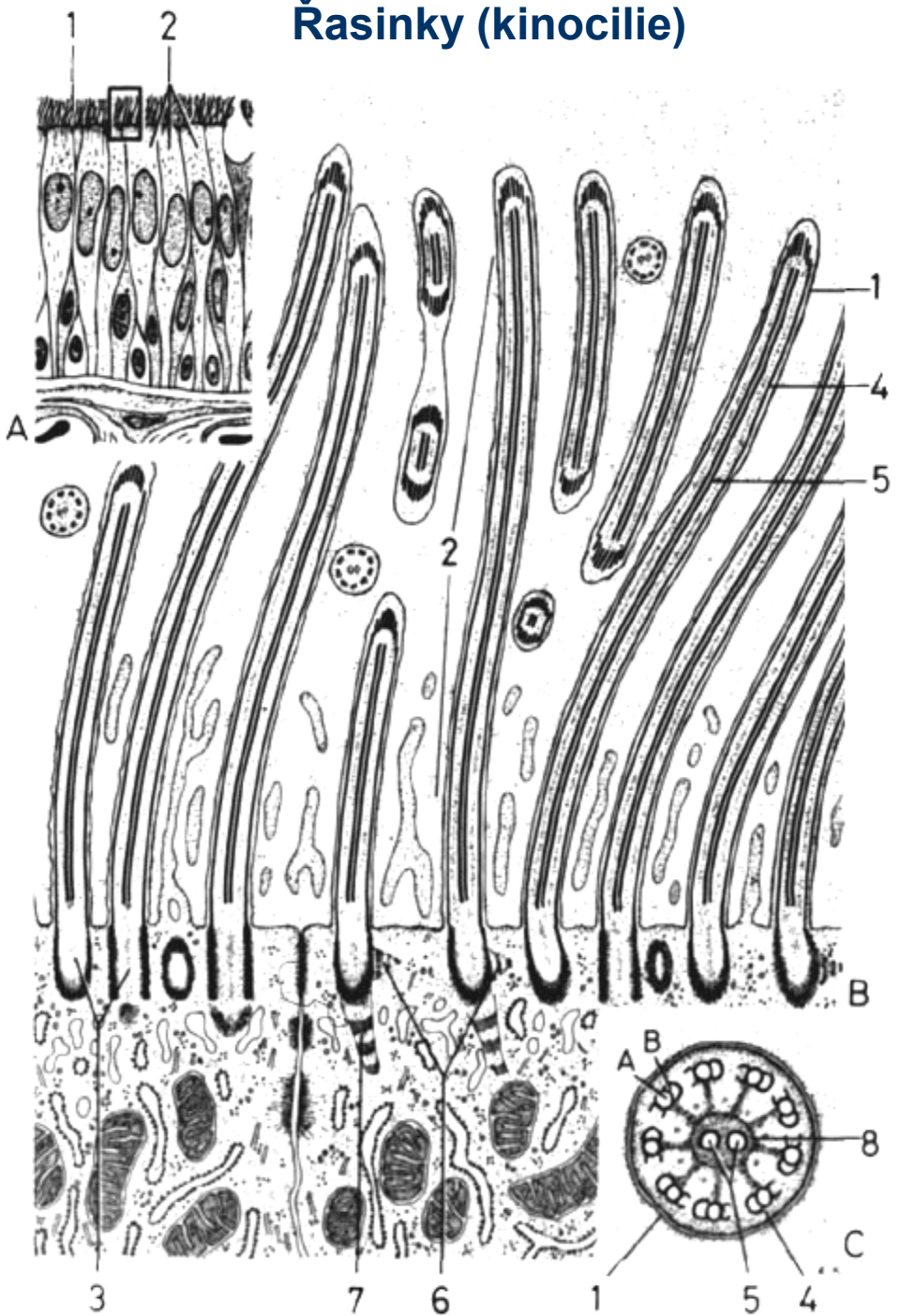

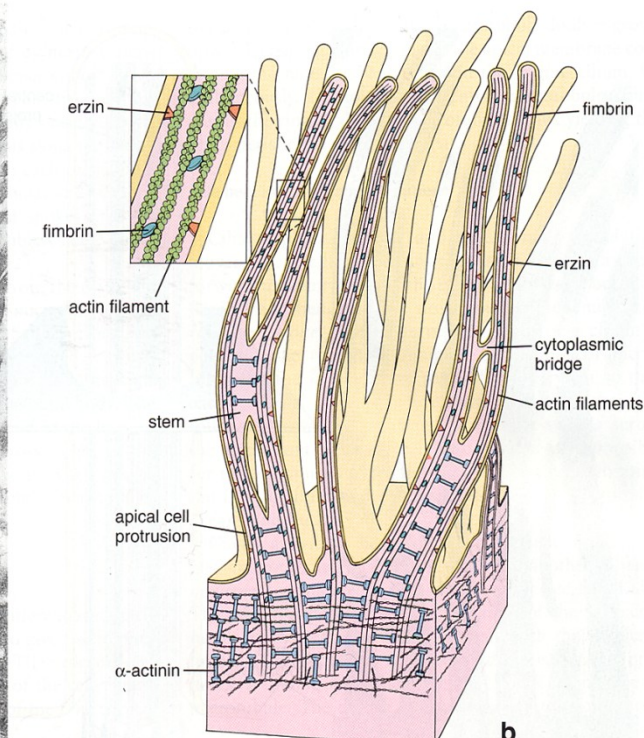
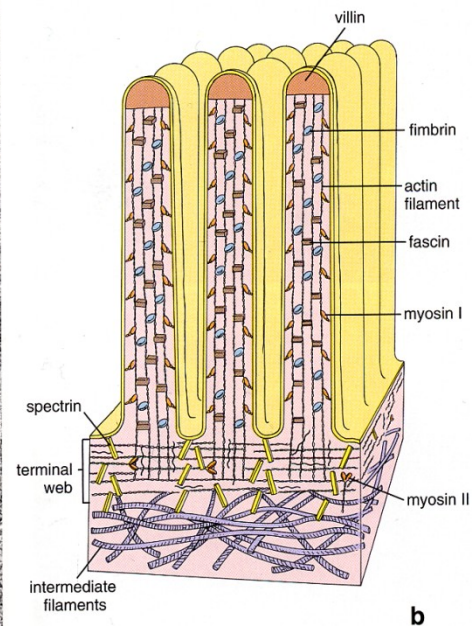

Mikroklky = výběžky cytoplazmy vyztužené aktinovými mikrofilamenty – dle uspořádání:

- krátké, nepravidelné
- žíhaná kutikula – *př. epitel. bb. střeva*
- kartáčový lem – *př. kanálky nefronu*
- stereocilie – *př. ductus deferens*

kartáčový lem

LEDVINA

STŘEVO

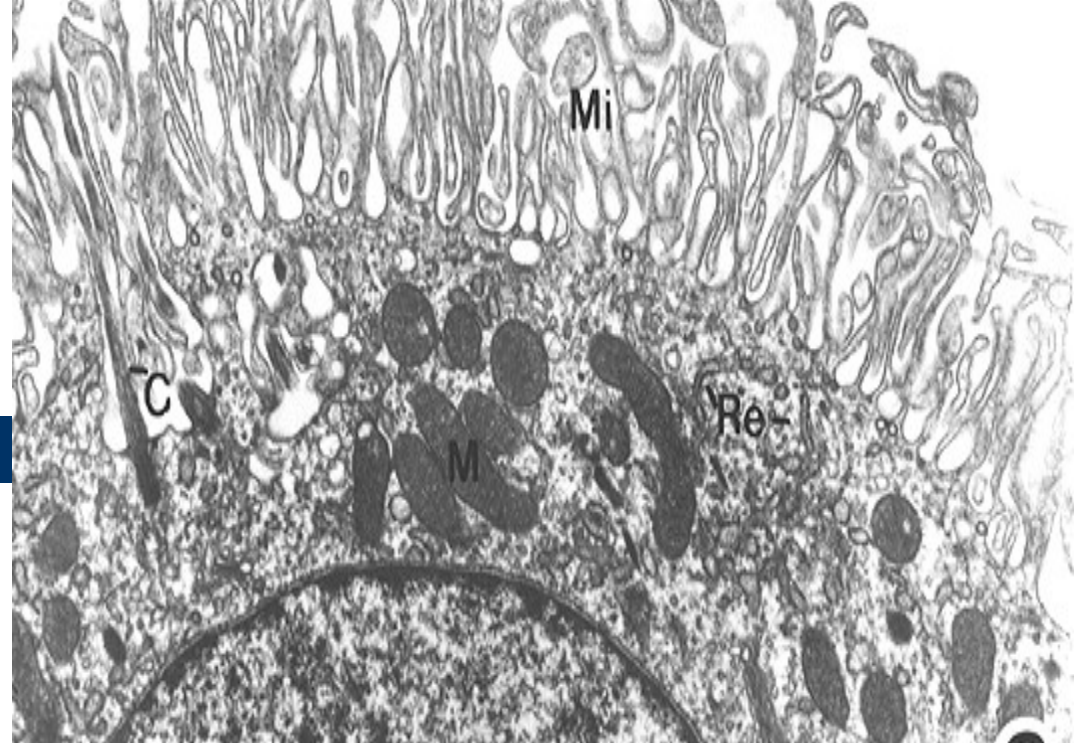

Glycocalyx

Microvilli

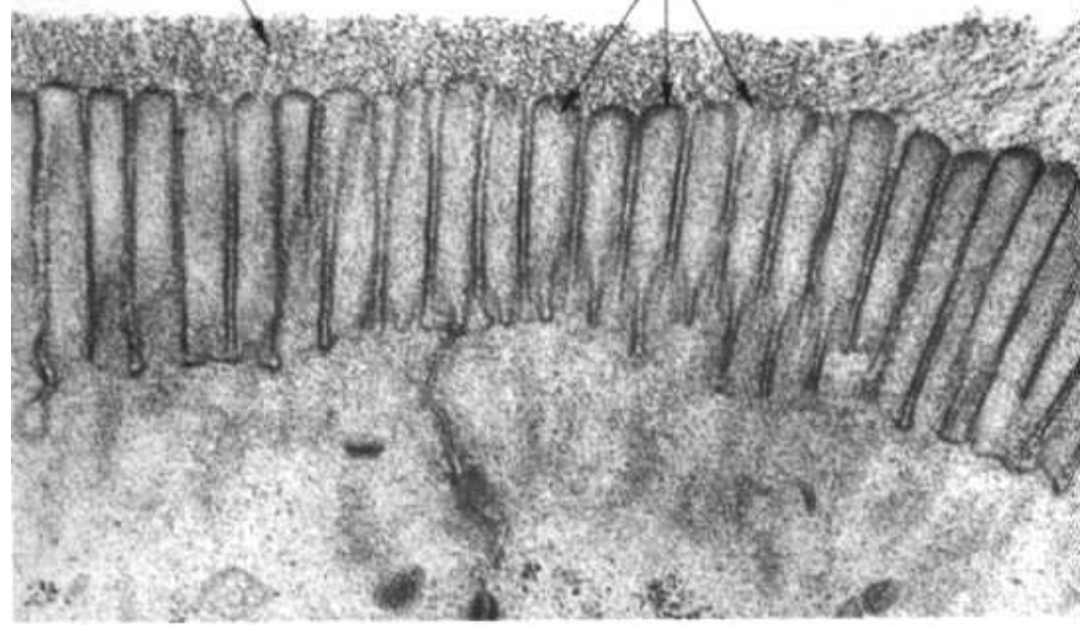

žíhaná kutikula

Kinocilium a flagellum (řasinka a bičík)

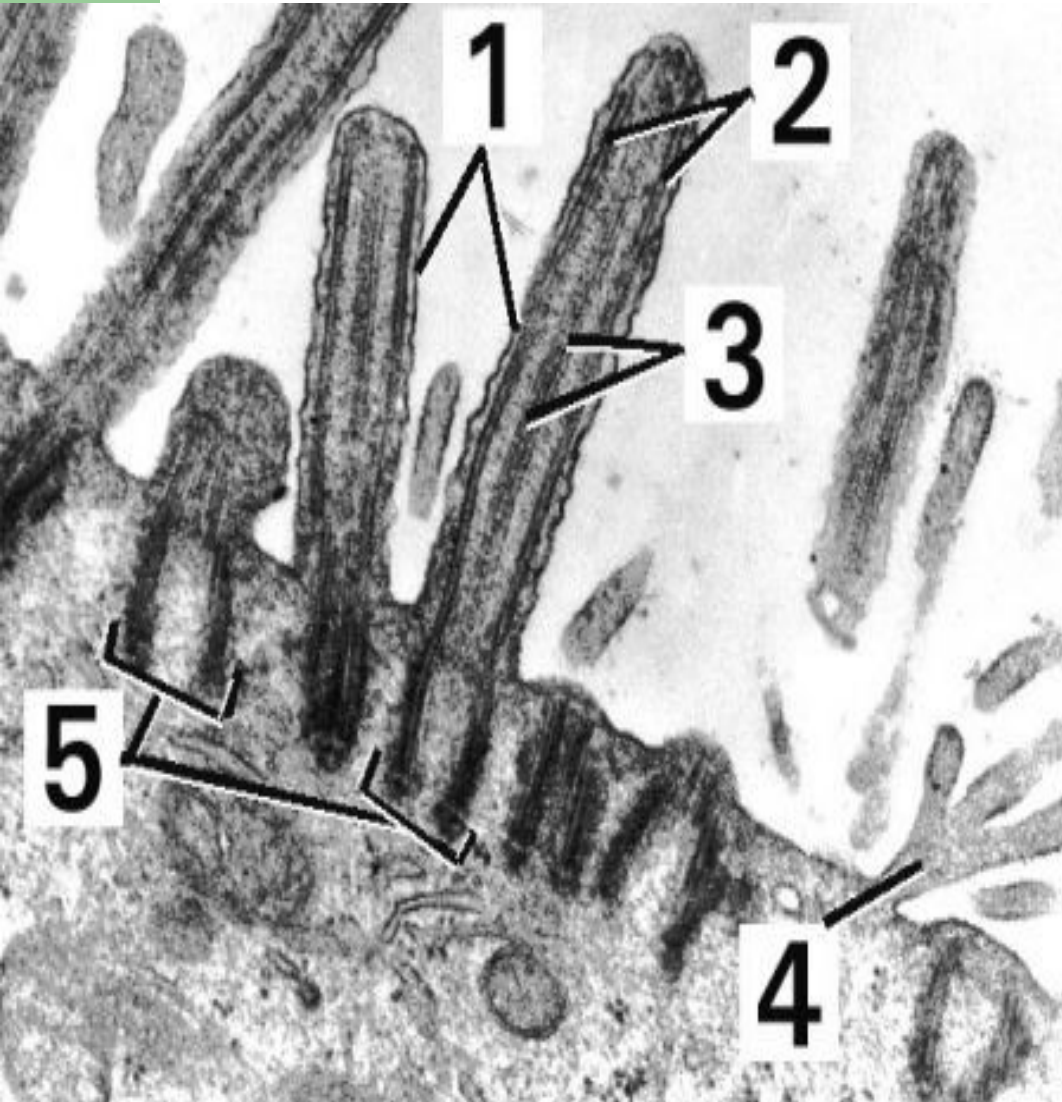



(a) 0.5 μm

©1999 Addison Wesley Longman, Inc.

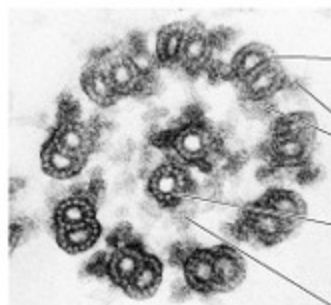

(b) 0.1 μm

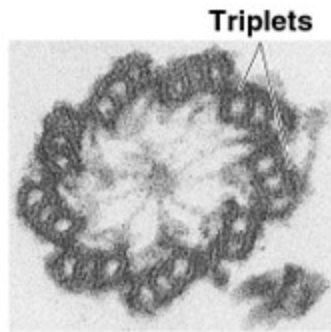

(c) 0.1 μm

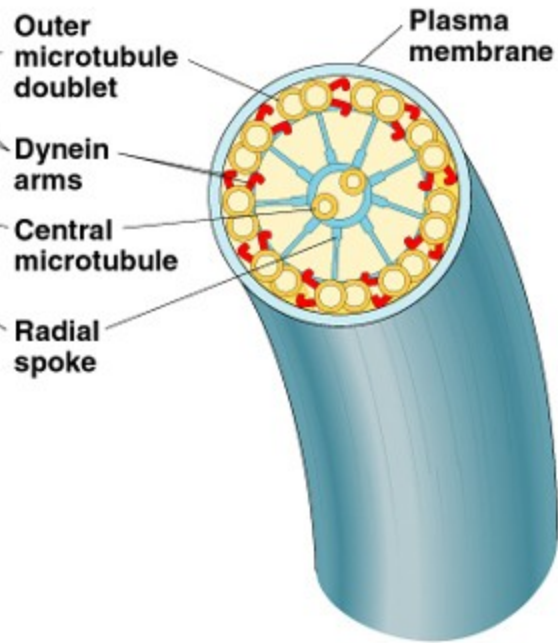

Řasinky, bičíky

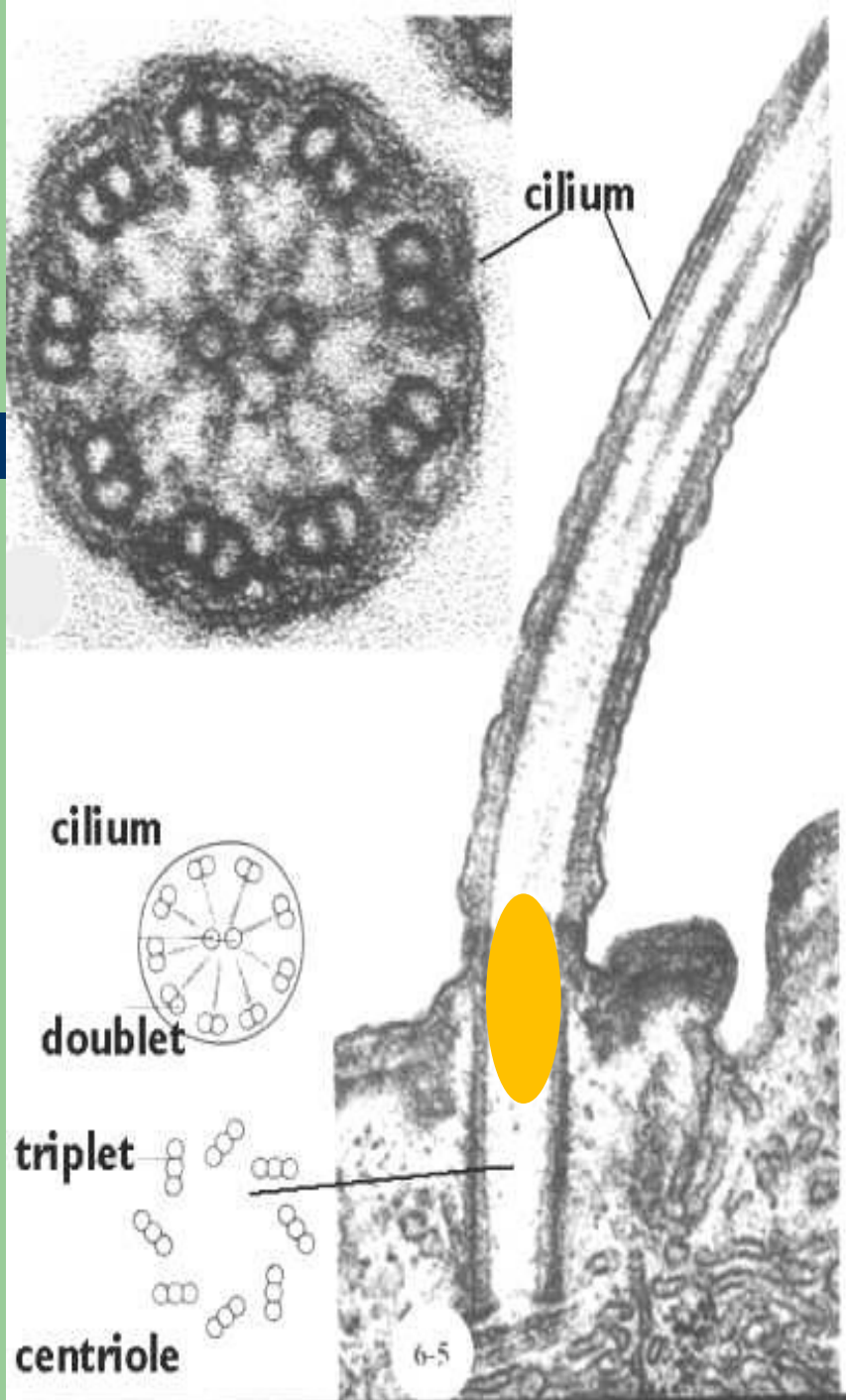

- Pohyblivé výběžky cytoplazmy vyztužené **mikrotubuly**:
9 dubletů + 1 centrální pár = **AXONEMA**
- **Bazální tělísko** = centriol
- Žíhaná nožka

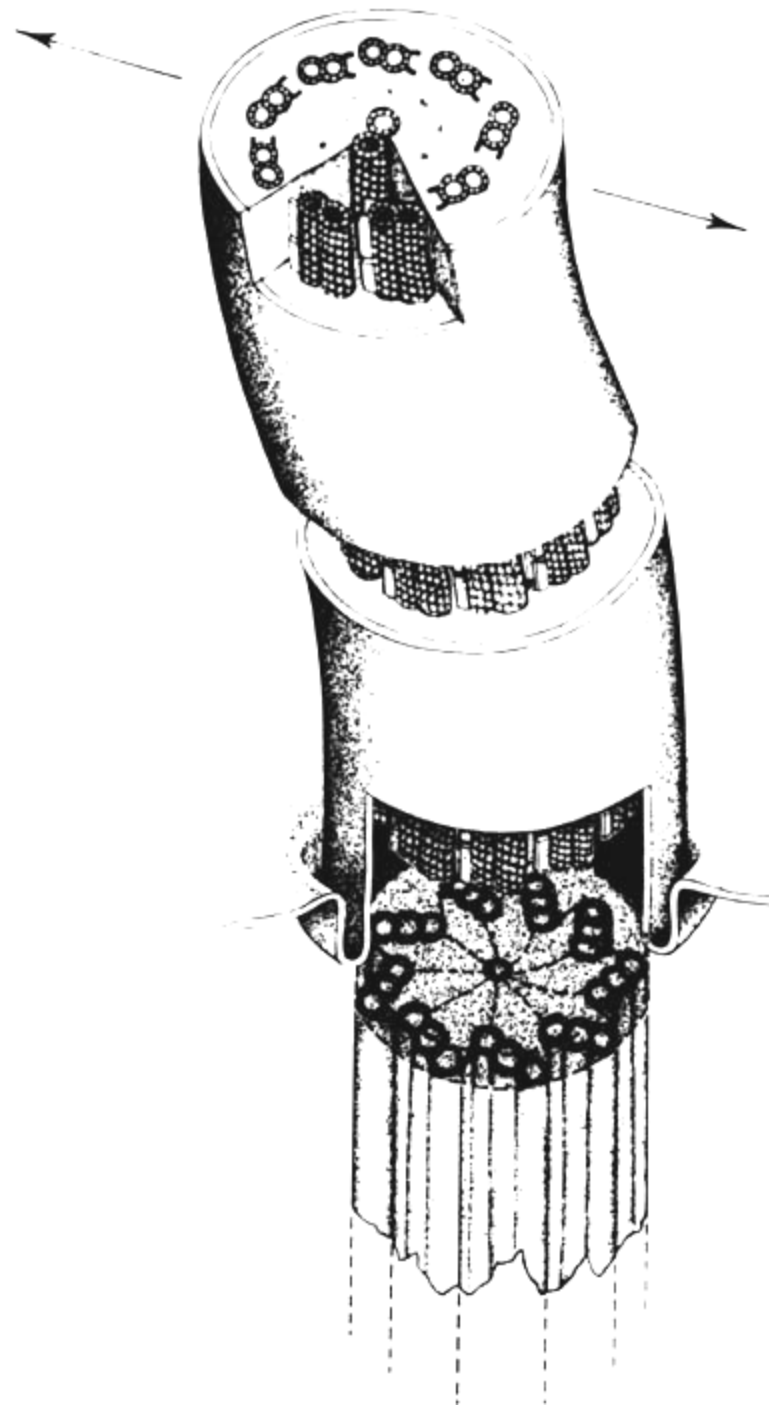
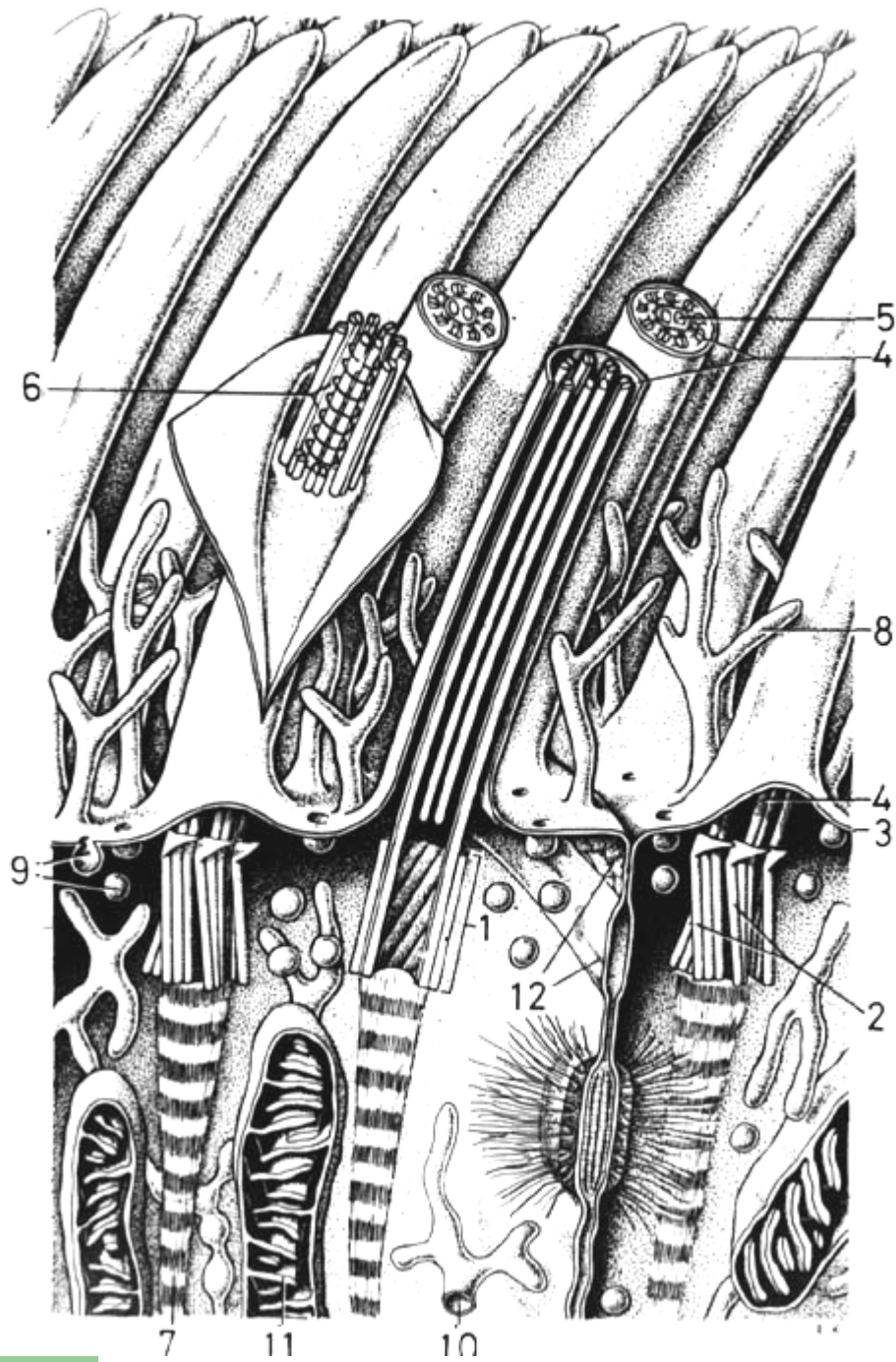

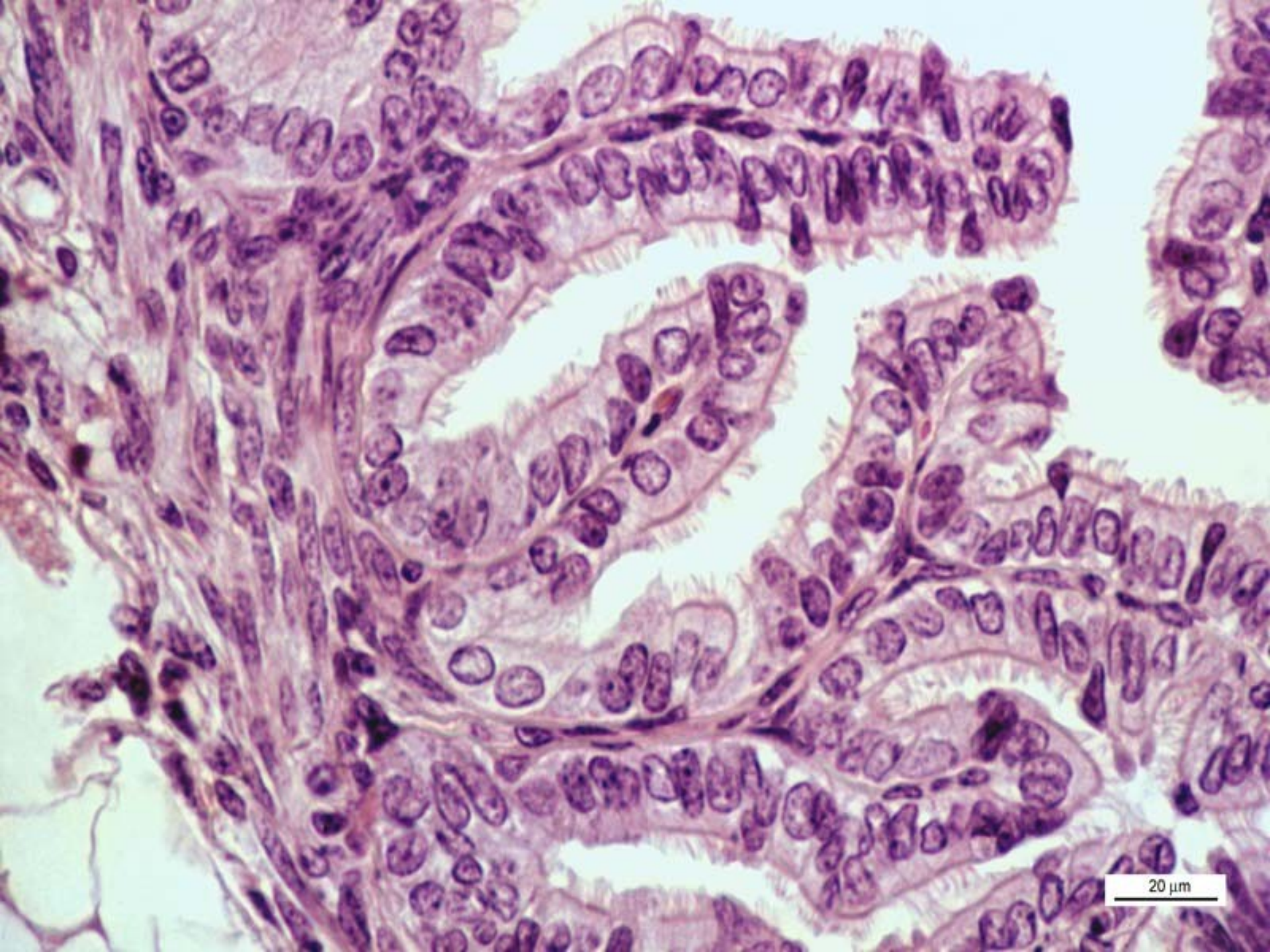

20 μ m

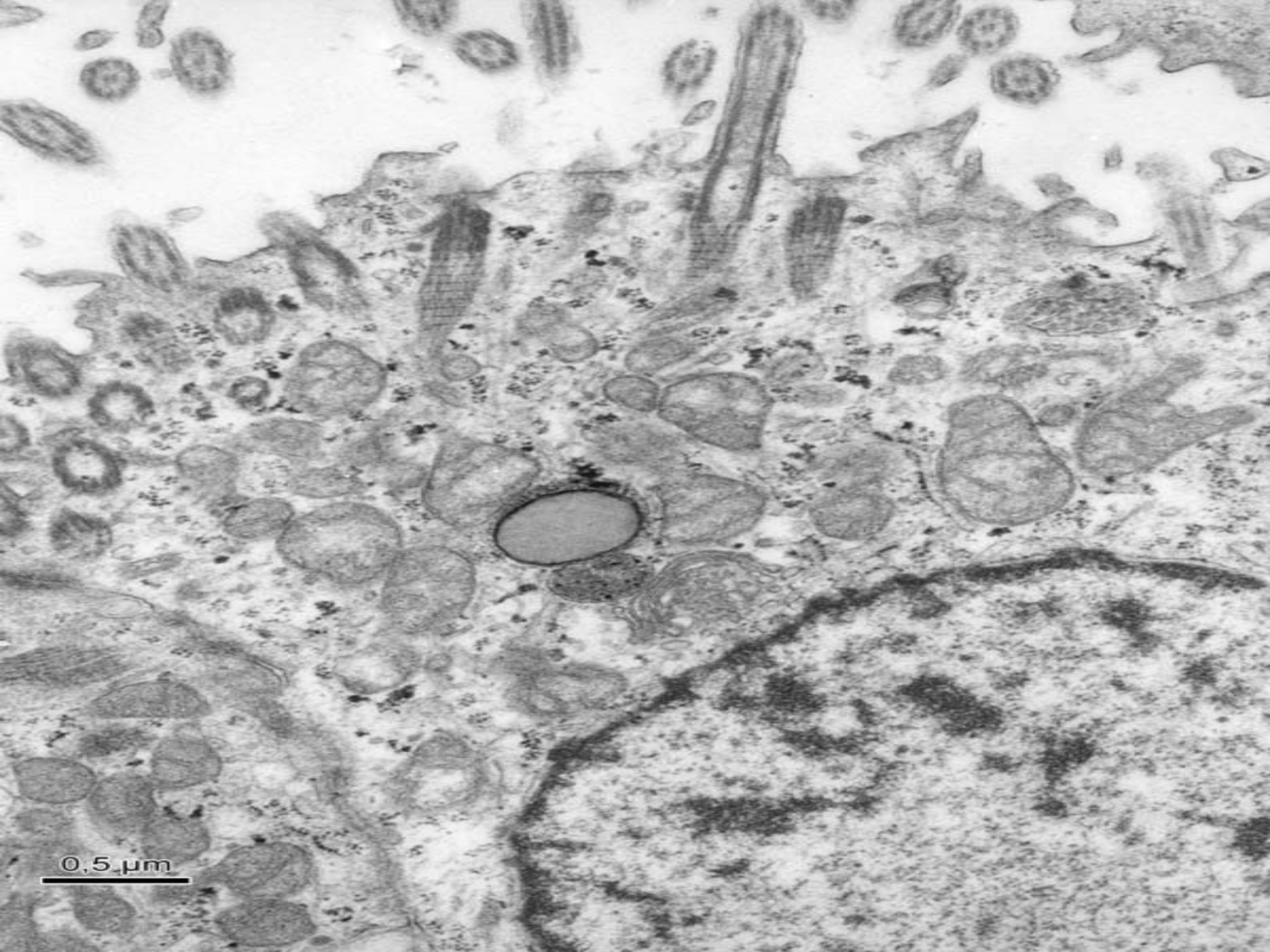

0.5 μm

Mezibuněčná spojení

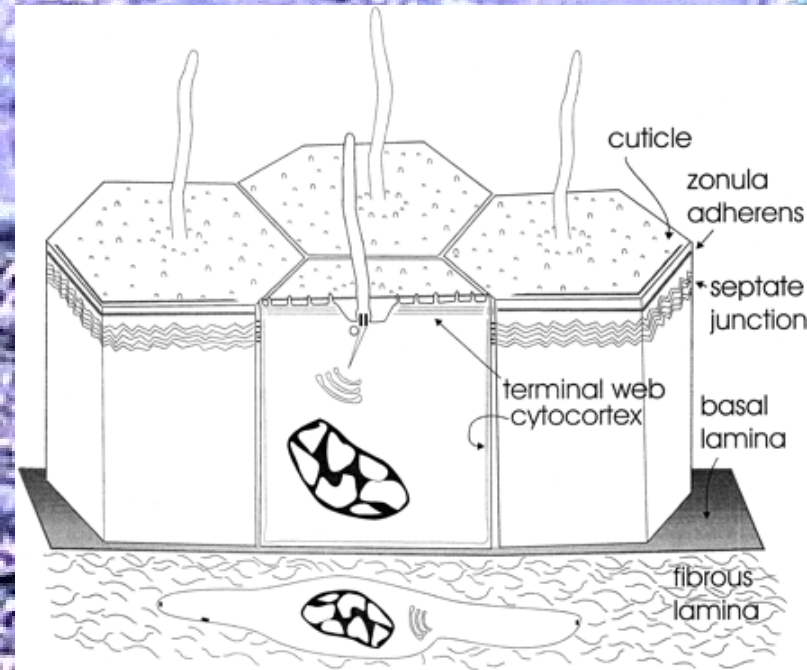
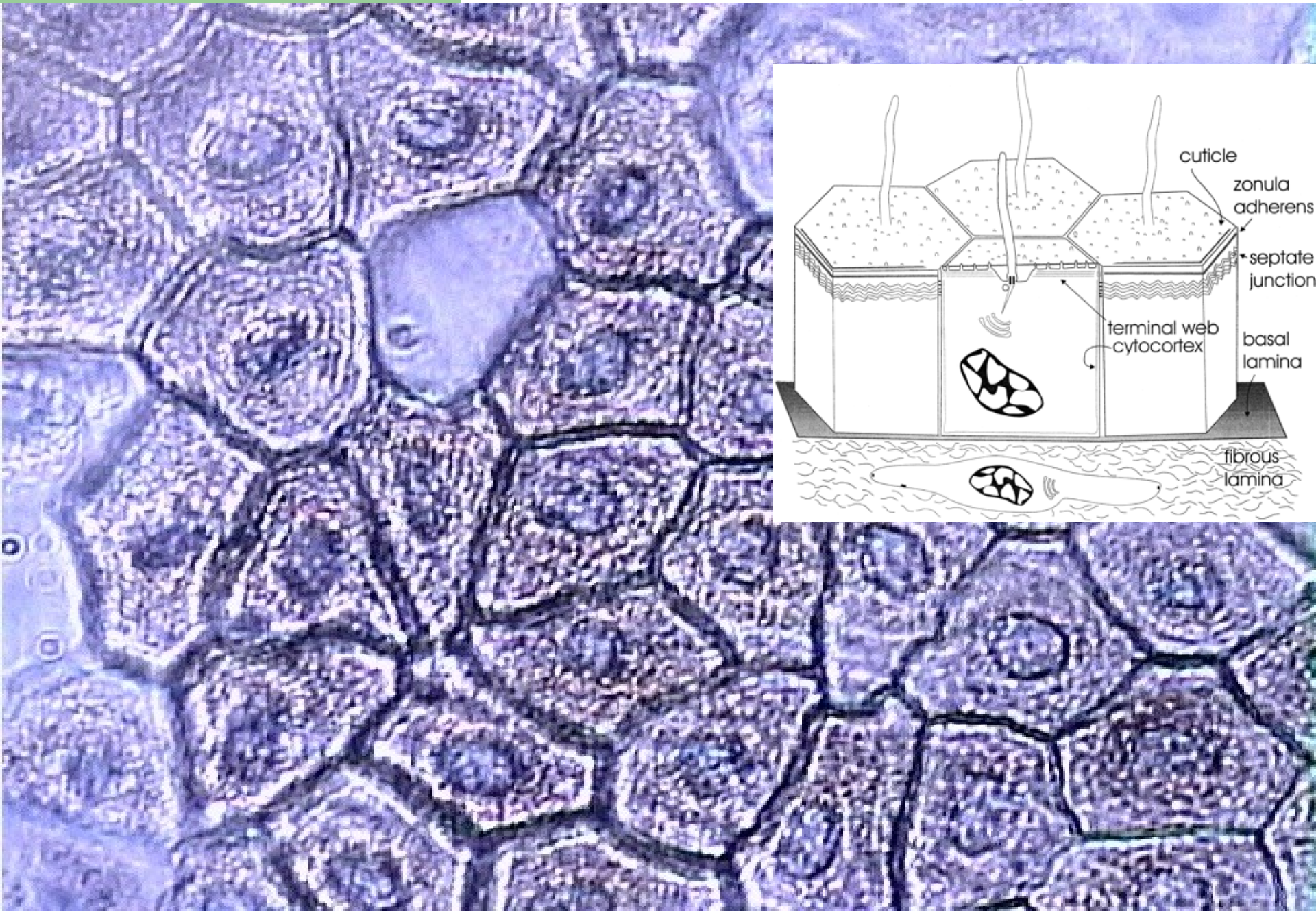

Laterální povrchy, intercelulární štěrbina (20 nm); zonulae a maculae

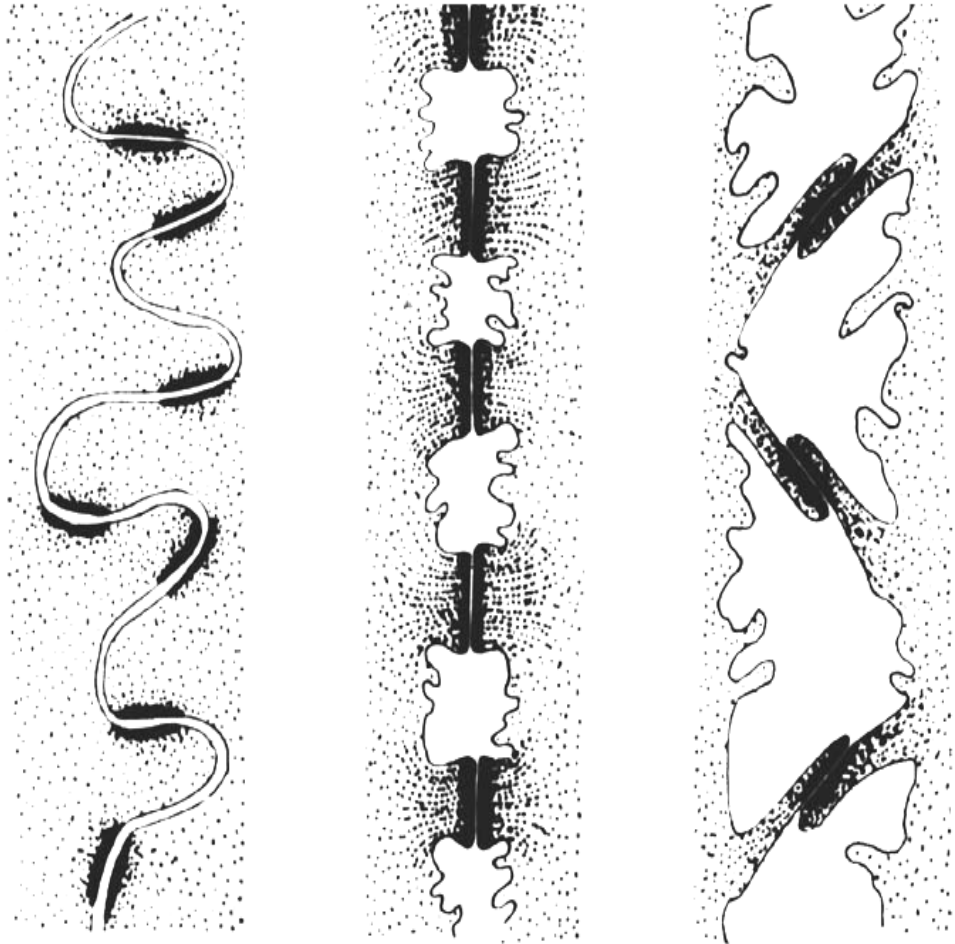

Šířka a tvar intercelulární štěrbiny

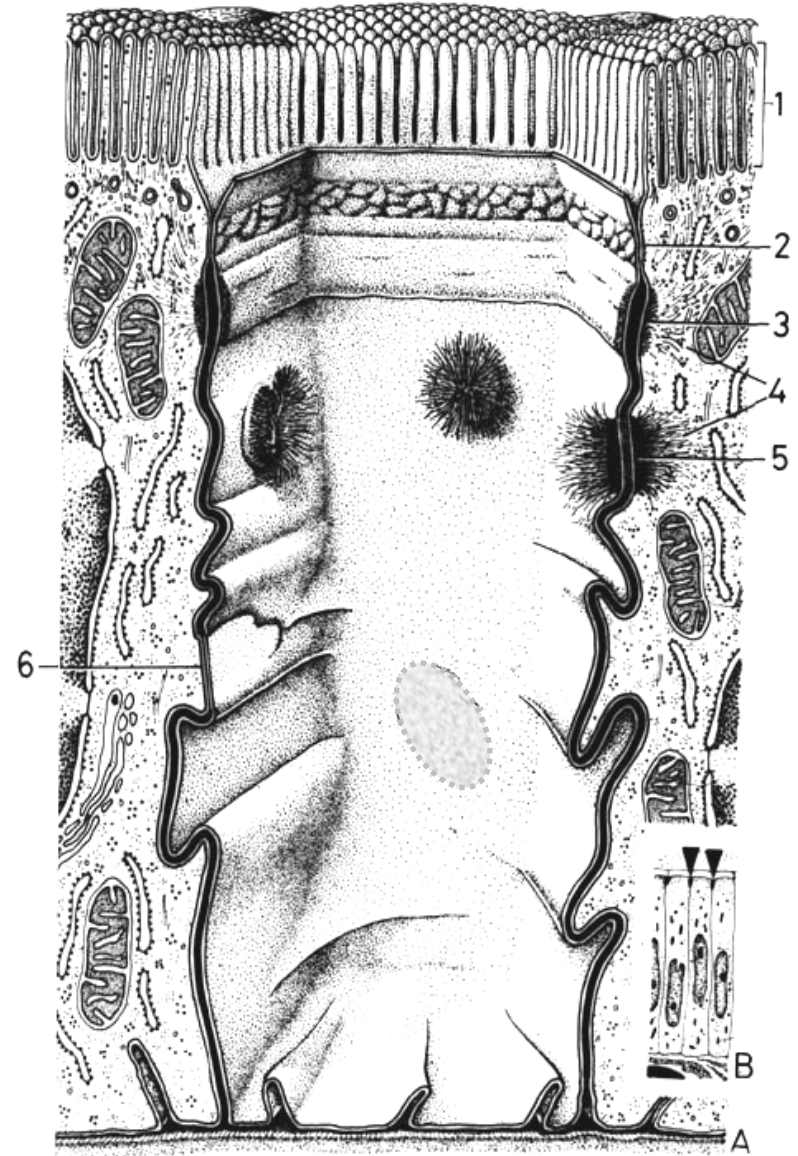

Intercelulární spoje

- těsná=okluzní: zonula occludens,
- adhezní: zonula adherens, dezmosom (macula adherens),
- komunikační: nexus (gap junction).

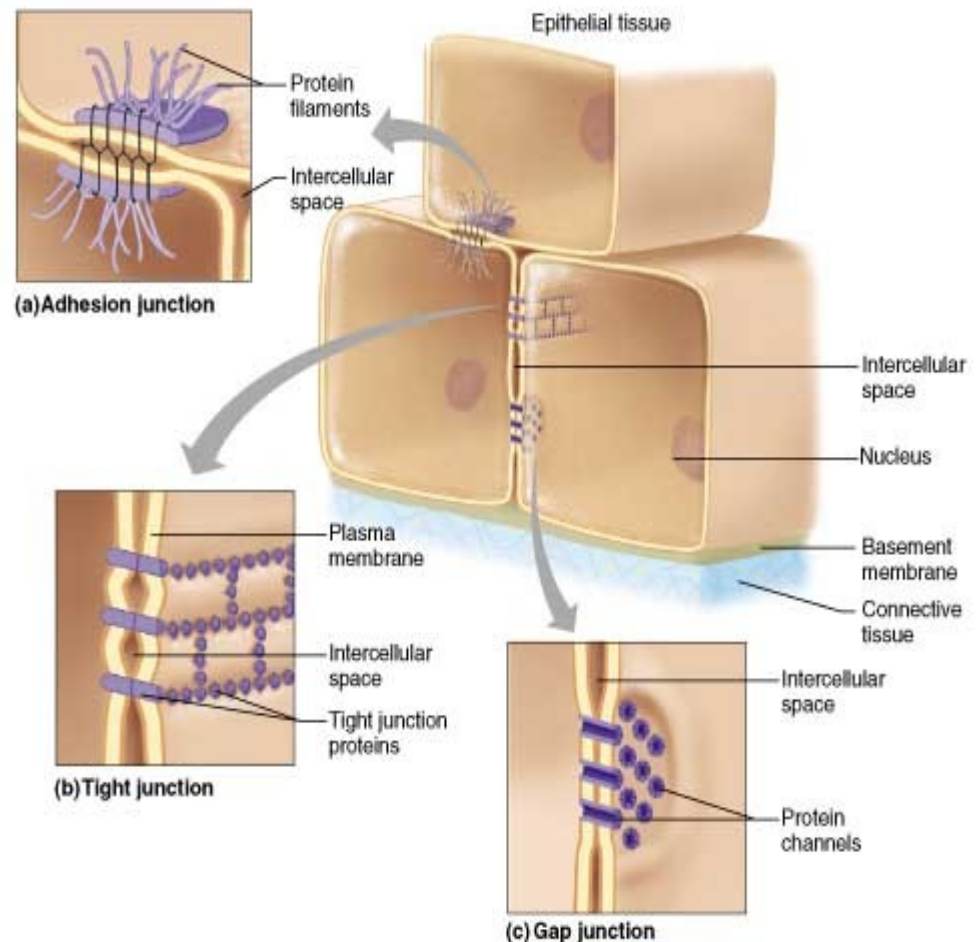

1. ZO, 2. ZA, 3. MA, 4. N

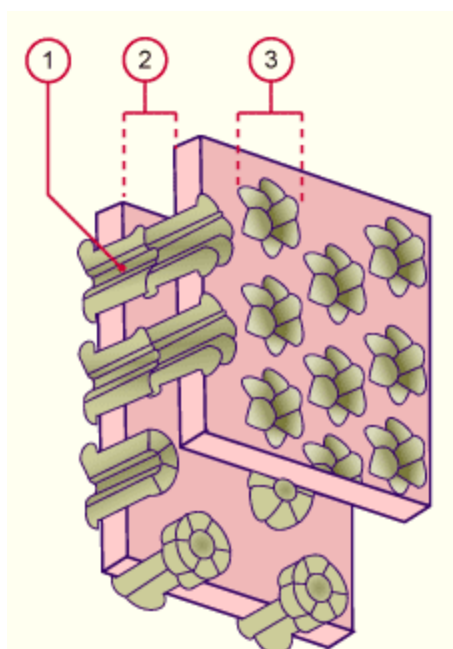
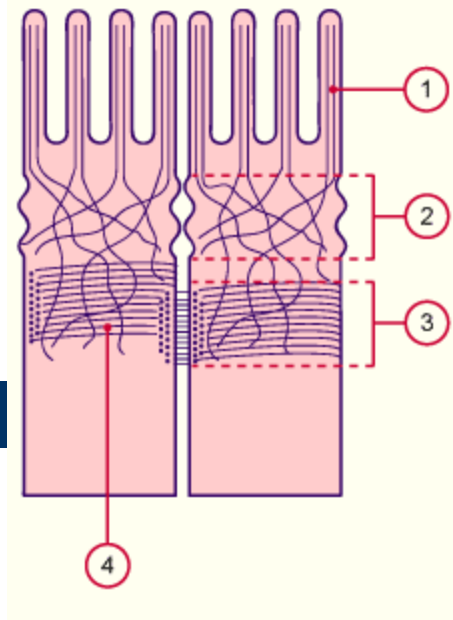
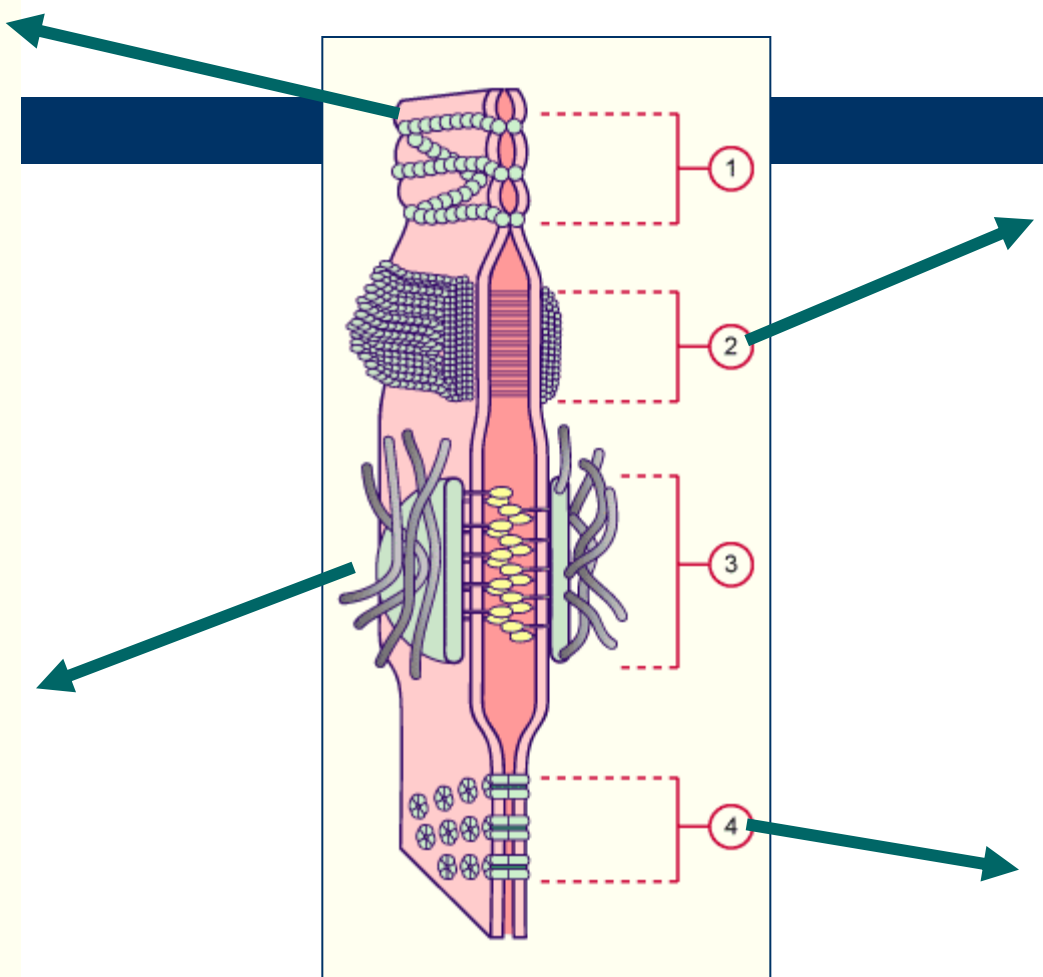
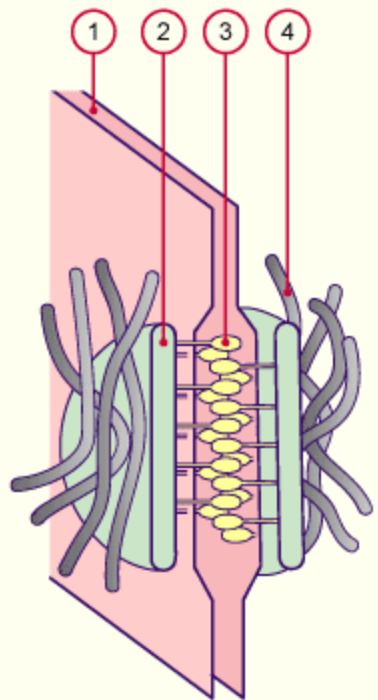
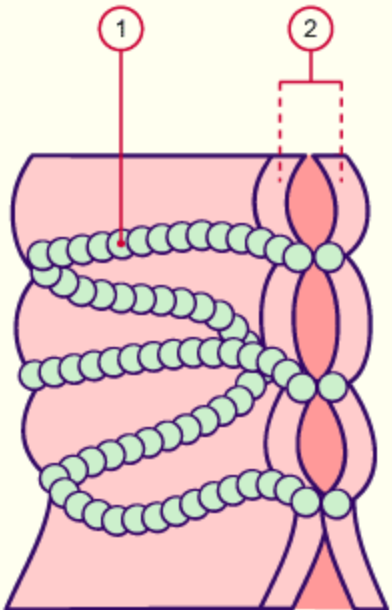

Zonula occludens

- Těsné pásovité spojení blízko apexu buňky
- Plazmalema sousedních buněk místy splývá (společné integrální proteiny – *klaudiny*, *okludiny*)
- Funkce: utěsnění intercelulární štěrbin

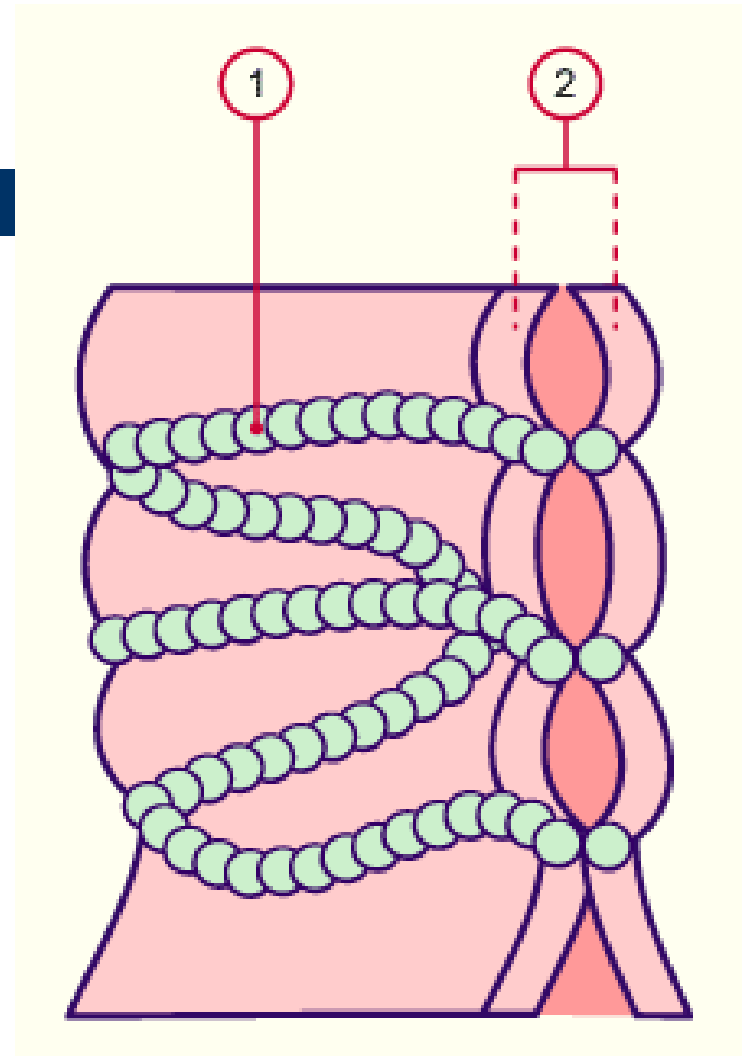

Defekt – porucha funkce hemoencefalické bariery u plodu – neurol. poruchy

Zonula adherens

- Pásovitý spoj kolem buňky
- Intercel. štěrbina – 20 nm, *kadheriny*
- Aktinová mikrofilamenta (Ø 6 nm)
- Funkce – adheze buněk

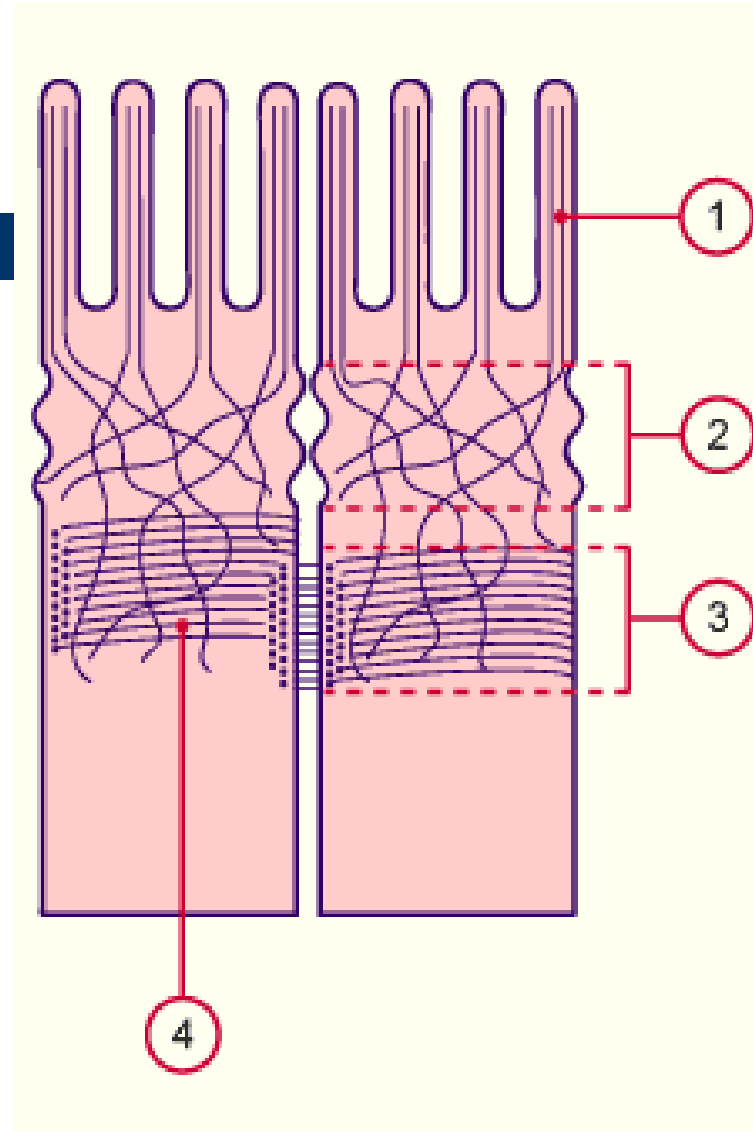

Defekt – šíření Tu buněk a zvýšení malignity Tu

Dezmosom (macula adherens)

- Diskovitý spoj (\varnothing 0,3-0,5 μm)
- Intercel. štěrbina – 40 nm;
el.denzní materiál, *desmoglein*(3)
tonofilamenta (cytokeratin, (4) \varnothing
8-10 nm), a desmoplakin (2) v
el.denzní ploténce
- Funkce - adheze

Defekt – porucha adheze kožních buněk,

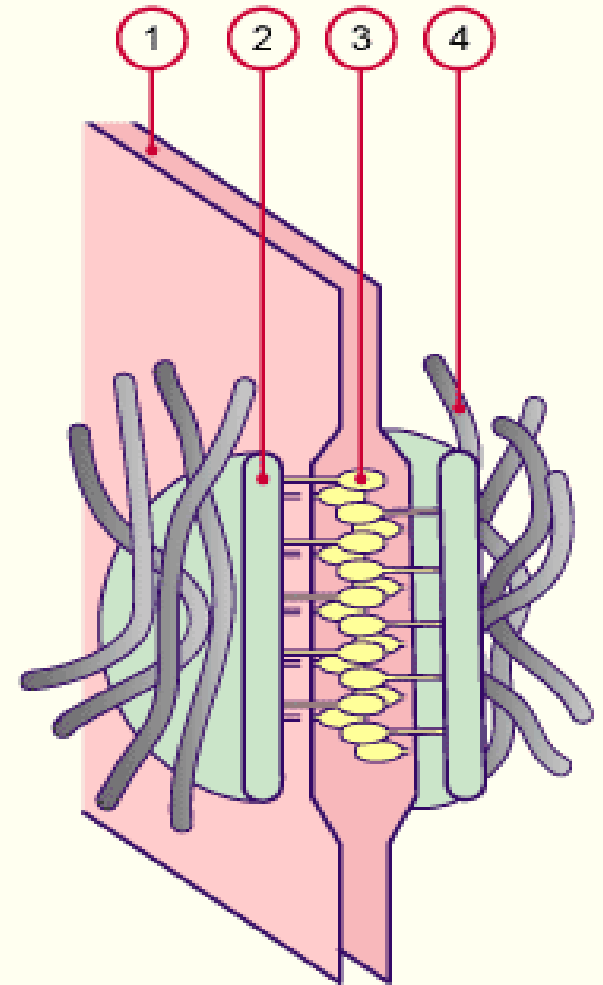

Nexus (gap junction)

- Plošný „kanálkovitý“ spoj
- Interceľ. šterbina – 2 nm
- Funkce - komunikace

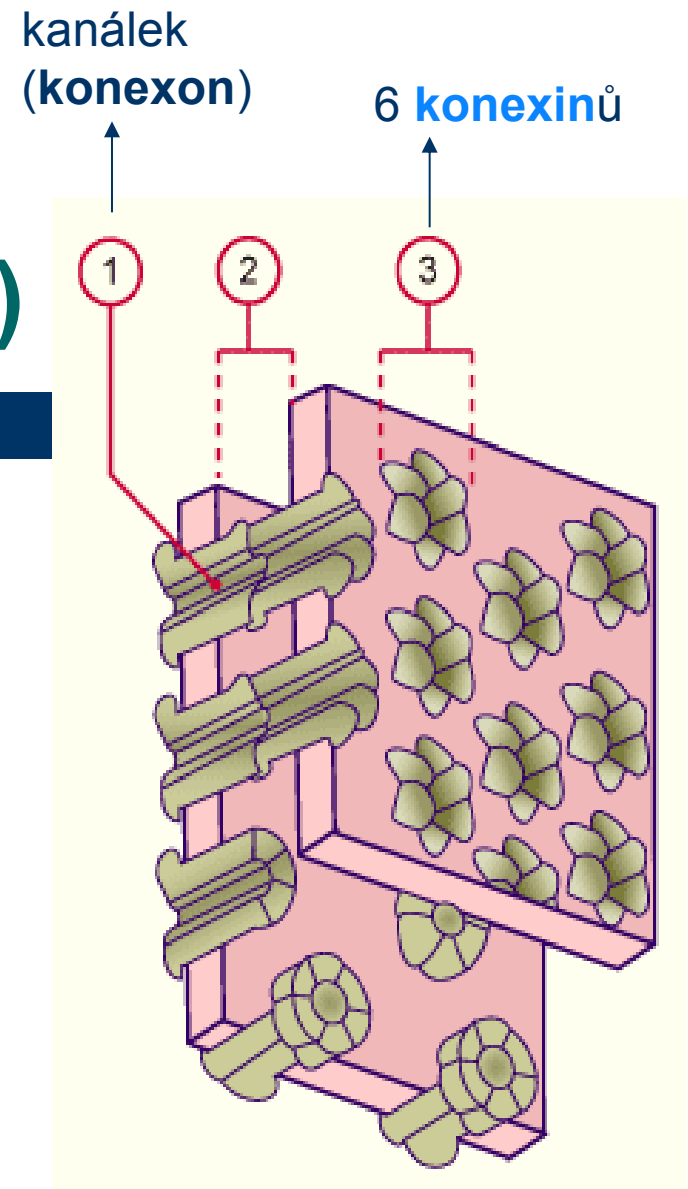

Defekt – periferní neuropatie, hluchota

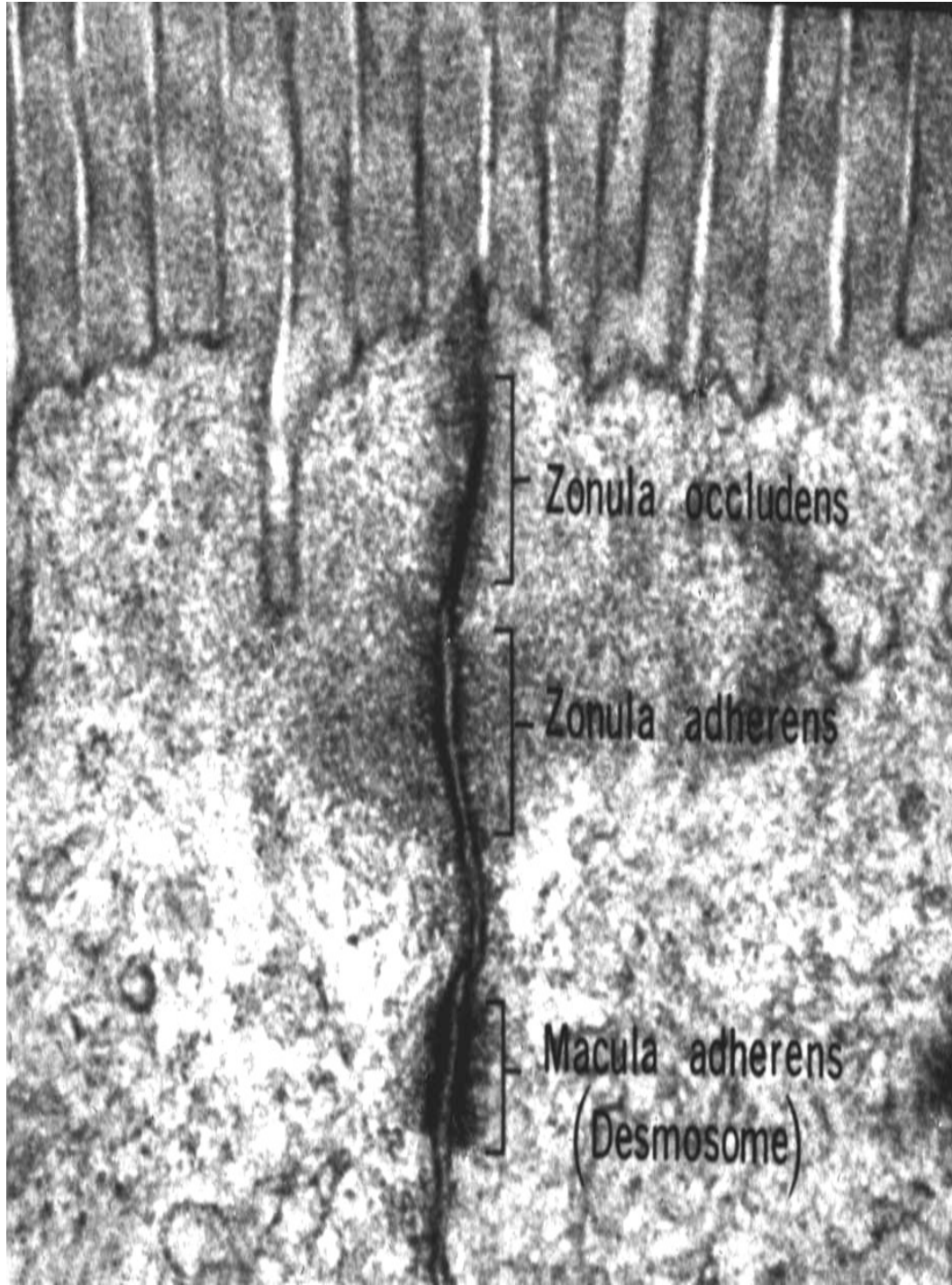
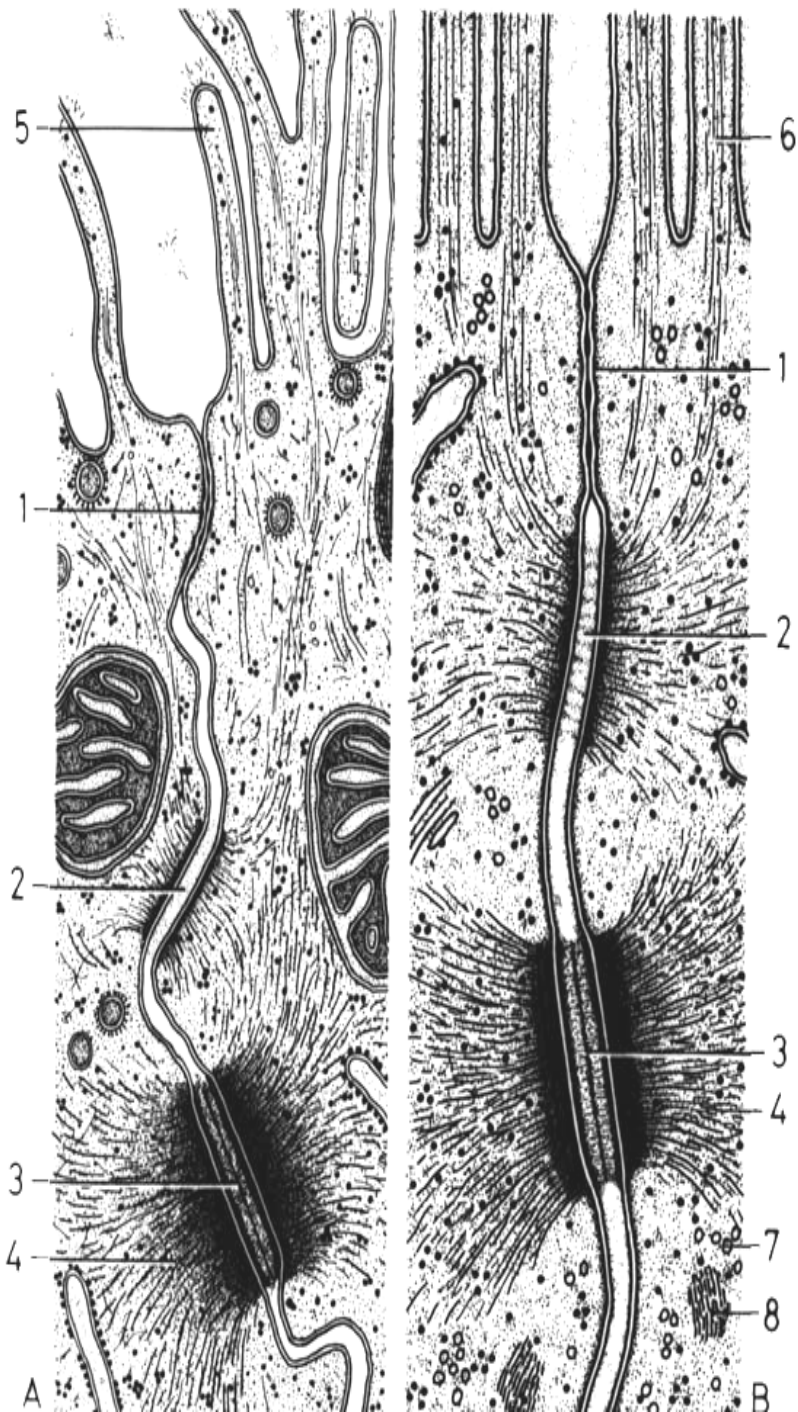

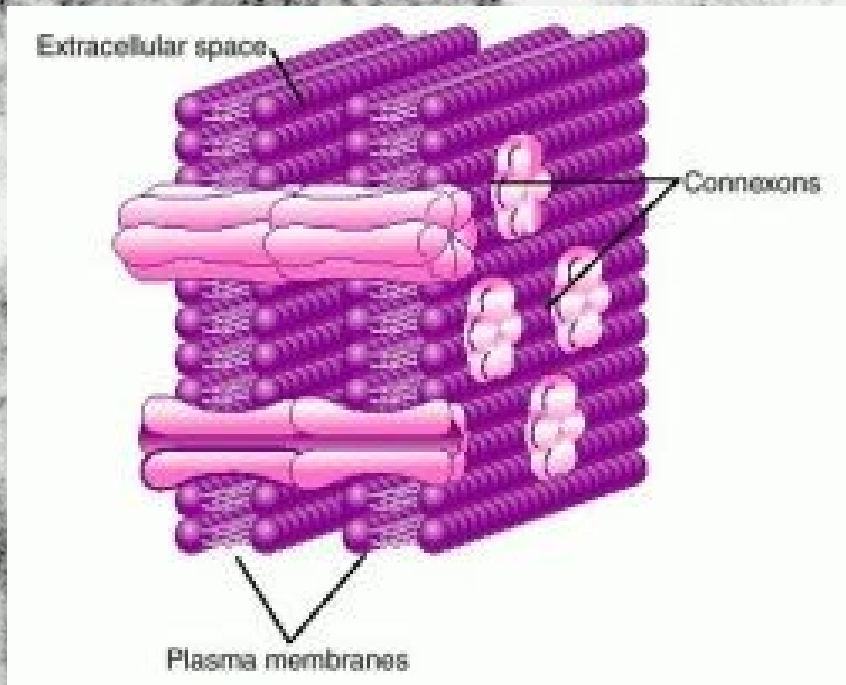
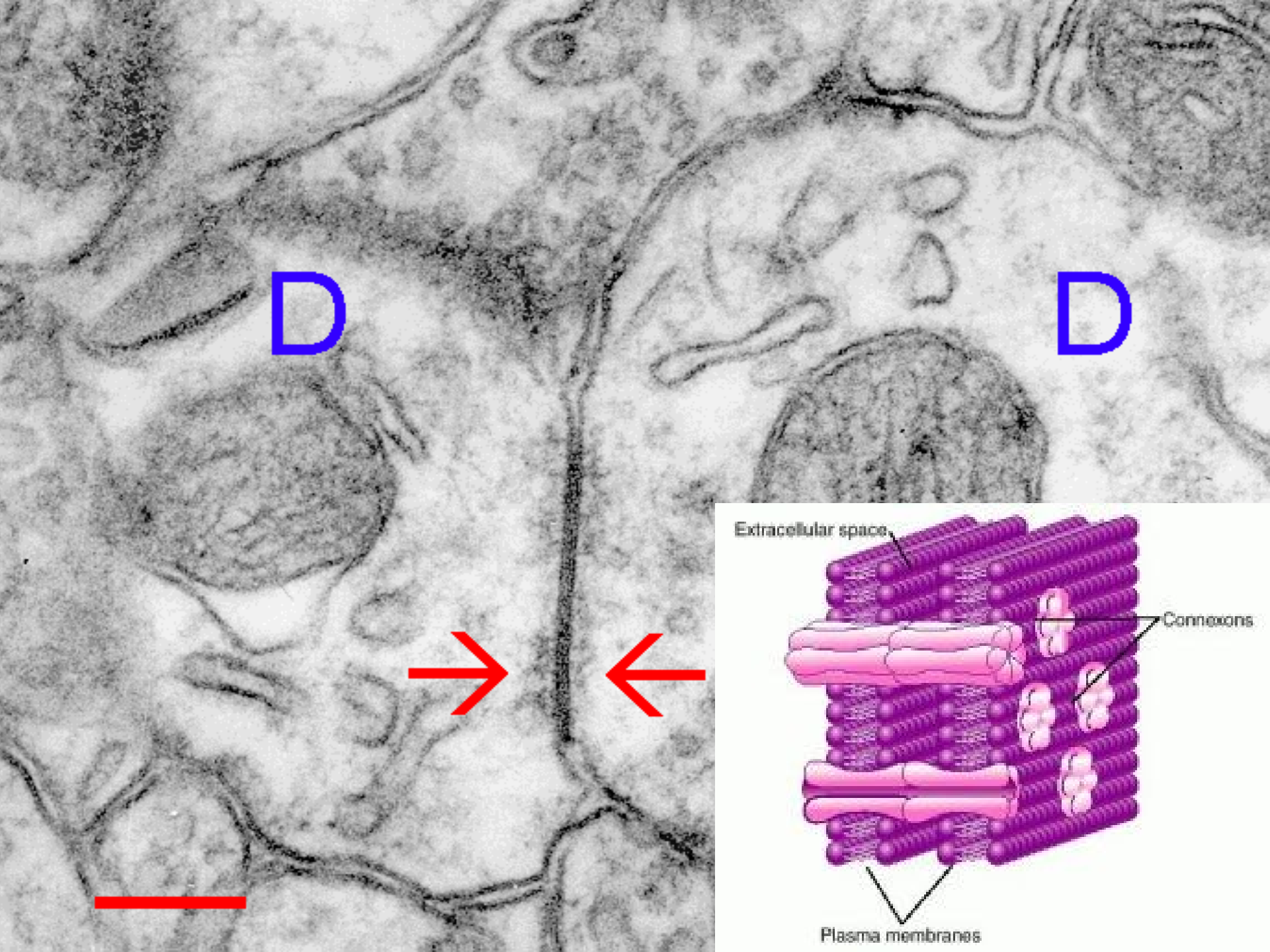

Mezibuněčná spojení - speciality

- **Fascia adherens** – v myokardu, obsahují rozsáhlé dezmosomy a nexusy
- **Spojovací komplex** – kombinace spojů *zonula occludens* (těsnost, pás), *zonula adherens* a *dezmosomů* (pevnost); od apexu k bázi v tomto pořadí, cylindrický epitel
- **Buněčné interdigitace** – na laterální straně buněk, zvětšení povrchu, buňky transportující vodu



Bazální povrch

- přivrácen k buňce (*viz výše – laterální povrch, vrst. epitelu*)
- přivácen k lamina basalis:
hemidesmosomy *bazální labyrint*

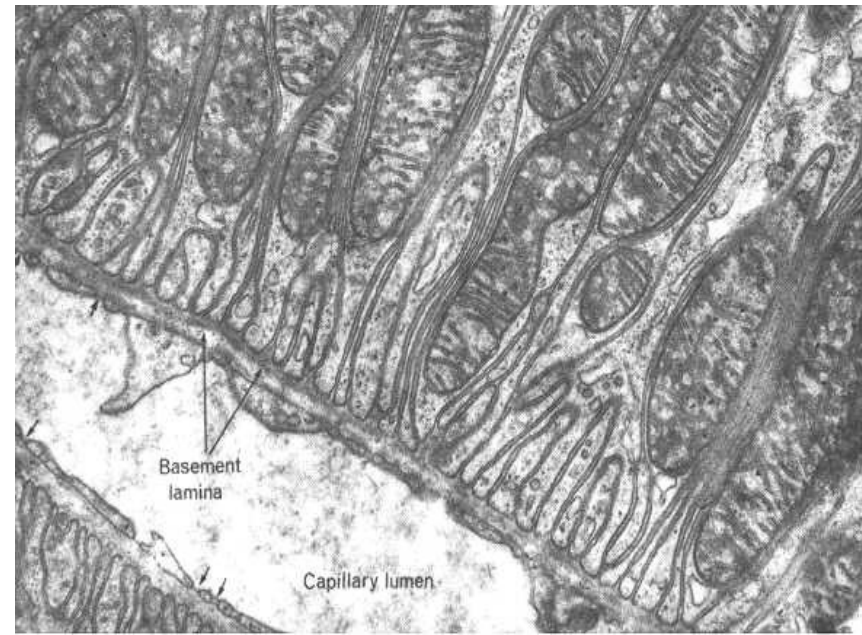
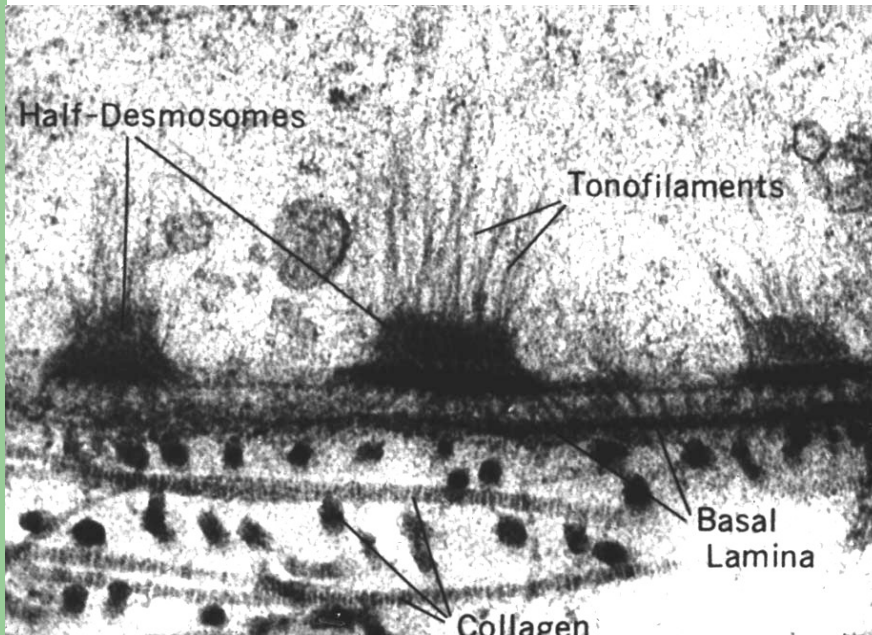

Životní projevy buňky

- **pohyb** (intracelulární, ameboidní, bičíky a řasinky)
- **výměna látek** (příjem, metabolismus, výdej)
- **dráždivost**
- **růst**
- **rozmnožování – mitóza, meióza**
- **smrt – apoptóza, nekróza**

transportní látek v buňce

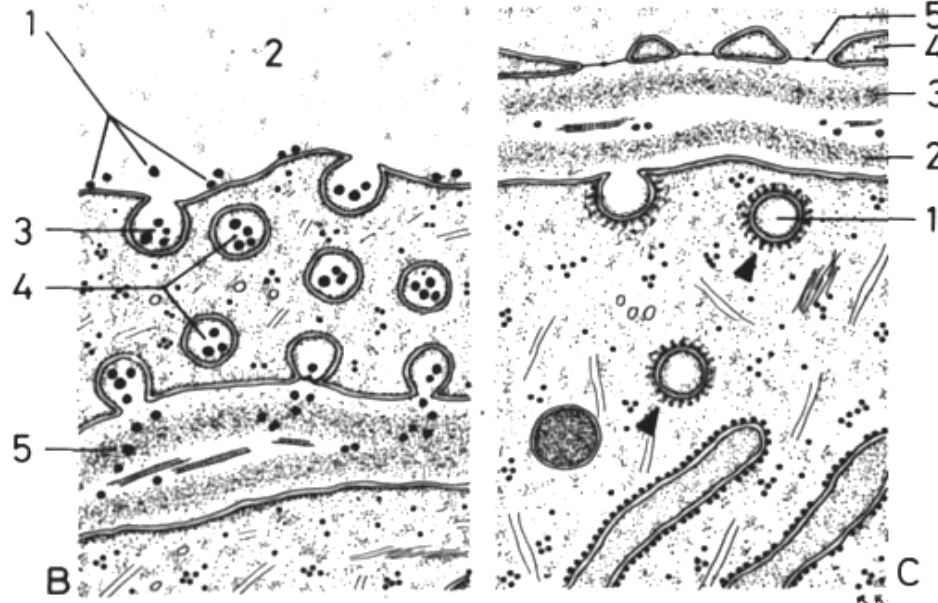
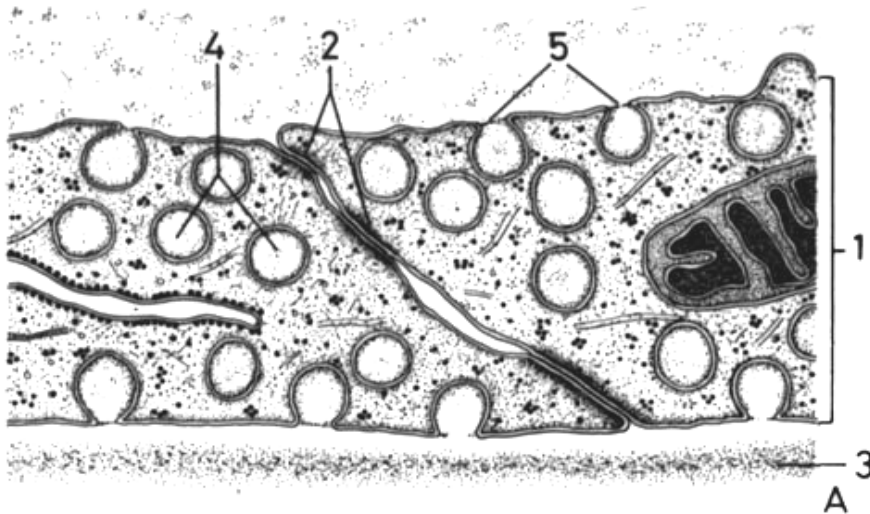

Endocytóza → fagocytóza
→ pinocytóza

*nespecif.
pinoctárními
váčky*

*specif.
„coated
vesicles“*

Exocytóza – sekrece
kontinuální a regulovaná

fagocytóza

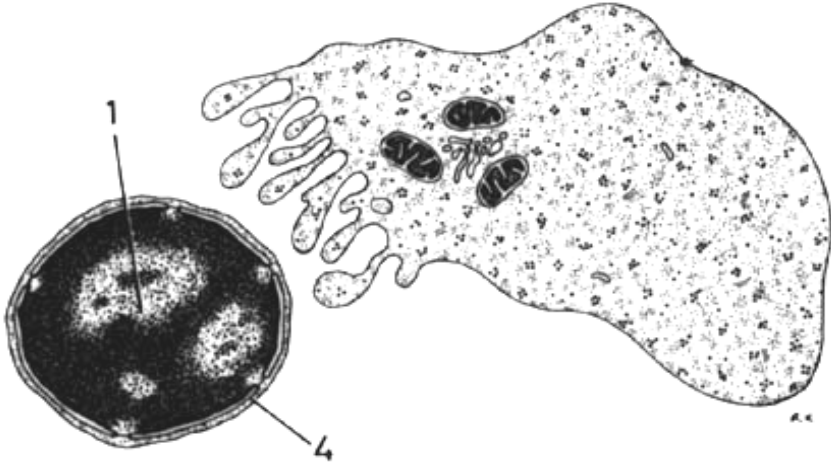
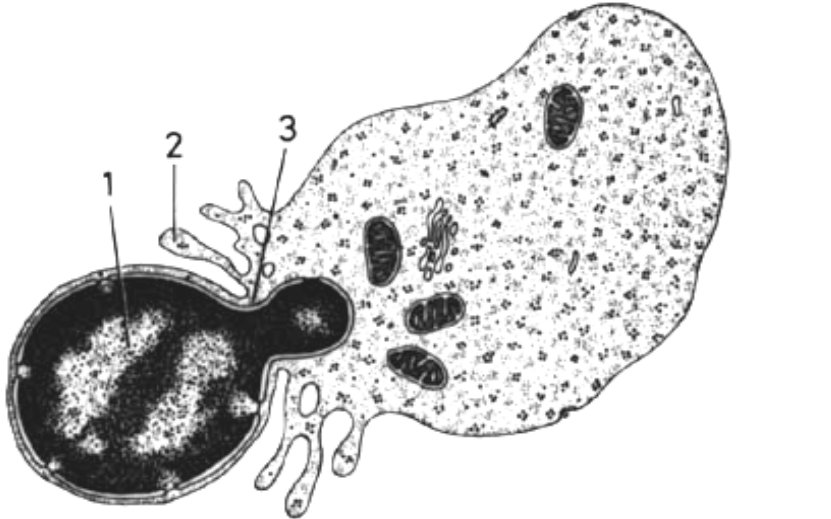

Final stage of apoptosis

White blood cell

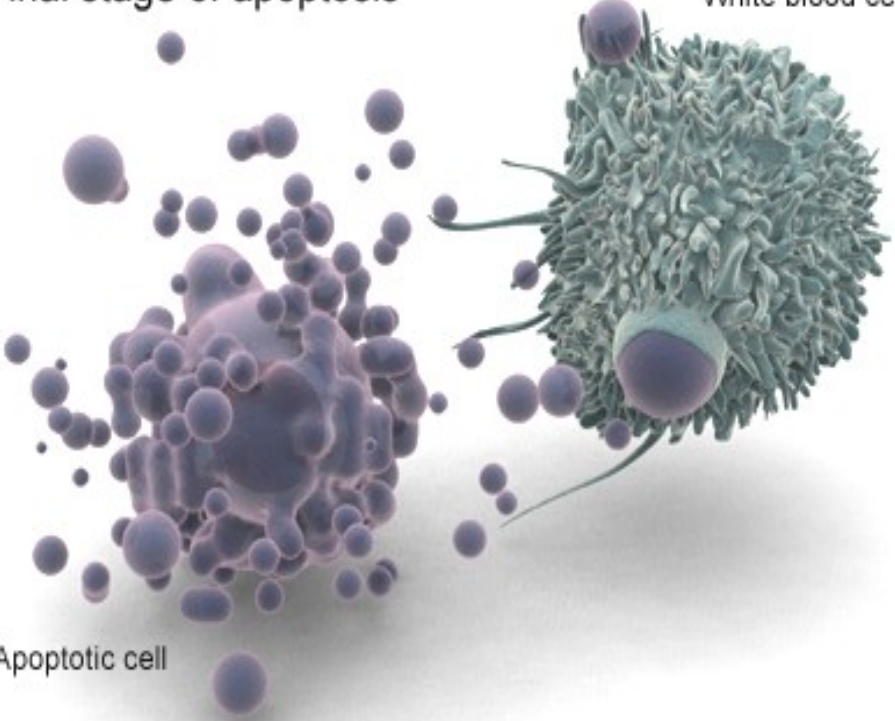

Apoptotic cell