

Counter-Current System Regulation of Renal Functions

Assoc. Prof. MUDr. Markéta Bébarová, Ph.D.

Department of Physiology

Faculty of Medicine, Masaryk University



This presentation includes only the most important terms and facts. Its content by itself is not a sufficient source of information required to pass the Physiology exam.



Water Transport in Tubules

GFR 180 l/day

UFR ~1 l/day

UFR 0.5 l/day
(1400 mosm/l)

up to

UFR 23.3 l/day
(30 mosm/l)

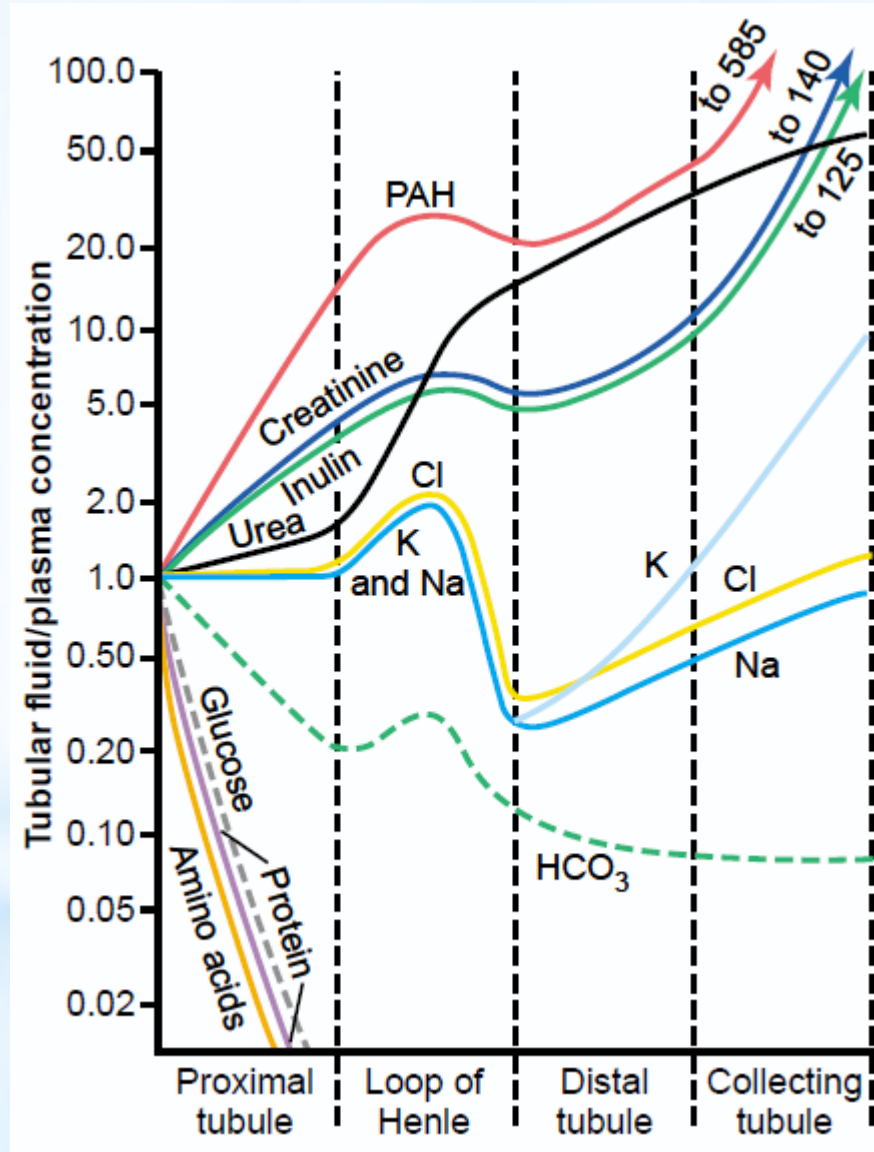

substances with pronounced secretion in comparison with H₂O

substances with pronounced reabsorption in comparison with H₂O

Guyton & Hall. Textbook of Medical Physiology

Water Transport in Tubules

Proximal Tubule

Intensive transport of solutes from tubules to interstitium -
osmotic gradient - water reabsorption

Facilitated by water channels (aquaporin 1; not guided by ADH!)



Isoosmotic fluid, volume notably decreased (60-70% of solutes and water reabsorbed)

Water Transport in Tubules

Loop of Henle

- 1) **thin descending part** - passive reabsorption of water (osmosis)
- 2) **thick ascending part** – impermeable for water, intensive reabsorption of solutes



Hypotonic fluid, volume decreased

Water Transport in Tubules

Distal Tubule

- 1) the first part – **analogical to the thick ascending loop of Henle** – impermeable for water, reabsorption of solutes (reabsorption of Na^+ regulated by aldosteron)
- 2) the next part – **analogical to the cortical part of collecting duct** – water reabsorption regulated by ADH (aquaporin 2)



Tonicity of the outflowing fluid **depends on the actual level of ADH.**

Water Transport in Tubules

Collecting Duct

- 1) **the cortical part** – water reabsorption regulated by ADH (aquaporin 2), isotonic intersticium
- 1) **the medullar part** – water reabsorption regulated by ADH (aquaporin 2), hypertonic intersticium



Tonicity of the outflowing fluid **depends on the actual level of ADH.**

Counter-Current System in Kidneys

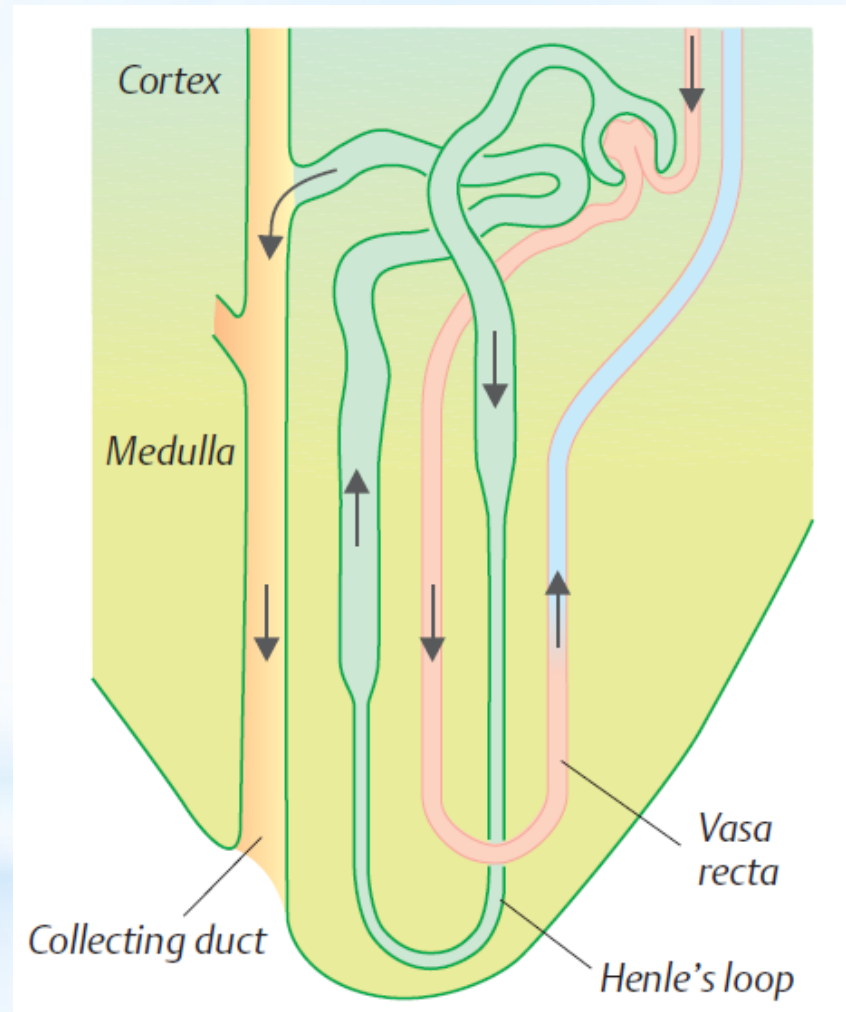

Despopoulos, Color Atlas of Physiology © 2003

Counter-Current System in Kidneys

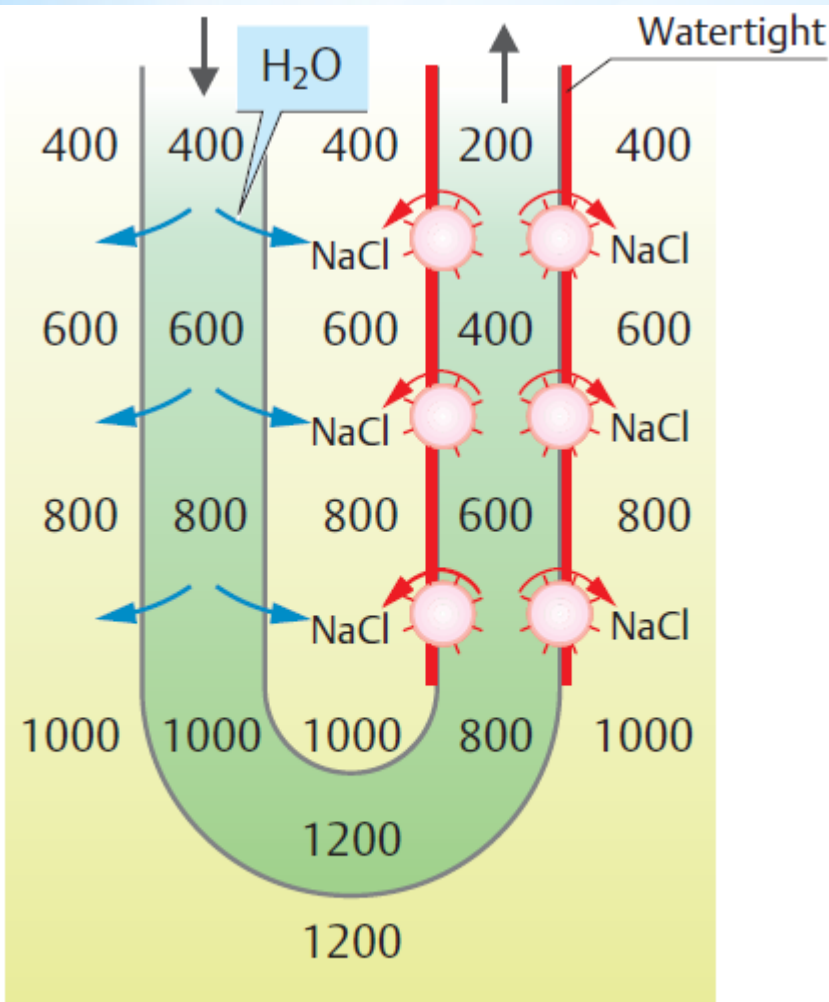

5 Countercurrent multiplier (Henle's loop)

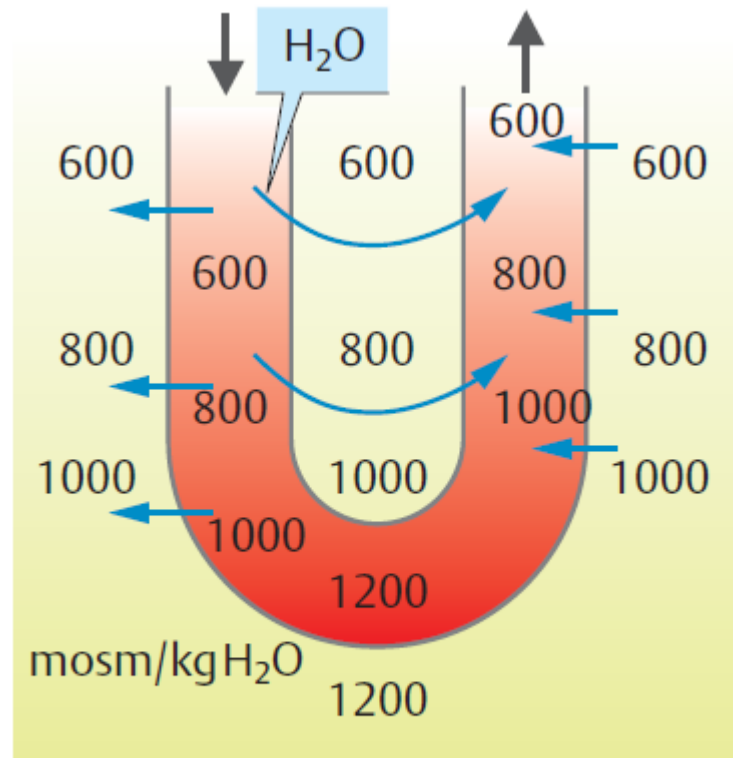

4 Countercurrent exchange (water) in loop (e.g. vasa recta)

Counter-Current System in Kidneys

Hyperosmotic Renal Medulla - Role of Loop of Henle

- 1) Active transport of Na^+ , co-transport of Na^+ with K^+ and Cl^- from ascending loop of Henle; **gradient even 200 mOsm/l**
- 2) Impermeability of ascending loop of Henle for water

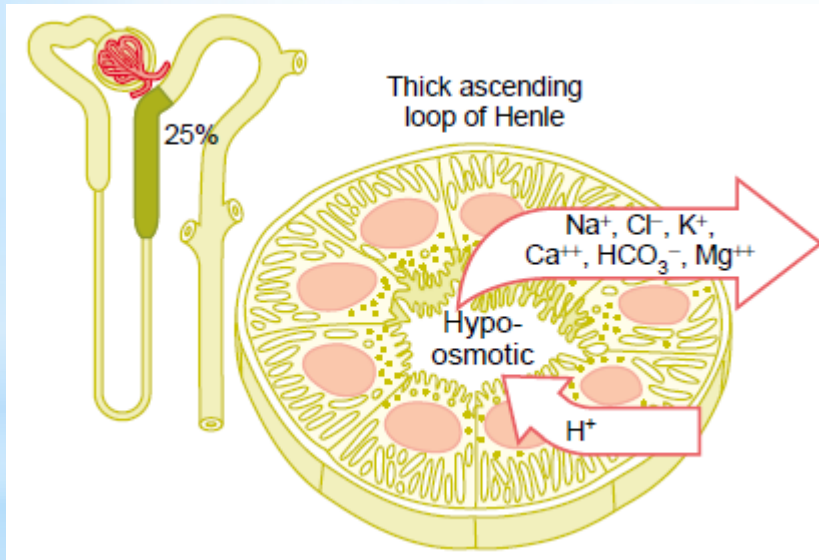

Guyton & Hall. Textbook of Medical Physiology

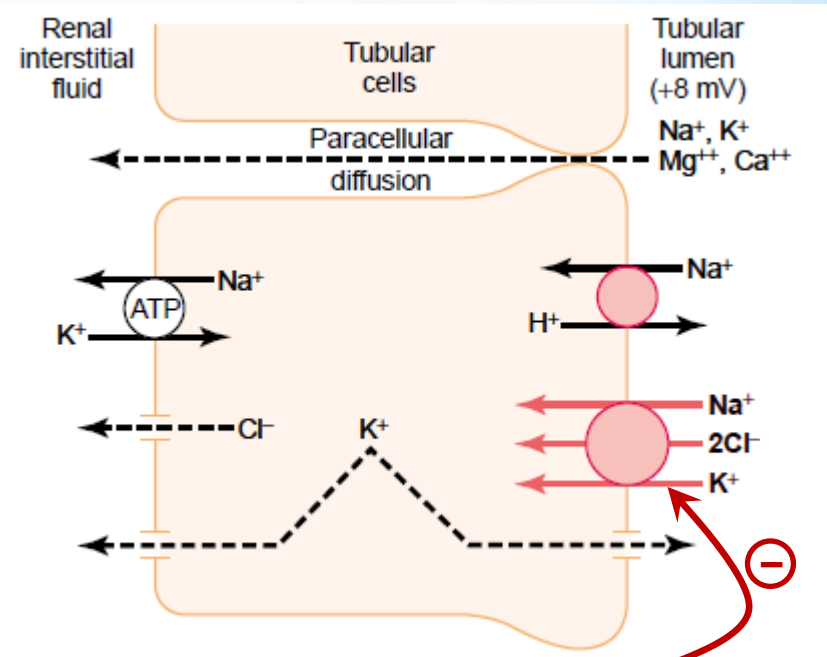

diuretics (e.g. furosemid)

Counter-Current System in Kidneys

Hyperosmotic Renal Medulla - Role of Loop of Henle

- 1) Active transport of Na^+ , co-transport of Na^+ with K^+ and Cl^- from ascending loop of Henle; **gradient even 200 mOsm/l**
- 2) Impermeability of ascending loop of Henle for water
- 3) Permeability of descending loop of Henle for water

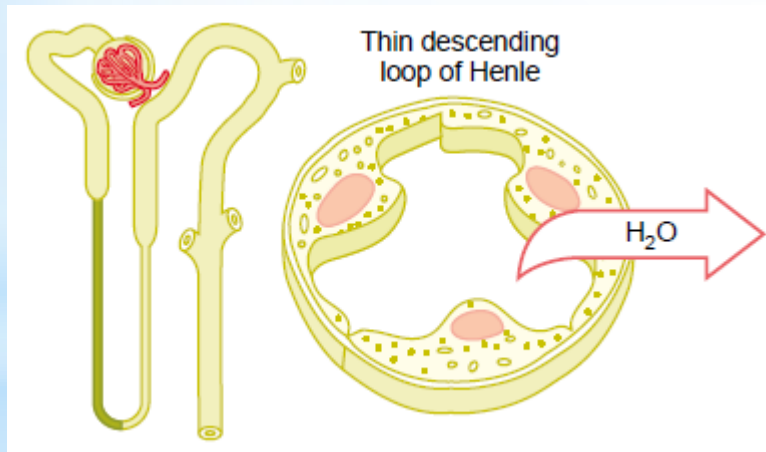

Guyton & Hall. Textbook of Medical Physiology

Counter-Current System in Kidneys

Hyperosmotic Renal Medulla - Role of Loop of Henle

- 1) Active transport of Na^+ , co-transport of Na^+ with K^+ and Cl^- from ascending loop of Henle; **gradient even 200 mOsm/l**
- 2) Impermeability of ascending loop of Henle for water
- 3) Permeability of descending loop of Henle for water

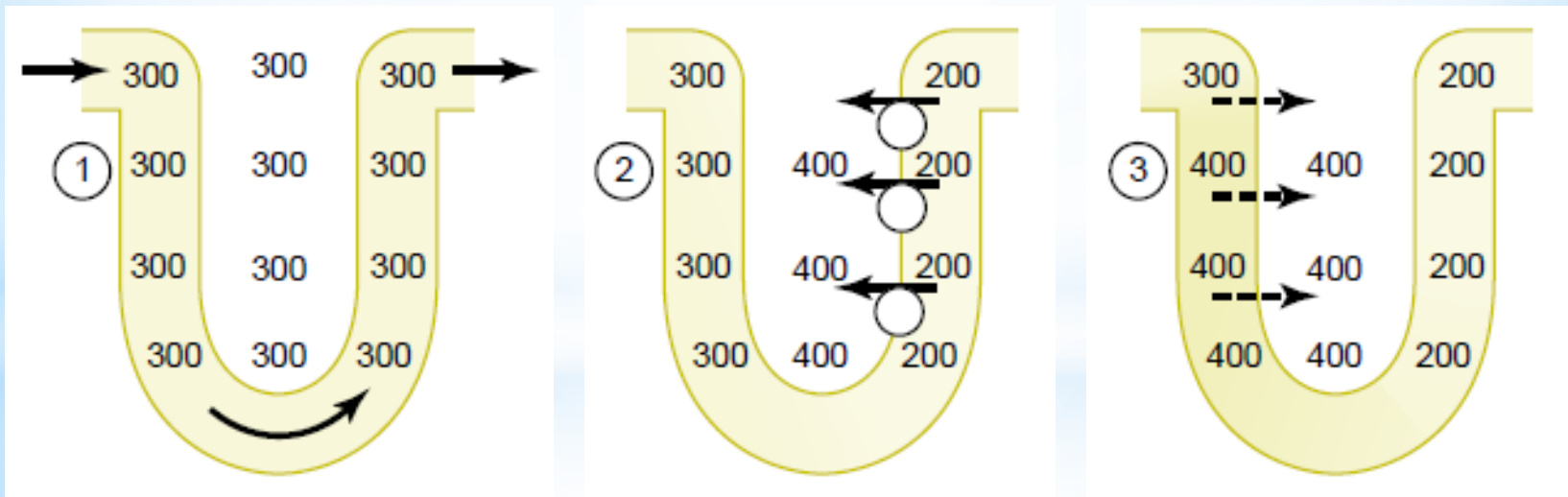

Guyton & Hall. Textbook of Medical Physiology

Counter-Current System in Kidneys

Hyperosmotic Renal Medulla - Role of Loop of Henle

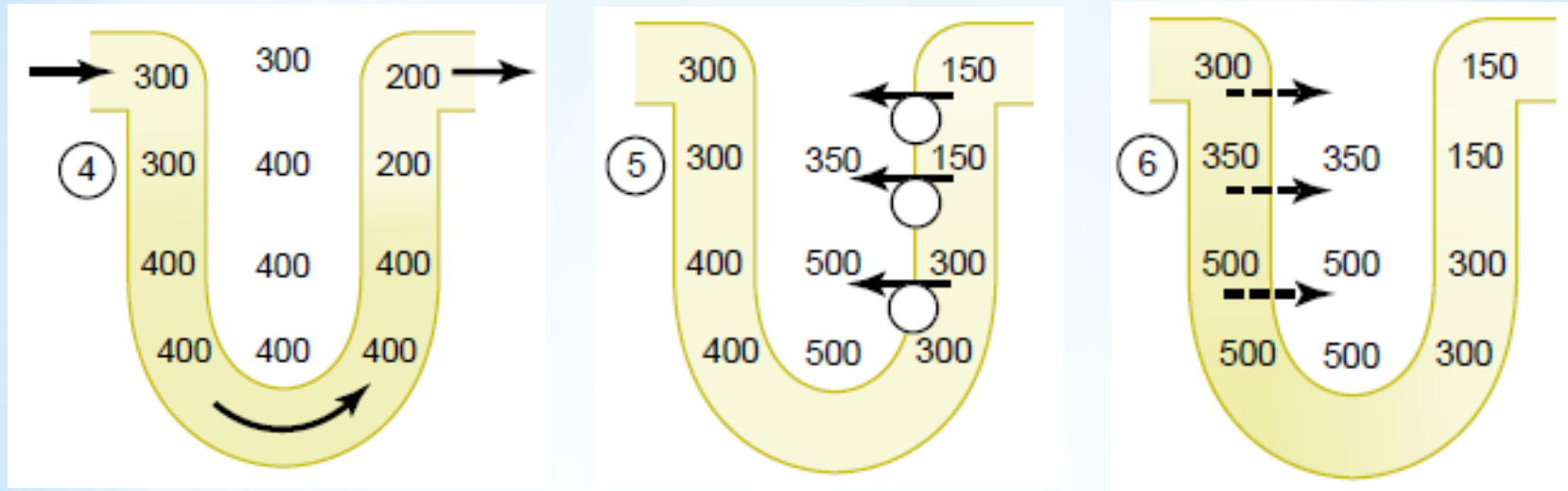

Guyton & Hall. *Textbook of Medical Physiology*

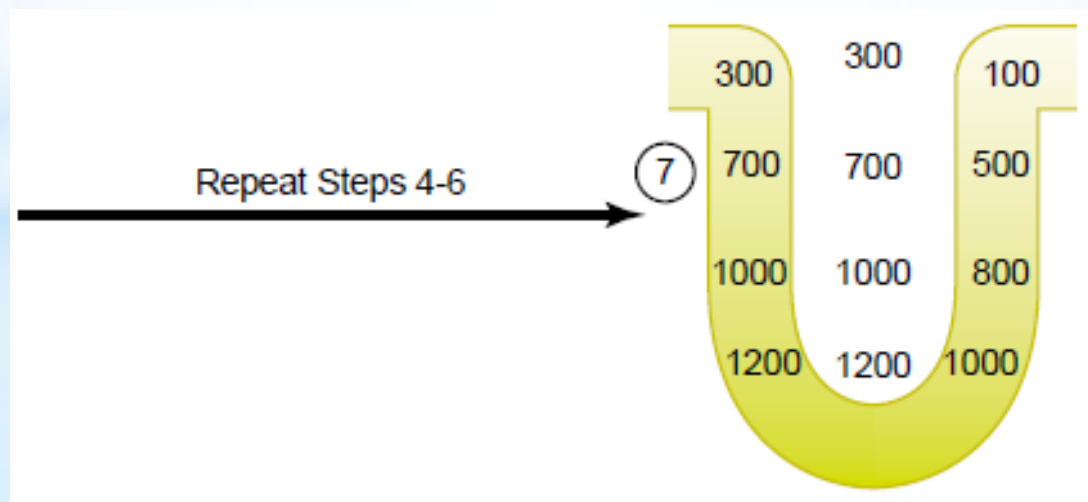

Counter-Current System in Kidneys

Hyperosmotic Renal Medulla - Role of Vasa Recta

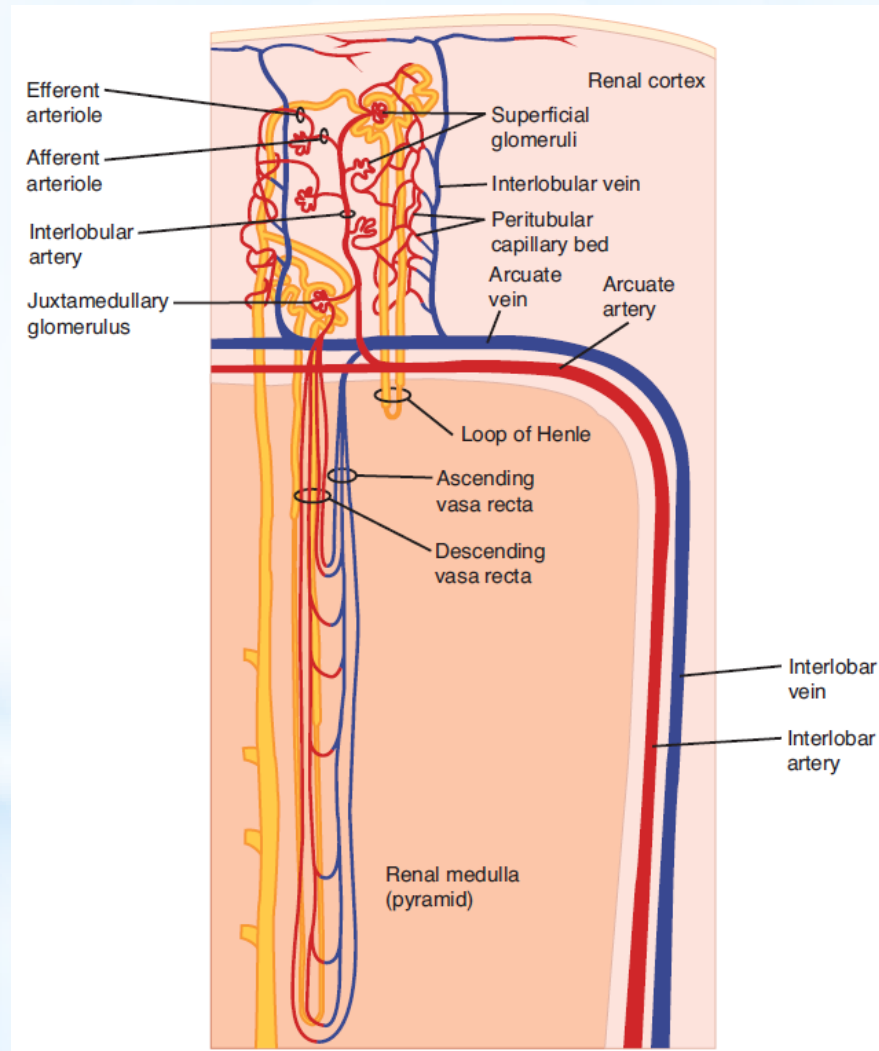

Ganong's Review of Medical Physiology, 23rd edition

Counter-Current System in Kidneys

Hyperosmotic Renal Medulla - Role of Vasa Recta

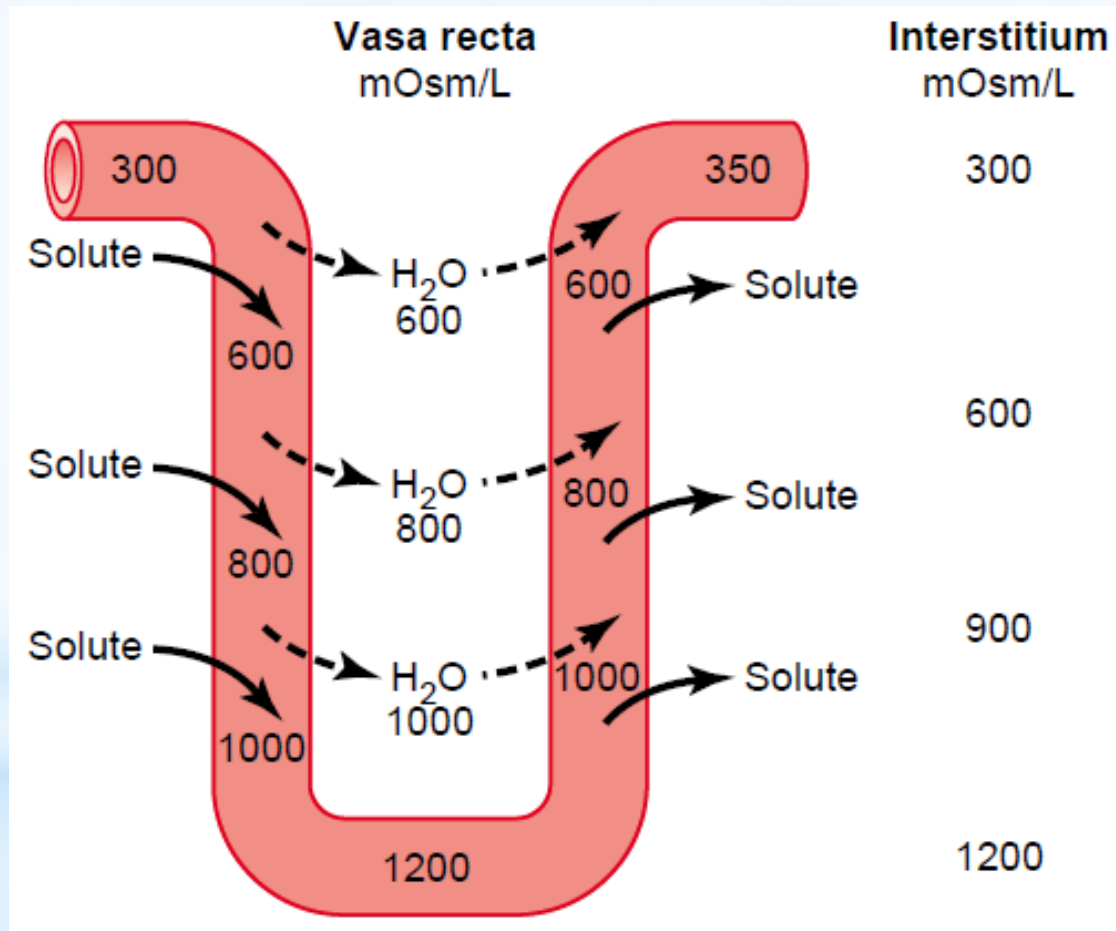

Guyton & Hall. Textbook of Medical Physiology

Counter-Current System in Kidneys

Hyperosmotic Renal Medulla - Role of Urea

passive transport

following parts of tubulus resistant to urea reabsorption

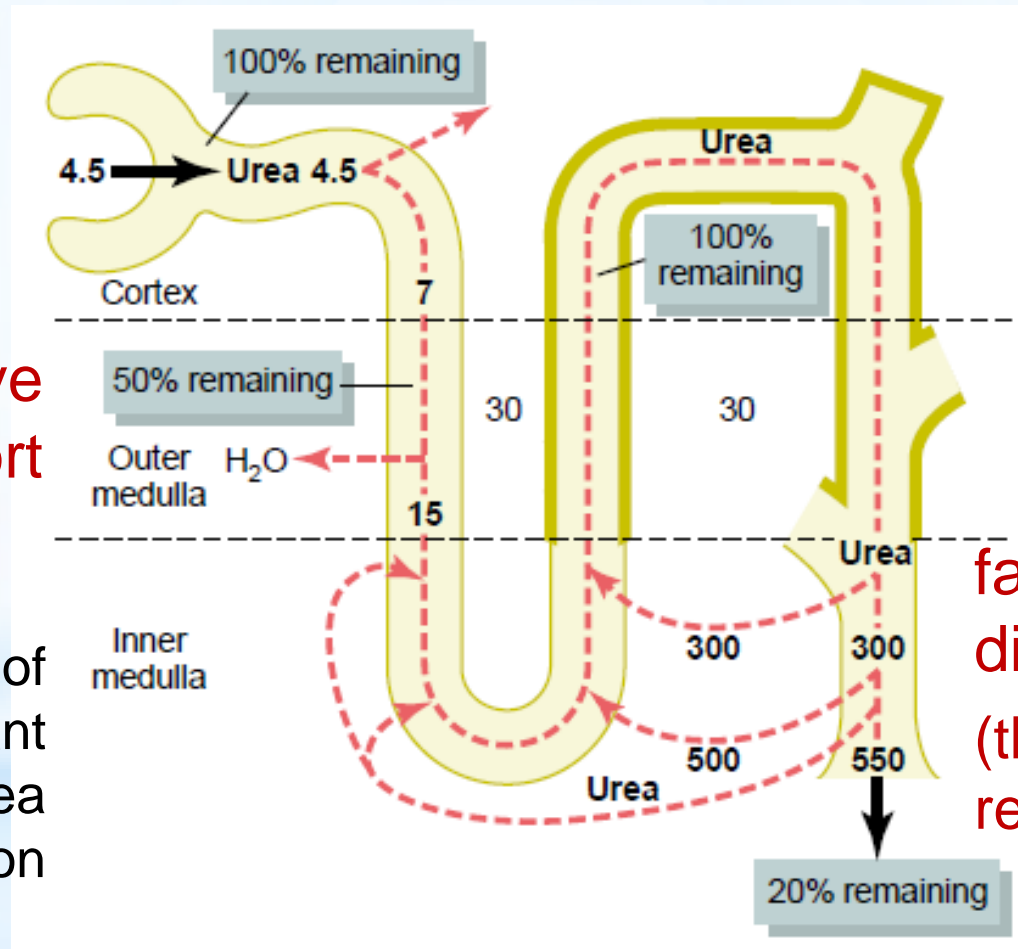

facilitated diffusion
(through UT-A1 - regulated by ADH)

Water Diuresis

- after drinking of a higher amount of hypotonic fluid
- drinking itself → slightly ↓ ADH secretion
- water reabsorption → ↓ plasma osmolarity –
osmoreceptors in the hypothalamus → notable ↓
ADH secretion → ↓ water reabsorption in tubulus
→ ↑ diuresis

Water Diuresis

Water Intoxication

- the water intake per time $>$ the amount of water which can be excreted (maximal diuresis ~ 16 ml/min)
- \rightarrow **cellular edema, symptoms of water intoxication**
- iatrogenic

Osmotic Diuresis

- induced by presence of non-absorbed osmotically active solutes in renal tubules (e.g. glucose - *diabetes mellitus*)
 - non-absorbed solutes in the proximal tubule → osmotic effect – retention of water in the tubulus
- ↓
- ↓ transepithelial gradient for Na^+ → inhibition of Na^+ reabsorption in the proximal tubule → Na^+ retained in the tubule ~ further osmotic load → further retaining of water in the tubule

Osmotic Diuresis

- more isotonic fluid with higher total amount of Na^+ into the loop of Henle \rightarrow \downarrow reabsorption of solutes \rightarrow \downarrow hypertonicity of the renal medulla
- more fluid flows through other parts of tubulus + \downarrow hypertonicity of the renal medulla \rightarrow \downarrow water reabsorption in the collecting duct \rightarrow \uparrow diuresis, urine with an increased amount of solutes

Regulation of Renal Functions

Regulation of Renal Blood Flow

Regulation of Renal Blood Flow

- 1) Myogenic Autoregulation
- 2) Neural Regulation
- 3) Humoral Regulation

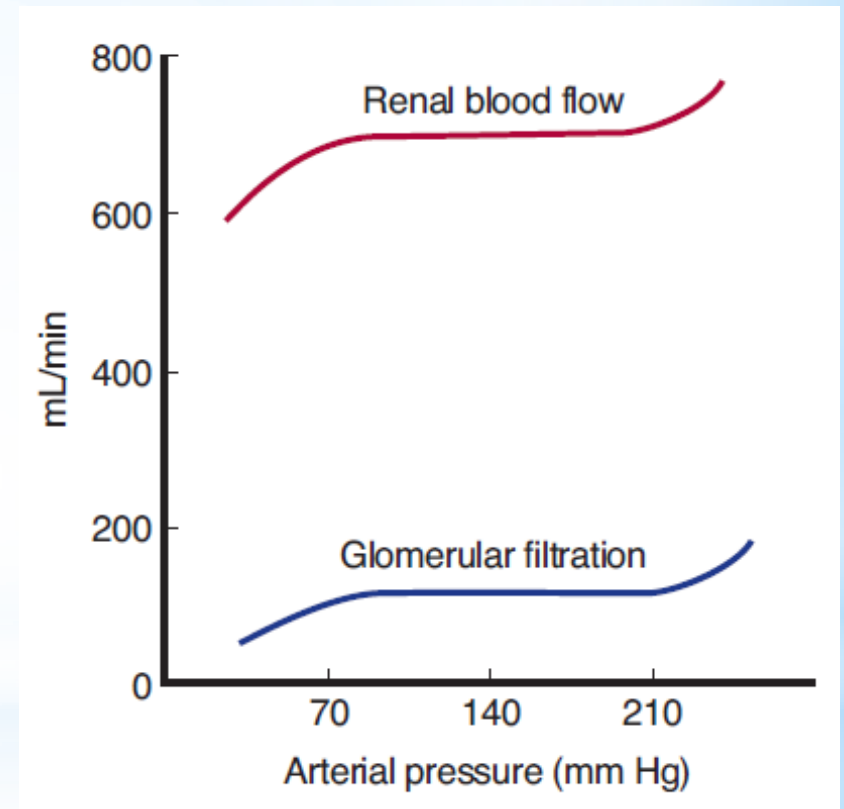

*Ganong's Review of Medical
Physiology, 23rd edition*

Regulation of Renal Blood Flow

1) Myogenic Autoregulation

- dominates
- provides stable renal activity by **maintaining stable blood flow at varying systemic pressure**

Regulation of Renal Blood Flow

2) Neural Regulation

- conformed to demands of systemic circulation
- **sympathetic system - NE**

light exertion (both emotional and physical) + upright body posture → ↓ renal blood flow but without ↓ GFR

higher ↑ of sympathetic tone - **during anesthesia and pain** - GFR may already ↓

in healthy people – minor impact

Regulation of Renal Blood Flow

3) Humoral Regulation

- contribute to regulation of systemic BP and regulation of body fluids
- **NE, E** (from the adrenal medulla)
constriction of aff. and eff. arterioles → ↓ renal blood flow and GFR

(small impact with the exception of serious conditions, for example serious bleeding)

Regulation of Renal Blood Flow

3) Humoral Regulation

- contribute to regulation of systemic BP and regulation of body fluids

- **endothelin**

constriction of aff. and eff. arterioles → ↓ renal blood flow and GFR

released locally from the impaired endothel (physiological impact - hemostasis; pathologically increased levels at the toxemia of pregnancy, acute renal failure, chronic uremia)

Regulation of Renal Blood Flow

3) Humoral Regulation

- contribute to regulation of systemic BP and regulation of body fluids
- **NO**
continual basal production → vasodilation → stable renal blood flow and GFR
- **prostaglandins (PGE₂, PGI₂), bradykinin**
→ vasodilation
minor impact under physiological conditions
non-steroidal anti-inflammatory agents during stress!

Regulation of Renal Blood Flow

3) Humoral Regulation

- contribute to regulation of systemic BP and regulation of body fluids
- **Renin-Angiotensine System**

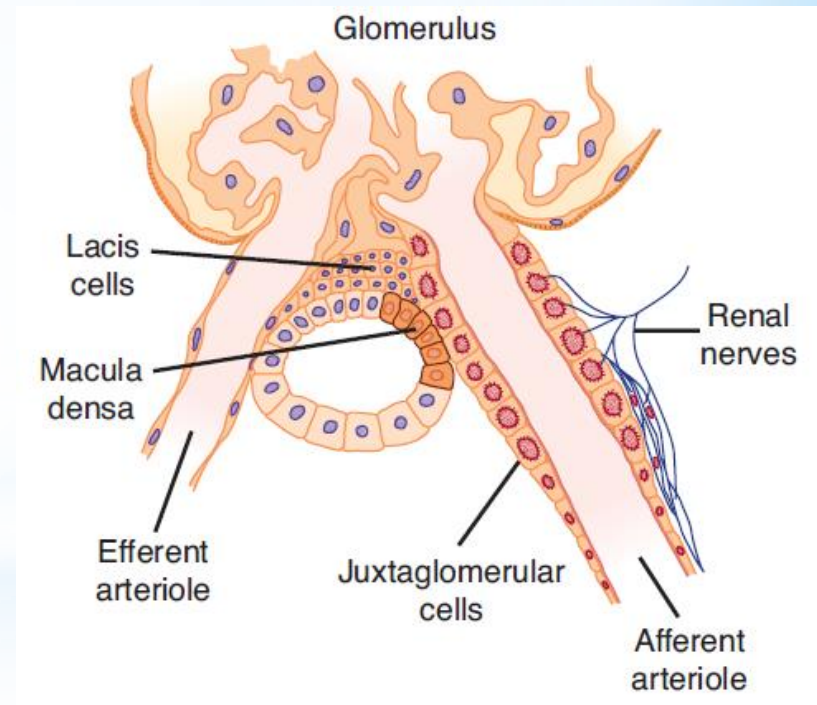

Ganong's Review of Medical Physiology, 23rd edition

Regulation of Renal Blood Flow

Renin-Angiotensin System

- ↓ Na⁺ in plasma
- ↓ blood pressure
- ↑ activity of sympathetic (β rec.)

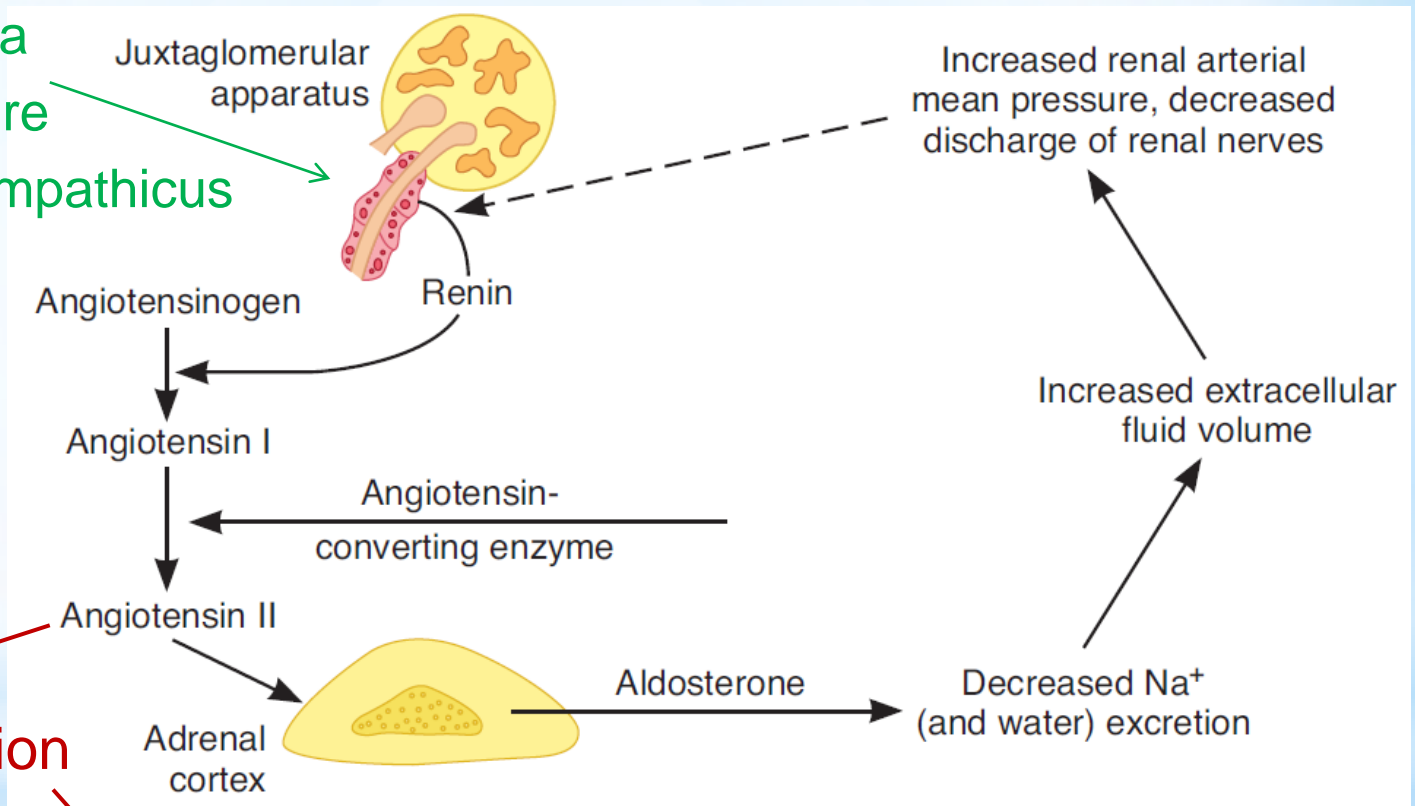

vasoconstriction
(more in eff. a.)

thirst, ADH

↓ renal blood flow but ↑ GFR

(usually during ↓ BP or fluid depletion – prevention of ↓ GFR + ↑ tubular reabsorption of Na⁺ and water due to ↓ P_c in peritubular capillaries)

Regulation of Renal Blood Flow

3) Humoral Regulation

Tubuloglomerular Feedback

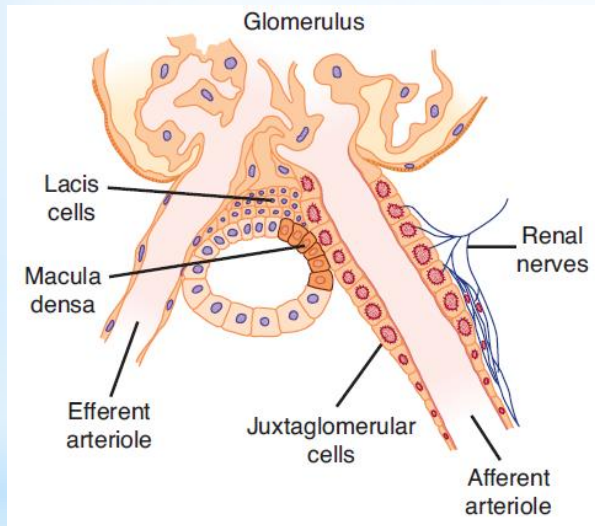

Ganong's Review of Medical Physiology, 23rd edition

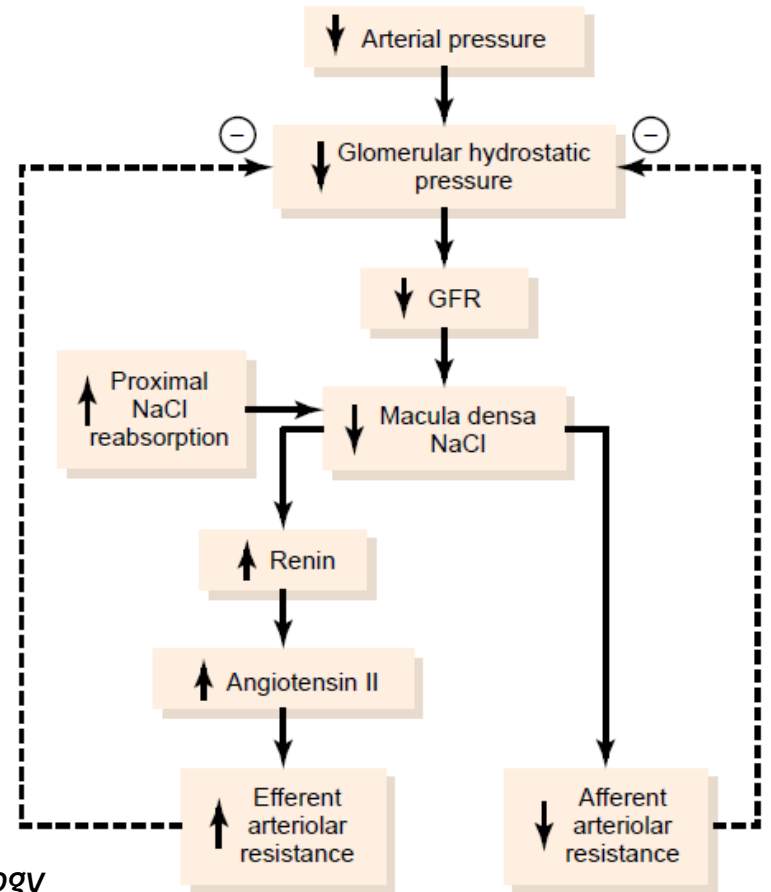

*Guyton & Hall.
Textbook of
Medical Physiology*

Regulation of Renal Functions

Regulation of Glomerular Filtration

Regulation of Tubular Reabsorption

Regulation of Glomerular Filtration

$$\text{GFR} = K_f \cdot \text{net filtration pressure}$$

$$\text{GFR} = K_f \cdot (P_G - \pi_B - P_B - \pi_G)$$

- control of the glomerular filtration pressure:

constriction of *vas aff.* → ↓ glomerular pressure → ↓ filtration

constriction of *vas eff.* → ↑ glomerular pressure → ↑ filtration

Regulation of Tubular Reabsorption

- controls balance between the glomerular filtration and tubular reabsorption

1) Local Regulation

2) Neural Regulation

3) Humoral Regulation

Glomerulotubular Balance

Regulation of Tubular Reabsorption

1) Local Regulation

Physical Forces in Peritubular Capillaries and in Renal Interstitium

$$\text{TRR} = K_f \cdot \text{net reabsorptive force}$$

- K_f
- $\uparrow K_f \rightarrow \uparrow \text{TRR}$ and *vice versa*
 - rather stable under physiological conditions

Regulation of Tubular Reabsorption

1) Local Regulation

Physical Forces in Peritubular Capillaries and in Renal Interstitium

$$\text{TRR} = K_f \cdot \text{net reabsorptive force}$$

P_c - **BP** ($\uparrow \text{BP} \rightarrow \uparrow P_c \rightarrow \downarrow \text{TRR}$)

- **resistance of aff. and eff. arterioles**

π_c - **π in plasma**

- **filtration fraction** ($\uparrow \text{FF} \rightarrow \uparrow \pi_c \rightarrow \uparrow \text{TRR}$)

Regulation of Tubular Reabsorption

1) Local Regulation

Physical Forces in Peritubular Capillaries and in Renal Interstitium

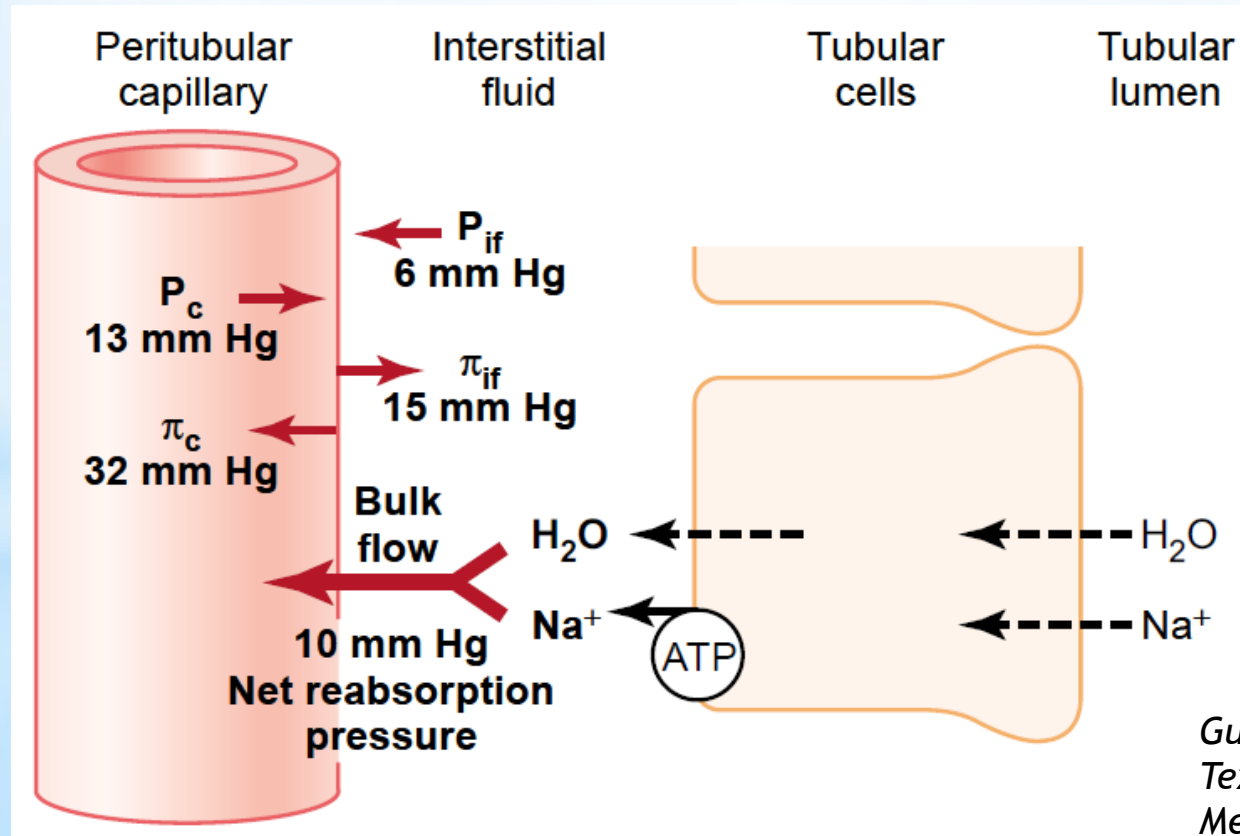

Guyton & Hall.
Textbook of
Medical Physiology



Regulation of Tubular Reabsorption

1) Local Regulation

Physical Forces in Peritubular Capillaries and in Renal Interstitium – changes in interstitium (P_{if} , π_{if})

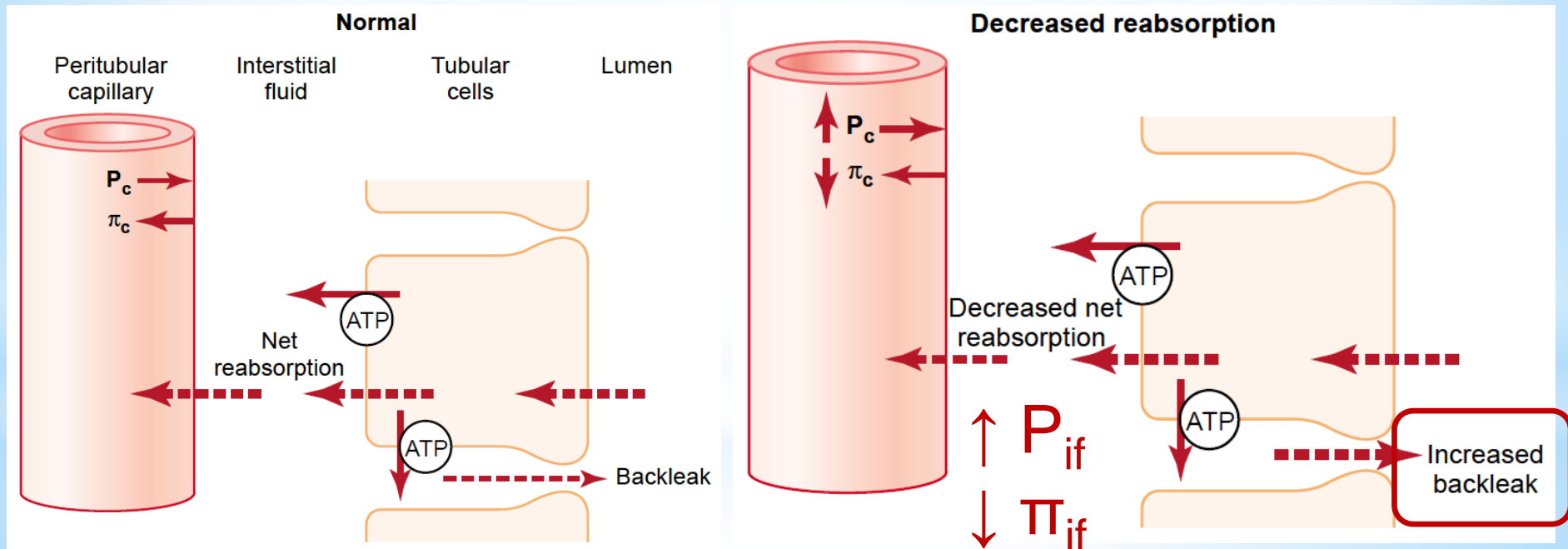

Guyton & Hall. Textbook of Medical Physiology

\uparrow reabsorption \rightarrow $\downarrow P_{if}$ a $\uparrow \pi_{if} \rightarrow$ \downarrow backleak

Regulation of Tubular Reabsorption

1) Local Regulation

Pressure Natriuresis and Pressure Diuresis

- increased excretion of salt and water at \uparrow BP
- mechanisms:

\uparrow GFR

(physiologically slight effect on diuresis -
autoregulation vs. impaired autoregulation at renal diseases)

\downarrow TRR

(\uparrow BP \rightarrow slight \uparrow P_c \rightarrow \uparrow P_{if} \rightarrow \uparrow *backleak* \rightarrow \downarrow TRR)

\downarrow formation of angiotensine II

Regulation of Tubular Reabsorption

2) Neural Regulation

Sympathicus

→ ↑ reabsorption of salt and water

- small ↑ of its activity (α -rec. in epithelia):
directly through ↑ reabsorption of Na^+

- notable ↑ of its activity - **indirectly**:

→ constriction of aff. and eff. arterioles → ↓ renal blood flow → ↓ P_c → ↑ TRR

Regulation of Tubular Reabsorption

3) Hormonal Regulation

- impact – **separate regulation** of reabsorption/excretion of particular solutes (other mechanisms are nonspecific – influence the total TRR!)

Aldosteron

Angiotensine II

Natriuretic peptides (namely ANP)

Antidiuretic hormone

Parathormone

Urodilatin (renal NP)

Regulation of Tubular Reabsorption

3) Hormonal Regulation

Aldosteron

Angiotensine II

Regulation of Tubular Reabsorption

3) Hormonal Regulation

Natriuretic peptides

increased tension of atrial cardiomyocytes

→ ↑ secretion of ANP:

→ ↓ reabsorption of salt and water directly
(namely in the collecting ducts)

→ ↓ secretion of renin → ↓ angiotensine II → ↓
TRR

(congestive heart failure)

Regulation of Tubular Reabsorption

3) Hormonal Regulation

Antidiuretic hormone (ADH)

- controls excretion of water

↑ **osmolality of plasma** (osmoreceptors)

→ ↑ secretion of ADH – V_2 receptors → water channels (aquaporins 2)

→ ↑ **reabsorption of water by osmosis**

Regulation of Tubular Reabsorption

3) Hormonal Regulation

Parathormone

- controls excretion of Ca^{2+}

↓ **calcemia**

→ ↑ secretion of parathormone:

→ ↑ **tubular reabsorption of Ca^{2+}**
(namely in the distal tubule)

→ ↓ **tubular reabsorption of phosphate in the proximal tubule**

→ ↑ **tubular reabsorption of Mg^{2+} in the loop of Henle**