

RETREATMENT



MODULE 9

Quality of Endodontic Treatments

		% Inadequate trt	% Failures (LEO)
Eckerbom et al. (1987)	Sweden	75	26,4
Eriksen et al. (1988)	Norway	59	34
Odesjö et al. (1990)	Sweden	70	24,5
Imfeld (1991)	Switzerland	64	31
Hülsmann et al. (1991)	Germany	62	60
De Cleen et al. (1993)	Holland	50,9	39,2
Städler et al. (1993)	Austria	57,8	25,9
Buckley et Spangberg (1995)	USA	58	31,3
Marques et al. (1998)	Portugal	53,8	21,7
Boucher et al (2001)	France	79	63

ProTaper Universal Retreatment

ProTaper « D »

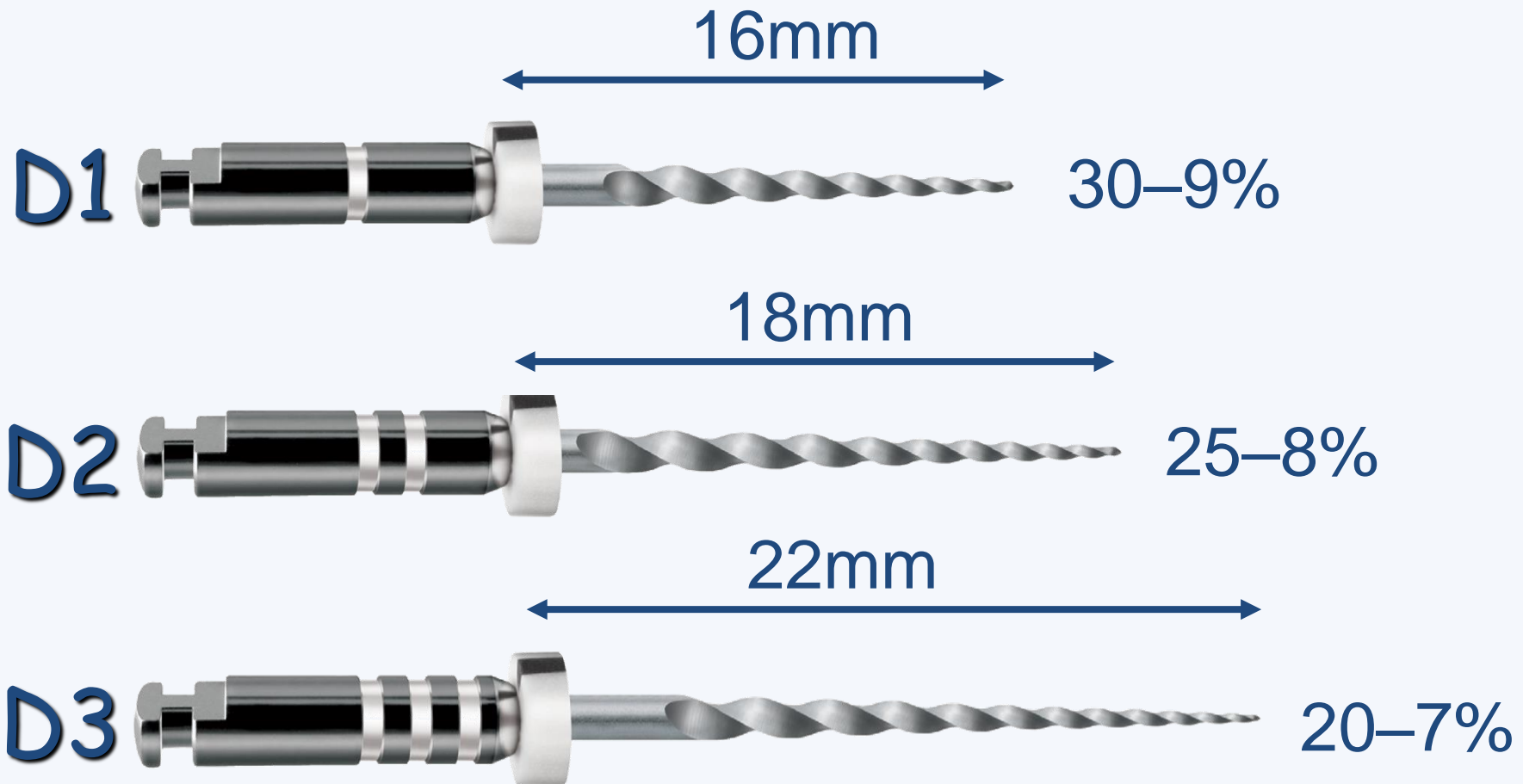

ProTaper « D » Decreasing Taper

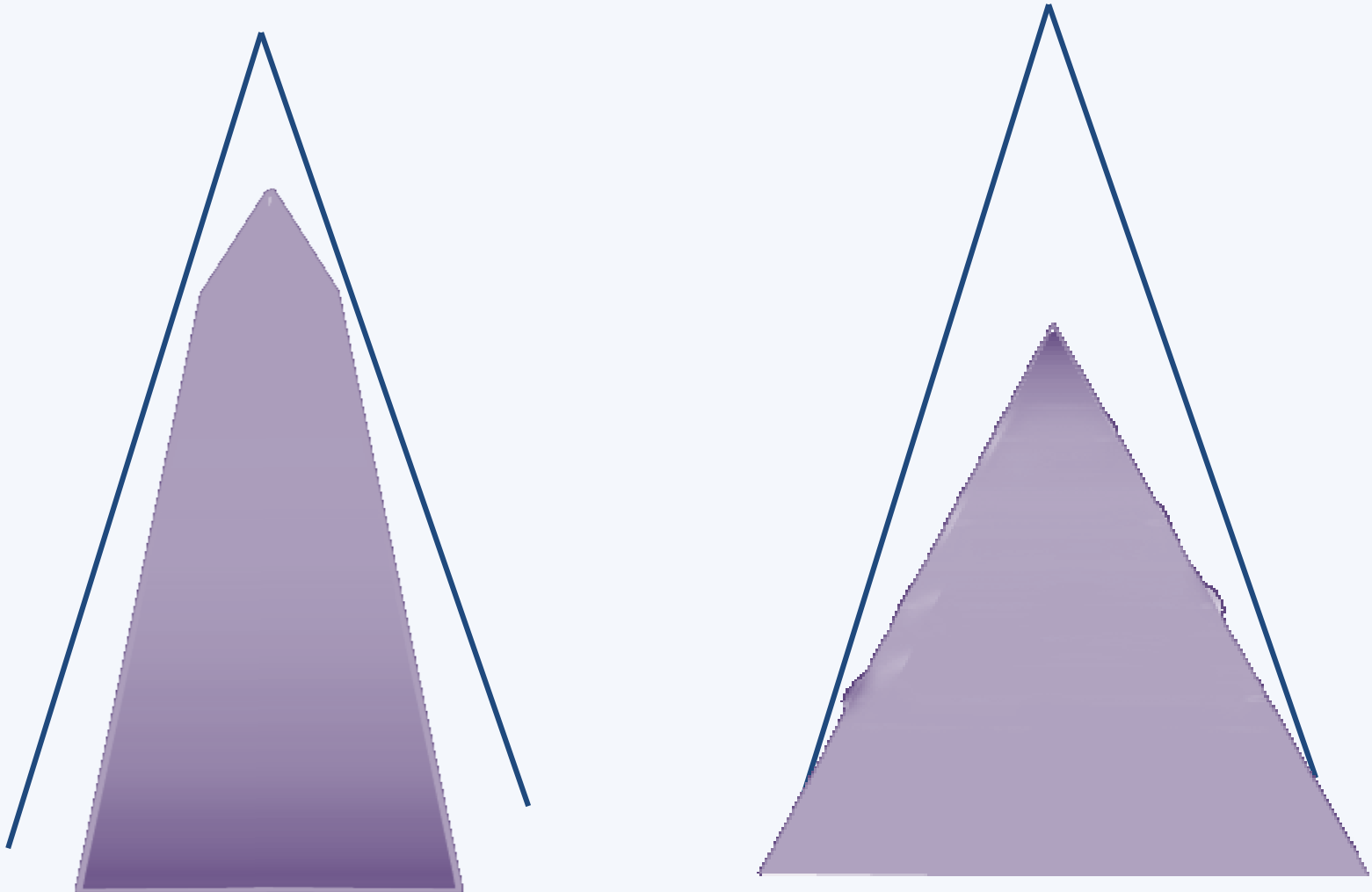

ProTaper D1

Active Tip : allows better initial penetration in the material

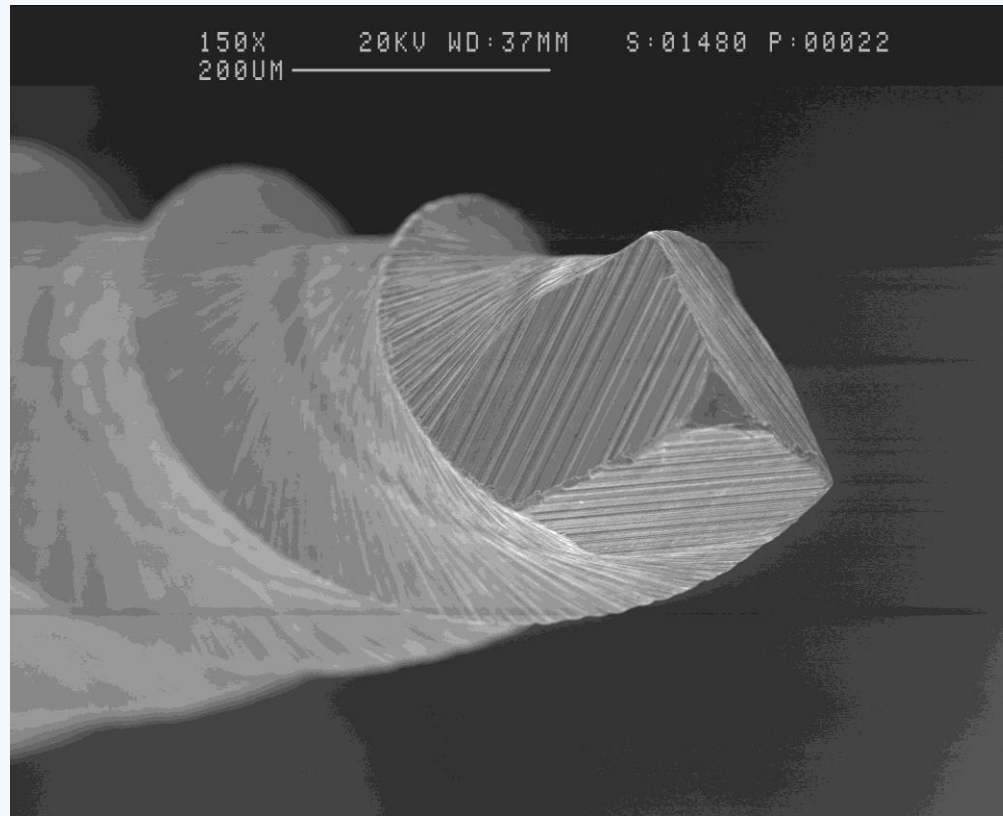
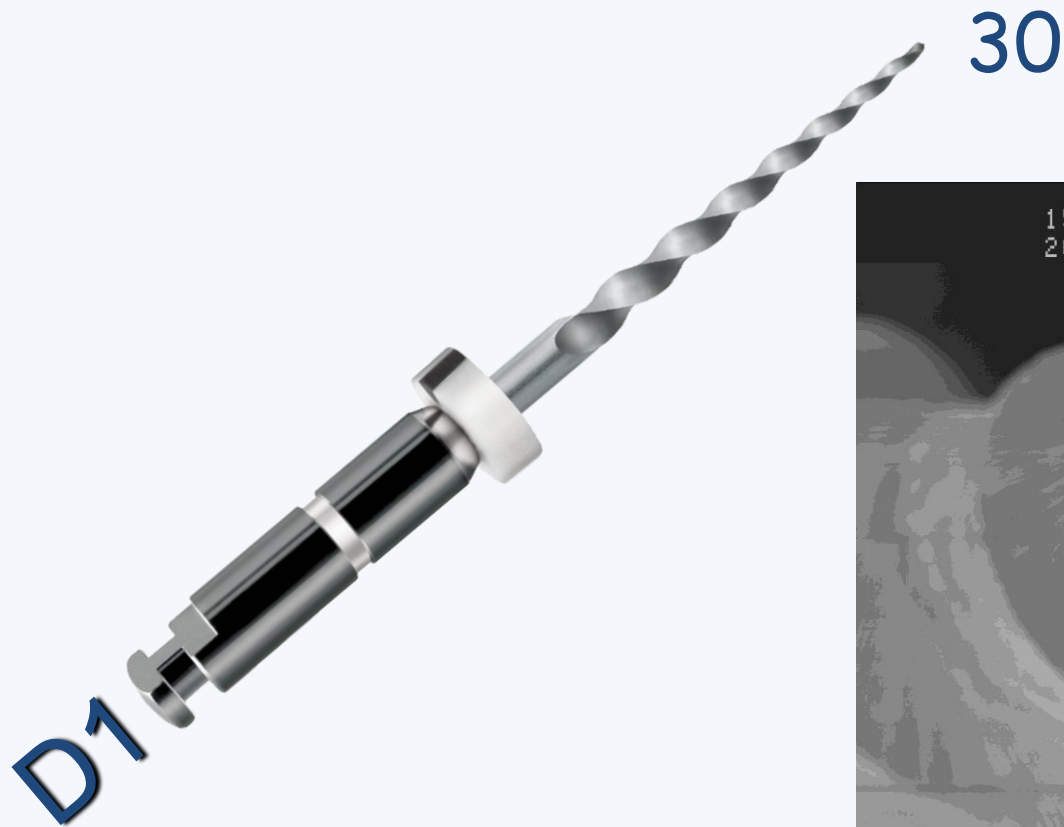

DENTSPLY

MAILLEFER



PROTAPER[®]
UNIVERSAL

Retreatment Sequence

RETREATMENT

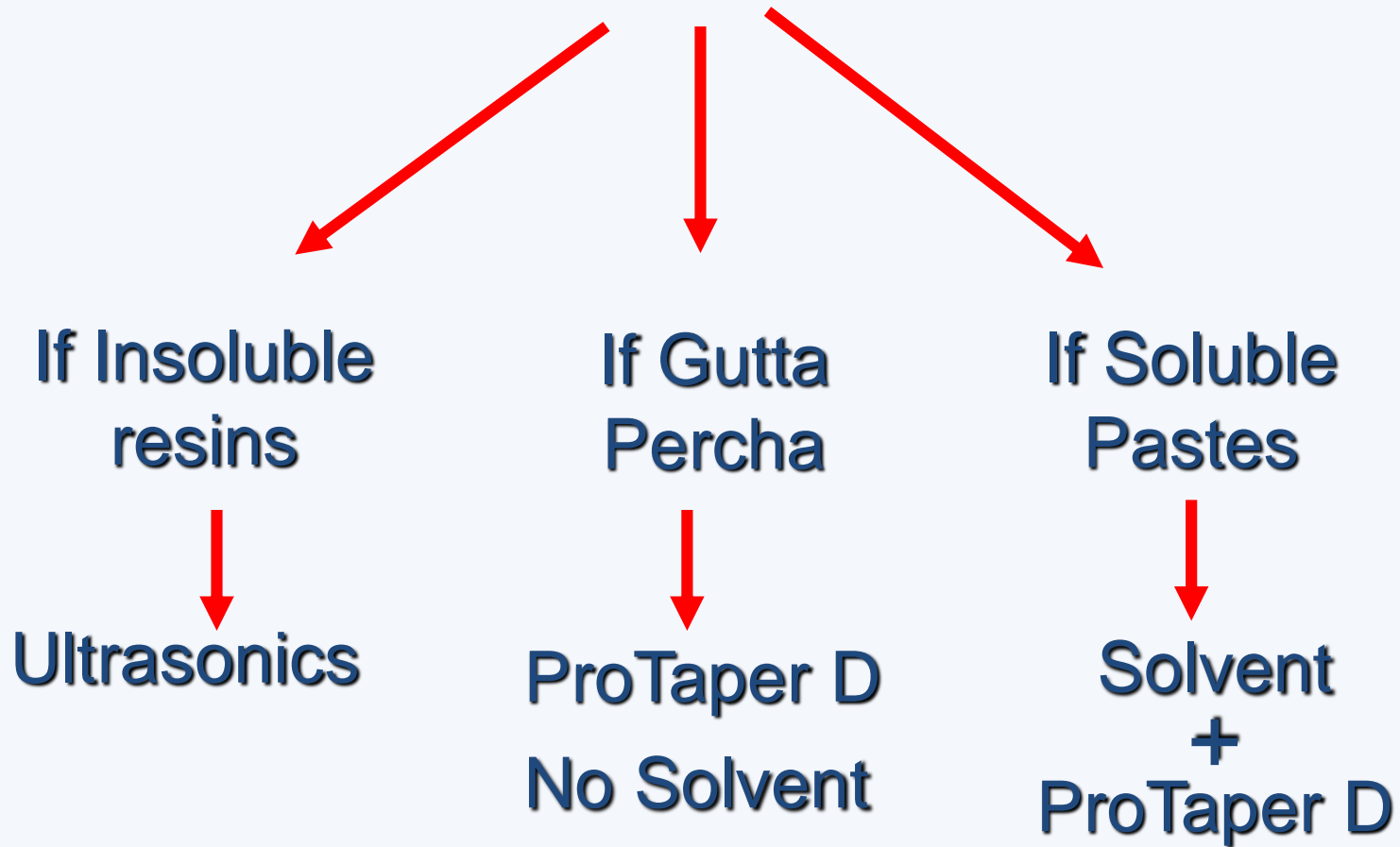



D1

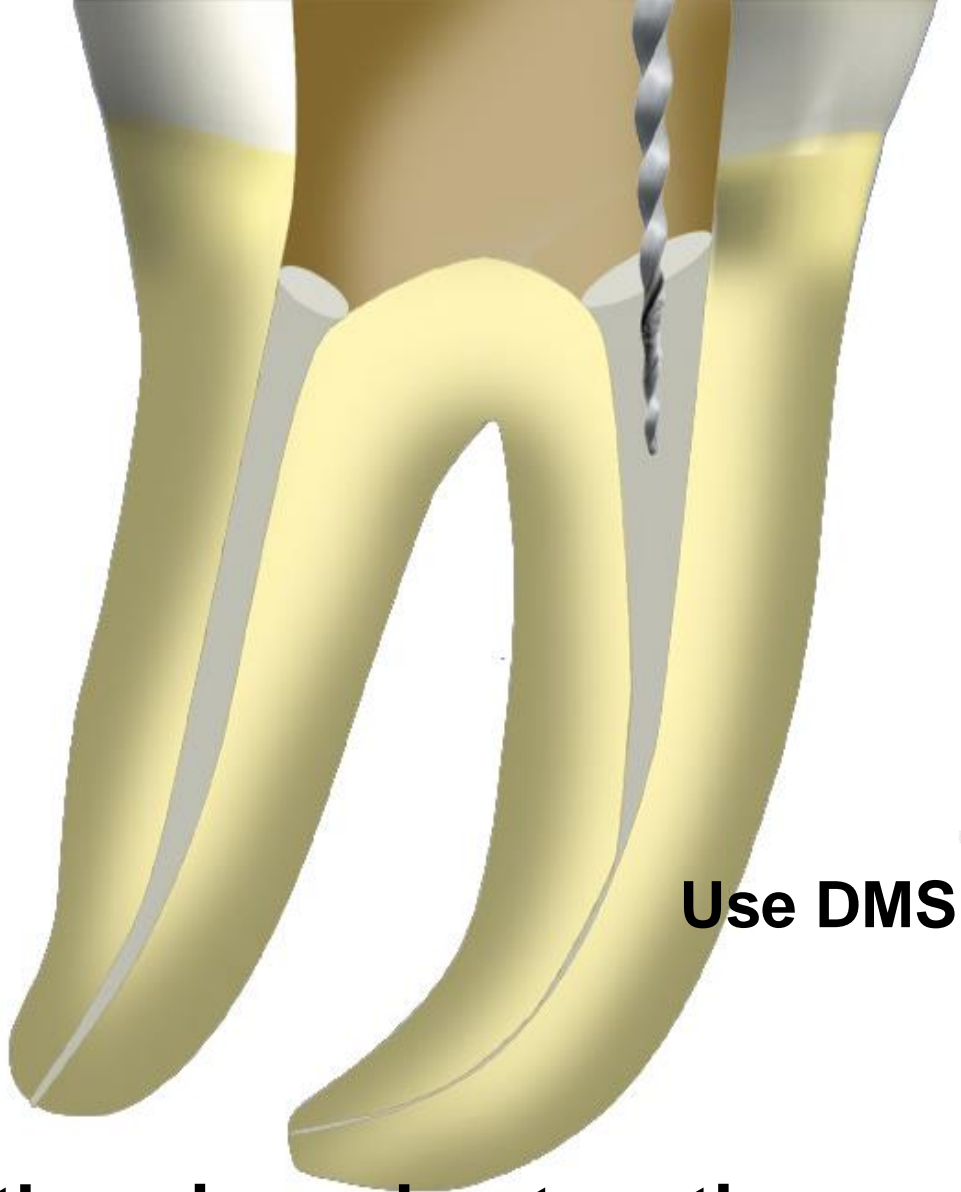

Use DMS 4 to softened Gutta

Use D1 with an in-and-out motion.

**In case of blockage, do not force
take an X-Ray.**

*If there is still material in the
canal, move to D2*



D2

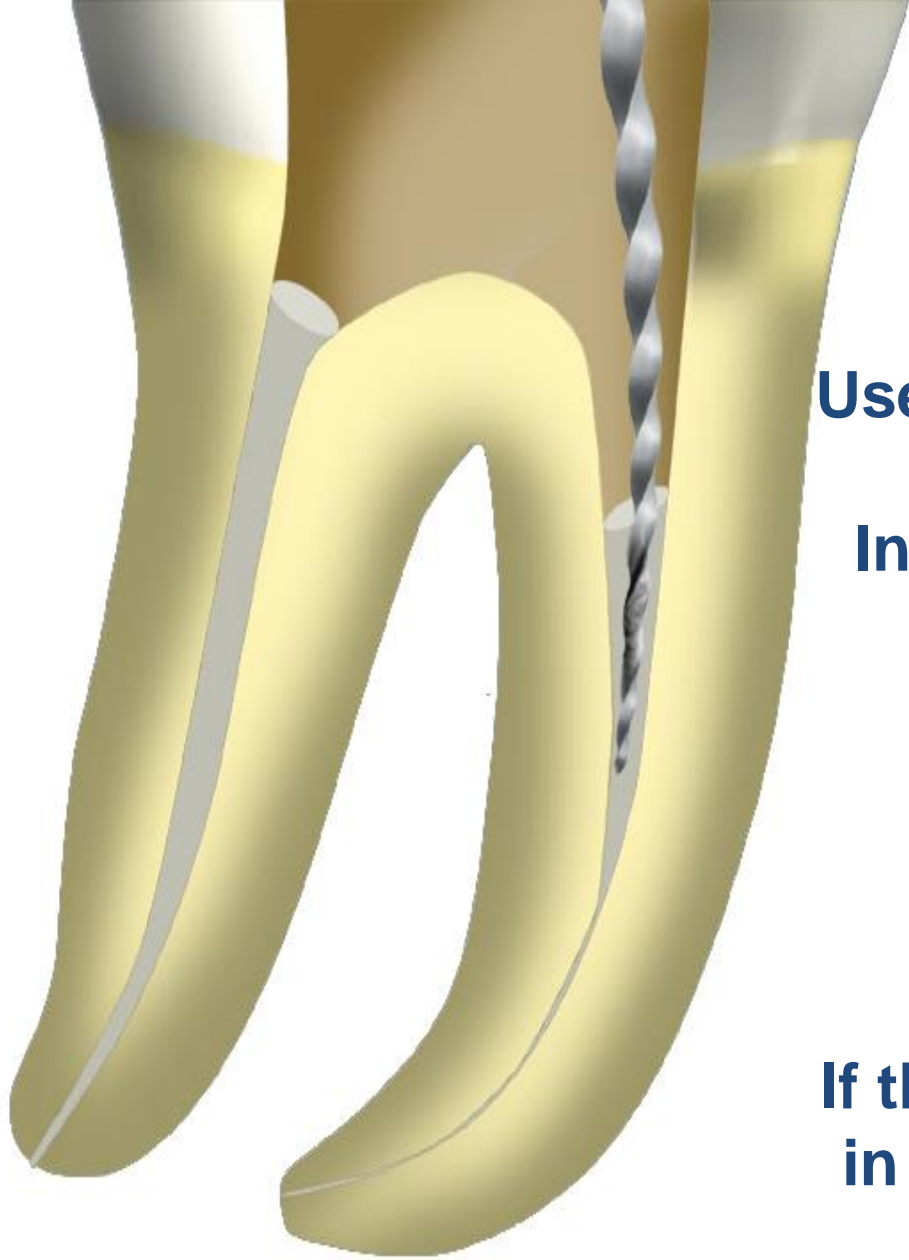

**Use D2 with an in-and-out motion
In case of blockage,
don't force.**

take an X-Ray.

**If there is still material
in the canal, move to
D3**



D3

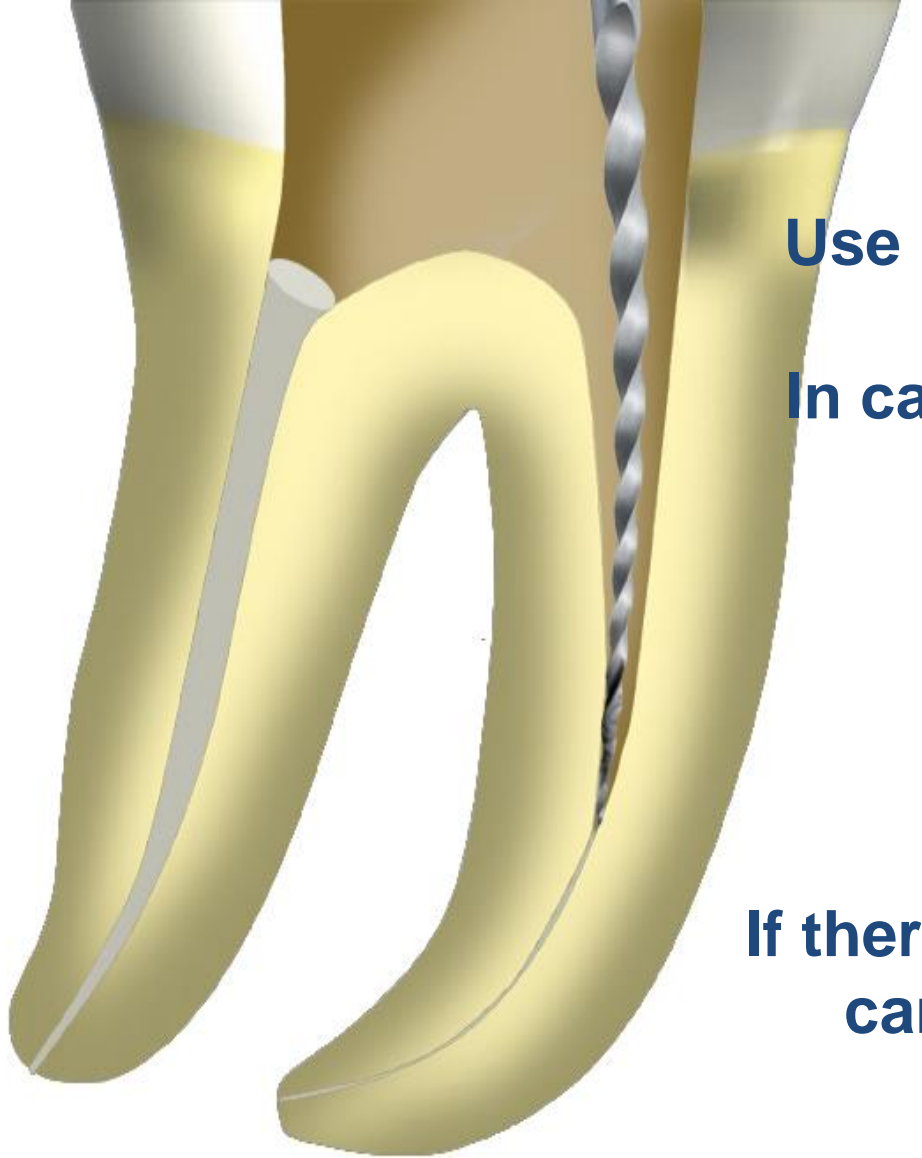

**Use D3 with an in-and-out motion
In case of blockade, don't force.**

take an X-Ray.

If there is still material in the canal or a ledge use a

C+ file

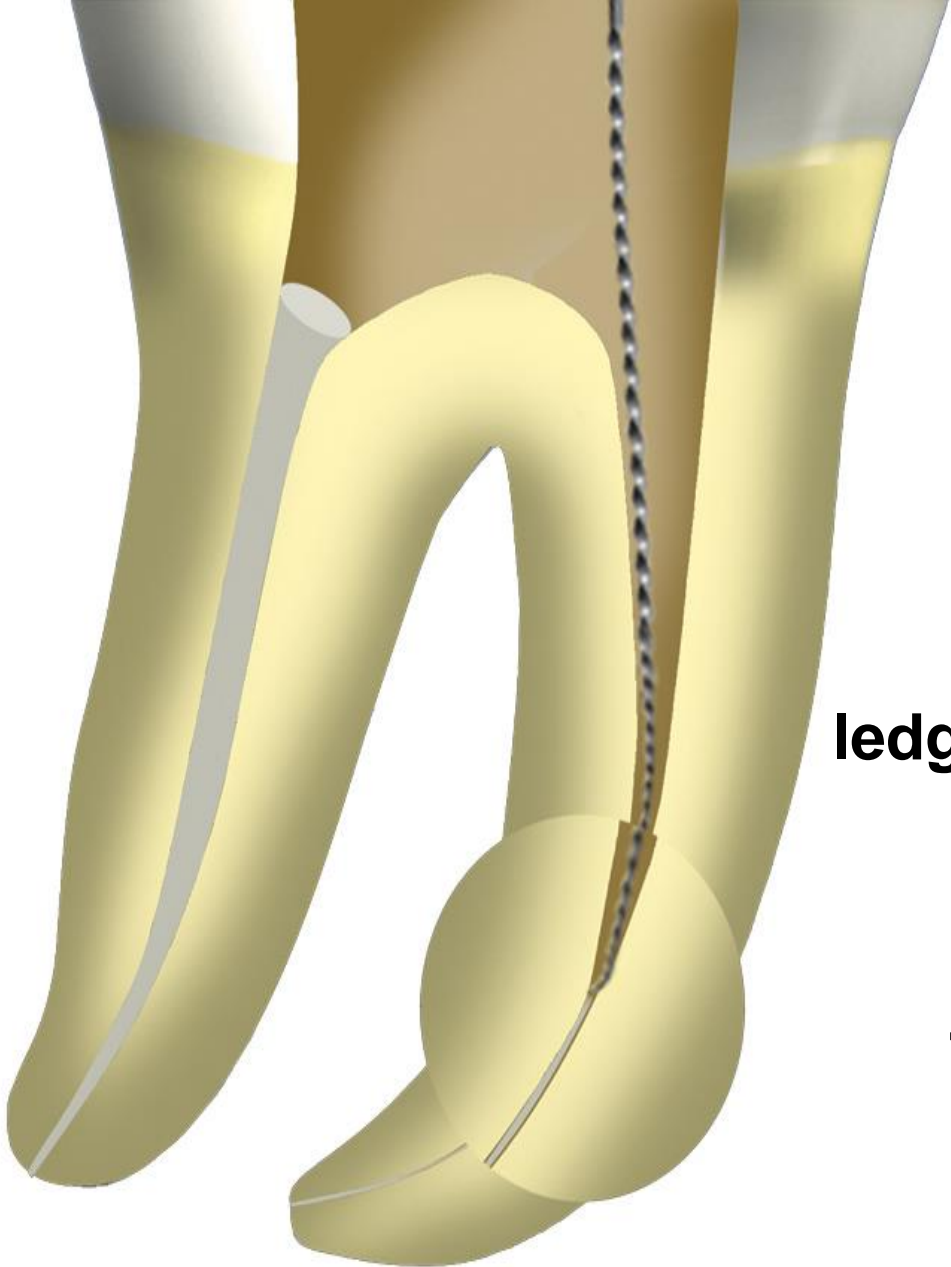

Bypass the ledge with precurved C+ files size 08, 10 or 15 18mm length



**Check patency of the apical
area and determine
Working Length
With Stainless Steel Hand
File
Size 15**

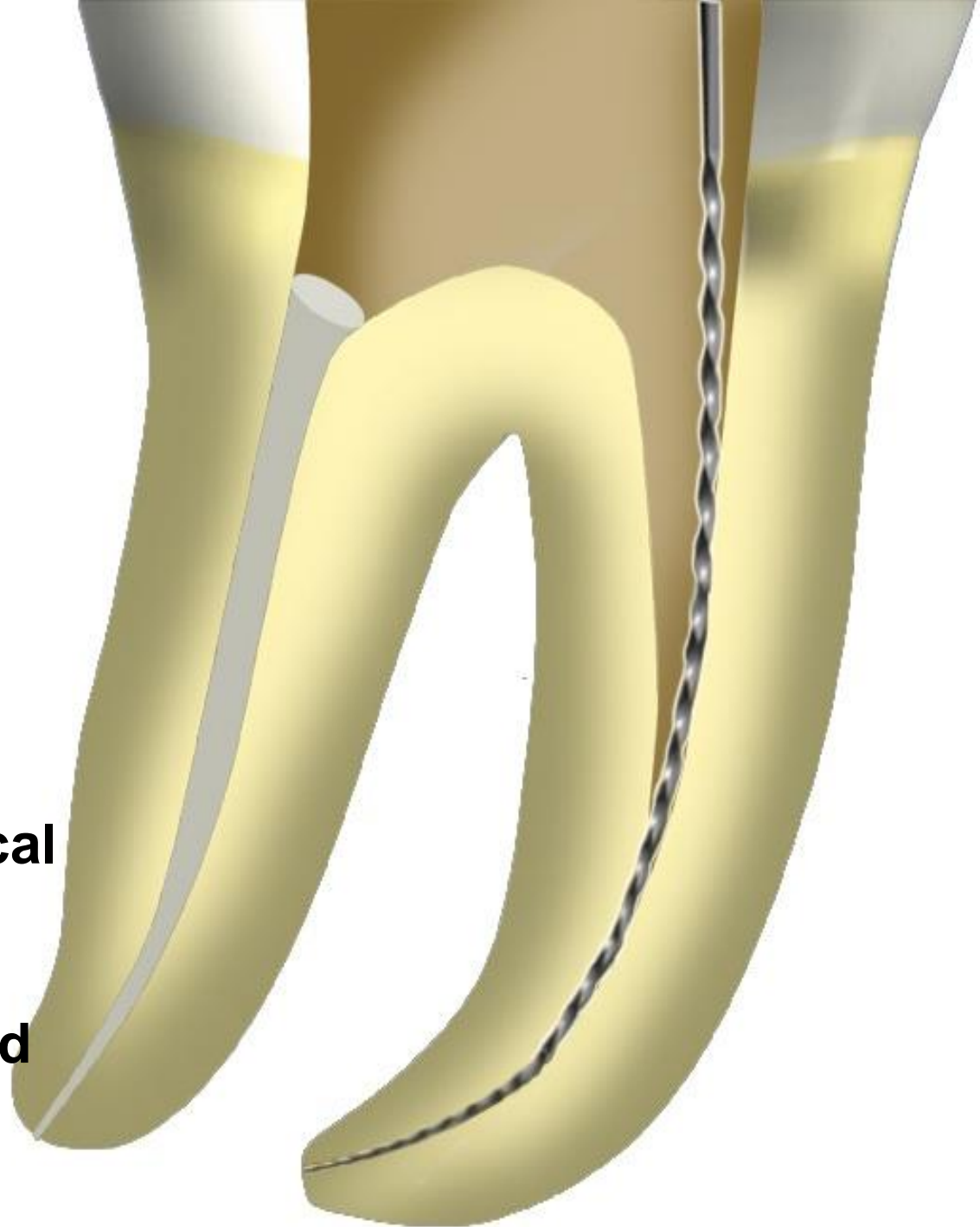

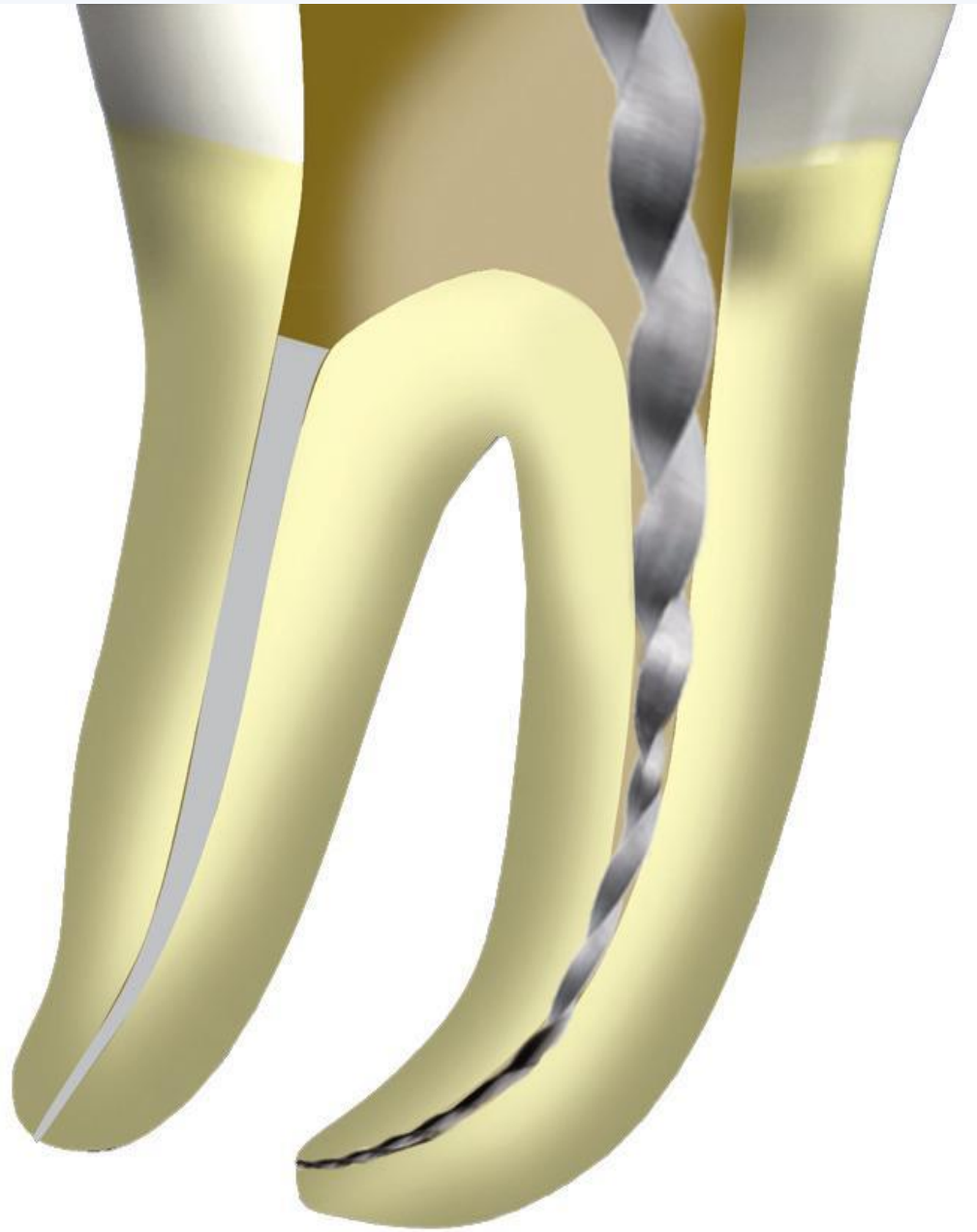

Shape at Working Length



D1





D2

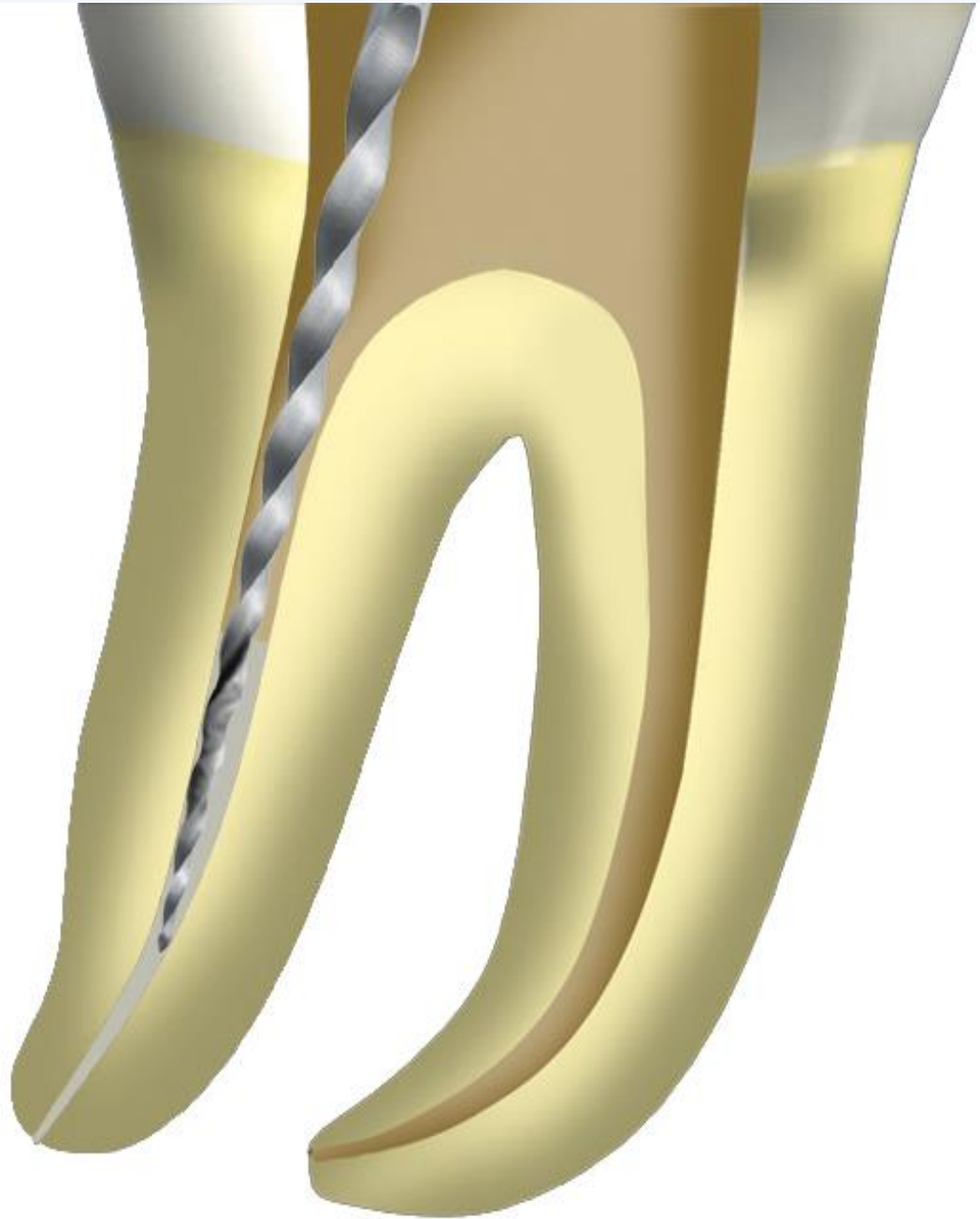

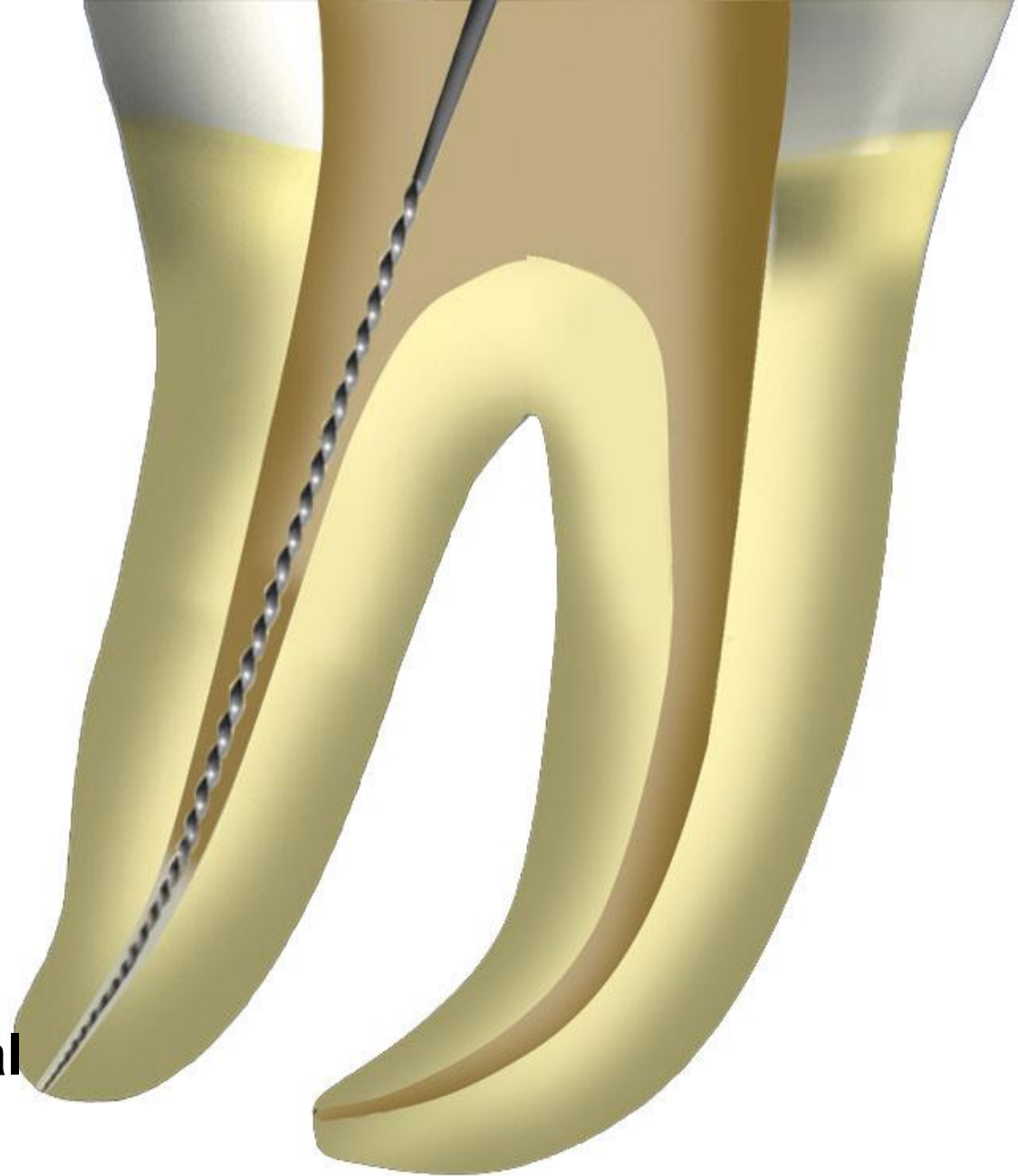

**Use C+ Files
in the last mm of the canal
to avoid
debris extrusion**



D3

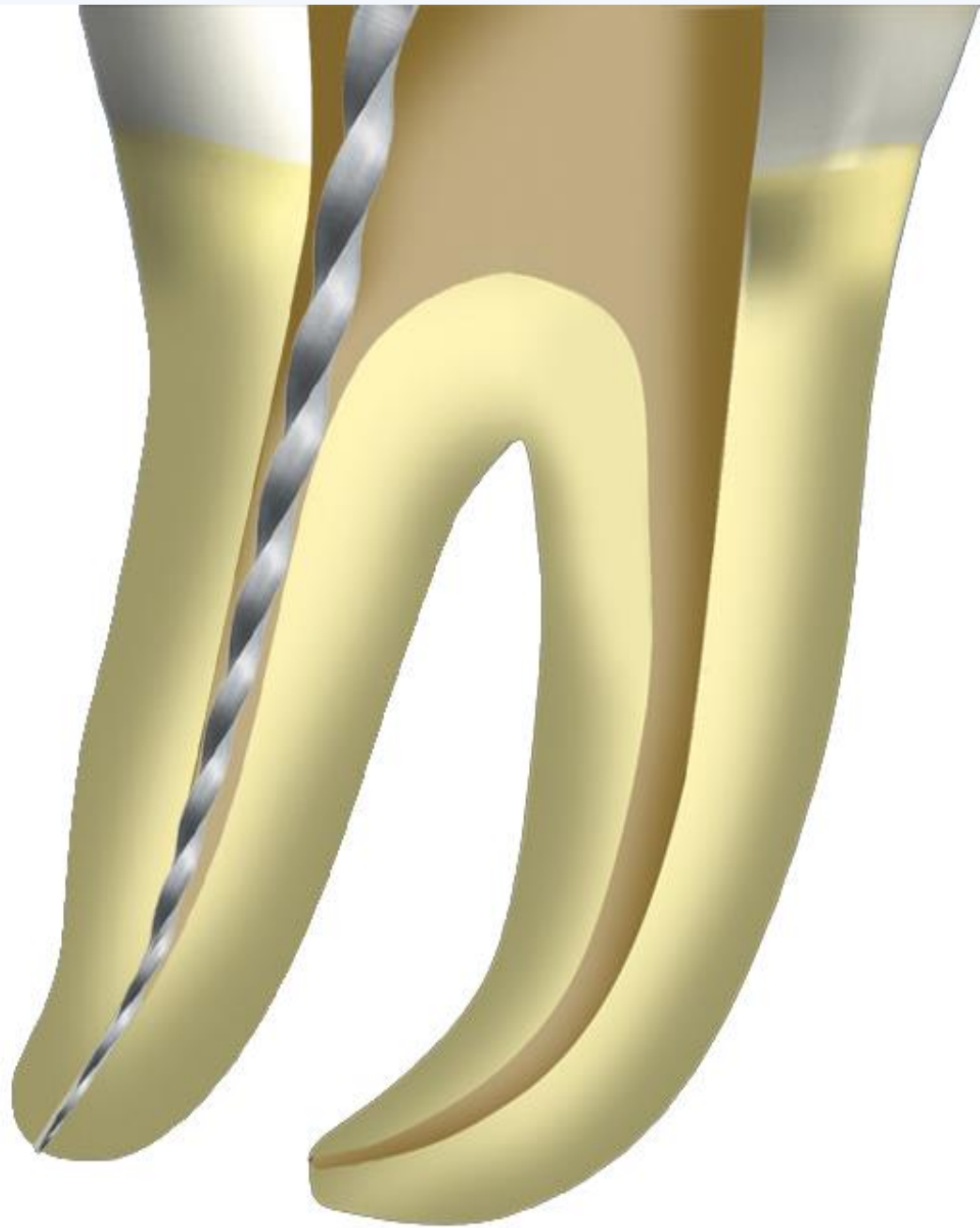

**Additional Shaping at
Working Length
If needed
F2,F3...**

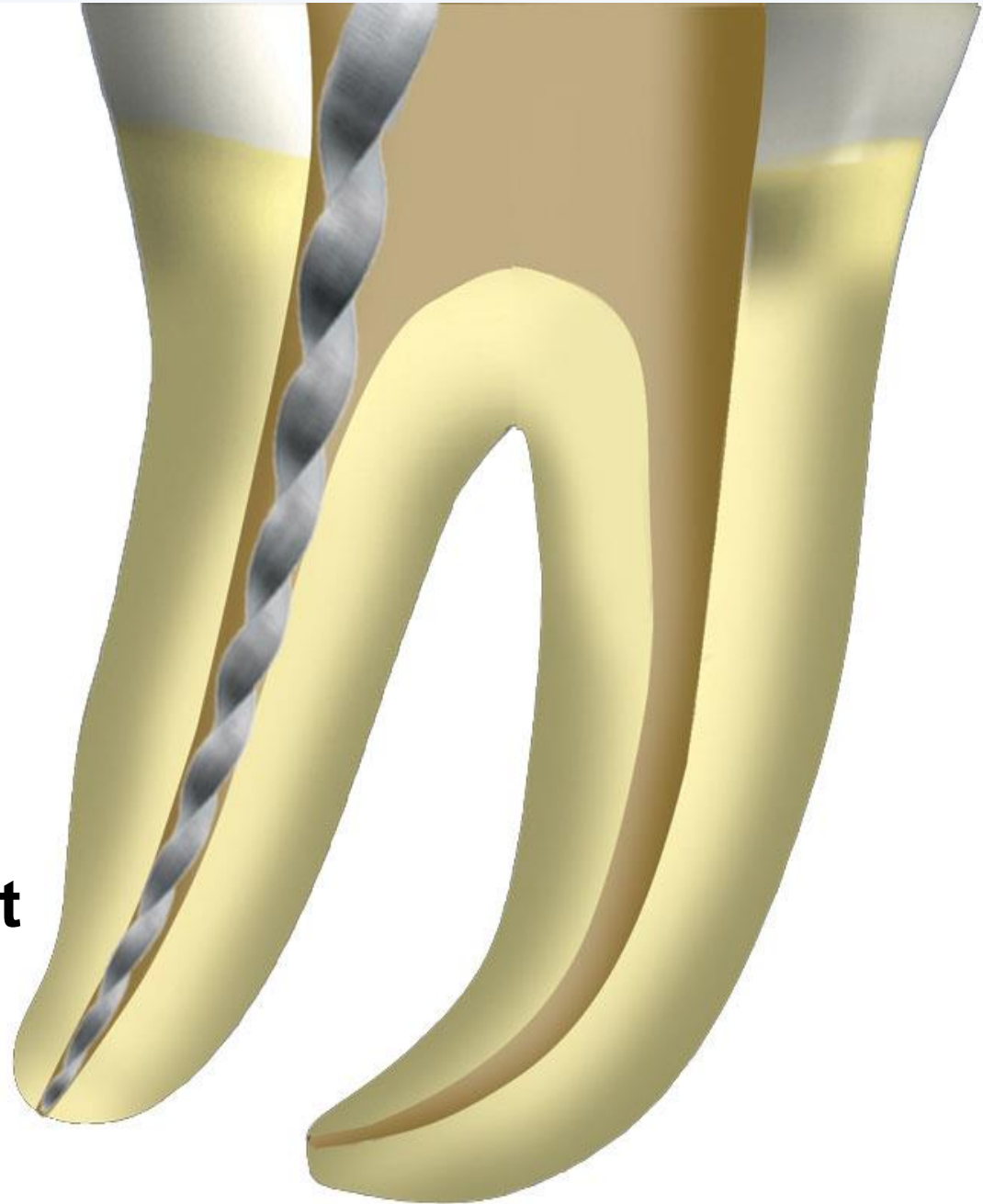

PROTAPER Sequencer For better ergonomics



DENTSPLY

MAILLEFER



**CONTINUING EDUCATION
CLINICAL EDUCATION**

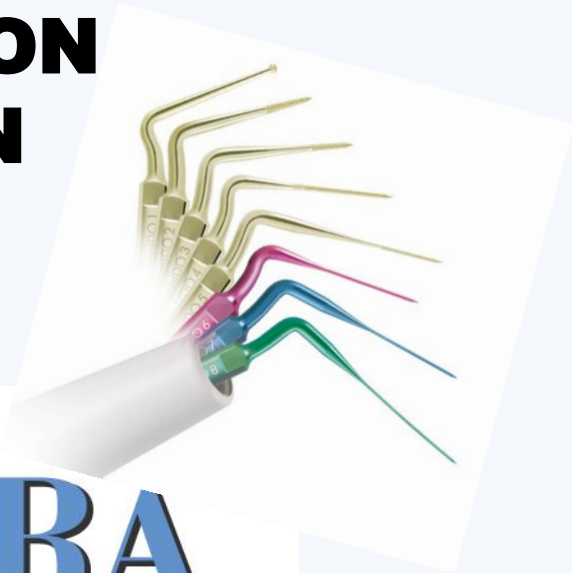

PROULTRA

**Posts Removal &
Broken Instruments Removal**

PROULTRA™

Abrasive coated instruments

Titanium instruments



ENDO1 **ENDO2** **ENDO3** **ENDO4** **ENDO5**

17 mm 17 mm 18 mm 20 mm 24 mm



ENDO6 **ENDO7** **ENDO8**

20 mm 24 mm 27 mm

Broken Instruments Removal

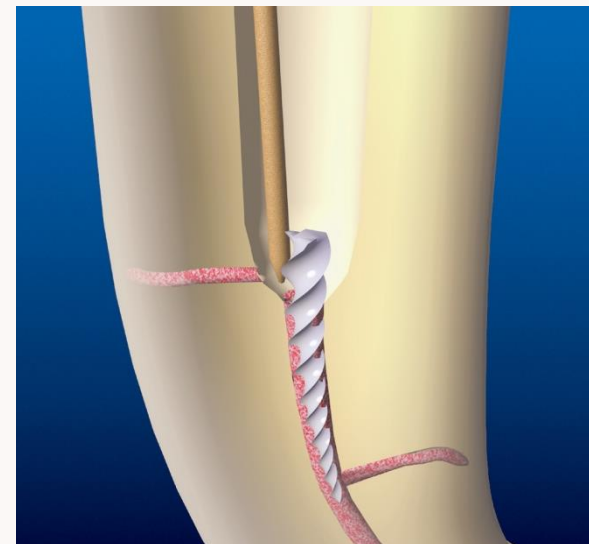
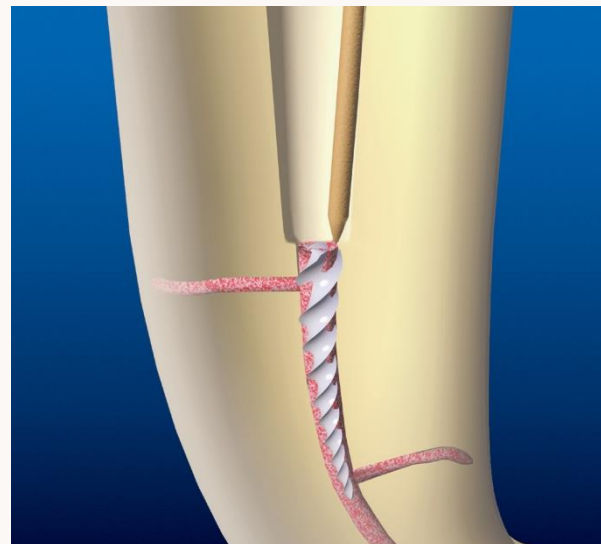
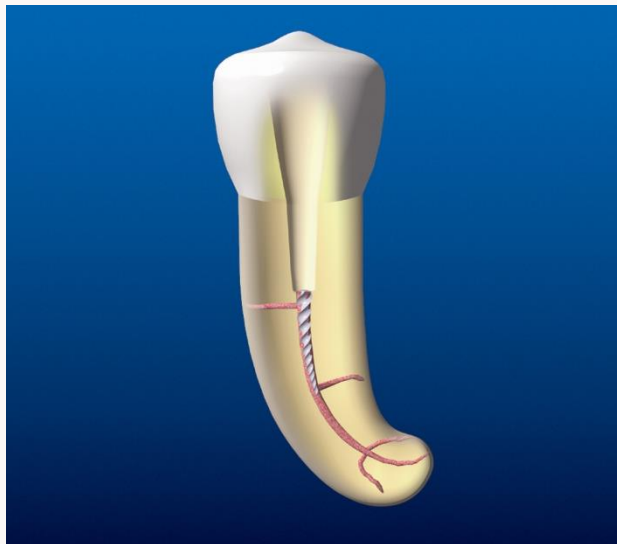
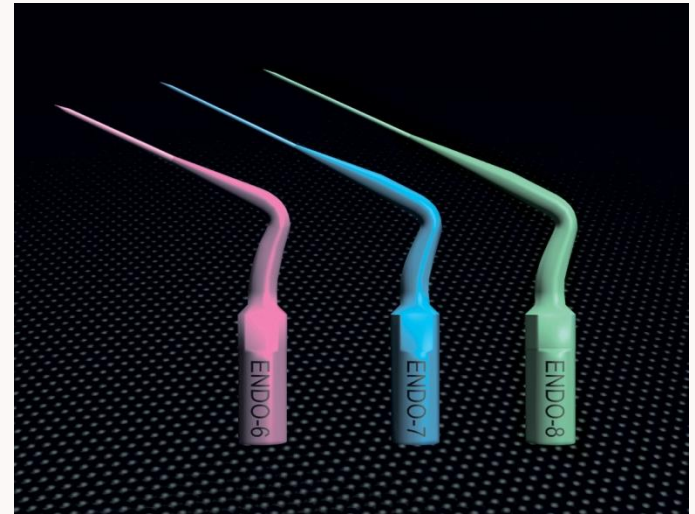

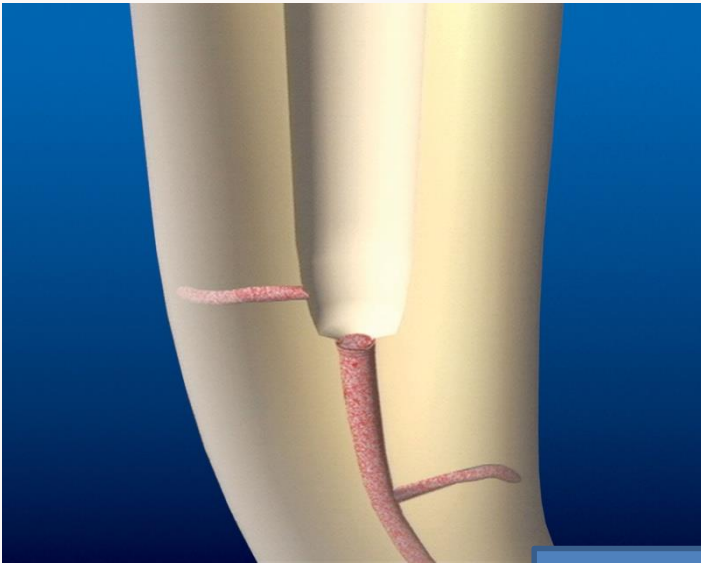
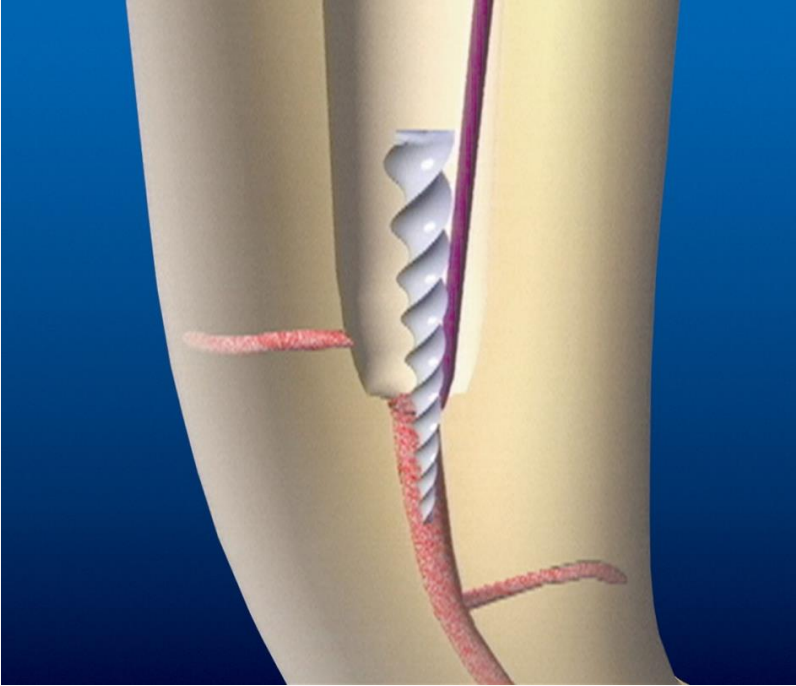
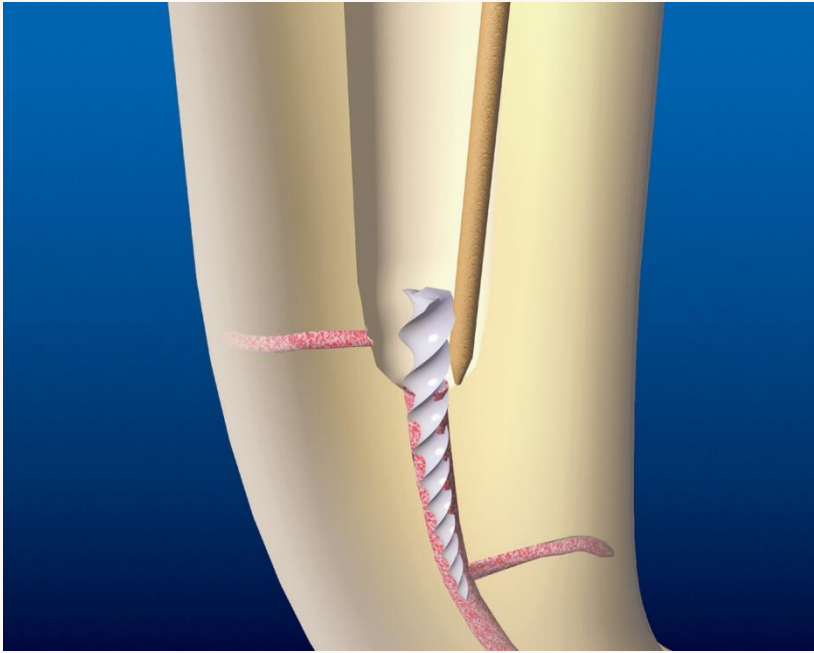

Posts Removal

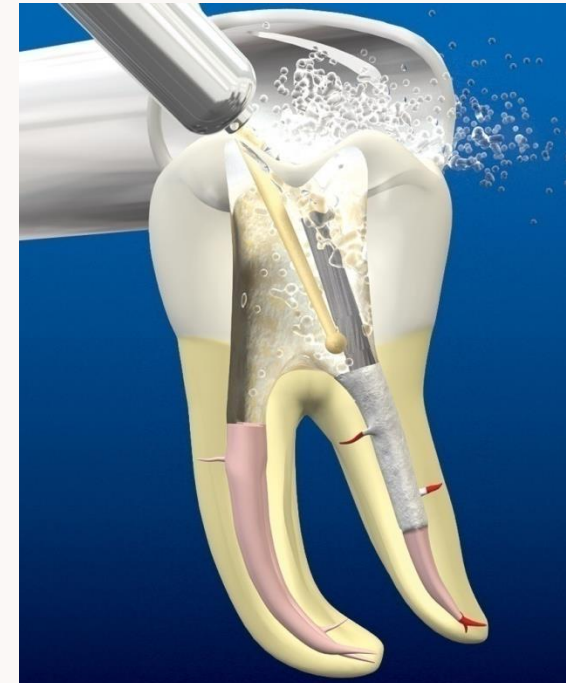
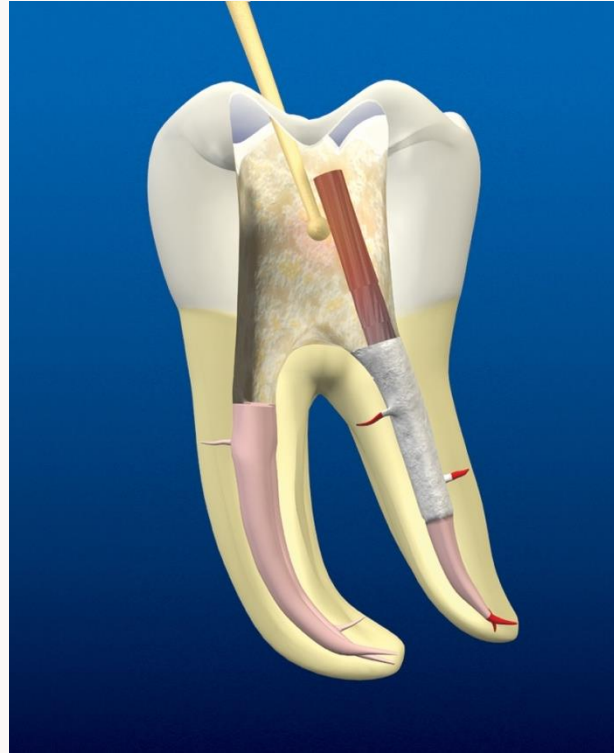

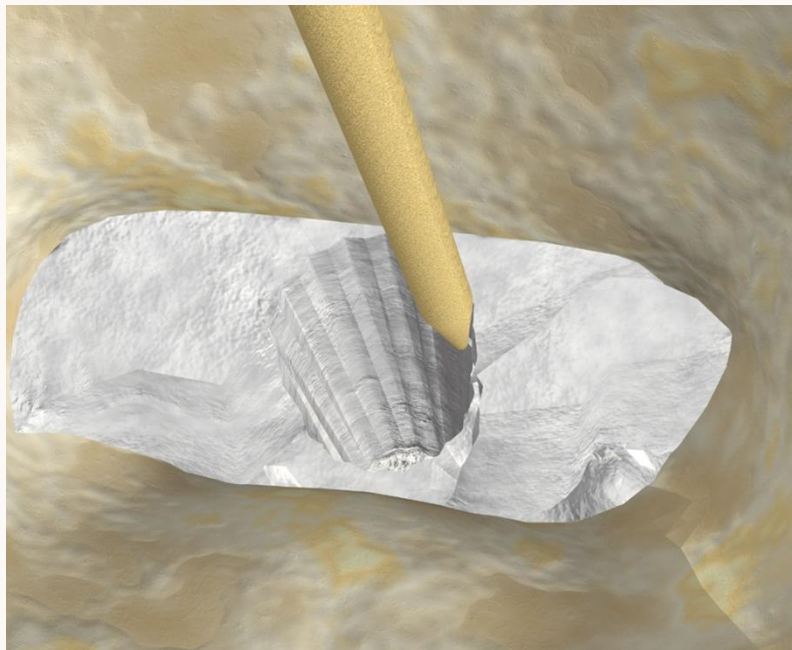
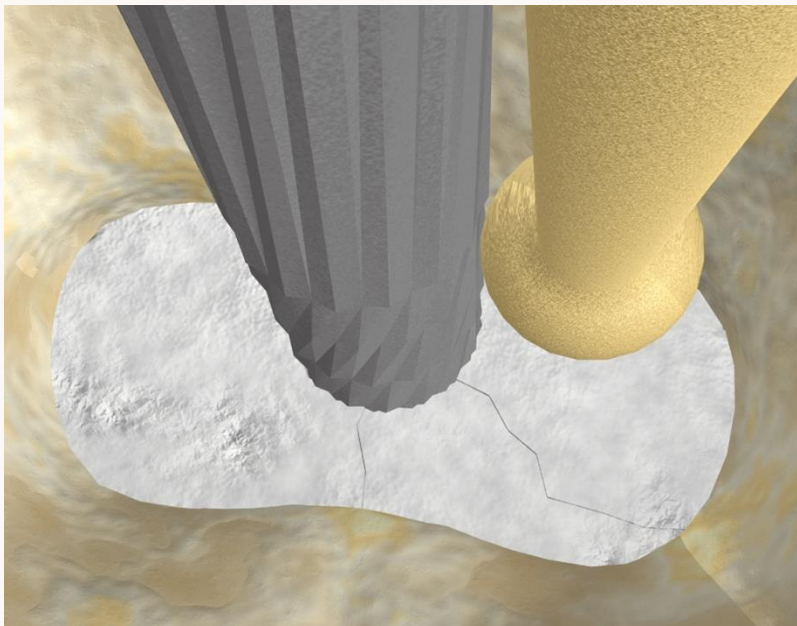

PROULTRA™

DENTSPLY

MAILLEFER



CONTINUING EDUCATION CLINICAL EDUCATION

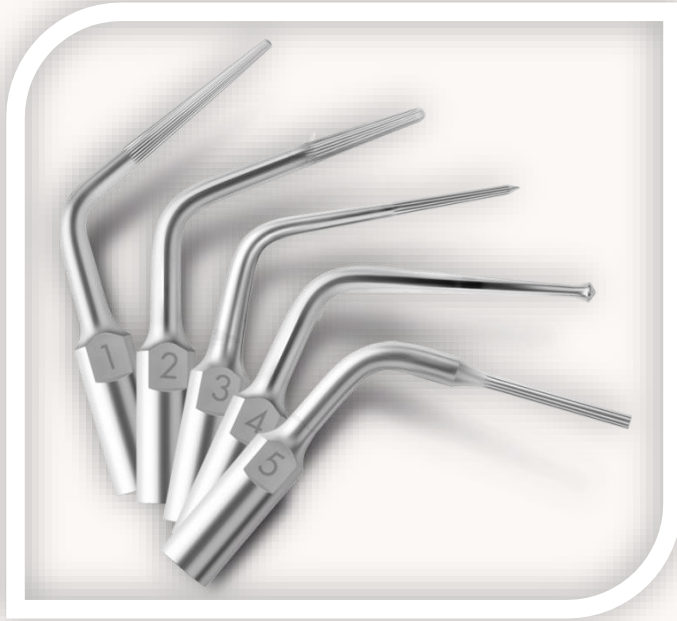

START-X™

5 tips for access cavity refinement and
canal orifice location

START-X™ #4 – METAL POST REMOVAL

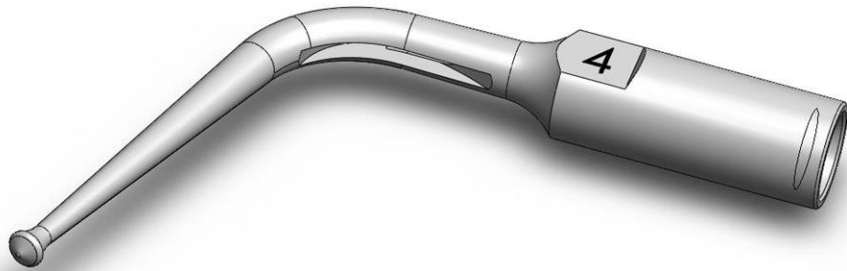

- ❑ **Specific design** → suitable for working efficiently both on the top and on the sides of the metal post
- ❑ **Water port** → avoids over heating

DENTSPLY

MAILLEFER

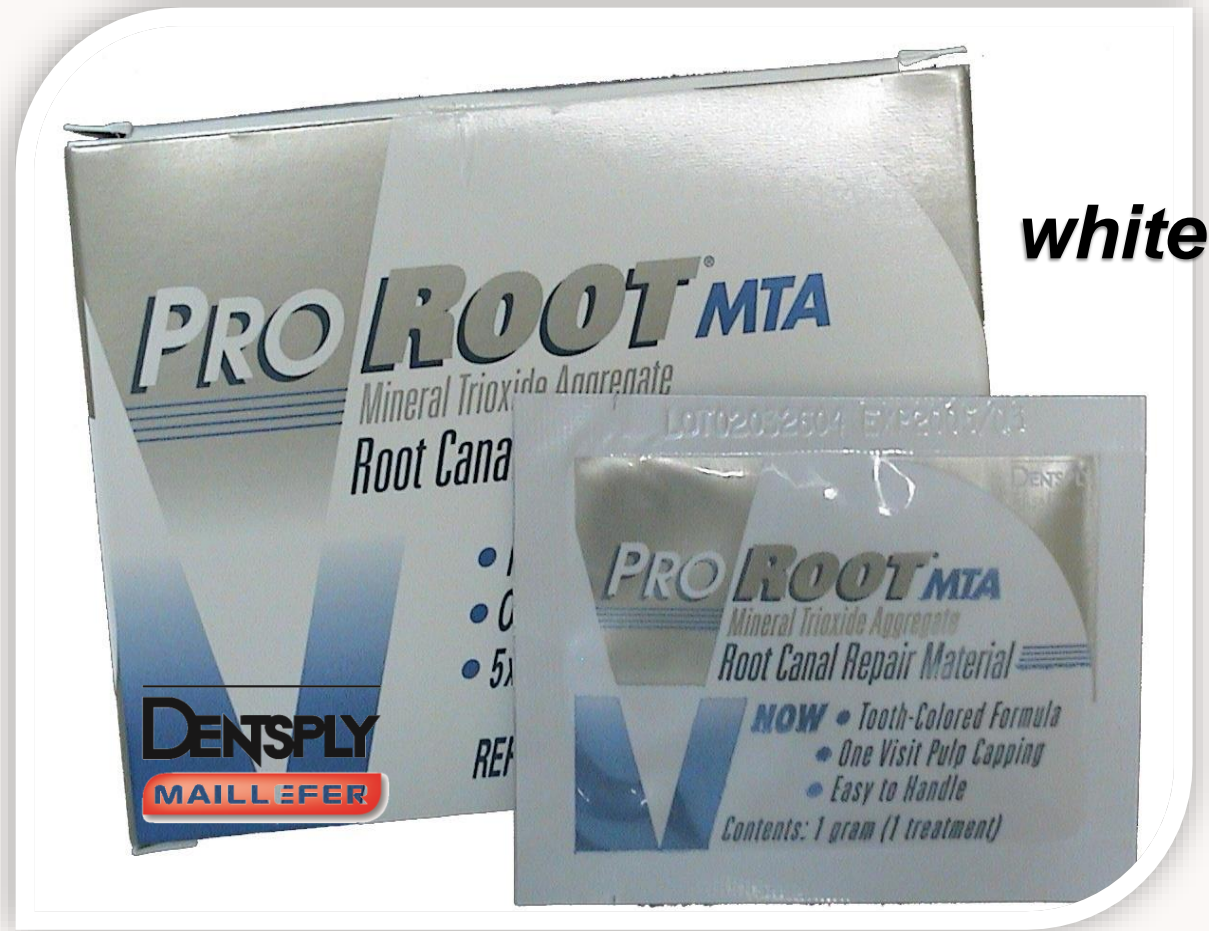

ProRoot MTA

MINERAL TRIOXIDE AGGREGATE

ProRoot MTA



PHYSICAL & CHEMICAL PROPERTIES

- pH **12,5**
- WORKING TIME **5 min.**
- SETTING TIME **4 h.**
- R. COMPRESSION **67,3 MPa (Amalgam : 311,1 Mpa)**
- RADIO OPACITY **< Amalgam**
> IRM et Super EBA

The two main properties of ProRoot MTA

➔ SEALING ABILITY

➔ BIOCOMPATIBILITY



ProRoot MTA

INDICATIONS

- ➔ PERFORATION REPAIR**
- ➔ APEXIFICATION (Apical Plug)**
- ➔ PULP CAPPING**
- ➔ ROOT-END FILLING MATERIAL**

ProRoot MTA For Perforation Repair

- Lee et al. 1993
- Pitt Ford et al. 1995
- Nakata et al. 1998
- Holland et al. 2001

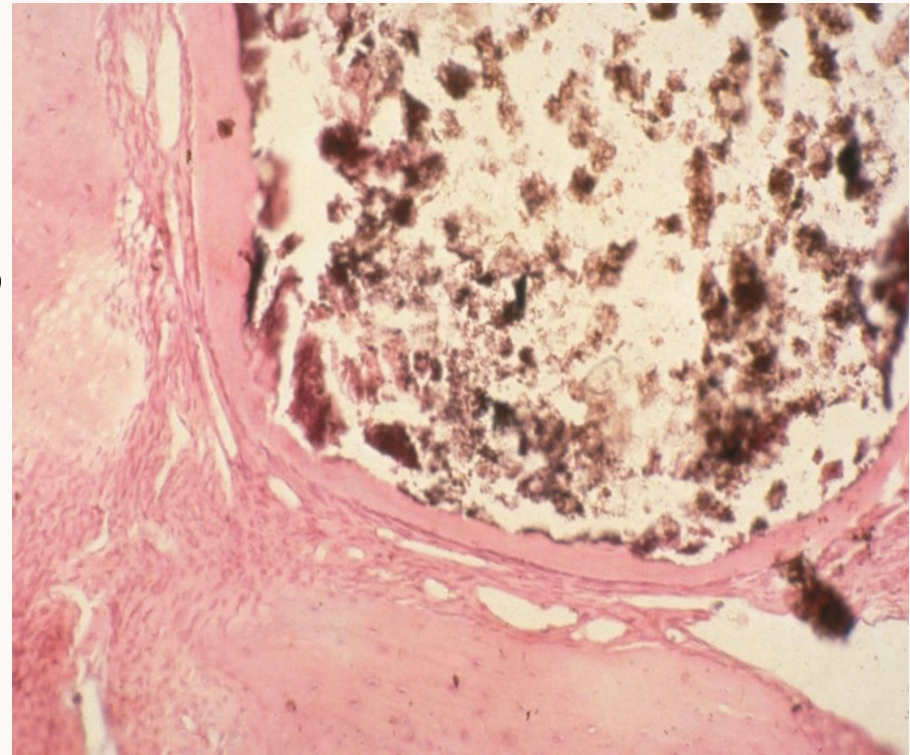

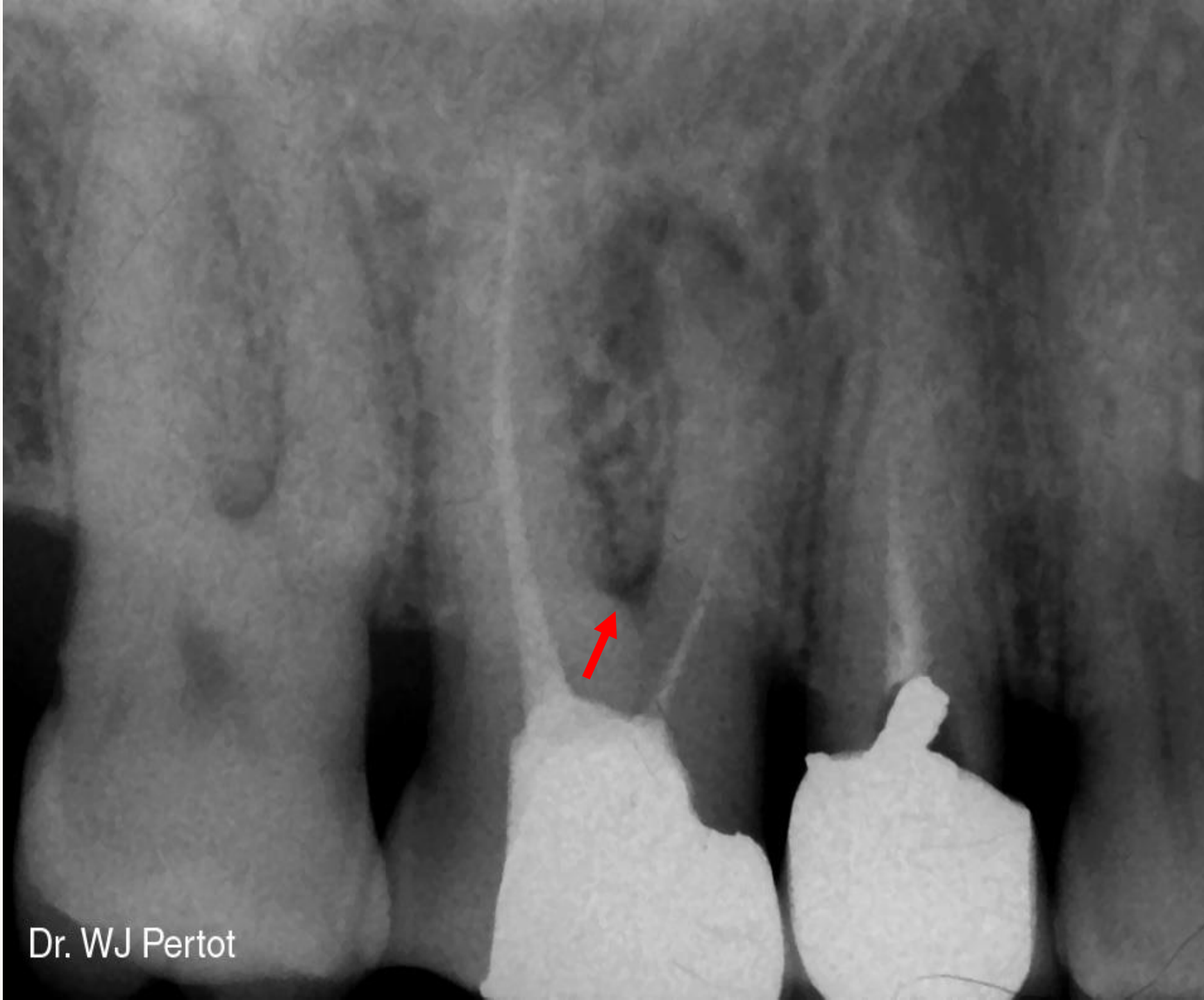

Dr. WJ Pertot

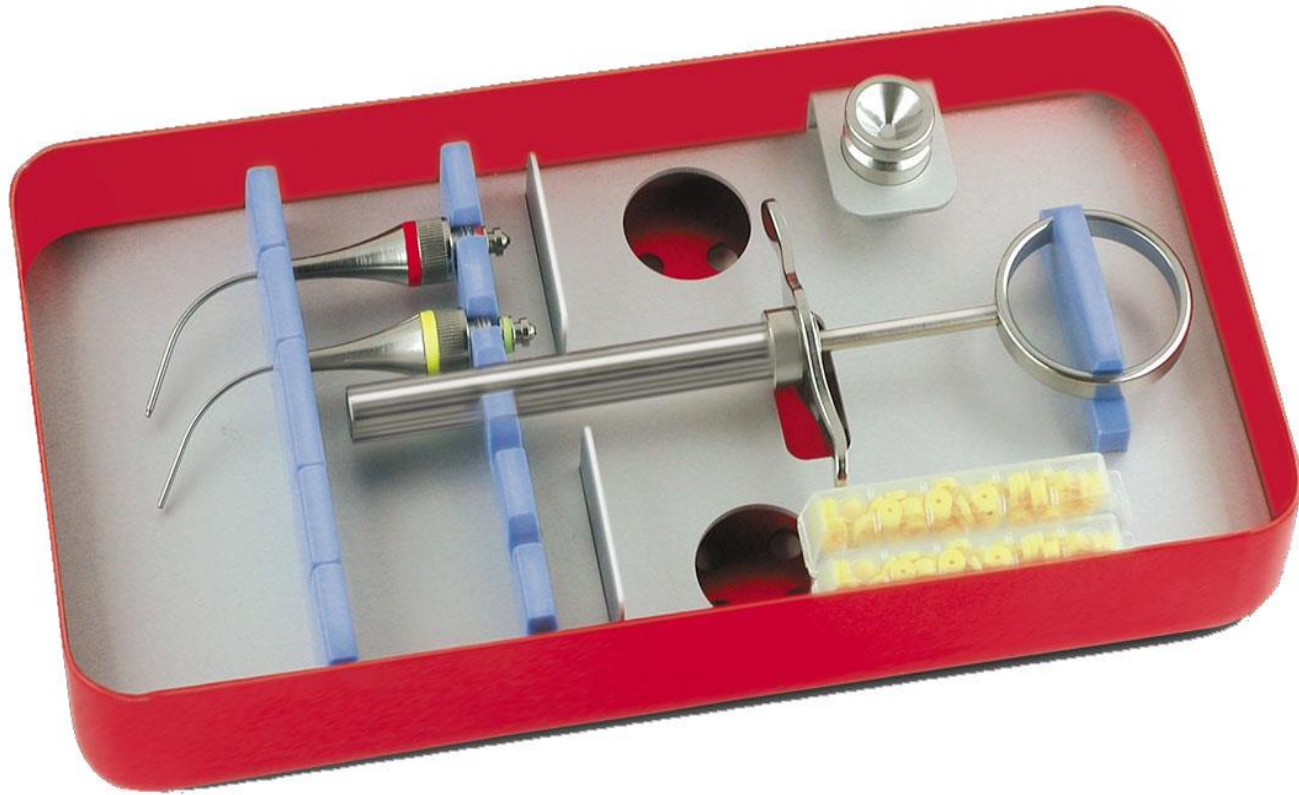

MTA GUN



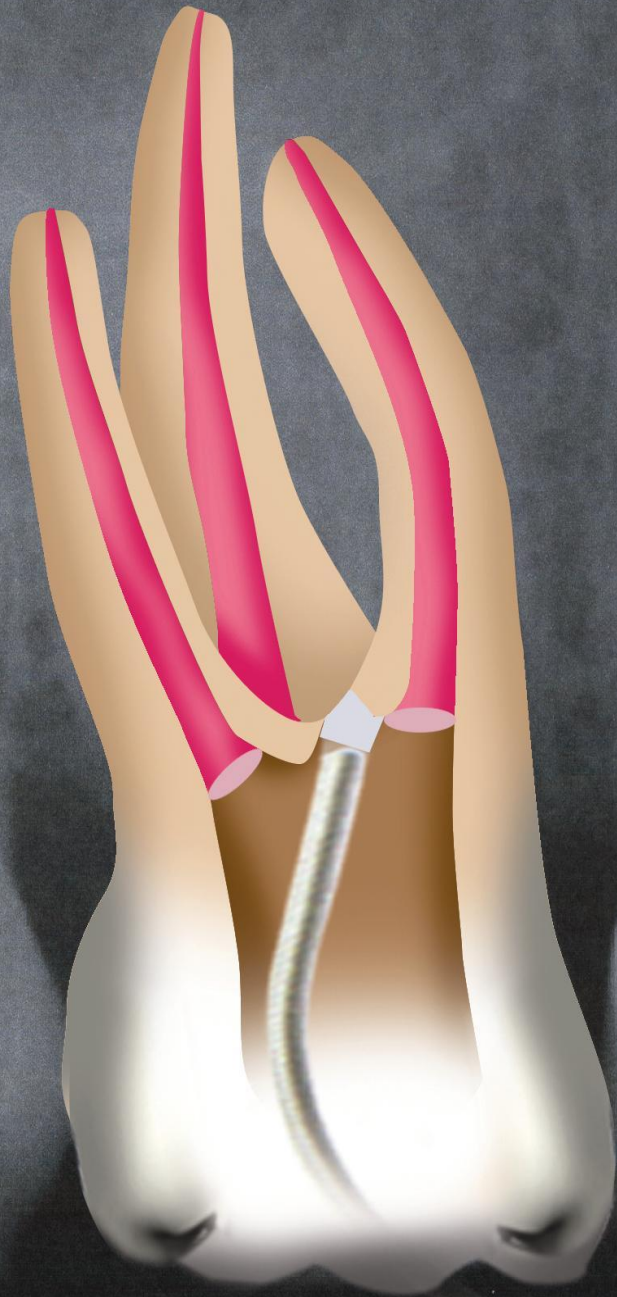

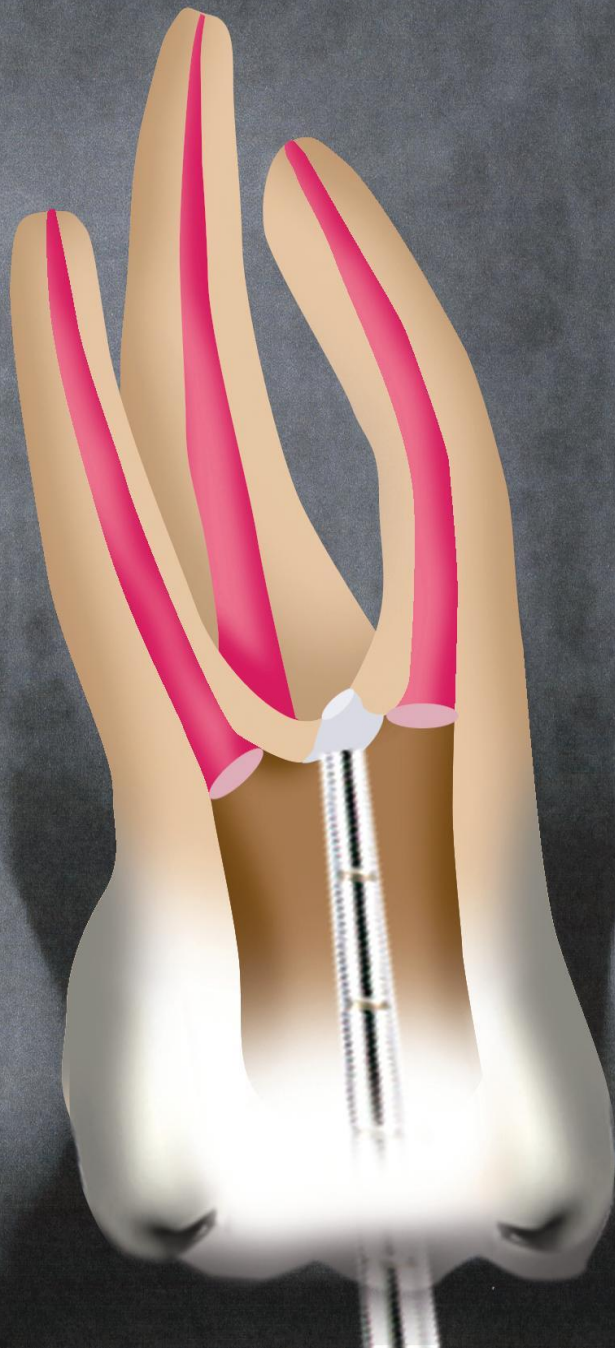



Dr. WJ Pertot

2 Yrs

PLS

Dr. WJ Pertot



ProRoot MTA

For Apexification (Apical Plugs)

- Tittle et al. 1996
- Shahabang et al. 1999
- Hachmeister et al. 2001
- Felipe et al. 2006
- Simon et al. 2007

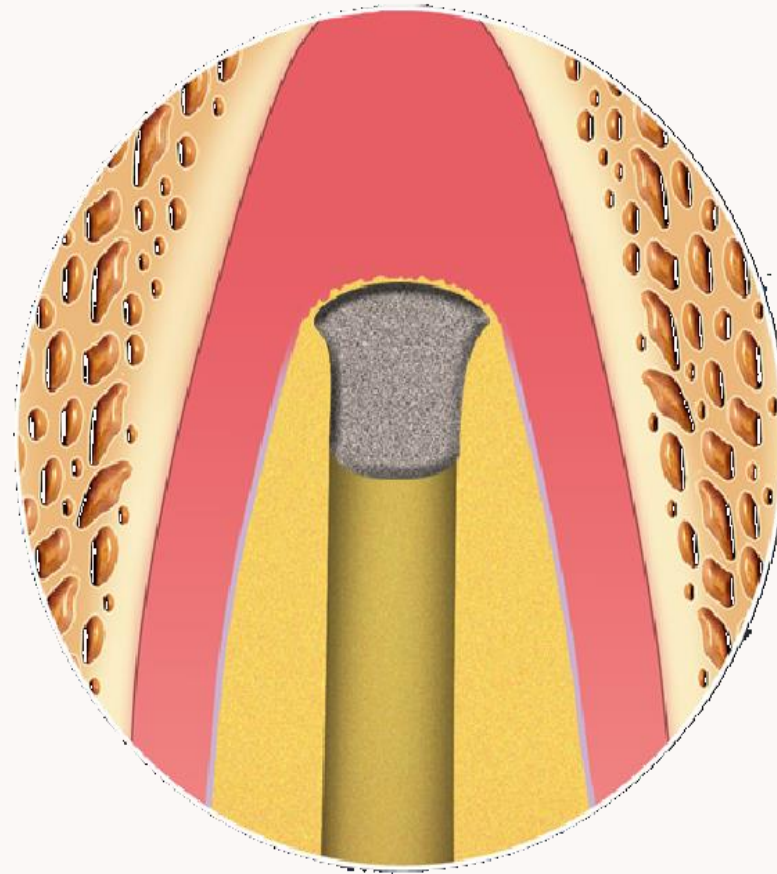

A comparative study of root-end induction using osteogenic Protein-1, calcium hydroxide and Mineral Trioxide Aggregate in dogs.

Shahabang *et al.* J Endodon 1999 ; 25 : 1-5.



% of roots with apical closure

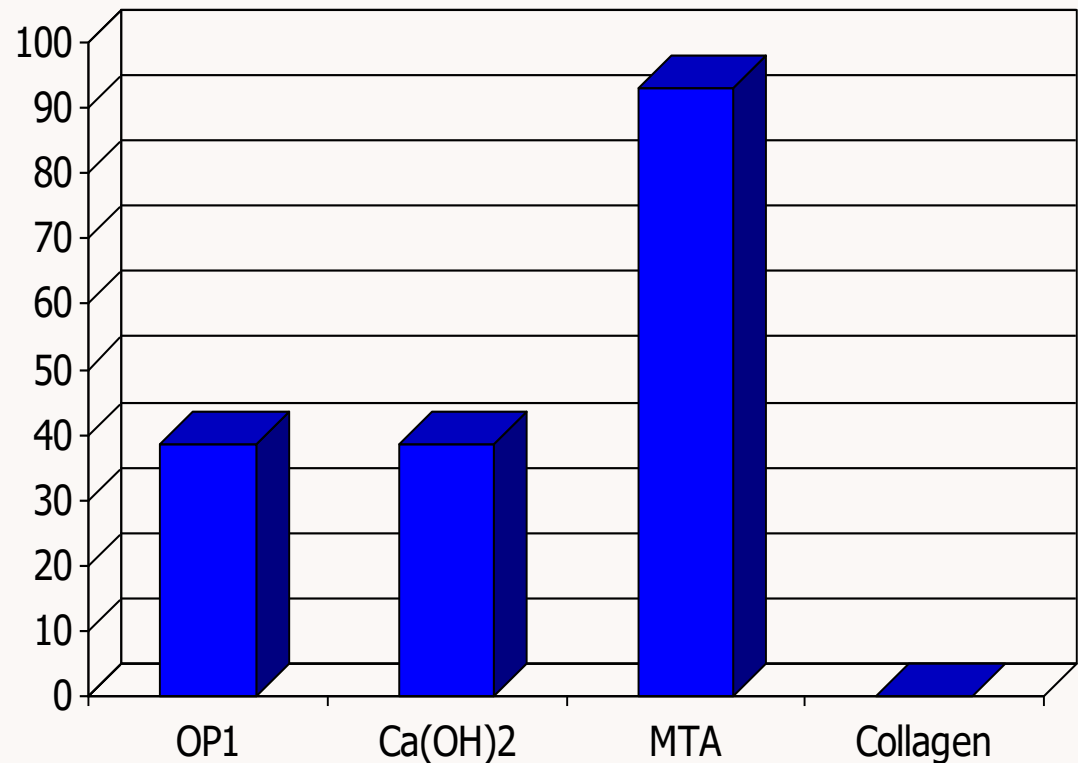

Dr. WJ PERTOT



Dr. WJ PERTOT

1 yr

