

- **Pharmacokinetic principles**
- **Drug absorption, distribution,  
metabolism and elimination**

# Pharmacokinetics

**Occupation theory:** The intensity of pharmacological response (E) is proportional to the concentration of reversible drug-receptor complex

**= Action of a drug requires presence of a certain concentration in the fluid bathing the target tissue.**

Pharmacokinetics deals with the processes of

absorption,  
distribution,  
metabolism  
excretion of the drug

A }  
D } **invasion** }  
M } **elimination** } **“ADME”**  
E }

And their relationship with their biological  
(pharmacological) effect

**„WHAT DOES ORGANISM DO WITH THE DRUG“**

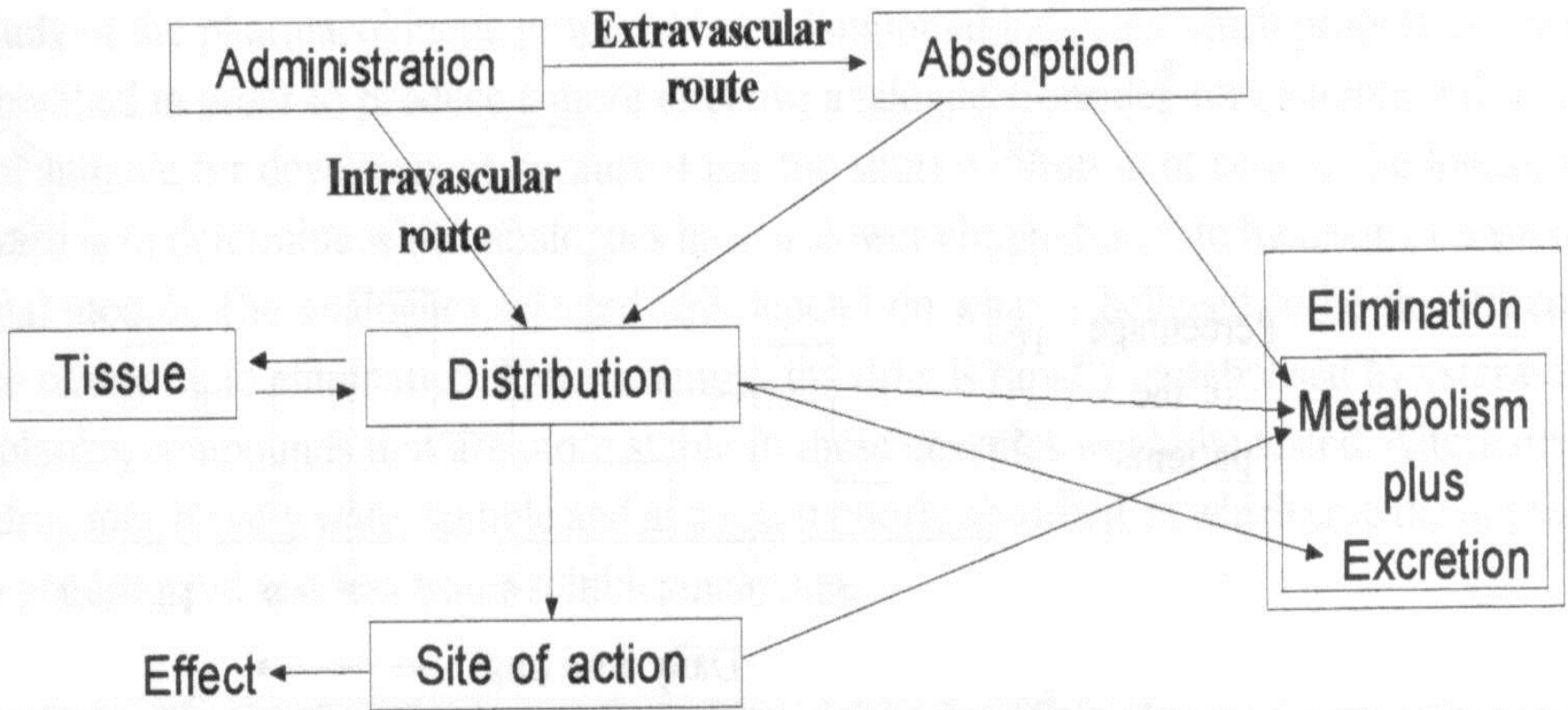

The general stages and their relationships in the life cycle of a drug after administration.

# What does influence the movements of the drug in the body?

## physico-chemical properties

lipophilic/hydrophilic properties, molecule structure, pKa, charge...

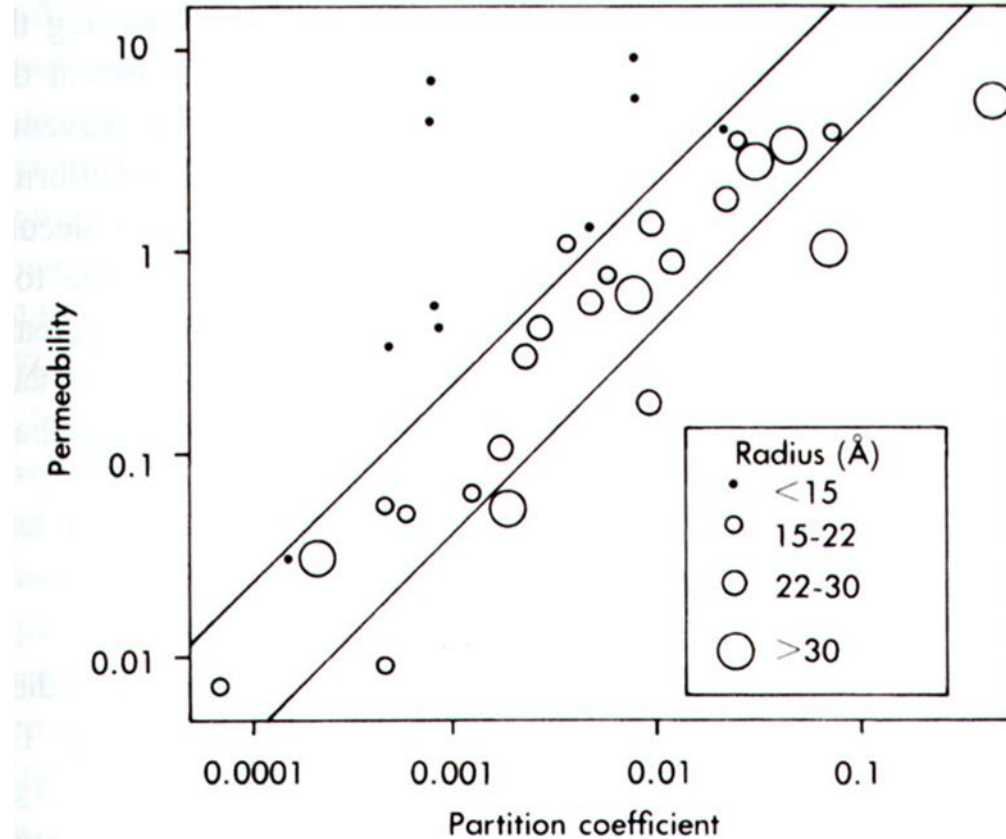

Ionized compounds tend to be *less* lipid soluble.

Non-ionized compounds tend to be *more* lipid soluble.

# What does influence the movements of the drug in the body?

## physico-chemical properties

lipophilic/hydrophilic properties, molecule structure, pKa, charge...

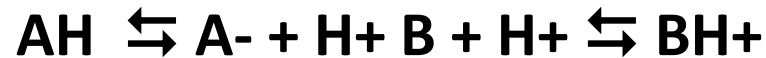

## permeation across the membranes

lipophilic – diffusion (passive)

hydrophilic – through the pores

active transport

## bonds of the drugs to:

plasma proteins

blood cells in the circulation

tissue

receptors

## perfusion of the tissues

a) brain, heart, liver, kidney

b) fat tissue

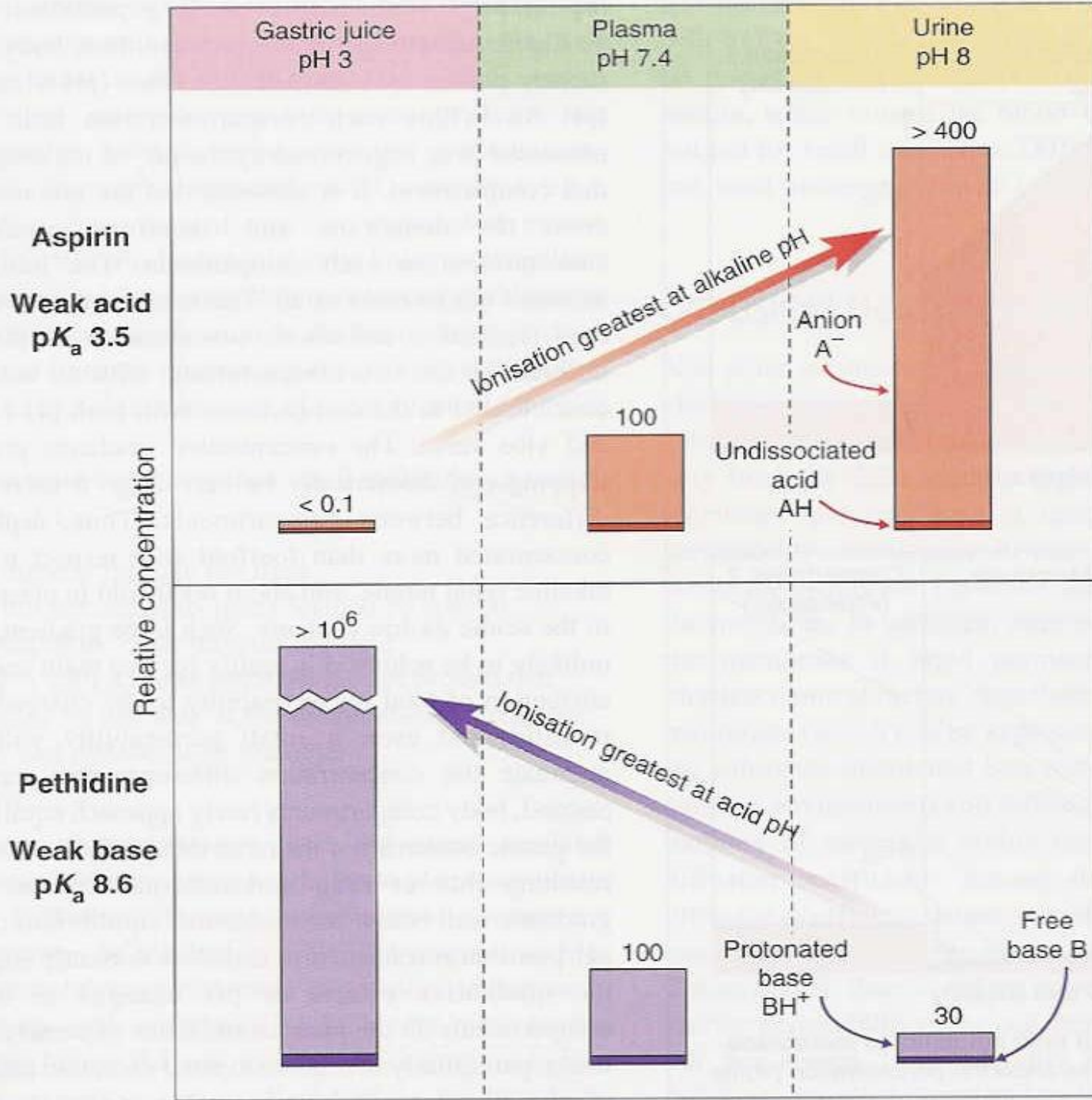

Bases Acids

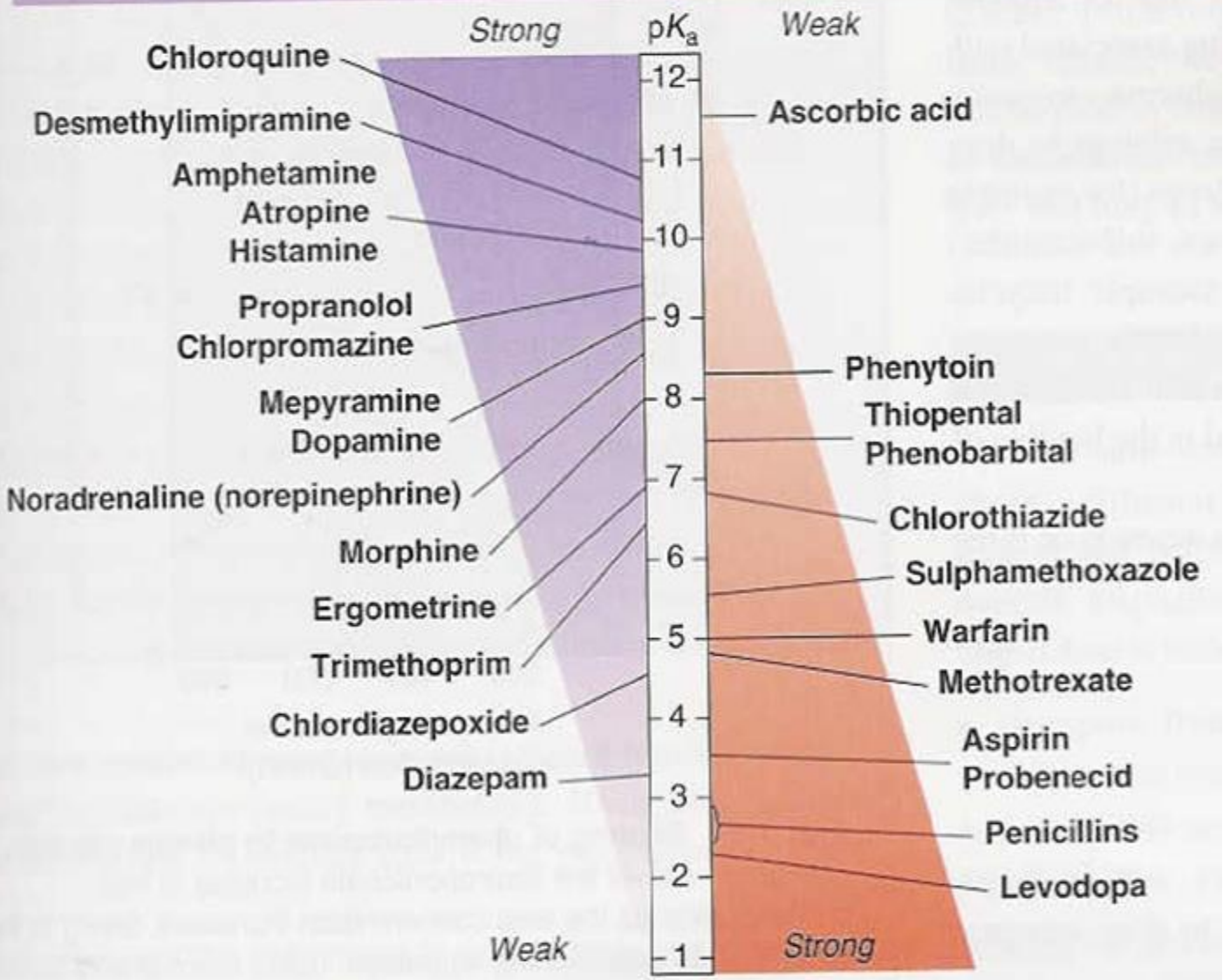



**active transport *via*  
transport proteins**

**diffusion**

**OATP, MDR, MRP**

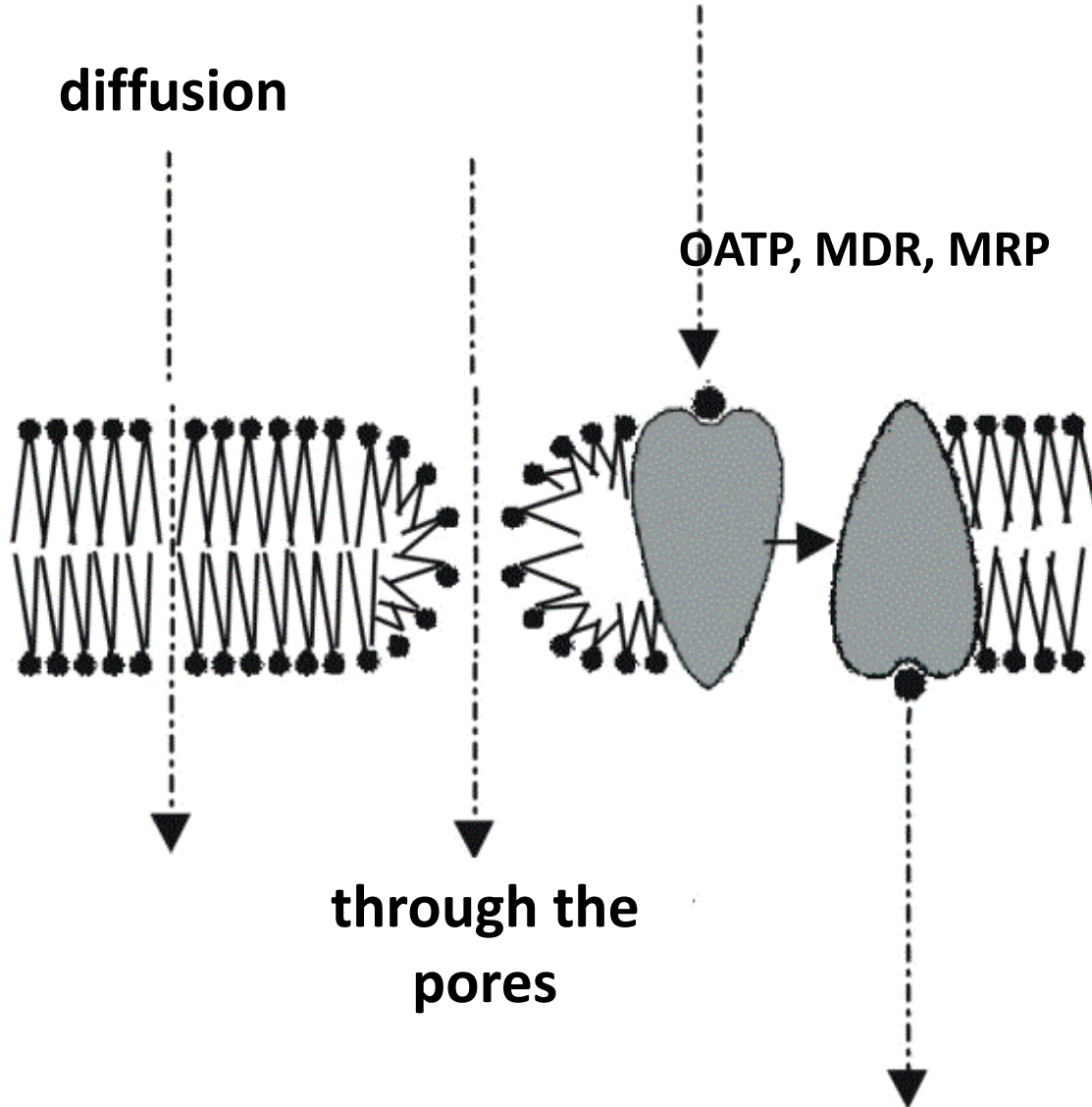

**through the  
pores**

# What does influence the movements of the drug in the body?

## physico-chemical properties

lipophilic/hydrophilic properties, molecule structure, pKa, charge...



## permeation across the membranes

lipophilic – diffusion (passive)

hydrophilic – through the pores

active transport

## bonds of the drugs to:

plasma proteins

tissue

blood cells in the circulation

receptors

## perfusion of the tissues

a) brain, heart, liver, kidney

b) fat tissue

# ABC - ATP-BINDING CASSETTE

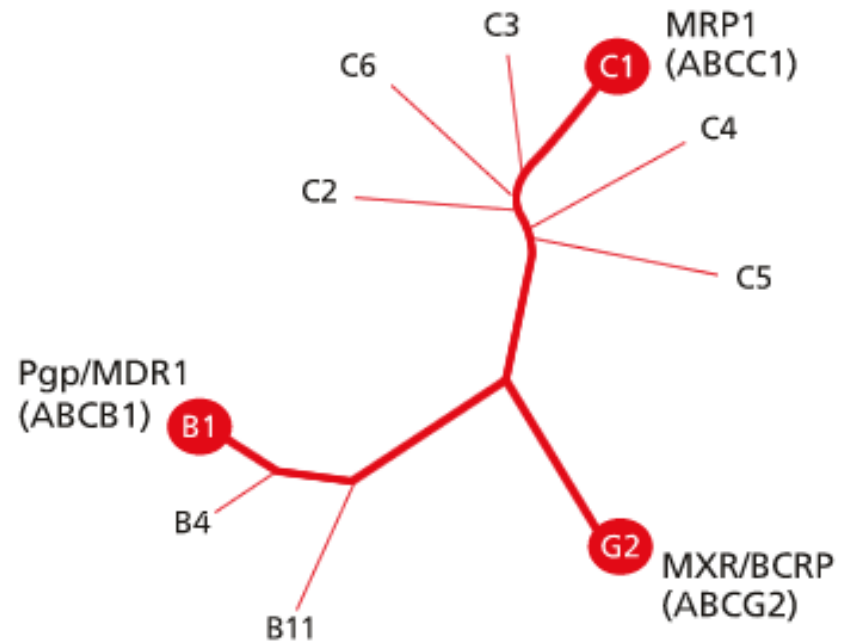
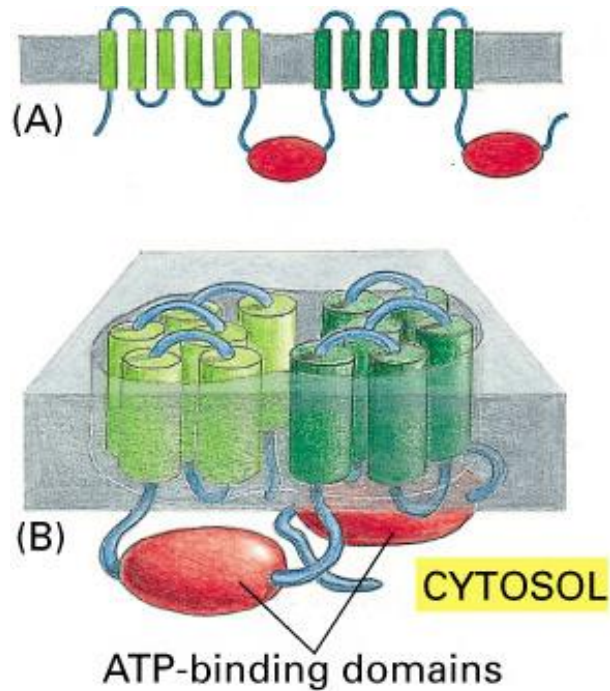

## ABC - ATP-BINDING CASSETTE

- **MDR - multi drug resistance**
- **MRP - multidrug resistance associated protein**
- **MXR - mitoxantrone resistance protein**
  
- **Pgp - P-glycoprotein pump**

# What does influence the movements of the drug in the body?

## physico-chemical properties

lipophilic/hydrophilic properties, molecule structure, pKa, charge...



## permeation across the membranes

lipophilic – diffusion (passive)

hydrophilic – through the pores

active transport

## bonds of the drugs to:

plasma proteins

tissue

blood cells in the circulation

receptors

Concentration of free drug

Afinity for binding sites

Conc. of protein

## perfusion of the tissues

a) brain, heart, liver, kidney

b) fat tissue

- plasma proteins
- tissue
- blood cells in the circulation
- receptors

- most of **acidic** drugs (at pH of 7.4= anions) are bound on albumin:
  - salicylates, sulfonamides, penicillins
- most of **alkalic + neutral** drugs (at pH of 7.4= cations) are bound on  $\alpha_1$ -acidic glycoprotein and lipoproteins:
  - quinidine, digitoxine, TCA, cyclosporine A

- Bonds with plasma proteins are
  - reversible
  - dynamic
  - competitive



drug	% bound
caffeine	10
digoxin	23
gentamicin	50
phenytoin	87
digitoxin	95
diazepam	96
warfarin	98
tolbutamide	99

# A bound drug has no effect!

**Amount bound depends on:**

- 1) free drug concentration
- 2) the protein (binding sites) concentration
- 3) affinity for binding sites

$$\% \text{ bound: } \frac{[\text{bound drug}]}{[\text{bound drug}] + [\text{free drug}]} \times 100$$

## Bonds in peripheral tissues

- specific for some of the drugs
  - tetracycline antibiotics - hydroxyapatit
  - chloramfenicol – skin
  - griseofulvin - skin
  - arsenic – in hair

# ABSORPTION

**Absorption** – permeation of the soluted drug into the body fluids from the site of administration – necessary for the general (systemic) effect

**topical effect** – on the skin, mucous membranes...  
mouth, rectum, vagina

- absorption is fault, can cause difficulties, adverse effects)

(local anesthetics, corticosteroids)

**Rate and extent of absorption are described by the parameters :**

**C max** - max. concentration of the drug in the plasma after single administration

**T max** - time after administration, when is Cmax

**F** - bioavailability (extent of absorption)

# Plasmatic concentration of the drug

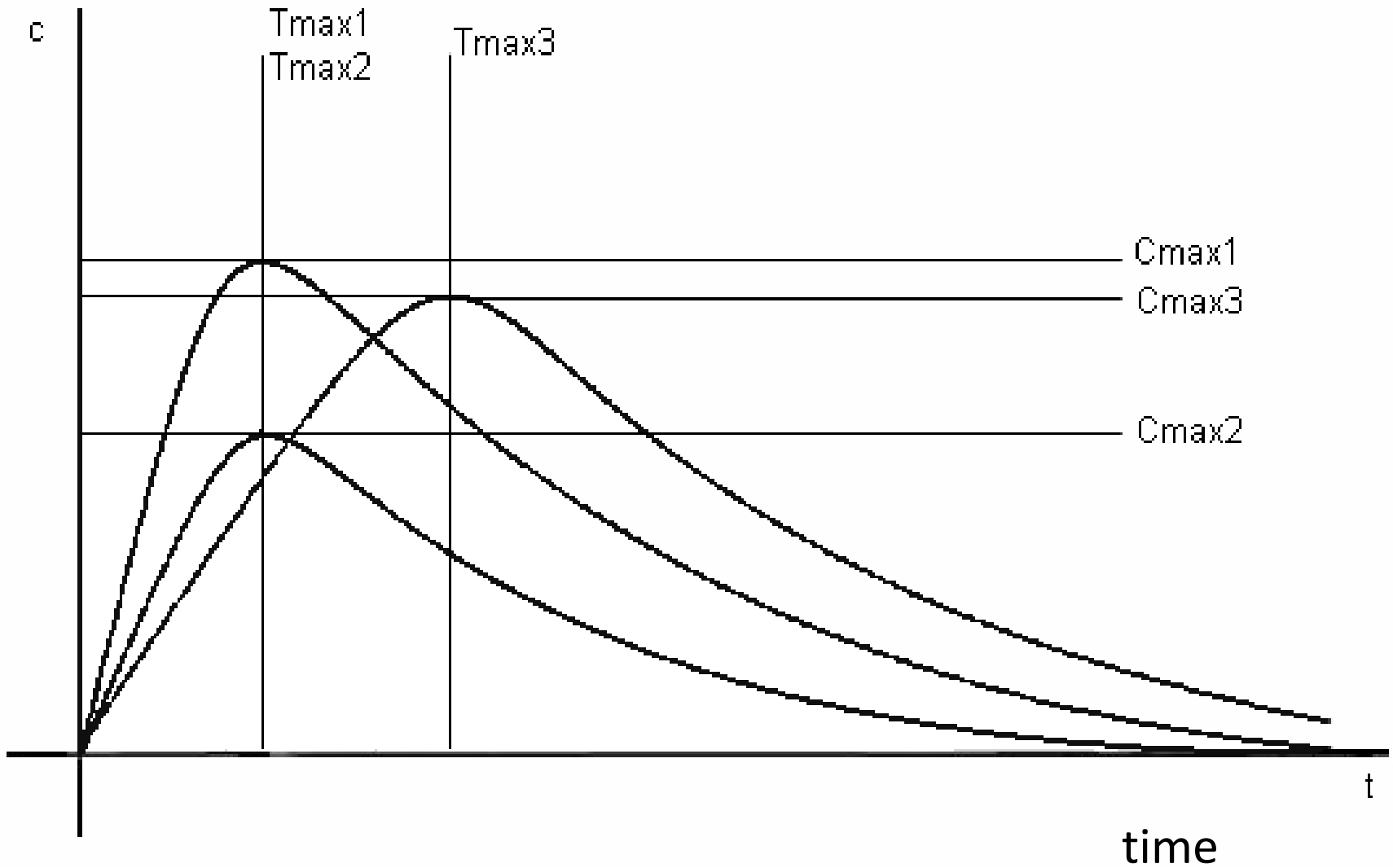

# Bioavailability

- The fraction of the dose of a drug (F) that enters the general circulatory system,

$$F = \frac{\text{amt. of drug that reach systemic circul.}}{\text{Dose administered}}$$

$$F = \text{AUC}_{\text{p.o.}} / \text{AUC}_{\text{i.v.}}$$

# Bioavailability

Extravascular route - 0-100% (resp. 0-1).

Intravenous - 100% = 1

If F is 0-20% = 0-0,2 – not suitable route of administration

(in spite of that fact, some drugs are administered, even if the  $F < 2-5\%$ , such as SET, bisphosphonates).

$$F = \text{AUC}_{\text{po}} / \text{AUC}_{\text{iv}}$$

**(the same drug, same dose, same patient)**

# Bioavailability

- A concept for oral (extravascular) administration
- Useful to compare two different drugs or different dosage forms of same drug
- depends, in part, on rate of dissolution (which in turn is dependent on chemical structure, pH, partition coefficient, surface area of absorbing region, etc.) Also first-pass metabolism is a determining factor



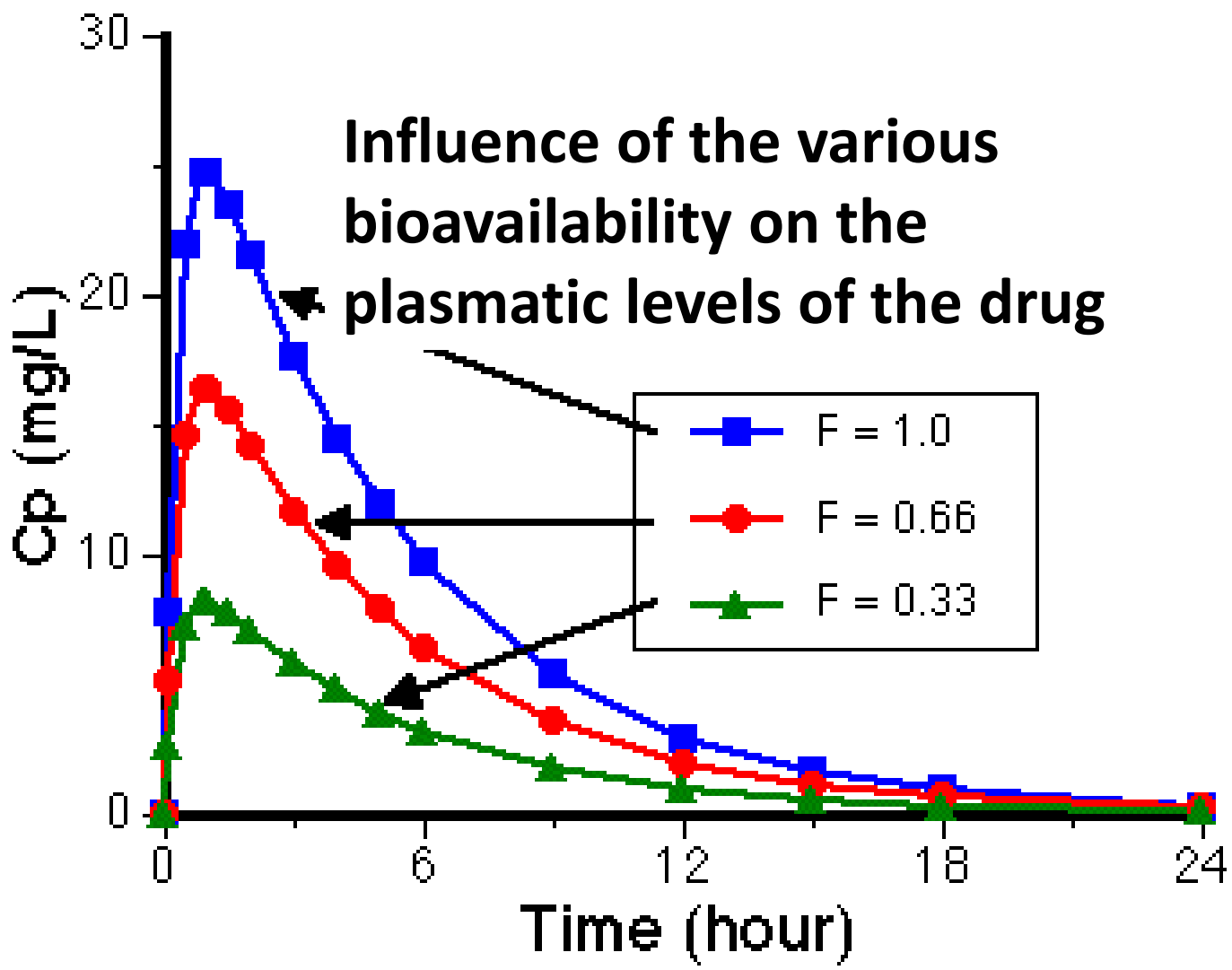

# Area under curve (AUC)

- Is a measure of bioavailability

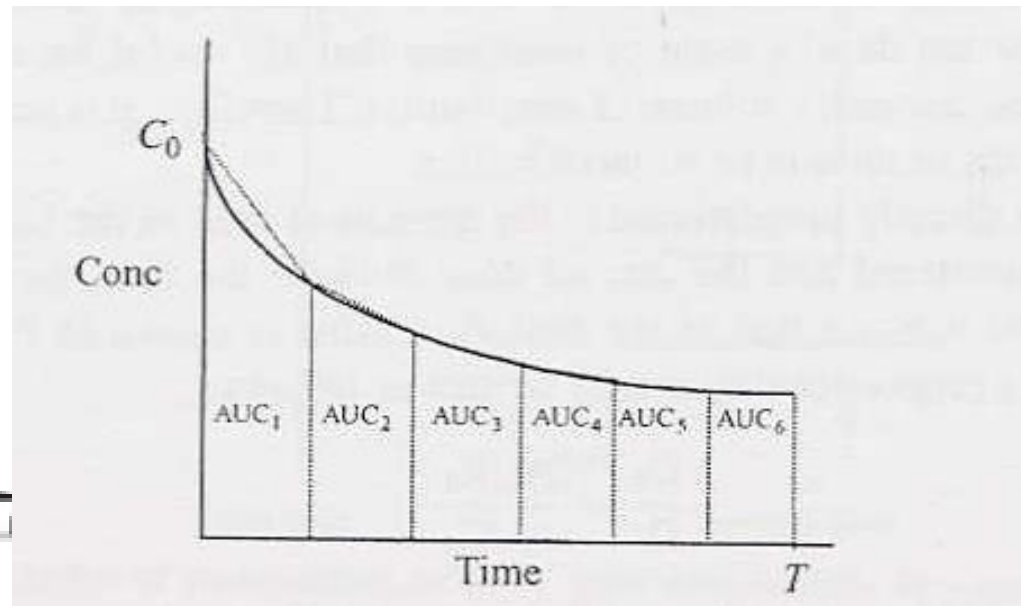
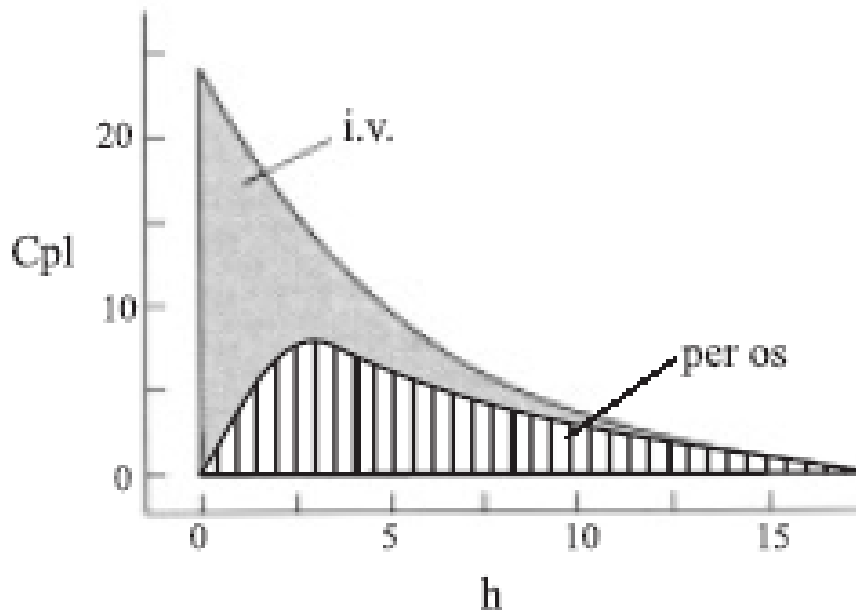

# First pass effect, presystemic elimination

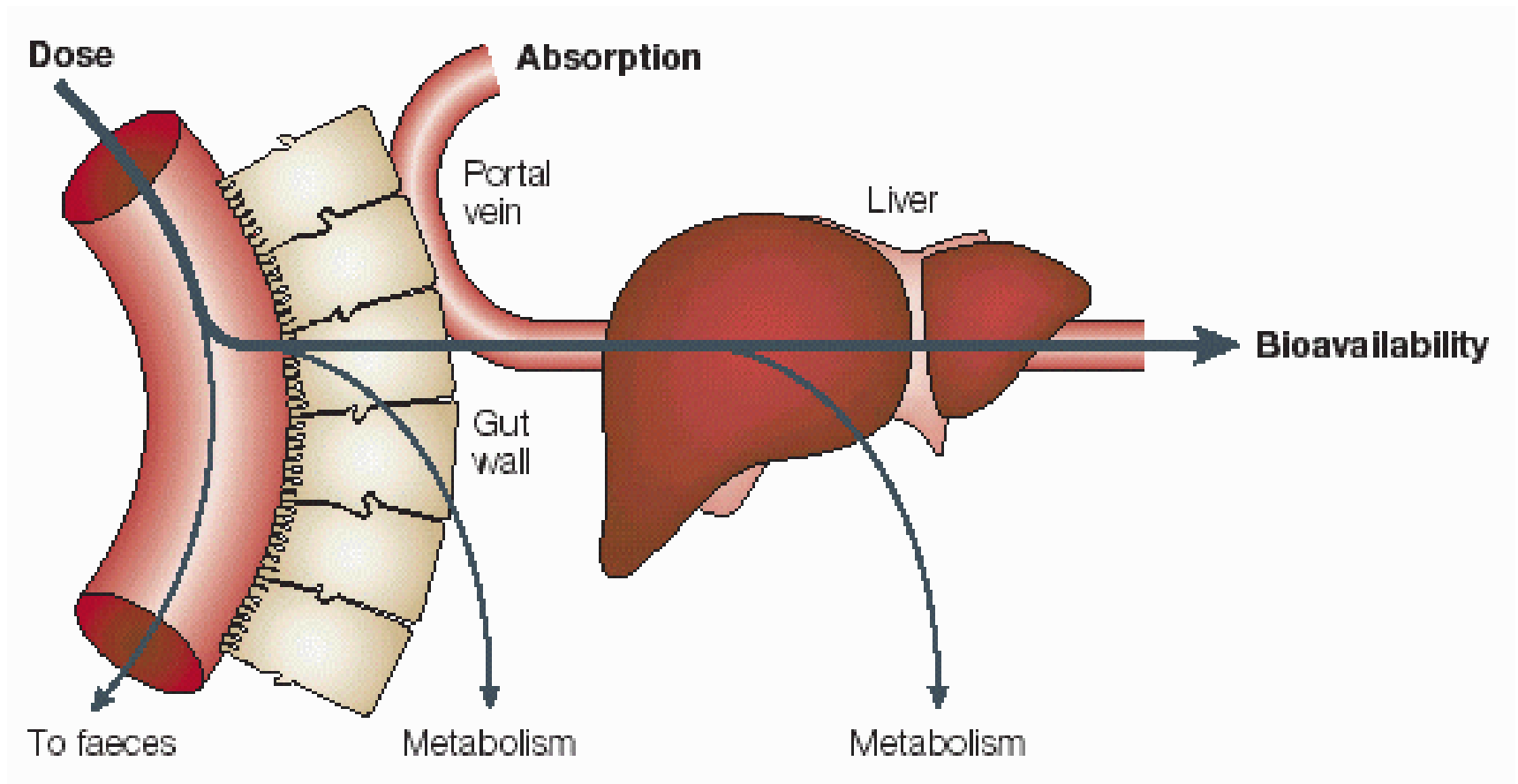

## Factors influencing absorption

Drug-dosage form– tbl./ sol./ supp./ TTS/tbl.subling.

Way of administration

Physico-chemical properties of drugs

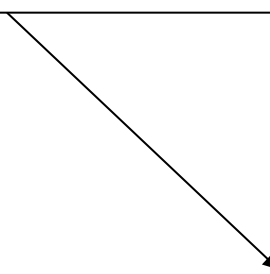
- 
- absorptive surface area
  - concentration gradient
  - ionization, lipofility
  - interactions

## Other factors influencing the absorption

gender, body weight, plasma volume, gastric emptying rate,

age - pH, bile, enzyme levels and activity

patophysiological state – liver diseases,  
inflammation

simultaneously eaten meal –

acceleration/deceleration

chemical incompatibilities

function of the GIT

# Factors affecting pharmacokinetics

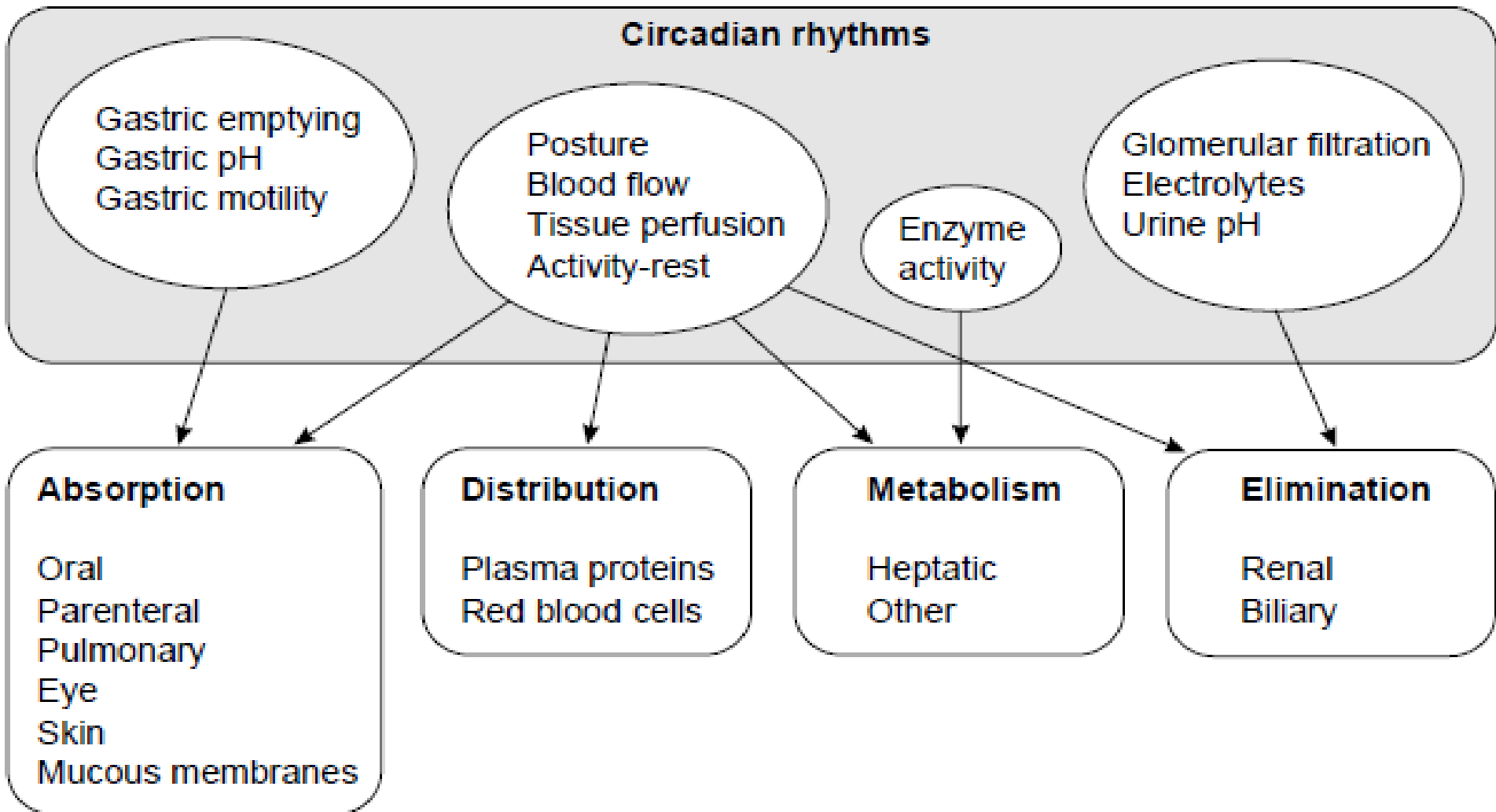

# Drug dosage forms of the 1st and 2nd generations

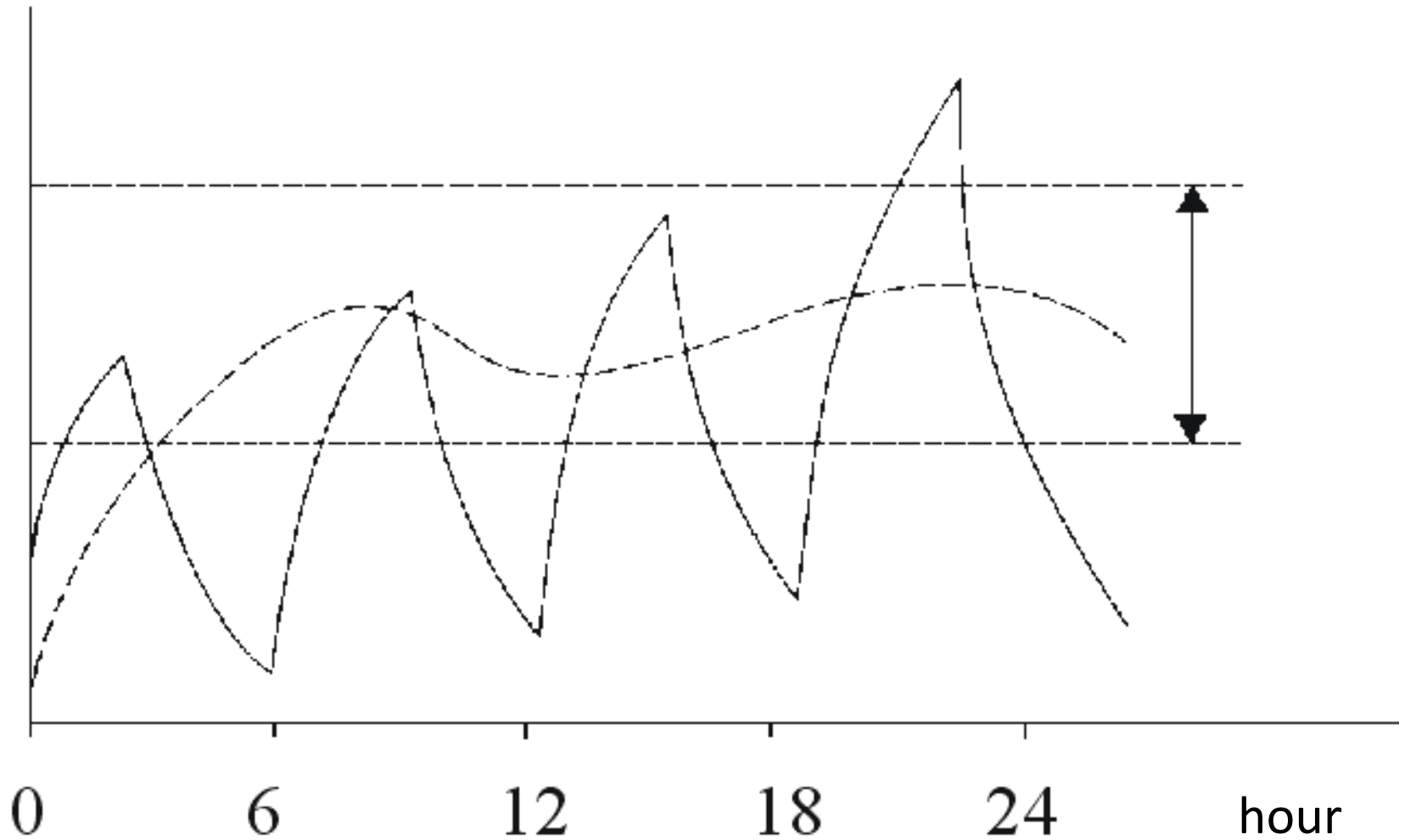

# Distribution

= permeation from the body blood to the tissues and site of the action is dynamic process

**rate** - depends on:

bonds (with the plasmatic proteins...)

permeation across the membrabes

blood perfusion through the organ

**state** - distribution equilibrium; the the proportion of the free (unbounded) fractions of the drug in the blood and in the tissues are the same

Barriers – the distribution is limited

blood-brain barrier („leaky areas“ – area postrema),

penicilines X aminoglycosides

placental barrier...

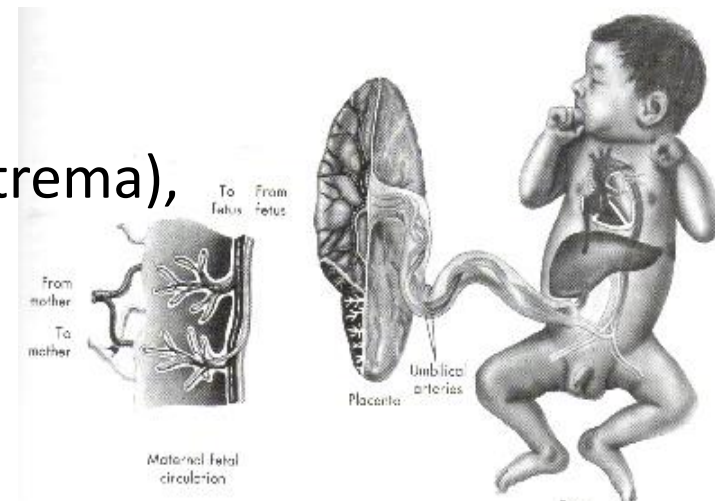



# Volume of Distribution

**Volume of distribution** – apparent, hypothetical

the proportion of the quantity of the drug and reached plasmatic concentration

$$V_d = D/C$$

- $V_d$  is the apparent volume of distribution
- $C$  = Conc of drug in plasma at some time
- $D$  = Total quantity (dose) of drug in system

$V_d$  gives one as estimate of how well the drug is distributed.

Value  $< 0.071$  L/kg indicate the drug is mainly in the circulatory system. Values  $> 0.071$  L/kg indicate the drug has gotten into specific tissues.

# Volumes of the water in human body

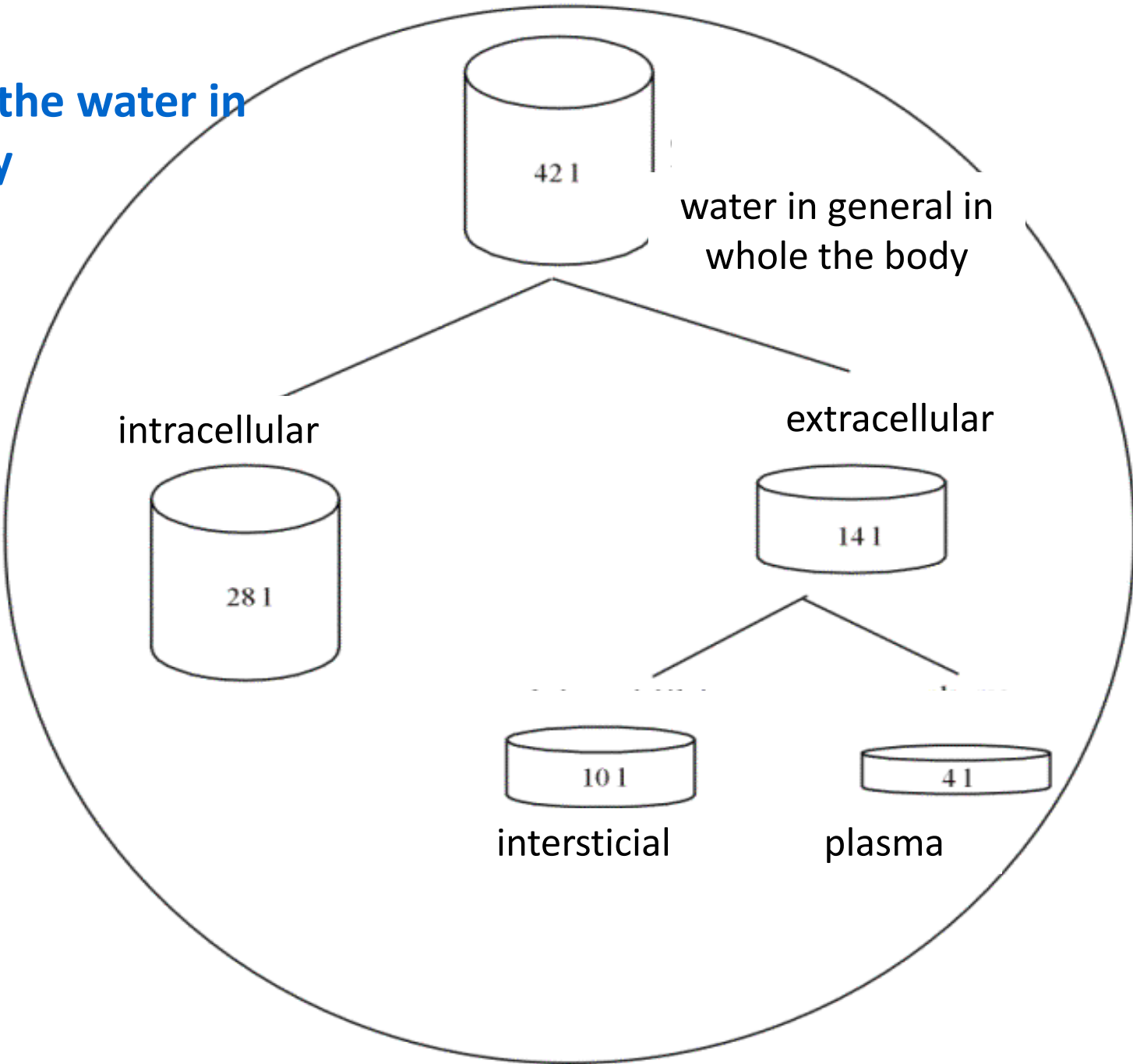

## Perfusion through the organs

organ	perfusion rate (ml/min/g tkáně)	% heart output
brain	0.5	14
fat	0.03	4
heart	0.6	4
kidney	4.0	22
liver	0.8	27
musculature	0.025	15
skin	0.024	6

# ELIMINATION = biotransformation + excretion



- Kinetics of the first order

= rate of elimination is descending with the descending concentration in the blood  
(linear kinetics)



- Kinetics of the zero order

= rate of elimination is constant (nonlinear kinetics)

# Types of Kinetics Commonly Seen

## • Zero Order Kinetics

- Rate =  $k$
- $C = C_0 - kt$
- C vs. t graph is LINEAR

## First Order Kinetics

- Rate =  $k C$
- $C = C_0 e^{-kt}$
- C vs. t graph is NOT linear, decaying exponential.
- Log C vs. time graph is linear.

# First Order Kinetics

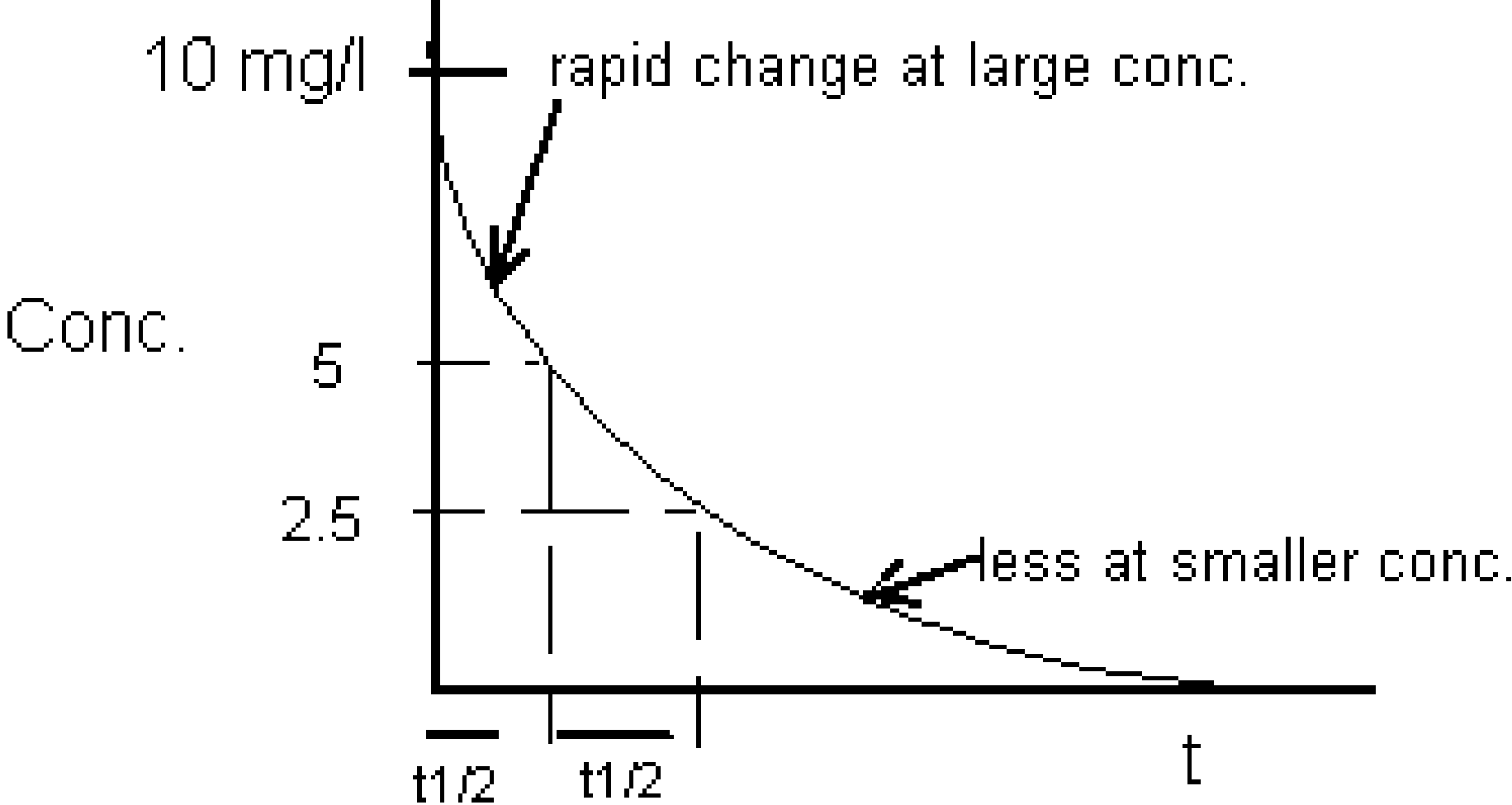

# ELIMINATION

## Biotransformation – metabolism

### Sites of biotransformation

anywhere, where the enzymes are present: plasma, kidney, lung  
GIT, brain, but especially **liver**

### Enzymatic

- **biodegradation**
- **bioactivation (prodrug)**
  - enalapril-enalaprilate
  - codein-morphine
  - bromhexin - ambroxol

**1. Phase :** oxidation, hydrolysis

Cytochrom P450, dehydrogenases

**2. Phase :** conjugation – metabolites are more soluble in the water

Metabolite - effective („more / less / in other way“)

- ineffective

- toxic



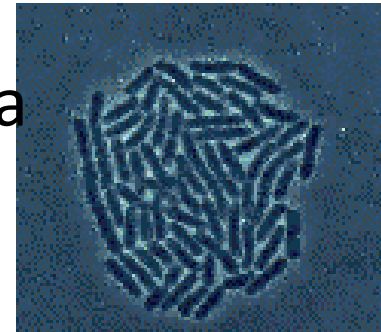
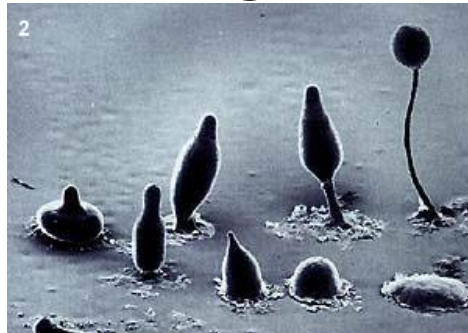
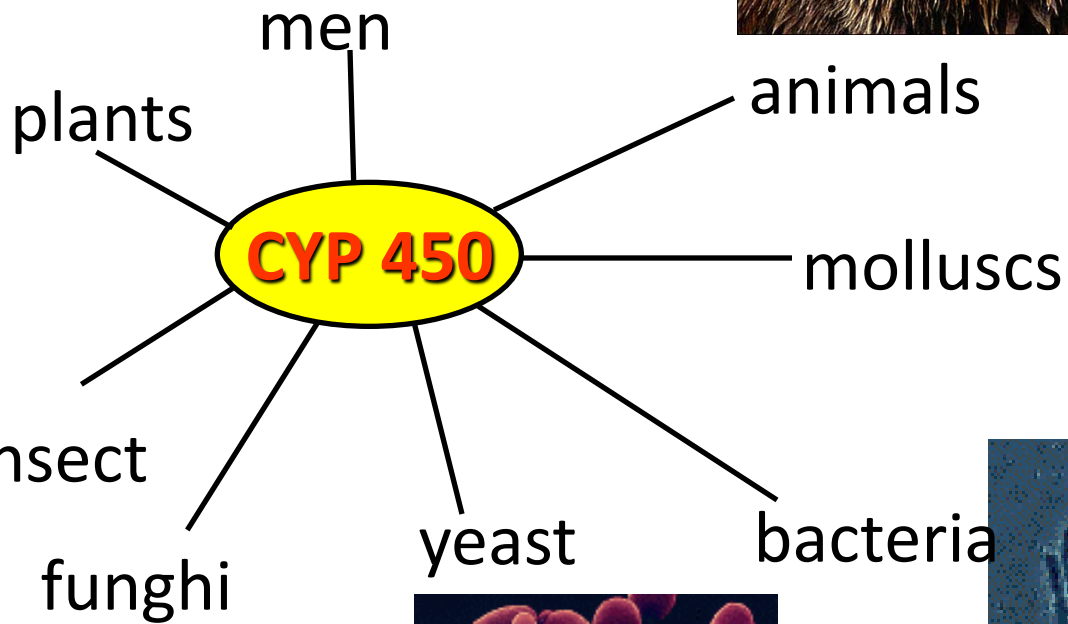
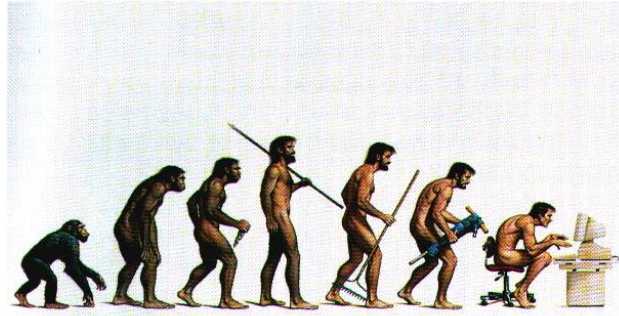

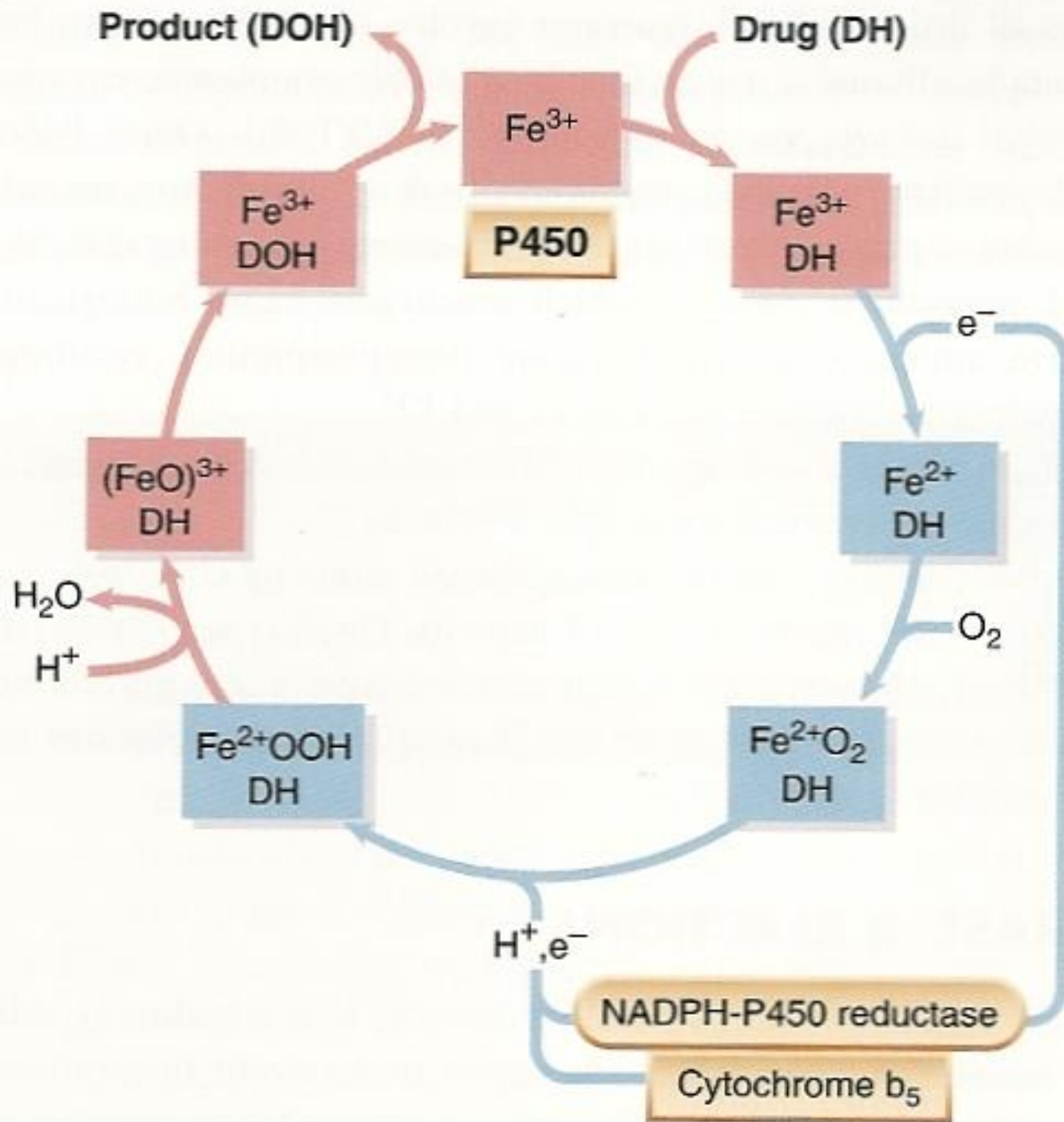

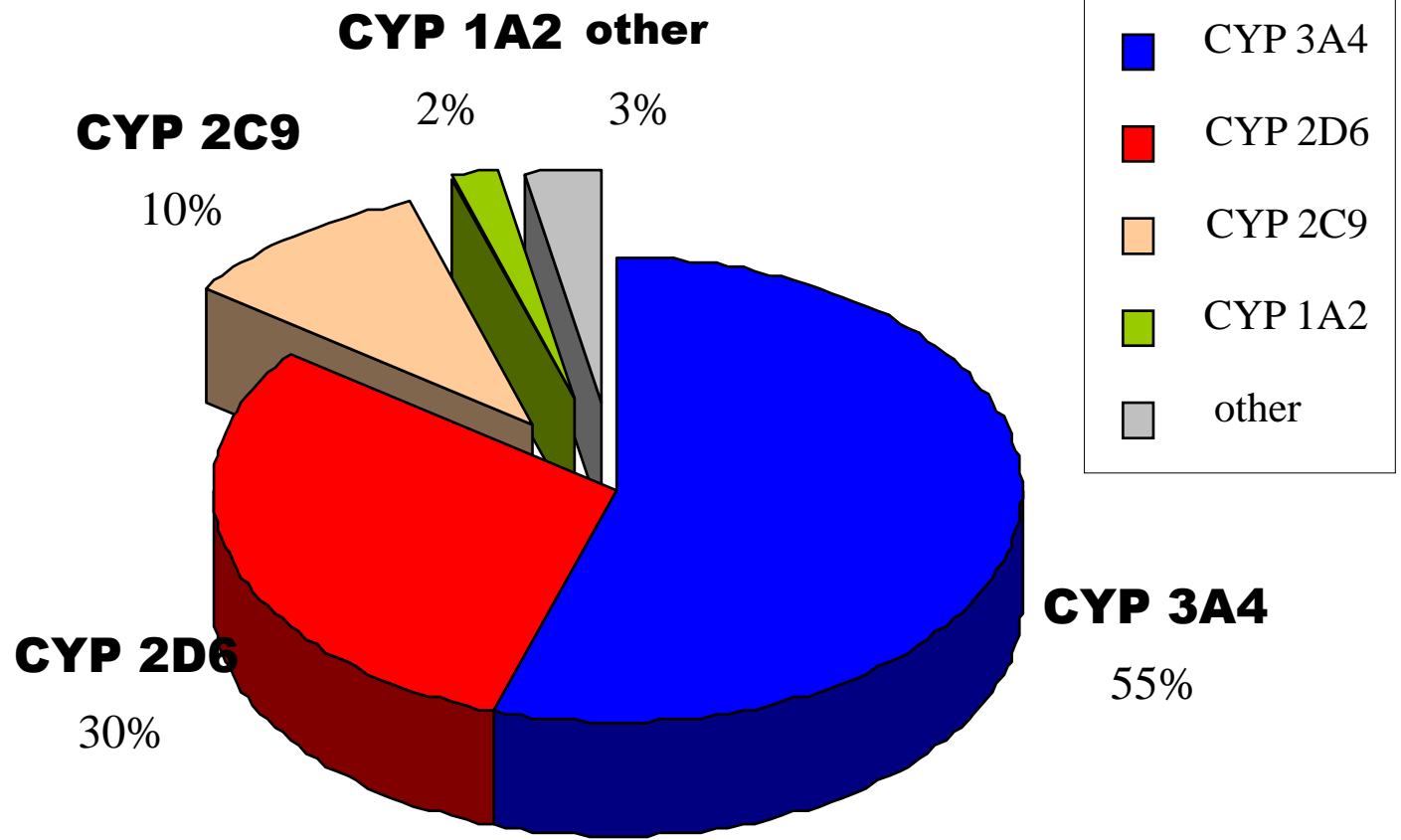

# Genetic polymorphism

Genetic polymorphism = the existence of several (At least two ) alleles for the gene from which At least part has a population frequency of at least 1 %

- Pharmacogenetics focuses on the study of genetically conditioned variability in the response to a drug
- Pharmacogenomics examines the relationship of drug effect on the level of the whole genome, respectively transcriptome

# Genetic polymorphism of biotransformation enzymes

Polymorphism in the gene of *N - acetyltransferase*

- Inactivation of drugs in the liver : slow x fast acetylators
- Isoniazide , procainamide, hydralazine
- Peripheral neuropathy (prevention - pyridoxine)

Polymorphism of *thiopurine S - methyltransferase*

- the metabolism of azathioprine
- commercially available genetic test for determining the polymorphisms, prevention of serious adverse reactions

# Genetic polymorphism of CYP2D6

## Null alleles

- encode a nonfunctional protein
- In the homozygous state cause the phenotype PM
- SNP (point mutations)
- a chromosome deletion
- mutation leading to loss of the function of protein, but the length of protein is maintained
- \* 4 allele ( 12-21 % ) in Caucasian populations (most frequent 1846G > A)
- \* 5 allele (2-7 % ) causes loss of whole CYP2D6 gene
- allele \* 13 and \* 16 - 5'- CYP2D7P / CYP2D6-3' hybrid genes , deletion of various parts of CYP2D locus

# GENETIC POLYMORPHISM OF CYP2D6

**The alleles associated with decreased enzymatic function**

**encode an enzyme with reduced activity**

**in the homozygous state or with the null allele in the heterozygous state cause the IM phenotype**

**\* 10 (50-70 % Asian, 1-5% of the Caucasian population)  
100C > T ( disrupts normal folding of the protein →  
enzyme is very unstable and has a low affinity to a  
substrate**

# GENETIC POLYMORPHISM OF CYP2D6

## **The alleles associated with increased enzyme function**

- **An increase in the number of active gene copy**
- **Alleles \* 1 , \* 2 , 35 \***
- **The frequency of Caucasians 1-5%**



# GENETIC POLYMORPHISM OF CYP

- **CYP2D6** and antidepressants (especially classical) : significant PK differences, difficult to adjust dose due to slower onset of effect, long-term drug therapy
- **CYP2C9** and oral antidiabetic drugs - derivatives  
sulfonylureas ( e.g. glimepiride, glipizide and tolbutamide)  
In heterozygotes CYP2C9 \* 1 / \* 3 , the total clearance of 50 %  
homozygotes and CYP2C9 \* 3 / 20 \* 3 % compared to WT
- **CYP2C9** and anticoagulants - (warfarin) in heterozygous  
CYP2C9 \* 1 / \* 3, the total clearance of 70 %, and in  
homozygotes CYP2C9 \* 3 / 40 \* 3 % compared to WT

Chromosome



Alleles



Genetic status

show hide

- |                       |                       |                              |
|-----------------------|-----------------------|------------------------------|
| <input type="radio"/> | <input type="radio"/> | Extensive metabolism (EM)    |
| <input type="radio"/> | <input type="radio"/> | Intermediate metabolism (IM) |
| <input type="radio"/> | <input type="radio"/> | Poor metabolism (PM)         |
| <input type="radio"/> | <input type="radio"/> | Ultrarapid metabolism (UM)   |

 — wild type allele

 — mutant allele

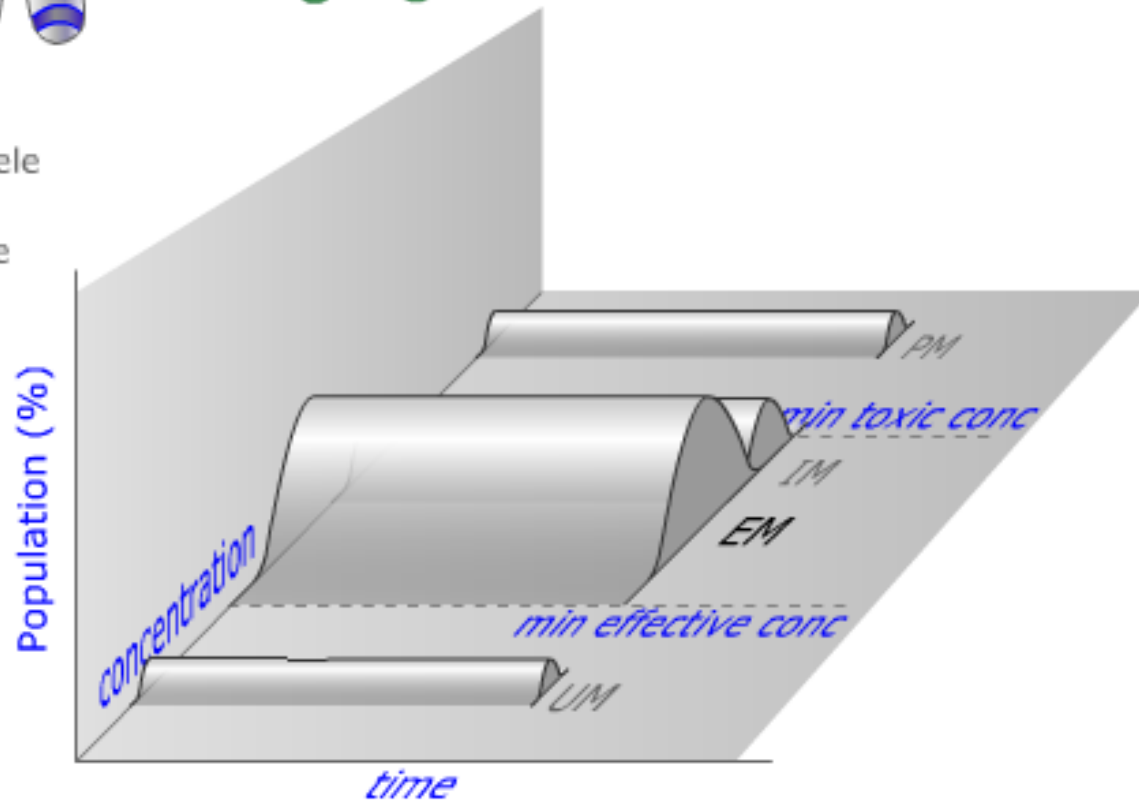

# INDUCERS of CYP 450

- dexamethason
- phenobarbital
- rifampicine
- *pf*
- *St*
- *Gi*

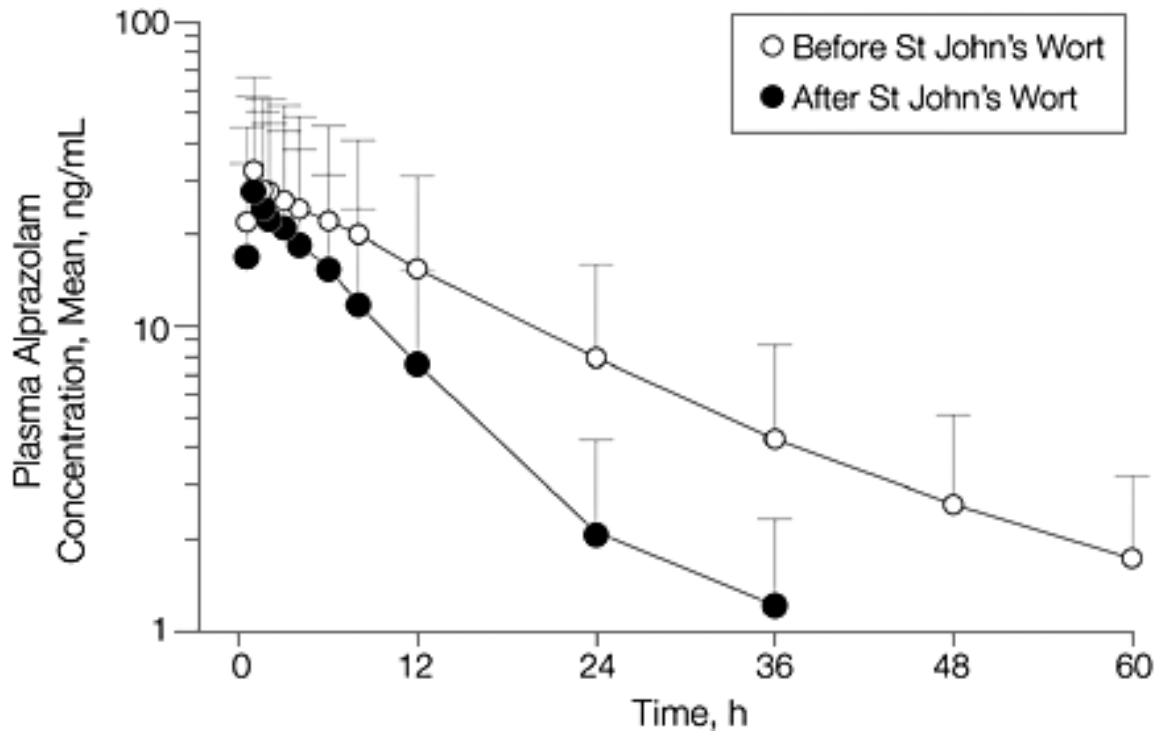

# INHIBITORS of CYP 450

- antidepressants (fluoxetine, fluvoxamine, paroxetine)
- quinine, quinidine
- chloramphenicol, erythromycin

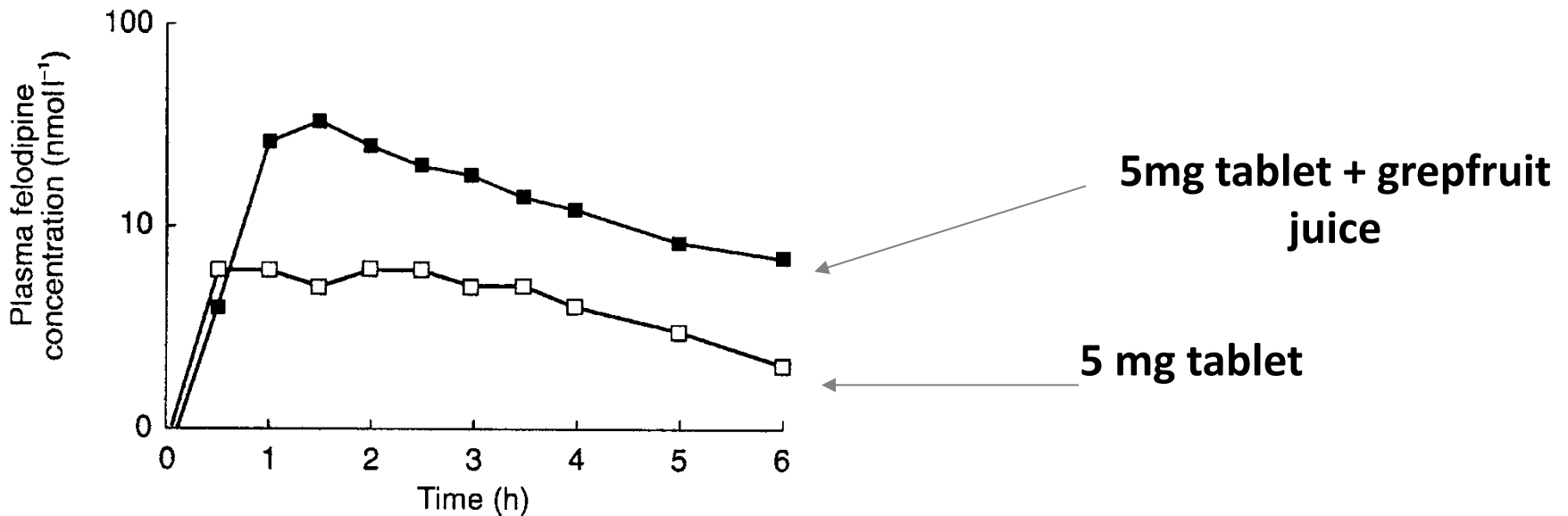

# Phase I of biotransformation

hydroxylation

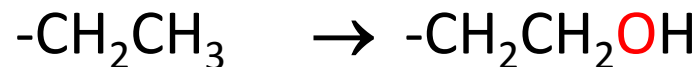

oxidation



O-dealkylation

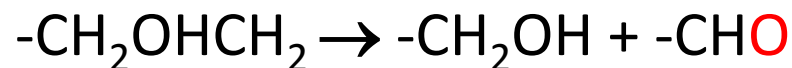

N-dealkylation

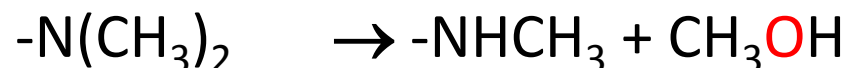

N-oxidation



oxidative deamination

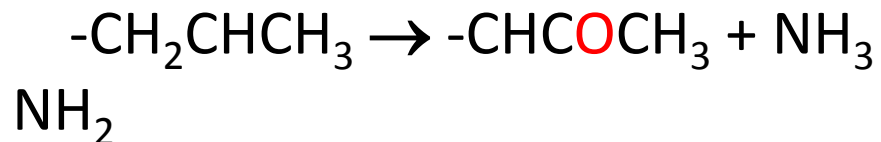

# Other non-microsomal biotransformations

- hydrolysis of esters in plasma (suxamethonium by cholinesterase)
- dehydrogenation of alcoholic and aldehydic group in cytosol in the liver (ethanol)
- MAO in mitochondria (tyramine, noradrenaline, dopamine, amines)
- xanthinoxidase (6-merkaptopurine, uric acid)
- enzymes with distinct function (tyrosine-hydroxylase, dopa-decarboxylase, etc.)

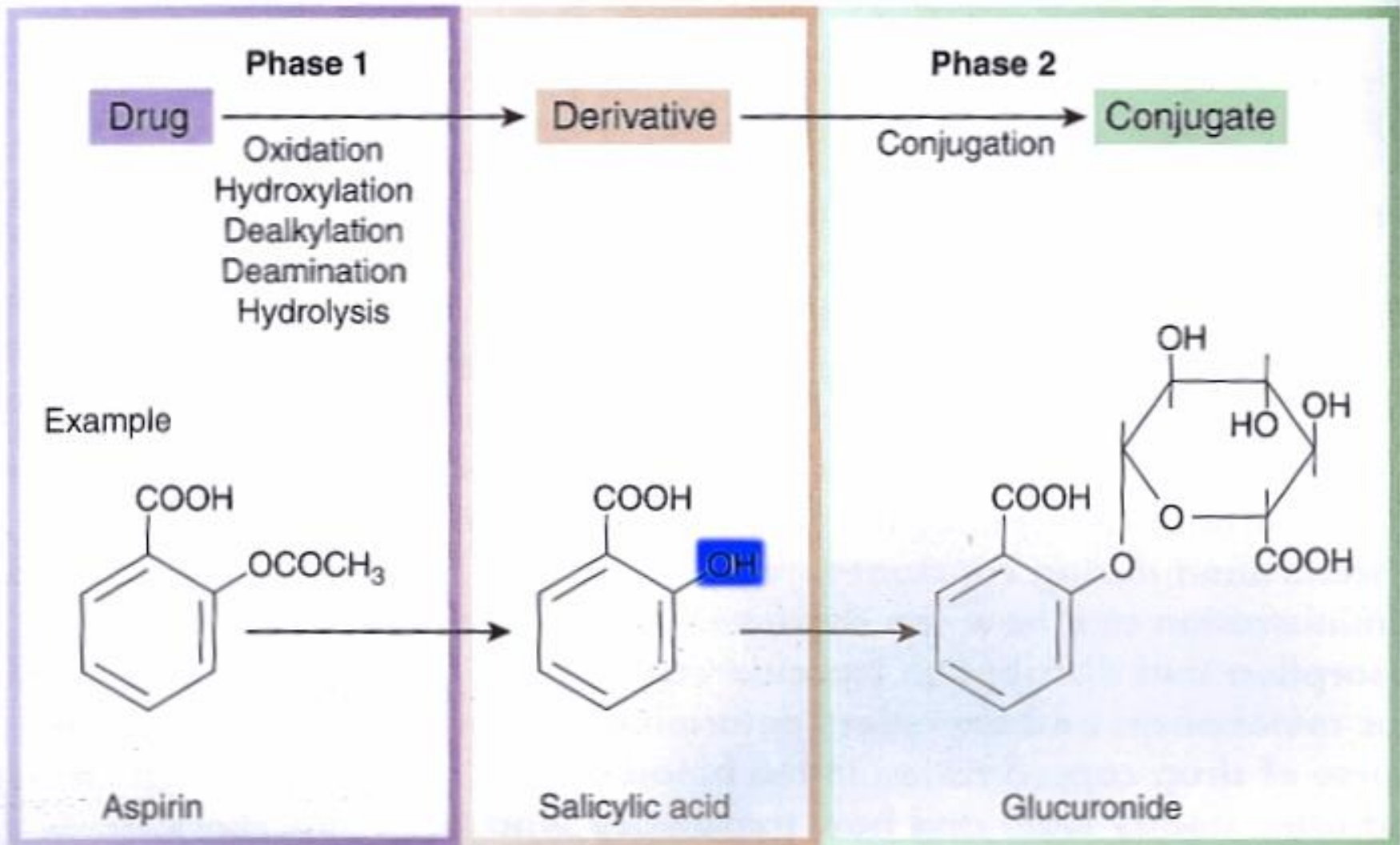

## Phase II of biotransformation

### CONJUGATION

Glucuronides -OH, -SH, -COOH, -CONH with glucuronyl acid  
(UDP- GlcUAc)

Sulphates: with -OH functional group

Acetylates: acetyl CoA with  $\text{NH}_2$ ,  $-\text{CONH}_2$ , s aminoacid- group

with glutathion with -halogen- or -nitrate functional groups, epoxides  
sulphates



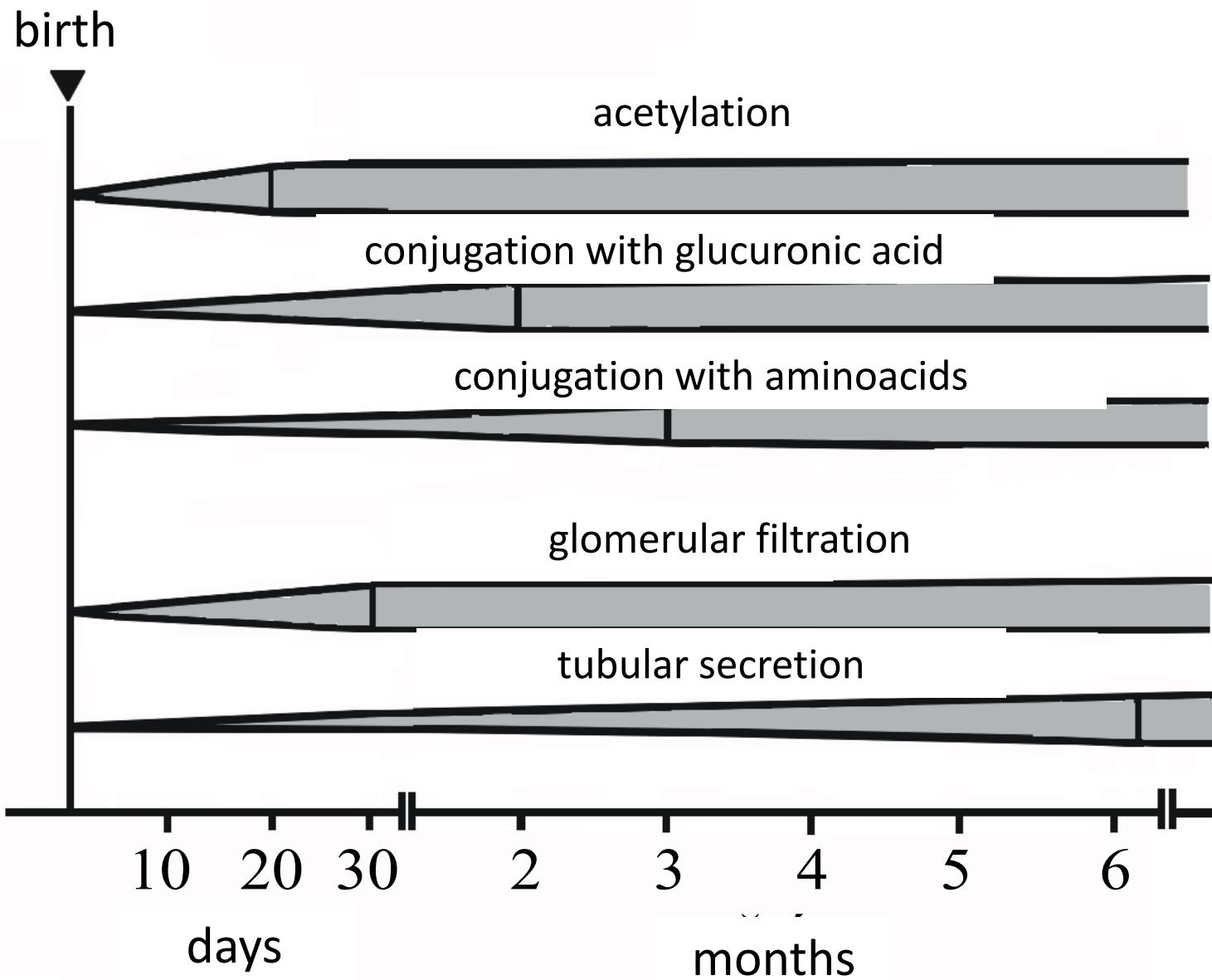

## Excretion

Kidney (urine)

tubular excretion

x

tubular reabsorption

liver (bile)

lung (air)

saliva, skin, hair, breast milk...

# Clearance

# Cl

- Volume of blood in a defined region of the body that is cleared of a drug in a unit time.
- more useful concept in reality than  $k_{el}$  since it takes into account blood flow rate
- Clearance varies with body weight
- Also varies with degree of protein binding

# Kidney

- MW < 60.000 D (MW albumin = 68.000 D)
  - tubular secretion
    - organic acids
      - furosemid
      - thiazide diuretics
      - penicilins
      - glucuronides
    - organic bases
      - Morphine
      - Atropine
      - Histamine...
  - tubular reabsorption
- acidification
- acetazolamid (inhibitor of CA)
  - ammonium chloride
- alcalization
- sodium bicarbonate

# Liver

Biliary excretion, clearance.

enterohepatic circulation

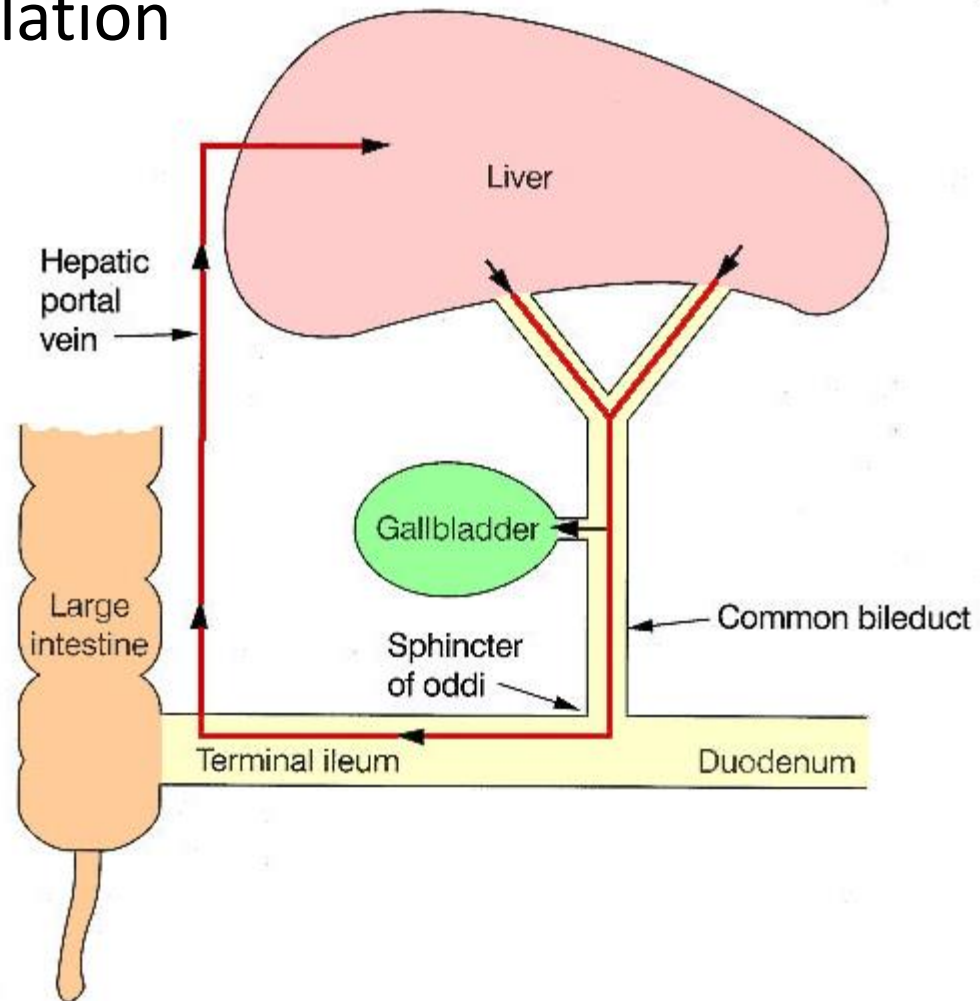

## Extraction ratio $E_R$

= proportion of the drug removed during the passage through the organ

$$E_R = \frac{c_a - c_v}{c_a}$$

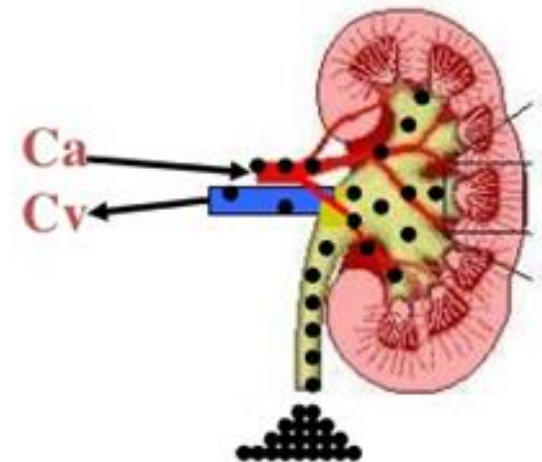

## Mean residence time **MRT**

= The average total time molecules of a given dose spend in the body. Thus, this can only be measured after instantaneous administration.

Non-compartment PK

$$\text{MRT} = \text{AUMC}/\text{AUC}$$

# PHARMACOKINETIC PARAMETERS

## PRIMARY

- **Bioavailability (F)**
- **Volume of distribution (Vd)**
- **Clearance (Cl)**

## SECONDARY

- elimination half-life ( $T_{1/2}$ )
- elimination constant ( $K_e$ )
- AUC (area under the curve)
- Cumulative index
- Extraction ratio



# Repeated administration

- increase in effect – accumulation  
sensitization
- decrease in effect
  - tolerance - changes at the site of receptor
    - changes in pharmacokinetics
  - tachyphylaxis
  - resistance – „tolerance“ to the drugs inhibiting cell.  
growth or cytotoxic drugs  
cytostatics, antiinfectives, antiseptics
- drug dependence

# Tachyphylaxis after repeated ephedrine administration (decrease in effect on blood pressure)

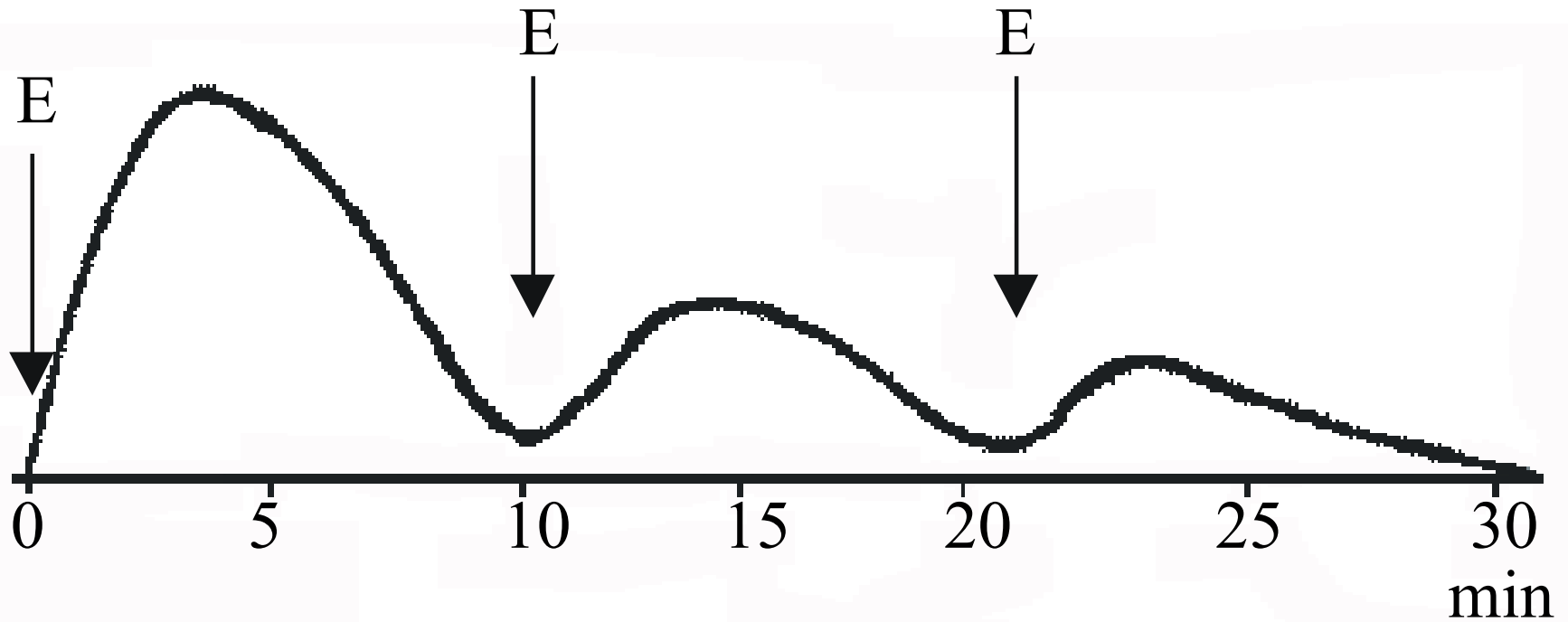

**E = ephedrine administration**

# BASIC PHARMACOKINETIC PARAMETERS

- $C$  (  $C_0$ ,  $C_{max}$  ) concentration in plasma
- $T_{max}$  time to reach  $C_{max}$
- $V_d$  volume of distribution
- $Cl$  clearance (  $Cl_{lung}$ ,  $Cl_{kid}$ ,  $Cl_{liv}$ ,  $Cl_{tot}$  )
- $t_{0,5\ abs}$  half-life of absorption
- $t_{0,5}$  (  $t_{1/2\ el}$ ,  $t_{50\% \ el}$  ) half-life of elimination
- **AUC** Area Under the Curve  
total amount of the drug during its presence in the body
- $F$  [ % ] bioavailability

# Elimination (first order)

**Elimination constant**  $k_e = \ln c_1 - \ln c_2 / t_2 - t_1$

**Half-life of the elimination** – the drug is completely eliminated after 4-5  $t_{0,5}$

$$t_{0,5} = \ln 2 / k_e = 0,7 / k_e$$

**clearance**      Volume of the blood in a defined region of the body that is cleared of a drug in a unit time

$$Cl_{TOT} = D/AUC = k_e V_d$$

# Kinetics of elimination of the 1st order –

semilog plot  
(i.v. admin)

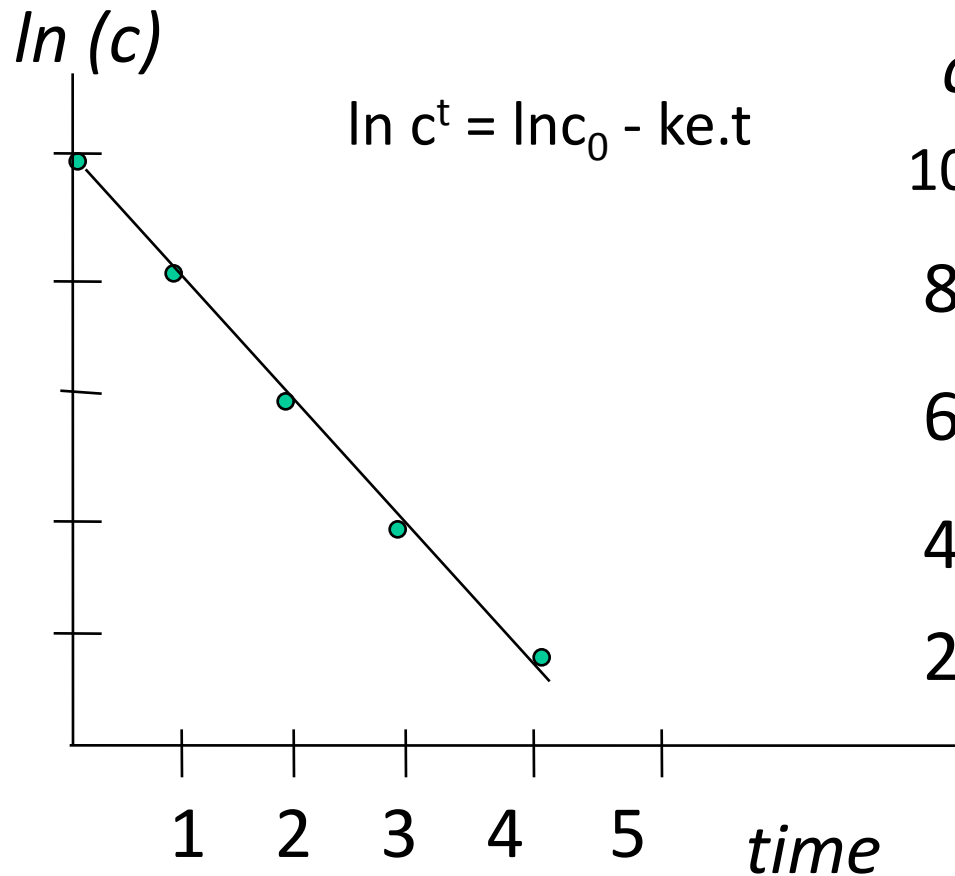

Normal plot  
(i.v. admin)

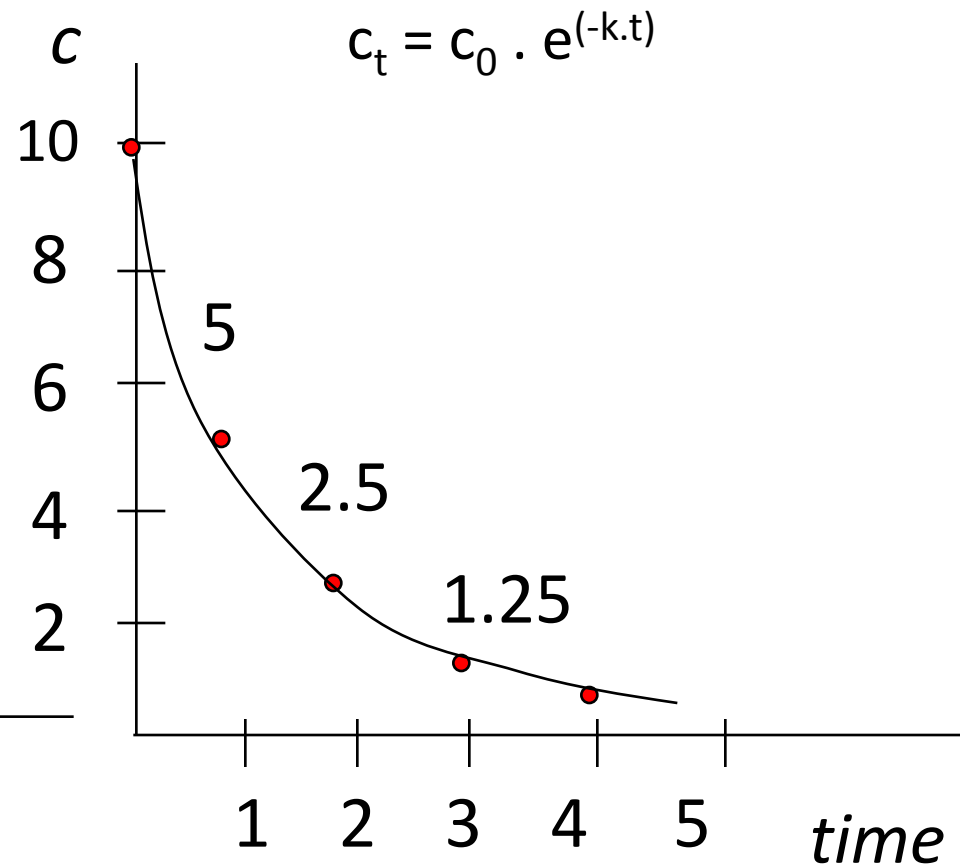

# Half-Life

- $C = C_0 e^{-kt}$
- $C/C_0 = 1/2$  in the time of 1 half-life
- Thus:  $0.5 = e^{-kt}$
- $\ln 0.50 = -k t_{1/2}$
- $-0.693 = -k t_{1/2}$
- **$t_{1/2} = 0.693 / k$**

## i.v. infusion

- **Continual drug administration**
- **Administration of the drug e.g. by the infusion pump**

-the plasma concentration increases until the elimination rate become equal to the drug intake –  
→ plasmatic concentration is steady - the plateau state ( $C_{ss}$ ).

# I.v. infusion

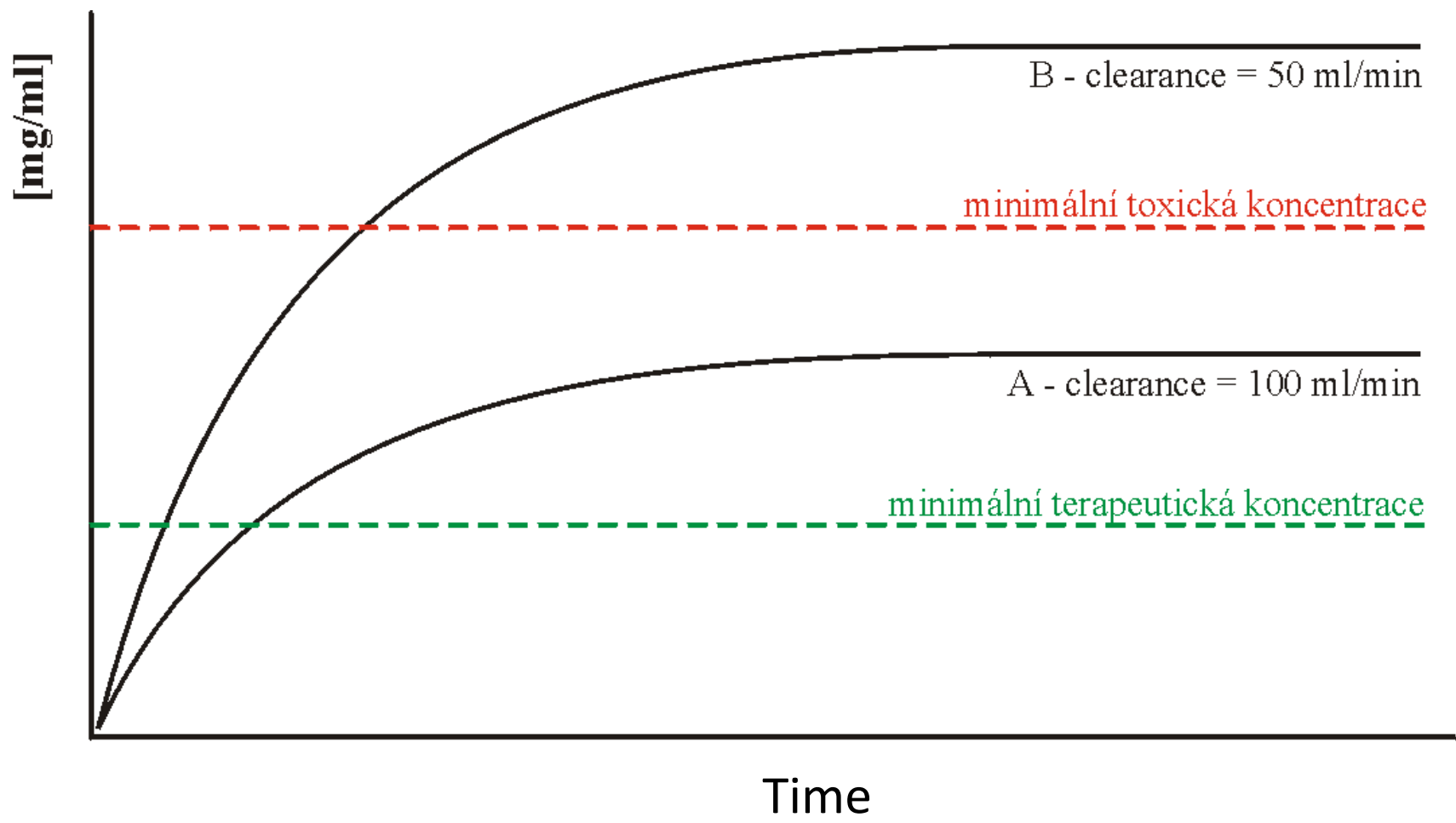



# The Compartment Model

Body = a series of interconnected well-stirred compartments within which the [drug] remains fairly constant.

Movement BETWEEN compartments is important in determining when and for how long a drug will be present in body.

## 2- compartment model

