

SECRETION

- Salivary glands
- Gastric glands
- Small glands of esophagus and intestine
- Exocrine pancreas
- Liver

Common features of secretion:
water, ions, HCO_3^- , mucin

STIMULATION OF SECRETION

1. Neurocrine
2. Endocrine
3. Paracrine

- Lubrication of food
- Swallowing
- Mechanical protection of GIT
- Chemical protection of GIT
- Enzymes
- Immune function(s)
- Articulation

PRODUCTION OF SALIVA

Xerostomia

- **Mucinous** vs. **serose** secretion
- Gl. parotis, gl. submandibularis, gl. sublingualis, small salivary glands in mouth
- 1 litre / day (1ml/min/g)
- High resting blood flow – 10 x contracting muscle, high metabolic exchange
- pH: 7 – 8 (at rest rather acidic, increase in HCO_3^- - alkalization)
- Parasympathetic stim. – Ach, VIP, VII. a IX.n., ; vasodilatation

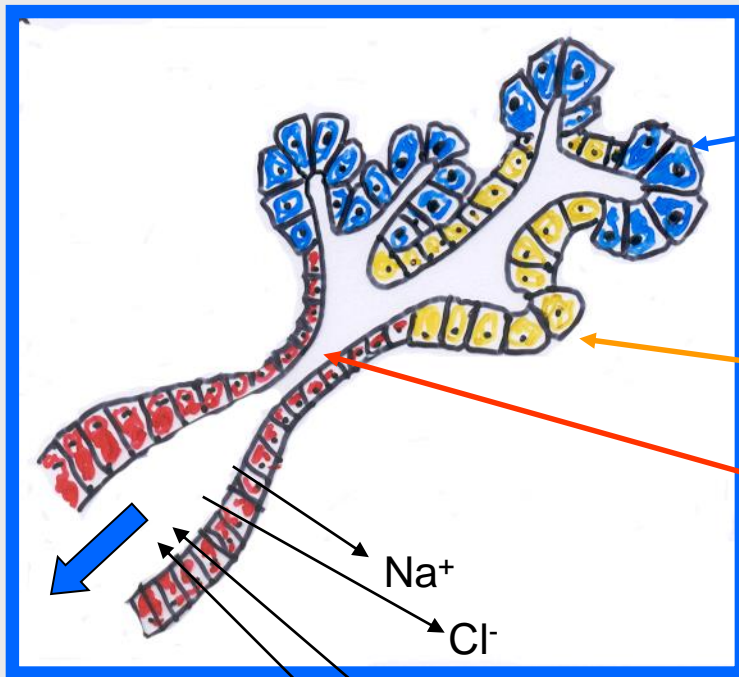

PRIMARY SALIVA

ACINES

Serose secretion (H_2O , ions; isotonic)(gl.parotis)

Salivary amylase (zymogenic granules – exocytosis)

Over pH 4!!!

Mucinosse secretion (glykoproteins) (gl.submandibularis and sublingualis)

DUCTUS

SECONDARY SALIVA

pH ~ 8

(hypotonic, after stimulation – increased tonus)

Resembles exocrine pancreas

REGULATION OF SALIVA PRODUCTION

Transmitter

2. messenger

Secretion

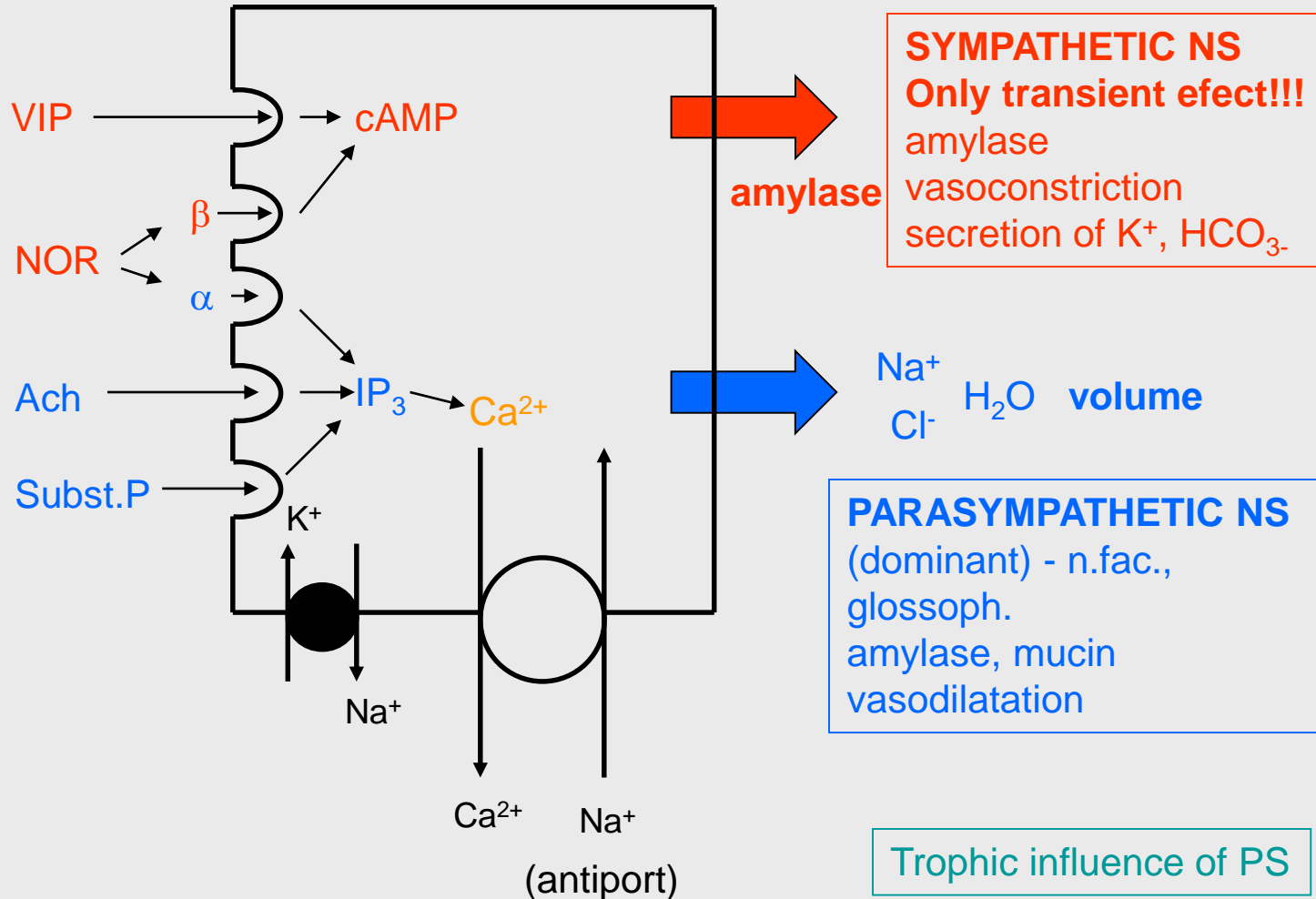

SECRETION OF GASTRIC JUICE

pH 2, high concentration of K^+ (vomiting) a Cl^-

Stimulation of α -receptors – decreased secretion of HCO_3^-
Gastric ulcers
 NSA – decreased secretion of HCO_3^- and mucine

Gastric mucose barrier

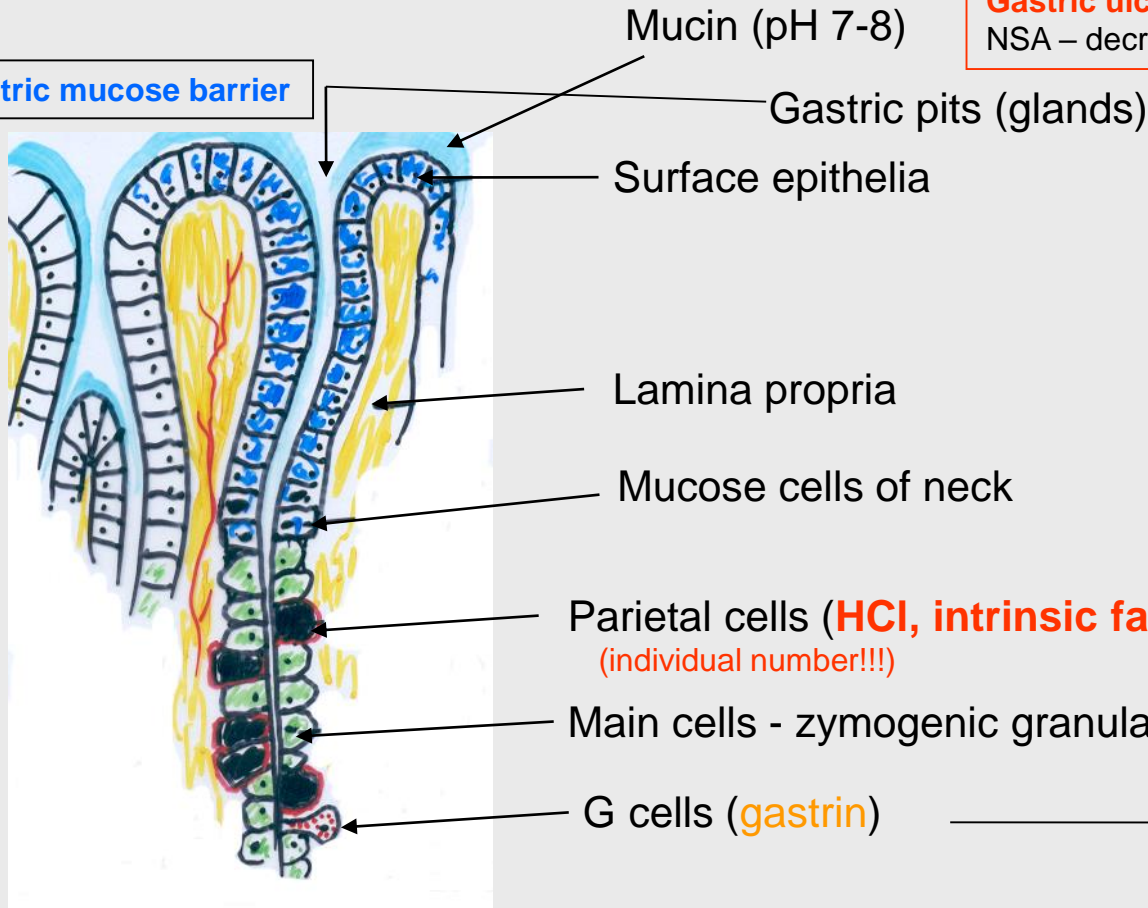

- Area:
- Subcardial (mucin)
 - Fundus (HCl)
 - Pyloric (mucin, G)

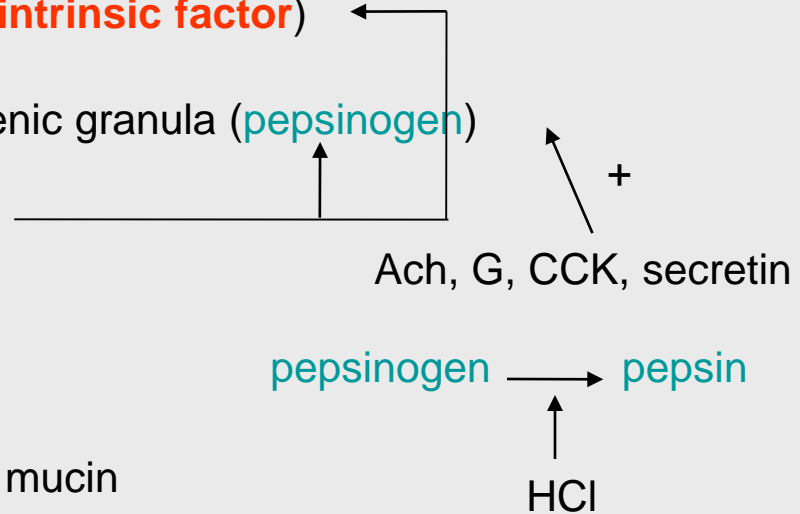

Gastric juice: water, salts, HCl, pepsin, intrinsic factor, mucin

Production increases after meal

Higher secretion – lower pH, lower secretion – more Na^+ , (**always more K^+ than in plasma**)

HCl PRODUCTION IN PARIETAL CELL

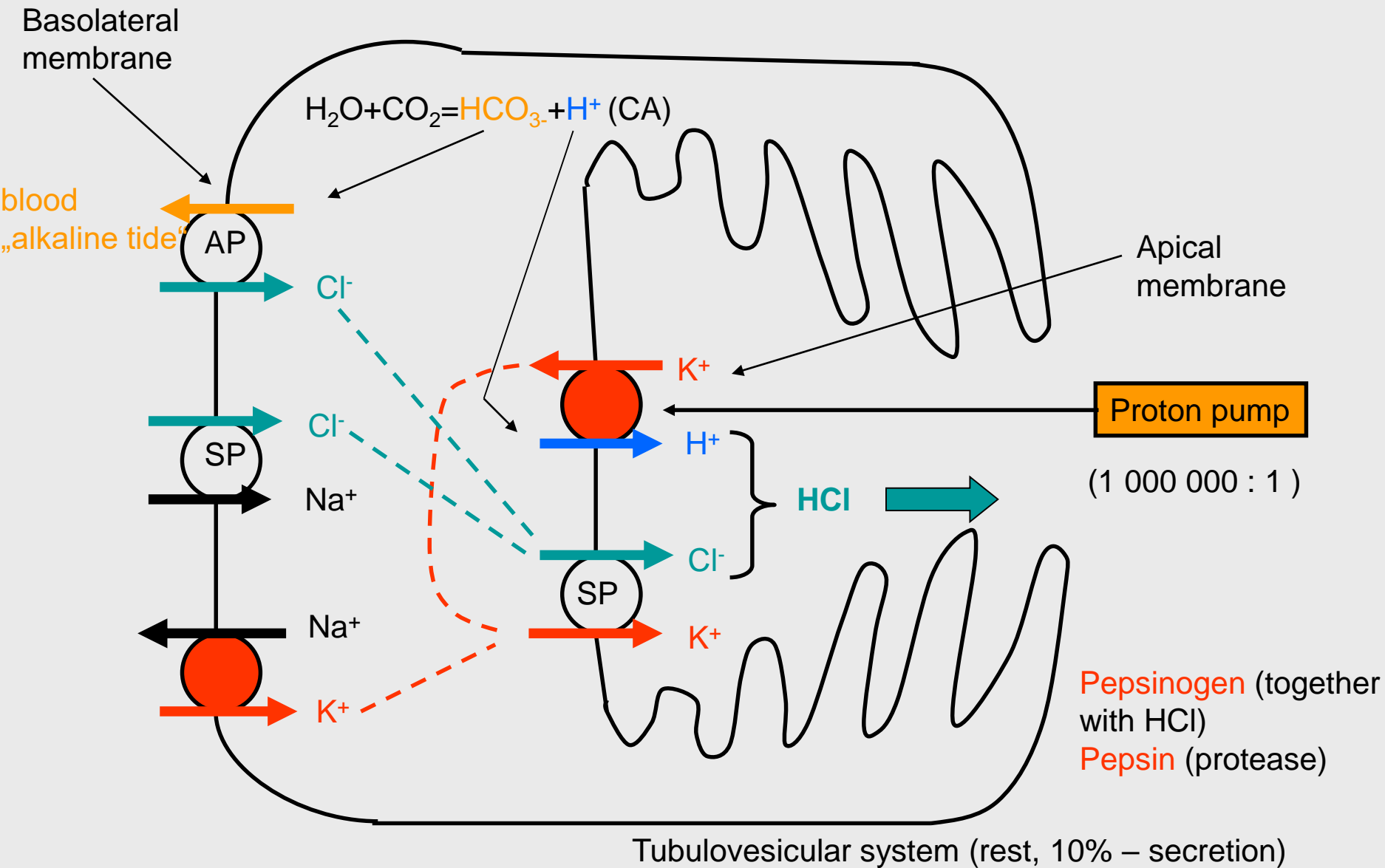

INTRINSIC FACTOR: binding protein (glycoprotein) for vitamin B₁₂ absorption (pernicious anemia)

CONTROL OF HCl PRODUCTION IN PARIETAL CELL

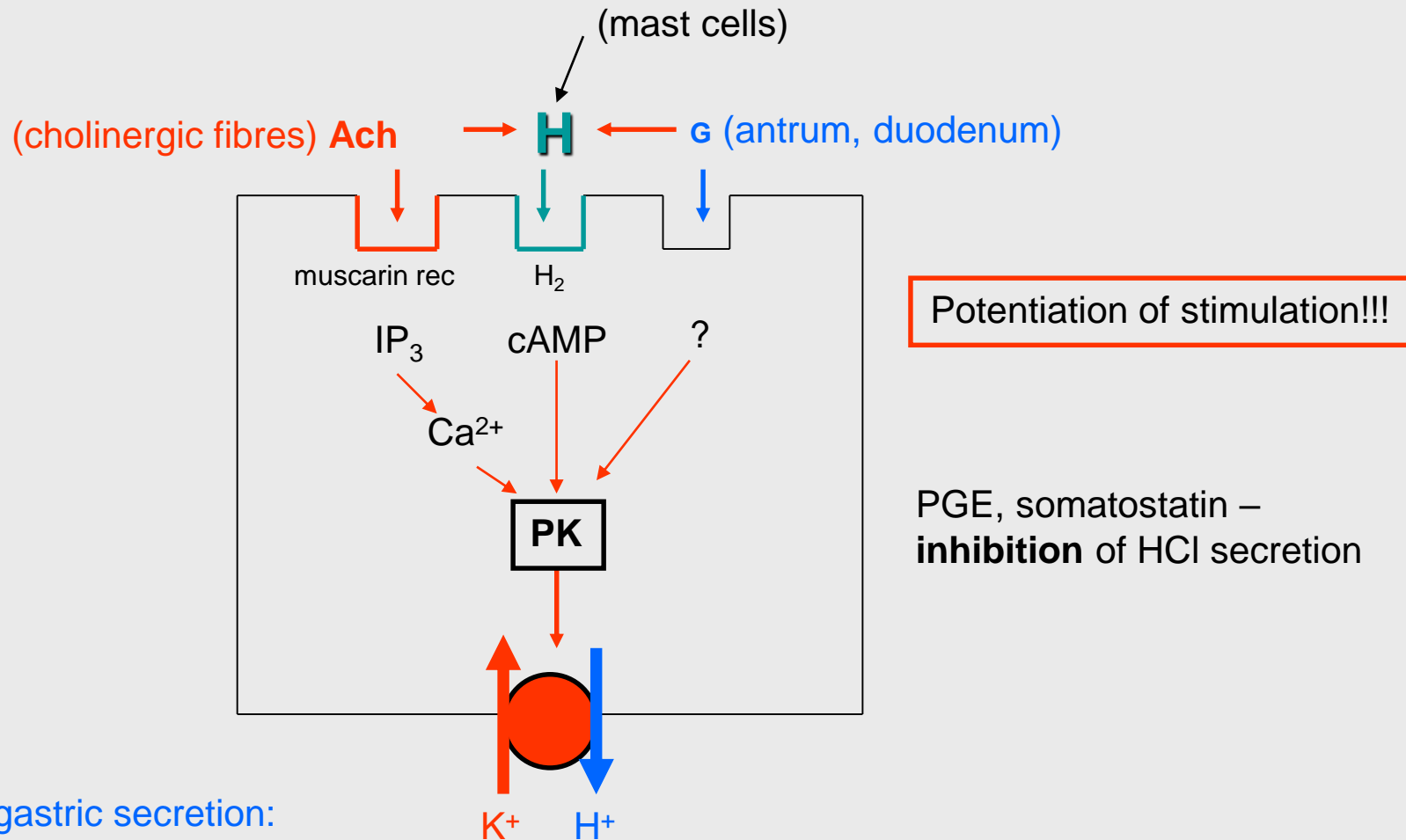

Phases of gastric secretion:

- **Cephalic** (vision, smell, taste)(X.)(directly, G, H)
- **Gastric** (distension of stomach; peptides, AA)(mechanorec.-local and centr. reflexes; trypt., fenylalanin, caffeine, alcohol – G)
- **Intestinal** (distension of duodenum, peptides, AA)(G from duodenum and jejunum)

Inhibition of gastric secretion:

Low pH, FA, hypertonia v duodenum and jejunum; secretin, bulbogastron, GIP, CCK

CONTROL OF PANCREATIC JUICE SECRETION

100 gr
1 l/day
exo-endo
n. X.

Digestion products
(lipids, peptides)

1. Water phase (HCO_3^-) - secretin
2. Enzymatic phase - CCK

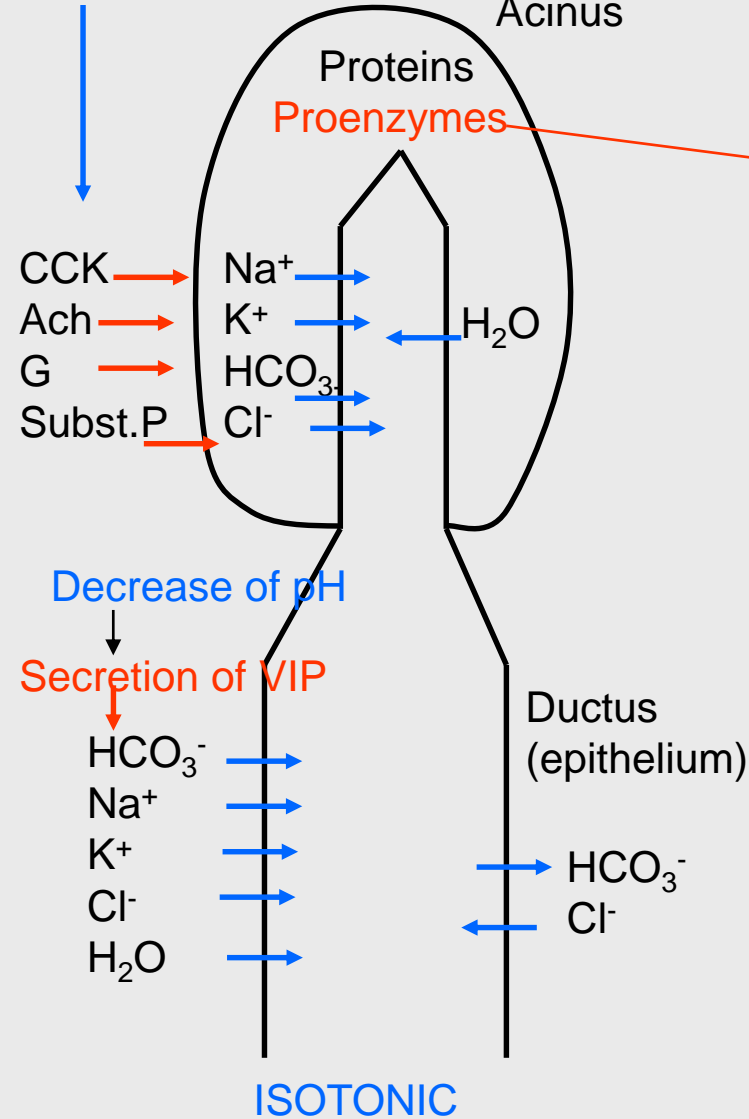

1. Trypsinogen (trypsin activates 1, 2, 3)
 2. Chymotrypsinogen
 3. Prokarboxypeptidase
 4. Trypsin-inhibitor
 5. α -amylase
 6. Pancreatic lipases
- Enterokinase – activates trypsinogen

Regulation of secretion:

1. Phase cephalic (n.X. – gastrin)
2. Phase gastric (distension of stomach – gastrin)
3. Phase intestinal (acid in duodenum and jejunum – secretin; peptides, AA = trypt., fenylalanin, FA – CCK)

Oddi sphincter (X. – relaxation, secretin - contraction)

Pancreatitis acuta

REGULATION OF SECRETION IN ACINARY CELL

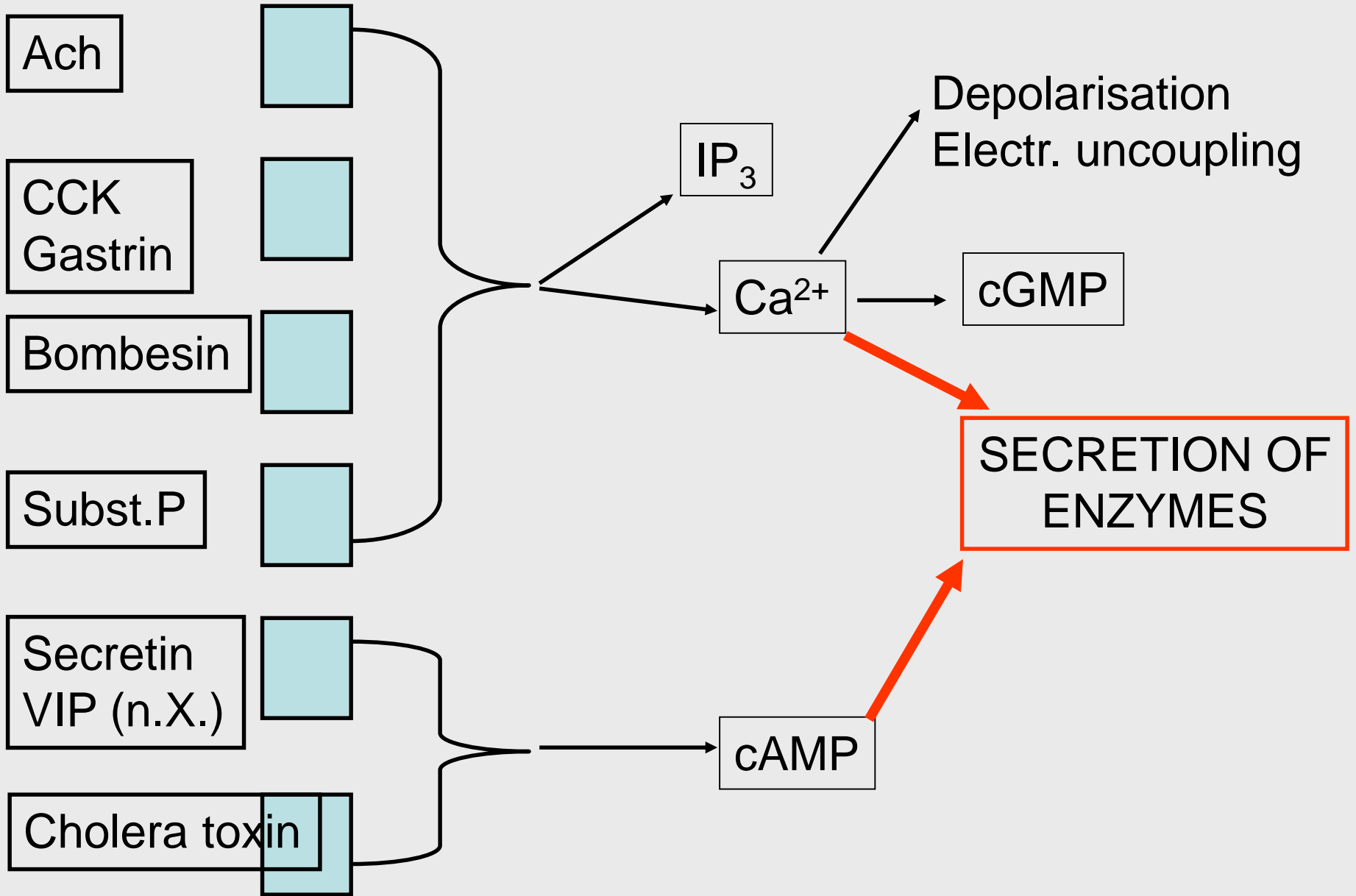

LIVER FUNCTION

- **Regulation of metabolism** (saccharides – glycogenolysis, glukoneogenesis; lipids – chylomicrons, lipoprotein lipase, VLDL, cholesterol and triglycerides; ketone bodies; proteins – synthesis of urea)
- **Proteosynthesis** (non-essential AA, lipoproteins, albumins, globulins, fibrinogen and other proteins of blood clotting cascade)
- **Storage** (glycogen, vitamins – A, D, B₁₂, iron)
- **Degradation** (hormones – epinephrin, norepinephrin, steroids, polypeptidic hormones)
- **Inactivation and excretion** (remedies, toxins) – detoxication by conjugation with glucuronic acid, glycine and glutathion

BILE PRODUCTION

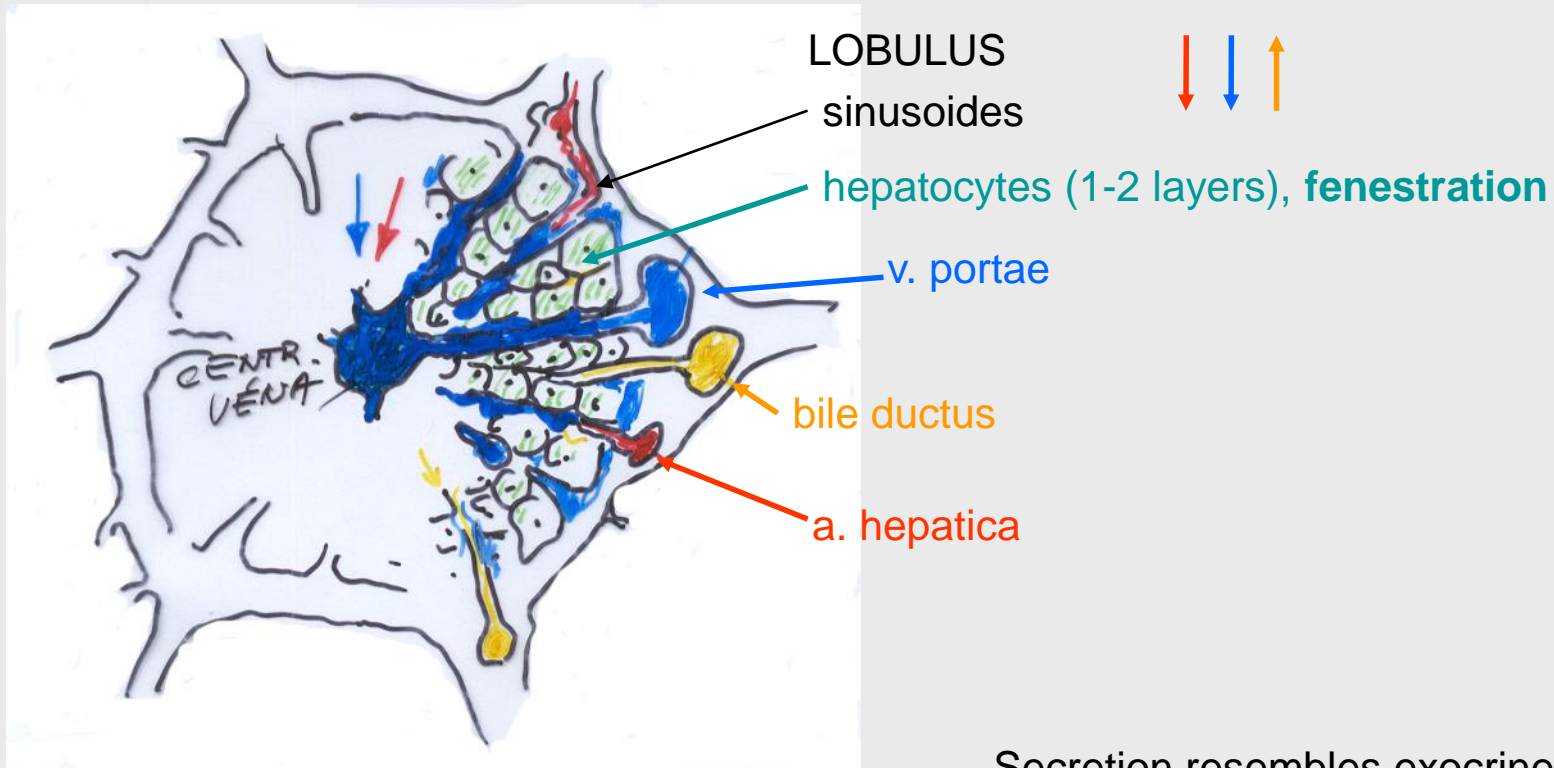

Secretion resembles exocrine pancreas

Bile

- 250-1500ml/day, isotonic, **primary secretion** – resembles plasma, **CCK**; modification - **secretin**
- bile acids (salts – Na^+) – conjugated (glycin, taurin) – soluble in H_2O , 50% of dry, micels
- cholesterol (crystals, lithiasis)
- lecithins
- bile pigments (bilirubin – glucuronid) – **yellow colour of bile** (lithiasis)
- Na^+ , K^+ , Cl^-
- H_2O , HCO_3^- (secretin)

ENTEROHEPATIC CIRCULATION

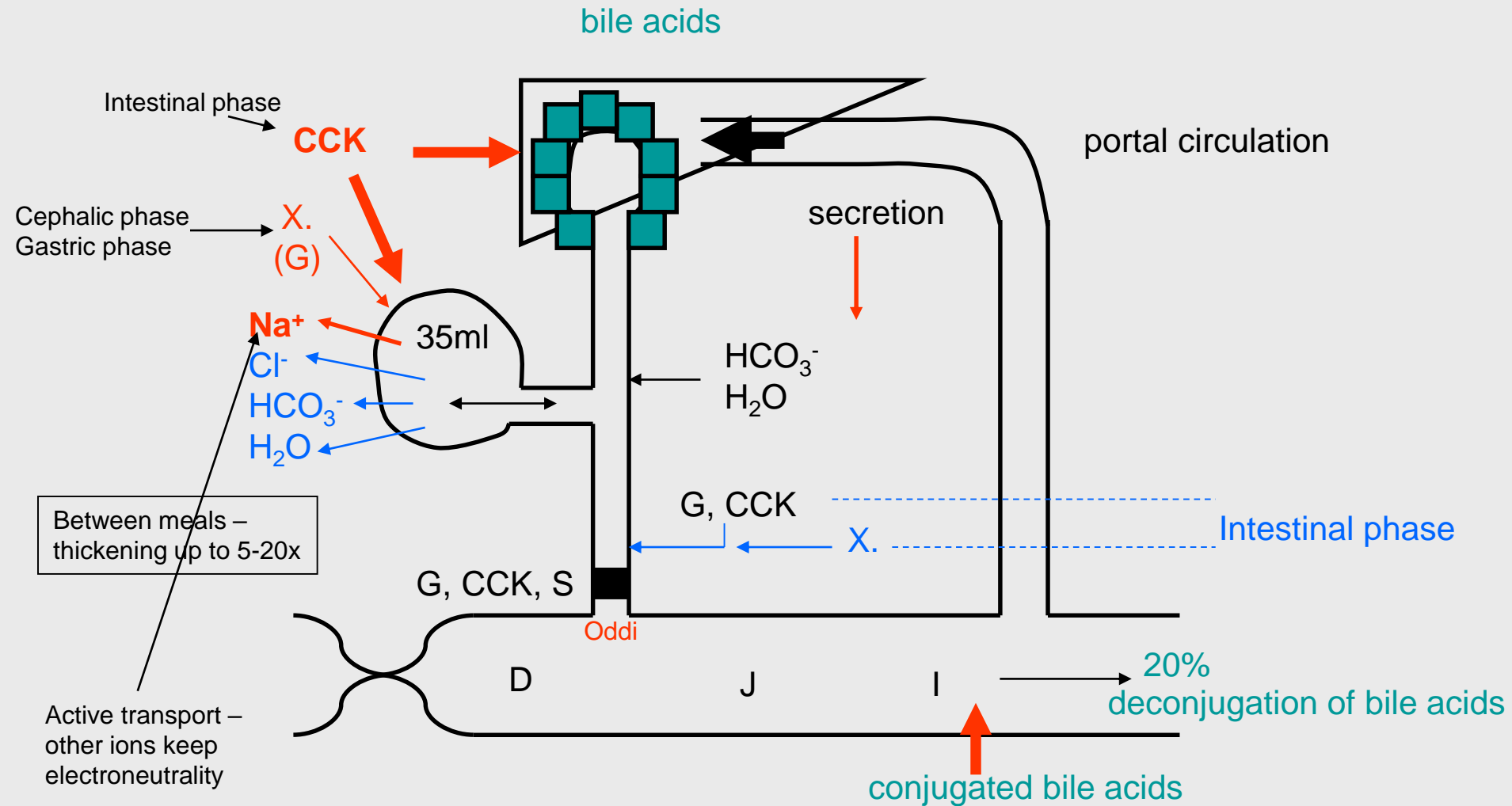

SECRETION FUNCTION OF GIT AND ITS HUMORAL CONTROL

