

**MUNI**  
**MED**

# **REGULATION**

# HOMEOSTASIS

„homeo“ + „stasis“

## Claude Bernard

*„complex organisms are able to maintain their internal environment [extracellular fluid (ECF)] fairly constant in the face of challenges from the external world“*

*„a free and independent existence is possible only because of the stability of the internal milieu“*

## Walter Cannon

*„maintaining a steady state within an organism regardless of whether the mechanisms involved were passive (e.g., water movement between capillaries and the interstitium reflecting a balance between hydrostatic and osmotic forces) or active (e.g., storage and release of intracellular glucose)“*

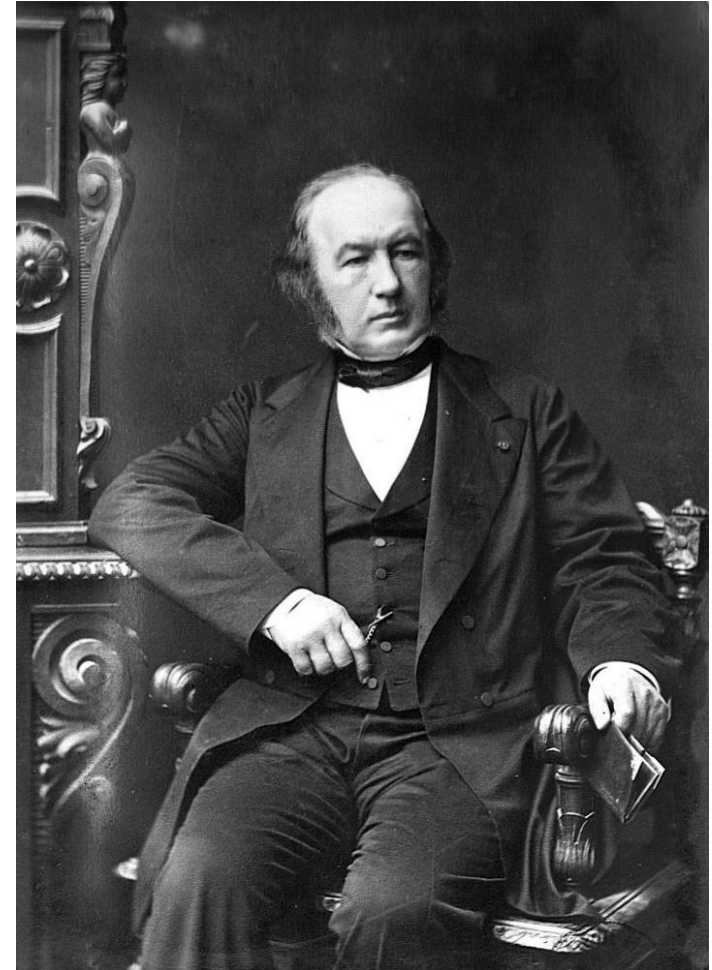

## Arthur Guyton

Introduced a concept of homeostasis as active regulatory mechanism aimed on minimizing of internal environment disturbances

### Homeostatic mechanisms – homeostatic regulations

- Keeping of regulated variable of internal environment **within the range**
- **Reduction of „noise“** during information transport in physiological systems

Reaching set point

## REGULATED variable („sensed“)

- Sensor
- Physiological range
- Blood pressure (baroreceptors)
- Body temperature (thermoreceptors)

## NON-REGULATED variable („controlled“)

- Variables which can be changed or modulated
- Sensor is not located in the system
- Keeping the variable constant
- Heart rate – autonomous nervous system



# HOMEOSTATICALLY REGULATED VARIABLES

Regulated Variable	Normal Range or Value	Sensor (Location If Known)	Control Center (Location)	Effectors	Effector Response
Arterial PO <sub>2</sub>	75–100 mmHg	Chemosenors (carotid bodies and aortic body)	Brain stem	Diaphragm and respiratory muscles	Change breathing frequency and tidal volume
Arterial PCO <sub>2</sub>	34–45 mmHg	Chemosenors (carotid bodies, aortic body, and the medulla)	Brain stem	Diaphragm and respiratory muscles	Change breathing frequency and tidal volume
K <sup>+</sup> concentration	3.5–5.0 meq/l	Chemosenors (adrenal cortex)	Adrenal cortex	Kidneys	Alter reabsorption/secretion of K <sup>+</sup>
Ca <sup>2+</sup> concentration	4.3–5.3 meq/l (ionized)	Chemosenors (parathyroid gland)	Parathyroid gland	Bone, kidney, and intestine	Alter reabsorption of Ca <sup>2+</sup> , alter resorption/building of bone, and alter absorption of Ca <sup>2+</sup>
H <sup>+</sup> concentration (pH)	35–45 nM (pH 7.35–7.45)	Chemosenors (carotid bodies, aortic body, and floor of the fourth ventricle)	Brain stem	Diaphragm and respiratory muscles	Change breathing frequency and tidal volume and change secretion/reabsorption of H <sup>+</sup> /bicarbonate ions
Blood glucose concentration	70–110 mg/dl	Chemosenors (kidney)	Kidney	Kidney	Alter storage/metabolism/release of glucose and its related compounds
		Fed state: chemosenors (pancreas)	Pancreas	Liver, adipose tissue, and skeletal muscle	
Core body temperature	98.6°F	Fasting state: chemosenors (hypothalamus, pancreas)	Hypothalamus	Blood vessels and sweat glands in the skin as well as skeletal muscles	Change peripheral resistance, rate of sweat secretion rate, and shivering
		Thermosenors (hypothalamus, skin)	Hypothalamus		
Mean arterial pressure	93 mmHg	Mechanosensors (carotid sinus and aortic arch)	Medulla	Heart and blood vessels	Alter heat gains/losses
Blood volume (effective circulating volume)	5 liters	Mechanosensors	Medulla	Heart	Alter heart rate, peripheral resistance, and inotropic state of the heart
		(Blood vessels: carotid bodies)	Hypothalamus	Blood vessels	Alter Na <sup>+</sup> and water reabsorption
		(Heart: atria and ventricle) (Kidney: juxtaglomerular apparatus and renal afferent arterioles)	Atria Kidney	Kidneys Intestine	Alter water absorption
Blood osmolality	280–296 mosM/kg	Osmosenors (hypothalamus)	Hypothalamus	Kidneys	Alter water reabsorption

# REGULATION

Control of living systems.

Living systems – open systems; their existence depends on flow of energy, substrates and signaling molecules between organism and environment in both directions.

Appears at all levels of system (cell – whole organism).

Regulation **nervous** vs. Regulation **humoral**.

# BASIC TYPES OF FEEDBACK

SERIAL

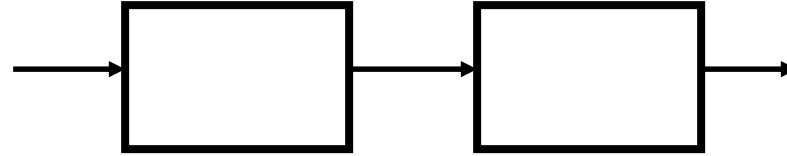

PARALLEL

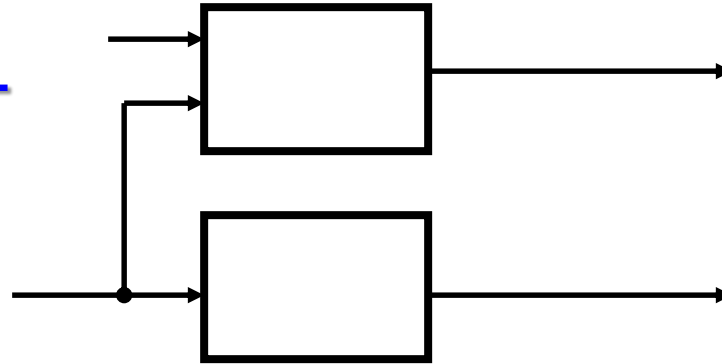

NEGATIVE DIRECT

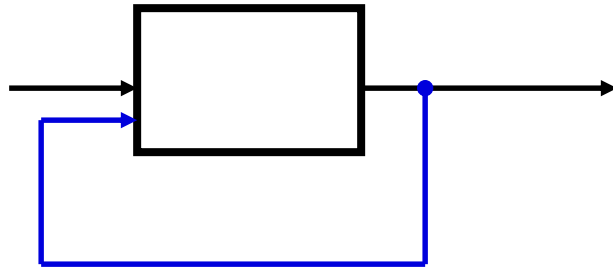

NEGATIVE INDIRECT

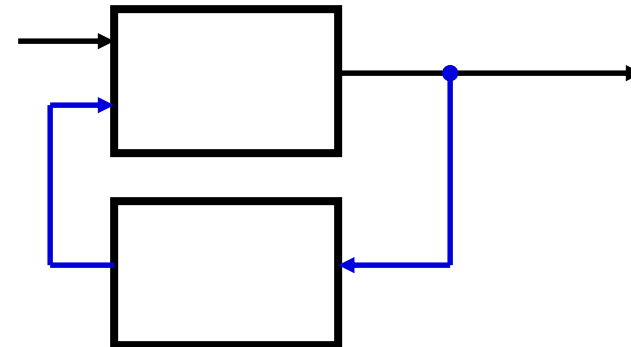

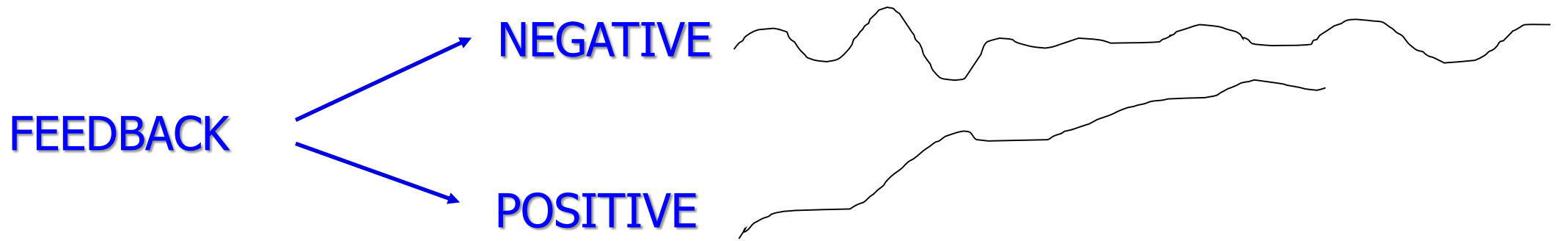

Deviation oscillates or continuously increases.

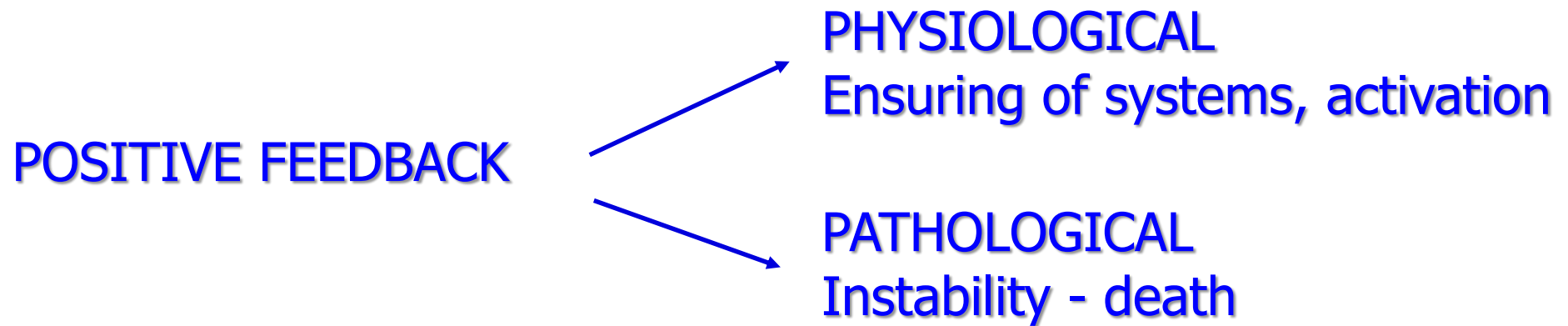

## NEGATIVE FEEDBACK

- plays a role in regulations
- compensates the difference of regulated parameter
- minimizes the difference between real values of regulated parameter and so-called **desired value**

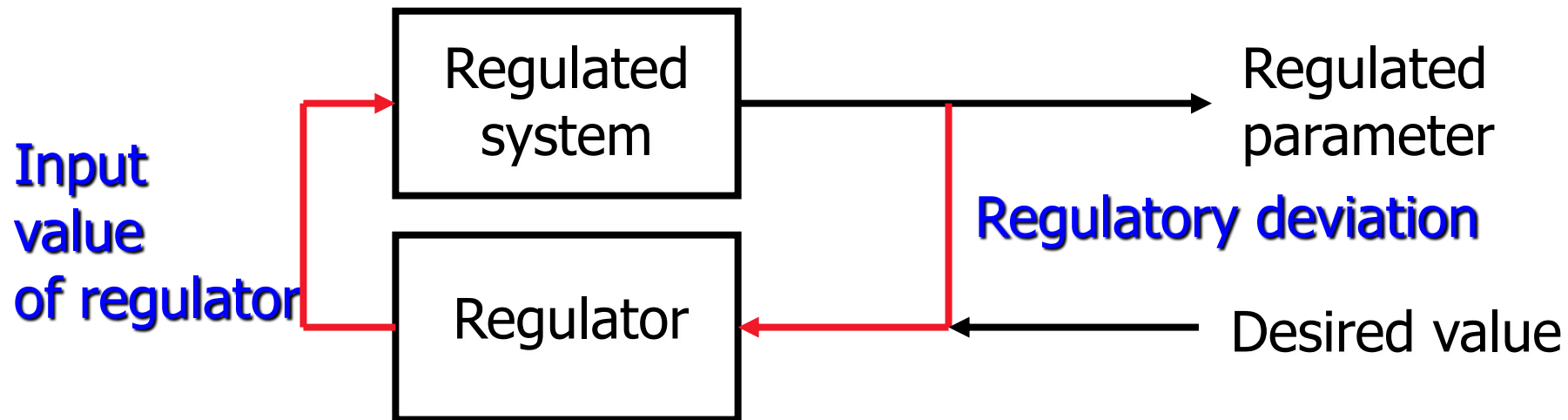

## POSITIVE FEEDBACK

- No regulatory effect
- It does not compensate the deviation, but amplifies it

# POSITIVE FEEDBACK - EXAMPLES

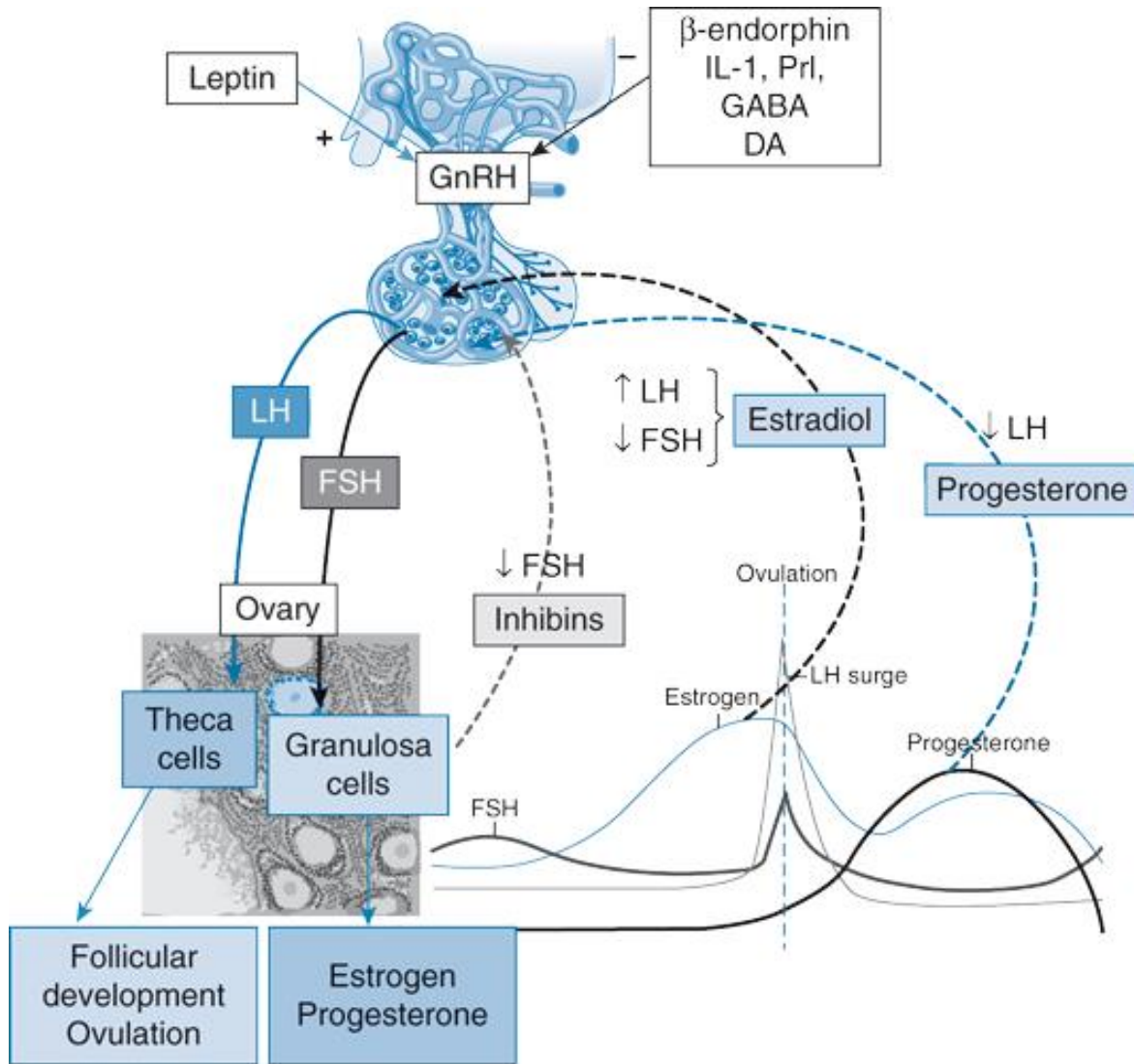

Late follicular phase (approx. 2 days before ovulation)

- High estradiol levels from pre-ovulatory follicles = change of negative feedback into positive feedback
- GnRH release
- Sensitisation of adenohypophysis to GnRH
- Increased LH secretion
- Stimulation of further estradiol secretion and following stimulation of LH secretion
- Permissive effect of progesterone



# POSITIVE FEEDBACK - EXAMPLES

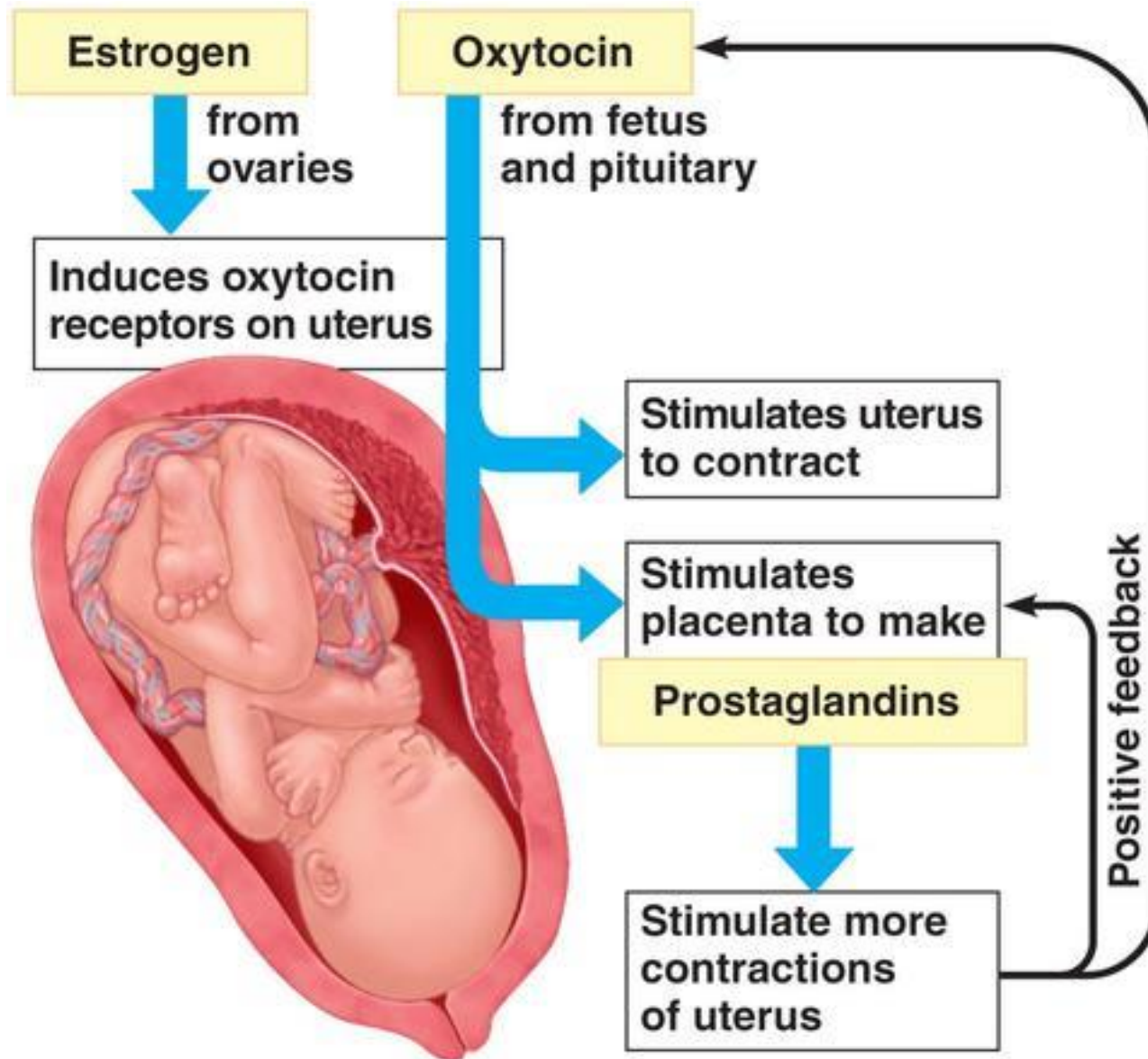

Estradiol upregulates

- Oxytocin receptors
- Prostaglandins receptors
- Gap junctions

Oxytocin

- Prostaglandins E2 and F2a
- Direct activation of PLC and Ca channels = release of Ca from intracellular stores
- Bleeding after placenta expulsion
- Nipples stimulation - milk ejection

# POSITIVE FEEDBACK - EXAMPLES

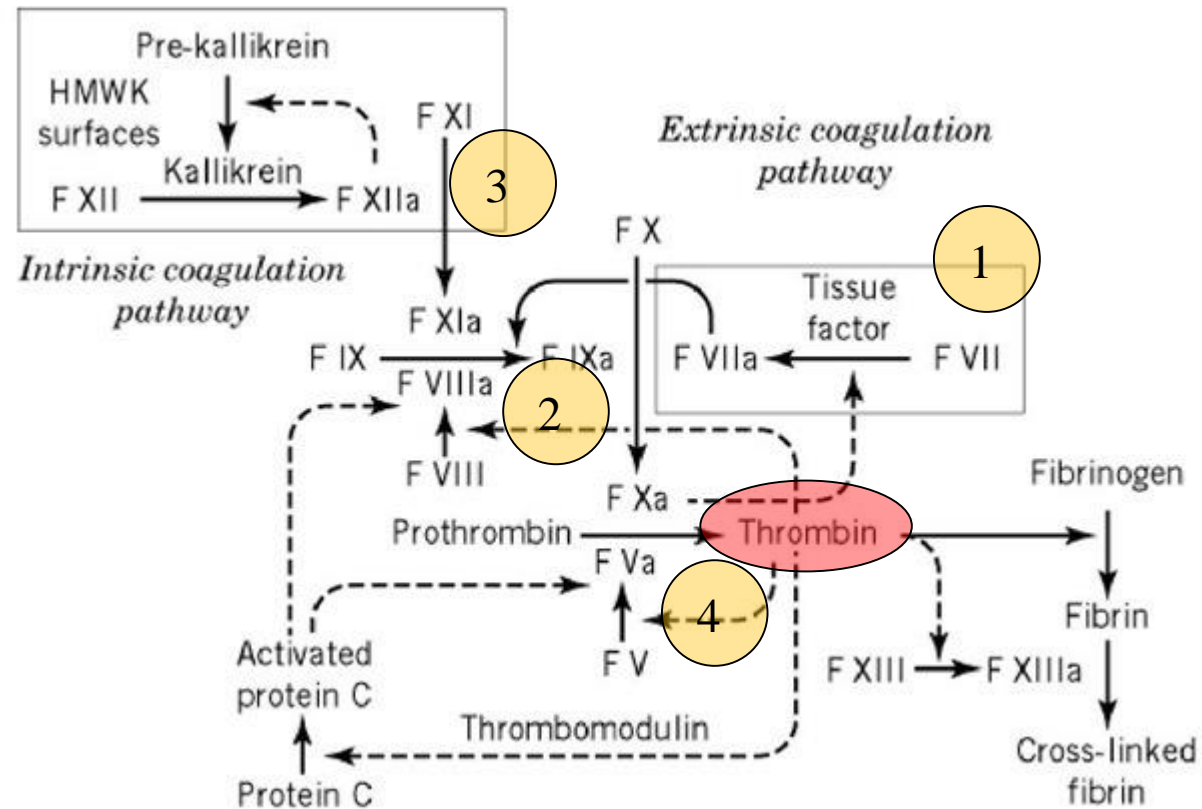

## Thrombin

- Very low amount of thrombin insufficient for fibrinogen activation
- Four important feedback mechanisms



# POSITIVE FEEDBACK - EXAMPLES

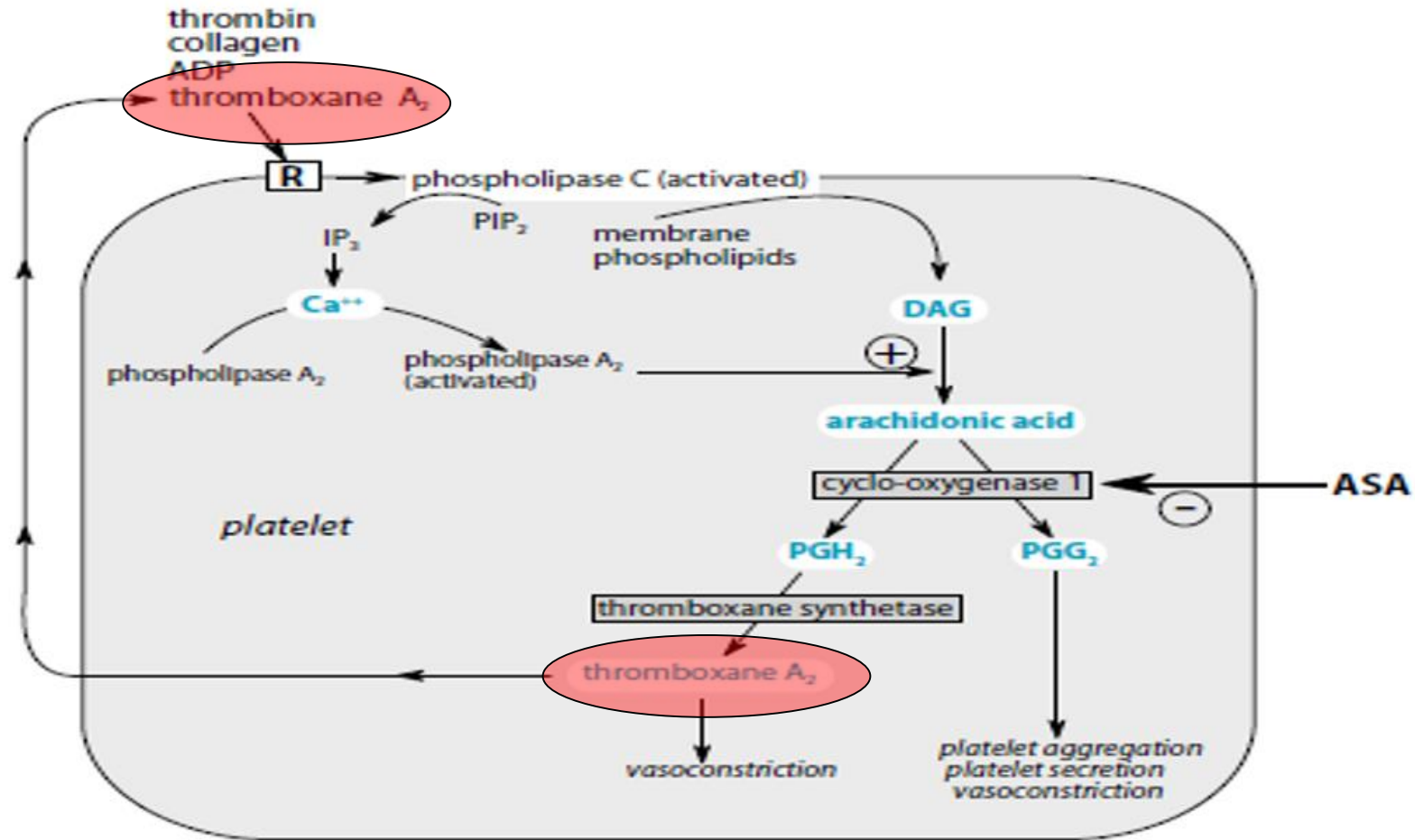

Aggregation of platelets

# POSITIVE FEEDBACK - EXAMPLES

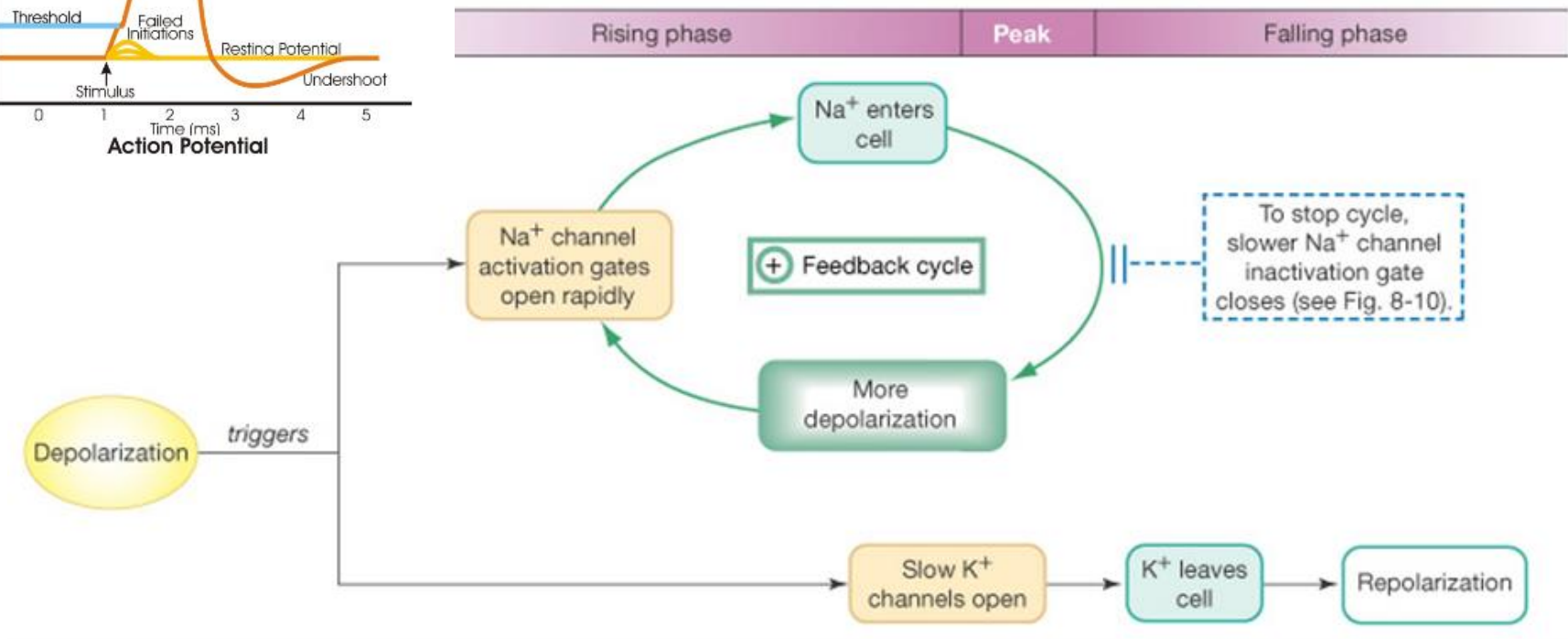
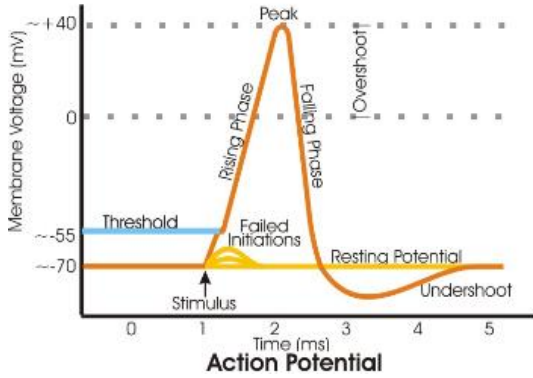

**MUNI**  
**MED**

# **PHYSIOLOGY OF ADAPTATION**

## Adaptation or Environmental Physiology

It studies the influence(s) of environment on living systems and their **ability to adapt** to changed conditions

**REACTION** (REGULATION): direct, immediate response of organism on environmental changes

**ADAPTATION** = a complex of biochemical, functional and structural changes in organism caused by long-lasting and repeated environmental changes

**REACTION** (sec, min) vs. **ADAPTATION** (min, hours, days)

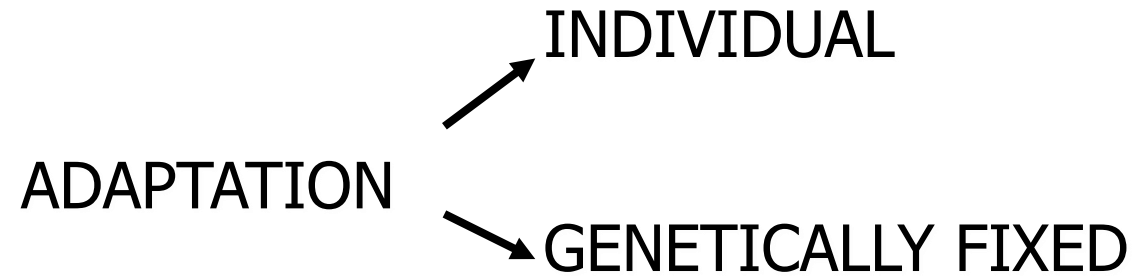

## MECHANISMS OF ADAPTATION

= processes which lead to new, functionally better parameters.

**Aim** is to reach new, more advantageous qualities for surviving of the individual or species.

## DURATION OF ADAPTATION:

Minutes - years

# MECHANISMS OF ADAPTATION

1. Changed plasticity of nervous system
  - changes at molecular level in CNS
  - gene expression changes
  - regulation of number of neurites
  - changes in neuronal nets (cortical fields)
- 2) Changes in organ size (adaptation to exercise)
- 3) Changes of autonomous tonus (athletes)
- 4) Temporary changes of skin colour (sunbathing)

# CLASSIFICATION OF ADAPTATIONS

## a) According to target parameter

- To cold
- To heat
- To dietary changes
- To high altitude
- To changed air composition
- To physical exercise .....

## b) According to output

- Adaptations at the level of five basic senses
- Adaptation changes of behavior



# ADAPTATION TO COLD AND HEAT

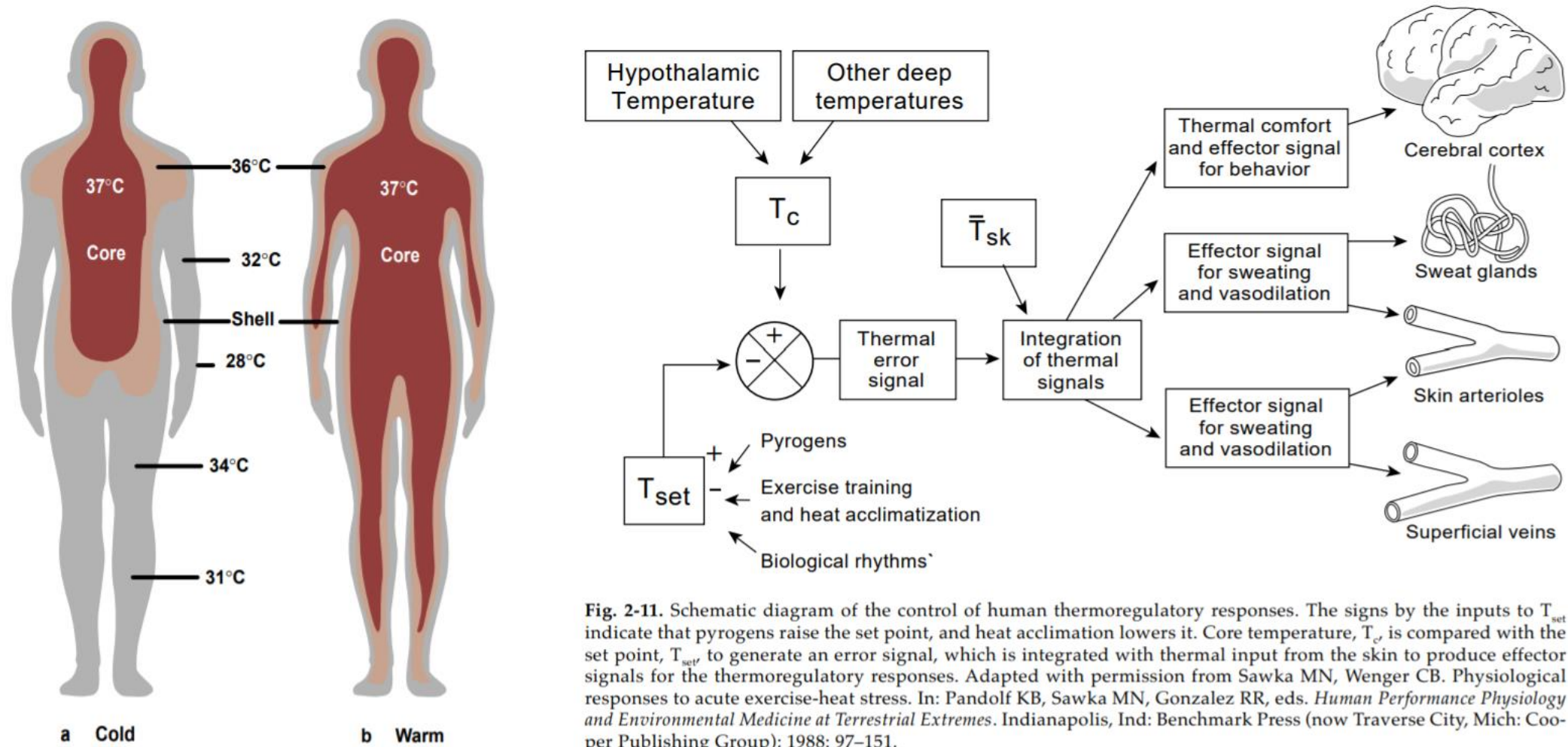

**Fig. 2-11.** Schematic diagram of the control of human thermoregulatory responses. The signs by the inputs to  $T_{set}$  indicate that pyrogens raise the set point, and heat acclimation lowers it. Core temperature,  $T_c$ , is compared with the set point,  $T_{set}$ , to generate an error signal, which is integrated with thermal input from the skin to produce effector signals for the thermoregulatory responses. Adapted with permission from Sawka MN, Wenger CB. Physiological responses to acute exercise-heat stress. In: Pandolf KB, Sawka MN, Gonzalez RR, eds. *Human Performance Physiology and Environmental Medicine at Terrestrial Extremes*. Indianapolis, Ind: Benchmark Press (now Traverse City, Mich: Cooper Publishing Group); 1988: 97–151.

# ADAPTATION TO COLD AND HEAT

<b>Physiological System</b>	<b>Role in Thermoregulation</b>
The cardiovascular system	Heart and blood vessels transport heat in blood Differential perfusion shunts blood and heat to skin for cooling Changes in heart rate and blood vessel tone compensate for dilated vasculature and dehydration
Nervous system Higher functions Paleo-brain (hypothalamus) Autonomic (sympathetic/parasympathetic) nerves	Cognitive assessment of risks, planning and taking action Control of thermoregulation  Control and modulation of blood vessels, heart, sweat glands
Integumentary system (Skin)	Sweat glands moisten the skin- allowing for evaporative cooling Subcutaneous fat (insulation)
Renal, under influence of endocrine system	Water and electrolyte regulation

# ADAPTATION TO COLD

18th century: surviving of sailors in cold water

1887: V. Priesnitz, S. Kneipp

People suffer from low temperatures less in winter than in summer.

**ADAPTATION**

**INSULATIVE**

**METABOLIC**

**HYPOTHERMIC**

1. **PROTECTION FROM HEAT LOSS** ( feather, vasoconstriction, increased amount of adipose tissue under the skin)
2. **INCREASE OF HEAT PRODUCTION** ( higher metabolic exchange)
3. **DOWNWARDS SHIFT OF SET-POINT** ( opposite to fever, behaviour as in hibernating animals )

Acclimation.

Human: as tropical animals

Seal, frog, seagull: arctic animals (thermoneutral zone between 20 – 40°C, thermoregulating below 20°C)

In humans always **all three mechanisms** activated at the same time.

In adapted – O<sub>2</sub> consumption decreases, HR not changed, BP increases (by 20 – 40mmHg), feeling of discomfort is lower (starts at lower temperature), **downward shift of set-point** (by 0.75°C)

## ADAPTATION PROCESS

- Mainly **new value of set-point**
- **Changed diet** (higher energy consumption, but NO increase of body mass, slowly increases body fat percentage)
- **Cold diuresis** (excretion of  $\text{Na}^+$  and  $\text{K}^+$ ) – up to 60x, mediated by ANF, haemoconcentration, increased number of leucocytes and erythrocytes
- **Glycaemia changes**: in non-adapted people decreases (stress), in adapted - increases (no stress)
- Decrease of threshold for pain on skin ( total habituation – decreased sensitivity of receptors); **stress analgesia** in the course of adaptation
- **Decrease of threshold for muscle shivering**

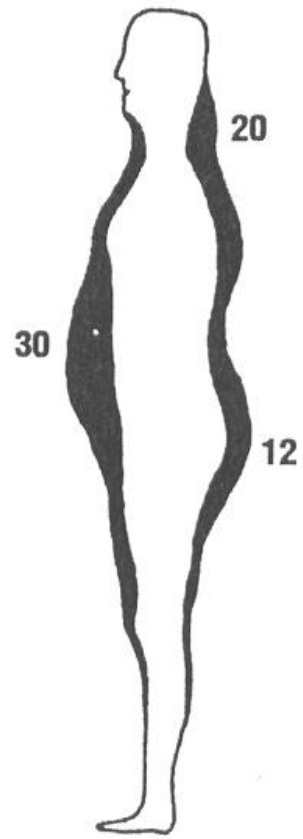

**J.Z.**  
**Weight 97 kg**  
**Height 1,7 m**

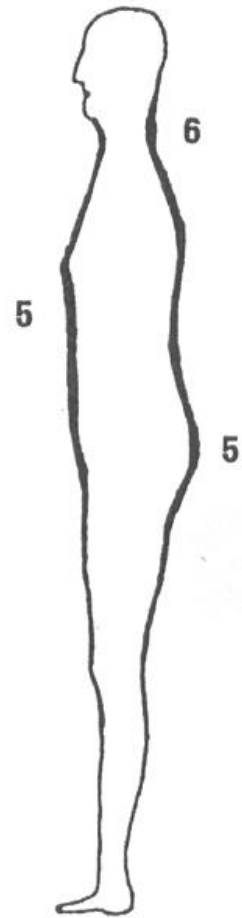

**G.P.**  
**75 kg**  
**1,8 m**

# ADAPTATION TO HEAT

- 1) **SWEAT PRODUCTION** may be doubled
- 2) **THRESHOLD FOR SWEATING** decreases to lower temperatures (both core and periphery)
- 3) **DECREASED CONTENT OF ELECTROLYTES IN SWEAT**
- 4) **FEELING OF THIRST** increases
- 5) **HIDROMEIOSIS** (decreased production of sweat in humid hot clima, after the period of profuse sweating; decreases idle dropping of sweat)
- 6) **ADAPTATION OF TOLERANCE TO HEAT** in inhabitants in the tropics, threshold for sweating is increased to higher body temperatures.

ATTENTION must be paid to physical exercise !!!



# ADAPTATION TO HIGH ALTITUDE

**PHOTO B.** Sir Edmund Hillary and Sherpa Tenzing Norgay on Everest.

This photograph shows Hillary and Norgay summiting Everest for the first time on May 1953. They used supplementary oxygen during their ascent.

*Source: © The Kobal Collection.*





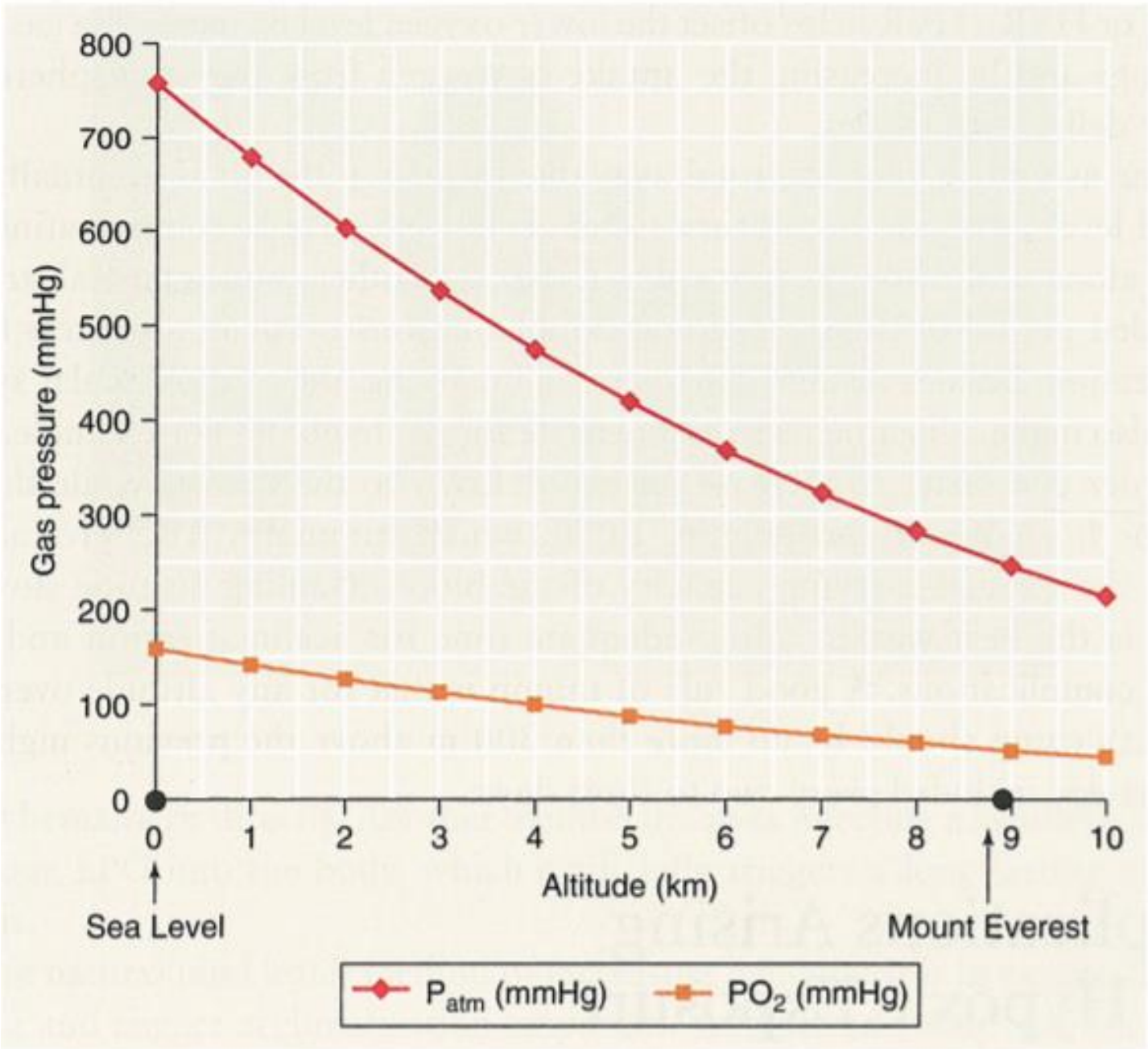

# ADAPTATION TO HIGH ALTITUDE

## FAST RESPONSE (reaction)

(hours)

**CARDIOVASCULAR RESPONSE:** tachycardia and increased cardiac output at rest, more pronounced during exercise (BP increases during exercise only slightly)

**RESPIRATORY RESPONSE:** increased minute ventilation, more pronounced during exercise

**ACID-BASE BALANCE:** respiratory alkalosis ( $RQ > 1$ )

**O<sub>2</sub> TRANSPORTATION:** shift of dissociation curve to left

# HIGH ALTITUDE ACCLIMATISATION

It takes at least several weeks, fully developed after months or years.

**CARDIOVASCULAR RESPONSE:** HR and CO are normalized, pulmonary arterioles constrict – pulmonary hypertension

**RESPIRATORY RESPONSE:** minute ventilation is stabilized (directly proportional to high altitude hypoxia), central chemoreceptors adapt

**INCREASED RELEASE OF ERYTHROPOETIN:** polyglobulia, transport capacity of blood for O<sub>2</sub> increases, viscosity of blood increases, density of mitochondria increases, myoglobin content increases

# ADAPTATION TO HIGH ALTITUDE

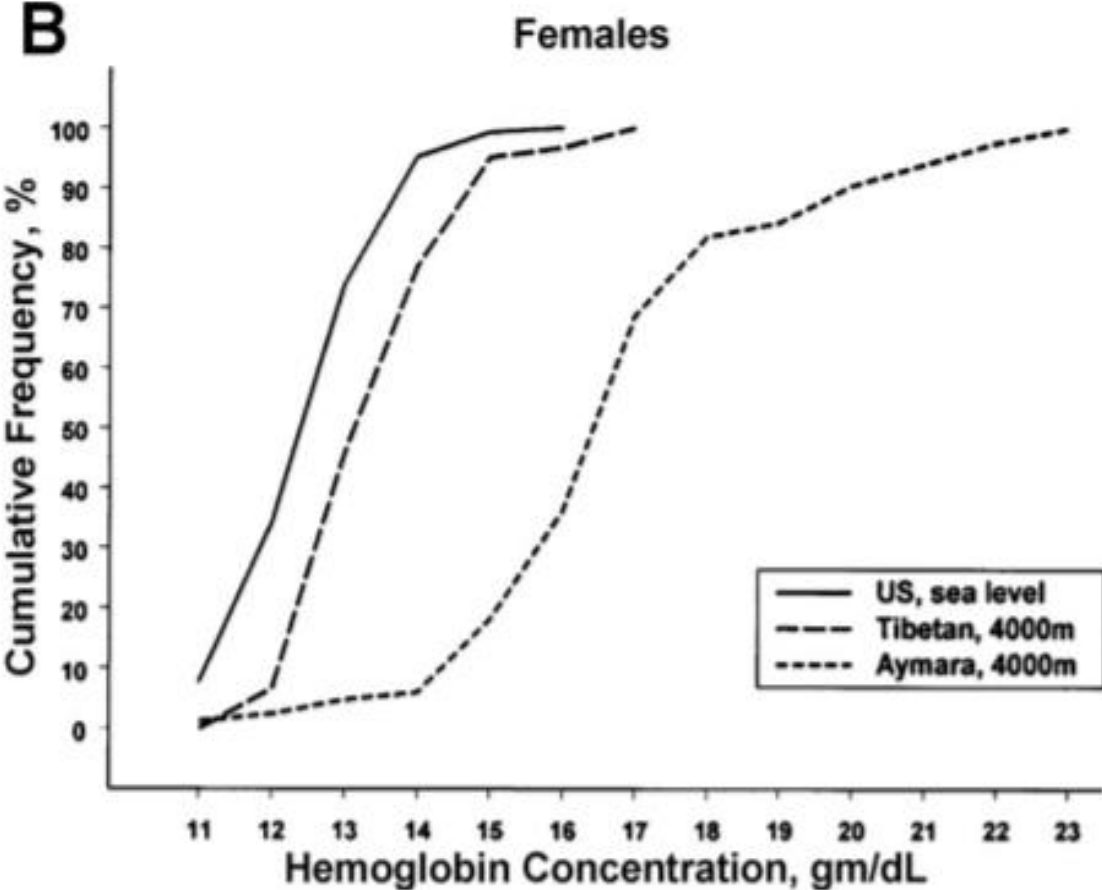
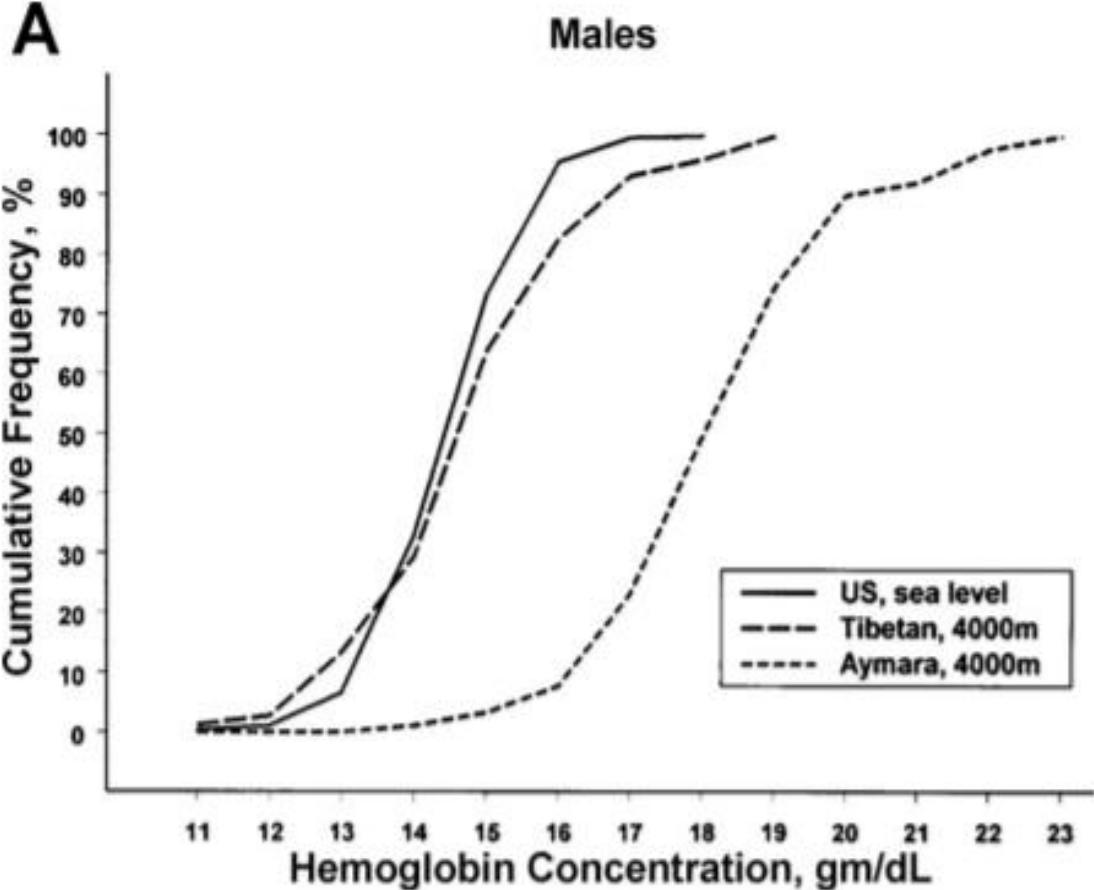

# ADAPTATION TO EXERCISE

1. Muscle hypertrophy
2. Athlete's heart

Athlete's heart:

- Hypertrophy → dilatation
- Increased volume reserve (1.5x)
- Increased chronotropic reserve

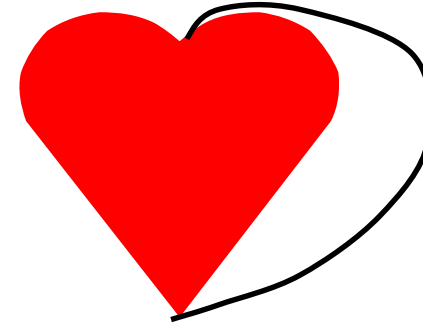

„Physiological“ hypertrophy

- Prolongation of muscle fibres and increase of their thickness (NOT their number!!!)
- Accompanied by normal or increased contractility (speed of ATP hydrolysis by myosin and maximal speed of muscle shortening are either normal or increased)
- In muscles: increased number of mitochondria, increased activity of oxidative metabolism enzymes, proliferation of capillaries

# ADAPTATION TO EXERCISE

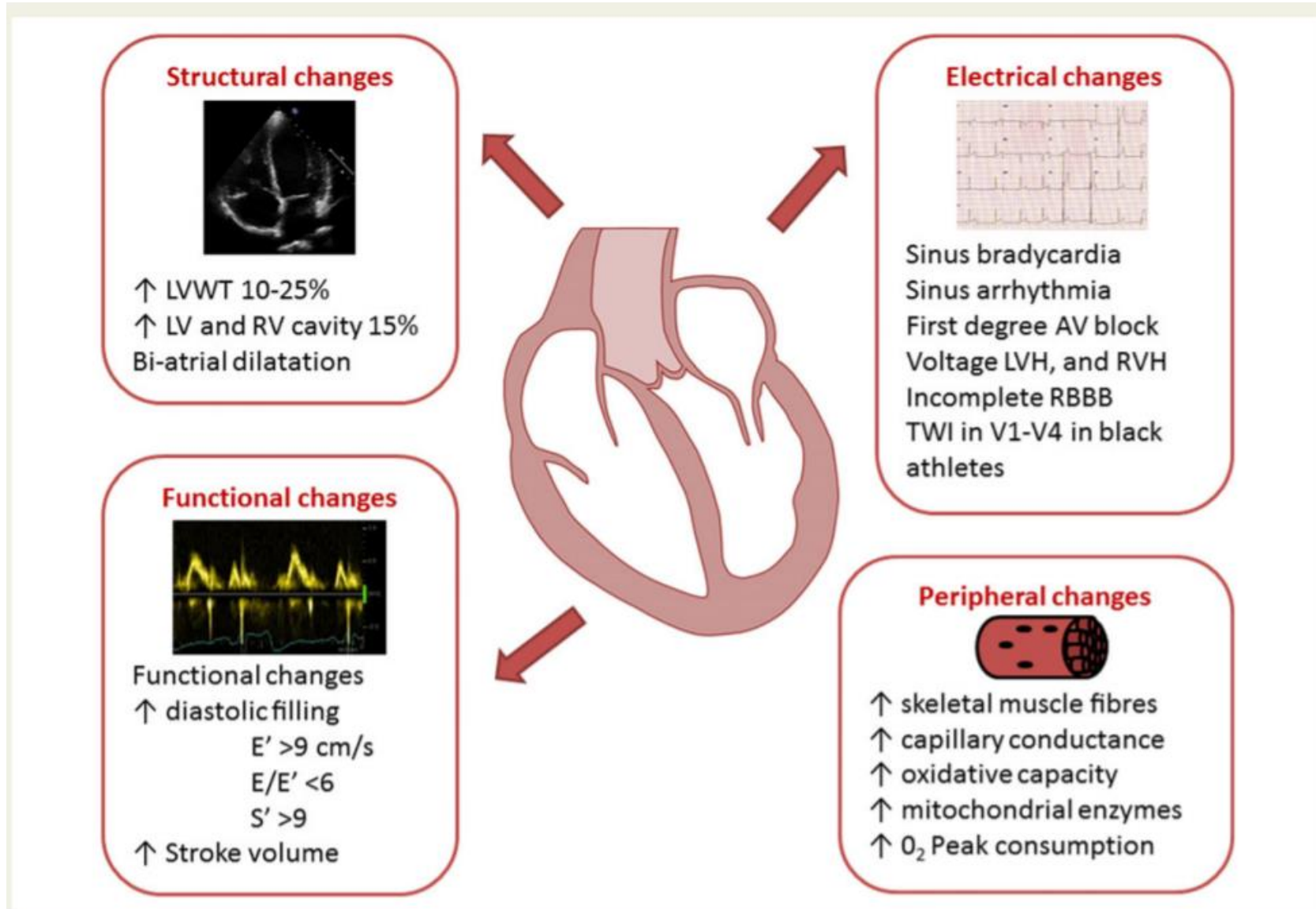

**Figure 2** Cardiovascular and peripheral adaptation to exercise in athletes. AV, atrioventricular; LV, left ventricular; LVH, left ventricular hypertrophy; LVWT, left ventricular wall thickness; RV, right ventricle; RVH, right ventricular hypertrophy; TWI, T-wave inversion.



# ADAPTATION TO EXERCISE

Variable	Sedentary man		Runner
	Pretraining	Posttraining	
<b>Cardiovascular</b>			
HR at rest (beats • min <sup>-1</sup> )	71	59	36
HR max (beats • min <sup>-1</sup> )	185	183	174
SV rest (ml)	65	80	125
SV max (ml)	120	140	200
Q̇ rest (L • min <sup>-1</sup> )	4.6	4.7	4.5
Q̇ max (L • min <sup>-1</sup> )	22.2	25.6	32.5
Heart volume (ml)	750	820	1,200
Blood volume (L)	4.7	5.1	6.0
Systolic BP rest (mmHg)	135	130	120
Systolic BP max (mmHg)	210	205	210
Diastolic BP rest (mmHg)	78	76	65
Diastolic BP max (mmHg)	82	80	65
<b>Respiratory</b>			
Ṁ <sub>E</sub> rest (L • min <sup>-1</sup> )	7	6	6
Ṁ <sub>E</sub> max (L • min <sup>-1</sup> )	110	135	195
TV rest (L)	0.5	0.5	0.5
TV max (L)	2.75	3.0	3.9
RR rest (breaths • min <sup>-1</sup> )	14	12	12
RR max (breaths • min <sup>-1</sup> )	40	45	50
<b>Metabolic</b>			
A-ṡO <sub>2</sub> diff rest (ml • 100 ml <sup>-1</sup> )	6.0	6.0	6.0
A-ṡO <sub>2</sub> diff max (ml • 100 ml <sup>-1</sup> )	14.5	15.0	16.0
ṀO <sub>2</sub> rest (ml • kg <sup>-1</sup> • min <sup>-1</sup> )	3.5	3.5	3.5
ṀO <sub>2</sub> max (ml • kg <sup>-1</sup> • min <sup>-1</sup> )	40.5	49.8	76.5
Blood lactate rest (mmol • L <sup>-1</sup> )	1.0	1.0	1.0
Blood lactate max (mmol • L <sup>-1</sup> )	7.5	8.5	9.0

**Volume Overload**  
Aerobic exercise  
Pregnancy  
Early mitral regurgitation

**Pressure Overload**  
Chronic hypertension  
Aortic Stenosis  
Aortic Coarctation

Hemodynamic  
Stress

Hemodynamic  
Stress

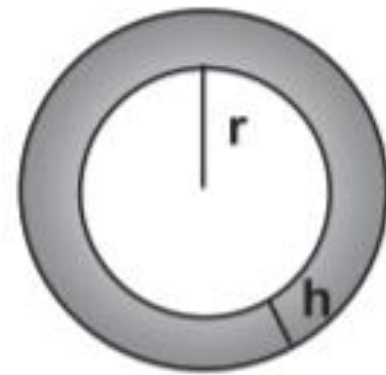

**Athlete's heart**  
 $r/h=c$

Eccentric hypertrophy

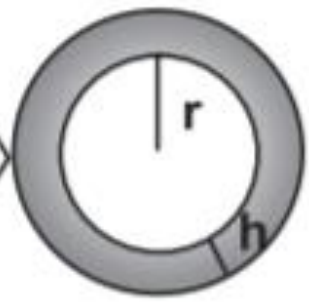

**Normal**  
 $r/h=c$

Concentric hypertrophy

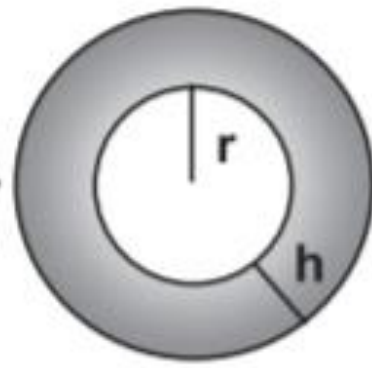

**Compensated Hypertrophy**  
 $r/h < c$

Time

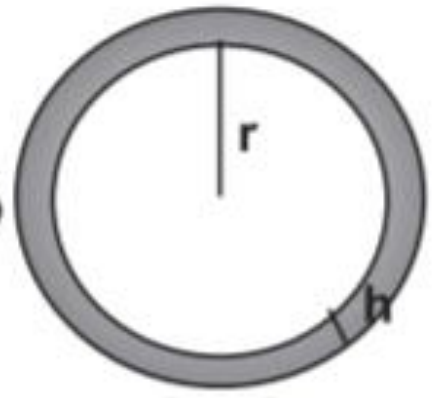

**Cardiomyopathic Dilation**  
 $r/h \gg c$



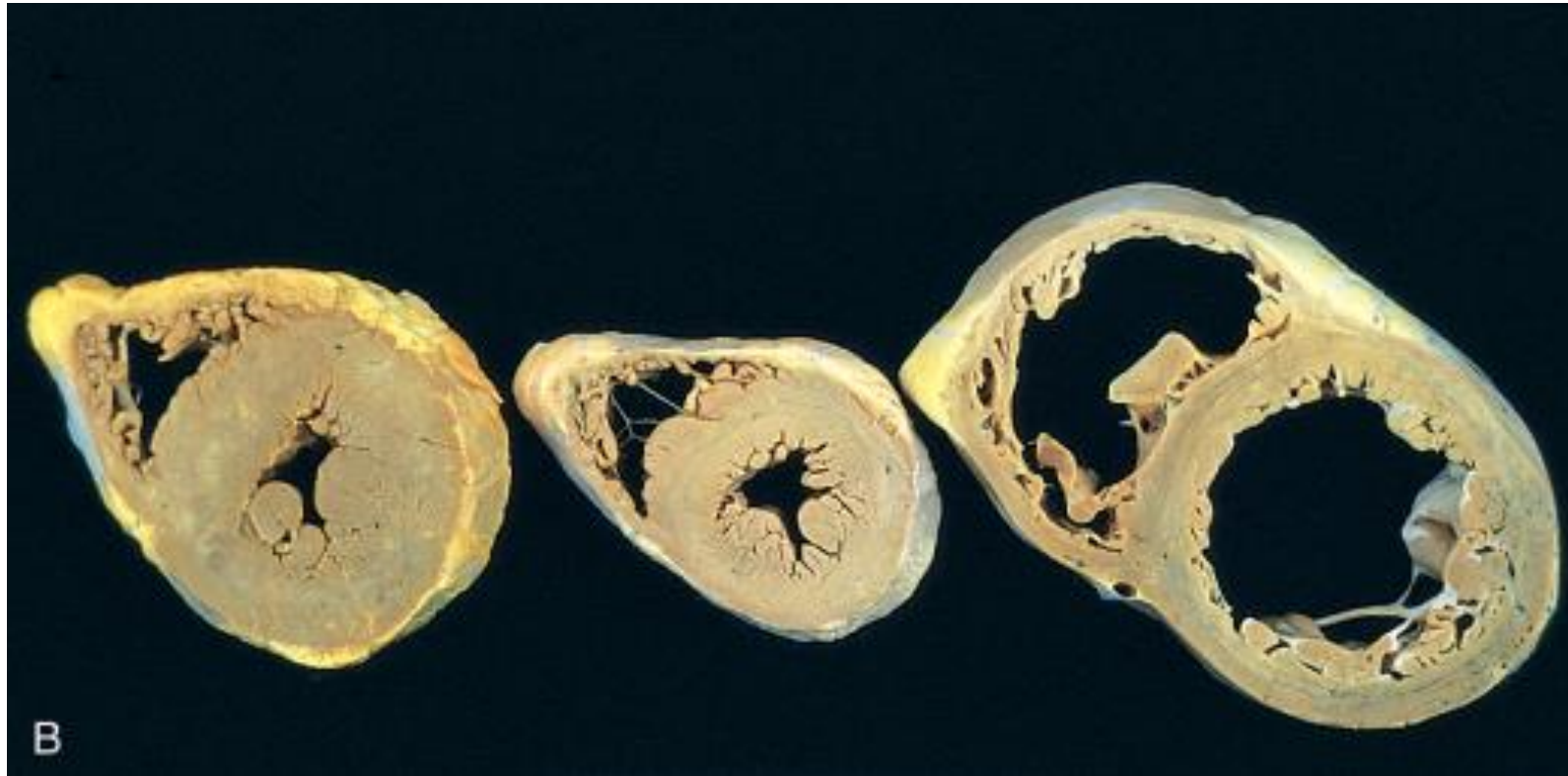

Transversal heart section:

hypertonic heart with concentric hypertrophy (left)

normal heart (middle)

hypertonic heart with eccentric hypertrophy = hypertrophy + dilation (right)

**Physiologically  
normal**

**Pathological  
heart failure**

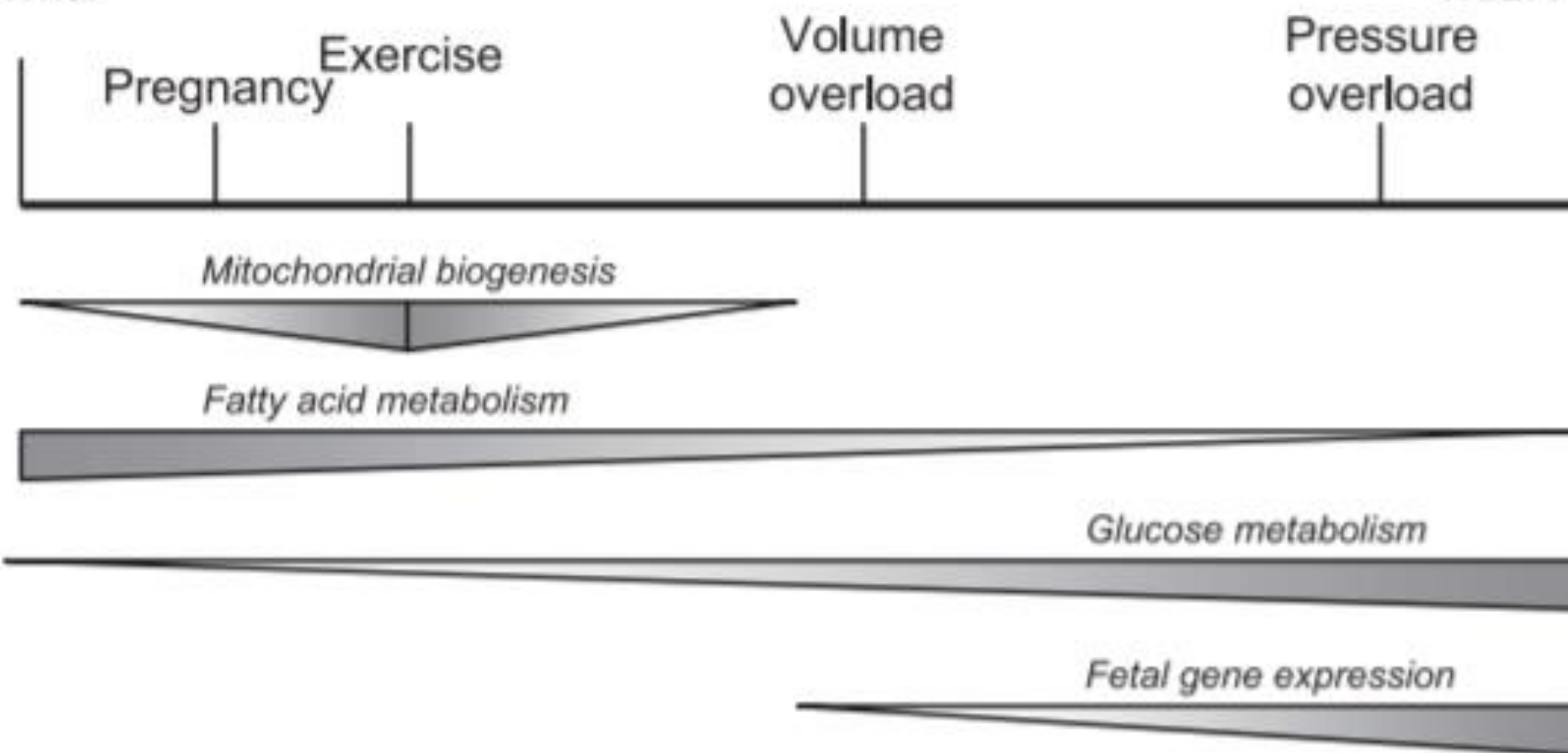

# EXERCISE AND HEART – GOOD, BAD, HARMFULL ???

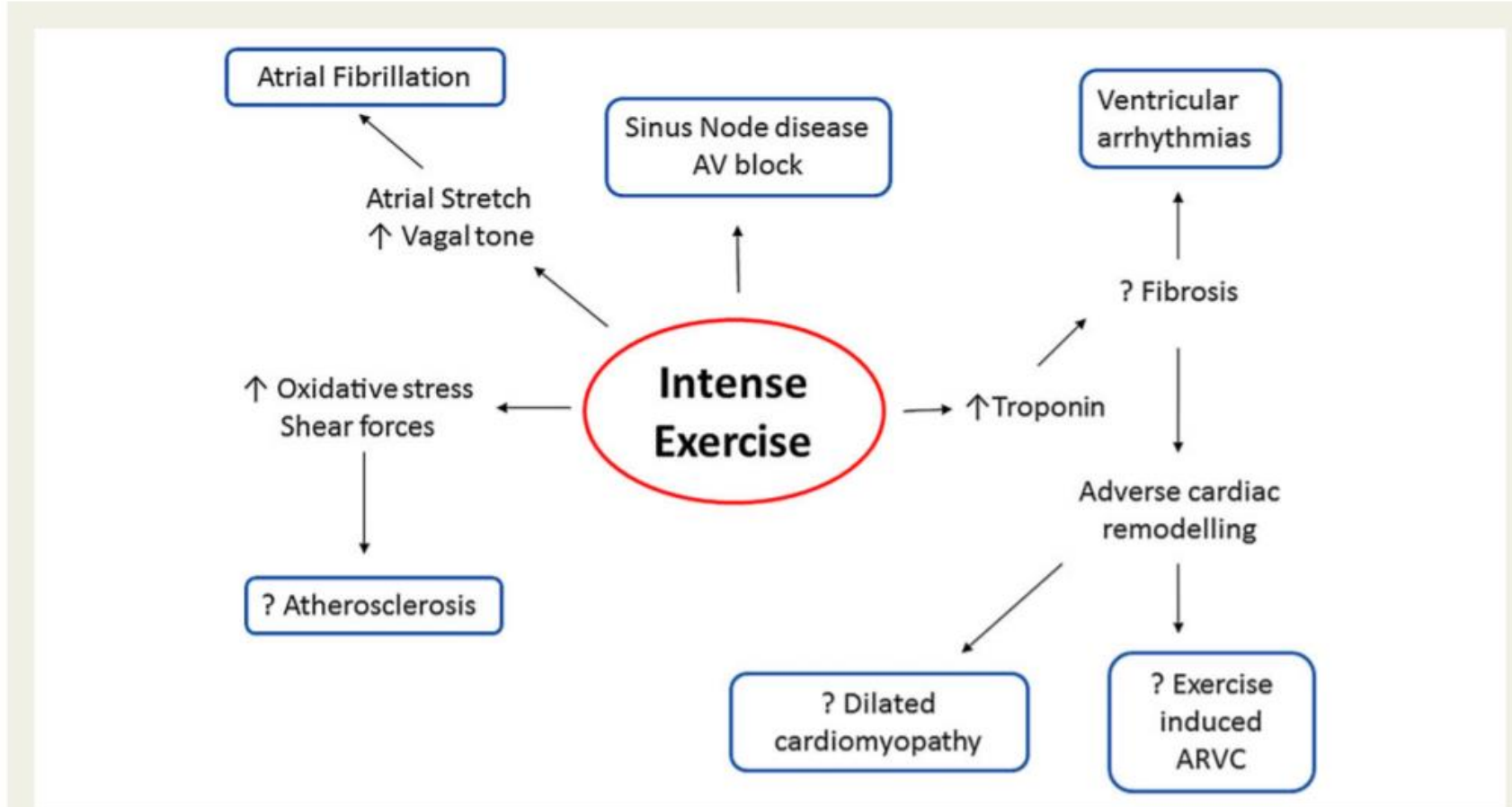

**Figure 6** Speculated mechanisms for the detrimental effects of exercise. ARVC, arrhythmogenic right ventricular cardiomyopathy; AV, atrioventricular; DCM, dilated cardiomyopathy.