

MUNI
MED

ELECTROCARDIOGRAPHY. ARRHYTHMIAS.

ELECTROCARDIOGRAPHY = methods enabling to register electrical changes caused by heart activity from body surface.

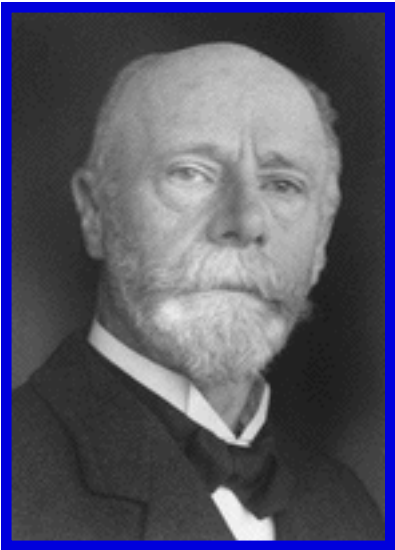

Willem Einthoven

1860 - 1927

1893 Einthoven introduces the term 'electrocardiogram'

1895 Einthoven distinguishes five deflections - P, Q, R, S and T

1902 Einthoven publishes the first electrocardiogram

1905 Einthoven starts transmitting electrocardiograms from the hospital to his laboratory 1.5 km away via telephone cable

1924 the Nobel prize

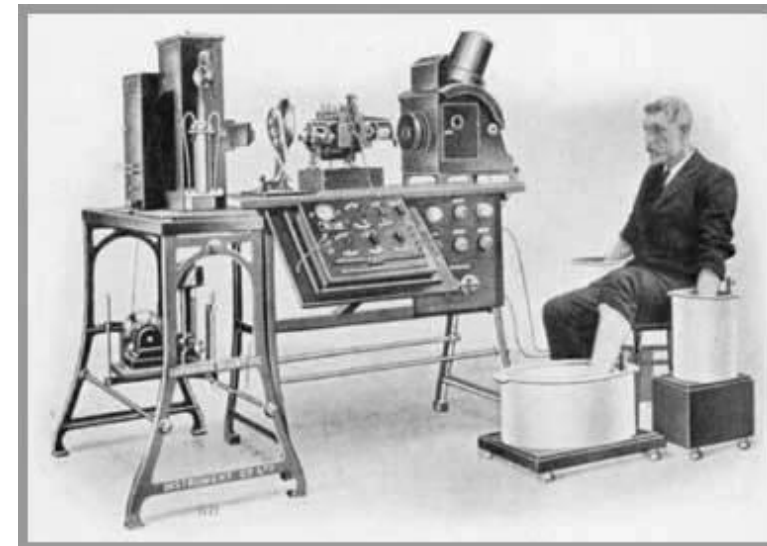

ELECTRICAL DIPOLE

stationary in homogenously conducting environment

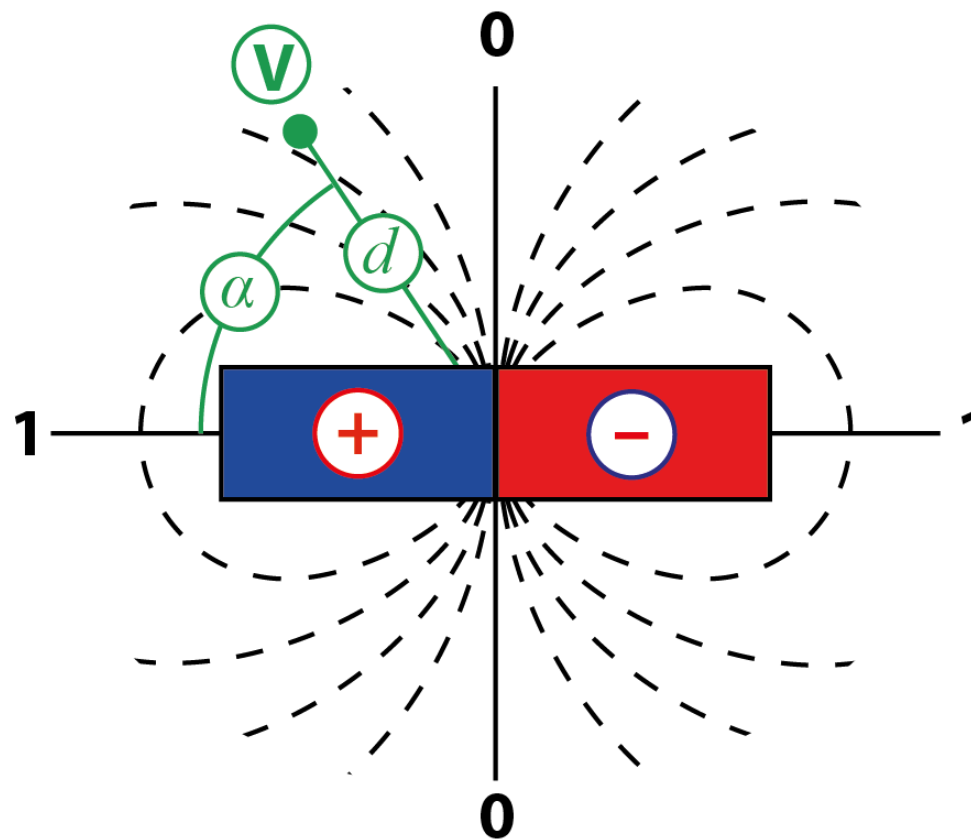

Local currents

- Maximal in dipole axis (1)
- Zero in the place of the centre (0)

SPREADING OF DEPOLARIZATION FRONT

ELECTRICAL FIELD OF THE HEART (vector)

- Consists of sum of momentary dipoles on the depolarization front
- Its size** is a function of number of dipoles and steepness of boundary line
- Direction from** depolarized (-) to (re)polarized (+) area

REGIONAL VECTORS
INTEGRAL VECTOR

during excitation is changing:

- Size of momentary dipoles
- Their direction
- They are spreading to body surface – ELECTROCARDIOGRAPHY

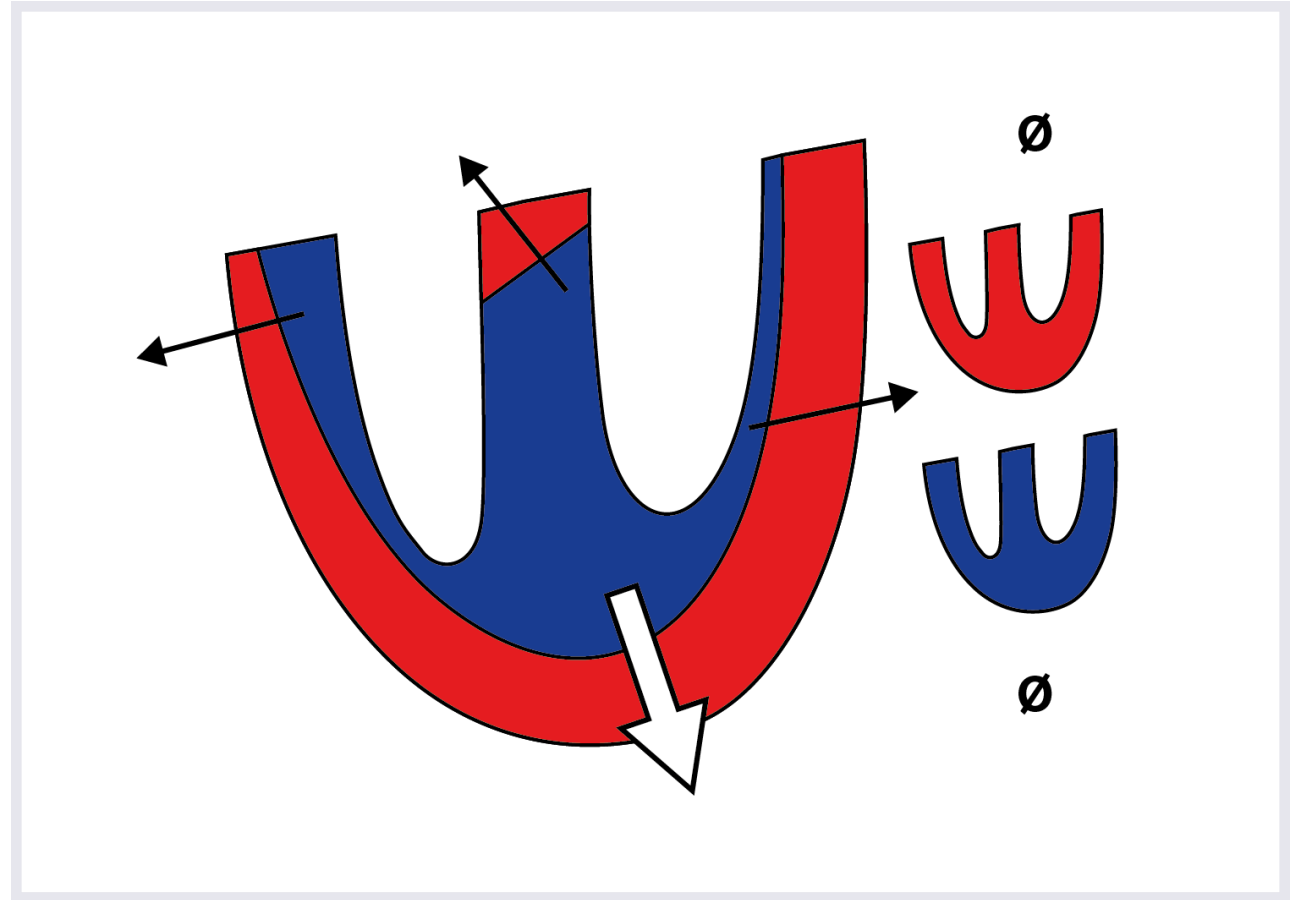

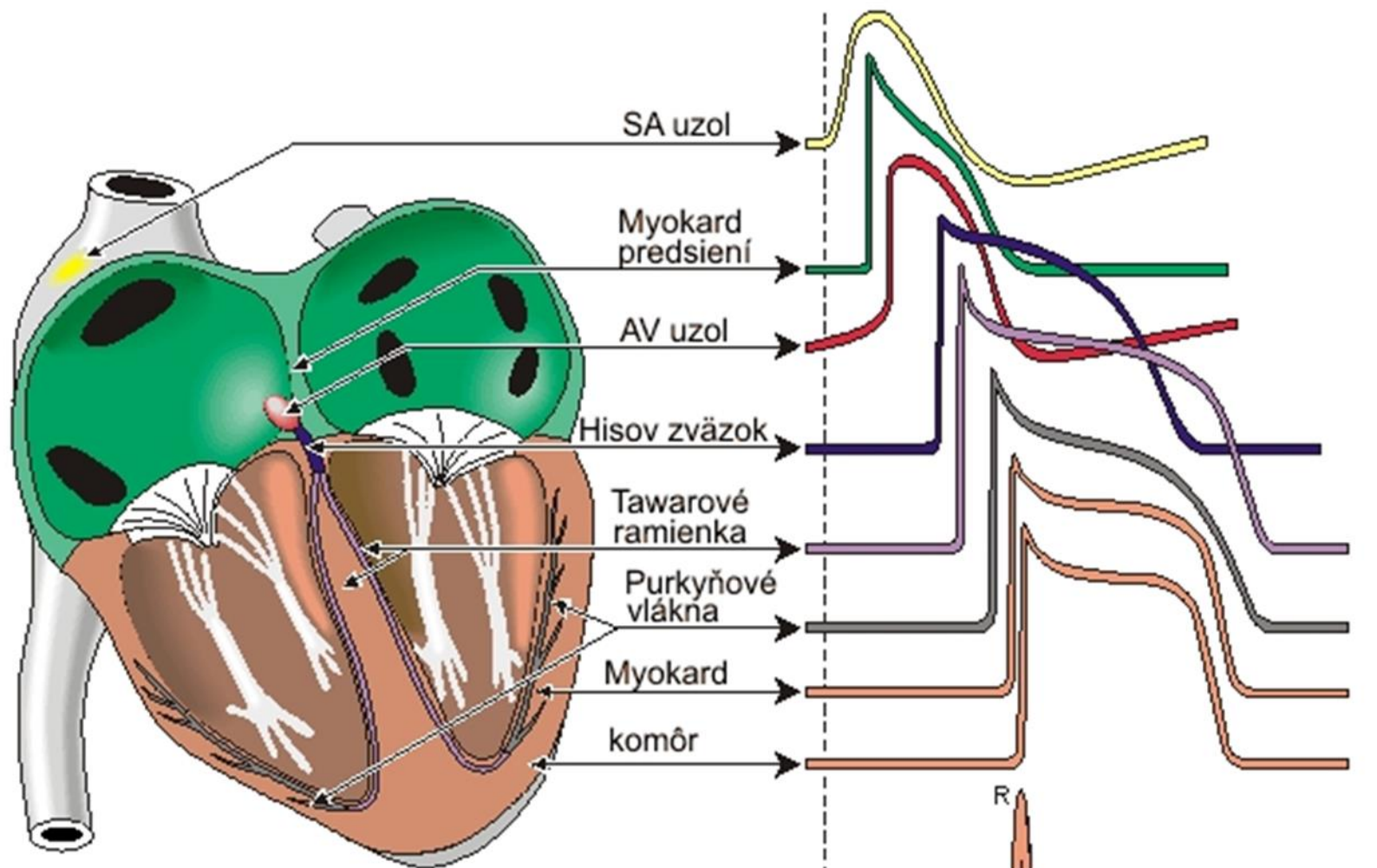

EKG

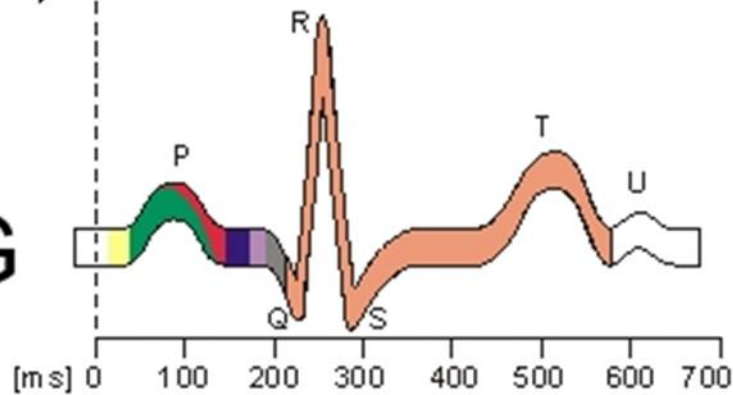

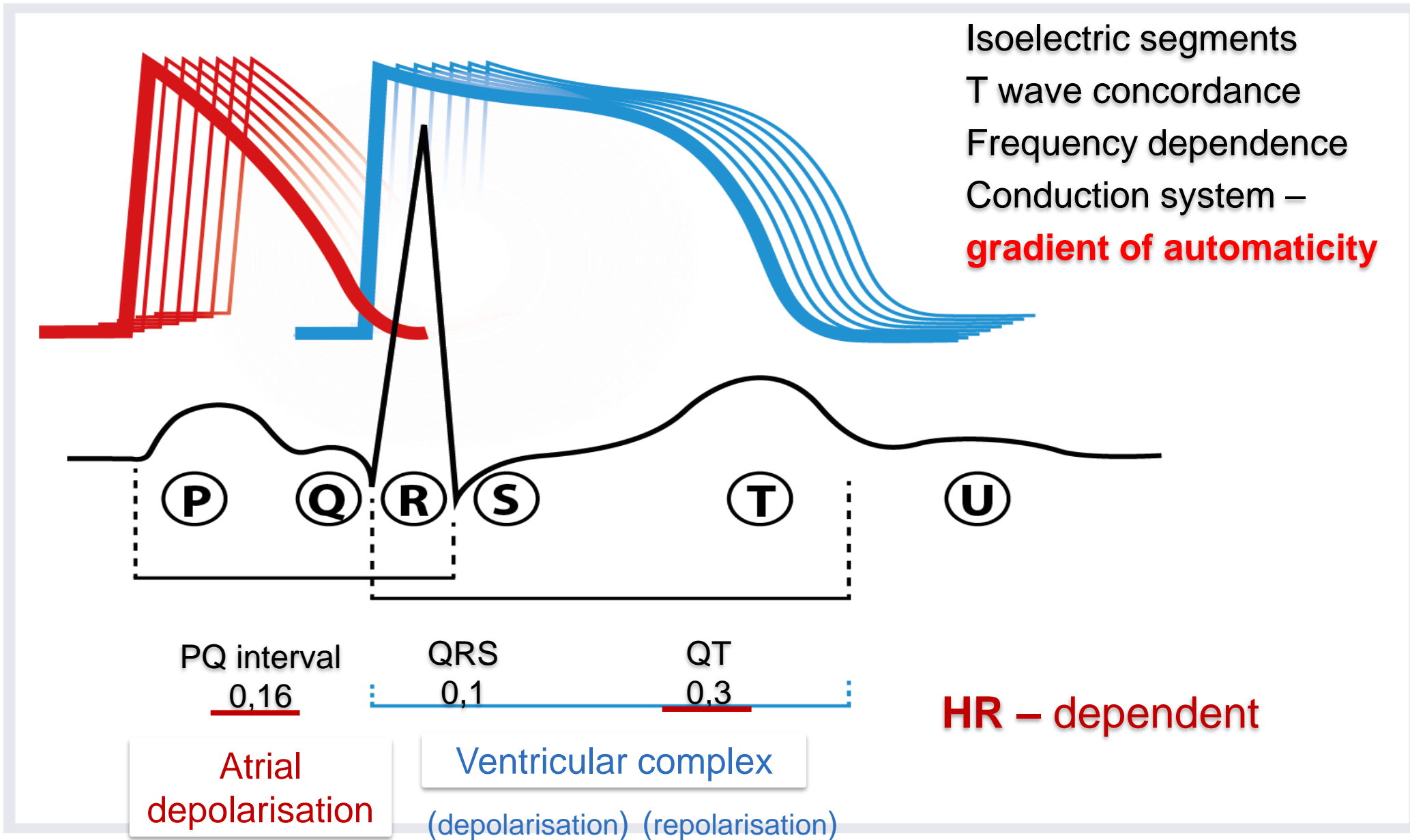

ECG gives information about:

1. **Frequency** (changes of HR in SA node or arrhythmias, sick sinus syndrome)

2. **Conduction** (blocks – SA, AV)

3. **Rhythm** (ES – supraventricular, ventricular)

4. **Ventricular gradient** (relationship between depolarization and repolarization:

origin – metabolic, hemodynamic, anatomic, physical...ischemia, hypertrophy,

dilatation, cardiomyopathy, inflammations, changes in electrolytes, drugs...)

3D LOOPS OF ELECTRICAL AXIS

F – frontal plane
S – sagittal plane
H – horizontal plane

0 – electric center of the heart
P – atrial depolarization
QRS – ventricular depolarization
T – ventricular repolarization

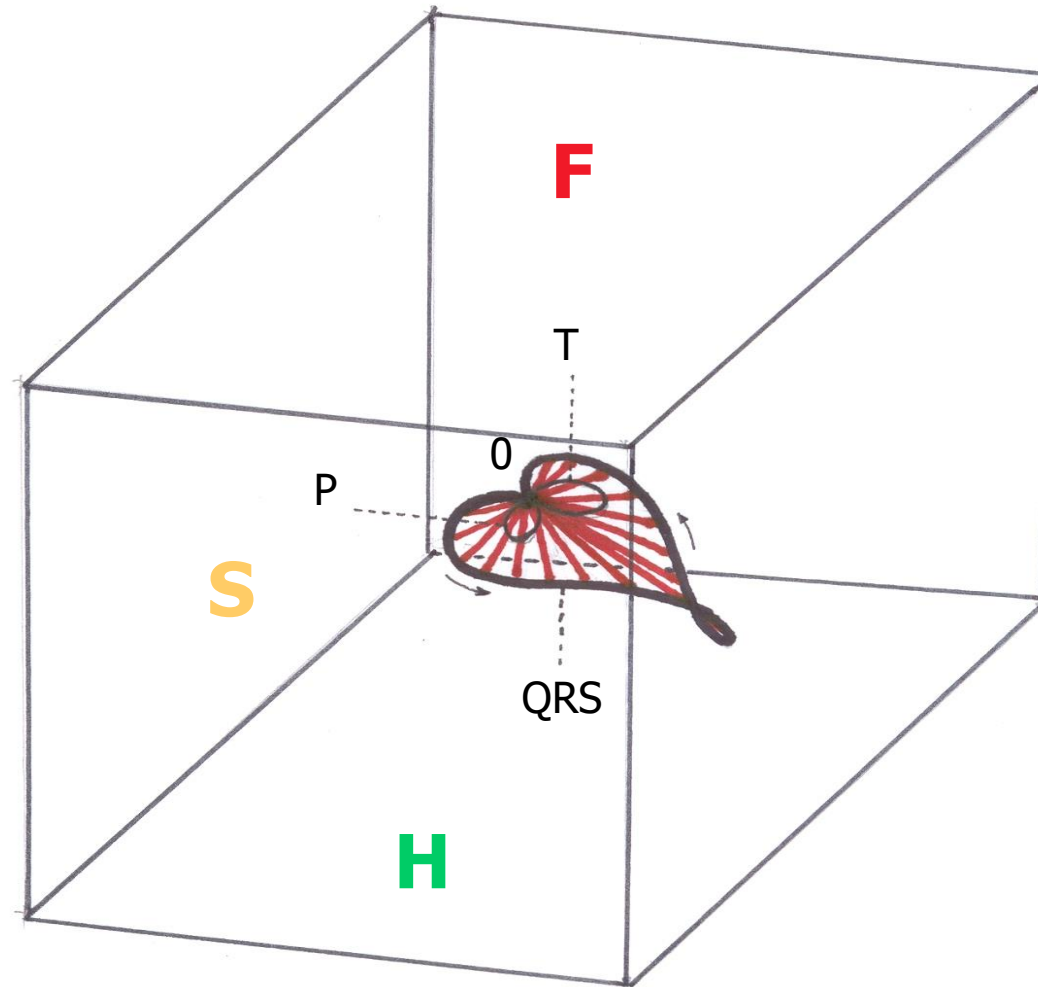

2D PROJECTION OF HEART AXIS

F – frontal plane
S – sagittal plane
H – horizontal plane

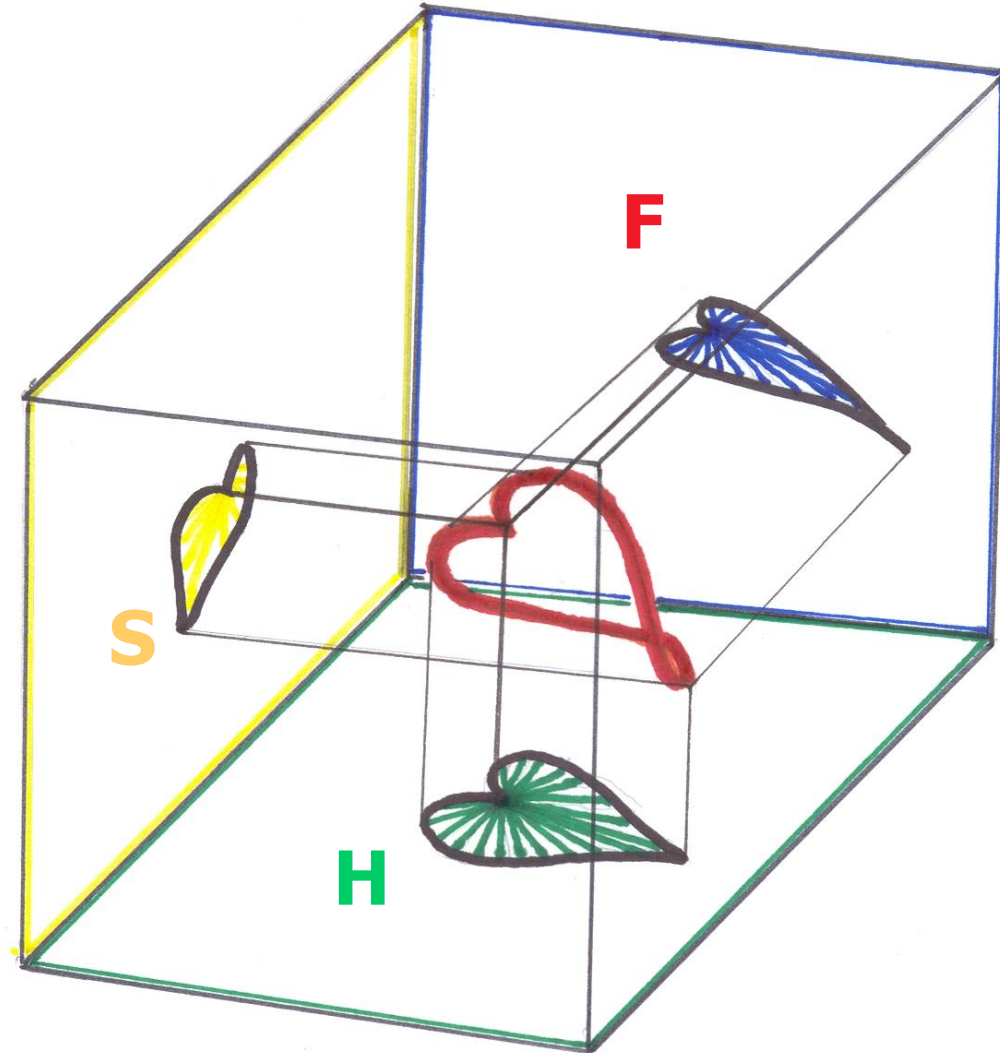

1D PROJECTION OF HEART AXIS

Projection on the chest surface
into frontal plane (2D)

And its projection to line
(1D), axis of the I. ECG lead

in time

E – Einthoven triangle

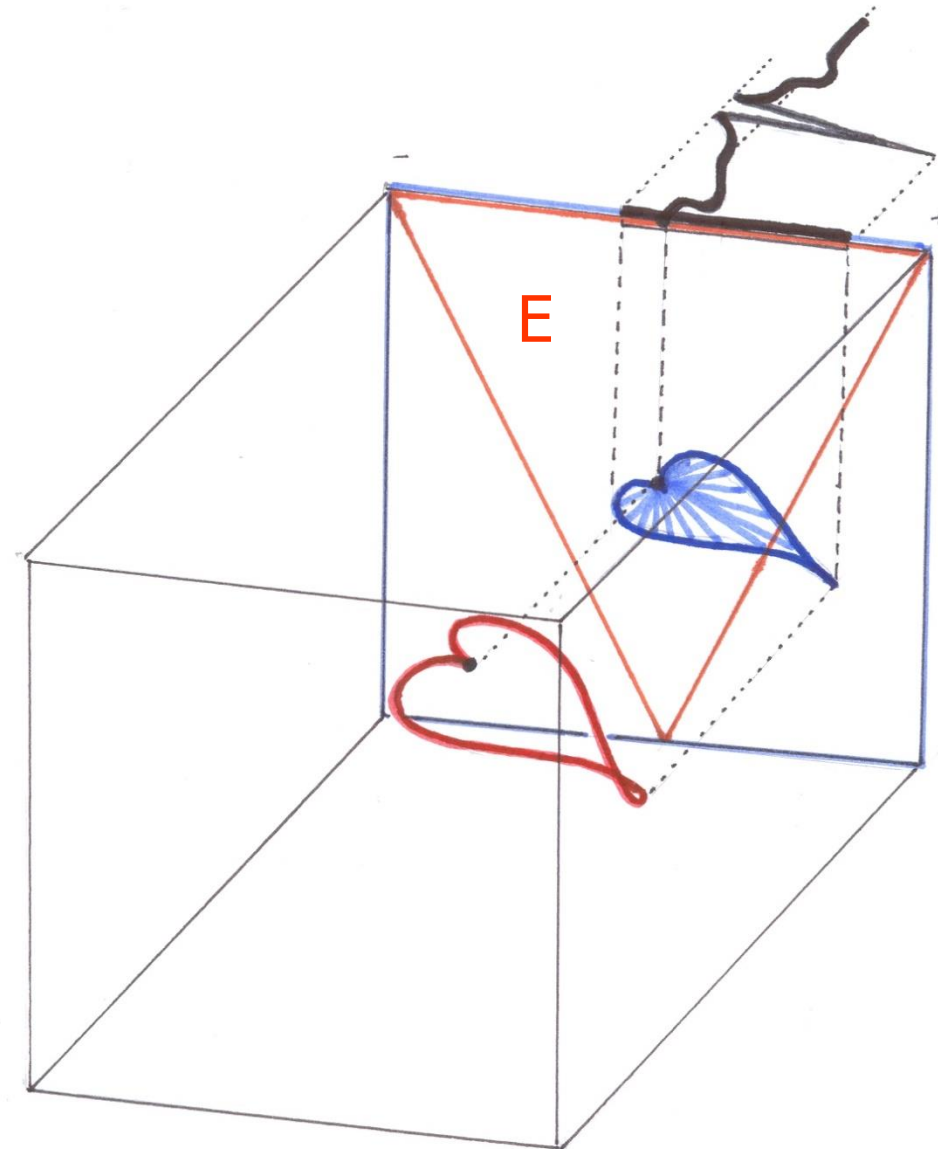

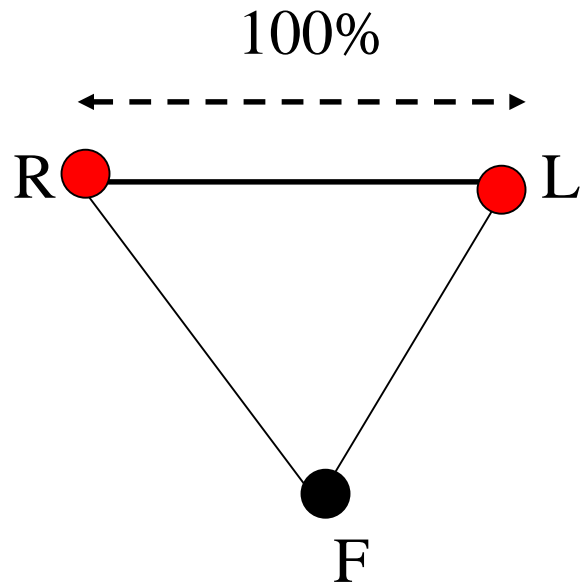

Einthoven, 1913

I, II, III

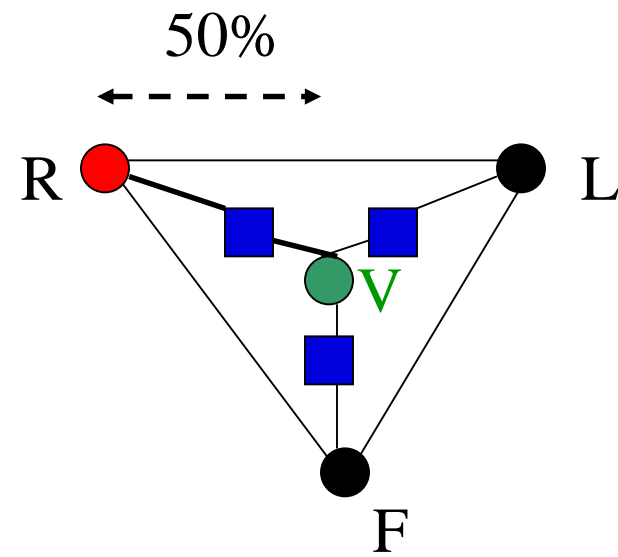

Wilson, 1934, VR, VL, VF

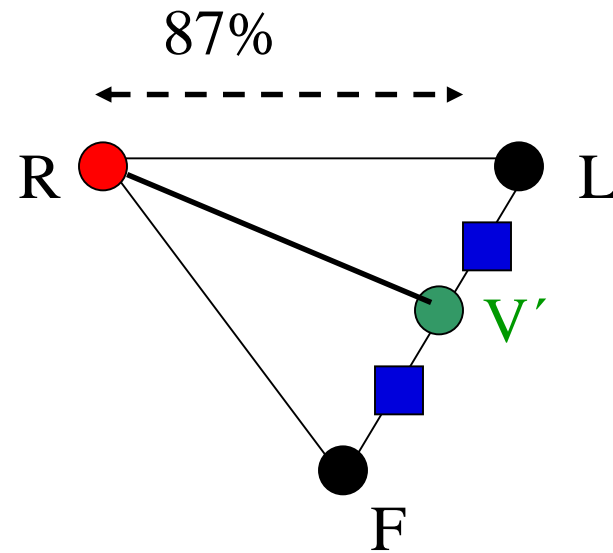

Goldberger, 1947, aVR, aVL, aVF

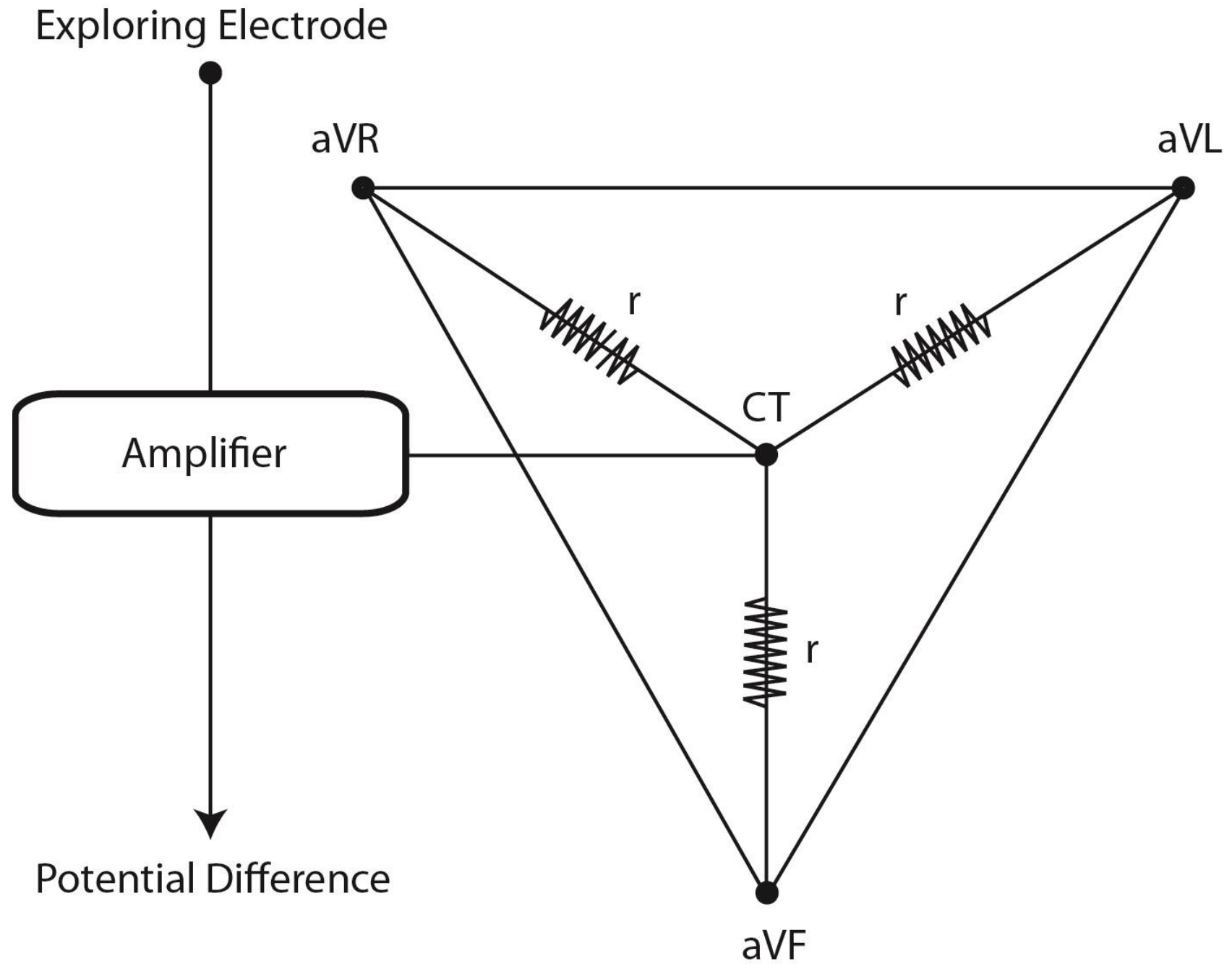

HEXAAXIAL SYSTEM

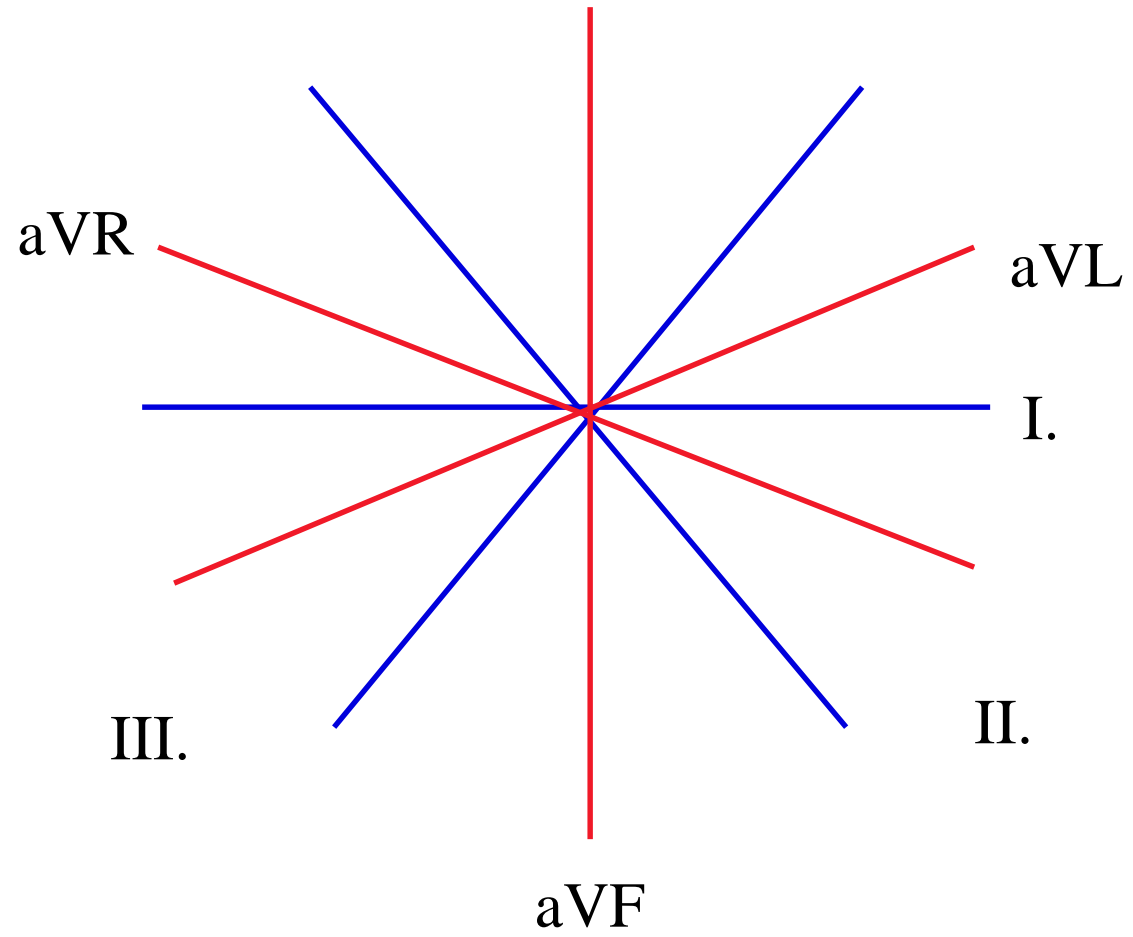

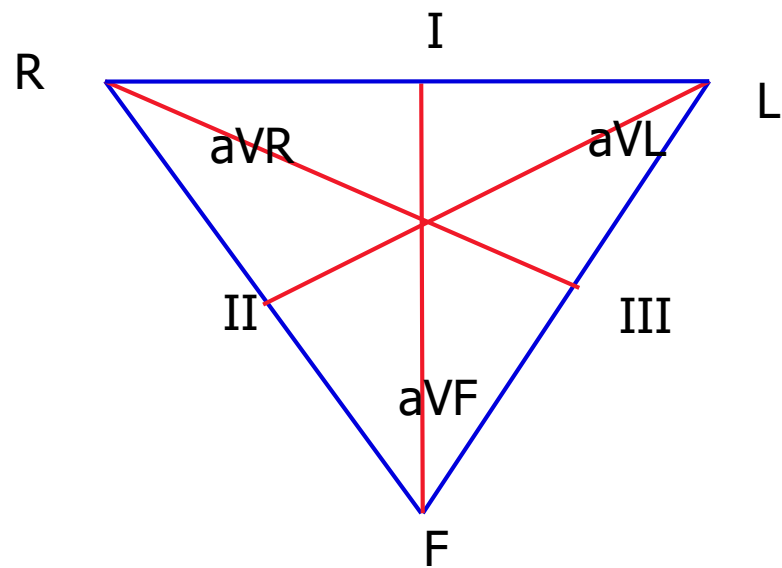

LIMB LEADS

Frontal projection of vector!

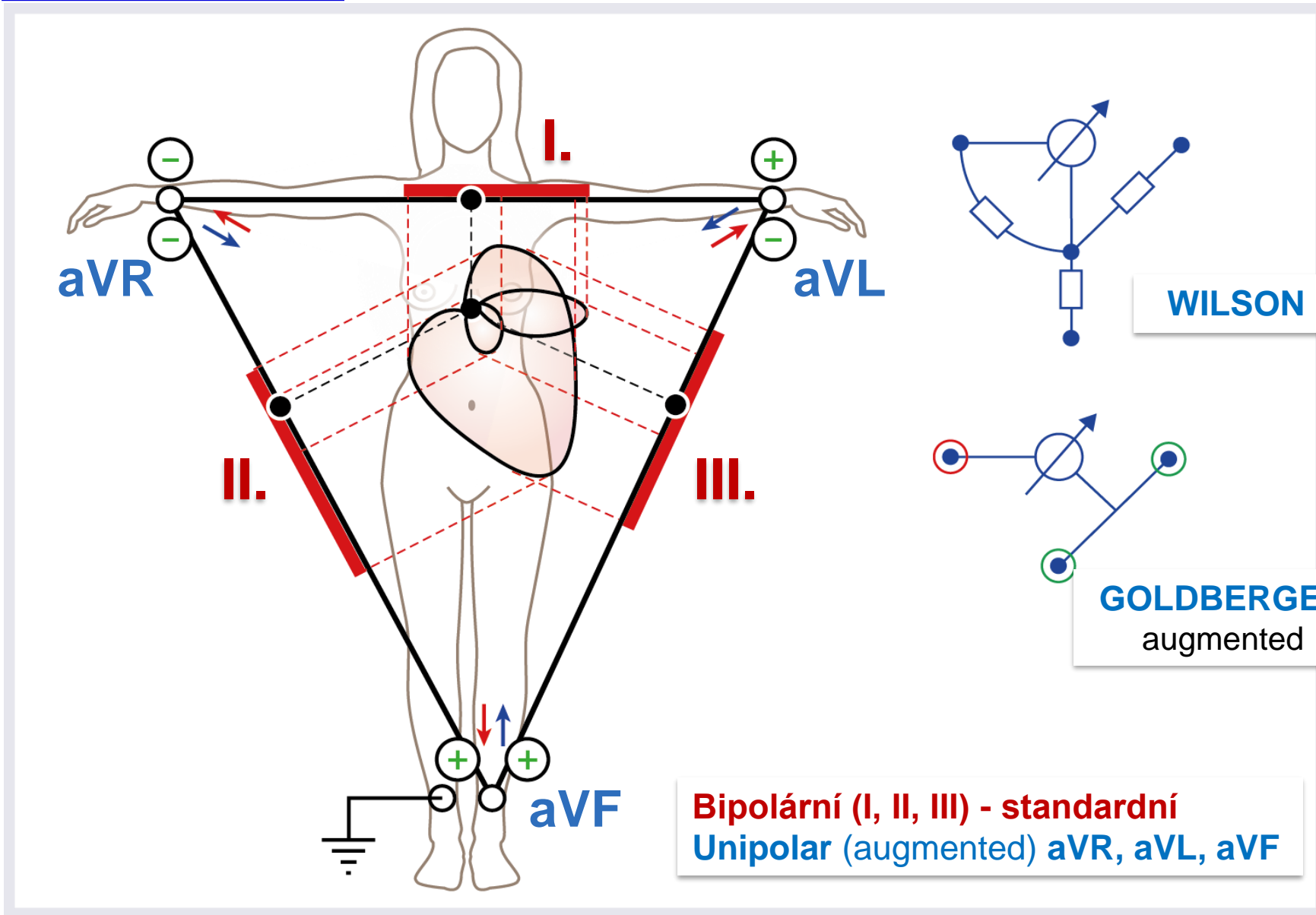

CHEST LEADS

Horizontal projection of vector!

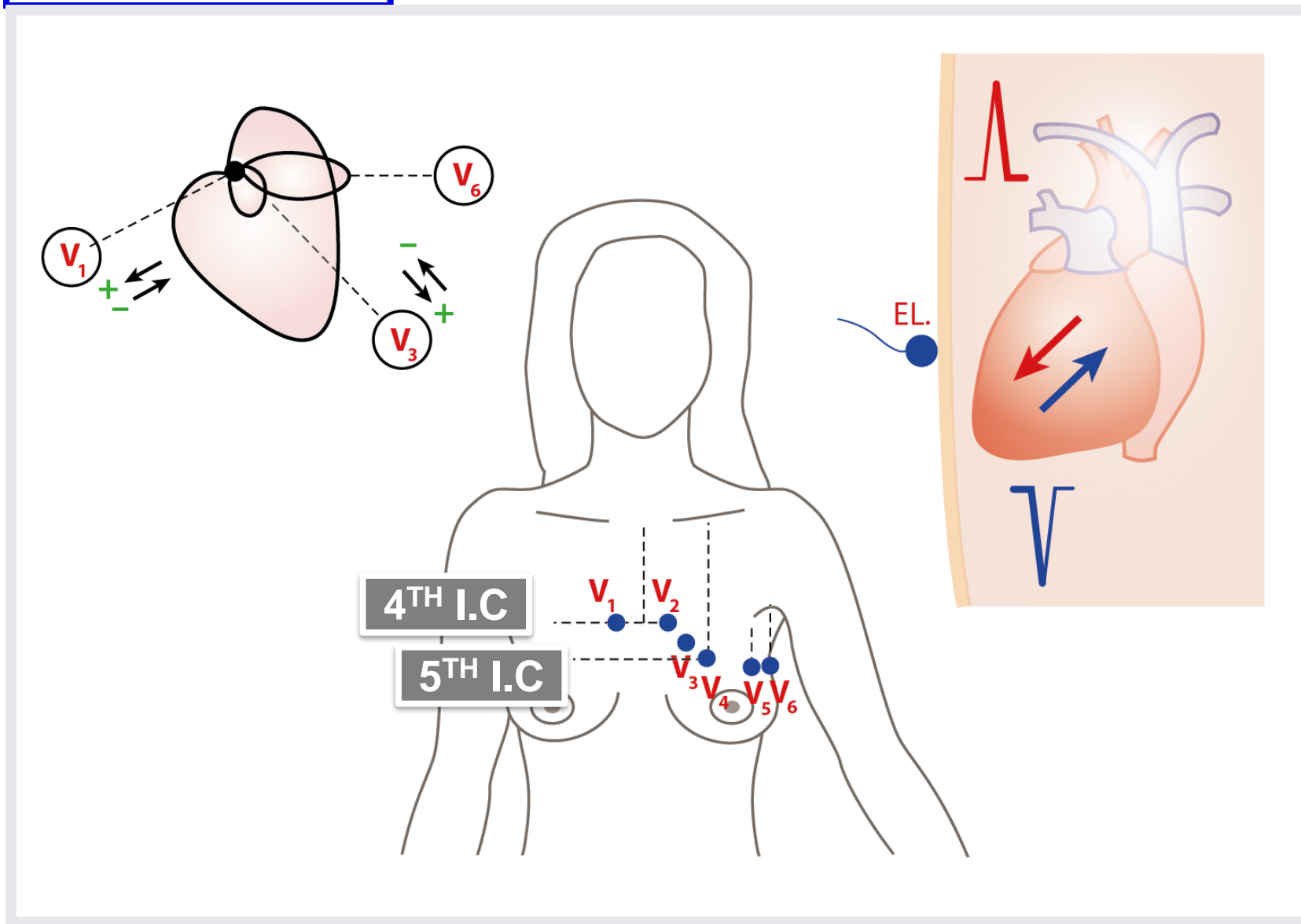

PROJECTION PLANES OF CARDIAC VECTOR and ECG LEADS

Frontal plane

Limb leads

I., II., III., aVR, aVL, aVF

Horizontal plane

V1 – V6

Both planes are shifted into the level of electrical center of the heart (0)

E – Einthoven triangle

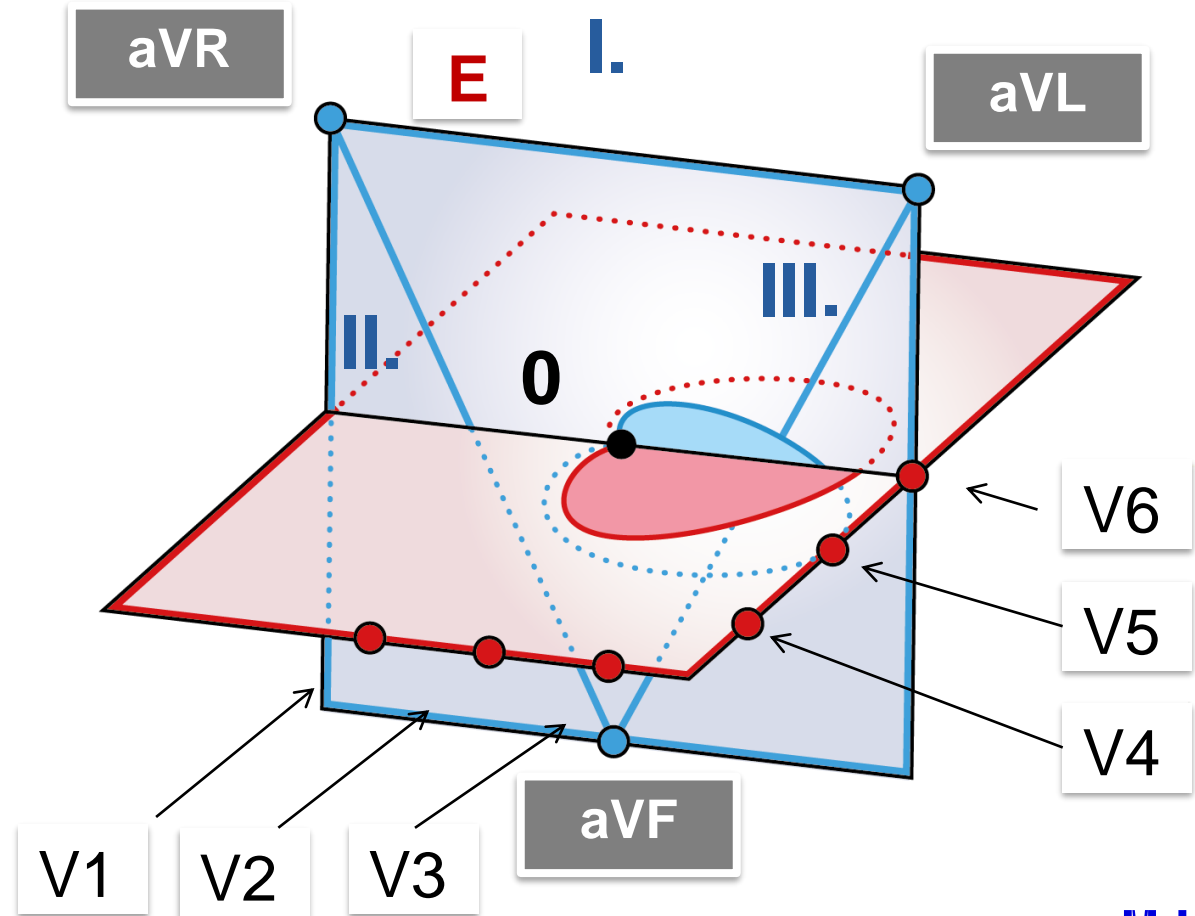

ISOLATED HEART perfused according to Langendorff

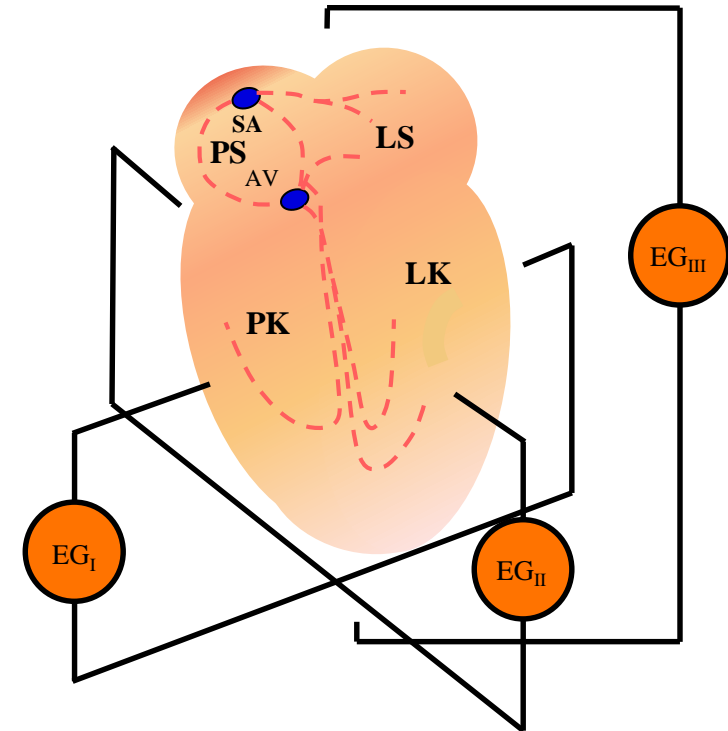
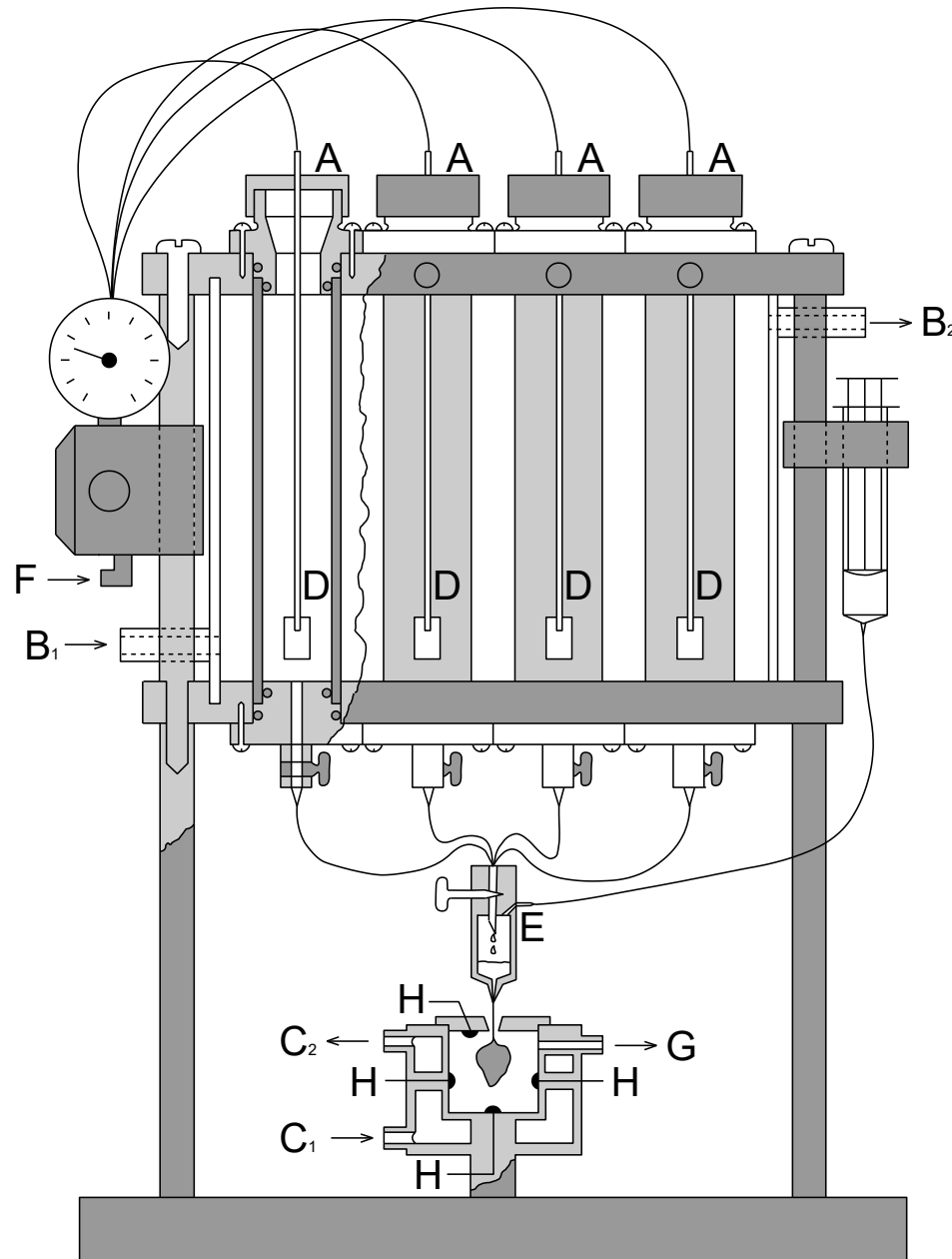

ELECTRICAL AXIS OF THE HEART

Summary of all momentary vectors, which form ventricular depolarisation loop. Expresses the direction of ventricular activation. Reflects asymmetry in ventricular wall thickness and the position of the heart in the chest.

ELECTRICAL AXIS – in the frontal plane

(R–Q–S) in lead I., II., III.

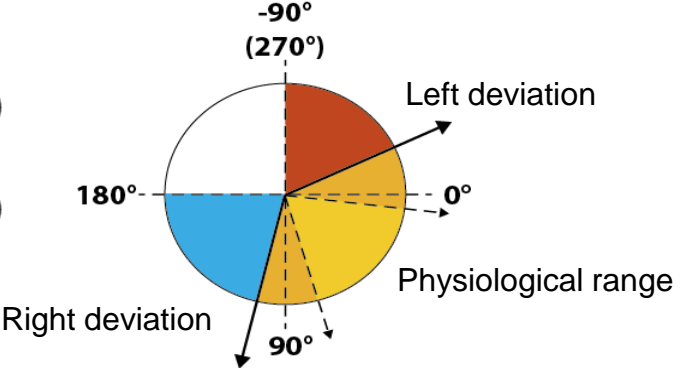
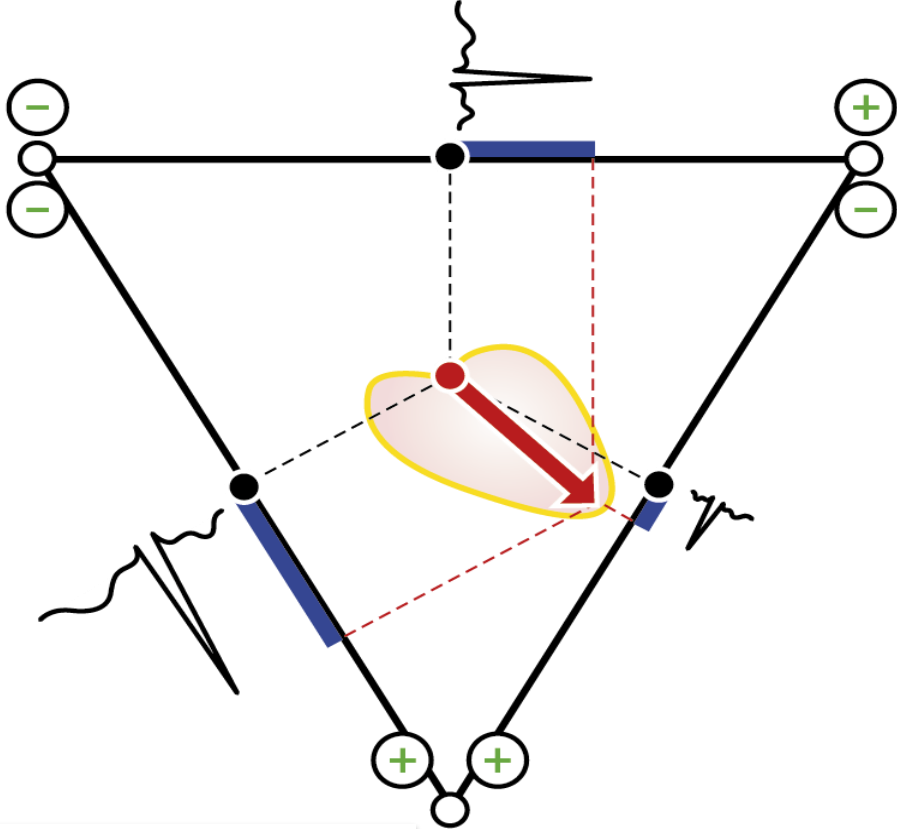

• **equilateral**
Einthoven triangle

Terminology →

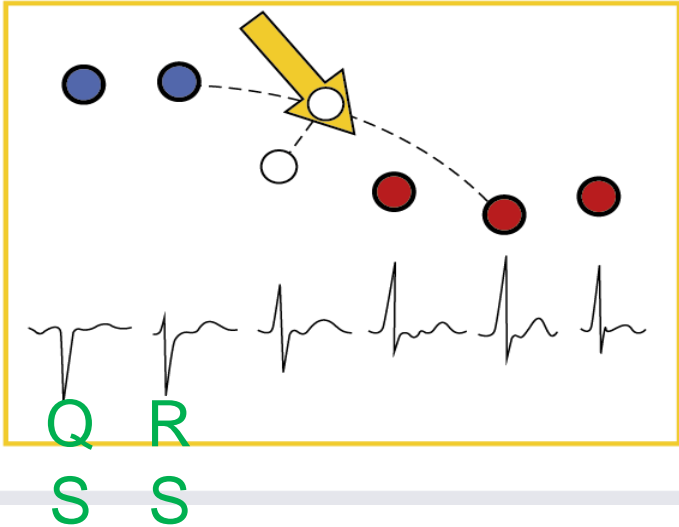

LEFT DEVIATION, RIGHT DEVIATION

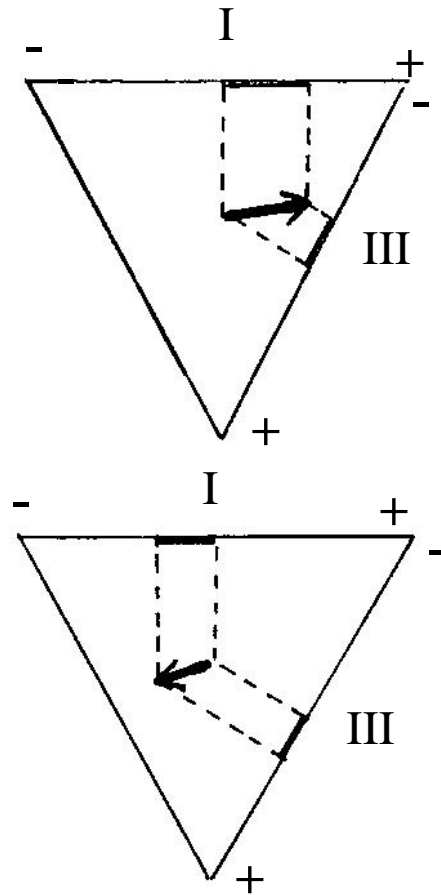
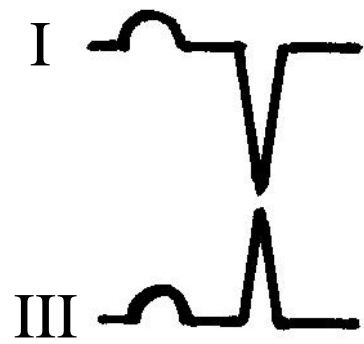
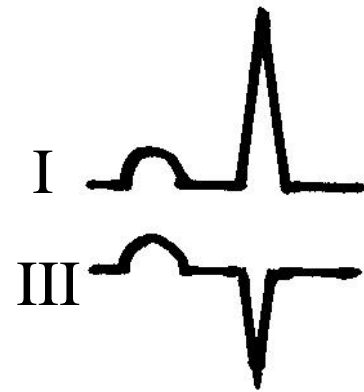

Physiological 12-lead electrocardiogram

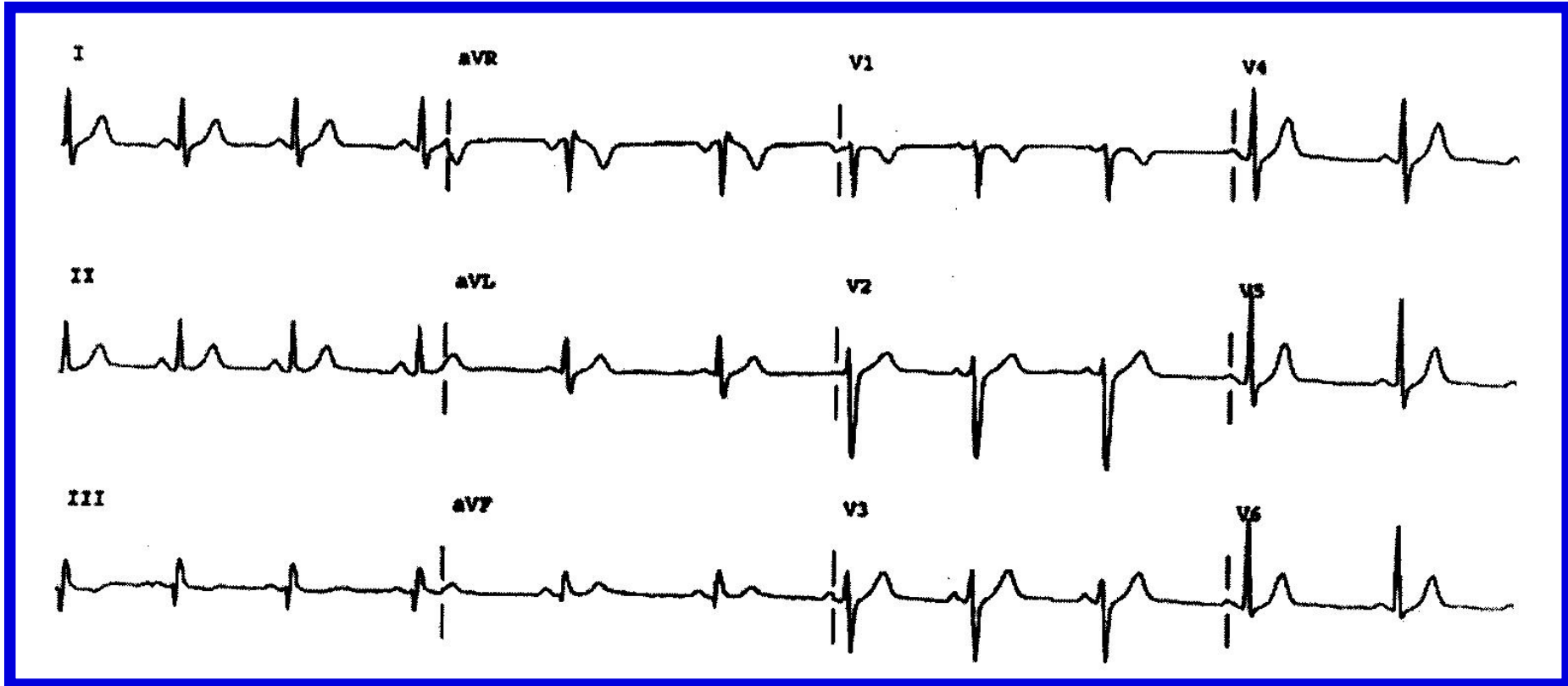

ECG – information about:

1. Magnitude and position of the heart (electrical axis)
2. Site of impulse origin (P, QRS)
3. Conduction path (P-Q, QRS)
4. Impulse regression – repolarization (T)
5. Rhythm (P-P, R-R)
6. Action potential alterations (ST, T)
7. Effect of drugs, remedies, ion composition changes,...

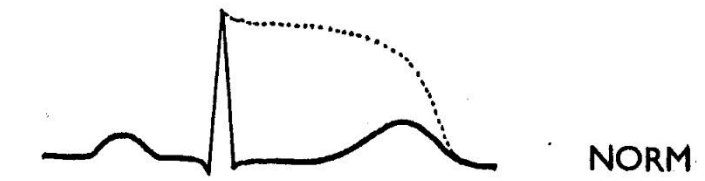
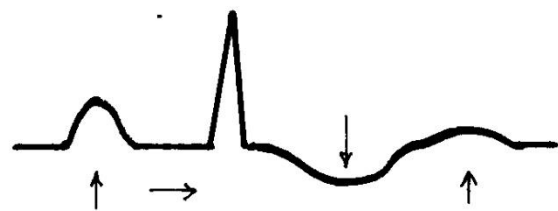

NORM

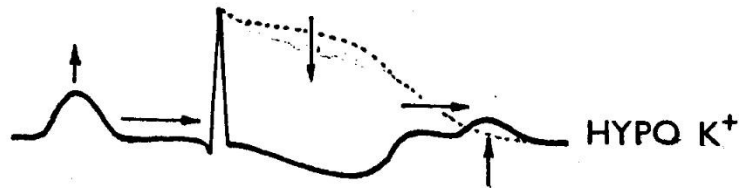

HYPO K⁺

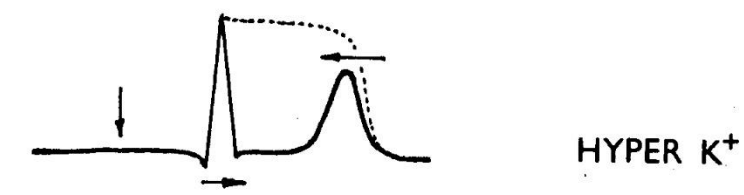

HYPER K⁺

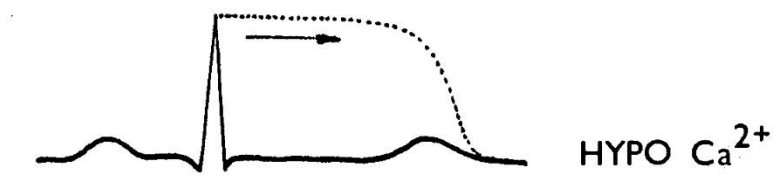

HYPO Ca²⁺

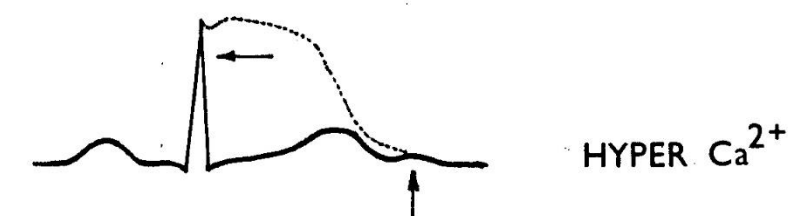

HYPER Ca²⁺

ARRHYTHMIAS

disturbance of impulse generation

or

disturbance of impulse conduction

RESPIRATORY (SINUS) ARRHYTHMIA

1847, Ludwig, ECG and breathing of dog – respiratory sinus arrhythmia

Detectable already during prenatal life.

Present in numerous species in animal kingdom – in all vertebrates.

Physiological meaning ????? STABILISATION OF MEAN BP (protection against mechanical effect of intrathoracic pressure on arterial BP)

Key effect of parasympathetic NS (decrease of its tonus), sympathetic NS only modulates!!!

MECHANISMS:

- 1) CENTRAL
- 2) REFLEXES FROM LUNGS
- 3) REFLEXES FROM BARORECEPTORS
- 4) REFLEXES FROM RECEPTORS IN THE RIGHT ATRIUM
- 5) LOCAL EFFECTS ON SA NODE
- 6) EFFECT OF OSCILLATIONS OF pH, paO_2 , $paCO_2$

Central mechanisms

Central generator of RSA

Respiratory neurons in medulla oblongata hyperpolarise preganglionic vagal neurons

Vagal tonus decreases during inspiration – HR increases

Lung reflexes – inflation reflexes

Stimulation of vagal stretch-receptors during inspiration suppresses inspiratory centre and also cardio-inhibitory centre in medulla oblongata

Reflexes from baroreceptors

Diverse opinions about the effect of arterial baroreceptors on RSA

Fluctuation of sensitivity of baroreceptors during respiratory cycle

Reflexes from receptors in the right atrium

Bainbridge, 1915

Reflex increase of HR during atria stretching

Applicable in explanted (denervated) heart

Local effects on SA node

Stretching of SA node causes faster spontaneous depolarisation

Effect of mechanosensitive chloride channels

Changes of SA node perfusion (a. centralis) and possible compression of SA node by expanding lungs

Effect of pH, p_aO_2 and p_aCO_2 oscillations

Oscillatory activity of peripheral chemoreceptors contributes to formation of RSA and increases its amplitude

ARRHYTHMIAS = disturbance of impulse generation or conduction

Description of ECG curve: **RAFO**

RHYTHM, **ACTION**, FREQUENCY, „osa“ AXIS:

Rhythm – sinus or ectopic rhythms: nodal (below 40 bpm), ventricular (below 20 bpm)

Action regular vs. irregular :

sinus respiratory arrhythmia (physiological)

sick sinus syndrom

extrasystoles (ES) single or coupled (bigeminia, trigeminia), according to site or origin - sinus, atrial, junction, ventricular

Regular

- 1) Normal HR range: 70 – 220 bpm; effect of age)
- 2) Sinus tachycardia (60 - 100 bpm; exercise; aging)
- 3) Sinus bradycardia (below 60 bpm; athletes' heart)

RHYTHM

SITE OF ORIGIN

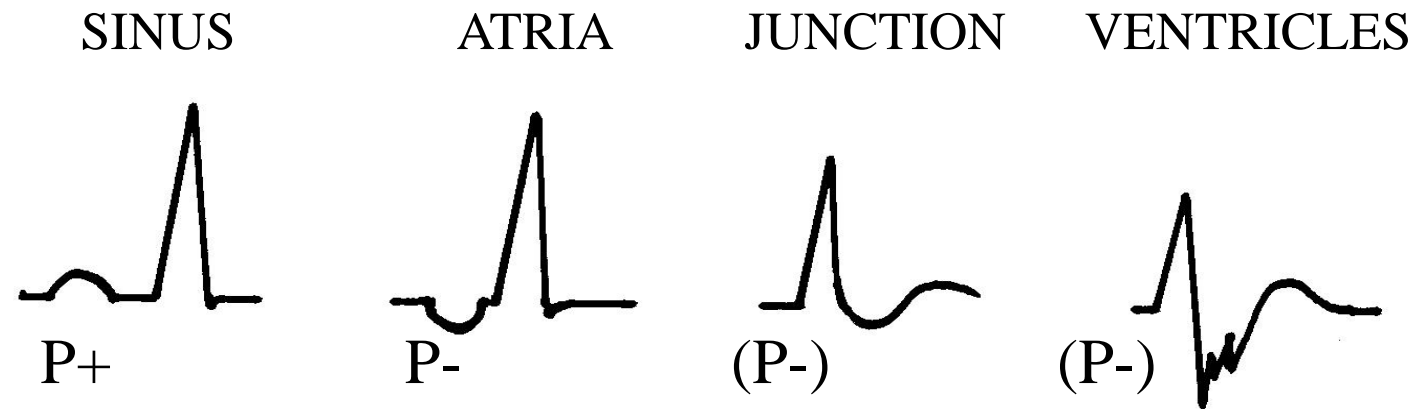

- P wave polarity
- PQ (QP) interval (physiological PQ interval : 0.12 – 0.2 s)

CONDUCTION DISTURBANCES (**BLOCKS**)

- Sick sinus syndrom
- AV blocks
- bundle branch block (BBB)
 - left, right

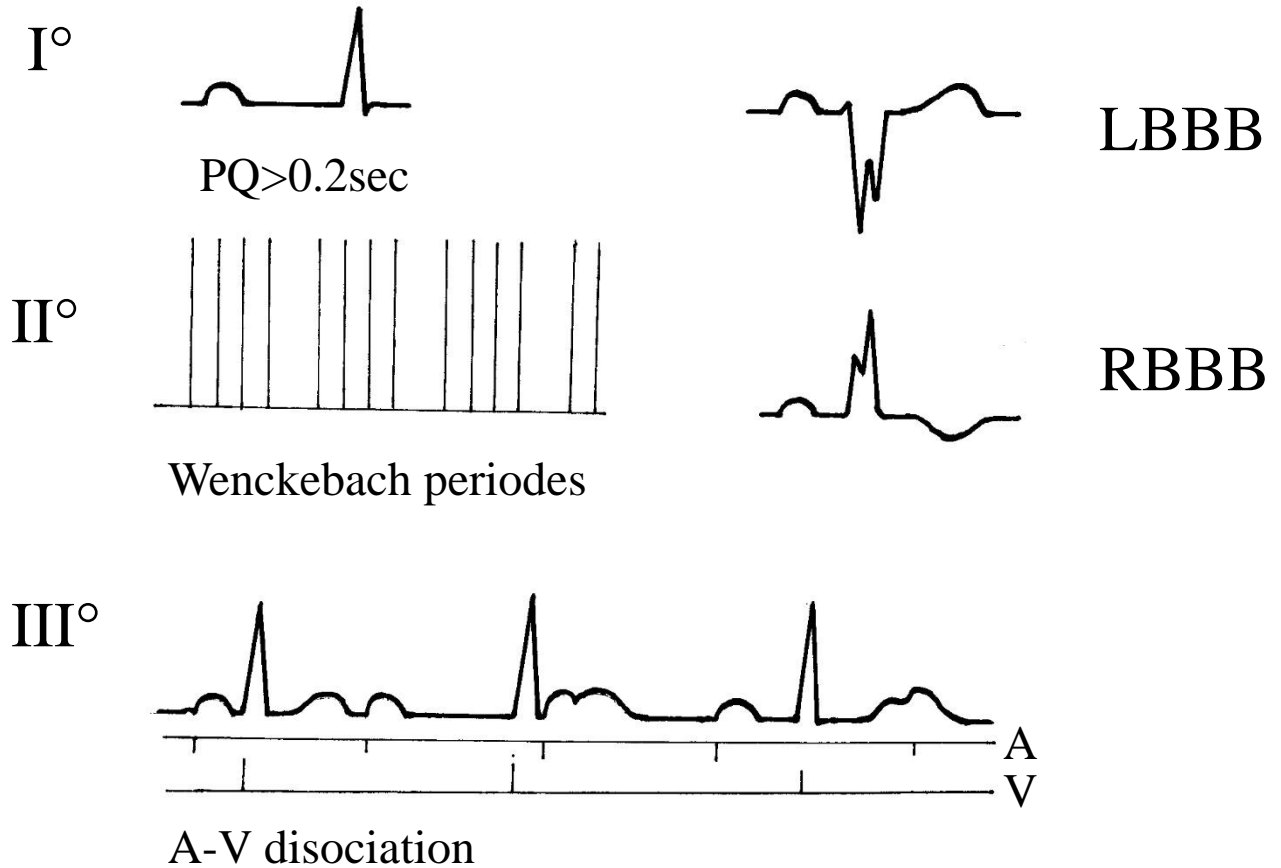

REENTRY

Common mechanism of (paroxysmal) tachycardias, extrasystoles, bigeminy, etc.

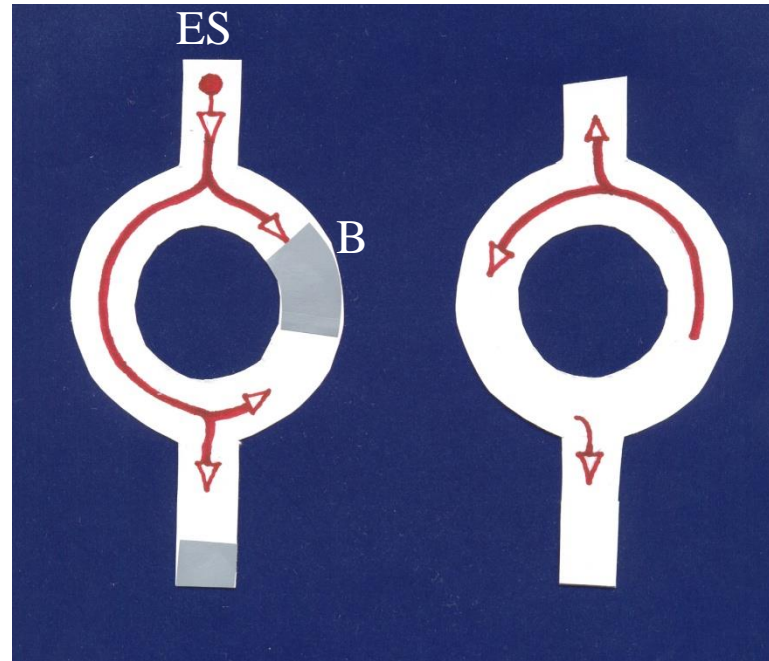

- **Double pathway**
Diverging and converging of excitation pathways
- **Unidirectional block**
 1. Long refractory period
 2. Slowed conduction
 3. **Reentry**

- **Loops most often at the level of AV junction**
- **Determinants of re-entry:**
 1. Proper dimension of the loop
 2. Proper timing of the trigger ES

TACHYARYTHMIAS

- **SINUS TACHYCARDIA**
- **PAROXYSMAL TACHYCARDIA** (supraventricular, ventricular)
- **FLUTTER** (>250/min; atrial)
- **FIBRILLATION** (>600/min; **atrial, ventricular**; breakdown of electrical homogeneity)

ATRIAL FLUTTER

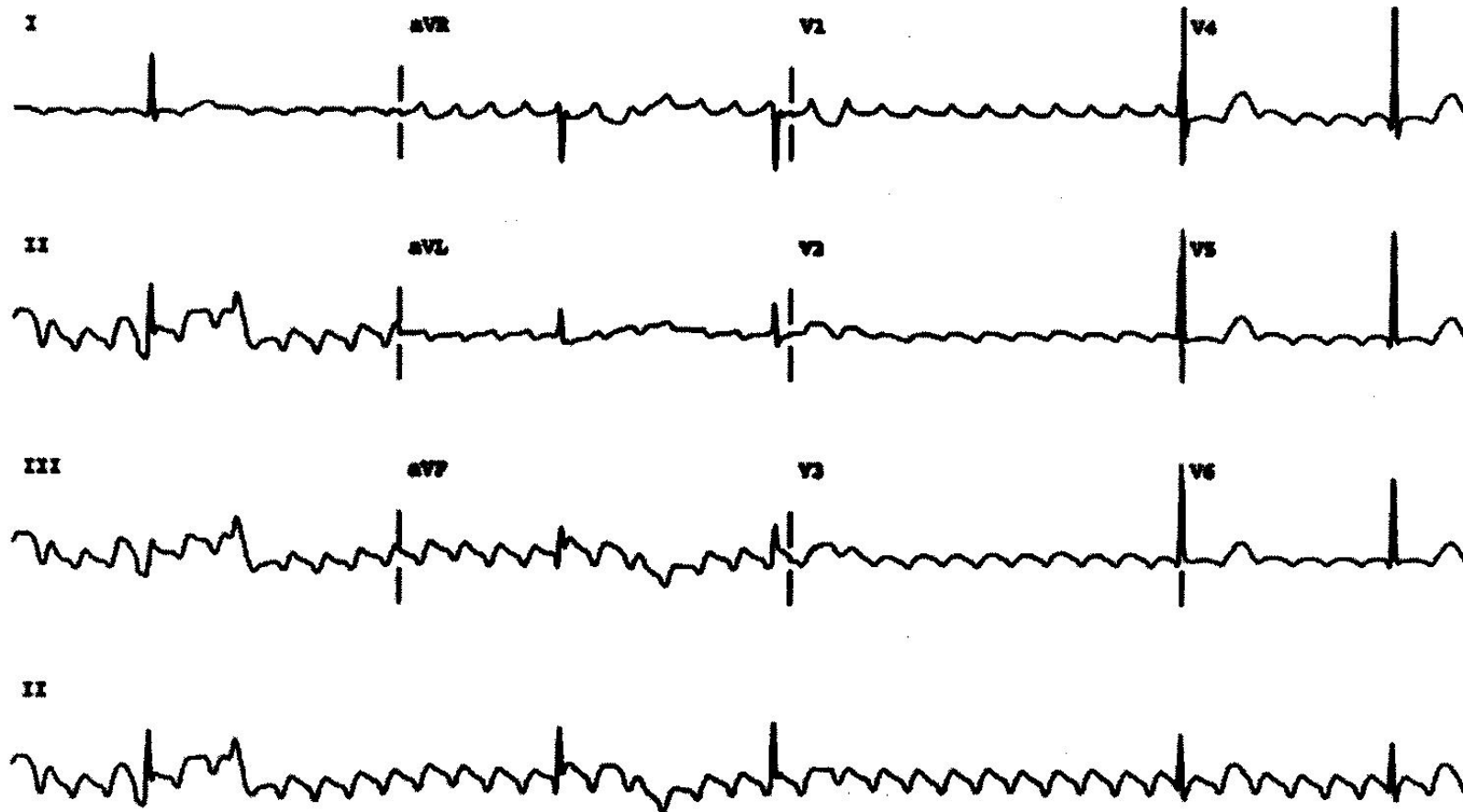

Frequency 250 – 600/min
Atrioventricular block n:1

ATRIAL FIBRILLATION

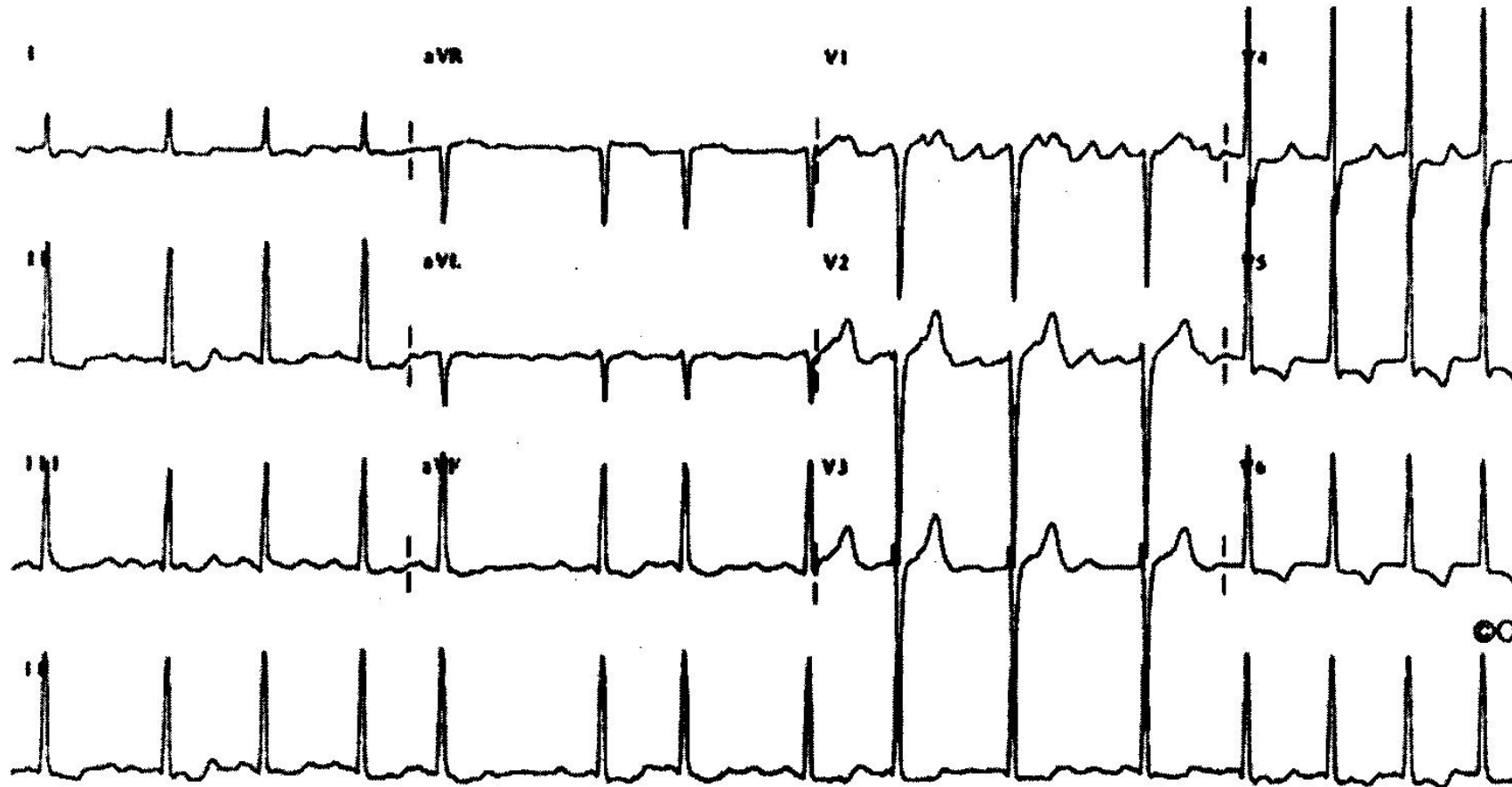

Irregular ventricular rhythm

+ f-waves

VENTRICULAR FIBRILLATION

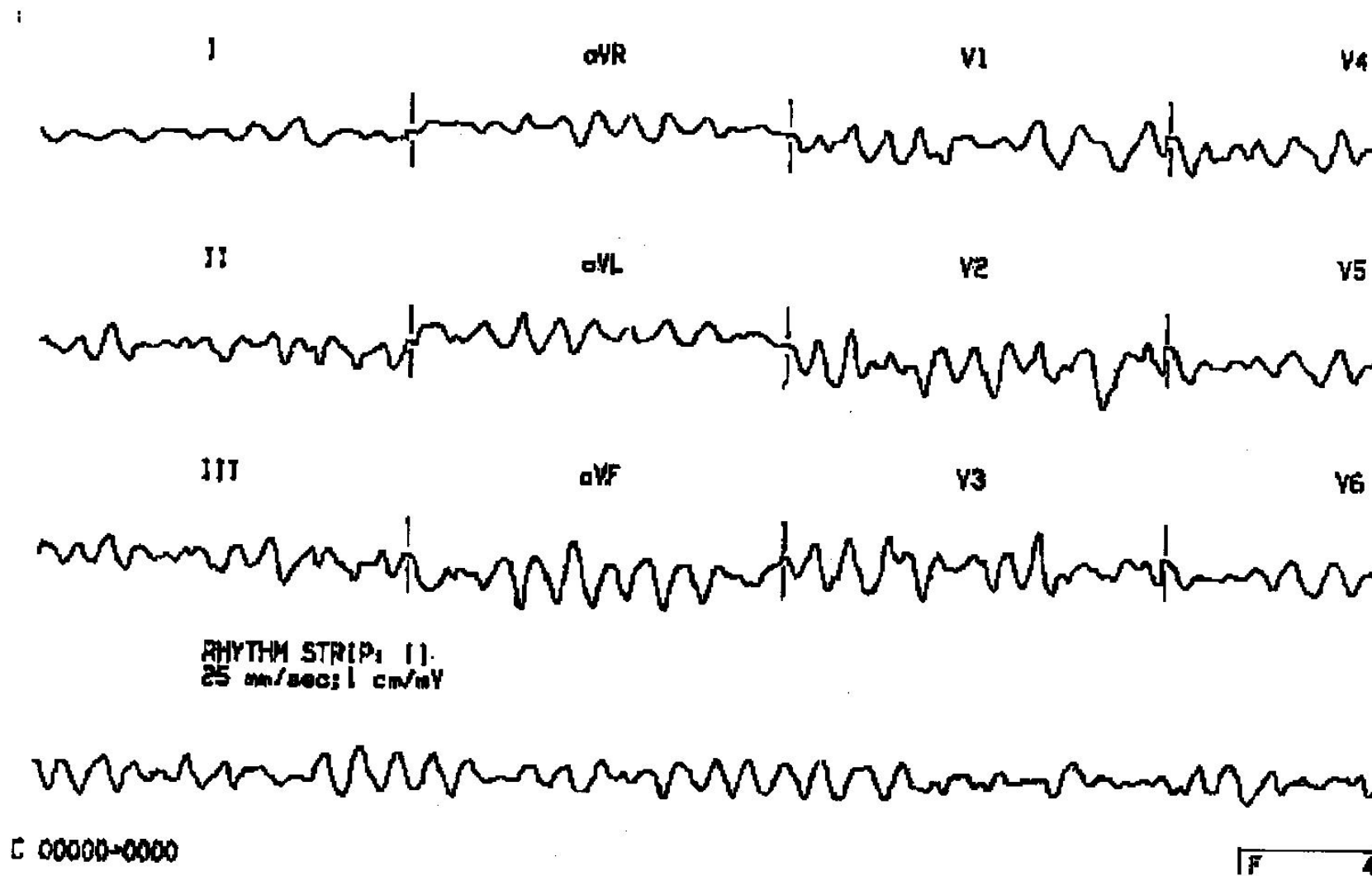

HEART ISCHEMIA

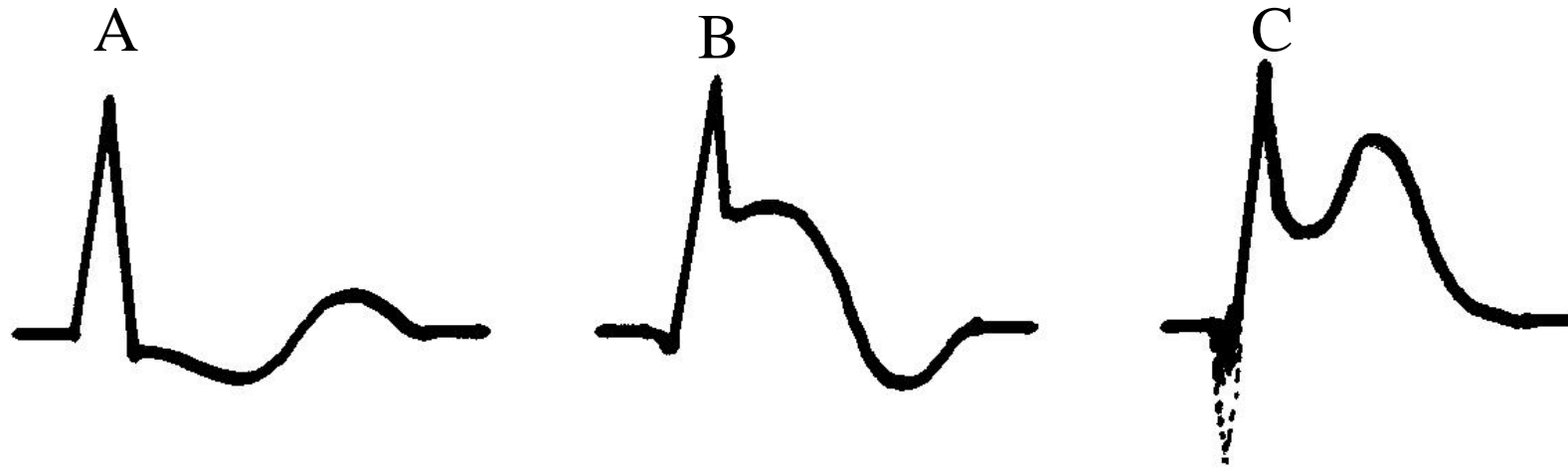

A: exercise angina pectoris

B: acute non-Q myocardial infarction

C: acute Q myocardial infarction

ANTIARRHYTHMICS

- **BLOCKERS OF Na CHANNEL** – prolong inactivation of I_{Na} , e.g. refracterity, „blocking“ fast ways
- **BLOCKERS OF Ca CHANNELS** – „blocking“ fast ways
- **BLOCKERS OF K CHANNEL** – prolonging refractory period
- **β -SYMPATOLYTICS** – slowing HR

Schémata a animace zpracovalo

Servisní středisko pro e-learning na MU

<http://is.muni.cz/stech/>

CZ.1.07/2.2.00/28.0041

Centrum interaktivních a multimediálních studijních opor pro inovaci výuky a efektivní učení



INVESTICE DO ROZVOJE VZDĚLÁVÁNÍ