

Counter-Current System Regulation of Renal Functions

Assoc. Prof. MUDr. Markéta Bébarová, Ph.D.

Department of Physiology

Faculty of Medicine, Masaryk University



Water Transport in Tubules

GFR 180 l/day

UFR ~1 l/day

UFR 0.5 l/day
(1400 mosm/l)

up to

UFR 23.3 l/day
(30 mosm/l)

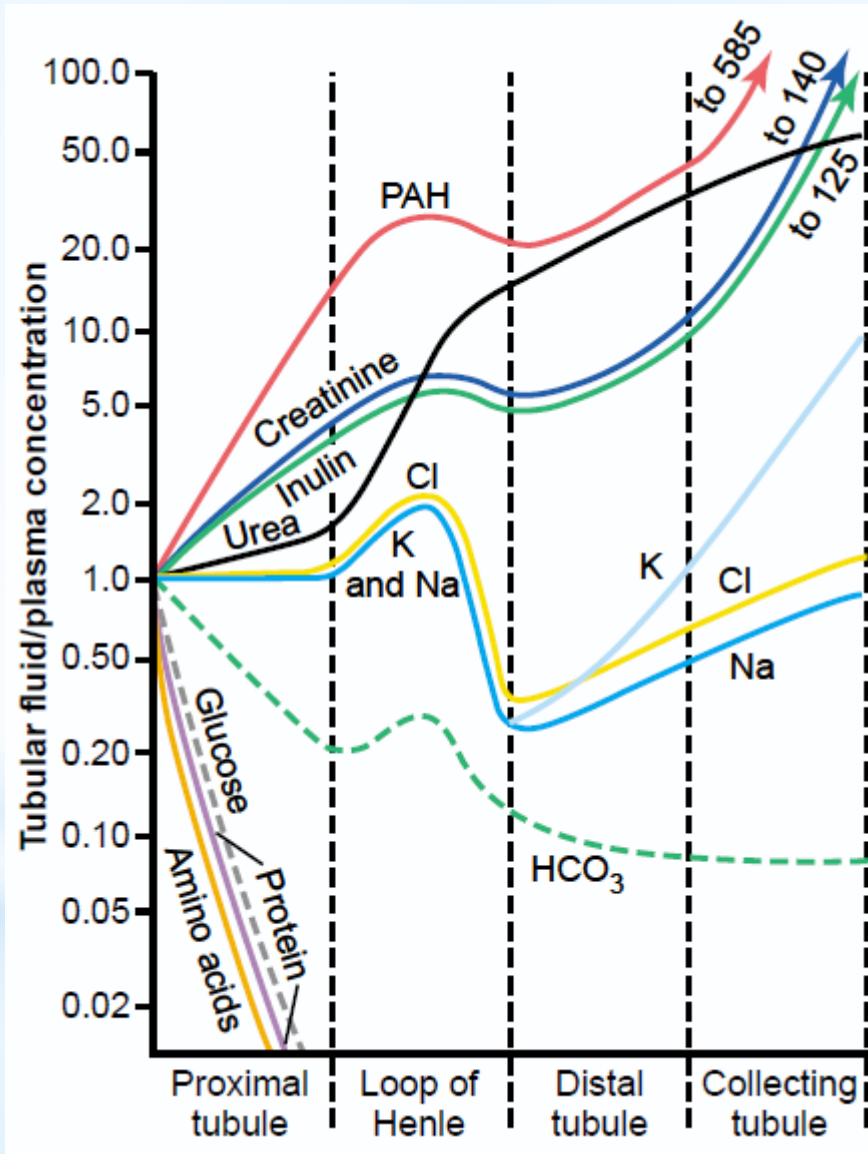

pronounced secretion in comparison with H₂O

pronounced reabsorption in comparison with H₂O

Guyton & Hall. Textbook of Medical Physiology

Water Transport in Tubules

Proximal Tubule

Intensive transport of solutes from the tubule to the interstitium forms an **osmotic gradient** which **drives the water reabsorption**.

The water reabsorption is facilitated by water channels in apical membranes of epithelial cells (protein **aquaporin 1**, not guided by ADH!).



From the proximal tubule, **isoosmotic fluid** outflows, its volume is notably decreased compared to the glomerular ultrafiltrate - **60-70% of solutes and water were reabsorbed**.

Water Transport in Tubules

Loop of Henle

- 1) **thin descending part** - passive reabsorption of water (osmosis)
- 2) **thick ascending part** – impermeable for water, intensive reabsorption of solutes



From the thick ascending loop of Henle, **hypotonic fluid** outflows, its volume is notably decreased.

Water Transport in Tubules

Distal Tubule

- 1) the first part – **analogical to the thick ascending loop of Henle** – impermeable for water, reabsorption of solutes (reabsorption of Na^+ varies, regulated by aldosteron)
- 2) the next part – **analogical to the cortical part of collecting duct** – water reabsorption regulated by ADH (aquaporin 2)



Tonicity of the outflowing fluid **depends on the actual level of ADH**, may be **even isotonic** (dependent on the tonicity of the neighbouring tissue, the renal cortex is isotonic).

Water Transport in Tubules

Collecting Duct

- 1) **the cortical part** – water reabsorption regulated by ADH (aquaporin 2), isotonic intersticium
- 1) **the medullar part** – water reabsorption regulated by ADH (aquaporin 2), hypertonic intersticium



Tonicity of the outflowing fluid **depends on the actual level of ADH**, may be **even hypertonic** (dependent on the tonicity of the neighbouring tissue, the renal medulla is hypertonic); in the absence of ADH, notably hypotonic.

Counter-Current System in Kidneys

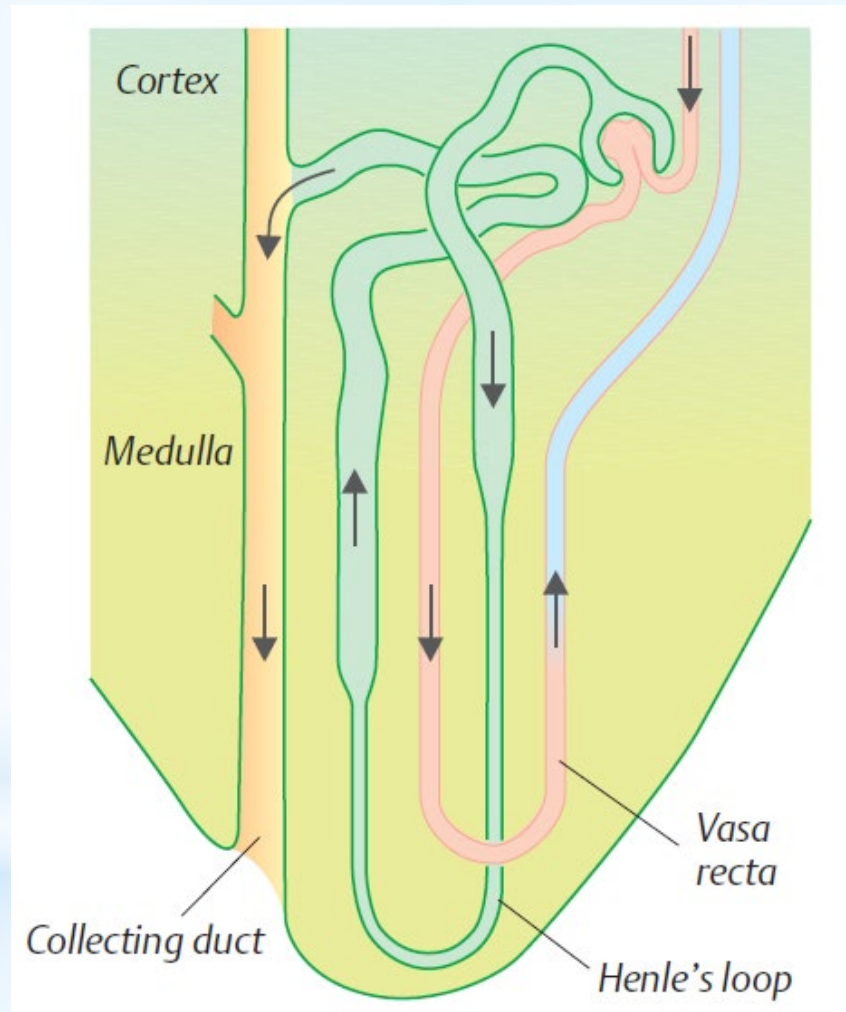

Despopoulos, Color Atlas of Physiology © 2003

Counter-Current System in Kidneys

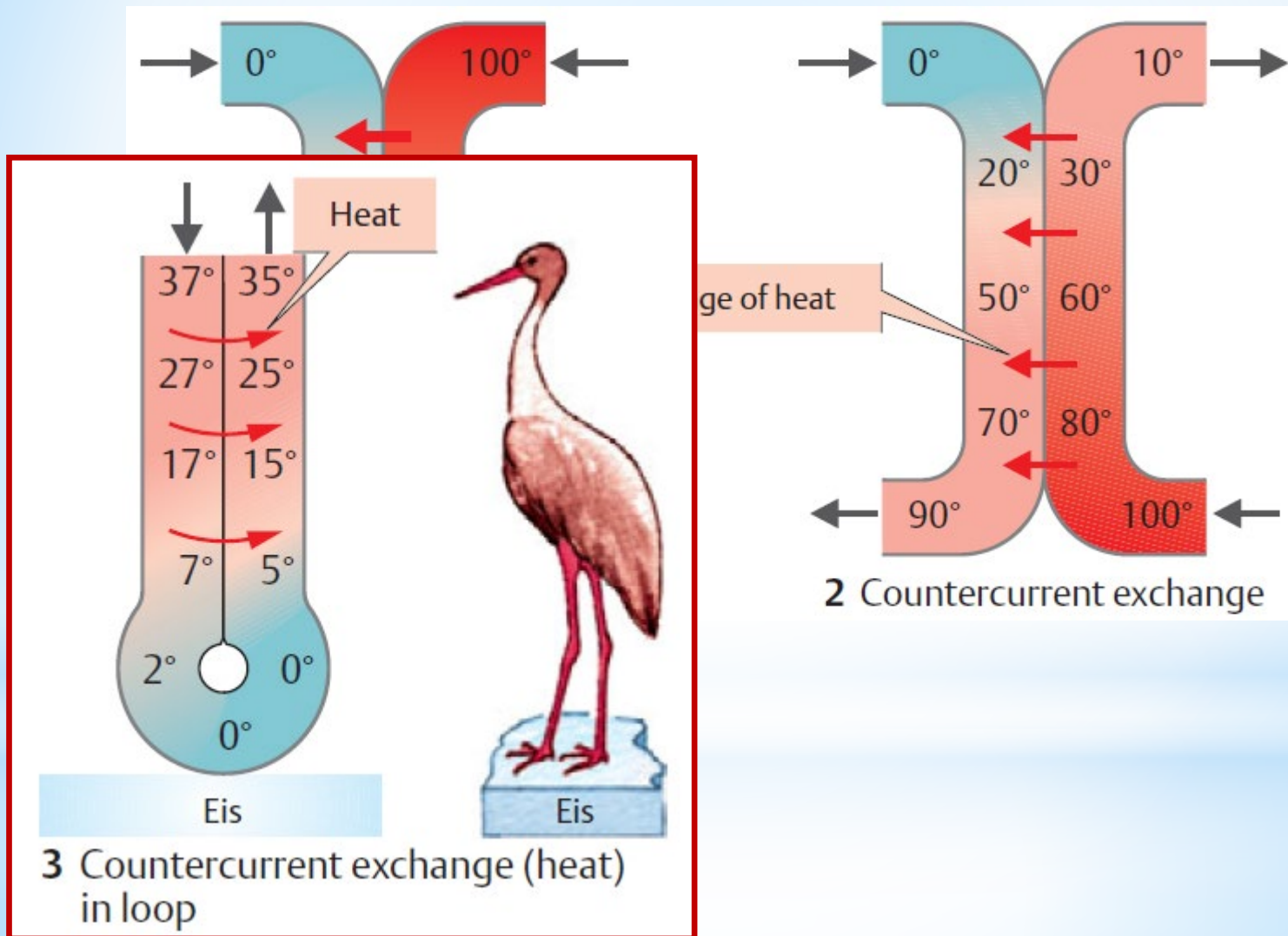

Counter-Current System in Kidneys

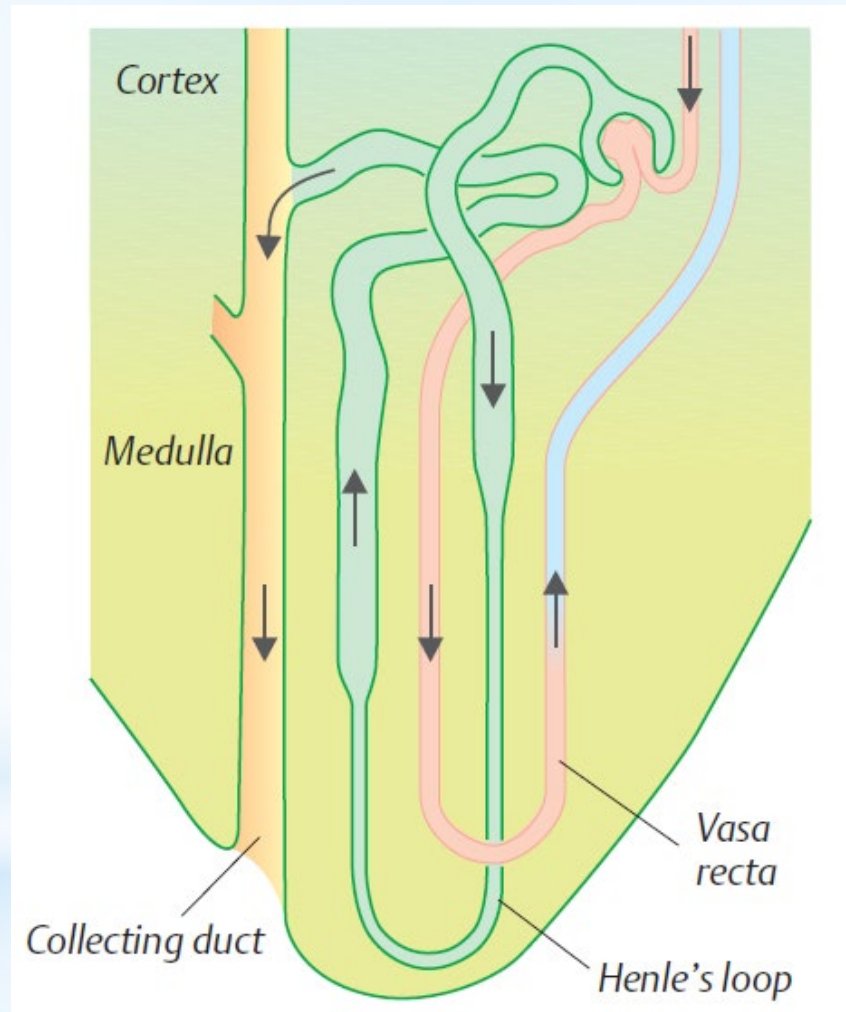

Despopoulos, Color Atlas of Physiology © 2003

Counter-Current System in Kidneys

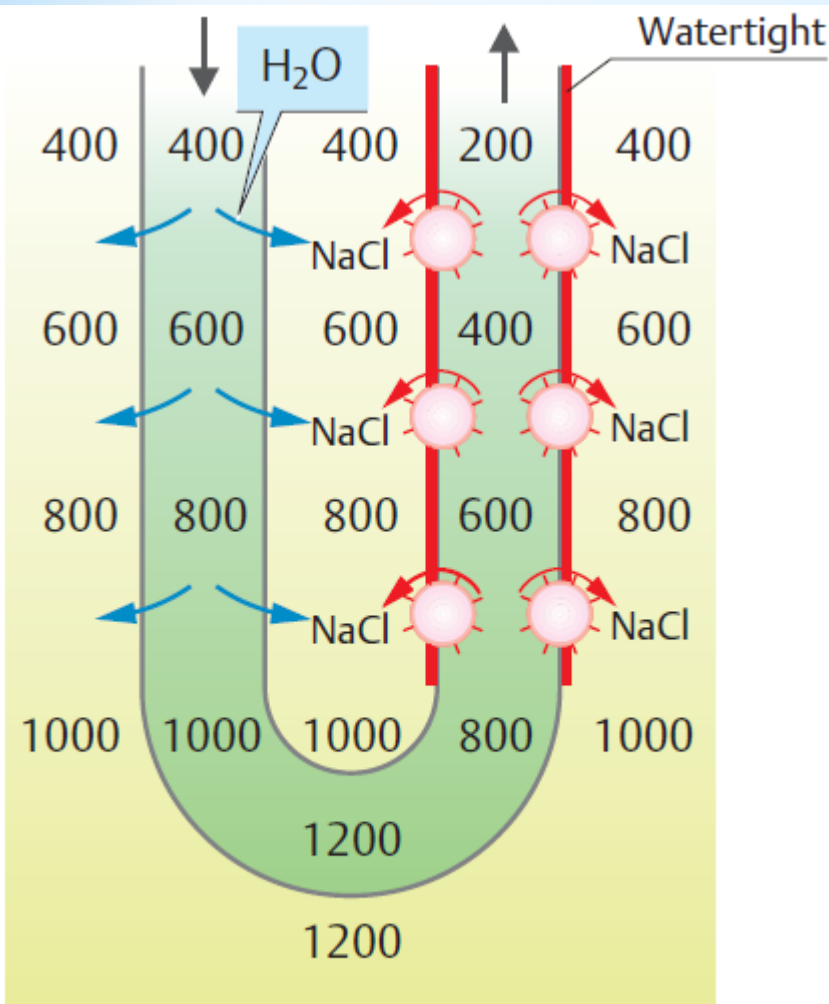

5 Countercurrent multiplier (Henle's loop)

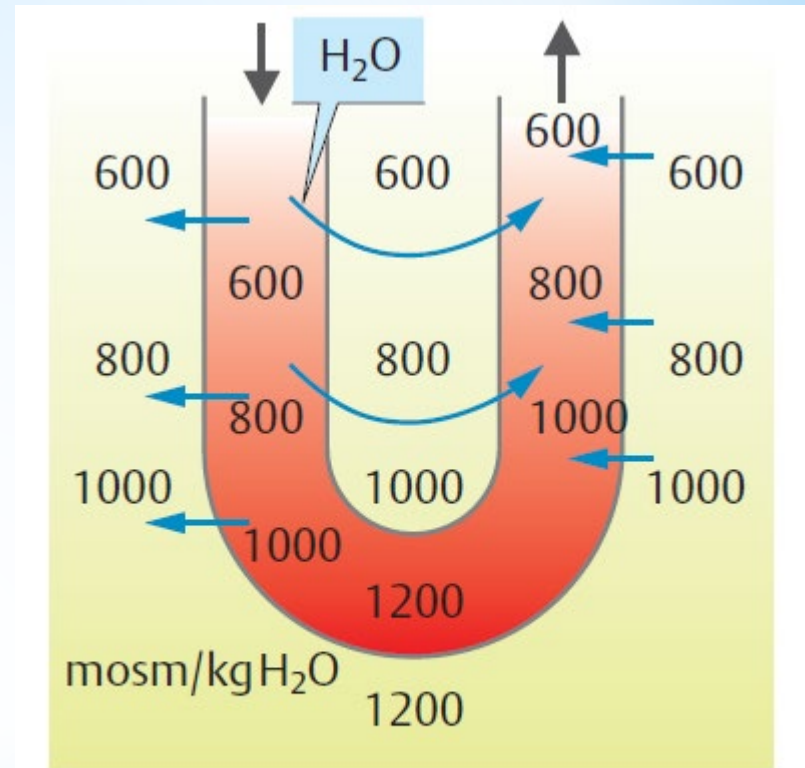

4 Countercurrent exchange (water) in loop (e.g. vasa recta)

Counter-Current System in Kidneys

Hyperosmotic Renal Medulla - Role of Loop of Henle

- 1) Active transport of Na^+ , co-transport of Na^+ with K^+ and Cl^- from ascending loop of Henle; **gradient even 200 mOsm/l**
- 2) Impermeability of ascending loop of Henle for water

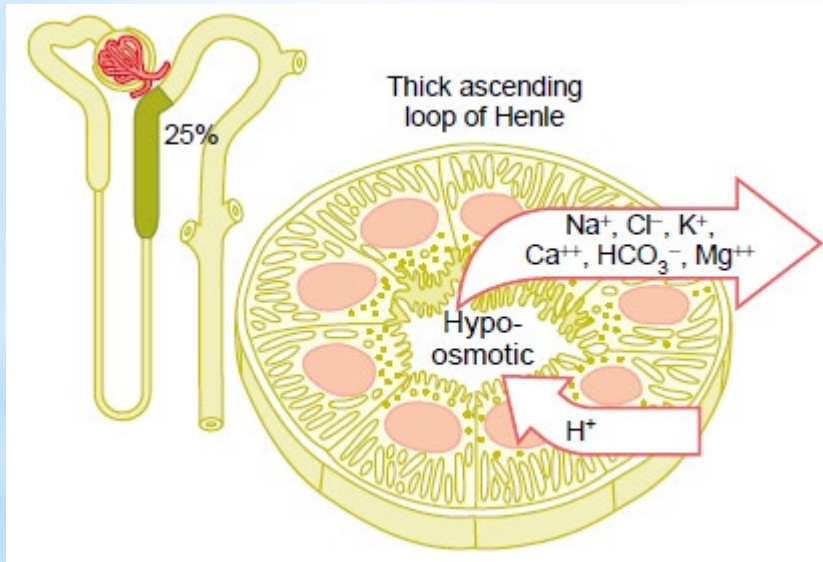

Guyton & Hall. *Textbook of Medical Physiology*

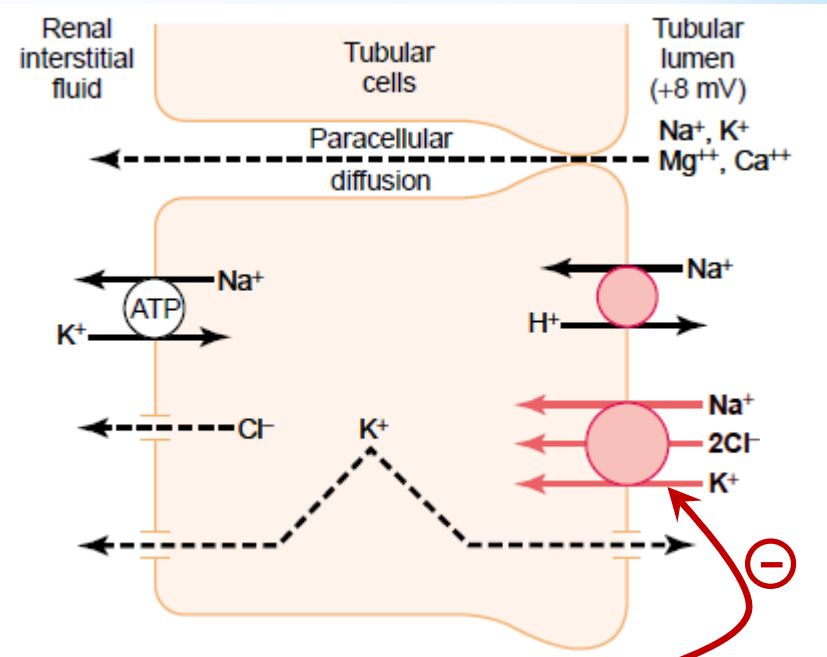

diuretics (e.g. furosemid)

Counter-Current System in Kidneys

Hyperosmotic Renal Medulla - Role of Loop of Henle

- 1) Active transport of Na^+ , co-transport of Na^+ with K^+ and Cl^- from ascending loop of Henle; **gradient even 200 mOsm/l**
- 2) Impermeability of ascending loop of Henle for water
- 3) Permeability of descending loop of Henle for water

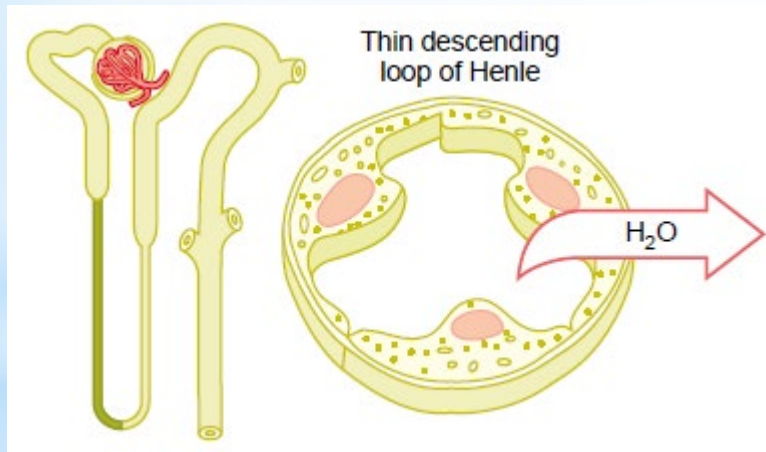

Guyton & Hall. Textbook of Medical Physiology

Counter-Current System in Kidneys

Hyperosmotic Renal Medulla - Role of Loop of Henle

- 1) Active transport of Na^+ , co-transport of Na^+ with K^+ and Cl^- from ascending loop of Henle; **gradient even 200 mOsm/l**
- 2) Impermeability of ascending loop of Henle for water
- 3) Permeability of descending loop of Henle for water

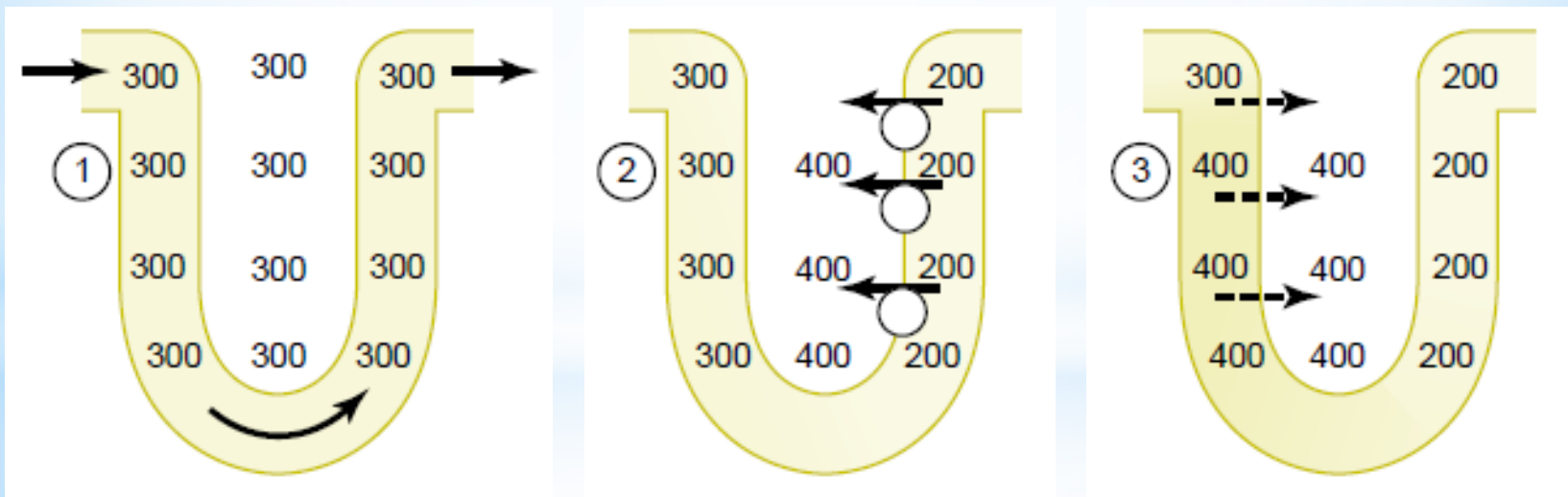

Guyton & Hall. Textbook of Medical Physiology

Counter-Current System in Kidneys

Hyperosmotic Renal Medulla - Role of Loop of Henle

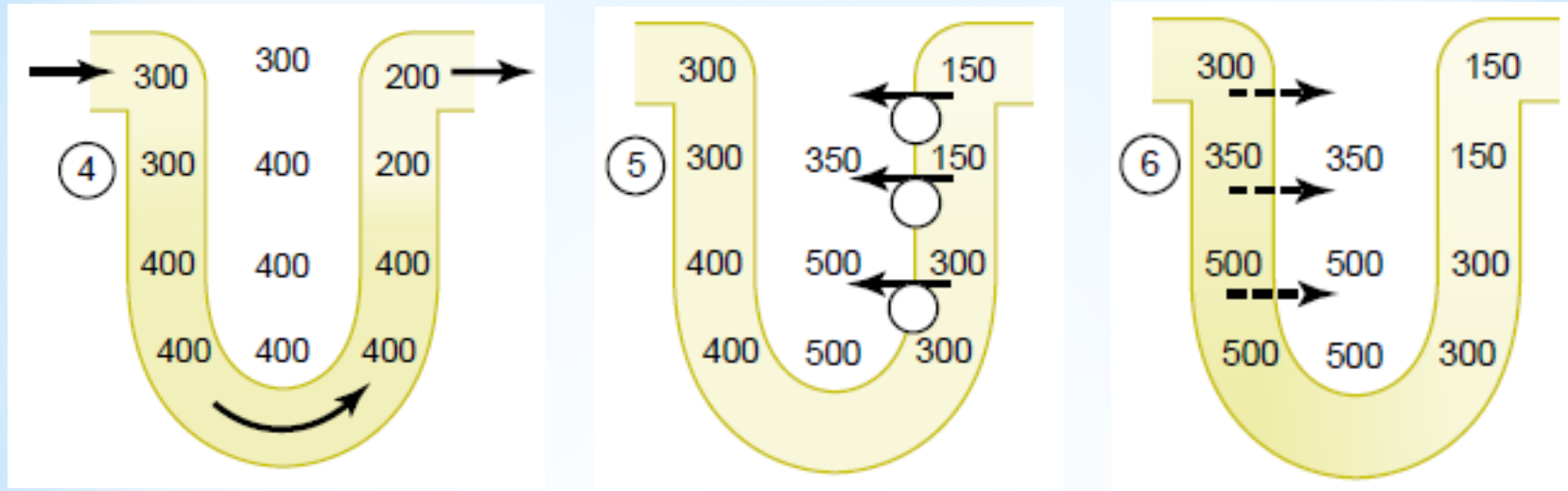

Guyton & Hall. *Textbook of Medical Physiology*

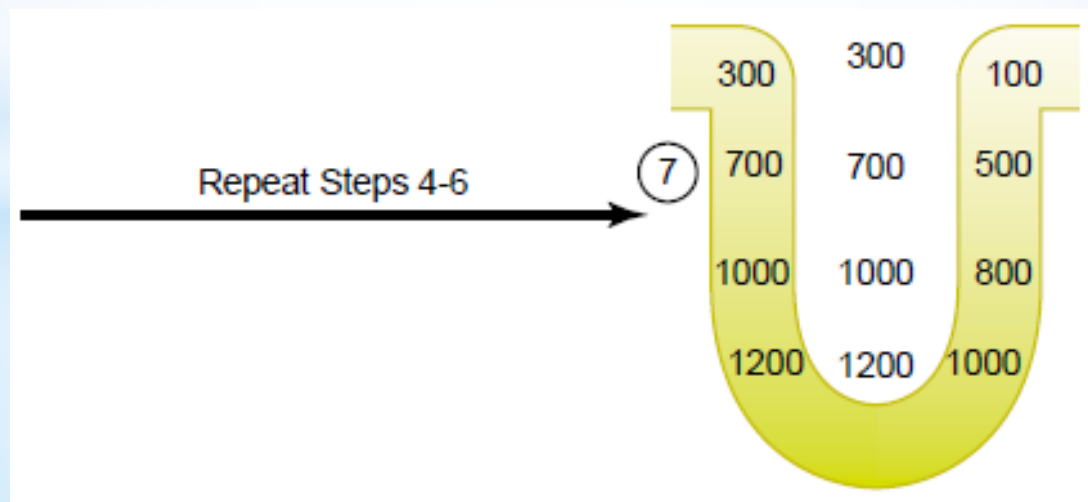

Counter-Current System in Kidneys

Hyperosmotic Renal Medulla - Role of Vasa Recta

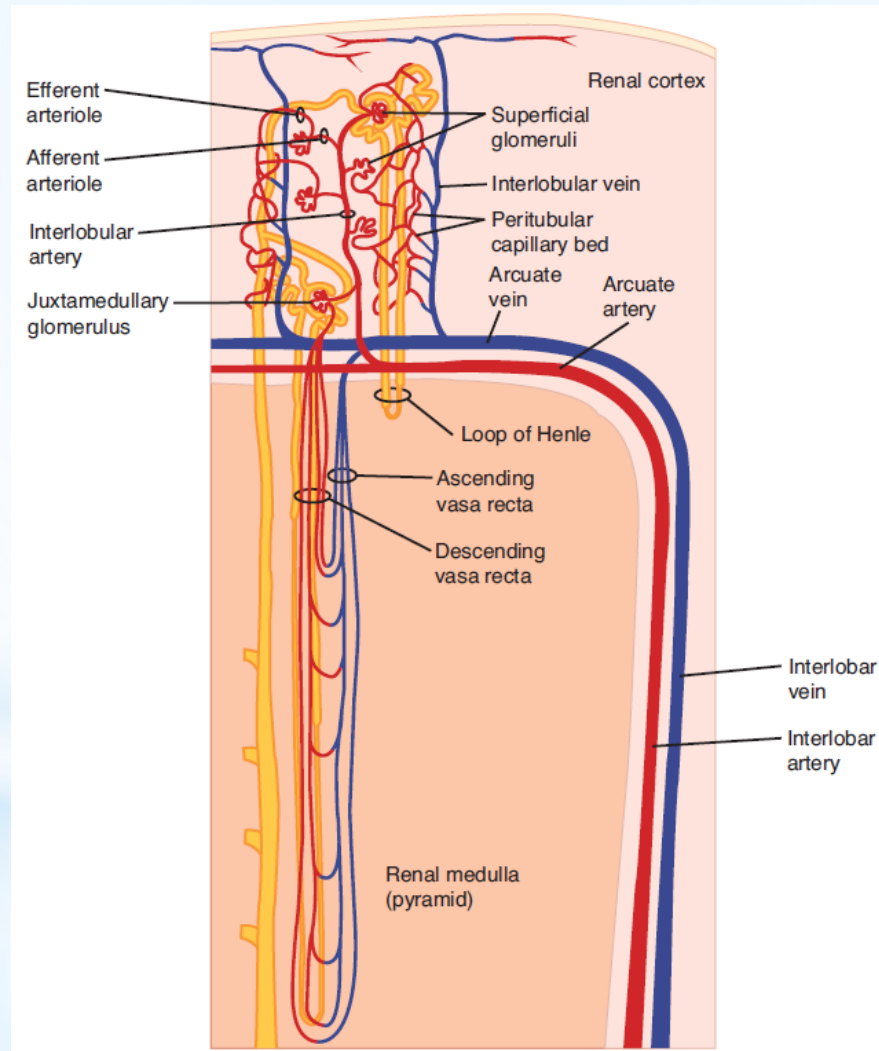

Ganong's Review of Medical Physiology, 23rd edition

Counter-Current System in Kidneys

Hyperosmotic Renal Medulla - Role of Vasa Recta

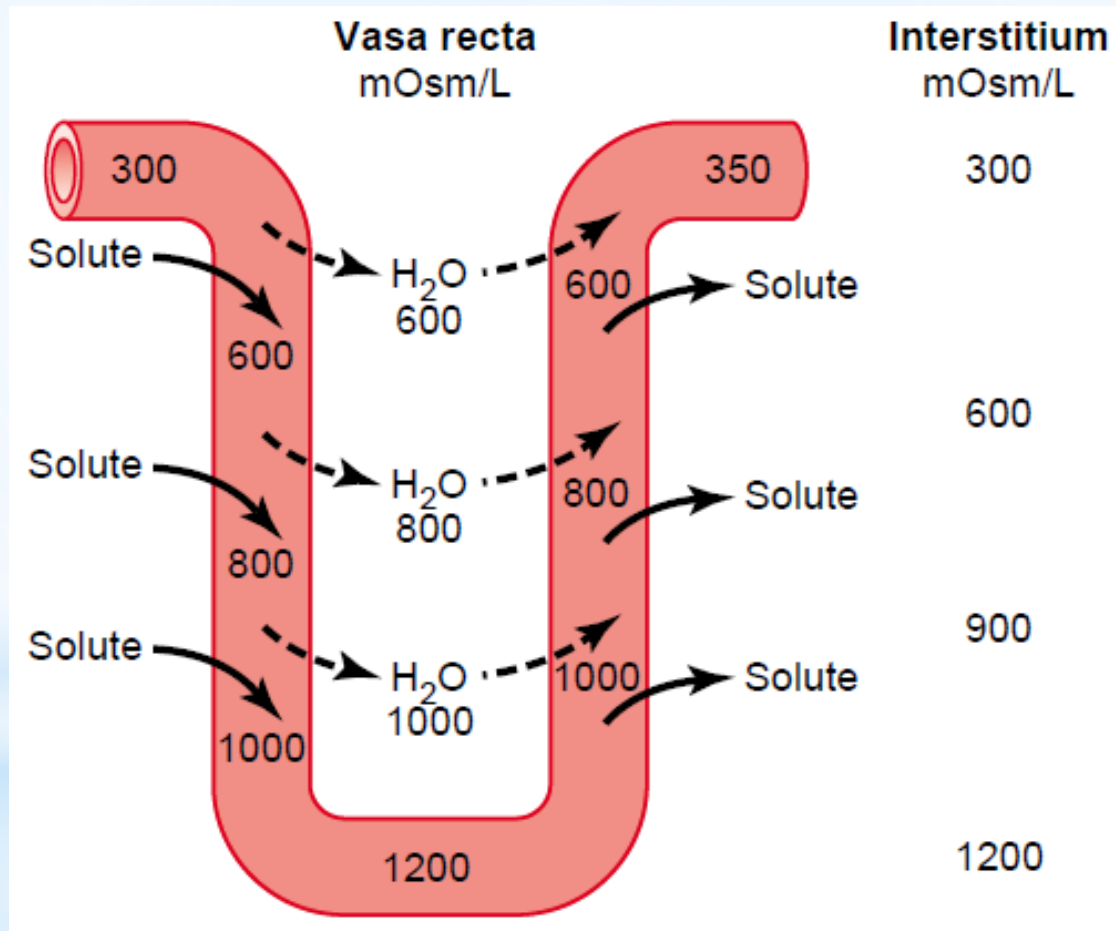

Guyton & Hall. Textbook of Medical Physiology

Counter-Current System in Kidneys

Hyperosmotic Renal Medulla - Role of Urea

passive transport

following parts of tubulus resistant to urea reabsorption

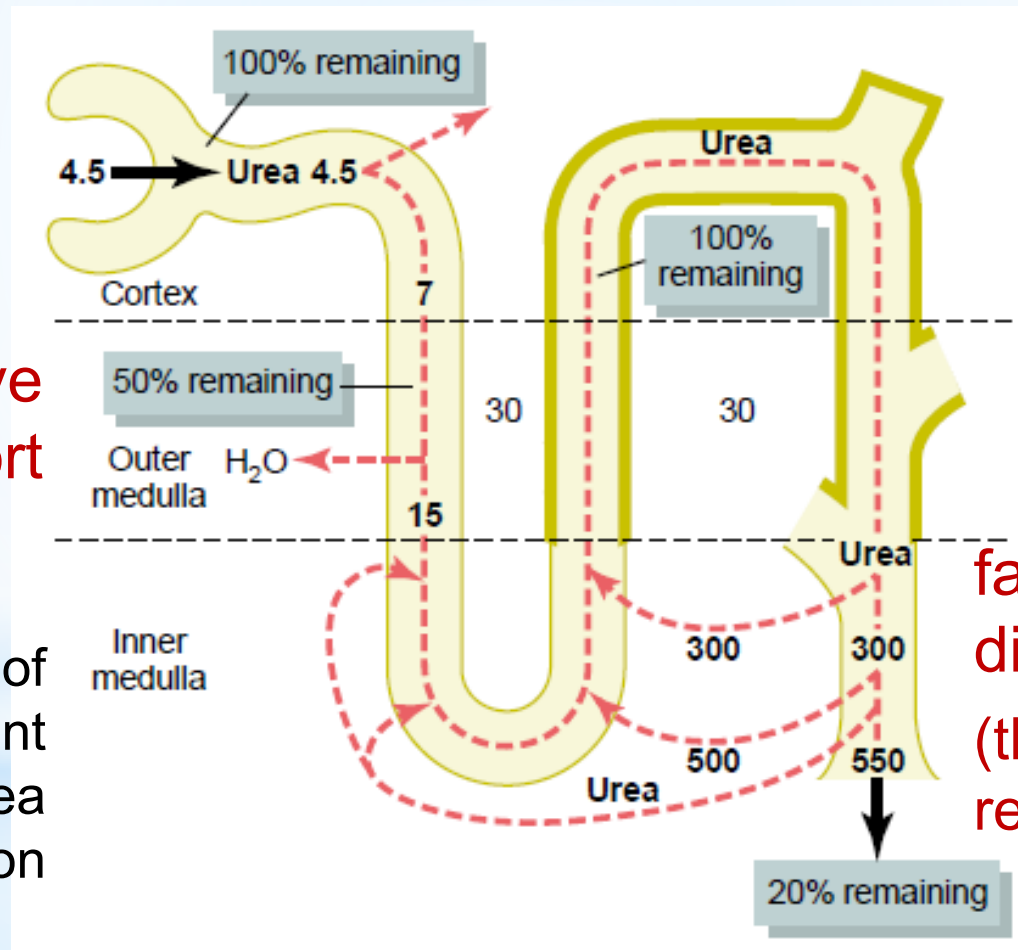

facilitated diffusion
(through UT-A1 - regulated by ADH)

Counter-Current System in Kidneys

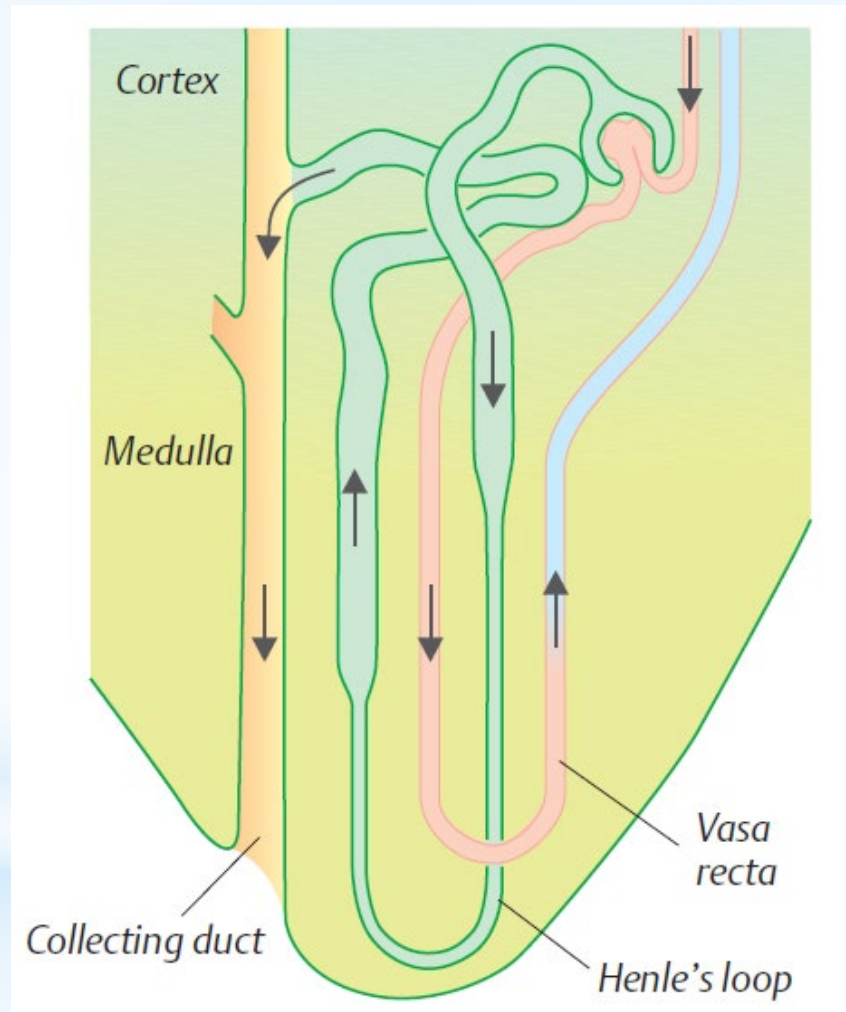

Despopoulos, Color Atlas of Physiology © 2003

Water Diuresis

- following drinking of a higher amount of hypotonic fluid
- starts ~15 min after drinking, maximum reached within ~40 min
- drinking itself → slightly ↓ ADH secretion
- water reabsorption in the intestine → ↓ plasma osmolarity – osmoreceptors in the hypothalamus → notable ↓ ADH secretion → ↓ water reabsorption in tubulus → ↑ diuresis

Water Diuresis

- following drinking of a higher amount of hypotonic fluid

Water Intoxication

- the water intake per time $>$ the amount of water which can be excreted (maximal diuresis ~ 16 ml/min)
- hypotonic fluid from plasma to cells \rightarrow **cellular edema, symptoms of water intoxication** (convulsions, coma even death due to the brain edema)
- **iatrogenic** – not restricted water intake after application of exogenous ADH or during its higher secretion induced by non-osmotic stimuli (e.g. surgery)

Osmotic Diuresis

- induced by presence of non-absorbed osmotically active solutes in renal tubules
- non-absorbed solutes (e.g. glucose - *diabetes mellitus*) in the proximal tubules → osmotic effect – water retained in the tubulus



- ↓ transepithelial gradient for Na^+ (Na^+ in the tubule in a higher amount of water) → inhibition of Na^+ reabsorption in the proximal tubule → Na^+ retained in the tubule ~ further osmotic load → further retaining of water in the tubule

Osmotic Diuresis

- induced by presence of non-absorbed osmotically active solutes in renal tubules
- more isotonic fluid with higher total amount of Na^+ into the loop of Henle \rightarrow \downarrow reabsorption of solutes in the ascendent loop of Henle after reaching the borderline concentration gradient for Na^+ reabsorption \rightarrow \downarrow hypertonicity of the renal medulla
- more fluid flows through other parts of tubulus + \downarrow hypertonicity of the renal medulla \rightarrow \downarrow water reabsorption in the collecting duct \rightarrow \uparrow diuresis, urine with an increased amount of solutes

Regulation of Renal Functions

Regulation of Renal Blood Flow

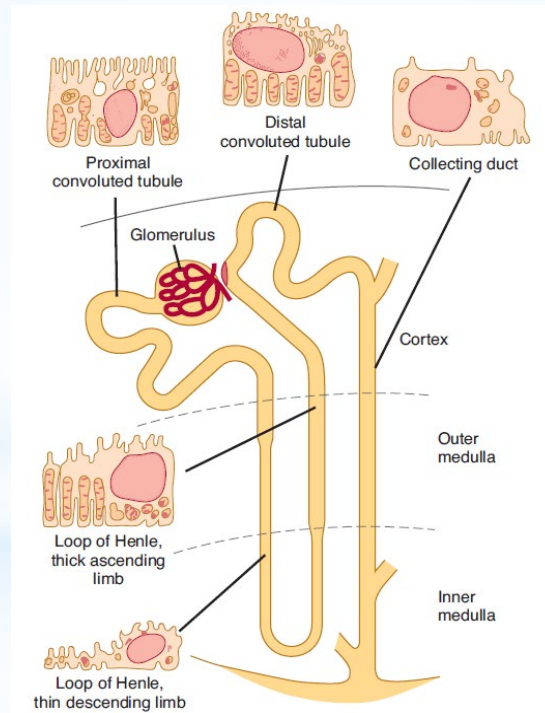

Ganong's Review of Medical Physiology, 23rd edition

Regulation of Renal Blood Flow

- 1) Myogenic Autoregulation
- 2) Neural Regulation
- 3) Humoral Regulation

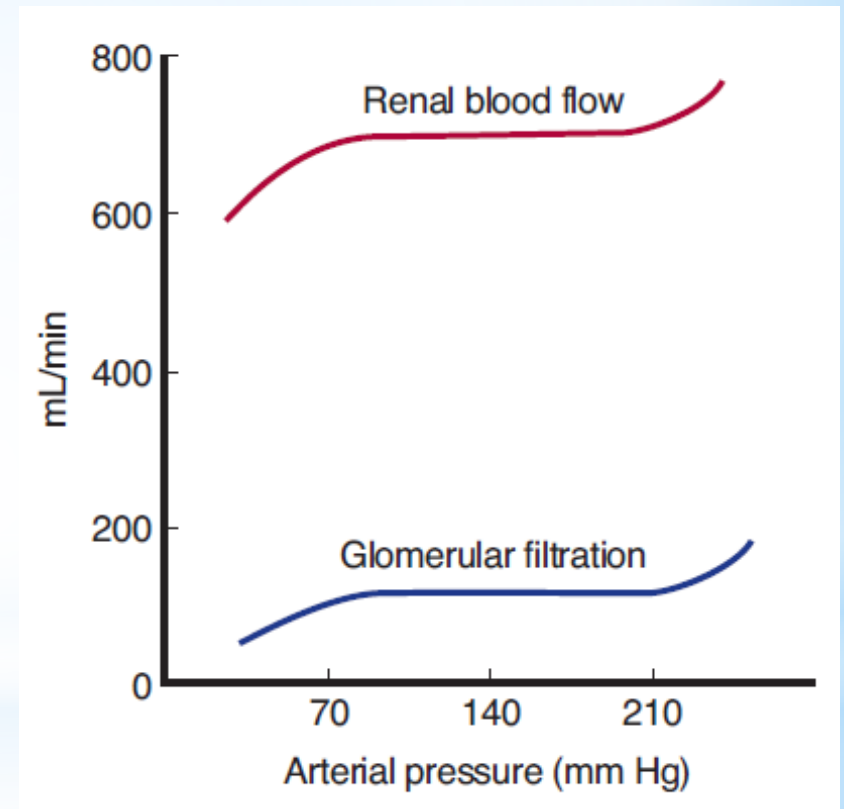

*Ganong's Review of Medical
Physiology, 23rd edition*

Regulation of Renal Blood Flow

1) Myogenic Autoregulation

- dominates
- provides stable renal activity by **maintaining stable blood flow at varying systemic pressure** (stable glomerular pressure and, thus, also stable glomerular filtration rate)

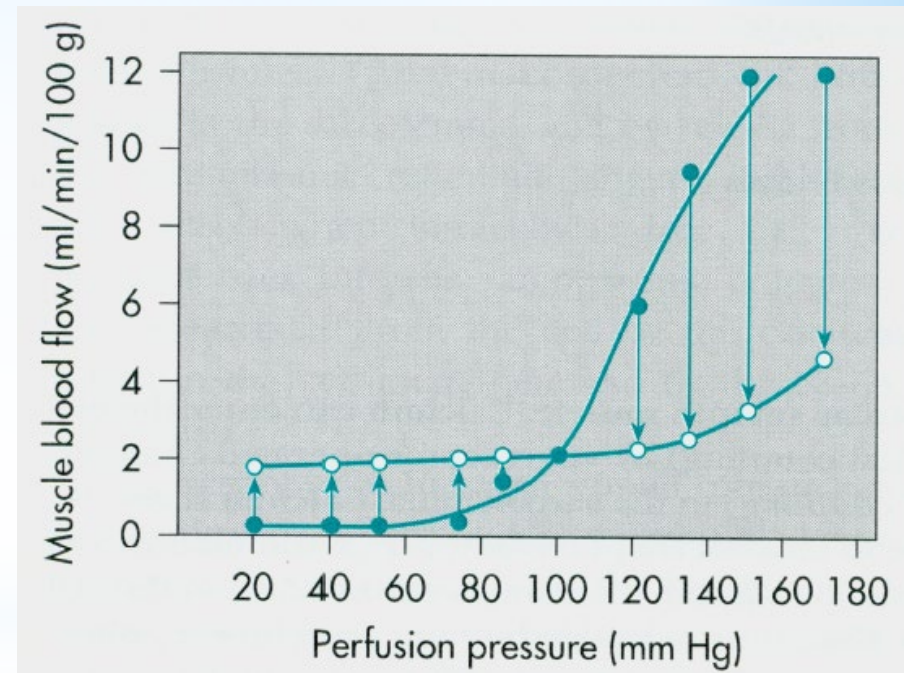

Regulation of Renal Blood Flow

2) Neural Regulation

- conformed to demands of systemic circulation
- **renal blood flow** forms 25% of the cardiac output, thus, it considerably **influence BP**
- **sympathetic system - norepinephrine**

light exertion (both emotional and physical) + upright body posture → ↑ sympathetic tone → ↑ tone of *v. aff.* and *eff.* → ↓ renal blood flow but without ↓ GFR (↑ FF)

higher ↑ of sympathetic tone - **during anesthesia and pain** - GFR may already ↓

in healthy people – minor impact

Regulation of Renal Blood Flow

3) Humoral Regulation

- contribute to regulation of systemic BP and regulation of body fluids
- **norepinephrine, epinephrine** (from adrenal medulla)
→ constriction of aff. and eff. arterioles → ↓ renal blood flow and GFR
in agreement with ↑ activity of sympathetic system
(small impact with the exception of serious conditions, for example serious bleeding)

Regulation of Renal Blood Flow

3) Humoral Regulation

- contribute to regulation of systemic BP and regulation of body fluids
- **norepinephrine, epinephrine** (from adrenal medulla)
→ constriction of aff. and eff. arterioles → ↓ renal blood flow and GFR
- **endothelin**
constriction of aff. and eff. arterioles → ↓ renal blood flow and GFR
released locally from the impaired endothel
(physiological impact - hemostasis; pathologically increased levels at the toxemia of pregnancy, acute renal failure, chronic uremia)

Regulation of Renal Blood Flow

3) Humoral Regulation

- contribute to regulation of systemic BP and regulation of body fluids
- **NO** (from the endothel)
continual basal production → vasodilation in the kidney
→ stable renal blood flow and GFR
- **prostaglandins (PGE₂, PGI₂), bradykinin**
→ vasodilation
minor impact under physiological conditions
decrease the effect of vasoconstrictive substances which reduce marked ↓ of renal blood flow and GFR
non-steroidal anti-inflammatory agents during stress (surgery, ↓ fluid volume) may → notably ↓ GFR

Regulation of Renal Blood Flow

3) Humoral Regulation

- contribute to regulation of systemic BP and regulation of body fluids
- **Renin-Angiotensine System**

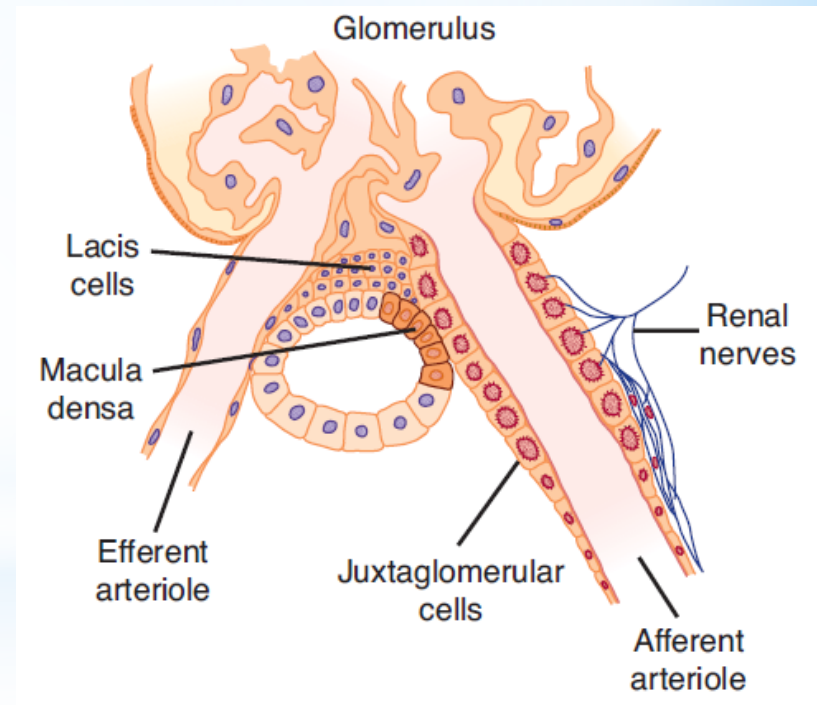

Ganong's Review of Medical Physiology, 23rd edition

Regulation of Renal Blood Flow

Renin-Angiotensin System

- ↓ Na⁺ in plasma
- ↓ blood pressure
- ↑ activity of sympathetic (β rec.)

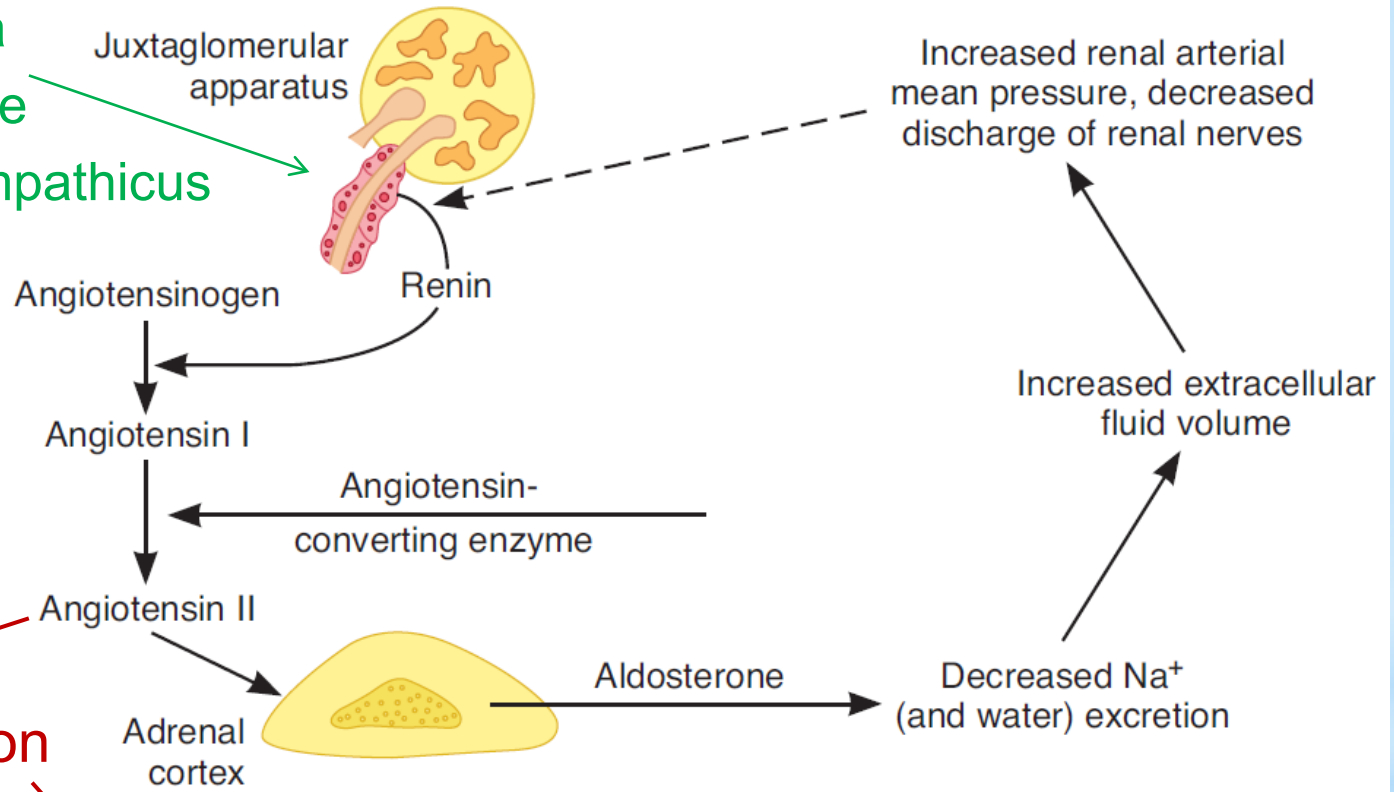

vasoconstriction
(more in eff. a.)

thirst, ADH

↓ renal blood flow but ↑ GFR

(usually during ↓ BP or fluid depletion – prevention of ↓ GFR + ↑ tubular reabsorption of Na⁺ and water due to ↓ P_c in peritubular capillaries)

Regulation of Renal Blood Flow

3) Humoral Regulation

Tubuloglomerular Feedback

- provides constant NaCl load in the distal tubule, prevents excessive changes of renal excretion

Regulation of Renal Blood Flow

3) Humoral Regulation

Tubuloglomerular Feedback

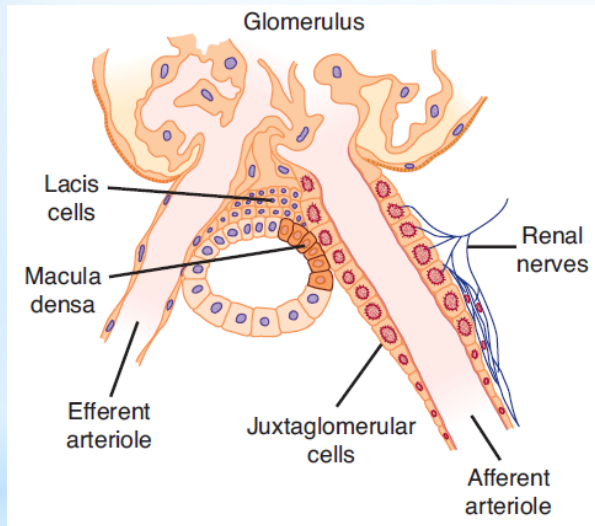

Ganong's Review of Medical Physiology, 23rd edition

*Guyton & Hall.
Textbook of
Medical Physiology*

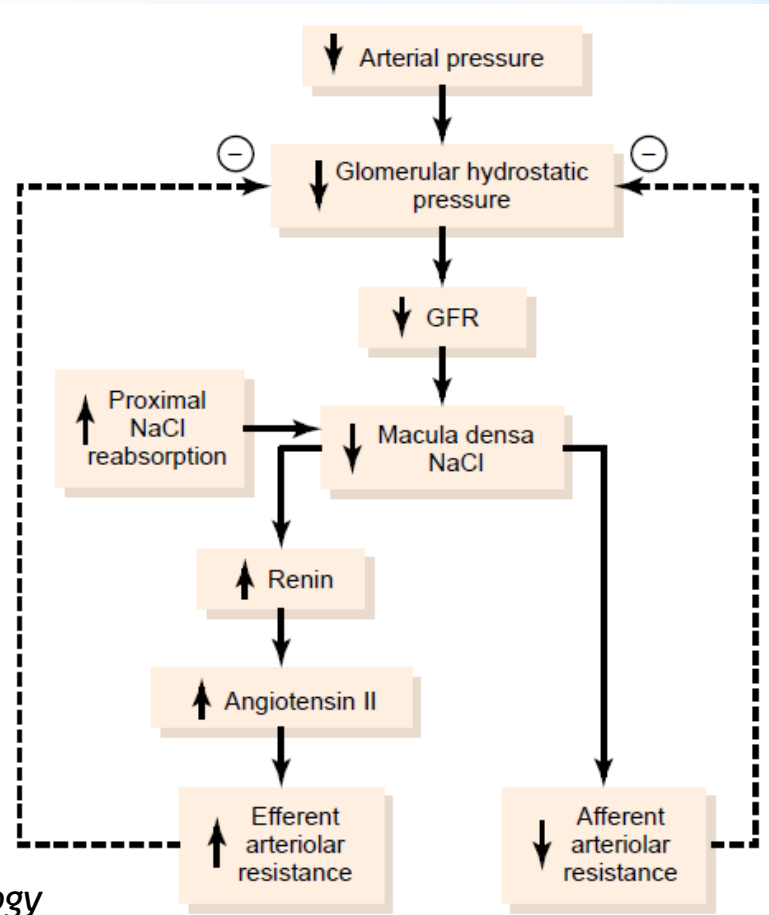

Regulation of Renal Functions

Regulation of Glomerular Filtration

Regulation of Tubular Reabsorption

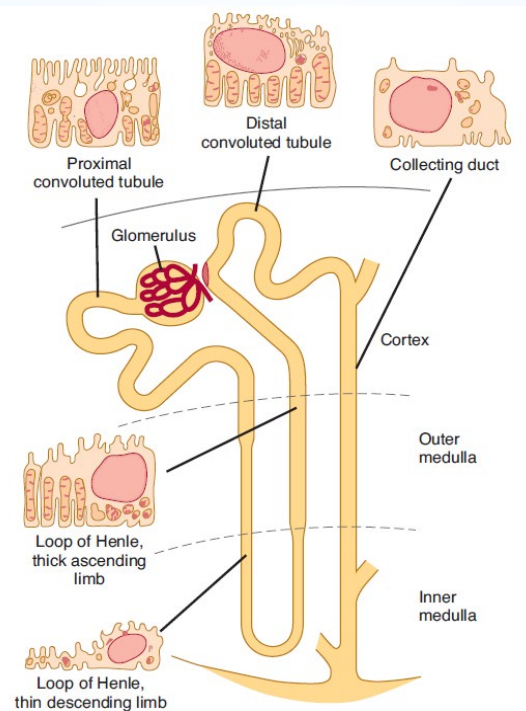

Ganong's Review of Medical Physiology, 23rd edition

Regulation of Glomerular Filtration

$$\text{GFR} = K_f \cdot \text{net filtration pressure}$$

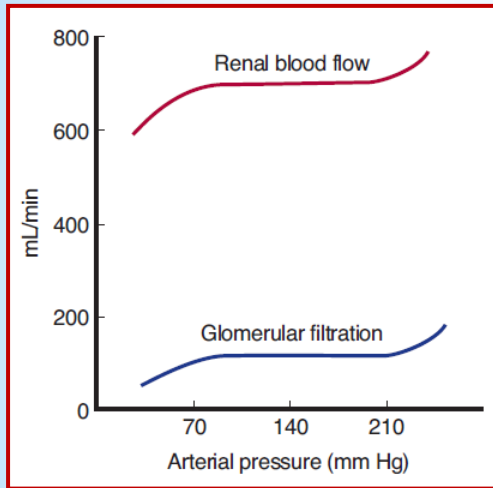

Ganong's Review of Medical Physiology, 23rd edition

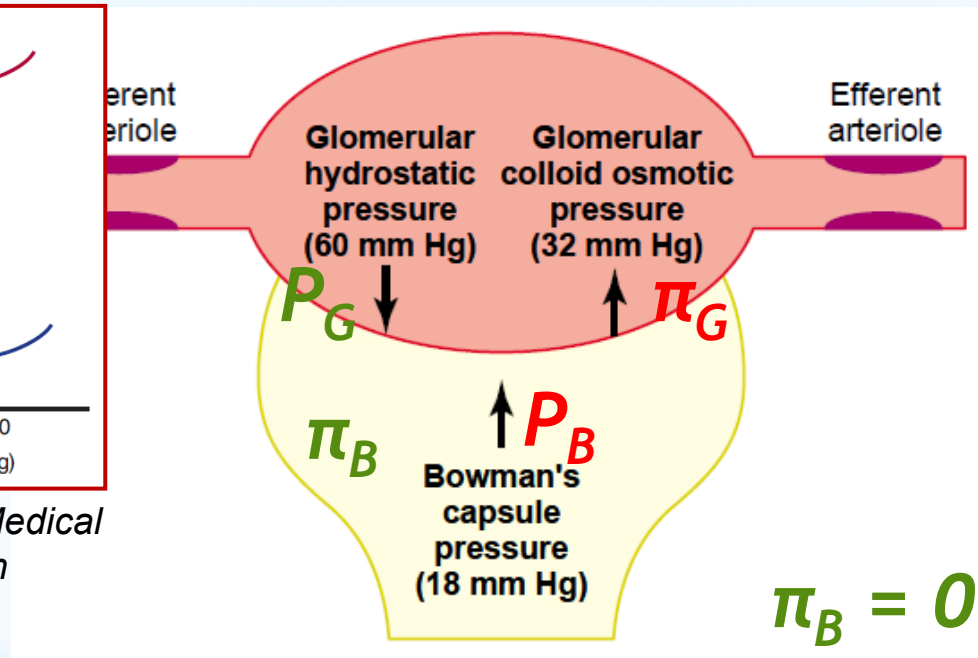

Guyton & Hall. Textbook of Medical Physiology

Under physiological conditions:

$$\text{net filtration pressure} = P_G + \pi_B - P_B - \pi_G = 60 + 0 - 18 - 32 = 10 \text{ mmHg}$$

$$\text{GFR} = K_f \cdot (P_G + \pi_B - P_B - \pi_G)$$

Regulation of Tubular Reabsorption

- controls balance between the glomerular filtration and tubular reabsorption

1) Local Regulation

2) Neural Regulation

3) Humoral Regulation

Glomerulotubular Balance

- \uparrow tubular reabsorption rate at \uparrow load of fluid flowing through tubules (prevention of overload of distal parts of tubulus)
- **namely in the proximal tubule**
- **local** mechanisms (present even in isolated proximal tubule)
- mechanisms not fully known (changes of physical forces?)

Regulation of Tubular Reabsorption

1) Local Regulation

Physical Forces in Peritubular Capillaries and in Renal Interstitium

- tubular reabsorption is controlled by hydrostatic and colloid osmotic forces (similarly to GFR)

$$\text{GFR} = K_f \cdot \text{net filtration pressure}$$



$$\text{TRR} = K_f \cdot \text{net reabsorptive force}$$

Regulation of Tubular Reabsorption

1) Local Regulation

Physical Forces in Peritubular Capillaries and in Renal Intersticium

- K_f
- $\uparrow K_f \rightarrow \uparrow \text{TRR}$ and *vice versa*
 - rather stable under physiological conditions

Regulation of Tubular Reabsorption

1) Local Regulation

Physical Forces in Peritubular Capillaries and in Renal Interstitium

- tubular reabsorption is controlled by hydrostatic and colloid osmotic forces (similarly to GFR)

$$\text{GFR} = K_f \cdot \text{net filtration pressure}$$



$$\text{TRR} = K_f \cdot \text{net reabsorptive force}$$

Regulation of Tubular Reabsorption

1) Local Regulation

Physical Forces in Peritubular Capillaries and in Renal Interstitium

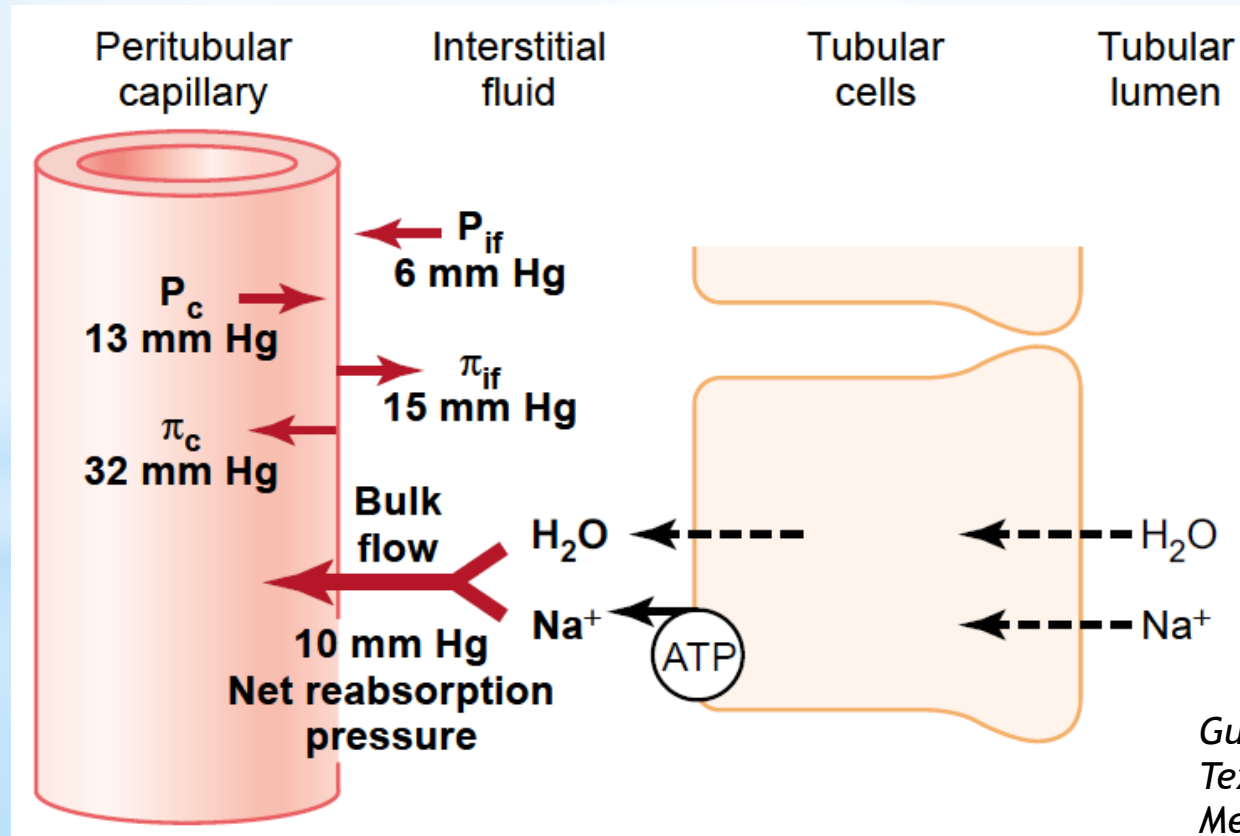

Guyton & Hall.
Textbook of
Medical Physiology



Regulation of Tubular Reabsorption

1) Local Regulation

Physical Forces in Peritubular Capillaries and in Renal Interstitium – renal haemodynamics influence

- P_c - **BP** (\uparrow BP \rightarrow \uparrow P_c \rightarrow \downarrow TRR) *autoregulation!*
- **resistance of aff. and eff. arterioles**
(\uparrow resistance \rightarrow \downarrow P_c \rightarrow \uparrow TRR)
(\uparrow resistance of eff. a. \rightarrow \downarrow P_c + \uparrow P_g \rightarrow \uparrow TRR + \uparrow GFR)
- π_c - **π in plasma**(\uparrow π \rightarrow \uparrow π_c \rightarrow \uparrow TRR)
- **filtration fraction** (\uparrow FF \rightarrow \uparrow π_c \rightarrow \uparrow TRR)
(FF = GFR /renal plasma flow)

Regulation of Tubular Reabsorption

1) Local Regulation

Physical Forces in Peritubular Capillaries and in Renal Interstitium – changes in interstitium (P_{if} , π_{if})

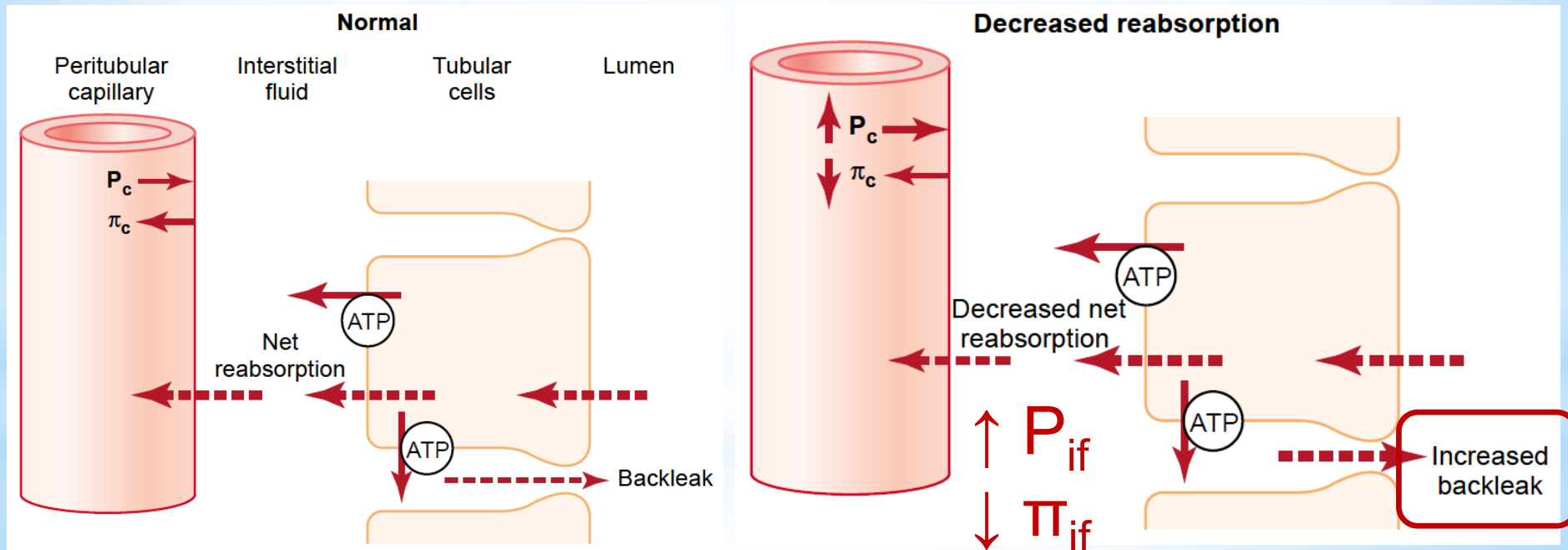

Guyton & Hall. Textbook of Medical Physiology

\uparrow reabsorption \rightarrow $\downarrow P_{if}$ a $\uparrow \pi_{if} \rightarrow$ \downarrow backleak

Regulation of Tubular Reabsorption

1) Local Regulation

Pressure Natriuresis and Pressure Diuresis

- increased excretion of salt and water at \uparrow BP
- mechanisms:

\uparrow GFR

physiologically at common BP (75-160 mmHg)
slight effect on diuresis due to **autoregulation of renal blood flow and GFR**

vs. impaired autoregulation (renal diseases)

Regulation of Tubular Reabsorption

1) Local Regulation

Pressure Natriuresis and Pressure Diuresis

- increased excretion of salt and water at \uparrow BP
- mechanisms:

\uparrow GFR

\downarrow TRR

\uparrow BP \rightarrow slight \uparrow P_c \rightarrow \uparrow P_{if} \rightarrow \uparrow *backleak* \rightarrow \downarrow TRR

\downarrow formation of angiotensine II

\uparrow BP \rightarrow \downarrow secretion of renin \rightarrow \downarrow formation of angiotensine II \rightarrow \downarrow reabsorption of Na^+ (both directly and through \downarrow secretion of aldosteronu)

Regulation of Tubular Reabsorption

2) Neural Regulation

Sympathicus

→ ↑ reabsorption of salt and water

- during a small ↑ of its activity (α -rec. in epithelia):
directly through ↑ reabsorption of Na^+ in the proximal tubule, in the ascending loop of Henle and may be also in the distal parts of tubulus
- during a notable ↑ of its activity **indirectly**:
→ constriction of aff. and eff. arterioles → ↓ renal blood flow → ↓ P_c → ↑ TRR

Regulation of Tubular Reabsorption

3) Hormonal Regulation

- impact – **separate regulation** of reabsorption/excretion of particular solutes (other mechanisms are nonspecific – influence the total TRR)

Aldosteron

Angiotensine II

Natriuretic peptides (namely ANP)

Antidiuretic hormone

Parathormone, ...

Urodilatin (renal NP)

Regulation of Tubular Reabsorption

3) Hormonal Regulation

Aldosteron

Angiotensine II

- RAS

Aldosteron

- principal cells of the distal tubule and of the cortical part of collecting duct
- stimulation of activity and number of Na^+/K^+ ATPases + \uparrow permeability of the luminal membrane for Na^+ (epithelial Na^+ channels)
 - \uparrow reabsorption of Na^+ (and water)
 - \uparrow secretion of K^+

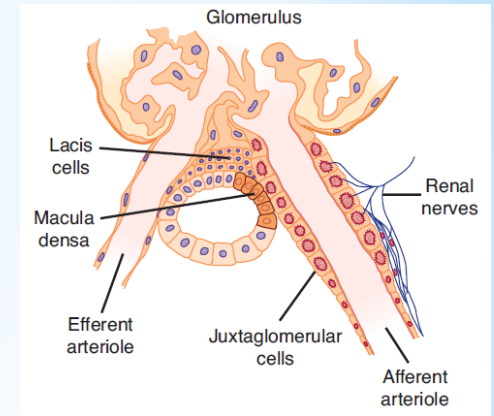

Ganong's Review of Medical Physiology, 23rd edition

Regulation of Tubular Reabsorption

3) Hormonal Regulation

Aldosteron

Angiotensine II

- RAS

Angiotensine II

- shifts BP and extracellular volume back to normal

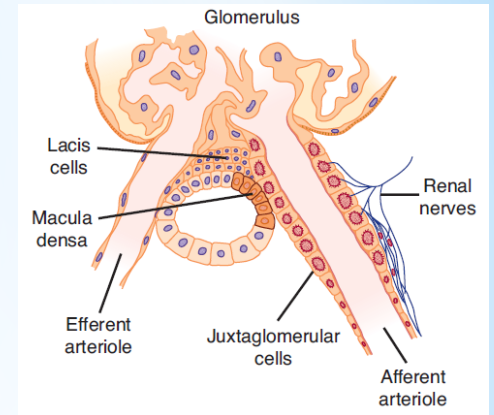

Ganong's Review of Medical Physiology, 23rd edition

Regulation of Tubular Reabsorption

3) Hormonal Regulation

Aldosteron

Angiotensine II

- RAS

Angiotensine II

→ ↑ reabsorption of Na^+ (and water):

a) stimulation of aldosteron secretion

b) constriction of eff.a.

→ ↓ P_c → ↑ TRR (namely in the proximal tubule)

→ ↓ blood flow → ↑ FF → ↑ π_c → ↑ TRR

c) direct stimulation of Na^+ reabsorption in the tubulus (Na^+/K^+ , Na^+/H^+ , $\text{Na}^+/\text{HCO}_3^-$)

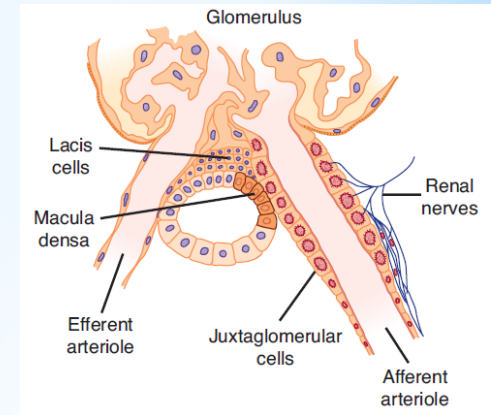

Ganong's Review of Medical Physiology, 23rd edition

Regulation of Tubular Reabsorption

3) Hormonal Regulation

Natriuretic peptides (namely ANP)

increased tension of atrial cardiomyocytes

→ ↑ secretion of ANP:

→ ↓ reabsorption of salt and water directly
(namely in the collecting ducts)

→ ↓ secretion of renin → ↓ angiotensine II → ↓
TRR

The level of ANP chronically increased at congestive heart failure which helps to reduce retention of salt and water.

Regulation of Tubular Reabsorption

3) Hormonal Regulation

Antidiuretic hormone (ADH)

- controls excretion of water

↑ **osmolality of plasma** (osmoreceptors)

→ ↑ secretion of ADH – V_2 receptors in the final part of the distal tubule and in the collecting ducts → fusion of the vesicles with water channels (aquaporins 2) with the luminal membranes of epithelial cells

→ ↑ **reabsorption of water by osmosis**

Regulation of Tubular Reabsorption

3) Hormonal Regulation

Parathormone

- controls excretion of Ca^{2+}

↓ **calcemia**

→ ↑ secretion of parathormone:

→ ↑ **tubular reabsorption of Ca^{2+}**
(namely in the distal tubule)

→ ↓ **tubular reabsorption of phosphate in the proximal tubule**

→ ↑ **tubular reabsorption of Mg^{2+} in the loop of Henle**

Filling and emptying of the bladder

cystometrogram

