

# Histology and Embryology

## Program of the 1st practice

- **general information**  
(organization of teaching)
- **histology and embryology**  
(what is the subject of study)
- **tissue processing for the light and electron microscopy**  
(laboratory methods)
- **demonstration of histological slides**  
(staining by different methods )

# Organization issues

- Beginning - **strictly on time**
- Change your shoes - you will not be allowed to enter the hall w/o indoor shoes
- Lockers – jackets, coats, bags etc.
- Cell phone – switched off or in silent mode
- Microscopic hall = **laboratory**
  - eating, drinking, smoking not allowed
  - smoking strictly forbidden anywhere in LF
  - students have to follow the instructions
  - academic misconducts or inappropriate behavior result in excluding from the lesson or course
- **Follow safety rules**
- You have **dedicated working place**
- You are responsible for microscope, slide set, EM atlas

# Organization issues

- **Practical lesson**

- introduction; images free available through **electronic resources**
- **your individual work** = study of the slides, schematic but precise drawing of tissue architecture, careful description. You make your own „study atlas“.
- students are supposed to come prepared for practices - schedules and syllables – IS, pin-boards
- **break – 10 minutes**

# Organization issues

## Attendance

### – 100% attendance

- substitution only in exceptional cases, after permissions from both the teacher of your group and the lesson where you plan to substitute
- sign in to the list
- make a protocol, let it check and signed by the lecturer
- one absence can be excused by a teacher, any other absence has to be excused formally by the Faculty through the IS
- late-comers cannot join the practice and have to substitute the missed practice

# Registration of substitution:

Datum Date	Jméno Name	Ročník Year	Skupina Group	Č. praktika Nr. of practice	Č. místa Nr. of place	Vyučující - podpis Teacher- signature

# Protocols

- paper **protocols**
- A4 size, blank, without lines, **according to the template** (can be downloaded from **interactive syllabus** in the IS)
- (color)pencil handdrawings
- **complete set of signed protocols** is required for getting the credits
- **the quality of the protocol** is approved by your teacher's signature at the end of practical lesson
- **incomplete or low-quality protocols cannot be approved** and the lesson must be substituted

# Protocols

Protocol No: ..... Name: .....  
Date: ..... Year: ..... Group: .....

---

TOPIC: .....

<u>List of slides for study:</u>		<u>Atlas EM: pictures for study</u>	
Number	Designation (staining)	Page	Designation
.....	.....	.....	.....
.....	.....	.....	.....
.....	.....	.....	.....
.....	.....	.....	.....
.....	.....	.....	.....
.....	.....	.....	.....
.....	.....	.....	.....
.....	.....	.....	.....
.....	.....	.....	.....
.....	.....	.....	.....

**Guidelines for the establishment protocol**

1. Student shall prepare color diagrams of histological slides (crayons) or black and white diagrams of pictures in EM atlas (pencils).
2. Each diagram must be provide with the following information:
  - designation of slide and staining method (see the list above), or designation of EM photograph,
  - magnification: 10 x 4 / 10 x 10 / 10 x 20 / 10 x 40 or total magnification: 40x / 100x / 200x / 400x,
  - description of the diagram.

**Checking of protocol**

Practice: regular  substitute  date .....

.....  
Signature of teacher

|

# Getting the credits

- **100% attendance**
- **complete set of signed protocols** from all lessons including substitutions
- **testing**
  - every student is examined four times per semester by a written, "partial", test
  - tests can be done in the regular practice only, not in the substituting practice
  - all four tests have to be passed (4/4)
  - if a student fails a partial test, it is indicated in the IS (F). The partial test can be repeated once until the end of semester (1st resit). If this fifth test is passed (4/5), conditions for getting credits are met
  - if a student fails in the 1st resit test, it is also indicated in the IS (FF). The "semestral" (2nd resit) test is scheduled at the end of the semester.



# Organization issues

- **End of practical lesson:**
  - the practice is closed by the lecturer
  - you are allowed to leave your working place only after checking the microscope and slides
  - if you leave before the check you may be responsible for any damages/losses recognized later
- During the semester, the primary contact is the teacher of student's study group. Name of the teacher can be found in the Timetable, the email contact then in the IS.
- Alternatively, a general email contact can be used:  
[histology@med.muni.cz](mailto:histology@med.muni.cz)



# RECOMMENDED LITERATURE

Mescher, A.L. *Junqueira's basic histology :text and atlas*. 13th ed. New York: McGraw-Hill Medical, 2013. xi, 544. ISBN 9781259072321.

Moore, K.L., T.V.N. Persaud a M.G. Torchia. *The developing human: clinically oriented embryology*. 9th ed. Philadelphia, PA: Saunders/Elsevier, 2013. xix, 540. ISBN 9781437720020.

Ovalle, W.K., P.C. Nahirney a F.H. Netter. *Netter's essential histology*. 2nd ed. Philadelphia, PA: Elsevier/Saunders, 2013. xv, 517. ISBN 9781455706310.

Young, B. *Wheater's functional histology :a text and colour atlas*. 5th ed. [Oxford]: Churchill Livingstone, 2006. x, 437. ISBN 044306850X.

Sadler, T.W. a J. Langman. *Langman's medical embryology*. Illustrated by Jill Leland. 11th ed. Baltimore, Md.: Lippincott William & Wilkins, 2010. ix, 385. ISBN 9781605476568.

Lowe, J.S. a P.G. Anderson. *Stevens and Lowe's Human Histology*. 4th. : Elsevier, 2015. ISBN 978-0-7234-3502-0.

**Lectures  
Protocols**

# RECOMMENDED LITERATURE

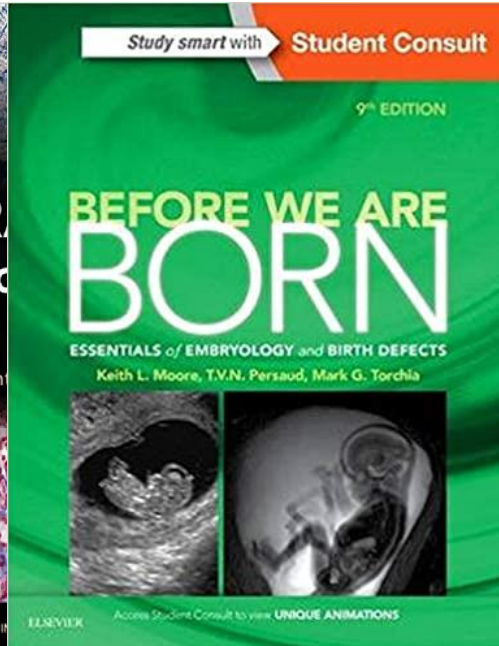
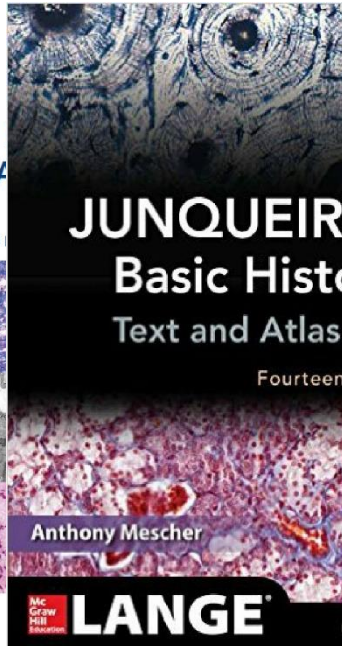
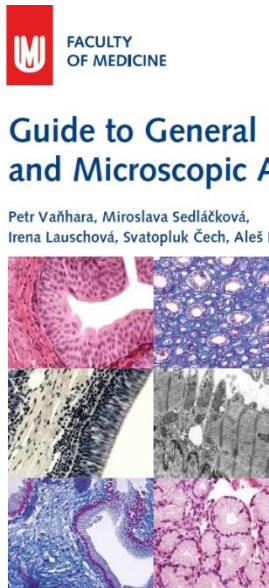
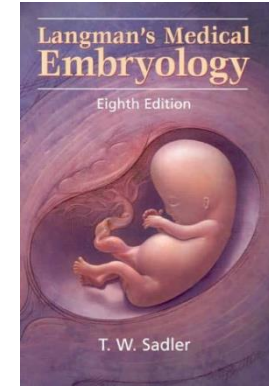
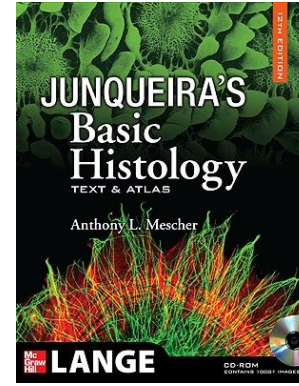
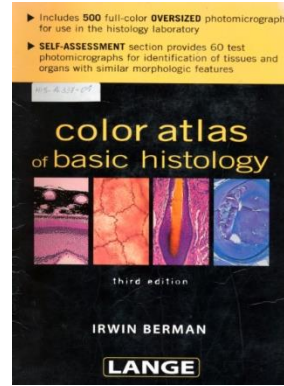
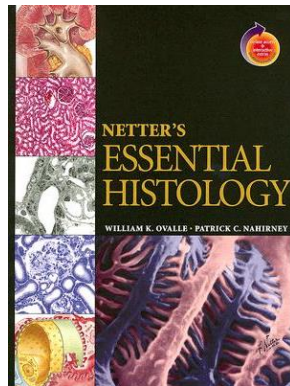
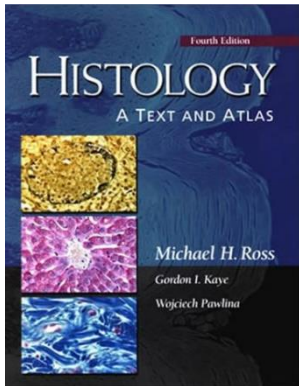

Department of Histology and Embryology MF MU

<http://histology.med.muni.cz>

# E-RESOURCES



Department of  
Histology and  
Embryology



Home Page

Research

Education ▾

Grants

Publications

People

Instrumentation ▾

Contact

## Atlas of Histology

*recommended study tool*

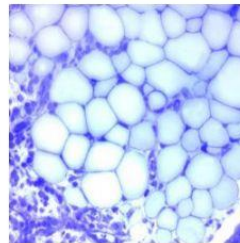

## Atlas of Cytology and Embryology

*recommended study tool*

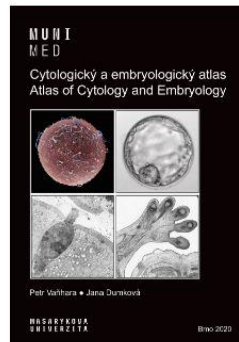

<https://histology.med.muni.cz/education/electronic-study-resources>

# HISTOLOGY

- structure and ultrastructure of normal cells and tissues,
- **cytology and general histology**
- **special histology** = microscopic anatomy of individual organs
  
- relevance: oncology, surgery, hematology, pathology, forensic,...



# EMBRYOLOGY

– prenatal (intra uterine) development

- **General embryology** (until 2nd month – EMBRYO )

gametogenesis and early embryonic development

- **Special embryology** (since 3rd month to birth – FETUS )

organogenesis

- **Teratology** – defects in organ development, malformations, anomalies; prenatal screening – ultrasonography, amniocentesis, genetic and karyotype screening

- Relevance: gynecology and obstetrics, pediatrics, assisted reproduction

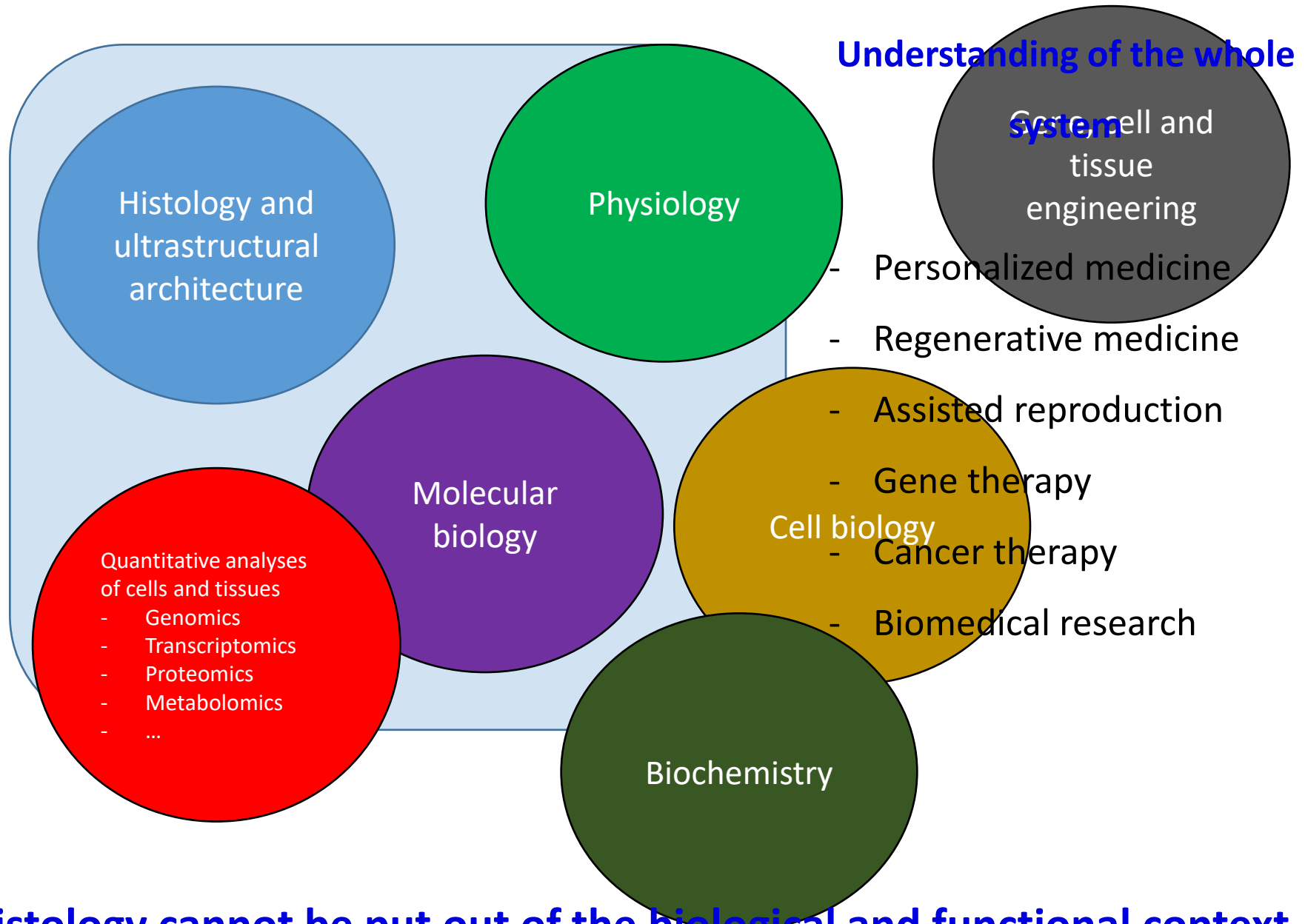

**Histology cannot be put out of the biological and functional context**



# Histology

- Resolution of naked eye – 0.1 mm
- Resolution of light microscopy – 0.1- 0.5  $\mu\text{m}$
- Resolution of electron microscopy – 0.1 - 1 nm

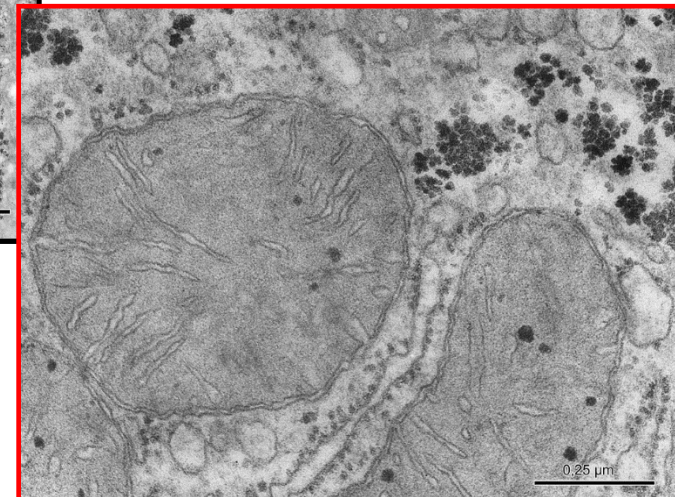
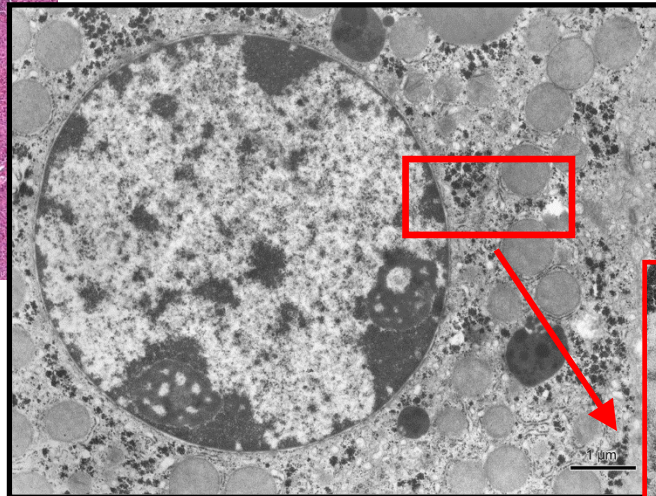
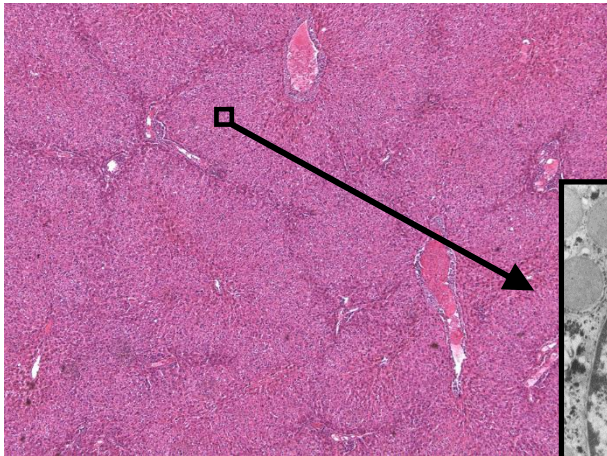
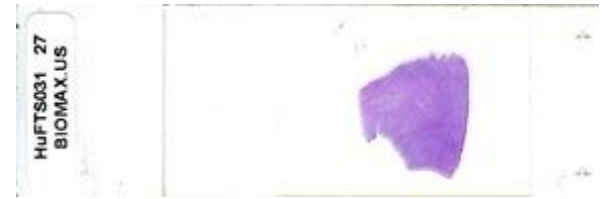

# Tissue processing for the light microscopy (LM)

(making of permanent preparations – slides)

- **SAMPLING** (obtaining of material – cells, tissue pieces)
- **FIXATION** of samples (tissue blocks)
- **RINSING** (washing) of samples
- **EMBEDDING** of samples - embedded blocks
- **CUTTING** of blocks - sections
- **AFFIXING** of sections
- **STAINING** of sections
- **MOUNTING** of sections

# SAMPLING

- A small piece of organ (tissue) is sampled and quickly put into the fixative medium.
- Biopsy during surgical dissection of organs in living organism
  - = excision
  - = puncture (liver or kidney parenchyma, bone marrow)
  - = curettage (uterine endometrium, adenoid vegetation)
- Necropsy from dead individual (sections); in experiments laboratory animals are used and tissue have to be sampled as soon as possible after the break of blood circulation
- The specimens shouldn't be more than **0.5 – 1 cm<sup>3</sup>** thick and fixation should follow immediately.

# Sampling tools



# FIXATION

- Definition: denaturation and stabilization of cell proteins with minimum artifacts
- The purpose of fixation: freshly removed tissues are chemically unstable – dry, shrink, undergo hypoxia, autolysis and bacteriological changes
- To stop or prevent these changes and preserve the structure tissue samples have to be fixed. During the fixation, all tissue proteins are converted into inactive denaturated (stable) form.
- 3 main requirements on fixatives:
  - good preservation of structure
  - quick penetration into tissue block
  - no negative effects on tissue staining

- Fixatives: solutions of different chemicals
  - **organic fixatives** – ALDEHYDES – formaldehyde (*most frequently used for LM*)
    - glutaraldehyde (*used for EM*)
    - ALCOHOLS – 96 – 100 % (absolute) ethylalcohol
    - ORGANIC ACIDS – glacial acetic acid, picric acid, trichloroacetic acid
  - **inorganic fixatives** – INORGANIC ACIDS – chromic acid, osmium tetroxide (OsO<sub>4</sub>)
    - SALTS OF HEAVY METALS – mercuric chloride HgCl<sub>2</sub>
  - **compound fixatives** – mixtures (two or more chemical components to offset avoid undesirable effects of individual (simple) fixatives.
    - FLEMMING's fluid – with OsO<sub>4</sub>
    - ZENKER's and HELLY's fluid, SUSA fluid – with HgCl<sub>2</sub>
    - BOUIN's fluid – with picric acid
    - CARNOY's fluid – with alcohol

Fixation is carried out at the room temperature, the time varies between **12 – 24 hours**, specimen must be overlaid by 20 – 50 times fixative volume:

Ratio of tissue block volume to fixative volume **1 cm<sup>3</sup> : 20 – 50 cm<sup>3</sup>**

# RINSING and EMBEDDING

- All samples should be washed to remove the excess of fixative; the choice of rinsing medium is determined by type of fixative: running tap-water or 70-80% ethanol
- Relevance of embedding: tissues and organs are brittle and unequal in density, they must be hardened before cutting

# EMBEDDING MEDIA

- water soluble – gelatine, celodal, water soluble waxes
- anhydrous – **paraffin**, celloidin



# EMBEDDING into PARAFFIN

- dehydration – to remove water from fixed samples by ascending series of ethanol is used (50%, 70%, 90%, 96%. each step - 2 – 6 hours
  - clearing – the ethanol must be replaced with organic solvantant that dissolves paraffin – xylene
  - infiltration – melted paraffin wax (56°C) is used; 3 x 6 hours.
  - casting (blocking out) – moulds (plastic, paper or metal chambers) are used for embedding.
- 
- The moulds are filled with melted paraffin, tissue samples are then placed inside and immediately immersed in cold water to cool paraffin quickly down.
  - These paraffin blocks are ready for trimming
- 
- **FFPE**



**Leica TP 1020**

Automated device for tissue dehydration

**Paper chambers**



**- metal**

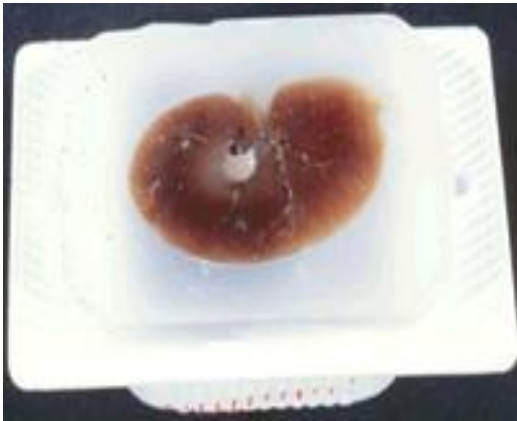

# CUTTING

- Microtome – a machine with automatic regulation of section thickness: 5 – 10  $\mu\text{m}$  is optimum.

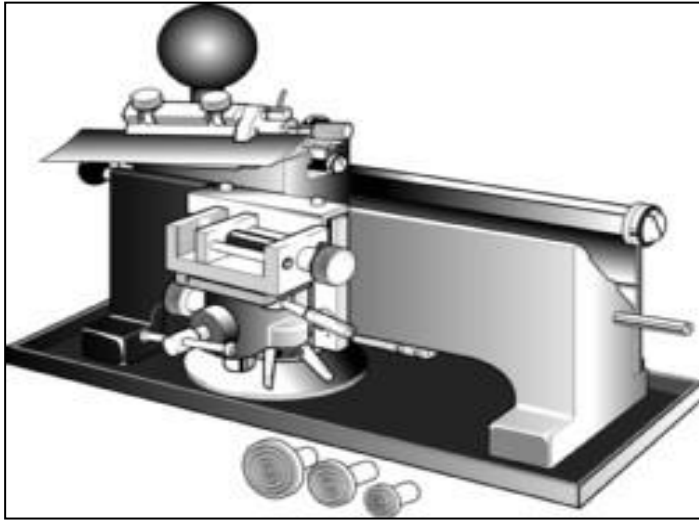

sliding microtome – block is fixed in holder, knife or razor moves horizontally

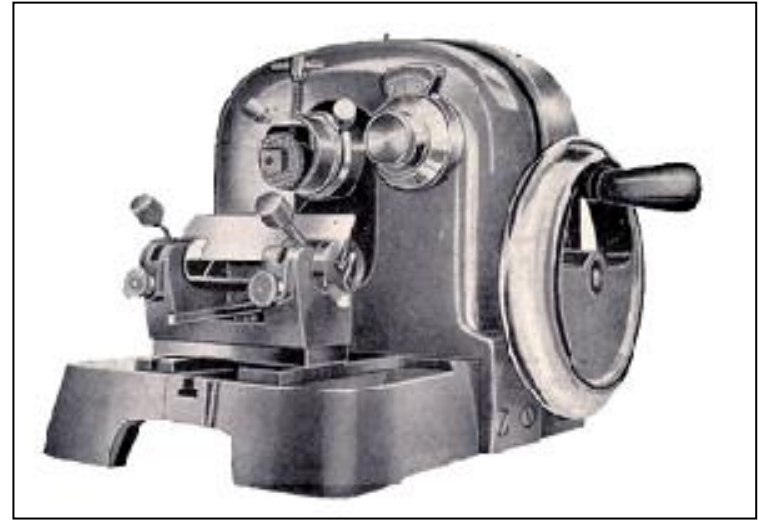

rotary microtome – knife is fixed, block holder moves vertically

## Sliding microtome

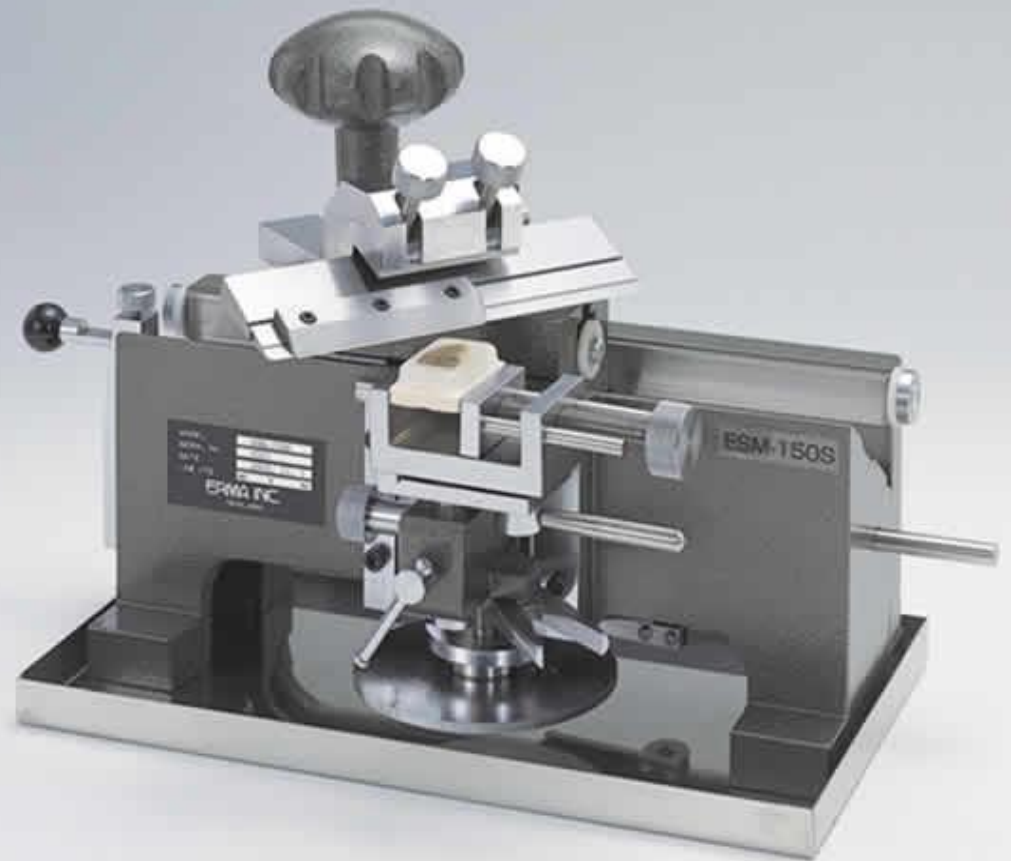

## Rotary microtome

MICROM

5

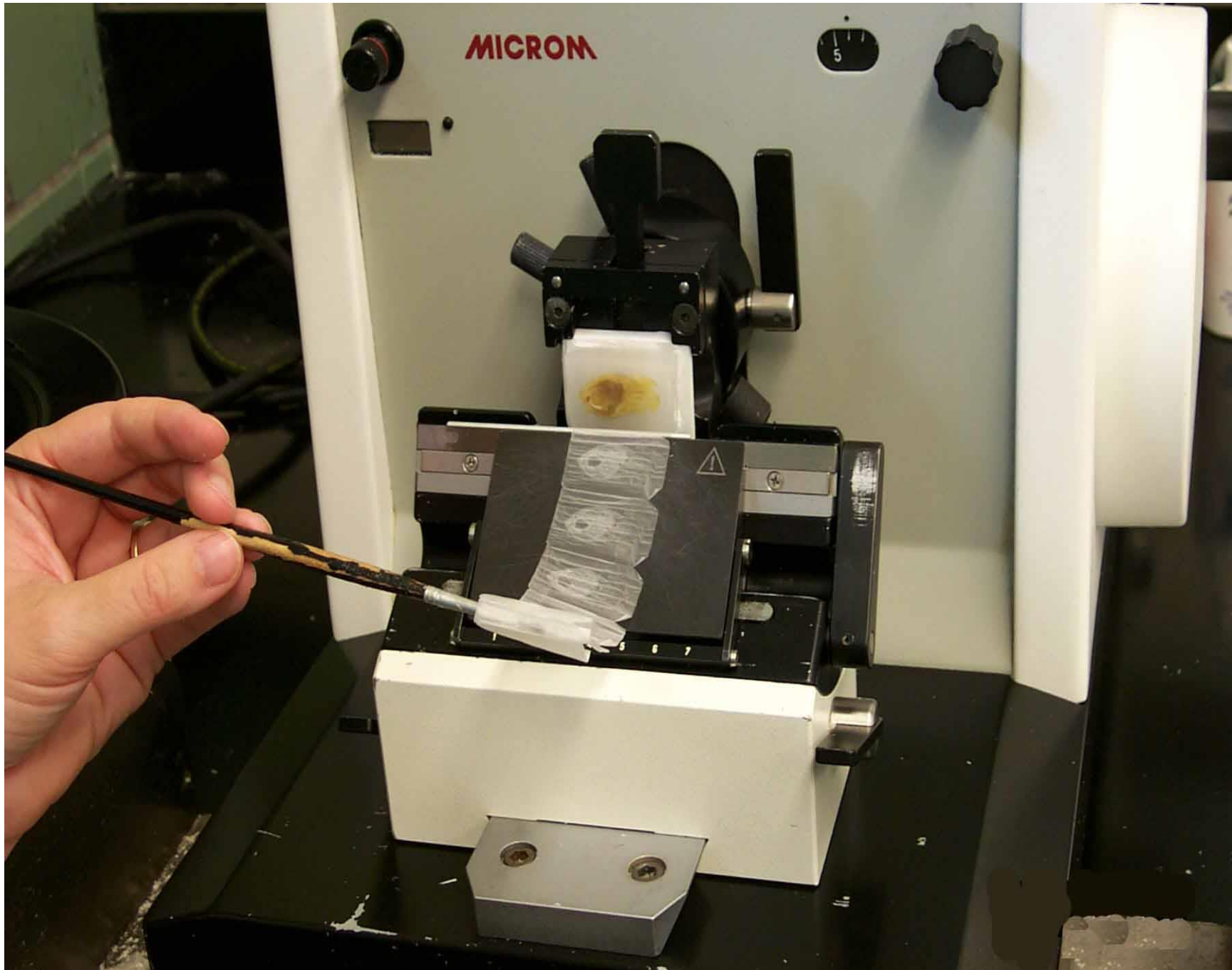





Freezing microtome (**cryostat**)  
= rotary microtome housed in freezing box  
(- 60° C)

Cutting of frozen tissue without the embedding

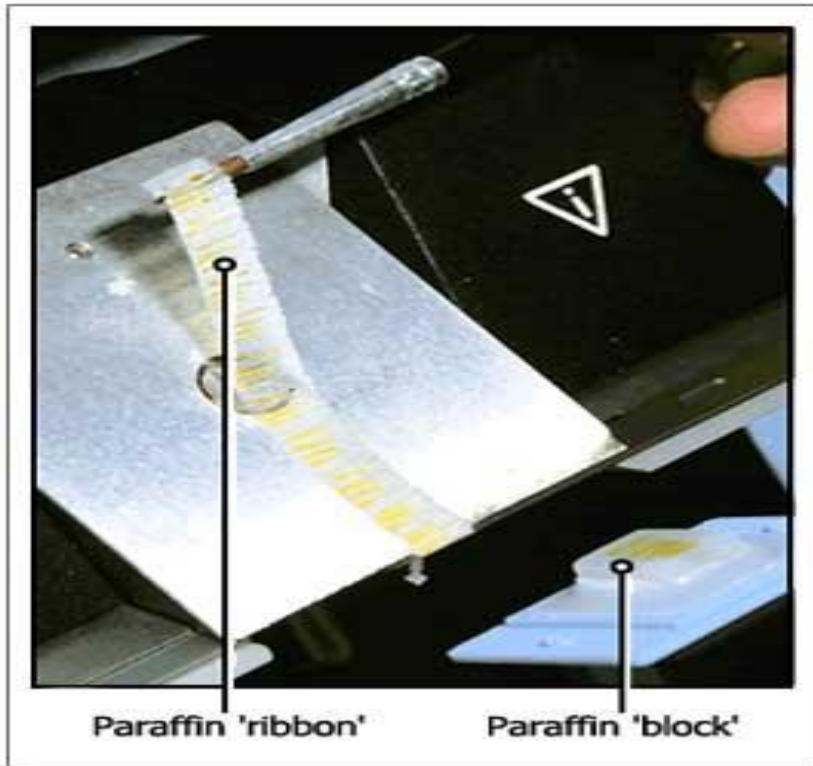

# CUTTING

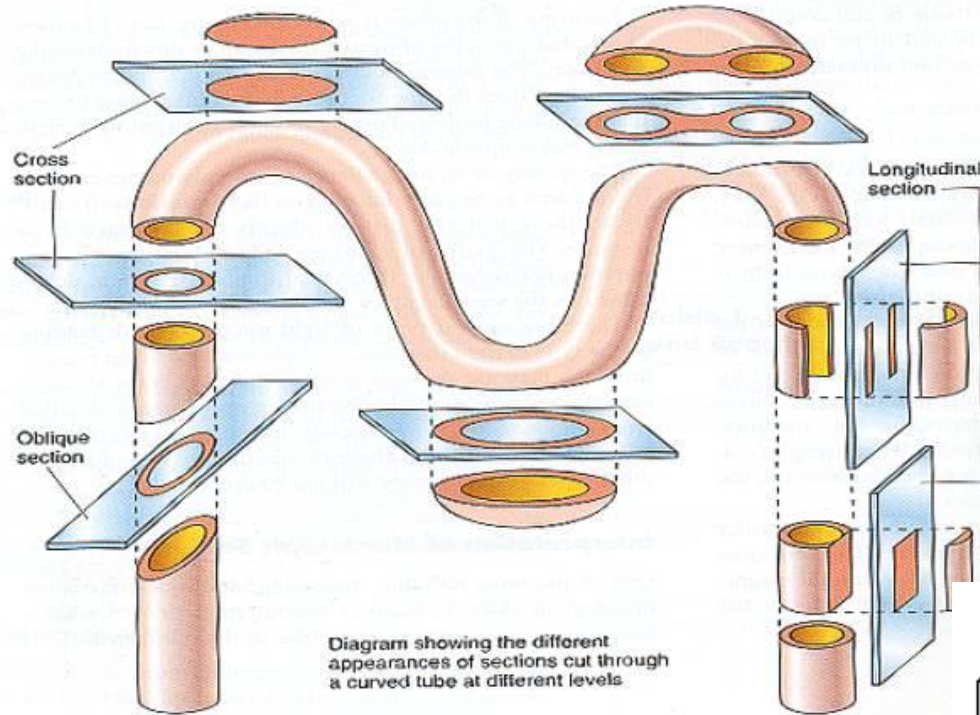
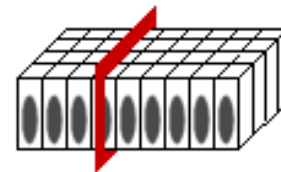

Diagram showing the different appearances of sections cut through a curved tube at different levels.



**perpendicular section**



**simple columnar epithelium**

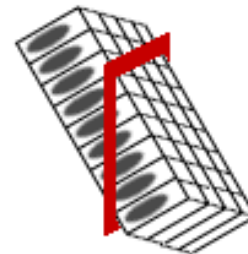

**oblique section**



# AFFIXING

- Mixture of glycerin and egg albumin or gelatin
- Section are transferred from microtome razor or knife on the level of warm water (45° C), where they are stretched; then they are put on slides coated with adhesive mixture; excess of water is drained and slides are put in incubator (thermostat, 37° C) over night to affixing of sections.



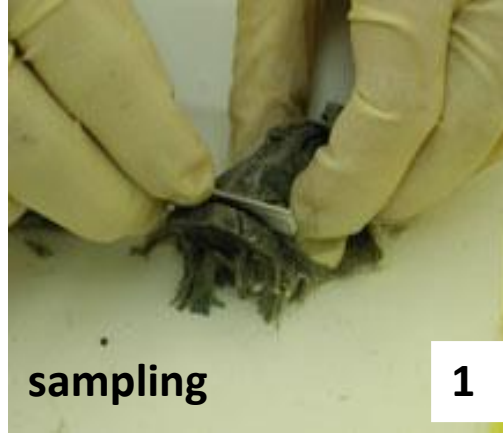

sampling

1

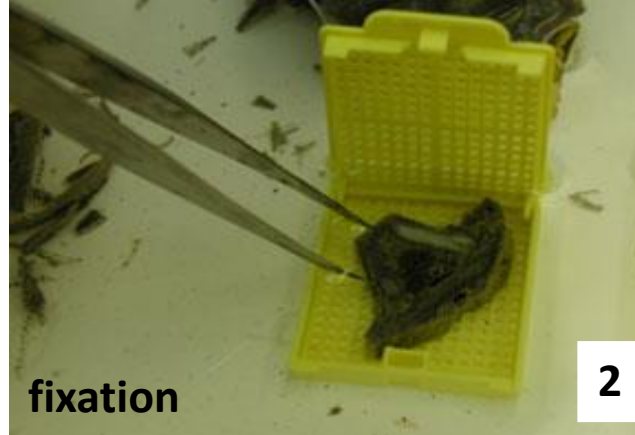

fixation

2

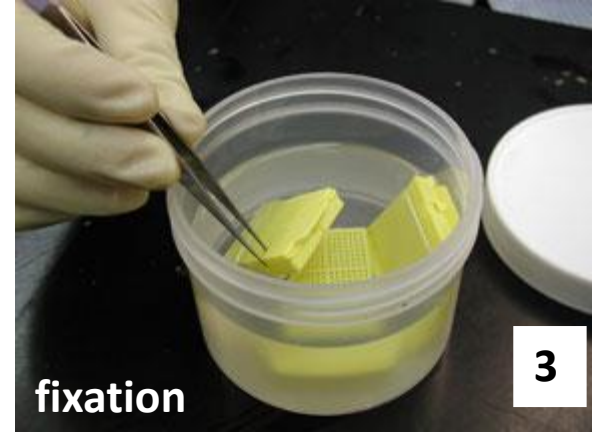

fixation

3



embedding

4

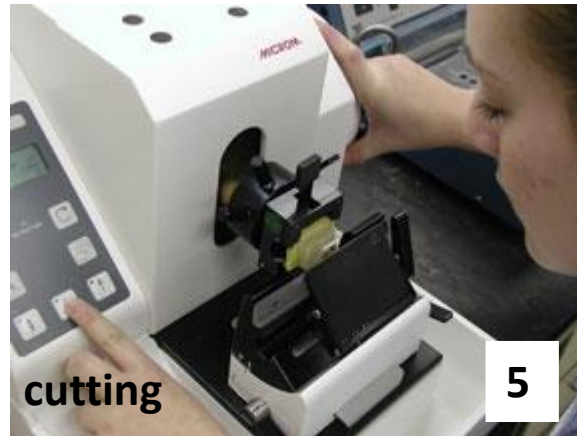

cutting

5

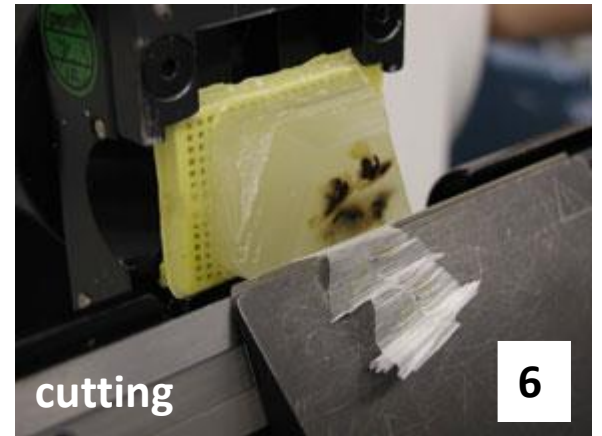

cutting

6



section affixing

7

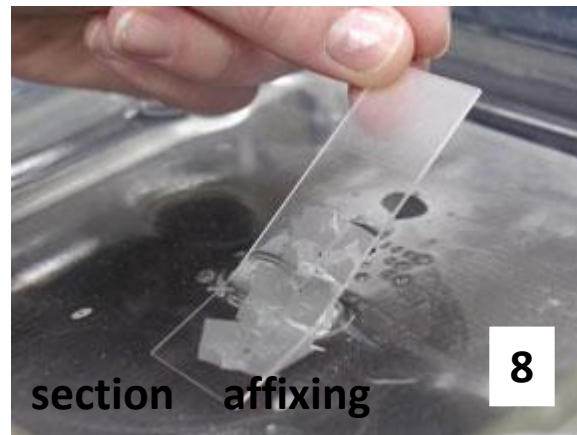

section affixing

8

Stretching of sections on warm water



Stretching on a warm plate



# STAINING

- Different cell or tissue structures are not apparent without staining.
- Cellular structures exhibit different affinity to staining dyes:  
**alkaline dyes** (basic or nuclear) – react with anionic groups of cell and tissue components

**basophilia** – basophilic structures in the cell

**acid dyes** (cytoplasmic) – react with cationic groups

**acidophilia** – acidophilic structures in the cell

**neutrophilia** – no reaction



# Hematoxyline and eosin (HE)

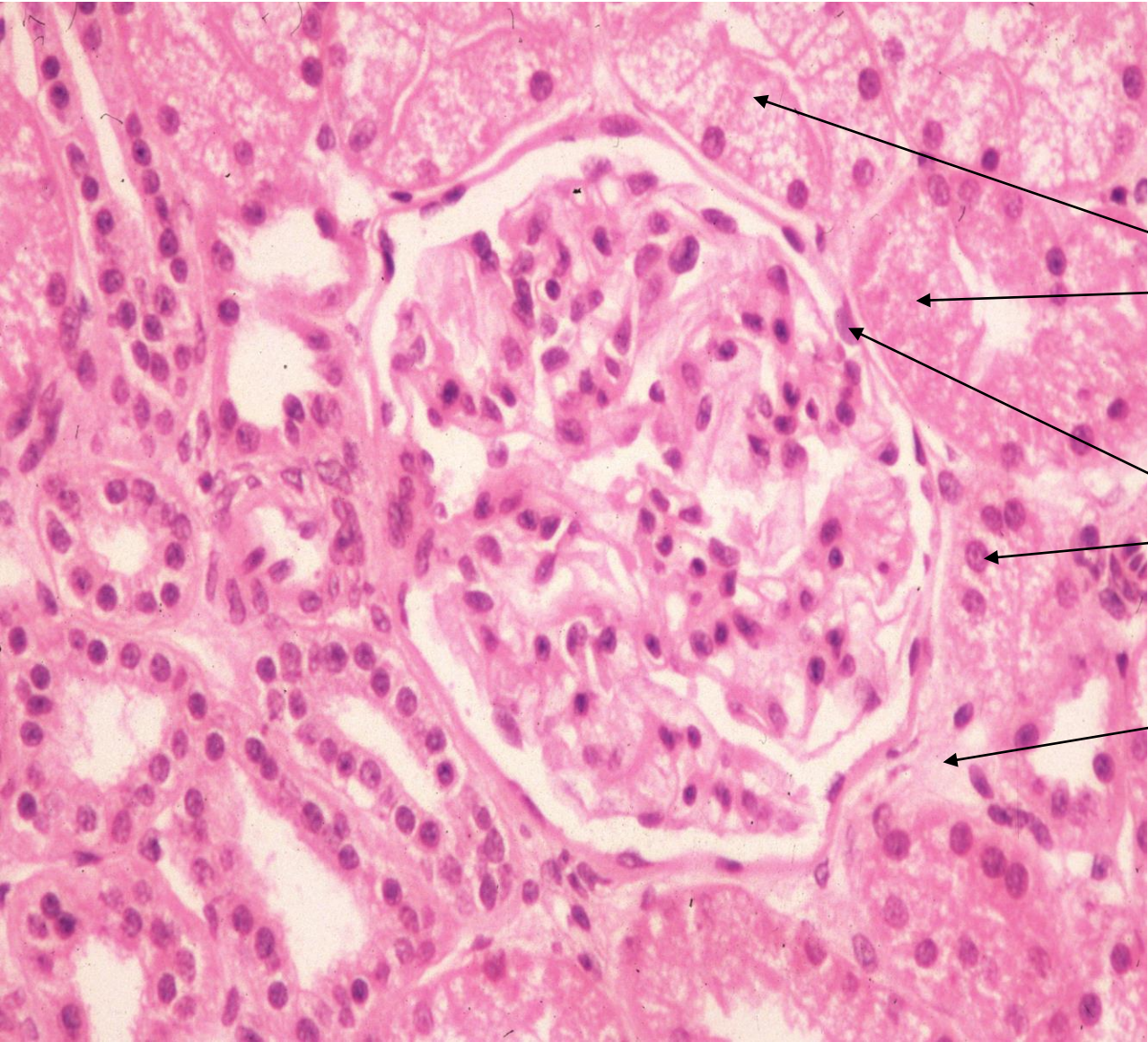

cell cytoplasm

cell nuclei

collagenous  
connective tissue

# HEMATOXYLINE – EOSIN (HE)

**Deparaffination**

**Rehydration**

**Washing**

**Staining**

**Differentiation**

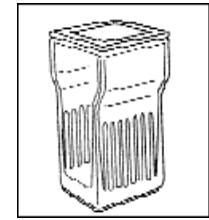
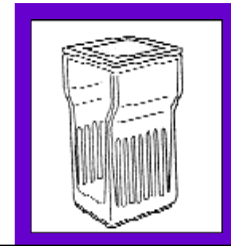
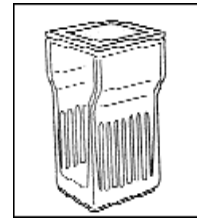
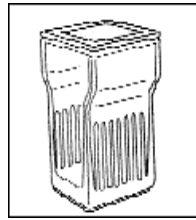
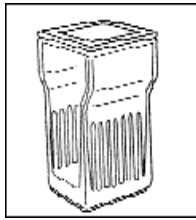
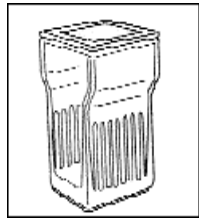

xylene I

xylene II

100%  
ethanol

96%  
ethanol

H<sub>2</sub>O

hematoxyline

acid  
ethanol

**Clearing**

**Dehydration**

**Washing**

**Staining**

**Washing**

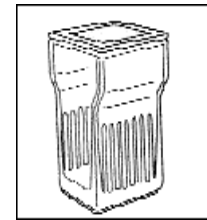
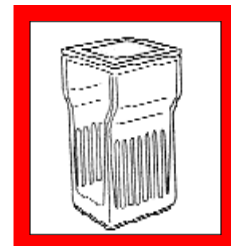
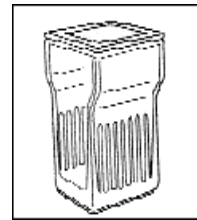
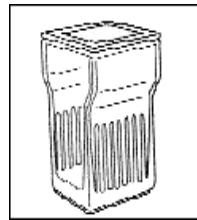
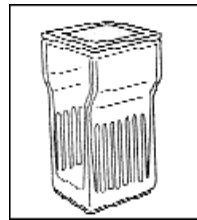
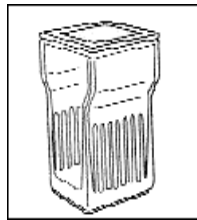
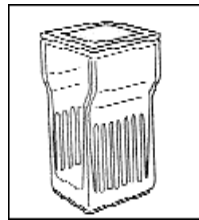

xylene IV

xylene III

100%  
ethanol

96%  
ethanol

H<sub>2</sub>O

eosin

H<sub>2</sub>O

# ROUTINE STAINING with HEMATOXYLINE – EOSIN (HE)

Hematoxyline – basic (nuclear) dye

Eosin – acid (cytoplasmic) dye



- Staining procedure:
- paraffin must be removed (dissolved) by xylene
- sections are rehydrated in descending series of ethanol (100% →96% →80%)
- staining with **hematoxyline**
- differentiation in acid ethanol and water (excess of dye is removed)
- staining with **eosin**
- rinsing in water (excess of dye is removed)
- dehydration in graded ethanol series (80% →96% →100%)
- clearing in xylene

# Staining results:

- **HE** = *Hematoxyline – Eosin*  
nuclei – bright clear blue or dark violet  
cytoplasm and collagen fibers – pink  
muscle tissue – red
  
- **HES** = *Hematoxyline – Eosin – Safron*  
connective tissue – yellow
  
- **AZAN** = *AZocarmin – ANiline blue – orange G*  
nuclei – red  
erythrocytes – orange  
muscle – red  
collagen fibers – blue



Staining tools:



cuvette

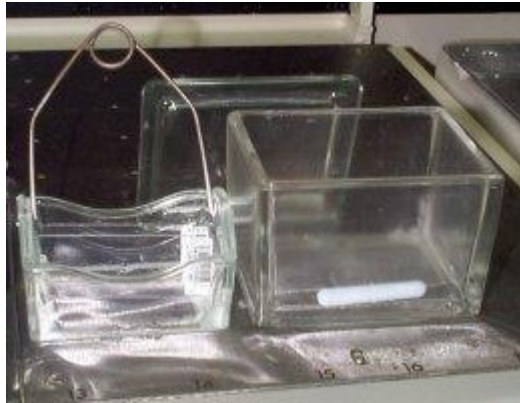
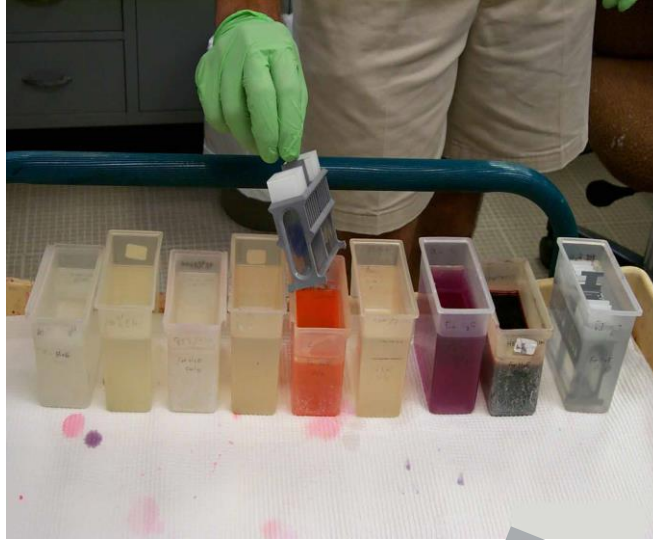

flask

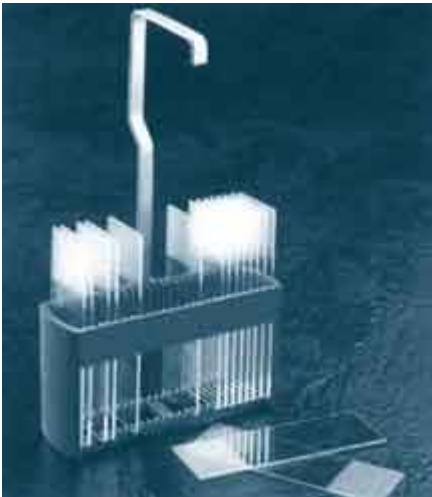

slides holder  
(basket)

# Automatic slide stainer



staining set of boxes with media



# MOUNTING

- Finally, preparates are closed with coverslip (coverglass) to form a permanent preparate. Small amount of mounting medium must be placed between stained section and the coverslip.

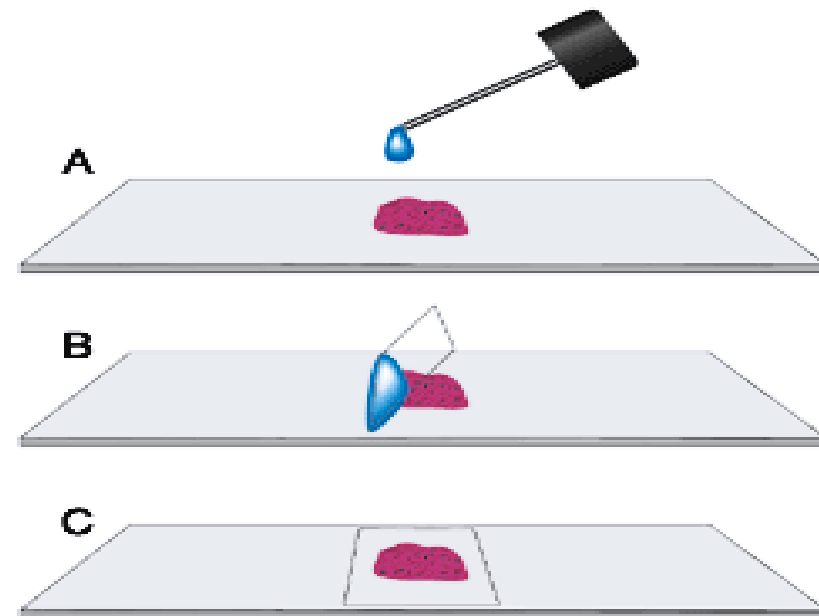
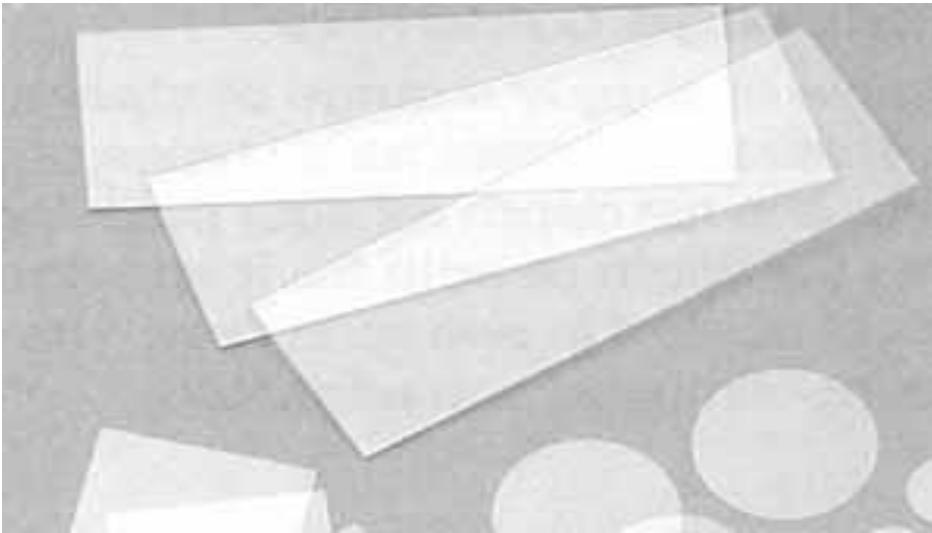

- Mounting media:** soluble in xylene – **canada balsam**  
soluble in water – glycerin-gelatine, arabic gum



**Permanent histological slides for study in the light microscope**



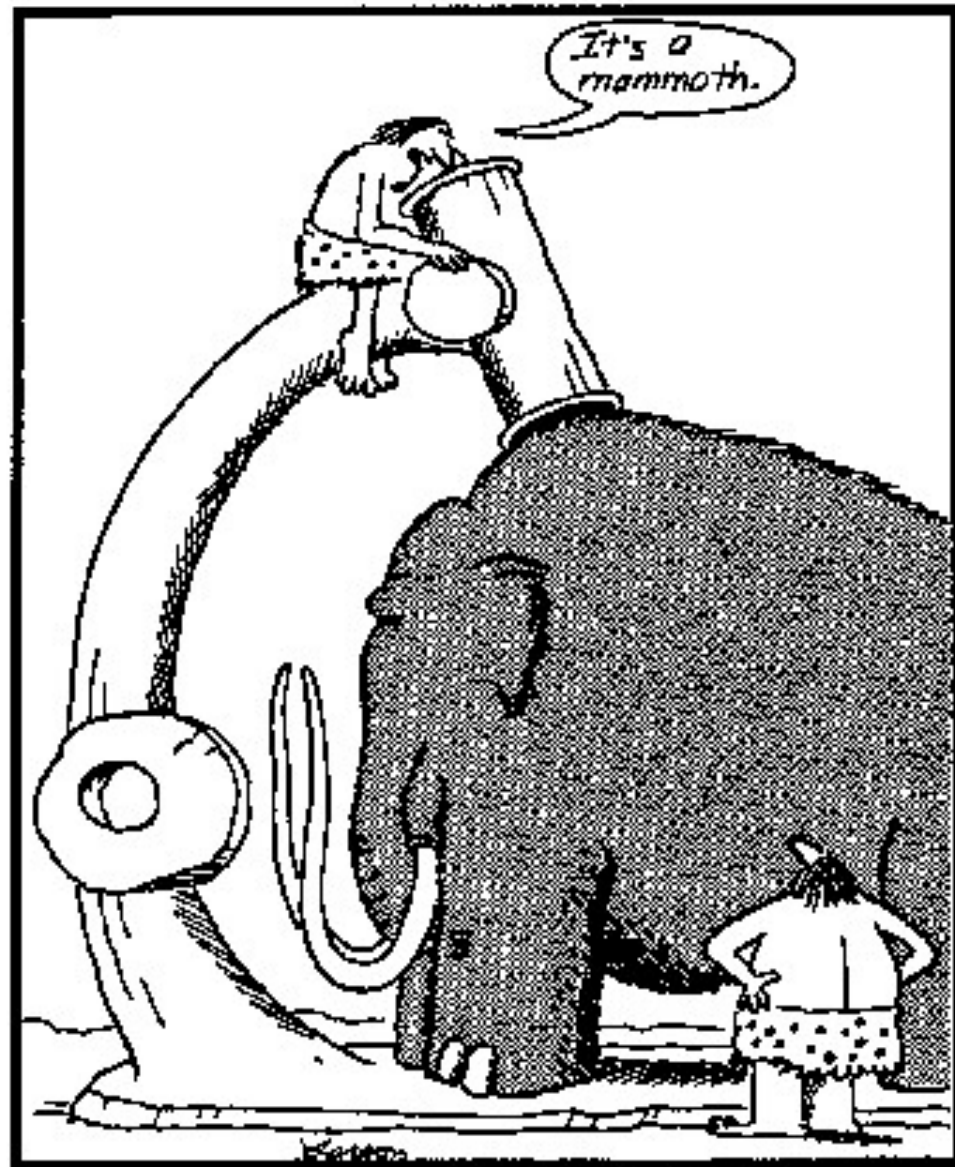

Early microscope

# Hematoxyline and eosin (HE)

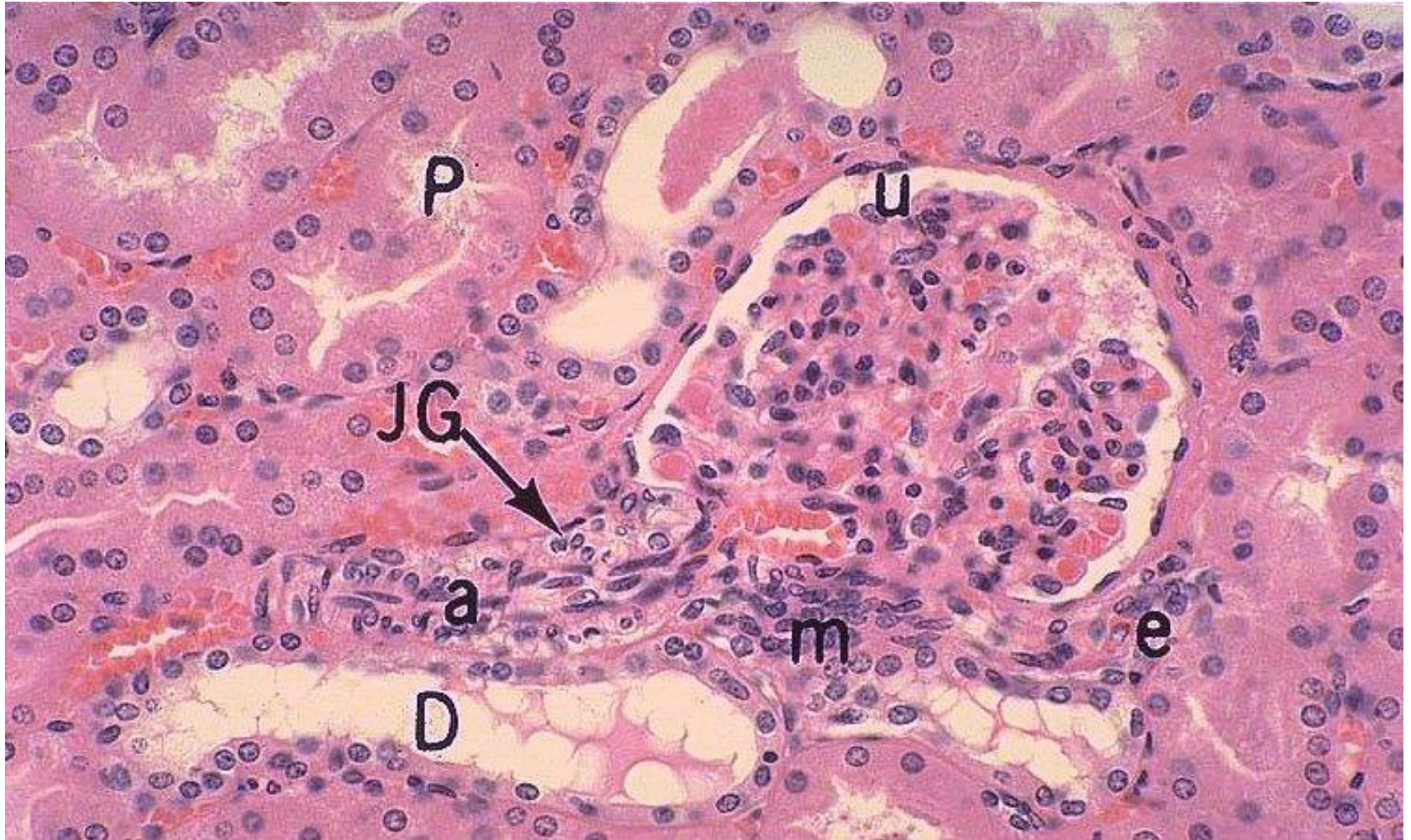



# Azocarmine and aniline blue (AZAN)

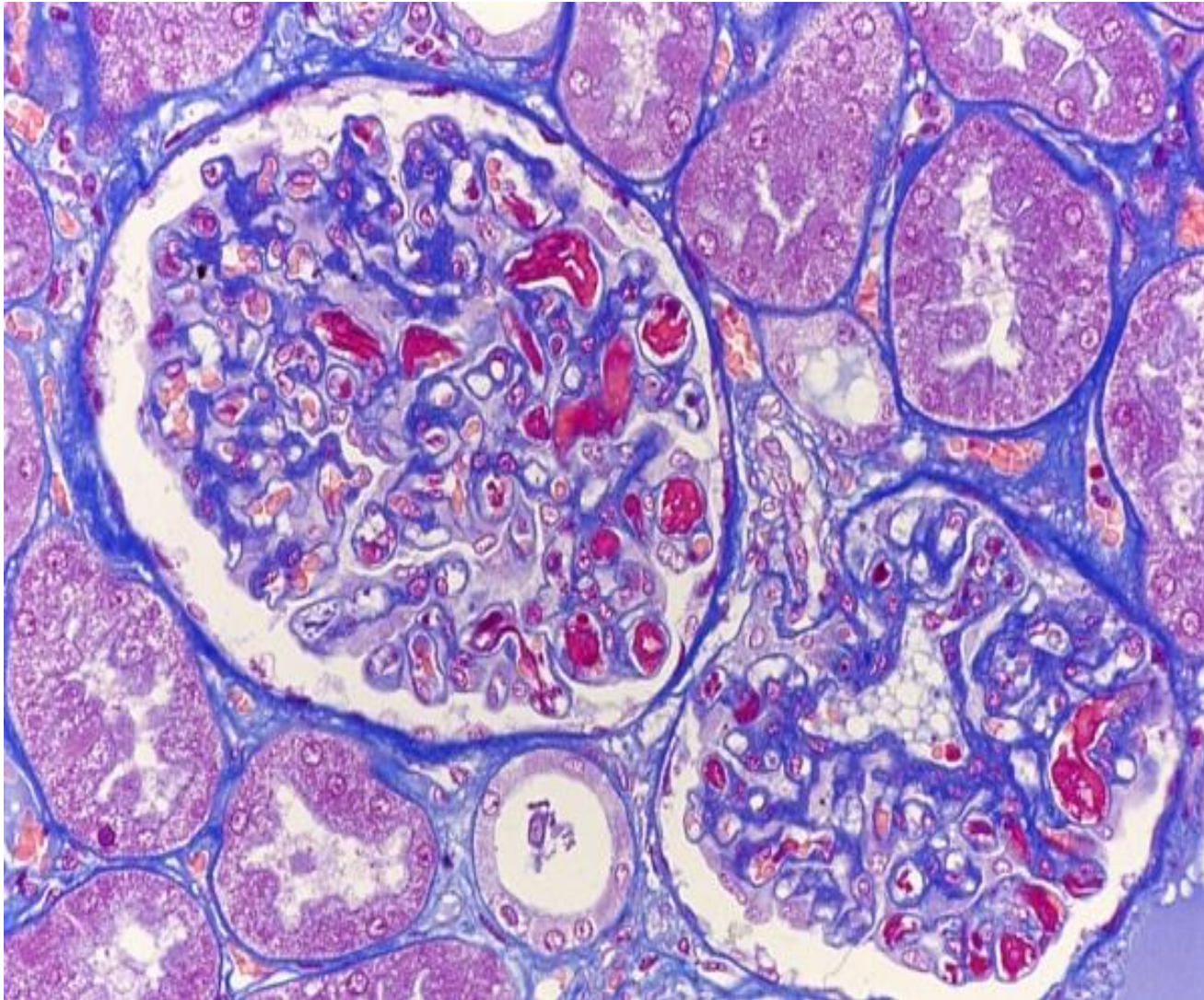

collagen fibers are blue



# Staining methods:

routine – HE, AZAN

(demonstrate all components of tissue)

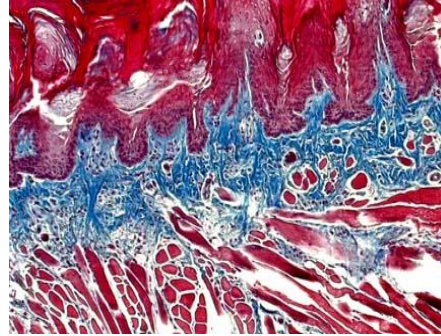
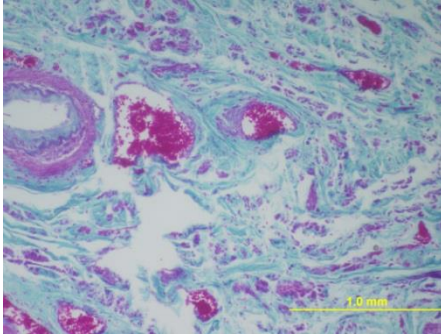

HE – the most frequent used method

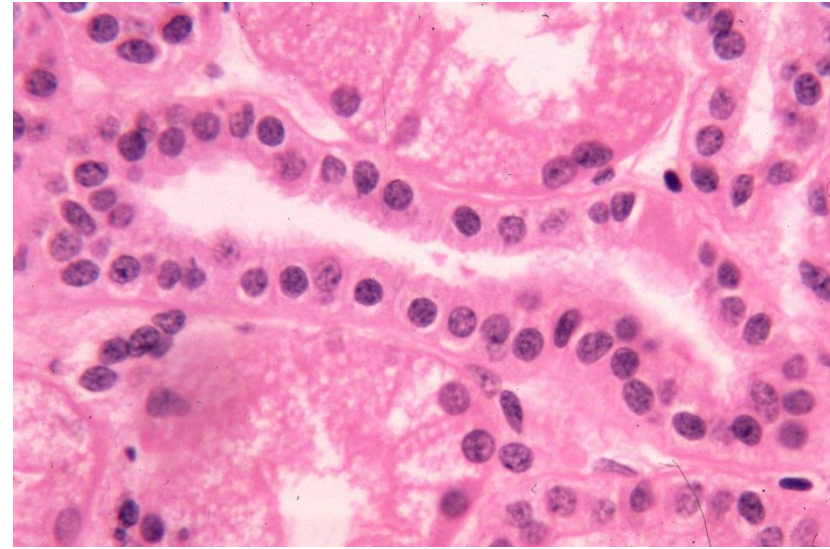

special

visualizes only special structures

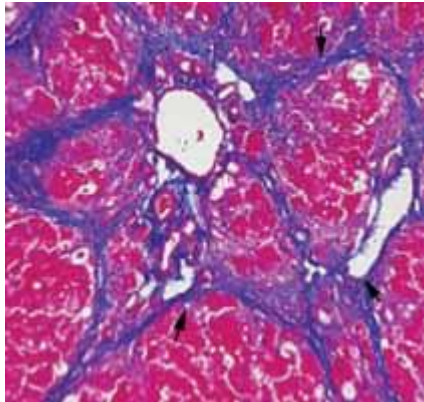

*Lipid droplets  
detected by oil red*

impregnation

by silver salt for detection  
of nerve or reticular fibers

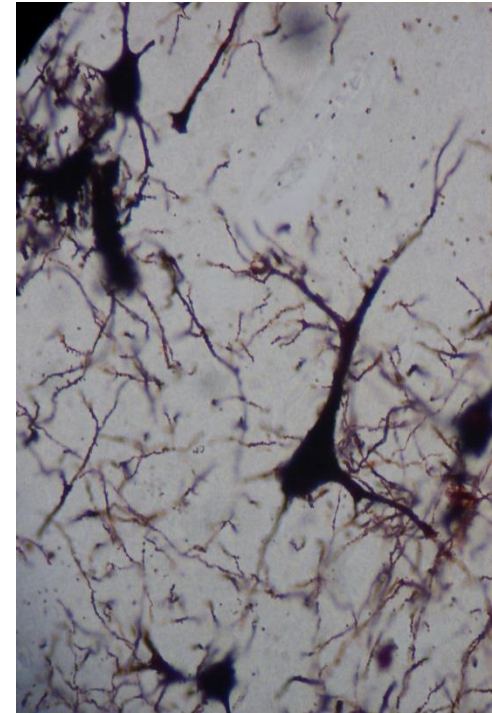



# Histochemistry and Immunohistochemistry

- Relevance:

various chemical compounds detected „in situ“ (proteins, AA, NA, saccharides, lipids, enzymes, pigments, inorganic substances – Fe, Ca, Zn)

Various epitopes detected by immunotechniques

Enzyme conjugated with secondary Ab - visualization

Secondary Ab specific against primary Ab

Primary Ab specific against epitope of the particular antigen

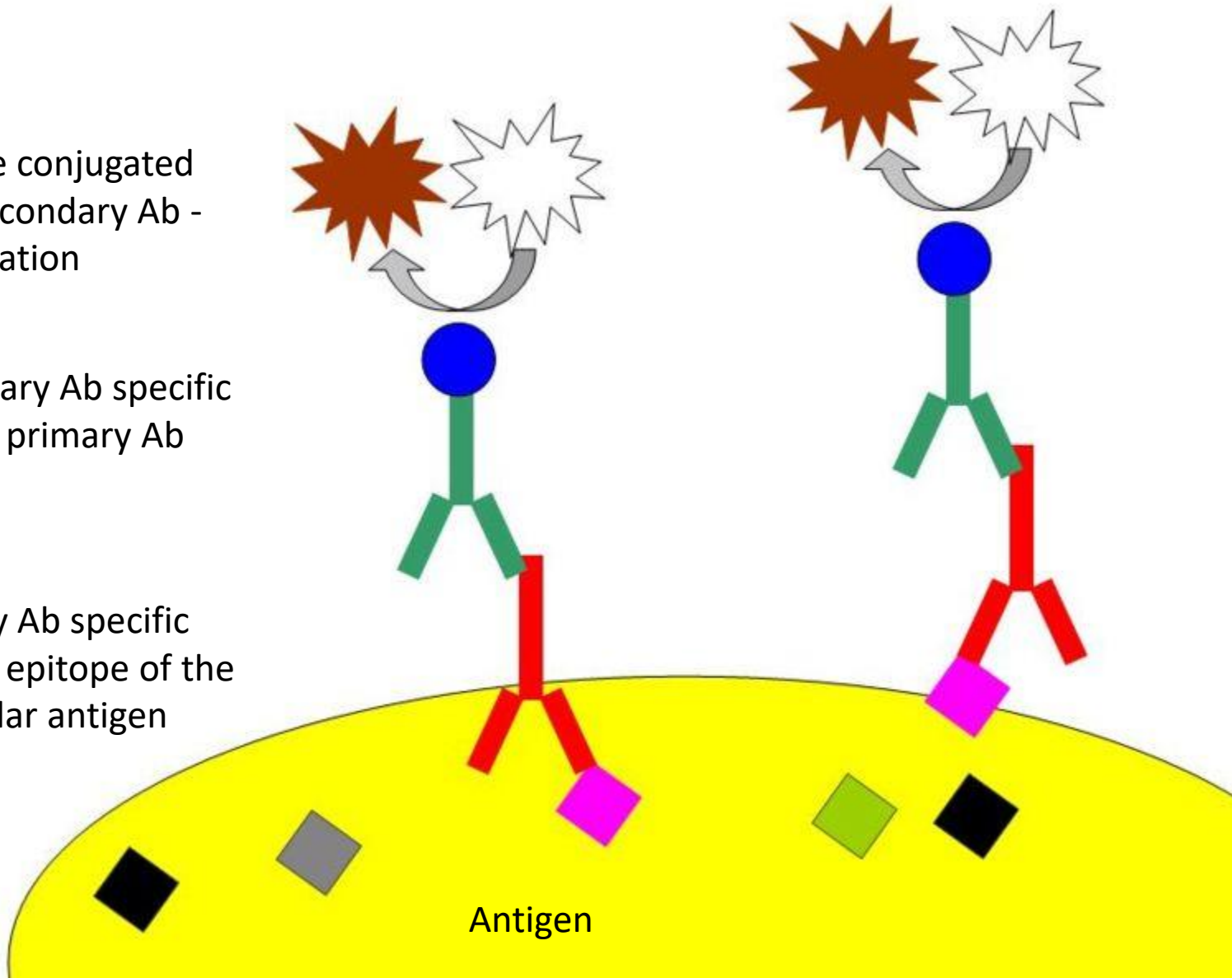

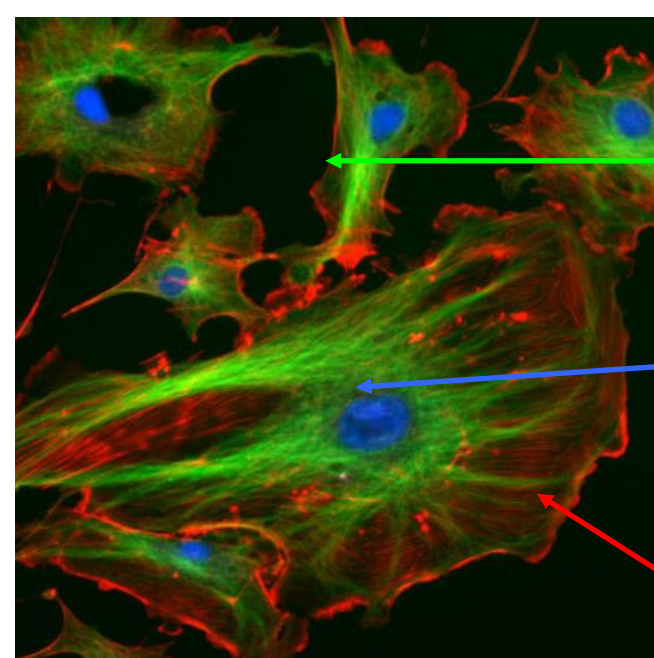

Actin (cytoskeleton)

DAPI (nucleus)

Microtubules (cytoskeleton)

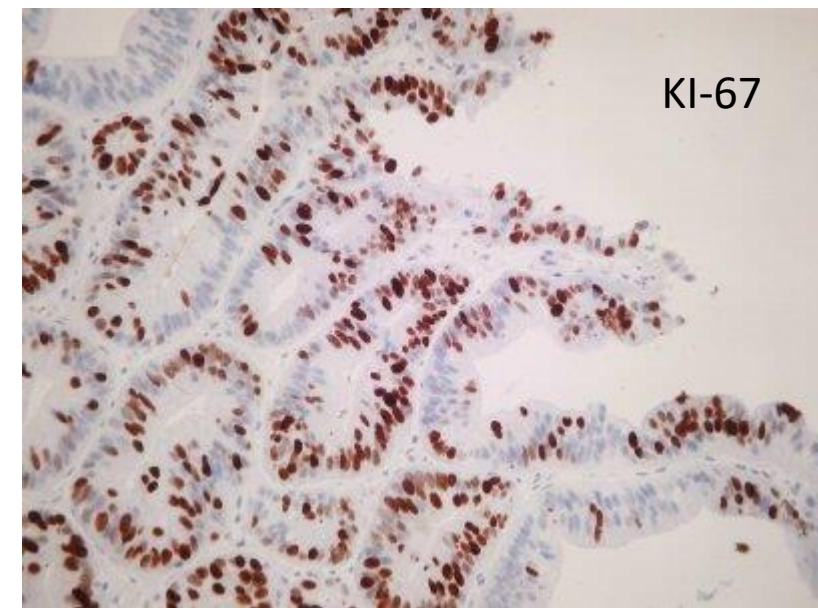
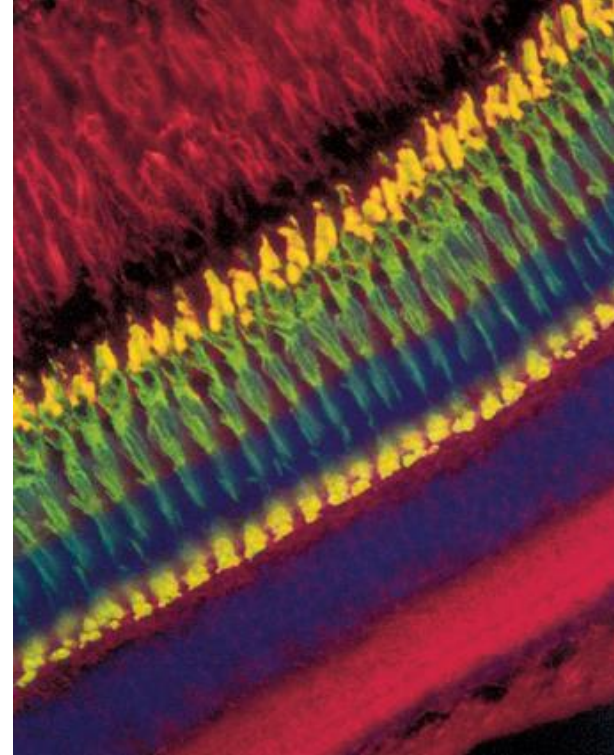

KI-67

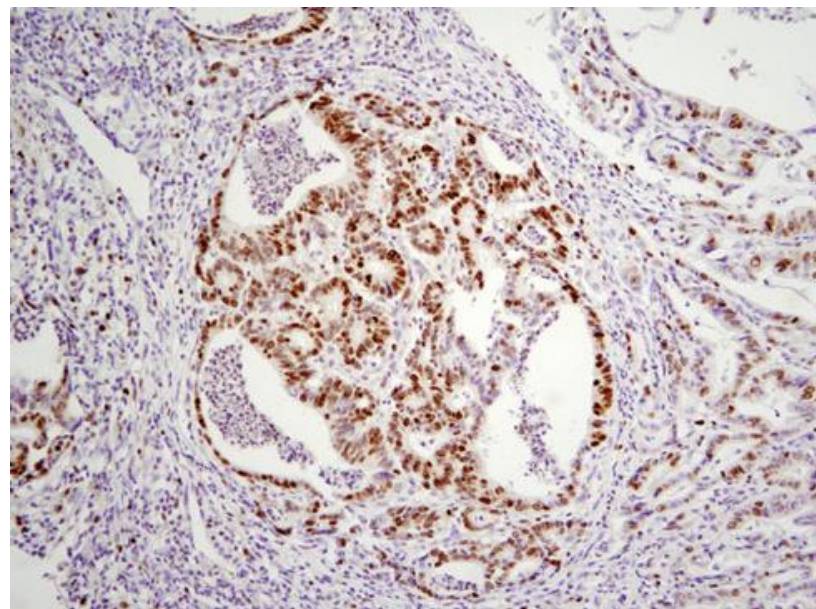

# In-vivo/live cell imaging

- US, MRI, PET...
- cells with fluorescent reporter

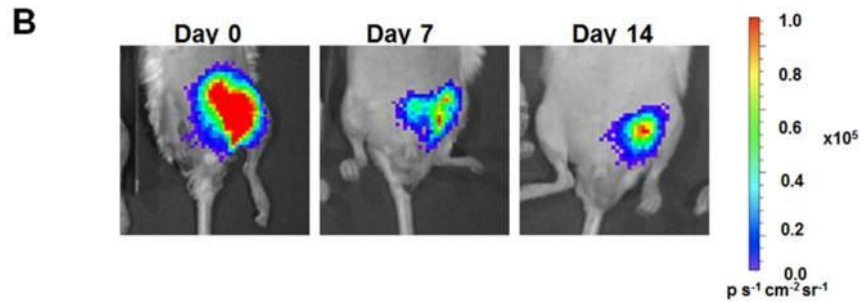
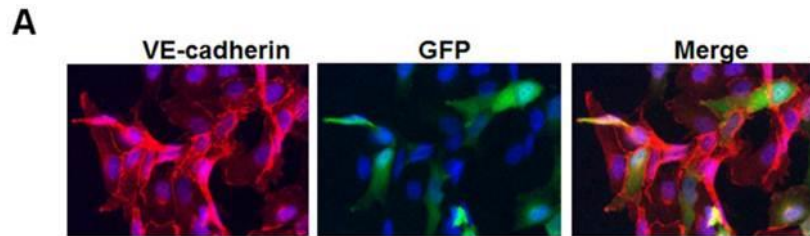

doi:10.7150/thno.3694

- FACS

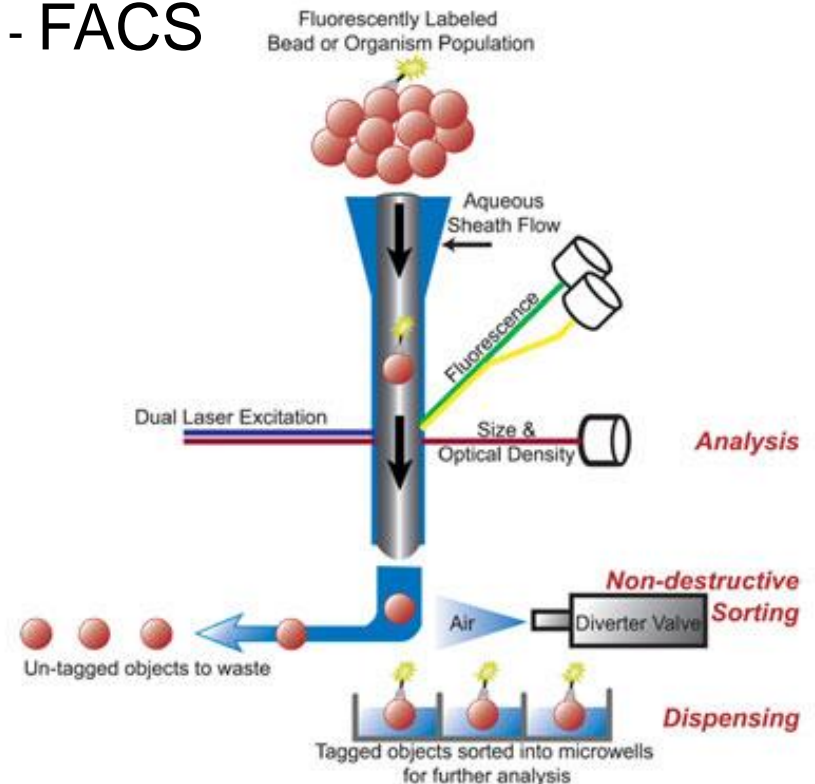



# Tissue processing for the EM



- pH of all solutions (media) must be buffered on **7.2 – 7.4**  
Cacodylate or phosphate buffer is frequently used.
- Absolutely dustfree environment
- Solutions (media) have to be precise (artifacts)

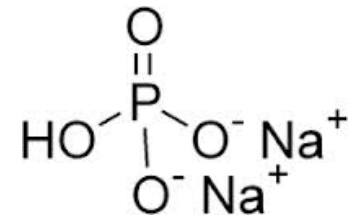
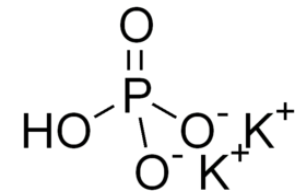
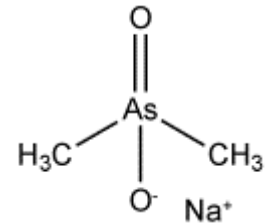

# Tissue processing for the EM

- **SAMPLING** – immediately after arresting of blood circulation, tissue block sized no more than **1mm<sup>3</sup>**
- **FIXATION** – **glutaraldehyde** (binds amine groups) + **OsO<sub>4</sub>** (binds lipids) are used as double fixation
- **RINSING** – distilled water
- **DEHYDRATION** - ethanol
- **EMBEDDING** – gelatin capsule or plastic forms are filled with some medium (which can be polymerized from liquid to solid form) and pieces of fixed tissue are placed into this medium. Epoxyd resins (Epon, Durcupan, Araldite) are usually used as in water insoluble media.
- **CUTTING** – ultrathin sections (in ultramictomes)
- **CONTRASTING** ≈ staining

Embedding tools:



gelatin (1) or plastic (2) capsules

capsule holder (3)

embedding plates  
(4, 5)

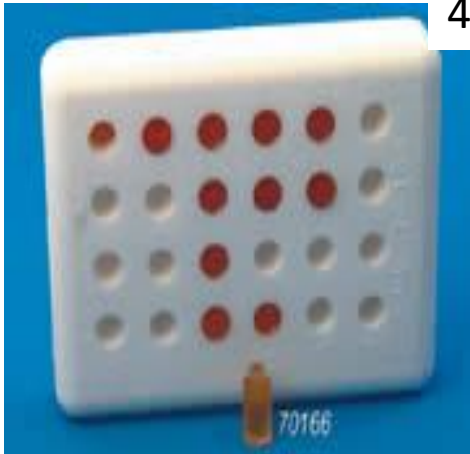

Embedded blocks  
prepared for cutting



# Trimming the Specimen Block

By trimming, using ultramicrotome, an excess of hard medium is removed and pyramide with minimal cut surface (0.1 mm<sup>2</sup>) is prepared.

*Minimum of tissue (black) is in the top of pyramid*

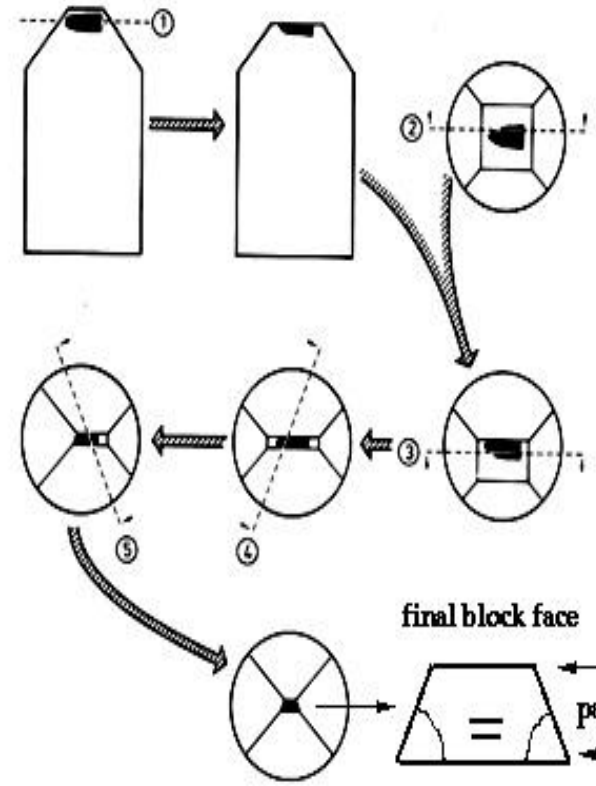
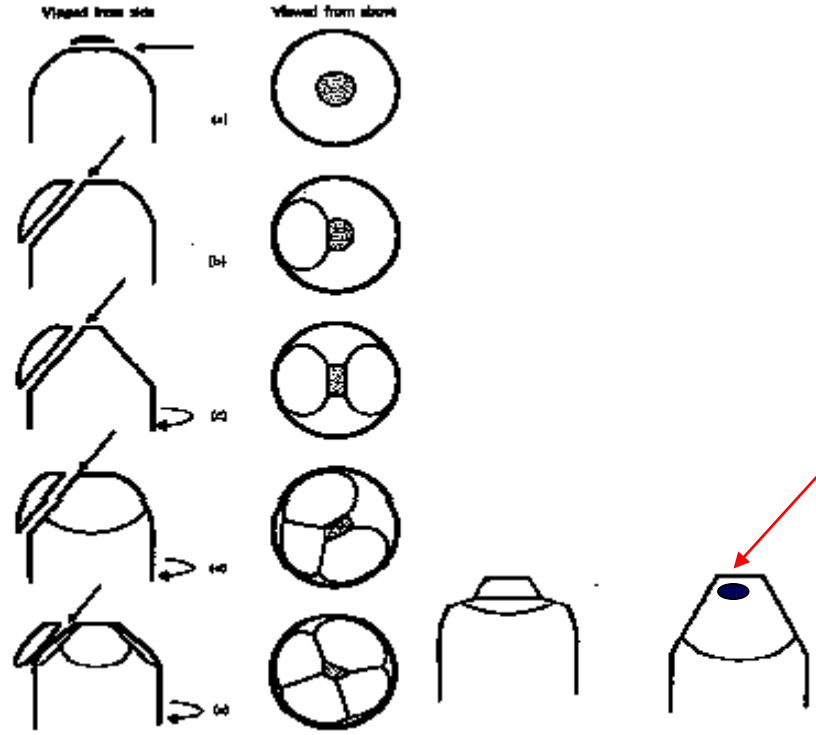

## Pyramid Side Profile



Too Steep-Trans Am Building (not rigid-vibrations)



Too Flat-Pyramid of the Sun (section size changes rapidly)



Just Right-Egyptian Pyramid with top cut off





# Cutting

Ultrathin sections (70 – 100 nm) - ultramicrotomes.

Glass or diamond (b) knives with water reservoir are used

Sections slide flow on water in small container attached to the knife

Supporting grids



# Ultramicrotom knives:

glass

diamond

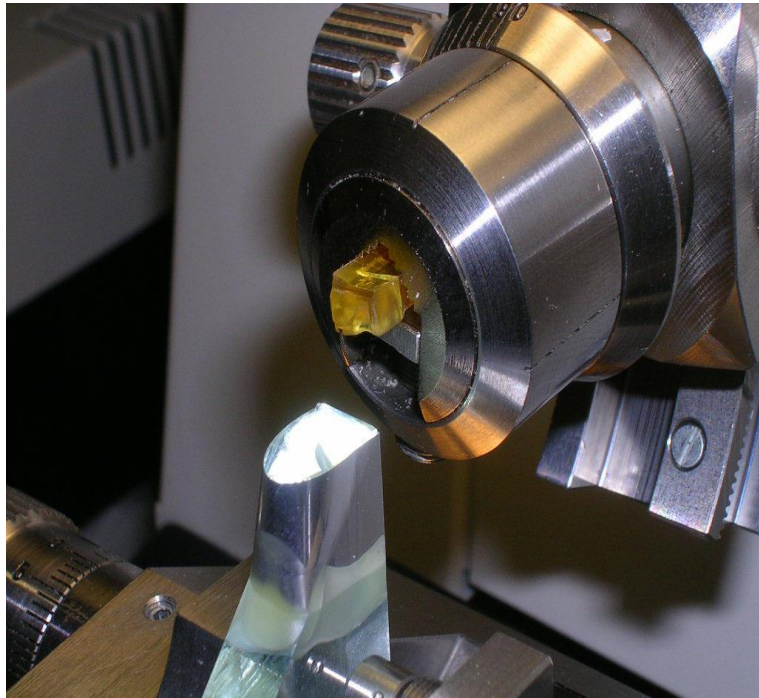

# Cutting

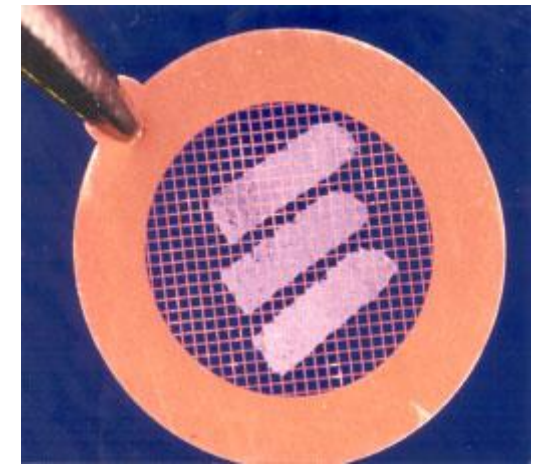
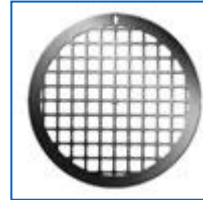
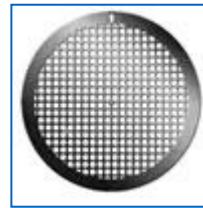
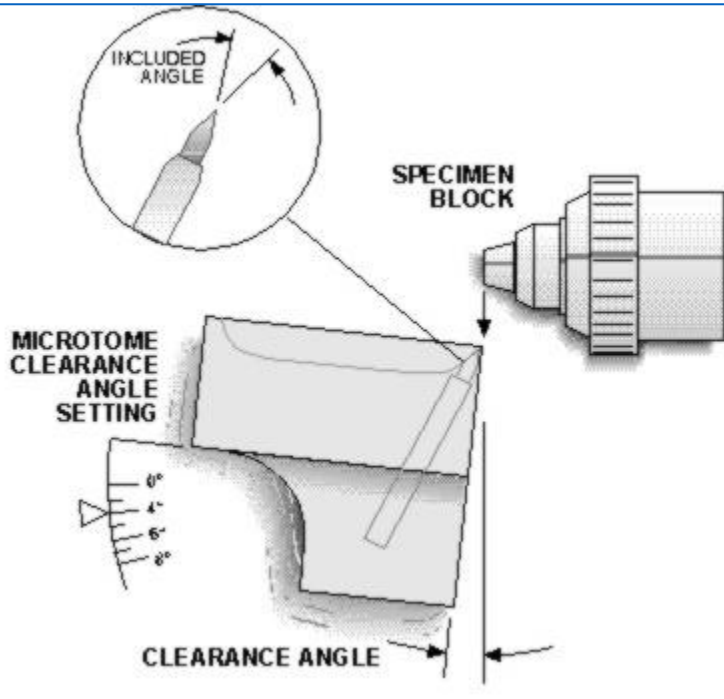

## Grid Types and Mesh Sizes

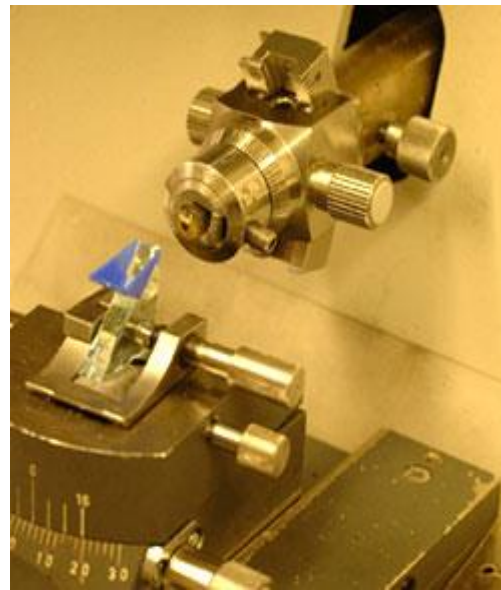
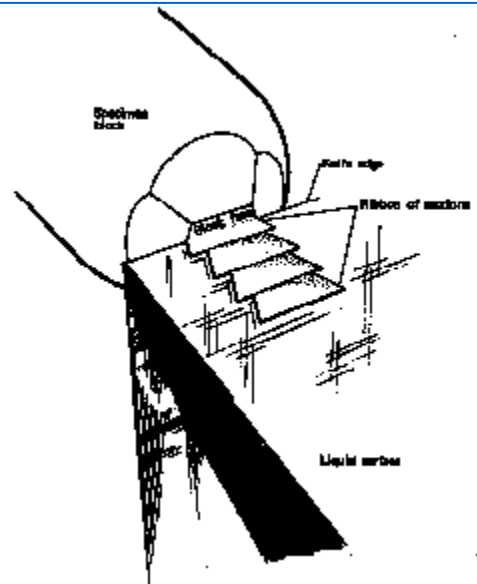
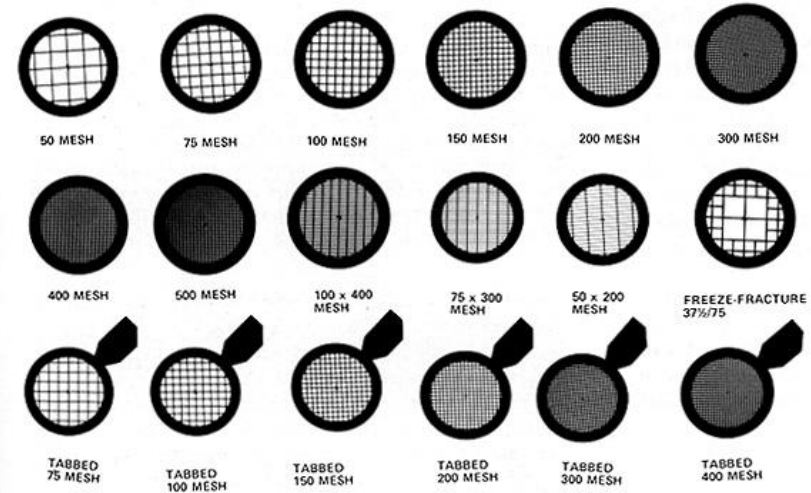

# CONTRASTING (=STAINING)

- principle of differentiation of structures – different dispersion of beam of electrons depending on atomic weight of elements.  
„electron dyes“ are thus mixtures of heavy metals: uranylacetate or lead citrate

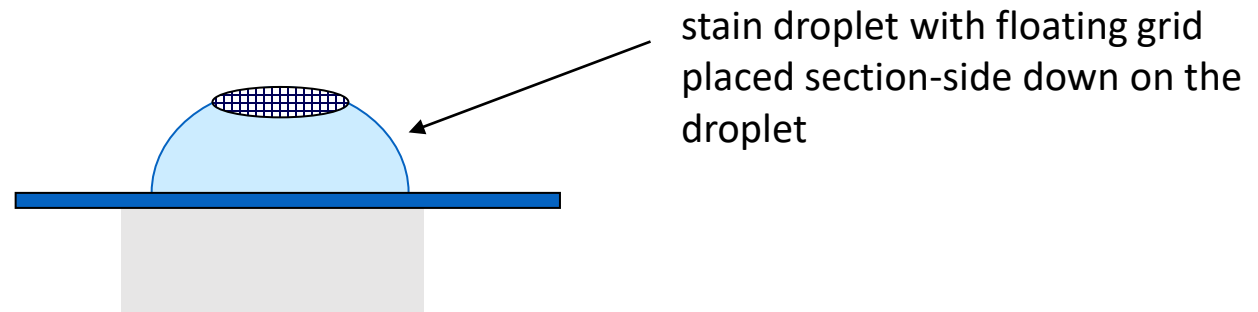



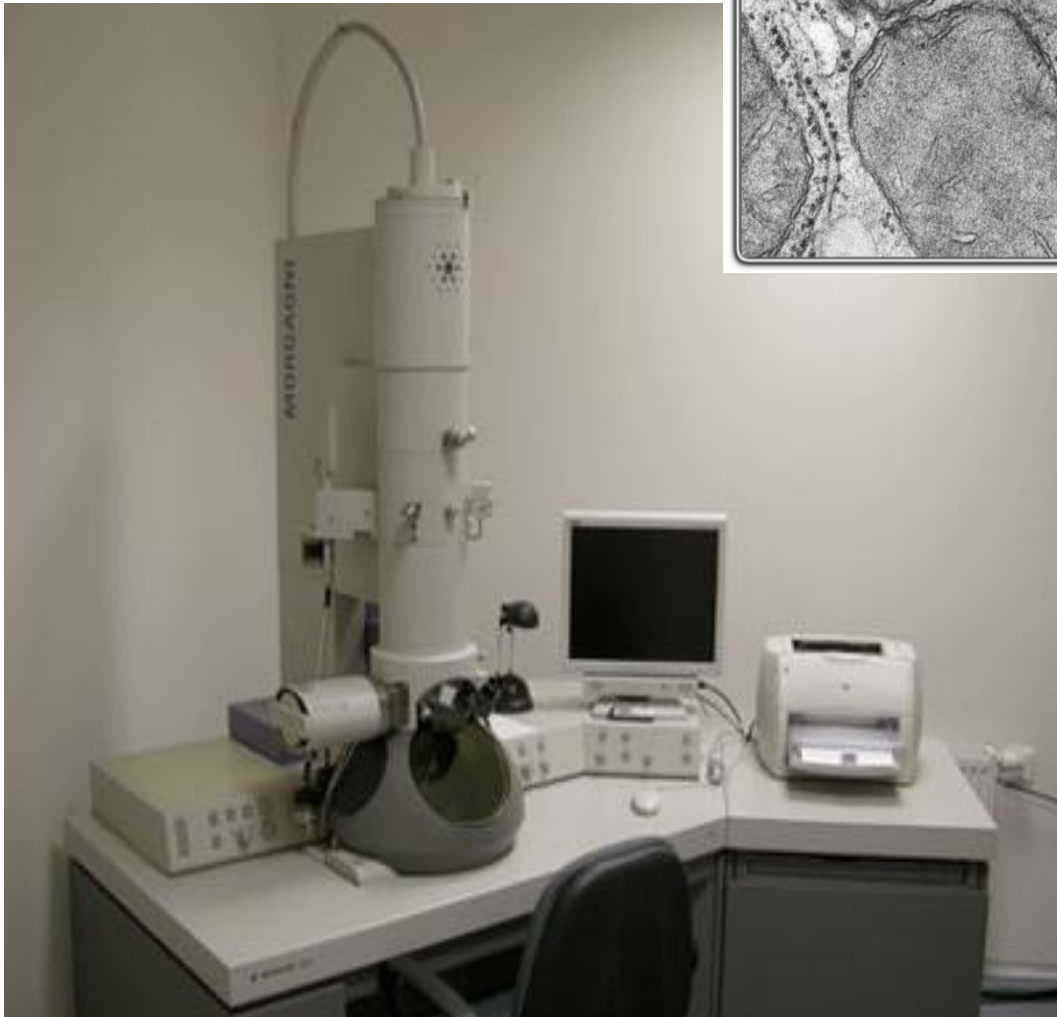
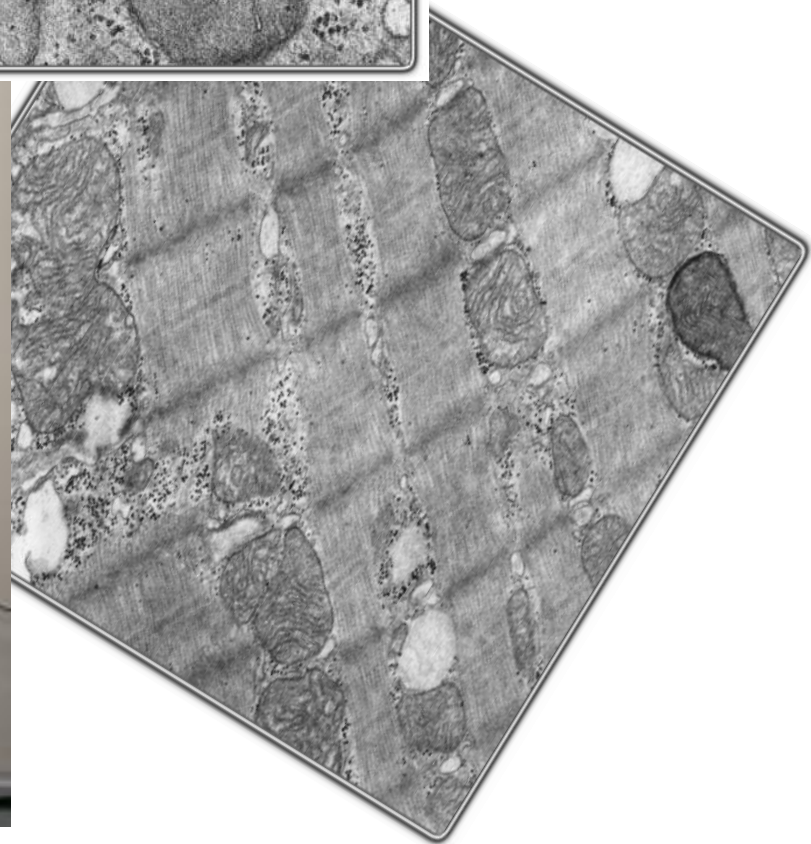
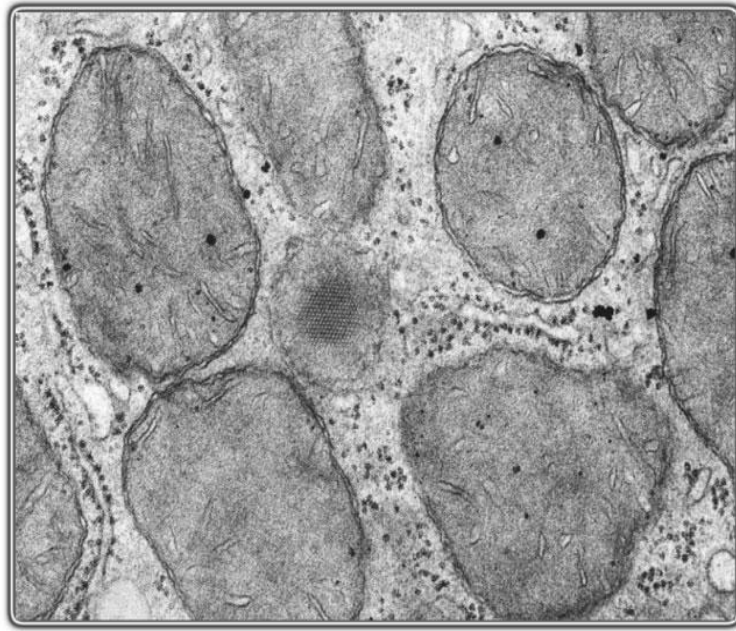

Differences between LM and EM		
	LM	EM
Sampling	< 1 cm <sup>3</sup> minutes	< 1 mm <sup>3</sup> seconds
Fixation	formaldehyde 12 – 24 hours	glutaraldehyde 1 – 3 hours
Embedding	paraffin	epoxid resins (Durcupan)
Cutting Thickness of sections	microtome 5 – 10 μm	Ultramicrotomes 50 – 100 nm
Staining (LM) contrasting (EM)	dyes ( <i>hematoxyline – eosin</i> )	heavy metals ( <i>uranylacetate, lead citrate</i> )
Mounting (only LM)		---
Result	histological slide (preparete)	photograph of ultrathin section

# Visit us at:

<http://histology.med.muni.cz>

MASARYK UNIVERSITY

**MUNI** Department  
**MED** of Histology  
and Embryology

[Home](#) [Education](#) [Research](#) [Projects](#) [Publications](#) [Instrumentation](#) [Contacts](#)

**Department of Histology and Embryology**

Faculty of Medicine, Masaryk University

EDUCATION

RESEARCH

## Interactive syllabus IS MU

**MUNI**

is > Teacher's Notebook > Interactive syllabi > Histology and embryology I - practice #

Interactive Syllabus



doc. RNDr. Petr Vanhara, Ph.D.  
Histology and embryology I - practice

History and embryology I - practice

STUDY NOW  
Week 1

- Week 2
- Week 3
- Week 4
- Week 5
- Week 6

# Thank you for attention