

Poranění HKK

Klinika úrazové chirurgie FN Brno

VLCH11Xpp

Klíční kost

- časté poranění mladých aktivních
- pády na nataženou končetinu, pád na rameno, náraz na rameno

- povrchové uložení kosti
- diafýza, laterální konec, mediální

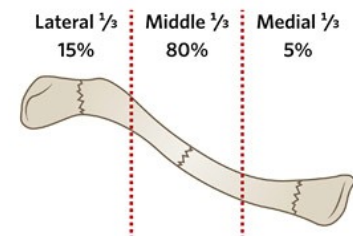

© The Royal Children's Hospital, Melbourne, Australia



MECHANISM OF INJURY

a) Fall with arm out, onto hand.



b) Fall onto shoulder.



c) Direct blow to shoulder.



- RTG – AP + snímek 45 st kaudální sklon - předozadní dislokace

- Konzervativní terapie
- Nedislokované, minimálně dislokované zlomeniny,
- Ramenní ortéza / klíčková ortéza 4-6T



- ROM po 4T

- Indikace OS
- Zkratek >18mm
- Dislokace > 100%
- Kominuce
- NV poranění
- Otevřené zlomeniny, napínání kůže



OS

- Dlahá
- Pin



- Ortéza / závěs 2-3T
- Posilování od 6 T
- Plná silová zátěž >3M

• Akromioklavikulární dislokace

- Přímý mechanismus/nepřímý mechanismus
- Muži 2. dekáda
- Vyšetření klinicky – prominence klíčku
- Piano key sign
- Dg: RTG

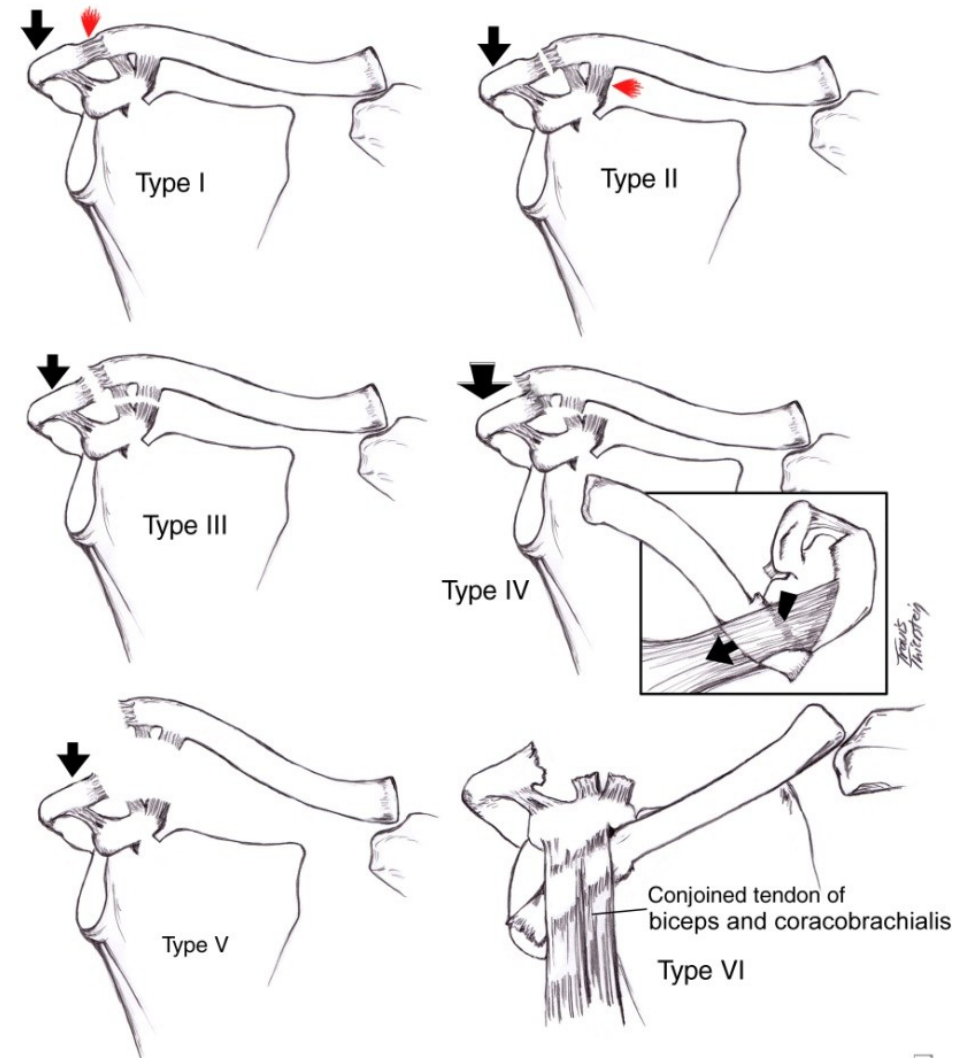
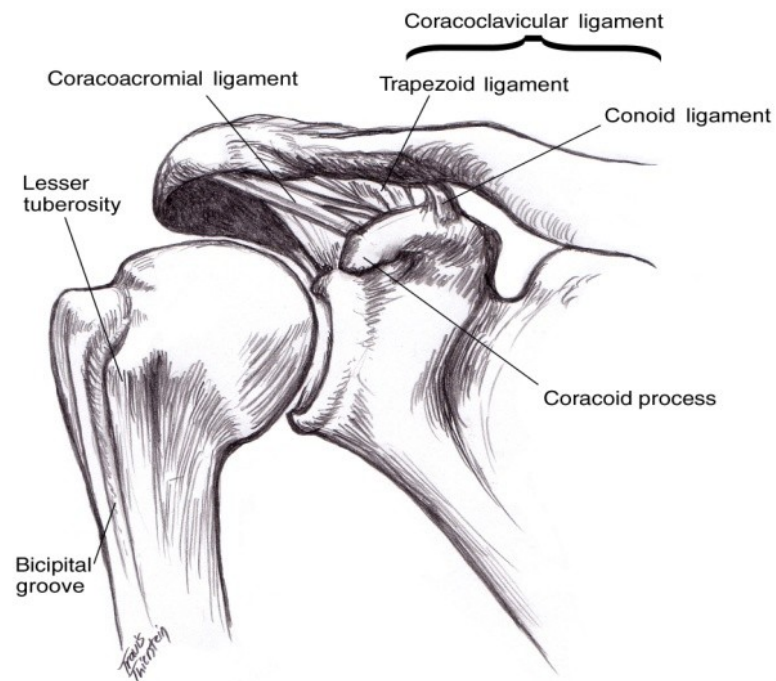

- Léčba

- Type I, II – konzervativně
- Type III – kontroverze
- Type IV, V, VI - operační

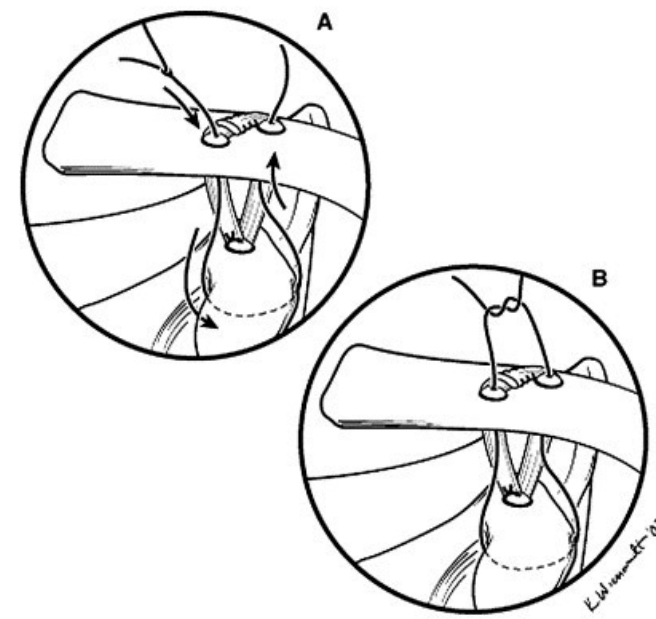
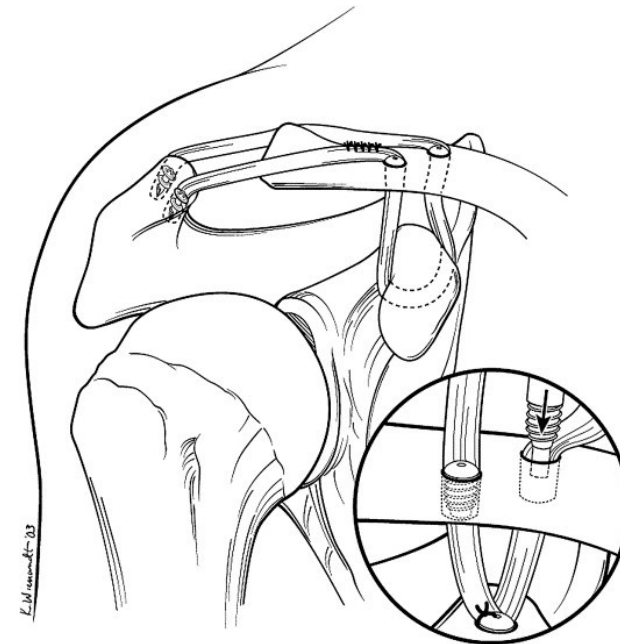
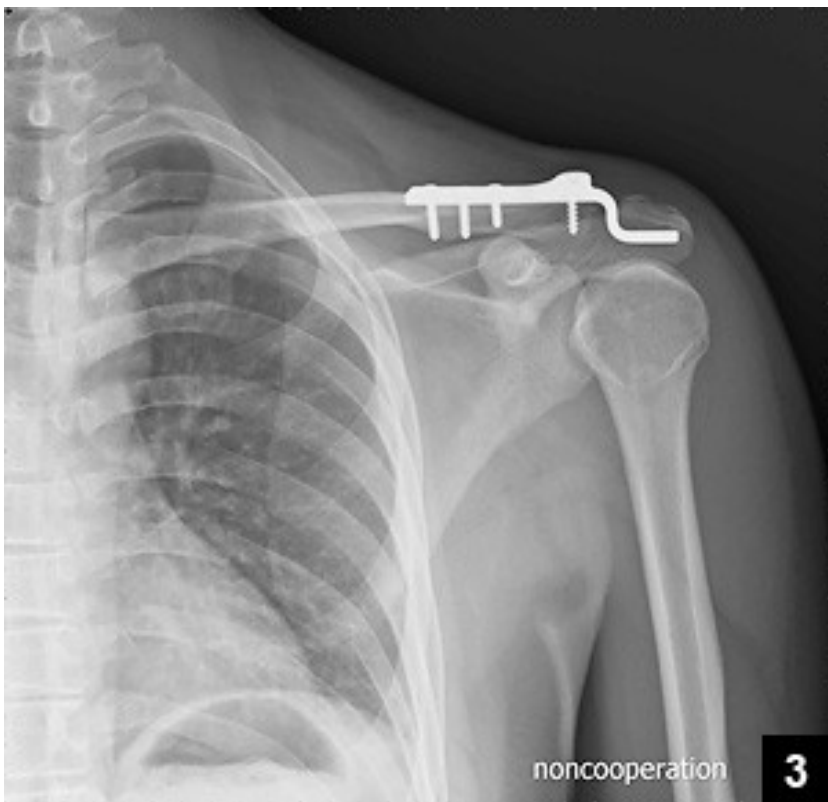

- Dislokace GH kloubu

- Přední > 95 % dislokací
- **Zadní** < 5 %
- Inferiorní/Erecta < 1%
- **Habitualní** – netraumatická – multidirekcionální nestabilita

- Pád na abdukovanou extendovanou končetinu
- Přímý náraz zezadu/zepředu/elektrický proud

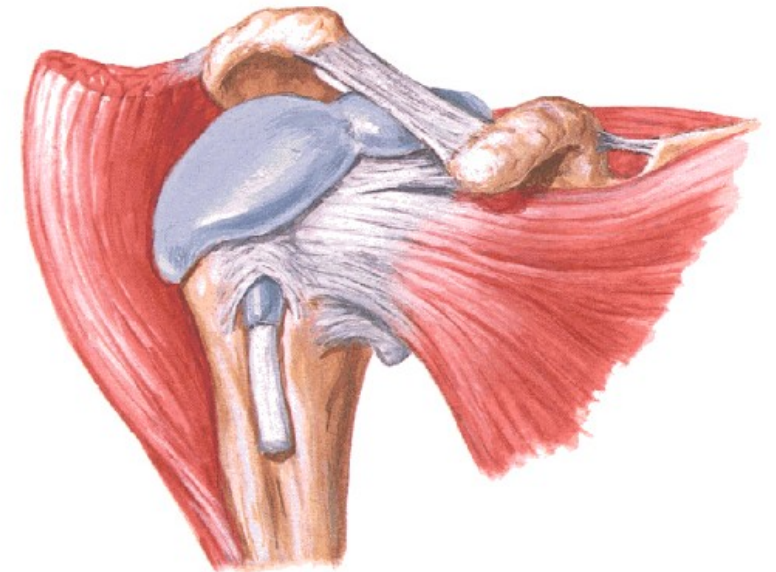
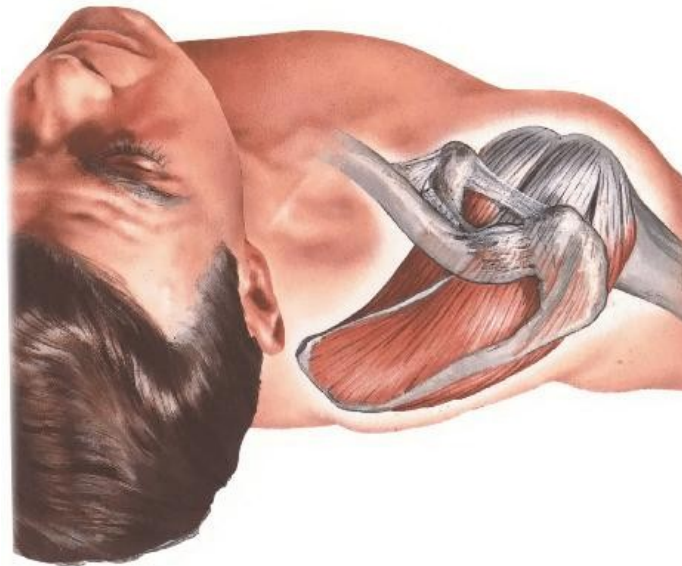
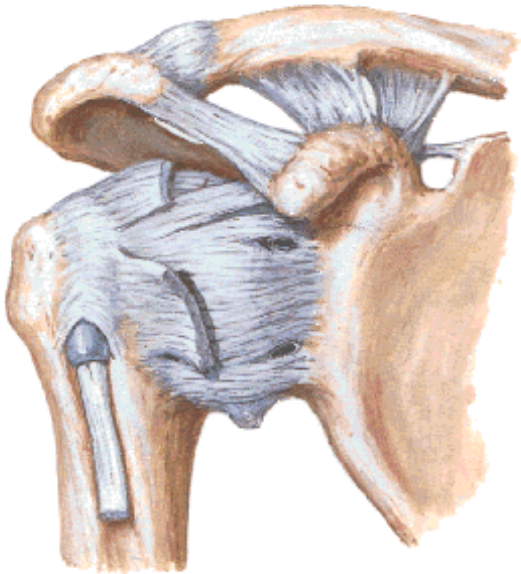

- **Diagnóza**

- Klinické vyšetření
- Zobrazovací metody

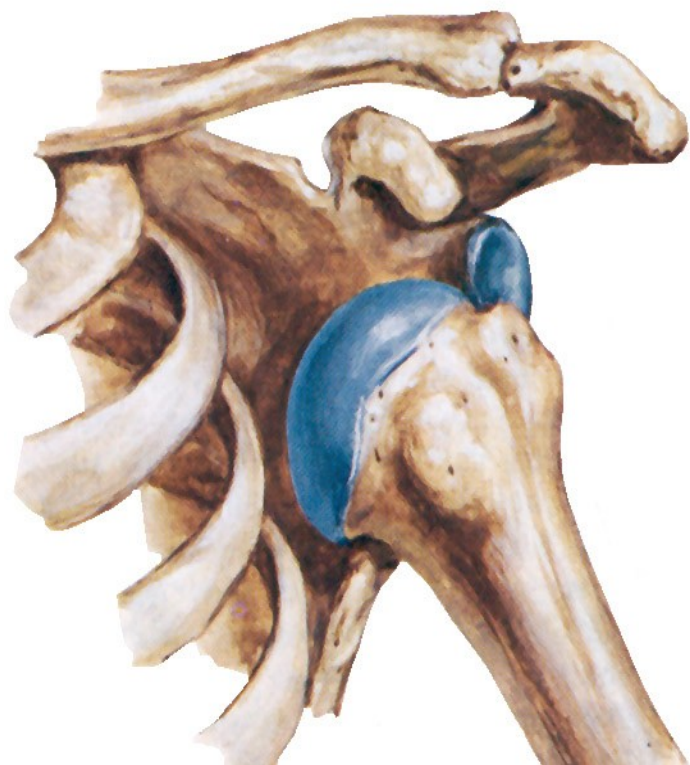

- Léčba
- akutní repozice
- následně imobilizace 2-3 týdny

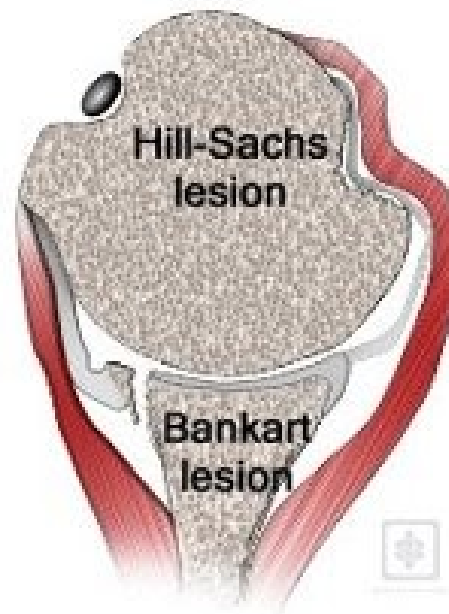
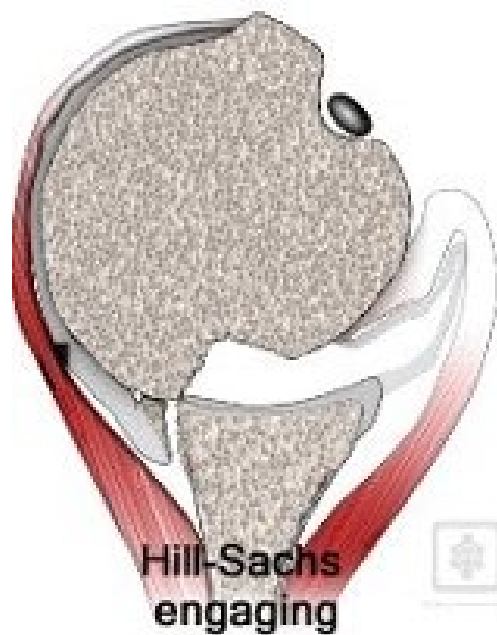
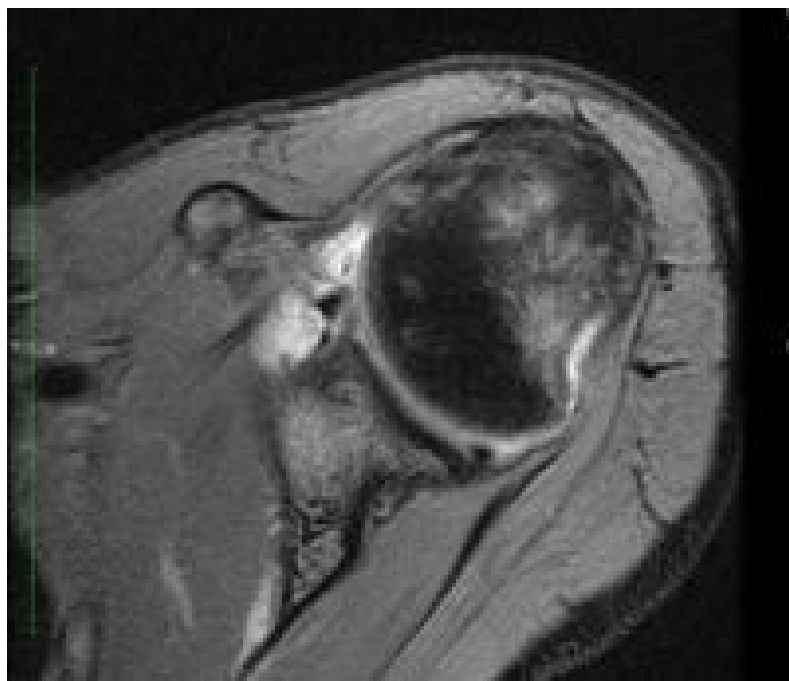

A SLAP tear occurs where the biceps tendon anchors to the labrum.

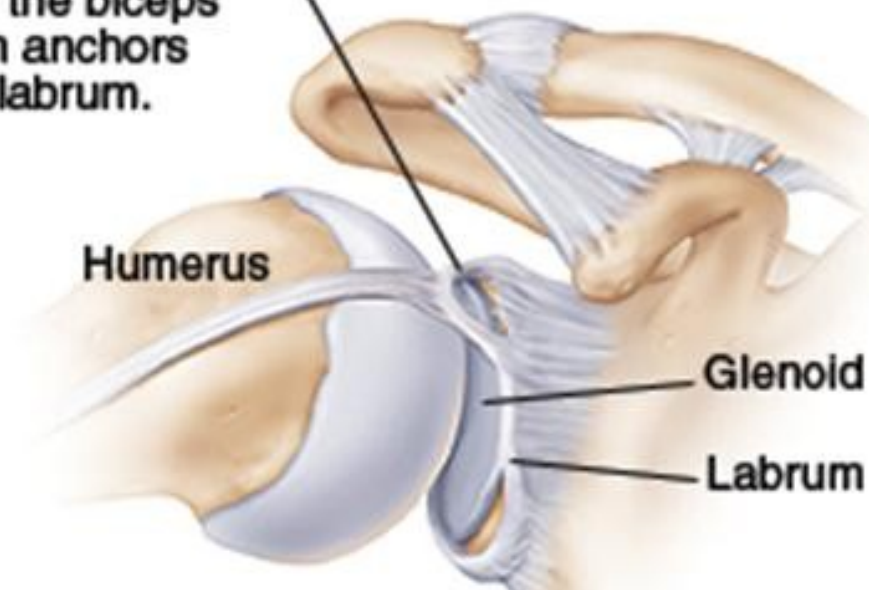

- **Techniky repozice**

- **Hippocrates Method, Stimpson's technique, Kocher's technique, Arlt technique**

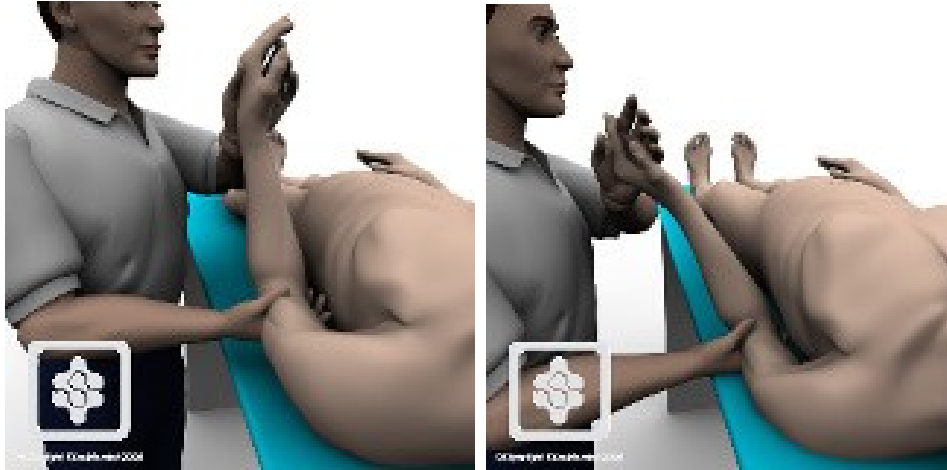

- Operační stabilizace

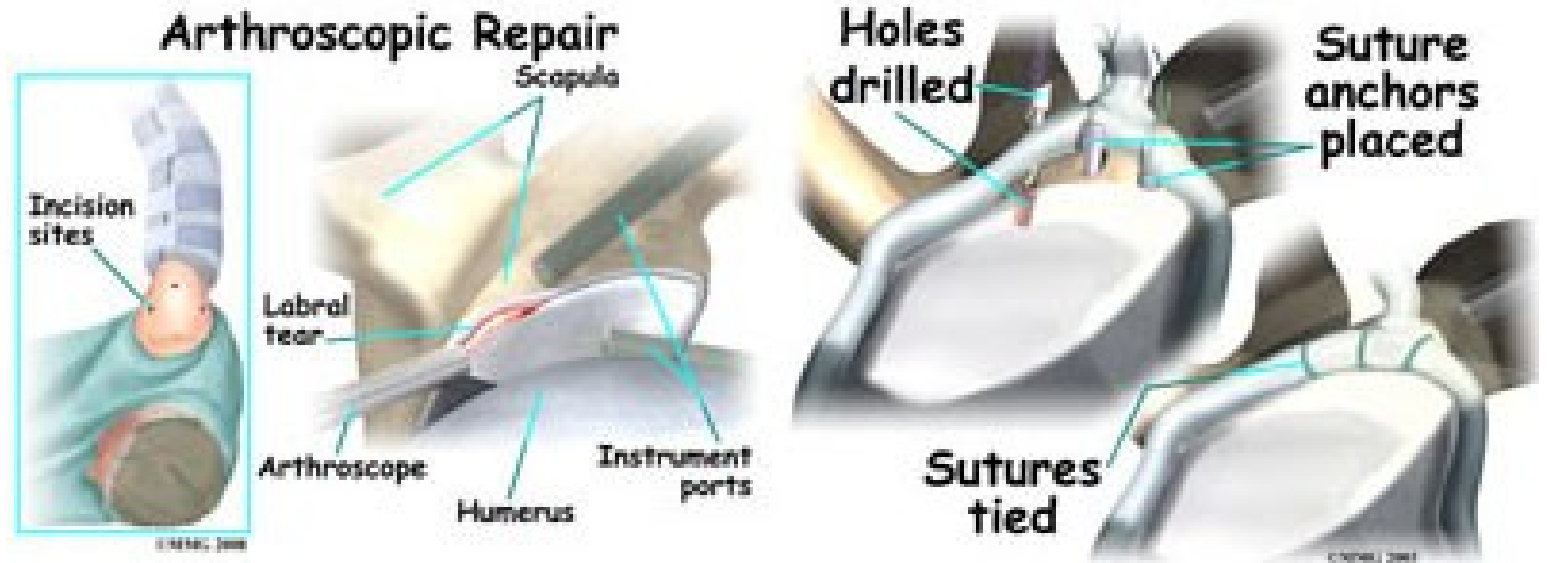

Bankart Repair

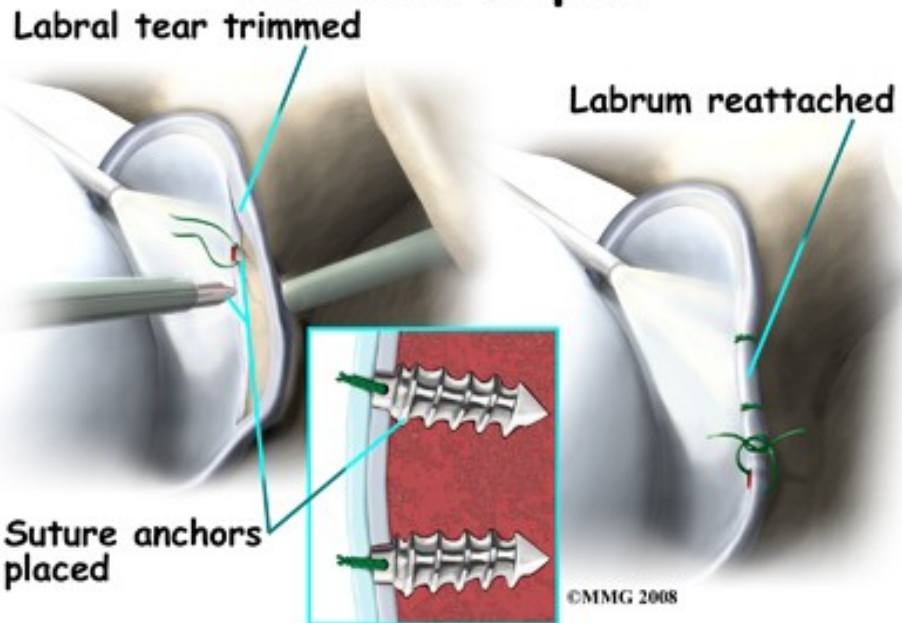

Zlomeniny proximálního humeru

- Bimodální frekvence
- Mladí - high energy, tříštivé
- Staří – low energy

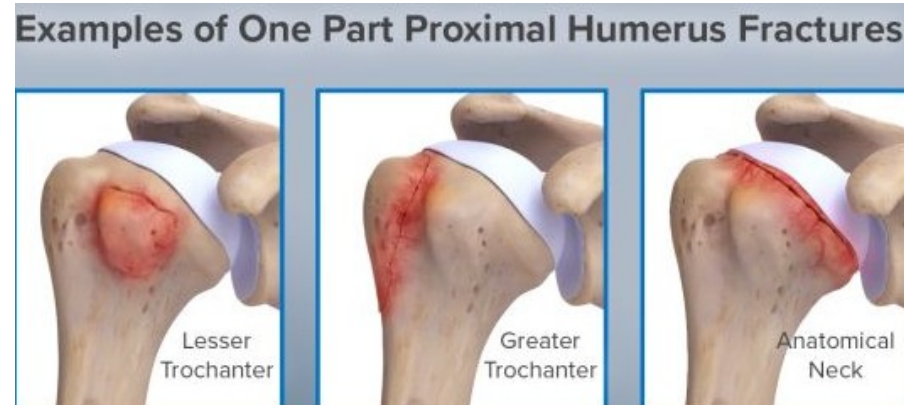

- 4 komponenty: chirurgický krček, anatomická krček, velký a malý hrbol
- Úpony RM

- RTG – AP + bočná
- CT

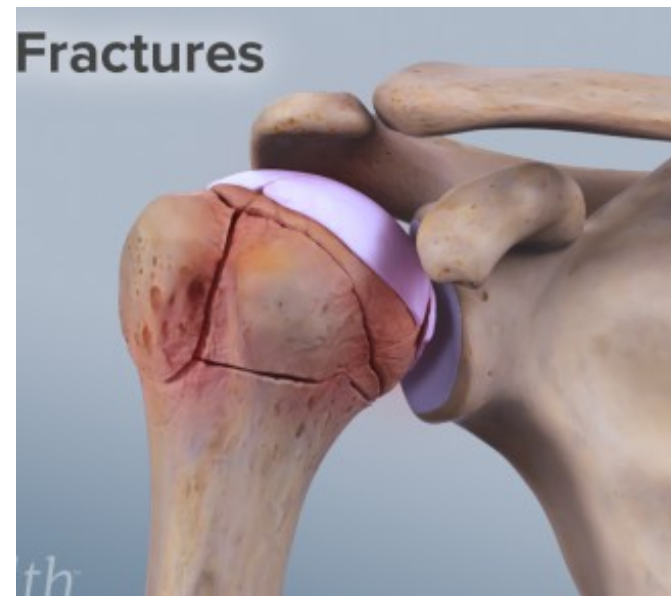

- Konzervativní léčba - cca 80% - nedislokované/ málo dislokované zaklíněné fr., nízce nárokový pac.
- 2-3T ramenní ortéza, 2T závěs
- RHB



Operační terapie

- Dislokace > 1cm, angulace >45st
- Kvalita kosti – osteoporóza >60 let – skořápka vajíčka

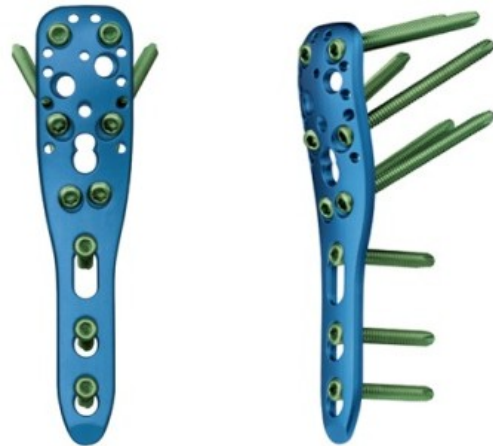

- LCP
- IM hřeb
- Hemiartroplastika - CKP

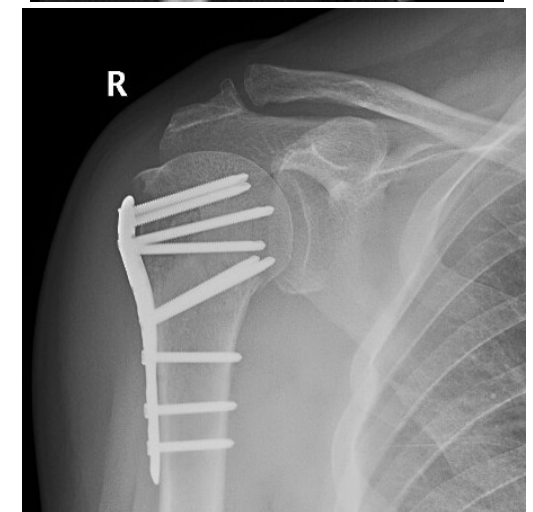
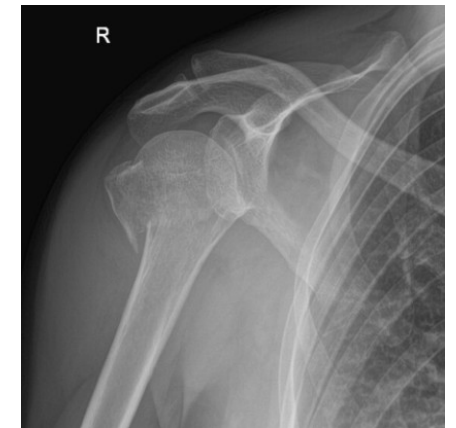



Diafýza pažní kosti

- RTG – AP + bočná
- Vysoký rozsah pohybu aGH
- Konzervativní ter
- <20st angulace
- <30 st varus/valgus angulace
- <3cm zkratek

Humeral Shaft Fractures

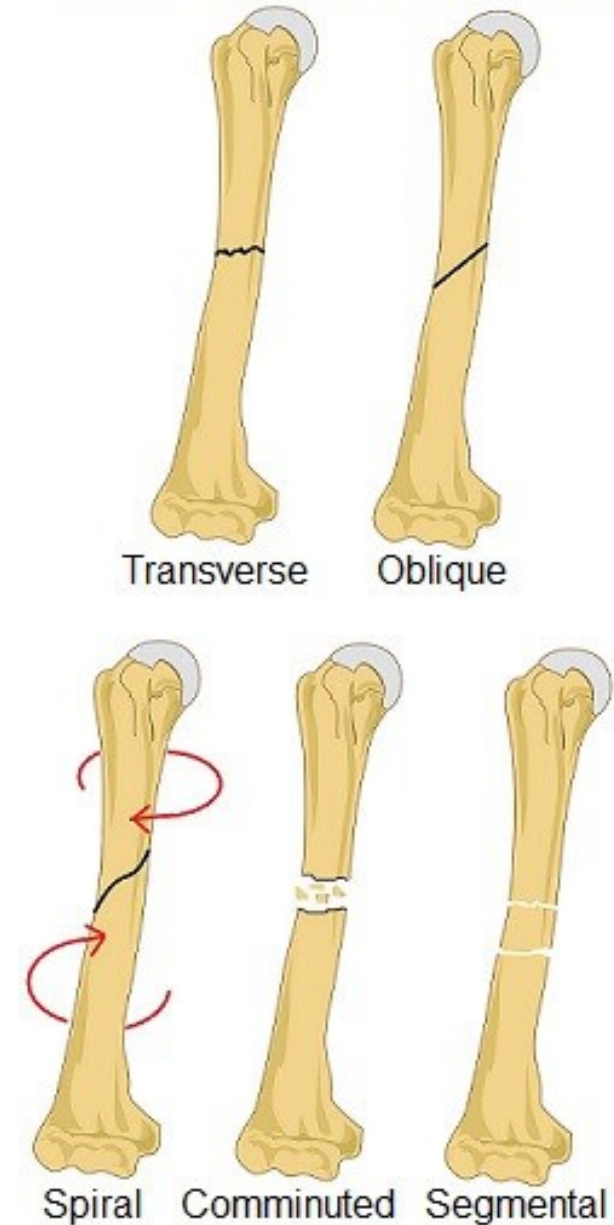

- Ramenní ortéza, vysoká sádrová dlahá, U splint
- Brace, (hanging část)
- 3T + brace 3-4T

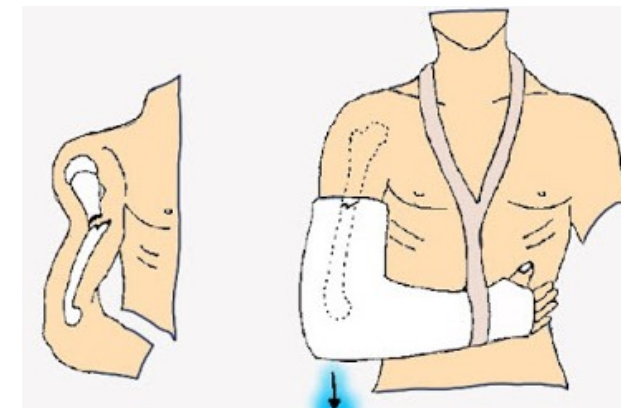
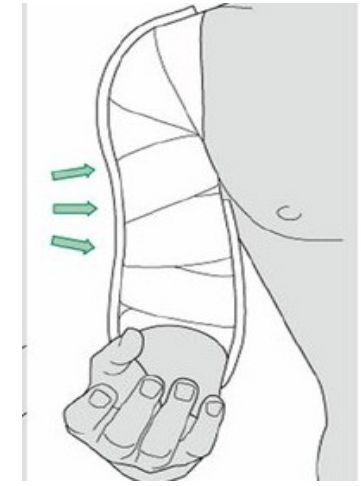

OS

- IM hřeb
- LCP /P1
- 4-6T PROM

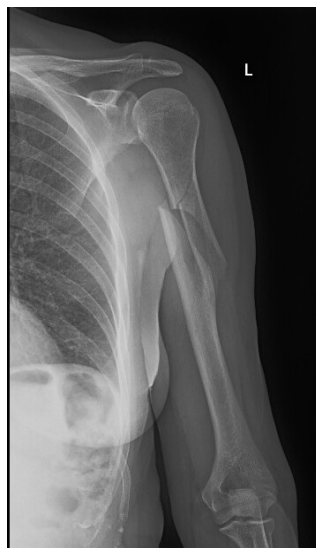
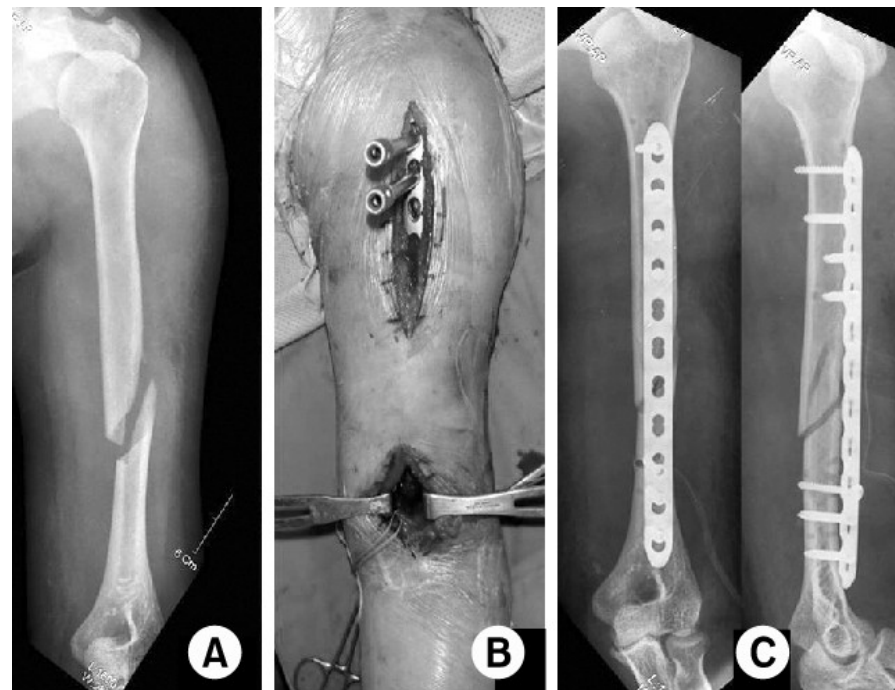

Distální humerus fraktury

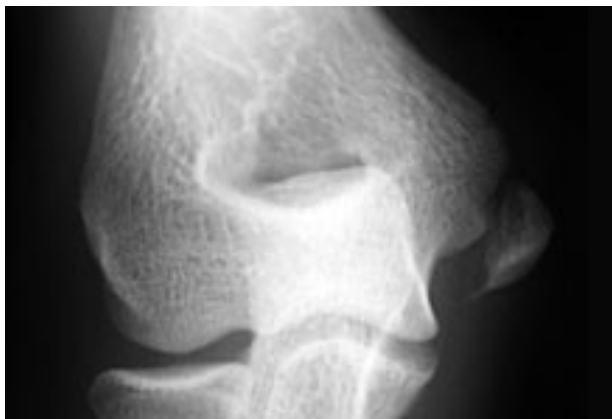
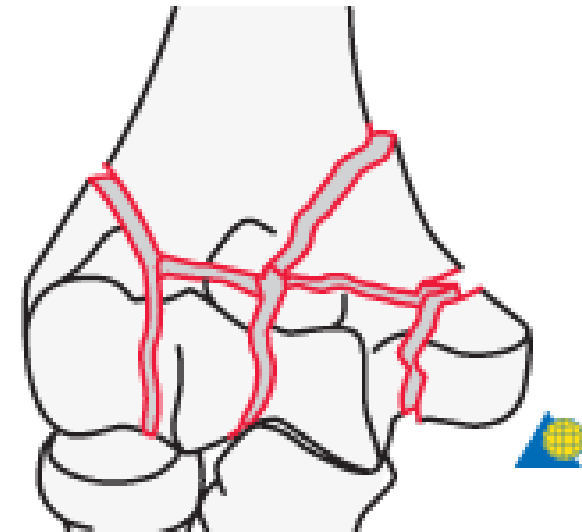
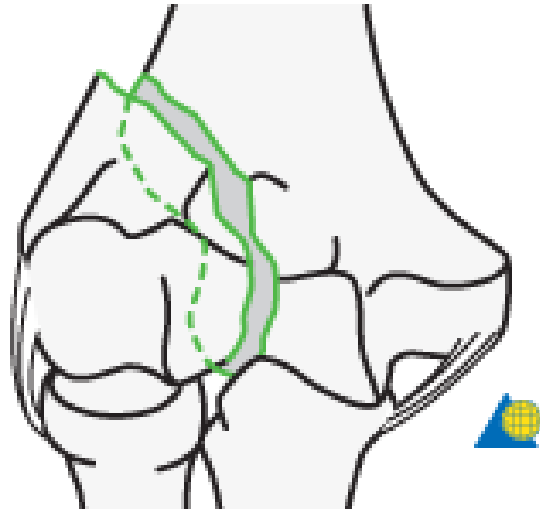
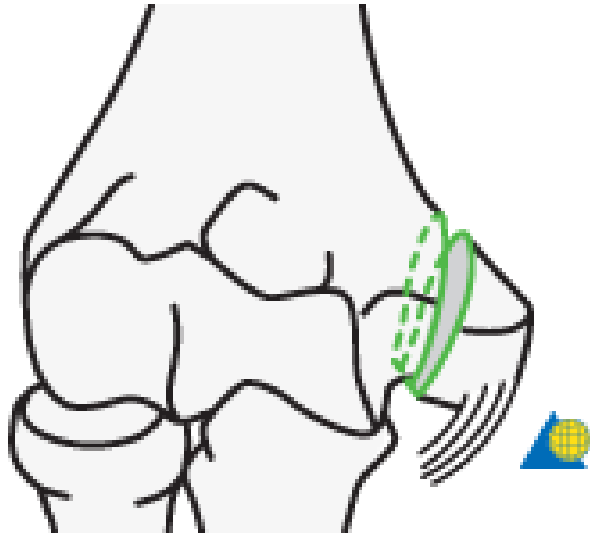

Konzervativní léčení

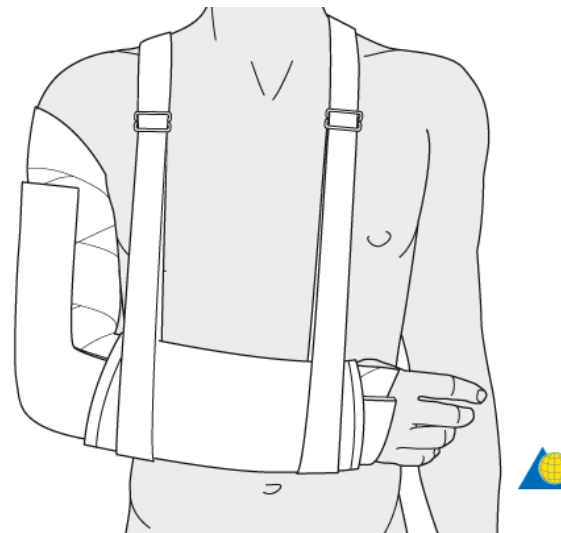
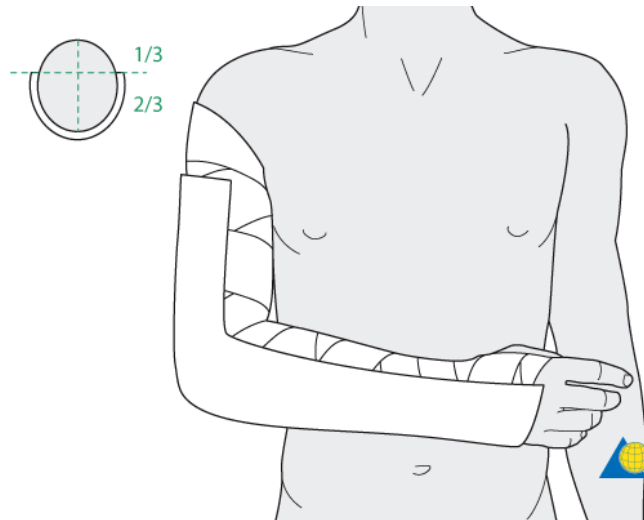
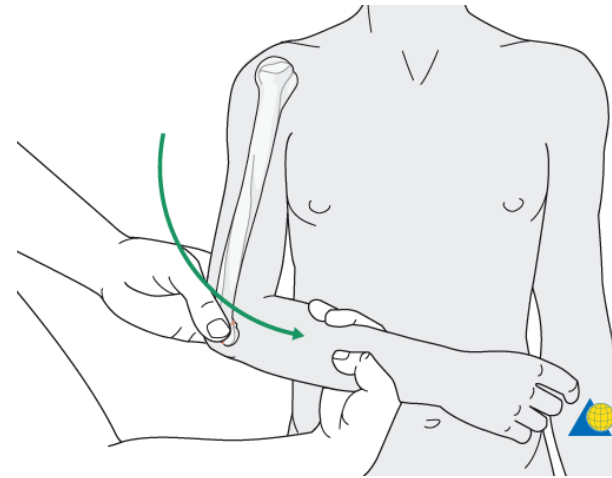
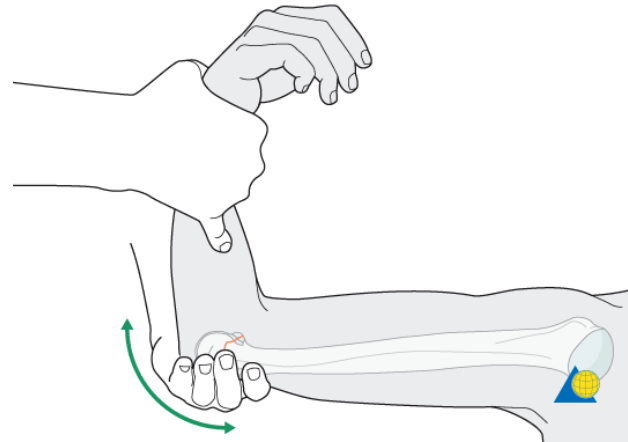
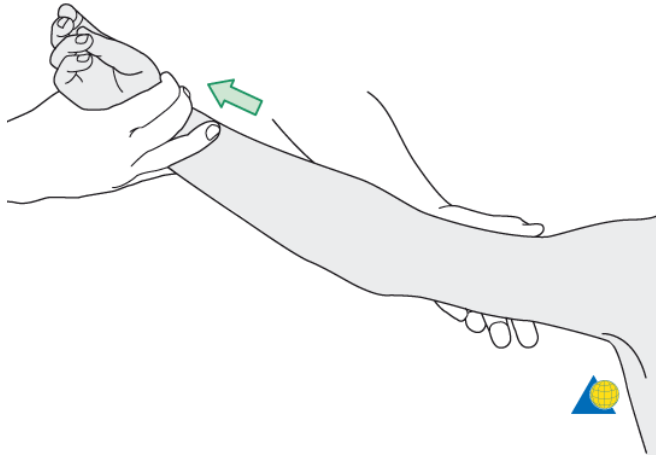

Operační léčení

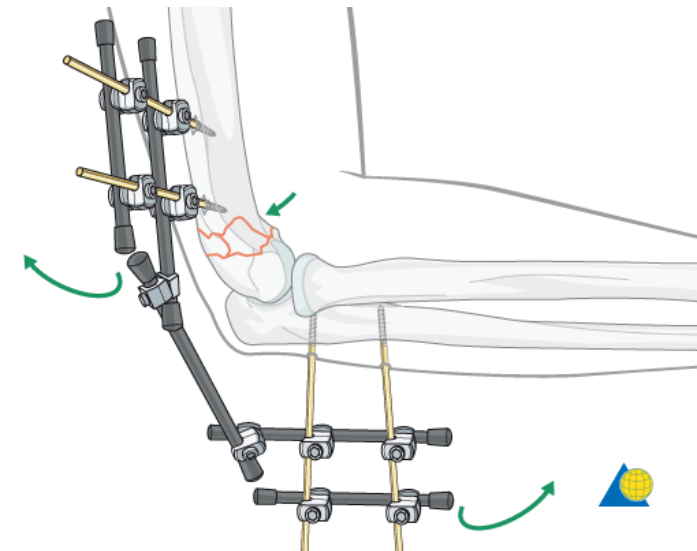
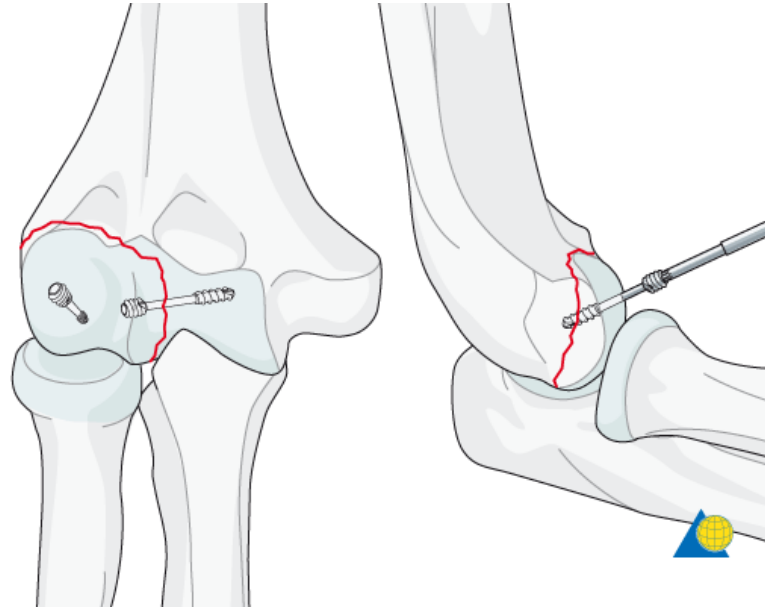
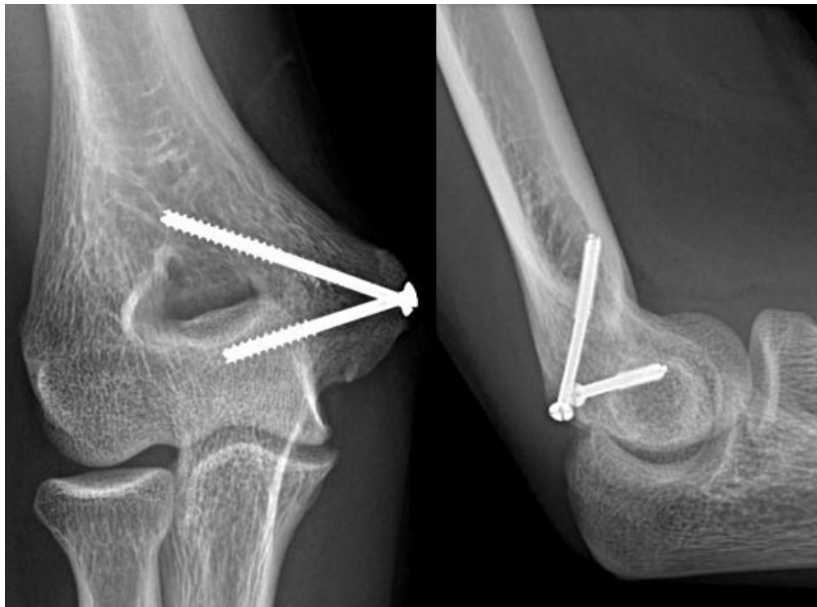
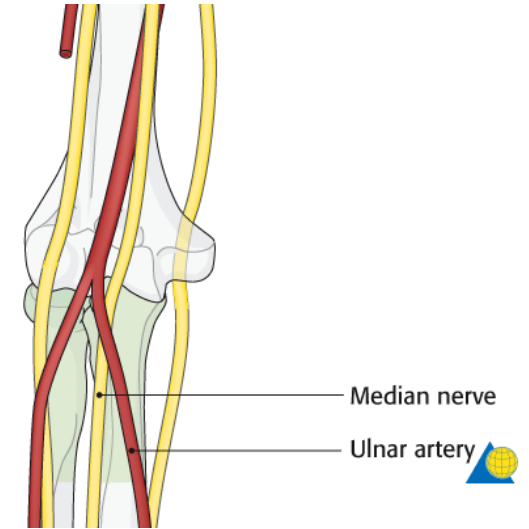
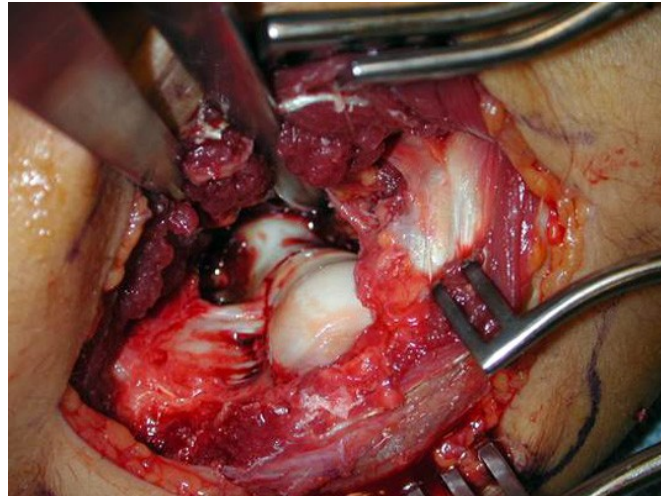
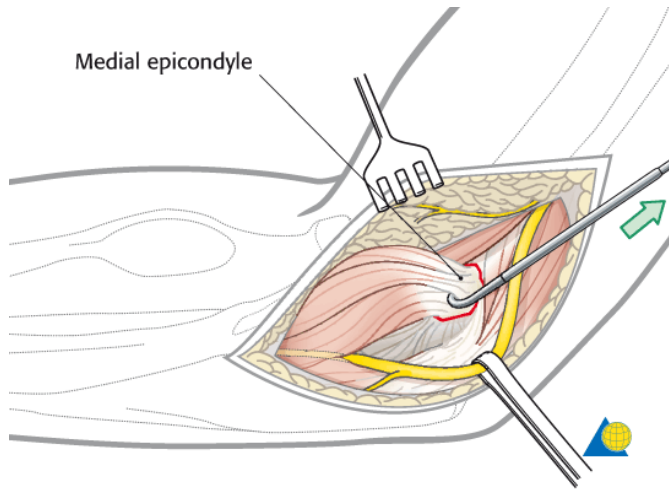

Operační léčení

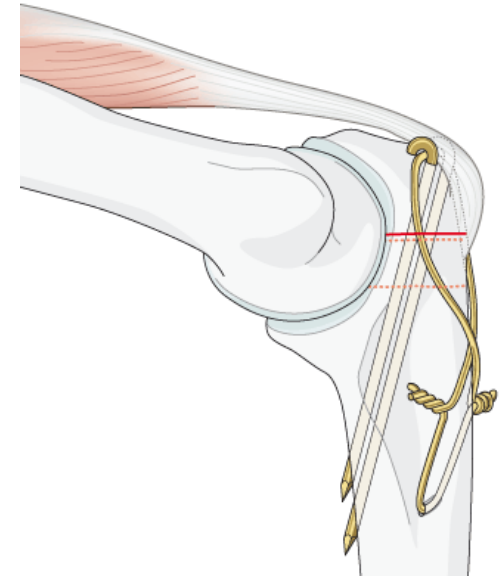
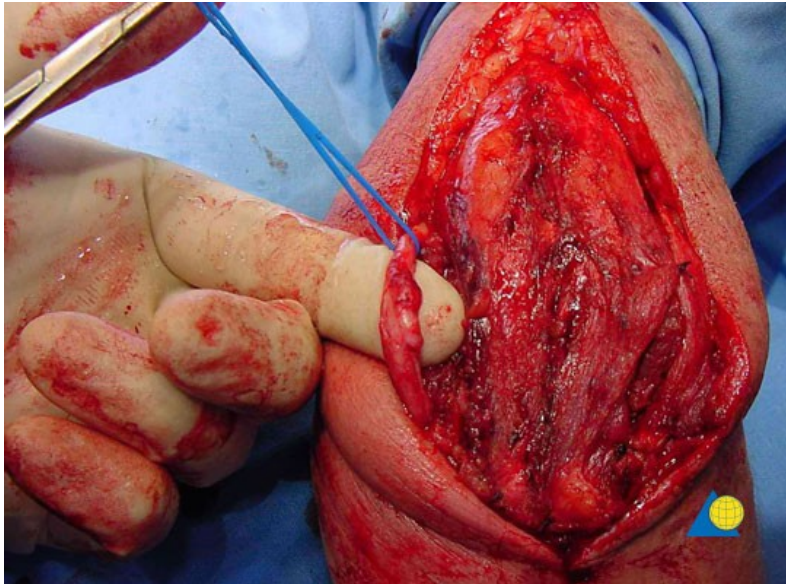
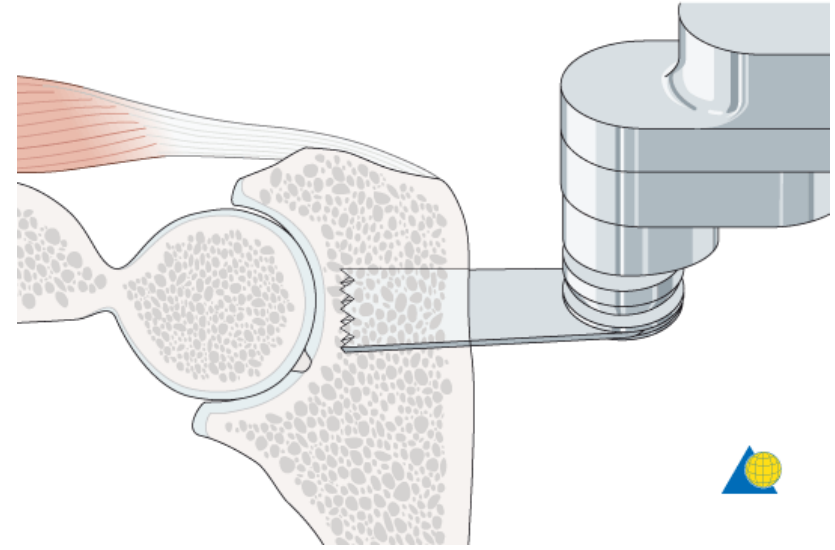
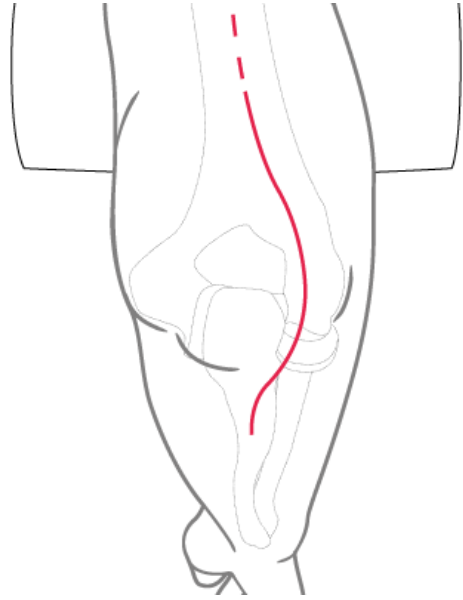

Operační léčení

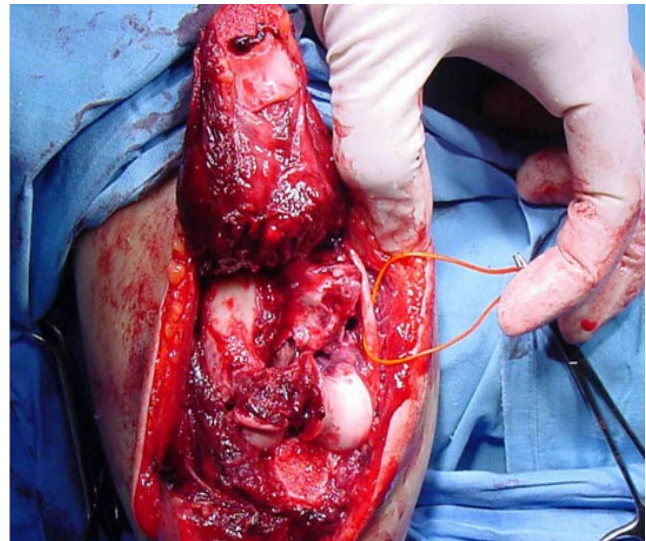
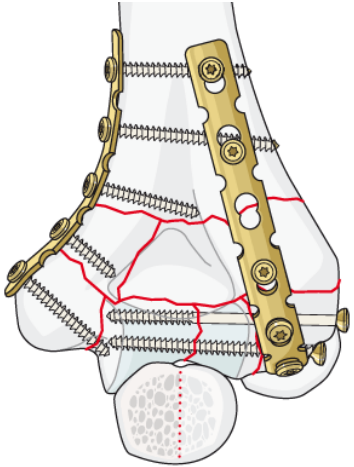
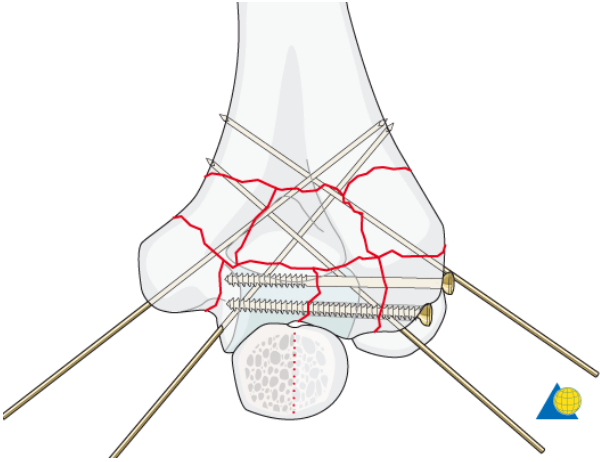
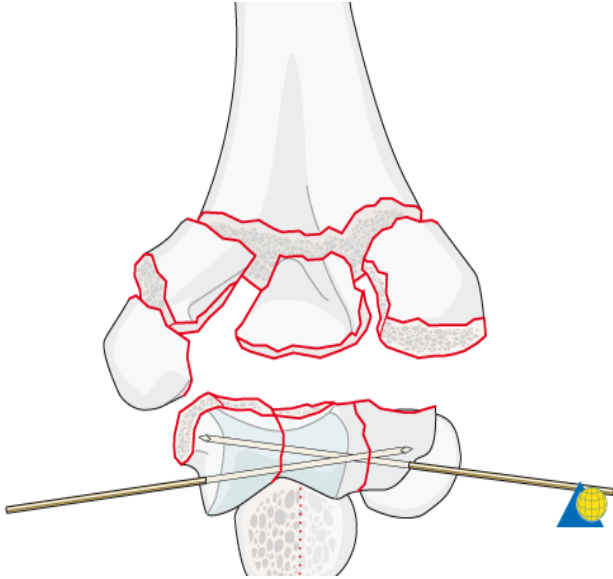

- Ruptura distálního bicepsu
 - Flexe a supinace
 - Muži 30-40 let
 - 30 – 40 % ztráta síkly
 - Symptomy – „pop“, slabost, hematom
 - Treatment – konz./operační

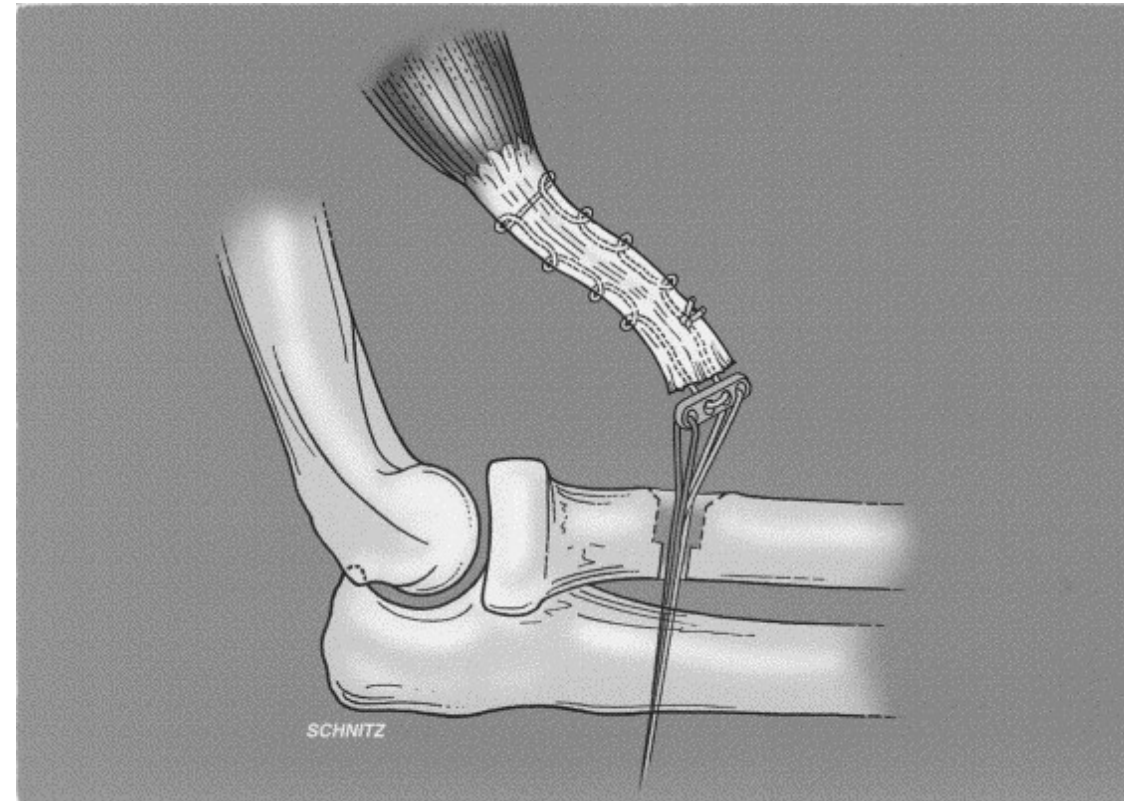
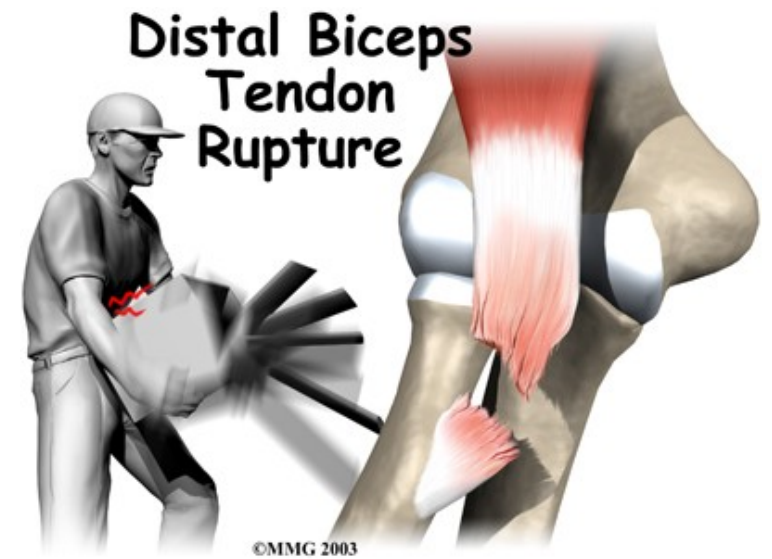

Luxace lokte

- 20 % luxací
- 11 -30 % úrazů lokte
- 6 -8 / 10000 / za rok

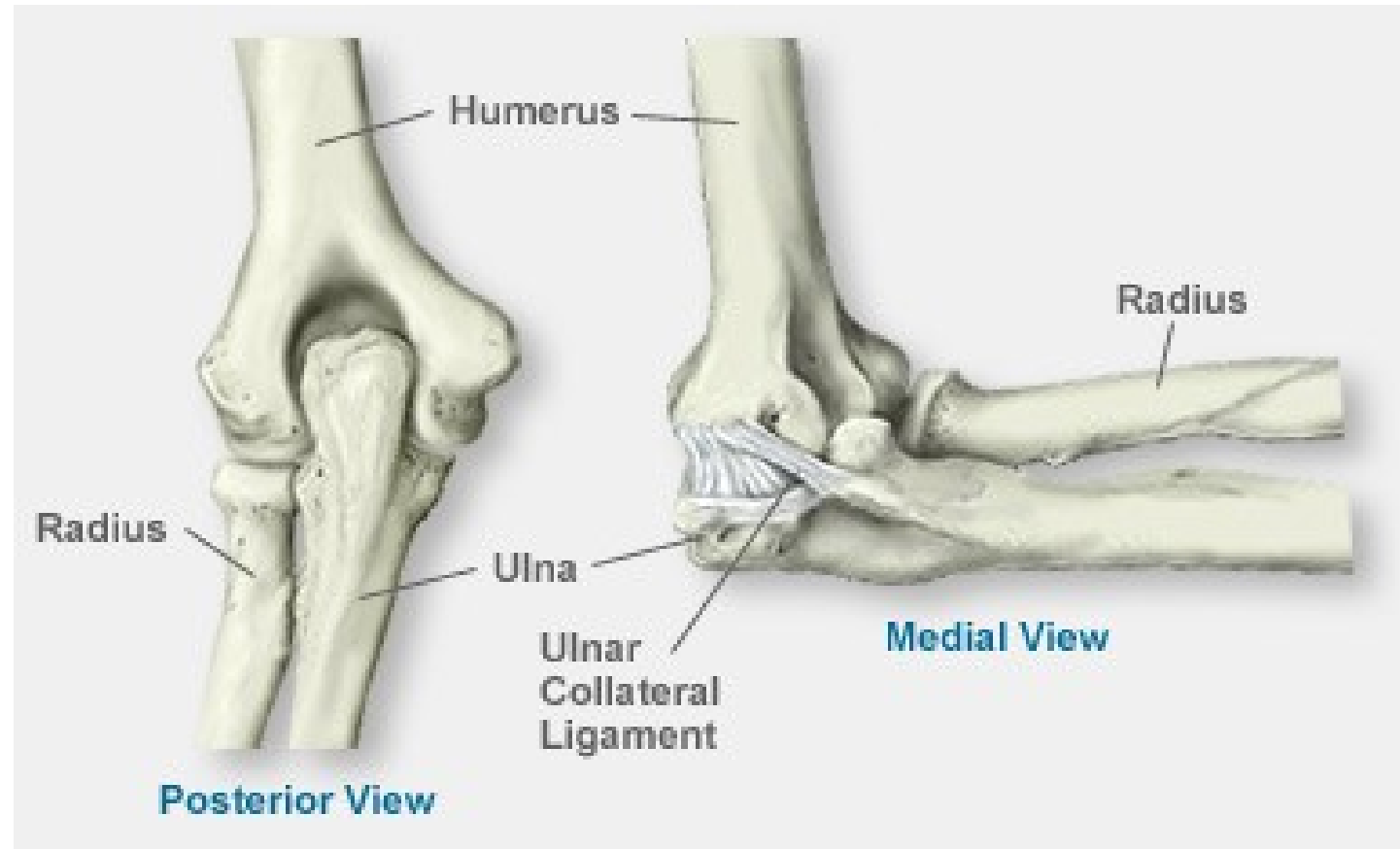

Elbow Dislocation

- Types - jednoduché / komplexní
- Jednoduché - vazivové
 - dorsální (90 %)
 - ventralní
 - medialní
 - lateralní
 - divergentní
- Komplexní- osteoligamentózní
- Diagnóza
 - anamnéze
 - klinické vyšetření
 - RTG, CT, MRI

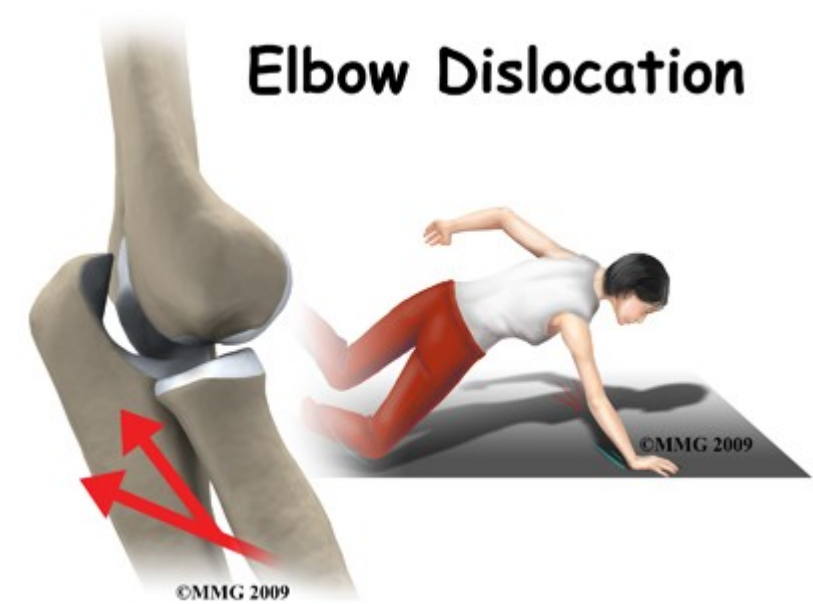

- **Terapie**
 - **repozice**
 - **vyšetření stability**



© ELSEVIER, INC. - NETTERIMAGES.COM

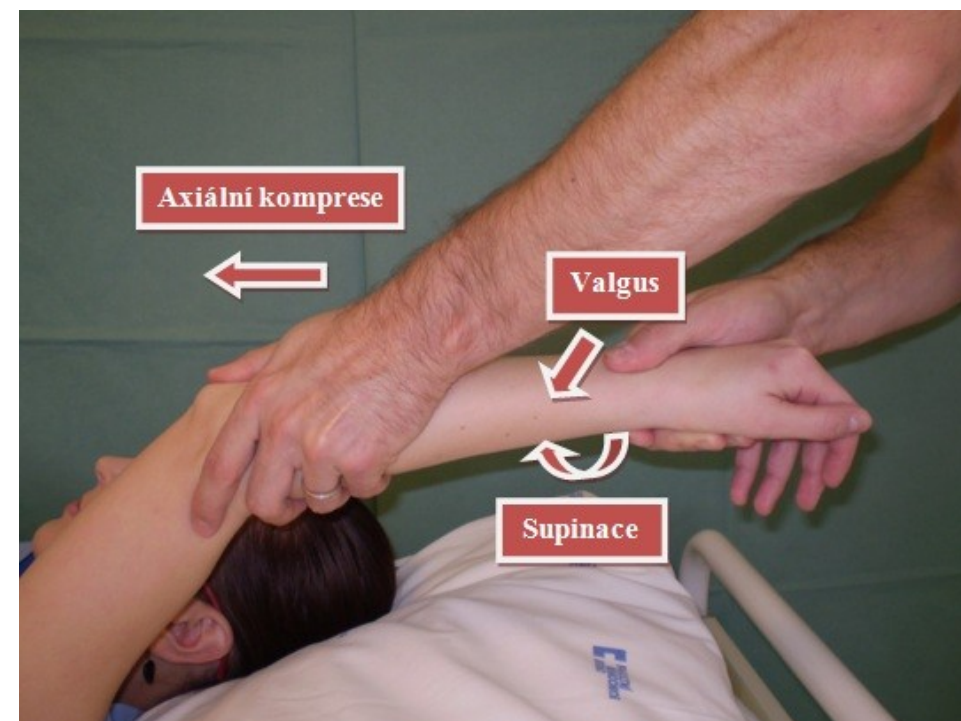

- **Konzervativní terapie**
 - limited motion ortéza
 - rehabilitace



- **Operační léčba**
 - Reinzerce otevřeně
 - rehabilitace

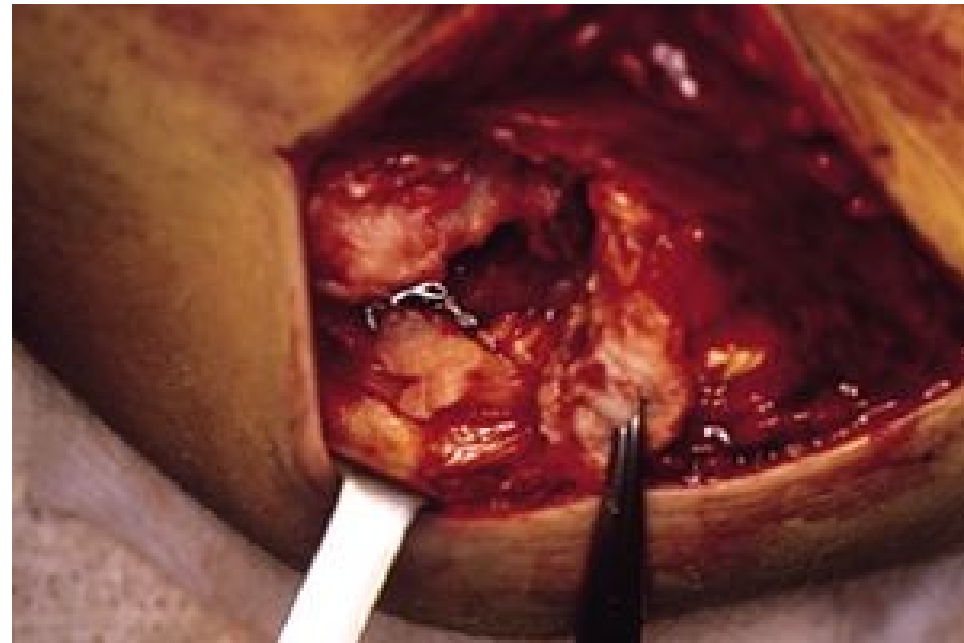

- Operační léčba

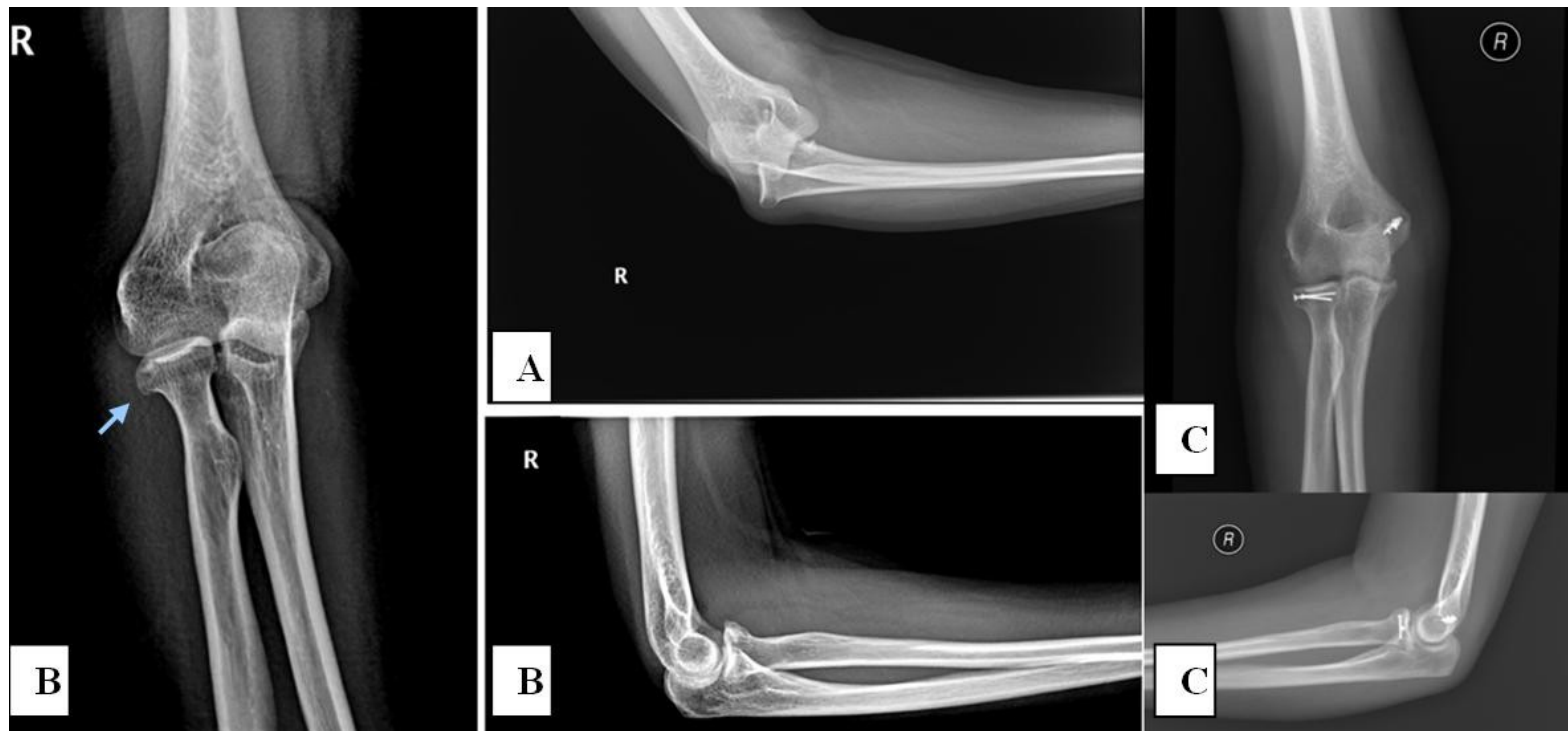

Komplikace

- heterotopické osifikace
- instabilita
- stuhlost



- Zlomeniny hlavičky radia

- 20 % fraktur lokte
- Pád na nataženou končetinu



- Diagnostika

- Anamnéza, klinické vyšetření, RTG, CT

- Klasifikace

- Mason I.-IV.

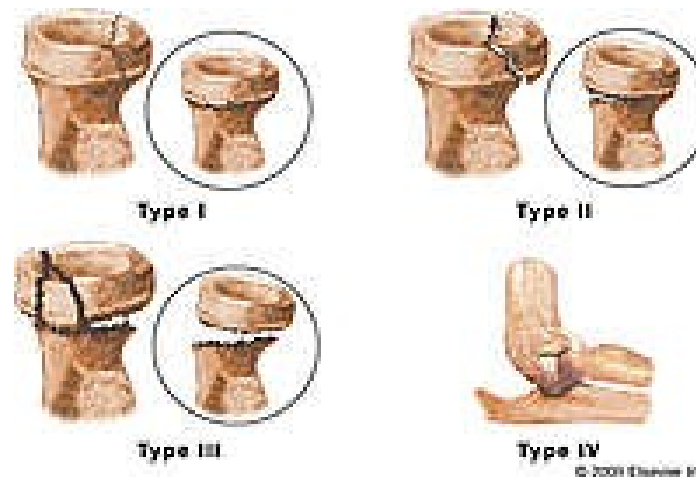

- Léčba

- Konzervativní
- Operační
osteosyntéza / náhrada / resekce

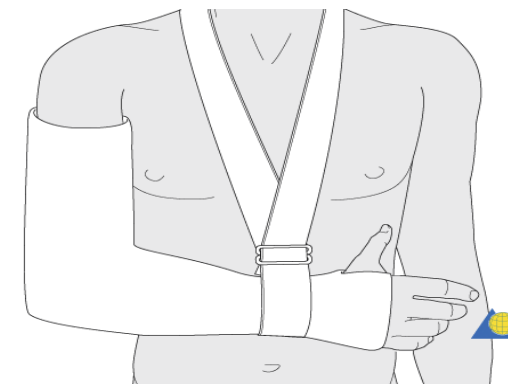

- Operační léčba

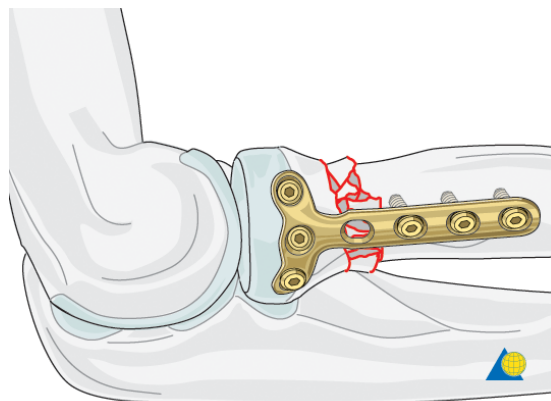
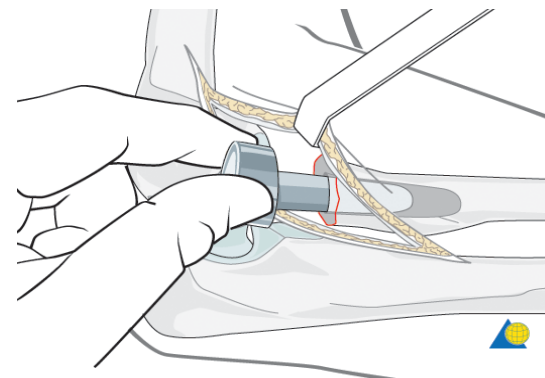
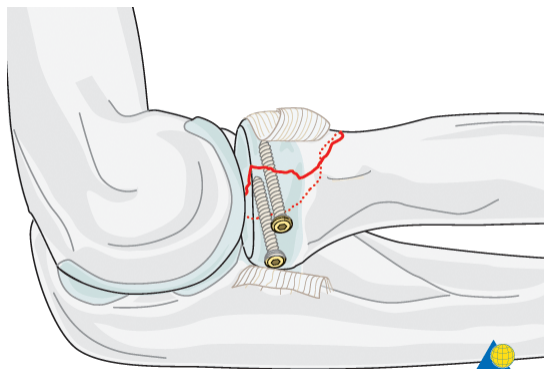
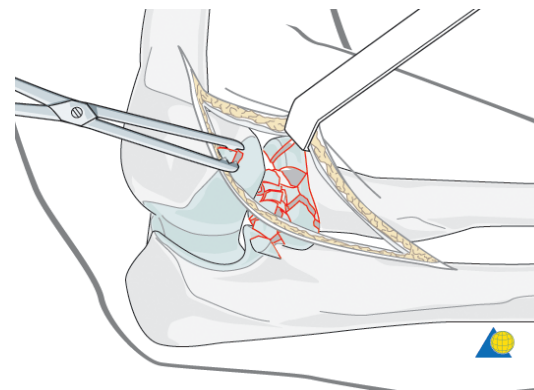
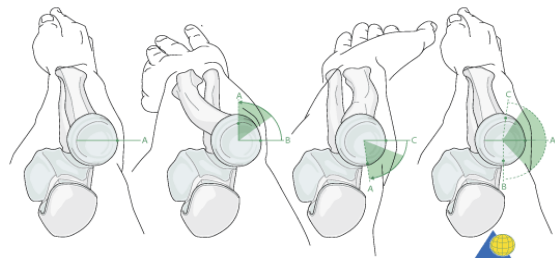

Zlomeniny olekranu

- Úpon tricepsu
 - Ztráta extenze proti gravitaci
 - Přímé úrazy – tříštivé
 - Nepřímé – šikmé/ příčné fr.
-
- RTG – AP, bočná, šikmá
-
- Konzervativní ter
 - Nedislokované fr SFO 3T, semiflexe
 - Operační ter
 - LCP, tahová cerclage

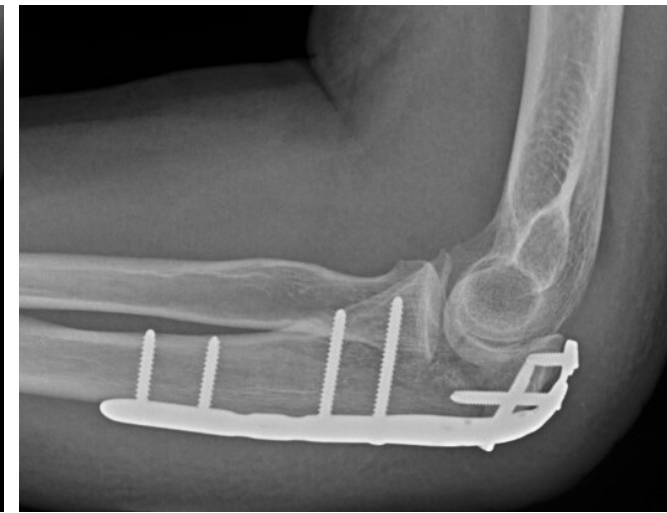

- Operační léčba

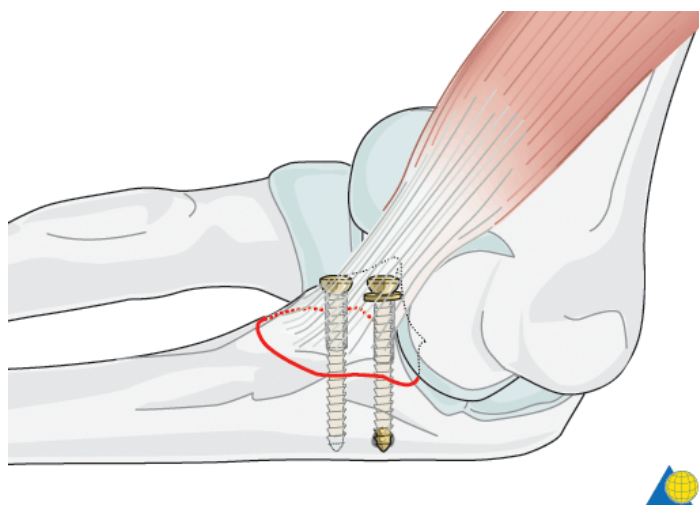
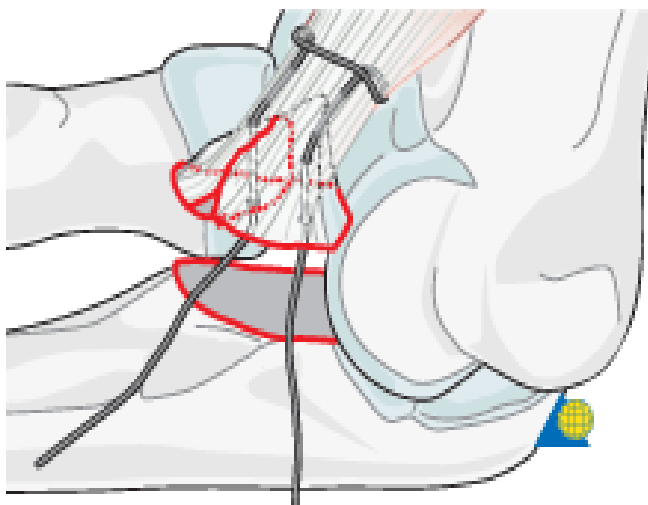
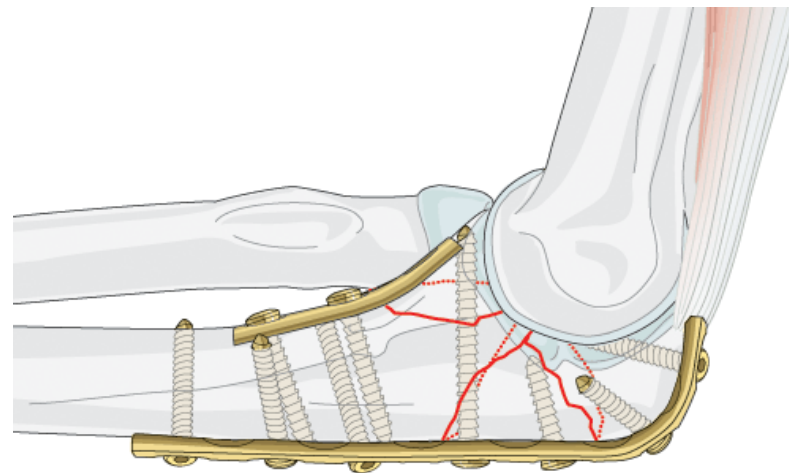
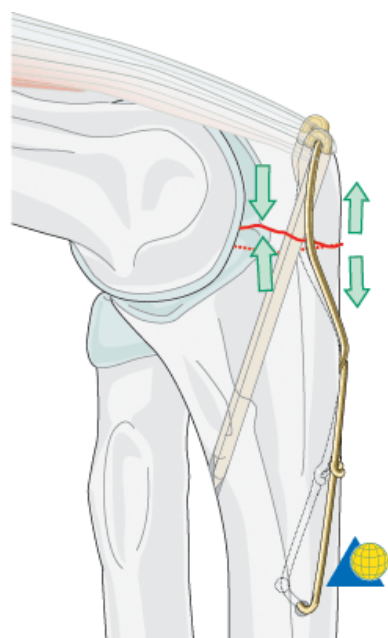
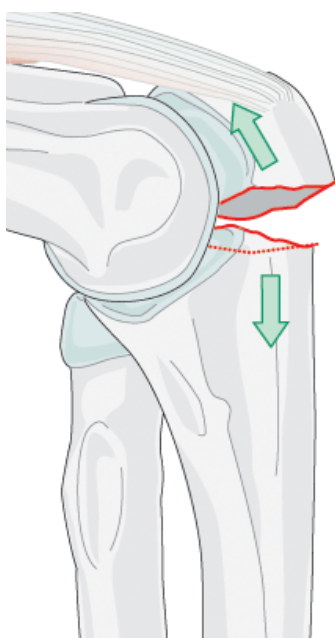

Zlomeniny předlo

- Izolované poranění 1 kosti
- Obě kosti

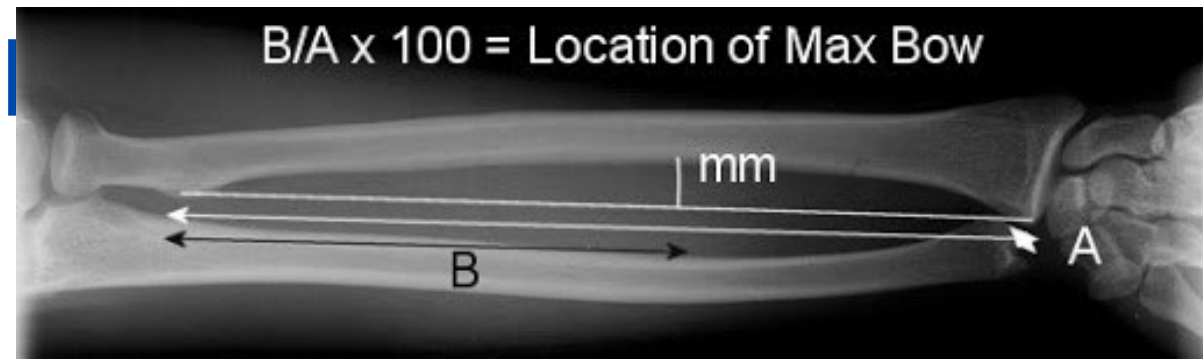

- Ulna – osa předloktí
- Radius – radiální oblouk, rotace radia kolem ulny do P/S

- RTG – AP + bočná



- Konzervativní terapie
- Nedislokované fr., minim posunuté – angulace <10st, kontakt >50%
- Radius – rotace - >> riziko pakloubu
- vysoká sádra 3T
- Antirotační brace/ SFO 3T



Operační terapie

- Dislokované fr., radius, obě kosti
- Dlahová OS
- ZF
- fasciotomie

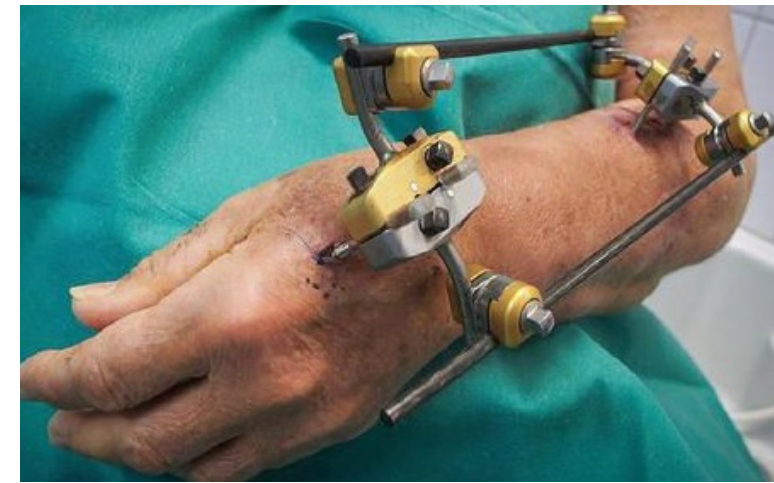

Distální radius

- Jedna z nejčastějších zlomenin
- Typická bajonetovitá defigurace, otok, porucha hybnosti, bolestivost dist předloktí

- Collesova zl.
- Smithova zl.
- Intraartikulární zasahující
- Poranění styloidu ulny

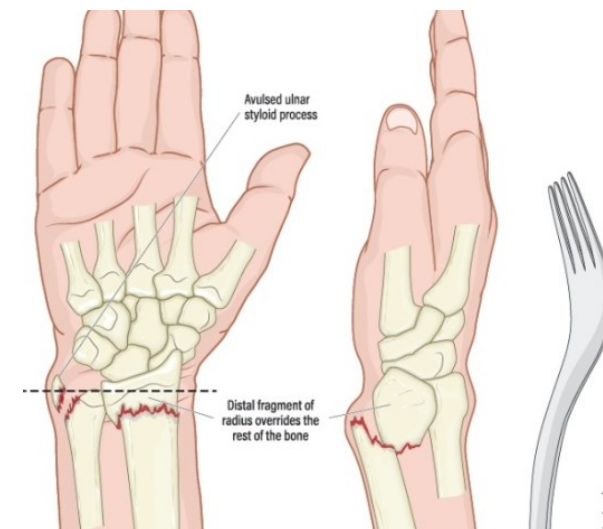

- Bimodální incidence
- Děti a mladí, aktivní
- Staří - osteoporóza

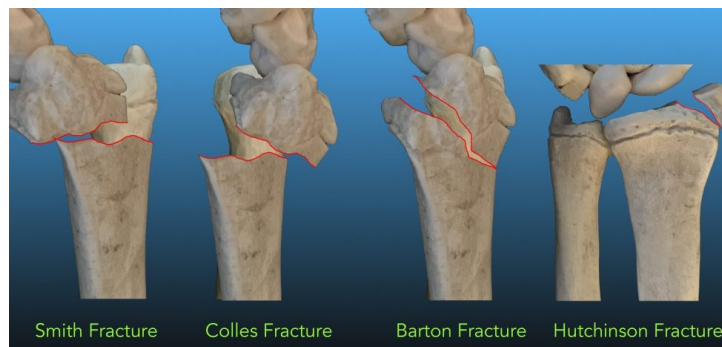

Distální radius

- Zavřená repozice – trakce, ligamentotaxe
- Mírná volární flexe a ulnární dukce
- Střižená SFO pod loket (loket)
- Suger tong splint
- SFO 5-6 týdnů, 4 týdny

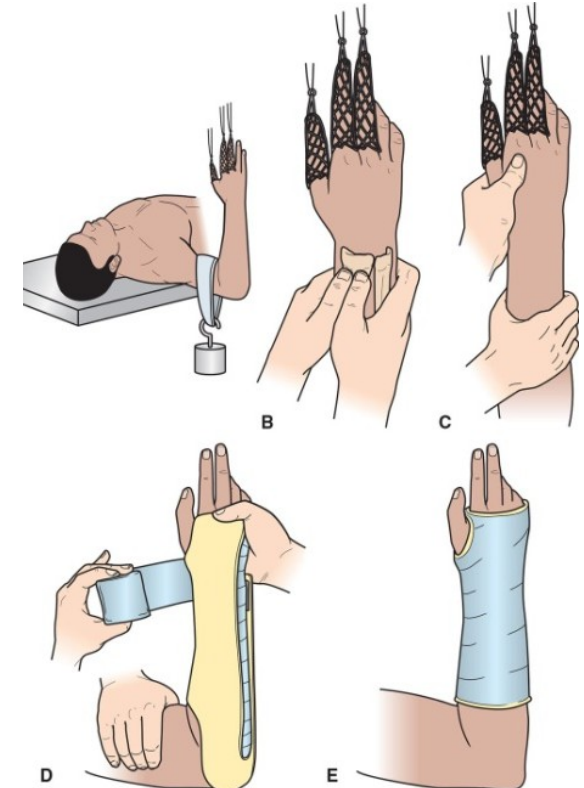

Zlomeniny ruky

- Scaphoid – nejčastěji poraněná carpální kost ruky,
- Limitované cévní zásobení, rozsáhlý chrupavčitý povrch
- Klin. bolesti fossa tabatiera

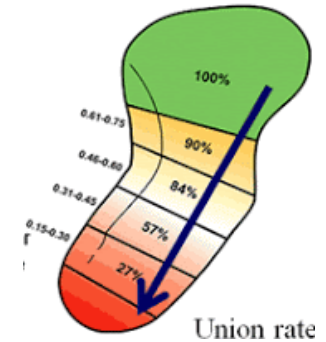

- Dlouhodobá fixace – 6, 8-12T
- S proximalizací – narůstající riziko pakloubu
- Operační léčba – Herbertův kompresní šroub

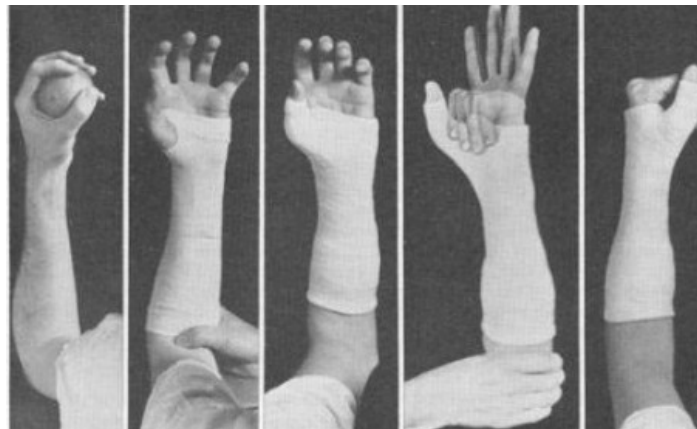

Zlomeniny MTC a prstů

- Vysoká incidence – pracovní, domácí, sportovní úrazy
- Krček < 40st angulace – 4 T
- Diafýza - 20st angulace, zkratek do 5mm, 5T
- Baze – 3T
- Prsty – 3 týdny
- Baze, diafýza, hlavice
- Op – dislokace, tříštivé zl. baze
- Malrotace
- SFO – intrinsic plus pozice

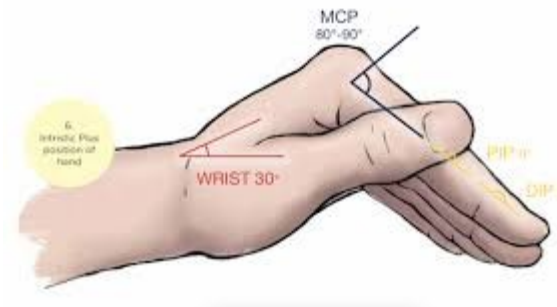
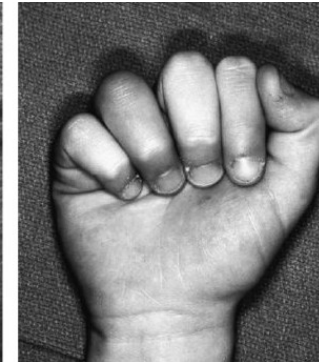

Zlomeniny MTC a prstů

- Operační indikace. Otevřené zlomeny, dislokace, výrazná angulace, zkratek, malrotace

- Šrouby
- KW
- dlahy

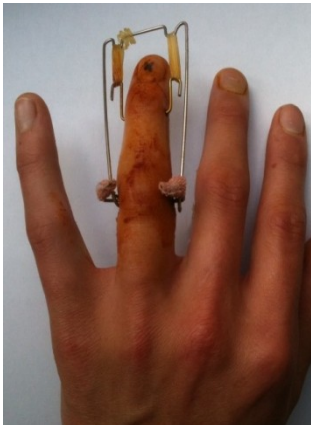

Flexorový aparát

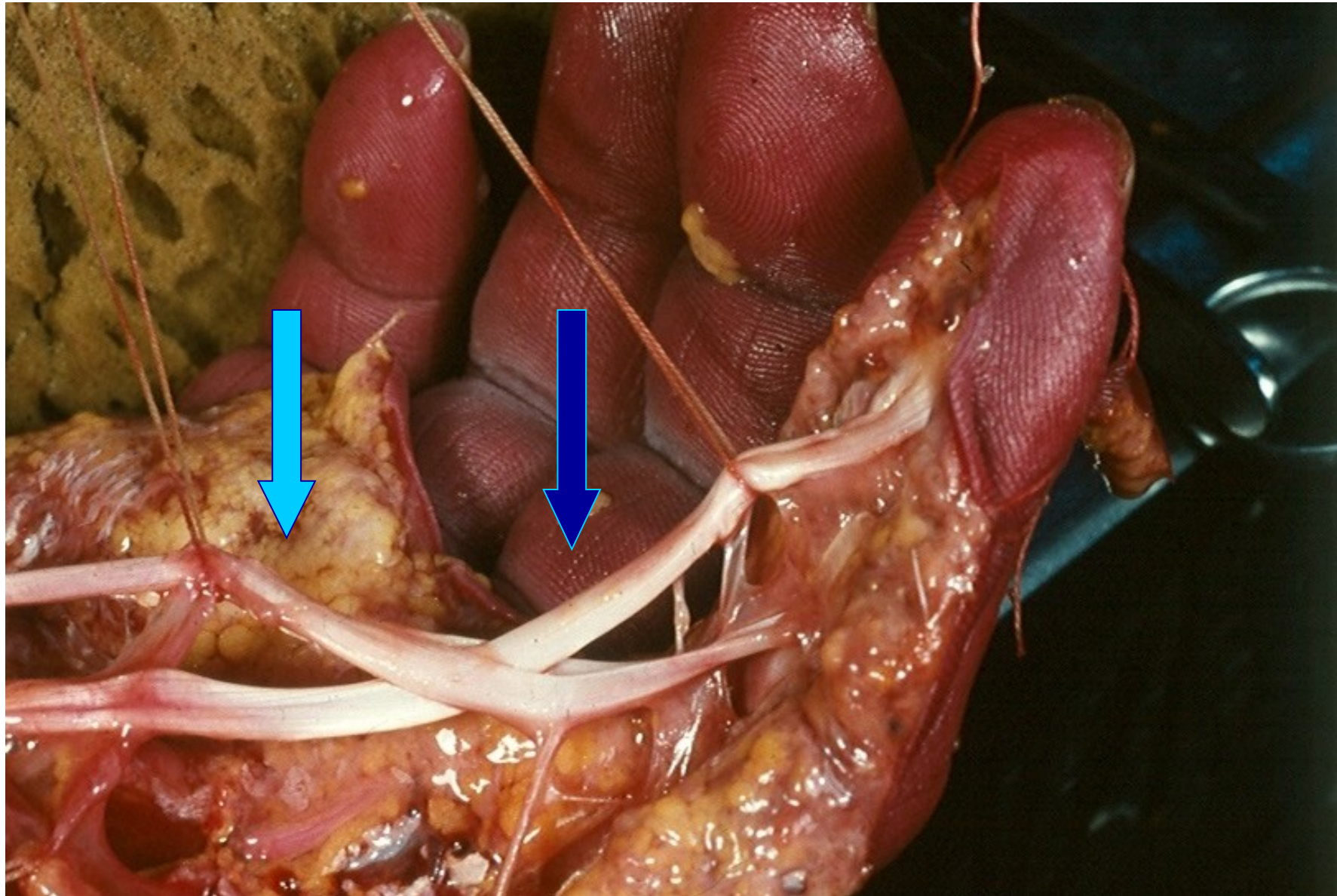

Šlachová poutka a zóny poranění dle Kleinerta

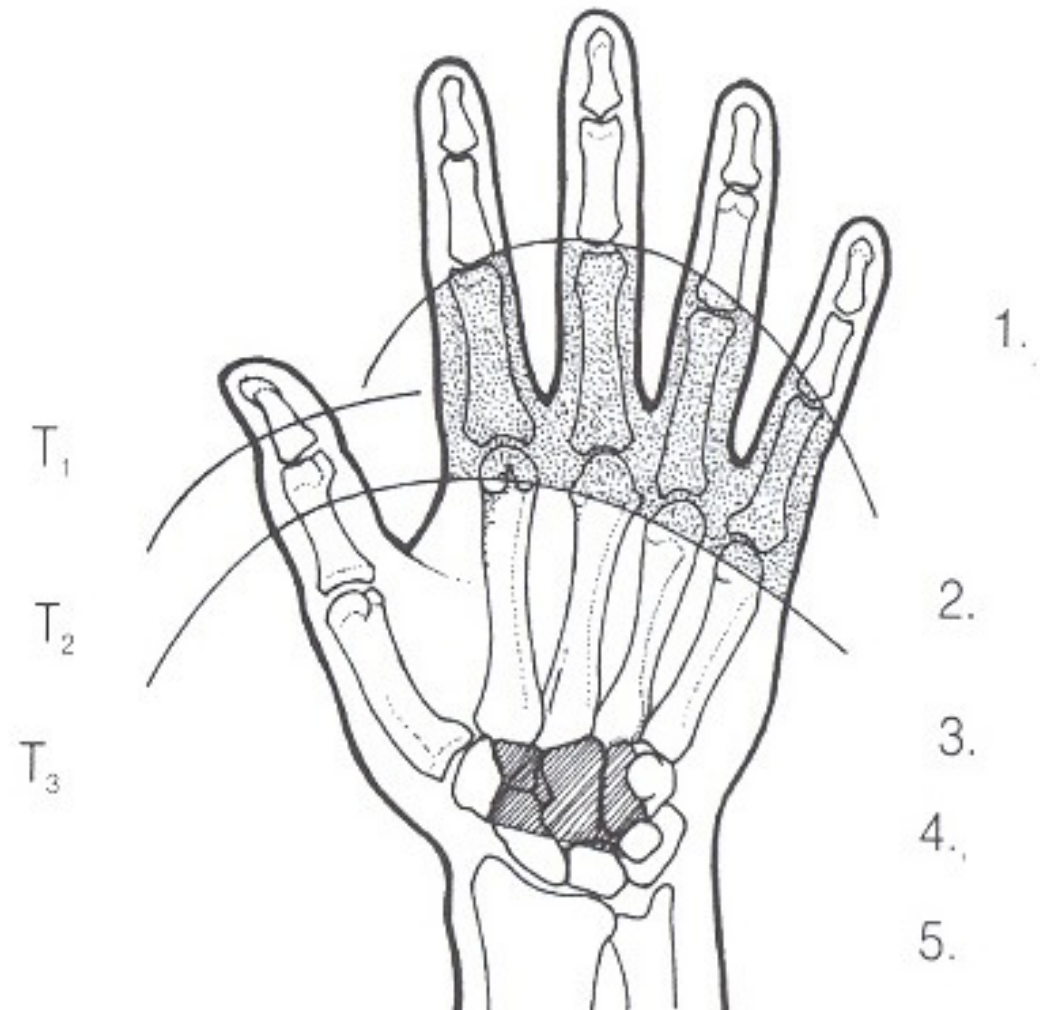
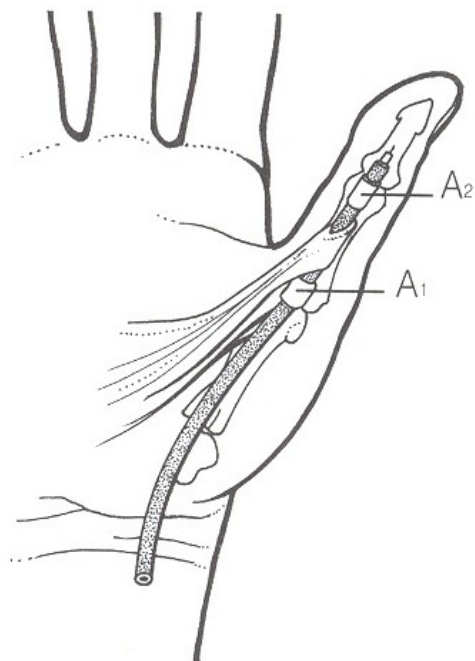
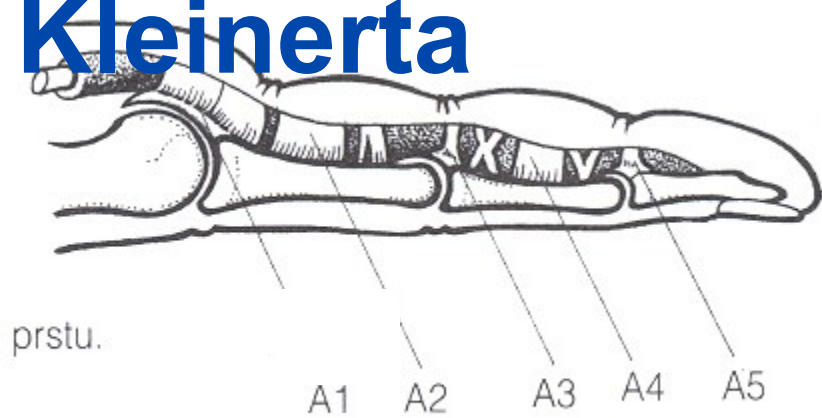

Vyšetření šlachy m. flexor digitorum profundus (FDP)

Prsty vyšetřujícího blokují
střední a základní článek prstu

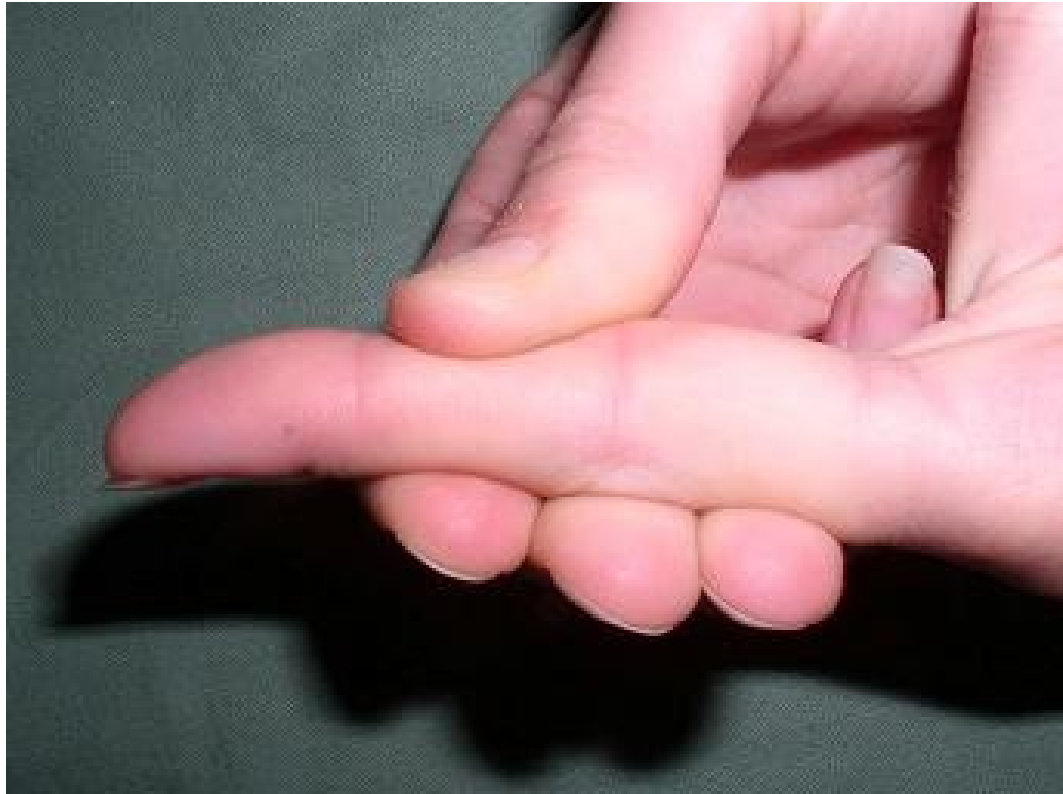

U neporaněné šlachy FDP je
možná aktivní flexe v DIP kloubu



Vyšetření šlachy m. flexor digitorum superficialis (FDS)

Prsty vyšetřujícího blokují
flexi ostatních prstů

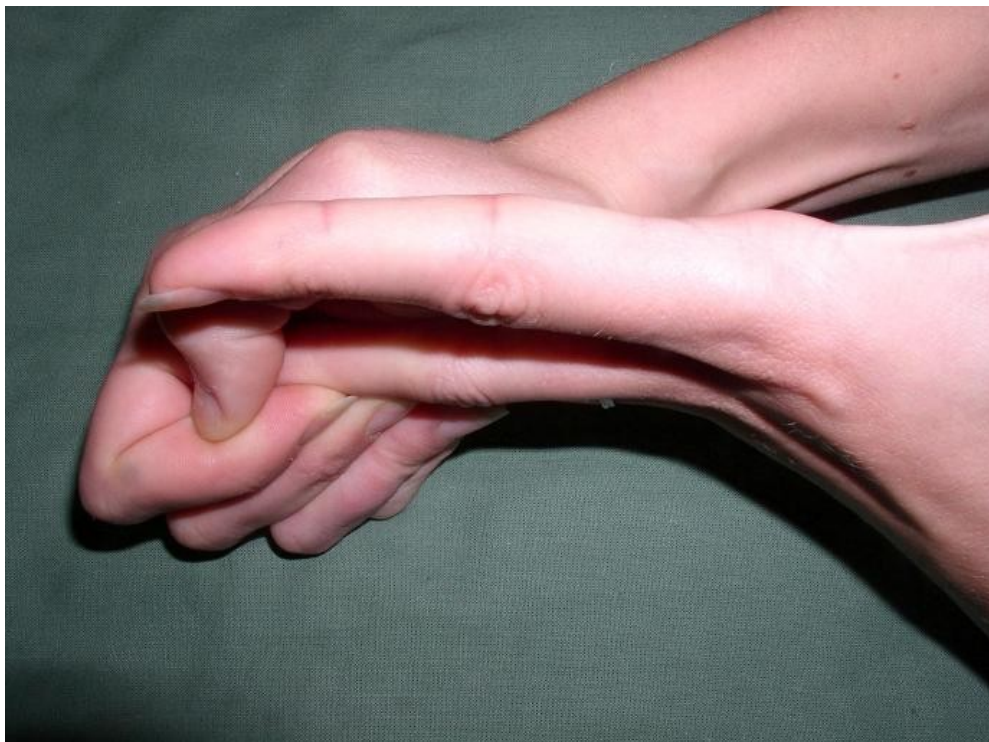

U neporušené šlachy FDS je
možná aktivní flexe v PIP kloubu

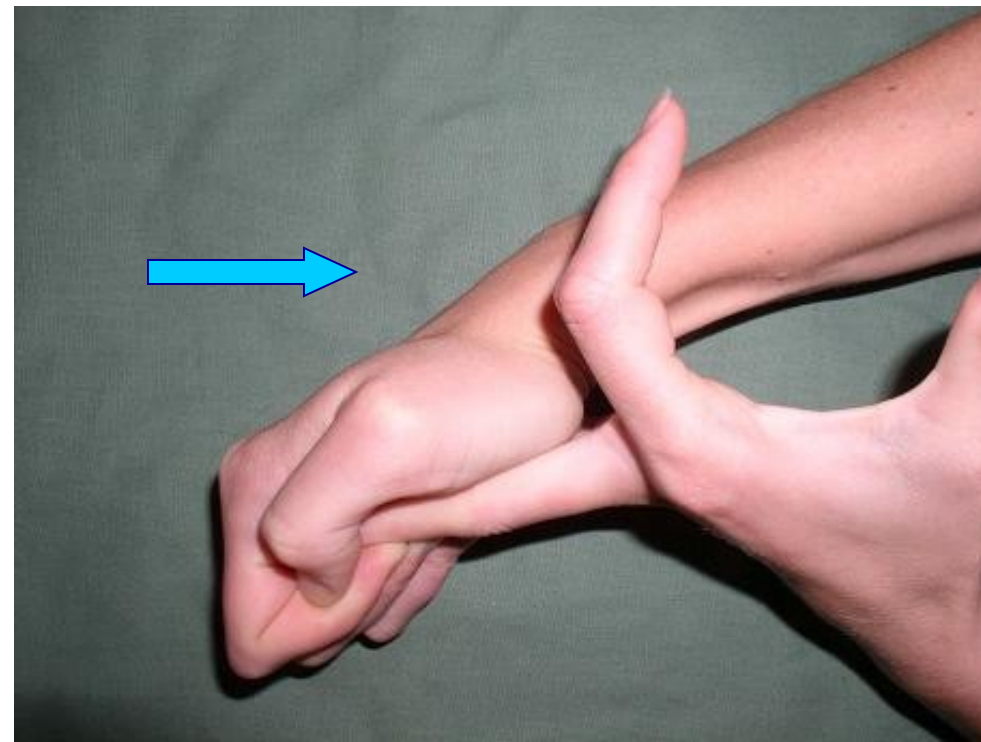

Sutura šlachy flexoru

- OP sál, CA, bezkrevnost, asistence
- primární sutura nebo „odložená neodkladnost“
- úprava šlachových pahýlů
- šicí materiál – 3-0, 4-0 pro obšití 5-0, 6-0
- doporučována technika 4 vláken (modif. Kessler, Kleinert)
- rehabilitace od 48 hod, Kleinertova fixace 3-4 týdny

Obr. 8
Typy šlachových sutur.

Kessler



Tsūge

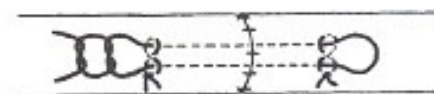

Modif. Kessler

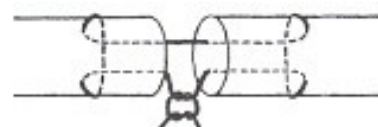

Becker

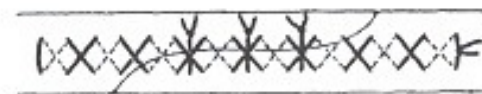

Kleinert



Verdan

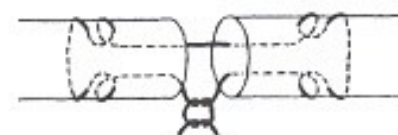

Bunnell



22

Obr. 7
Sutura šlachy základním stehem
a její obšití stehem adaptačním.

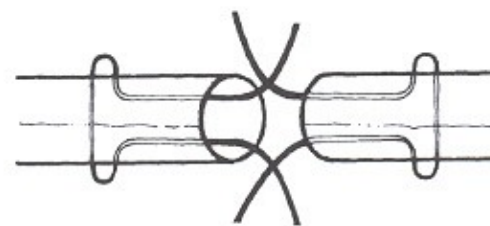

Vyšetření extenzorového aparátu

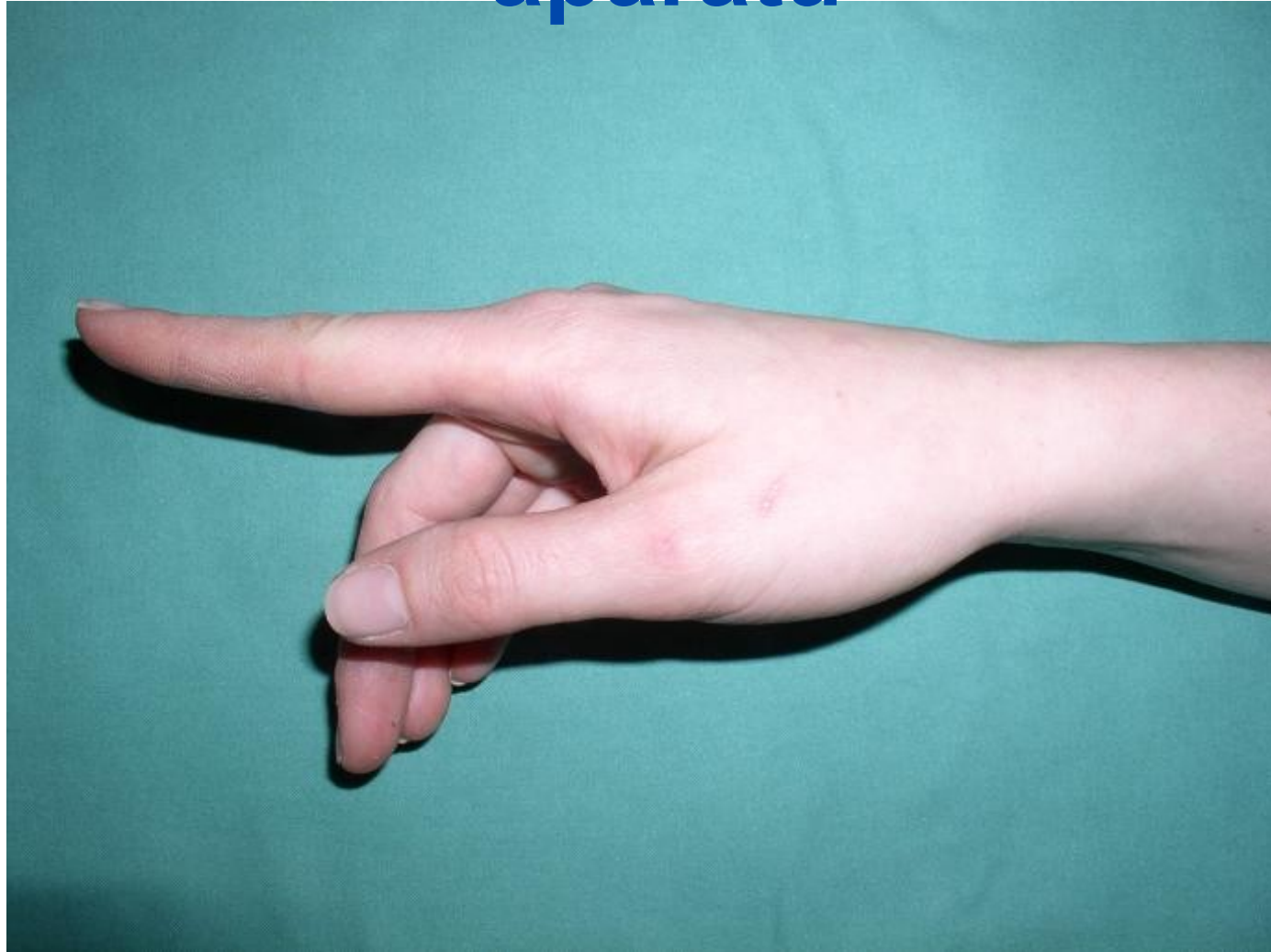

Sutura šlachy extenzoru

- ideální je primární sutura
- při poranění v oblasti PIP kloubu: *CAVE* centrální pruh !
- fixace MCP kloubů v 10° flexi a zápěstí ve 45° extenzi
- doba fixace 4-5 týdnů
- rehabilitace Kleinertova dynamická fixace

Kleinertova dynamická fixace u poranění extenzorů



Poranění středního pruhu extenzorového aparátu

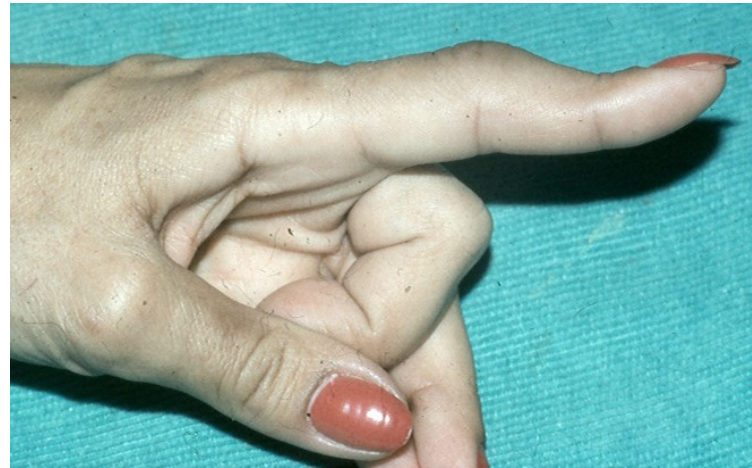

Shrnutí VI

Pro diagnostiku a léčbu je nutná dobrá znalost anatomie šlachového systému

Ošetření poranění flexorů nejlépe na operačním sále v celkové anestézii, v bezkrevném operačním poli a s asistencí.

Dynamická Kleinertova fixace je prevencí adhezí a dostatečně brání suturu před uvolněním

U poranění extenčního aparátu prstu je nutné vyloučit poranění středního pruhu !

Infekce na ruce

Hnisavá onemocnění prstů

Povrchní

- Panaritium erytematosum/bullosum/periung./subung. (paronychium)

Hluboká

- Panaritium pulposum (članků/ryh)/tendineum (tendovag. purulul.), osseum (osteomyelitis)/ articulare

Hnisavá onemocnění ruky

- Tyloma abscedens
- Flegmona meziprstních prostorů
- Flegmona thenar./antithenar. Prostoru
- Flegmona dorsa ruky
- Flegmona středního dlaňového prostoru

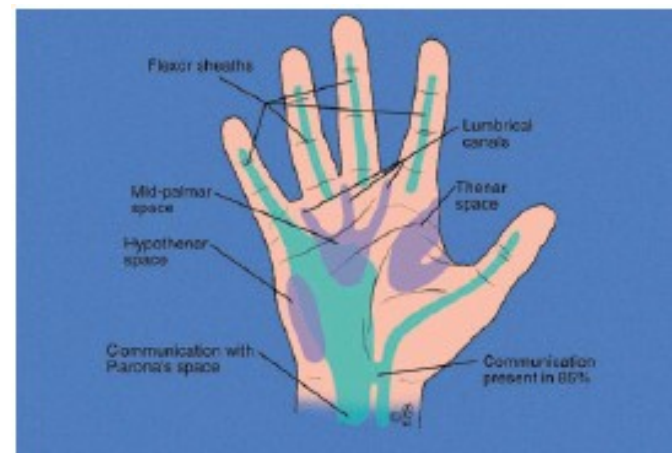

Infekce na ruce

- Nejčastěji stafylokoková/streptokoková infekce
- Klin. obraz – rubor/calor/dolor
- Terapie – klid režim

antiseptika(VB...)

chir. terapie (incize/kontraincize, drenáž, proplach

atb/antiseptika lokálně)

atb celkově (tt, lymfangoitis, lymfadenitis, B+C)



Panaritium

- Většinou penetrující trauma (staf. aureus, G-)
- Cave – diabetes, imunokompromit. Pacienti
- Otok, tlak ,bolest (kompart. sy s NV kompresí)
- Rtg- vyloučení corp. alien/osteomyelitis
- Chyby – herpet. infekce/nepoznaná osteomyelitis, tendovaginitis
iatrogenní infekce šlachy, léze NC svazku
- Terapie – konzervativně (povrchní- celulitis – do 48 h)
- operační



Panaritium

- Principy – terapie infektu a uvolnění tlaku
- 3x denně proplachy/obložky
- Brzká rehabilitace
- Ev ATB dle citlivosti
- Komplikace – šíření infekce – šlacha, kost kloubm neht. lůžko

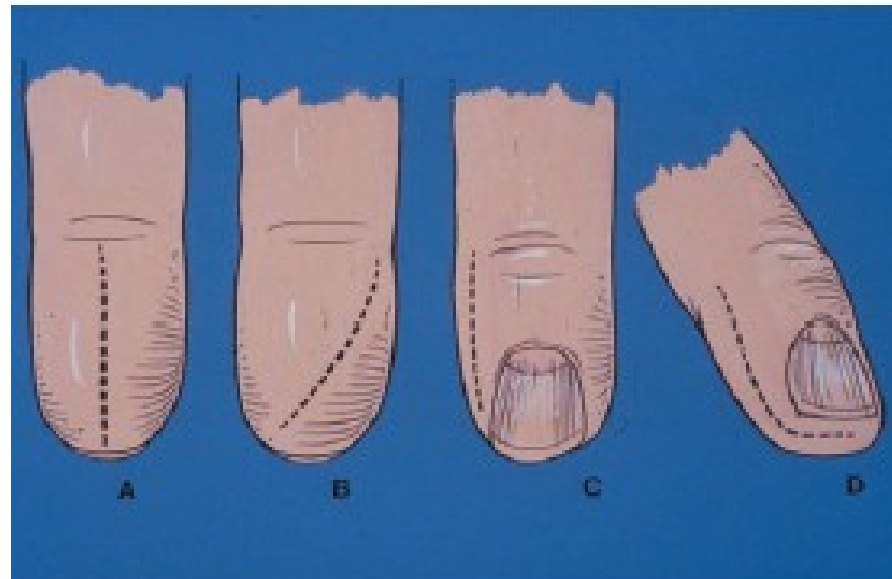

Paronychia

- Infekce tkání kolem plotýnky, akut./chron.
- Nail biters/manikura – s. aureus
- Šíření – paronych. – eponych. – kontralat.
- **Konz. Terapie**
 - Brzké stádium, lok. terapie ev. atb, brzká rhb
- **Chir. Terapie**
 - Incize, drenáž, cave - matrix

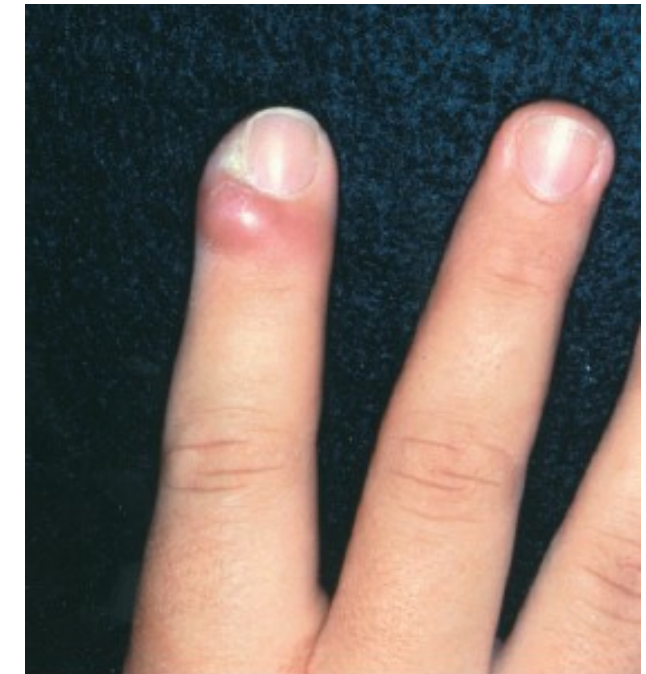
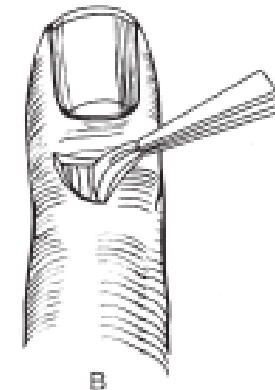
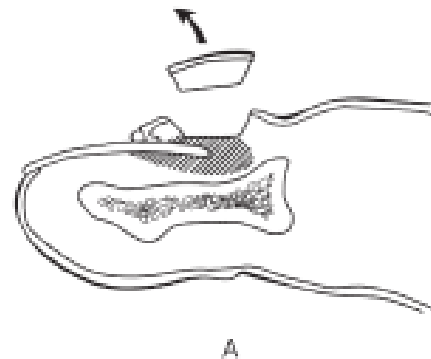
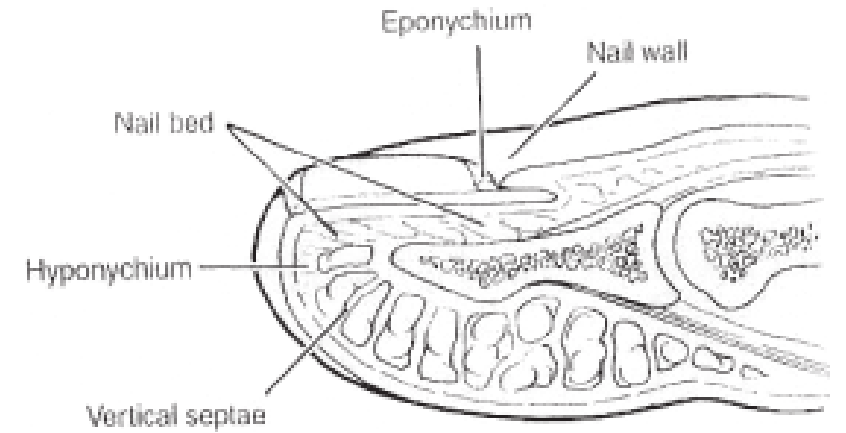

Konzervativní terapie zlomenin

- Nedislokované zlomeniny
- Zlomeniny s dislokací s možností zavřené repozice,
- Vynuceně - pacienti neschopní podstoupit výkony v CA
- Měkko-tkáňové poranění kdy dojde k zhojení in situ
(kontuze, distorze, stavy po luxacích, parc. ruptury svalů, šlach, některé totální ruptury svalů či šlach)
- Dětské zlomeniny - vysoký remodelační potenciál



Konzervativní terapie

(AO principy)

- **Repozice** - obnovení anatomického postavení zlomené kosti
- **Retence** - udržení postavení fragmentu dostatečně stabilní
fixací - **imobilizace**
- **Rehabilitace** - časná mobilizace s rehabilitací postižené oblasti

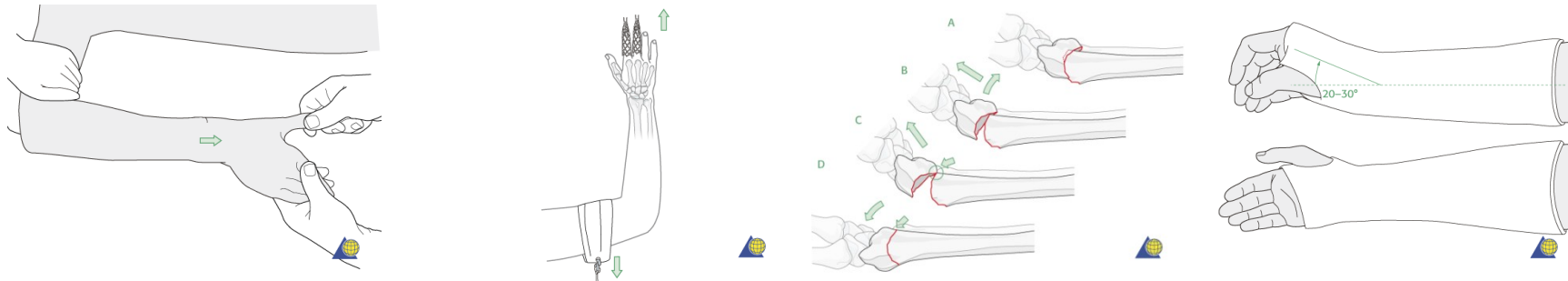

- Sekundární hojení kostním svalkem

Konzervativní terapie

Imobilizace

- Obinadla, ortézy
- Tuhnoucí fixační obvazy
- sádra, syntetika
- Skeletární trakce (extenze)

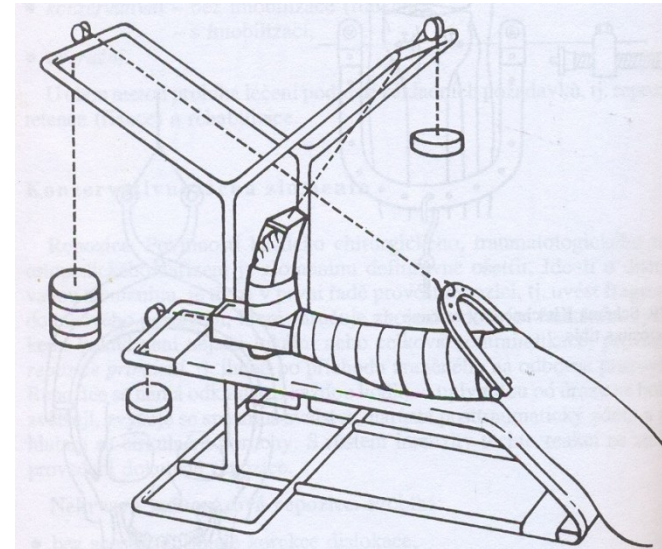

Konzervativní léčení

Rizika a nevýhody

- Zlomeninová nemoc :
 - změna oběhu – omezení hybnosti okolních kloubů, otoky venózní, lymfatické, svalová atrofie, osteoporóza až Sudeckova kostní atrofie – prevence je RHB
- Imobilizace – riziko trombózy
 - artrofibroza přilehlých imobilizovaných kloubů –
omezení hybnosti – dlouhodobá RHB
- Diskomfort pacienta
- Časté kontroly pro riziko redislokace

Tuhnoucí fixační obvazy

Fixační materiály:

- Sádrové longety



- Syntetické polymery – fiberglass – aktivace vodou



- Termoplasty



Formy:

- Sádrová dlaha
- Cirkulární sádra
- Brace – umožňuje pohyb v přilehlých kloubech



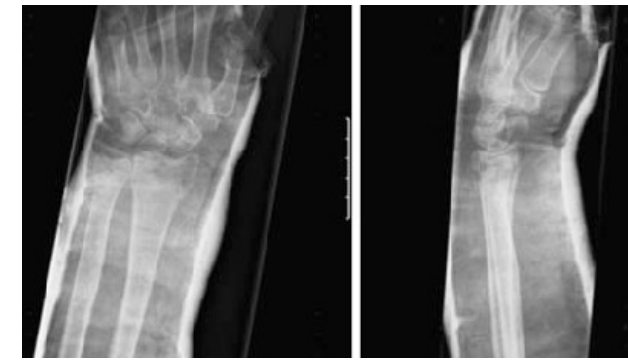

- **Sádra**

Výhody:

- Levná cca 15Kč/ks, Hypoalergenní, Snadno tvarovatelná

Nevýhody

- Těžká, Křehká, Kontakt s vodou – rehydratace, radioopacitní



- **Syntetické materiály**

Výhody

- Lehké při zachované tuhosti a pevnosti, Odolnost proti vodě / Cave – podložení, Radiolucentní

Nevýhody

- Cena cca 250-300 Kč, Obtížné tvarování Riziko - otlaku útlaku



Pravidla pro naložení sádrového fixačního obvazu

- Fixace kloub nad a kloub pod zlomeninou / poraněním
- Imobilizace kloubů ve funkčním postavení ???
- Důsledné tvarování, bez tlakových bodů - dlaně



- Primární ošetření / dočasná fixace
 - dlahy, cirkulární střižená fixace - vývoj otoku, převaz
- Definitivní ošetření
 - cirkulární fixace po opadnutí otoku



Pravidla pro naložení sádrového fixačního obvazu

- Nepodložený SFO – (Böhler – aplikace přímo na kůži), punčocha, vypodložení prominencí



- **Podložený SFO** – cirkulární vypodložení vatou mezi pokožkou a sádrou, 50% překryv



Vypodložení:

Okraje sádrového obvazu, ochrana prominencí
Otok a očekávání otoku, atrofie měkkých tkání



Pravidla pro naložení sádrového fixačního obvazu

- Punčocha (trikot)

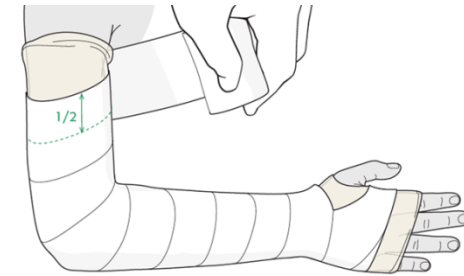

AO

- Vata



- Krepový papír / Haftan



- Sádrová longeta

•



Poučení pacienta se sádrovým fixačním obvazem

Okamžitá kontrola:

- Při výrazné bolesti a tlaku fixované končetiny
- Otoku periferie, diskolorace periferie
- Porucha hybnosti, parestezie

- Pacient se sádrou má vždy pravdu

- Udržovat sádrový obvaz v suchu a čistotě

- Mobilizace všech přilehlých nefixovaných kloubů, izometrie svalů

Komplikace konzervativní terapie

- Příliš volná fixace

- ztráta repozice



- Příliš těsný fixace:



- Bolest
- Dekubity
- Periferní nervový de
- Kompartment syndrom
- ischemická kontraktura

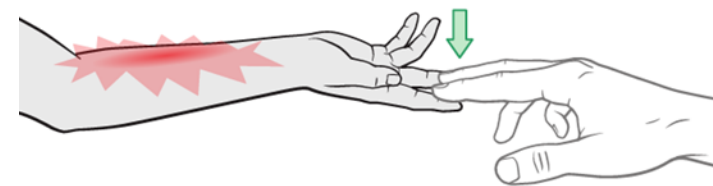

Operační stabilizace zlomenin

- Zavřená nebo krvavá repozice zlomeniny a instrumentální stabilizace fragmentů
- Selhání konzervativní terapie
- Nestabilní - reponovatelní, ale neretinovatelne zlomeniny
- Zavřeně nereponovatelné zlomeniny
- Dislokovaní intrartikulární zlomeniny (schodek kl. plochy 2mm)
- Zlomeniny s nízkým hojivým potenciálem při konzervativní ter (krček femuru)
- Dislokované avulzní fr. svalů a šlach (olecrnon, patella)
- Mnohočetná poranění, polytrauma
- Otevřené zlomeniny