



LÉKAŘSKÁ FAKULTA MASARYKOVY UNIVERSITY
Interní hematologická klinika LF MU a FN Brno
Centrum molekulární biologie a genové terapie



Analýza exprese microRNA

Doc. MUDr. Mgr. Marek Mráz, PhD
Group leader CEITEC MU

- Nic si nepište...vše bude online
- Další hodina příští týden

- Lidské miRNA geny: **cca 2000**

microRNA (miRNA)

- ❑ krátké RNA molekuly
~22 nukleotidů
- ❑ komplementární vazba k
cílové mRNA
- ❑ inhibují translaci a snižují
stabilitu mRNA



**Stovky evolučně
konzervovaných microRNA**

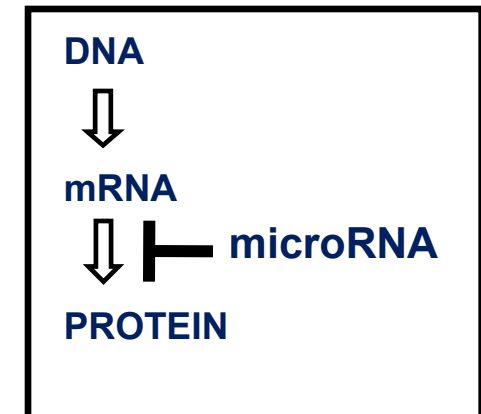
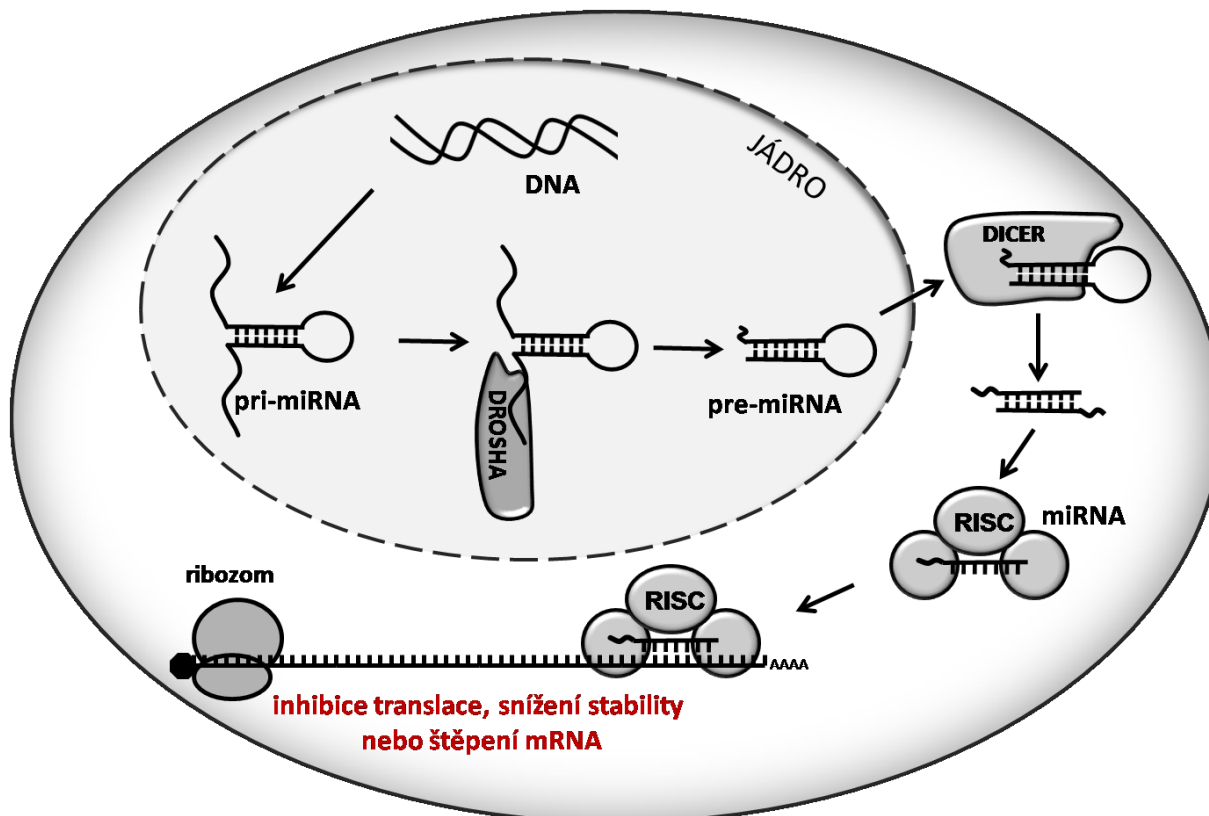

MicroRNAs were discovered by V. Ambros and G. Ruvkun in *C. elegans*

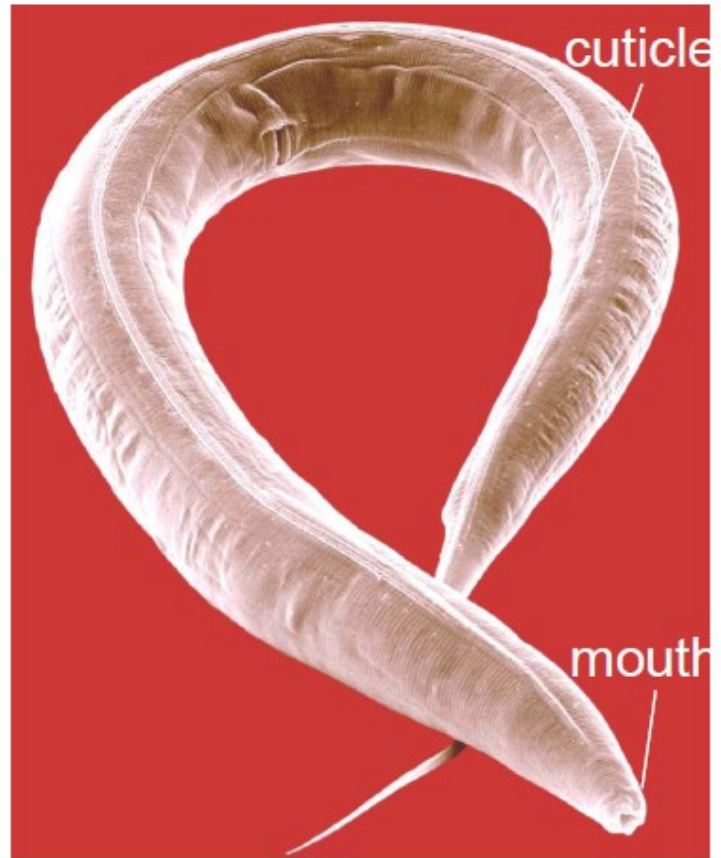
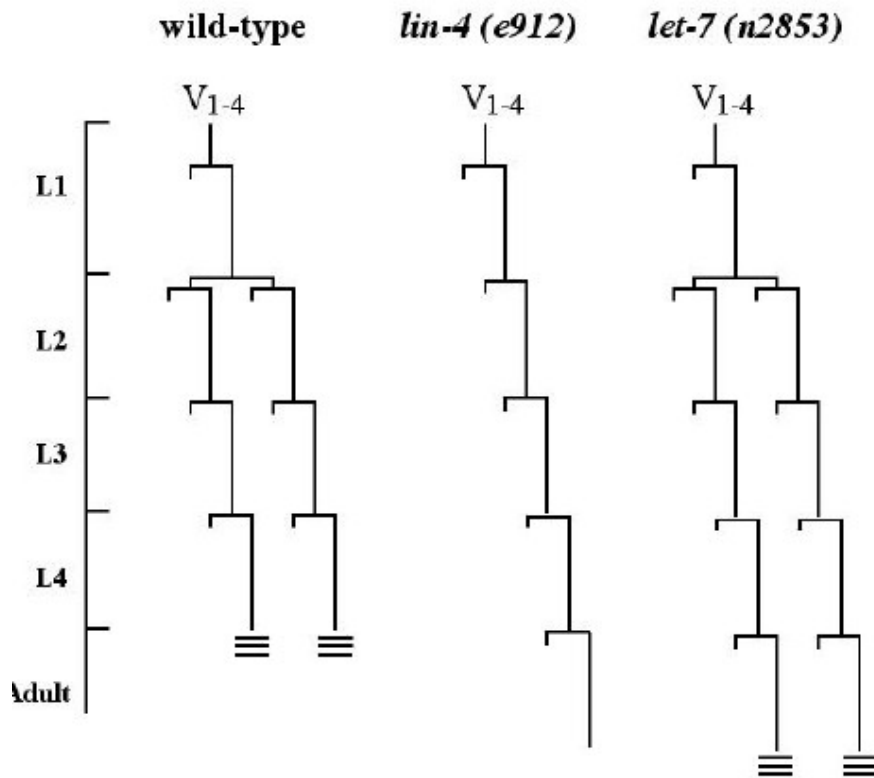

Lee et al. 1993 *Cell*

Reinhart et al. 2000 *Nature*

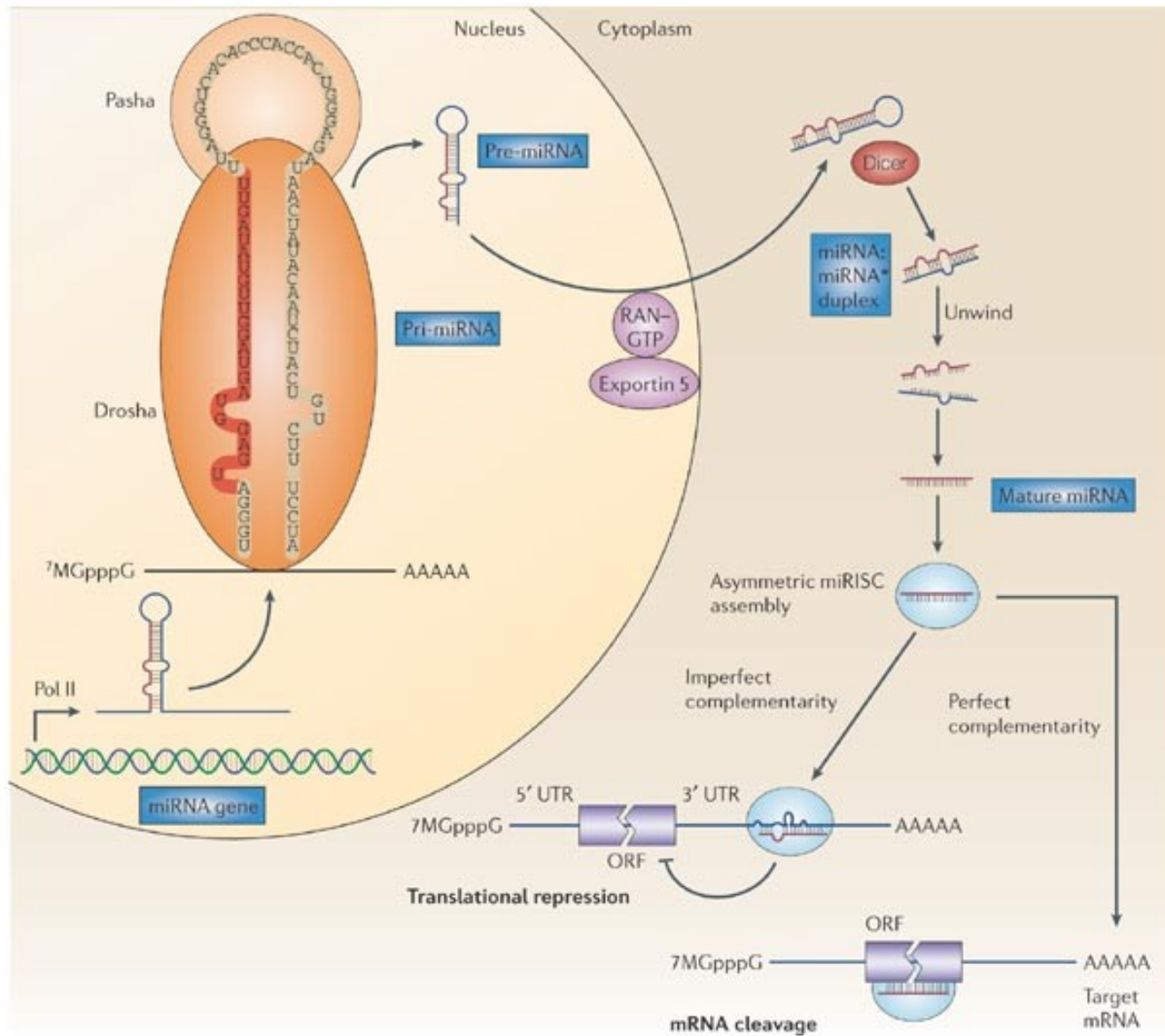

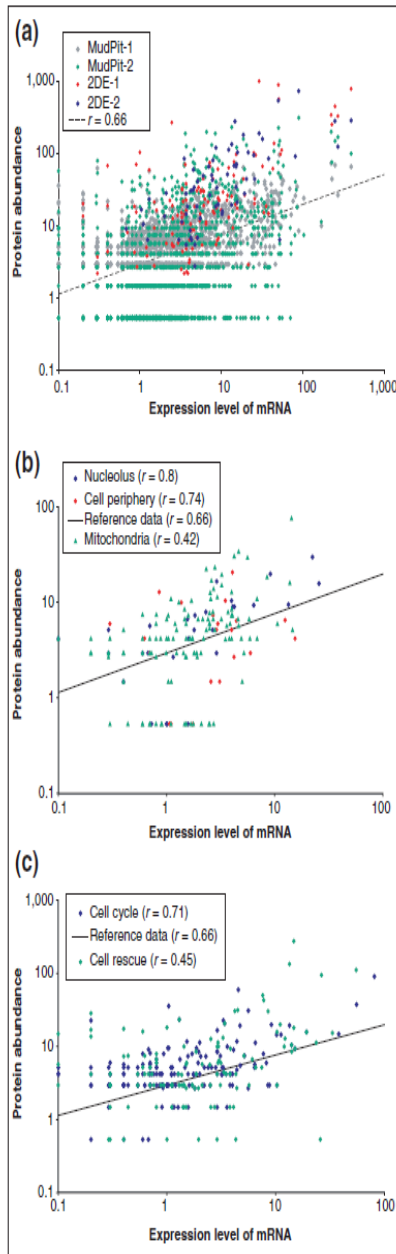

mRNA neznamená, že v buňce bude i protein

Historicky vždy velká neshoda mezi daty z expresních čipů a expresí proteinů (Western Blot)

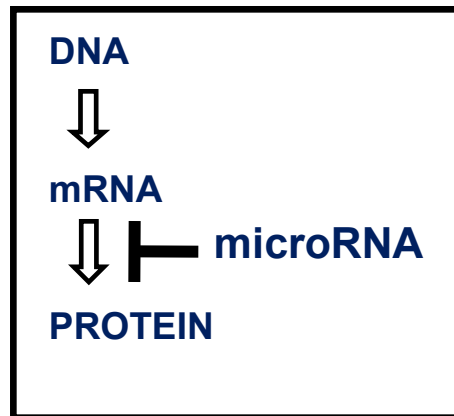

Specifika analýzy exprese microRNAs:

- velmi malé molekuly – 22nt – specifikum izolace, specifické značení i design sond
- malé zastoupení ve vzorku – separace microRNA
- v lidském genomu cca 2000 genů
- některé mají velmi podobnou sekvenci – rozdíl 1nt
- pre-miR, pri-miR, mature-miR
- málo se ví o jejich funkcích – obtížná interpretace výsledků
- zatím málo zkušeností a standardizace

Izolace

Microarrays

Identifikace miRNA (cloning a Northern blot)

Real-Time PCR

NGS

1/ Izolace a stabilita microRNA

Problémy: velikost 22nt, celkově cca 0,01% z celkové RNA

Izolace:

TRizol/TriReagent
miRvana (Ambion)
PureLink (Invitrogen)
a další

Obohacení:

PAGE
FlashPAGE Fractionator
(Ambion)

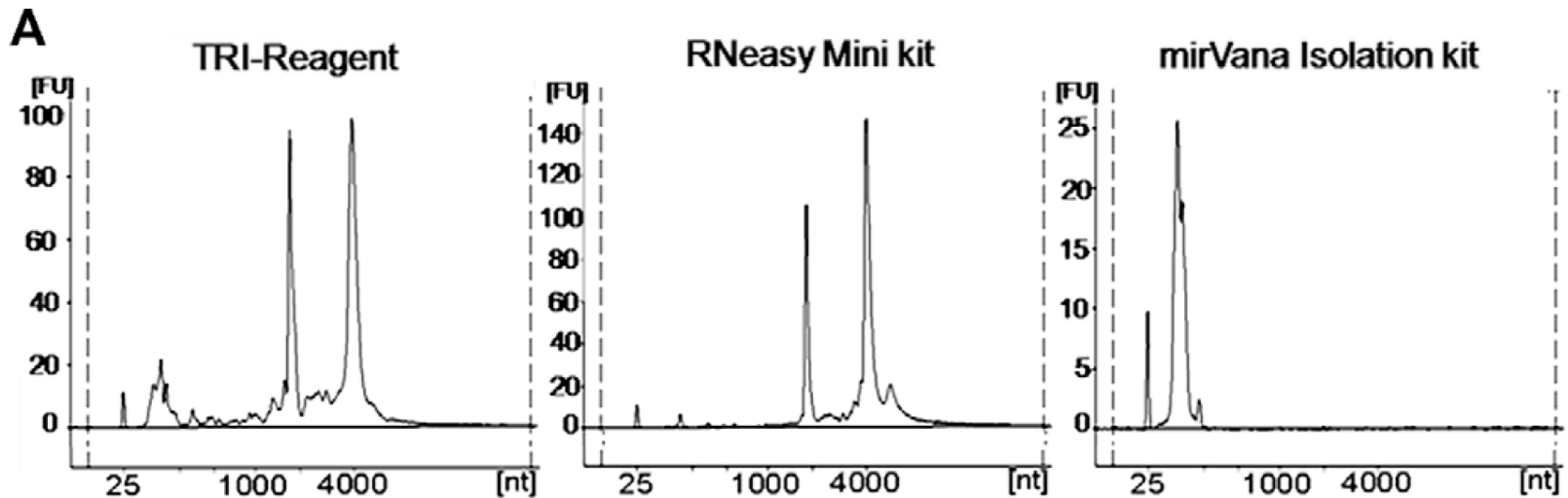

Mraz et al., 2009

Izolace:

TRizol/TriReagent
miRvana (Ambion)
PureLink (Invitrogen)
a další

Izolace:

TRIReagent/TRIzol
is the „gold standard“
(Mraz et al., 2009)

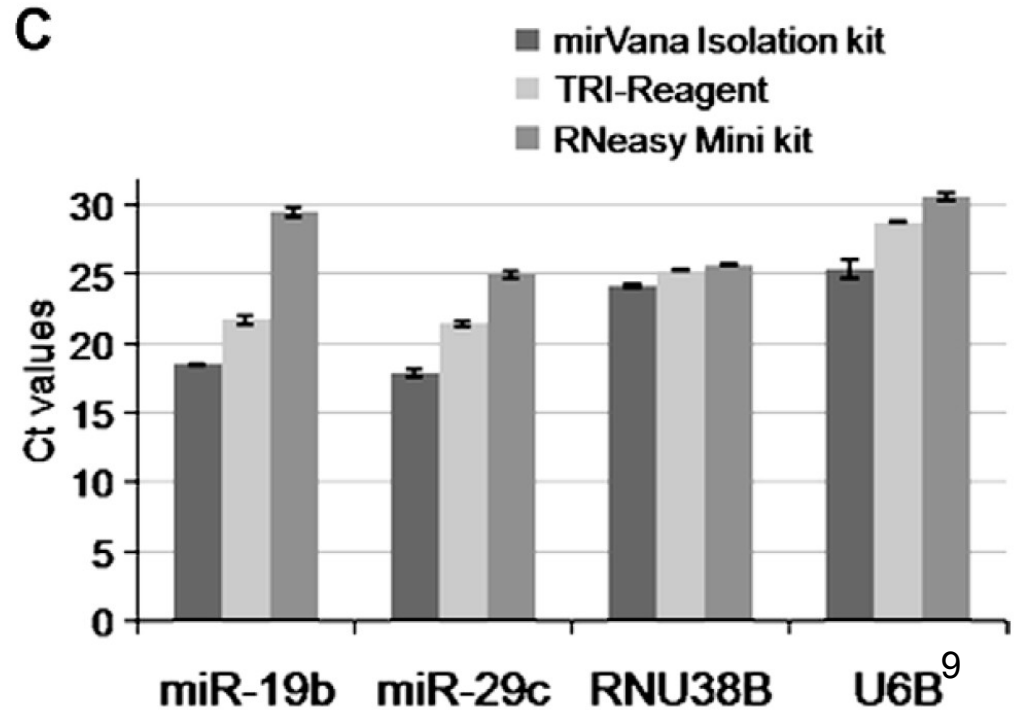
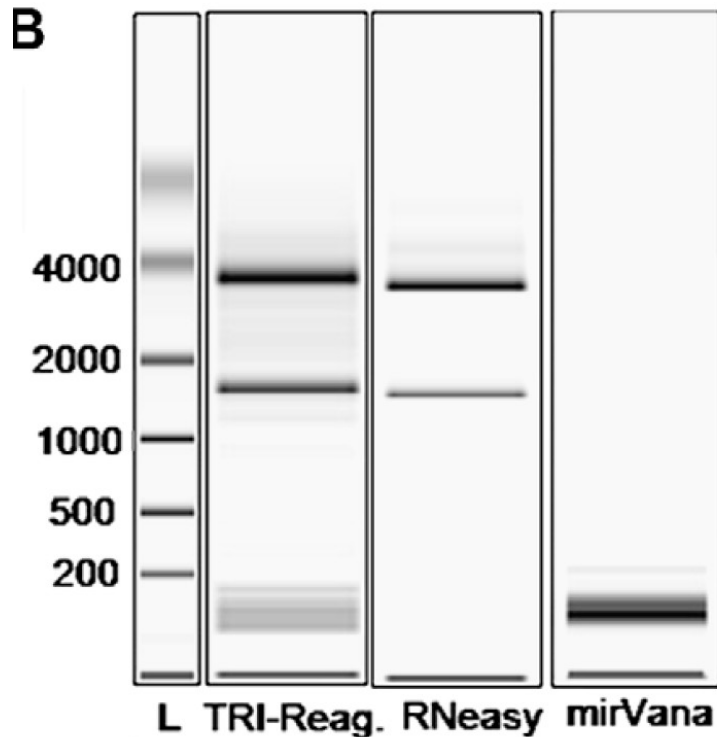
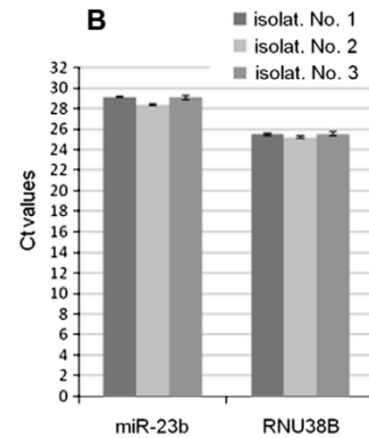

Obohaceni:

PAGE

FlashPAGE Fractionator (Ambion)



flashPAGE™ Protocol

1. Pipet flashPAGE™ Lower Running Buffer into the lower buffer chamber of the apparatus
<30 seconds
2. Insert a "ready-to-use," pre-cast flashPAGE™ Gel Cartridge
<5 seconds
3. Add flashPAGE™ Upper Running Buffer to the upper buffer chamber of the gel cartridge
<30 seconds
4. Add your RNA or DNA sample (with flashPAGE™ A40 Dye Marker)
<1 minute
5. Run gel at 70 V on any standard power supply
~12 minutes
6. Collect PAGE-purified nucleic acid from lower buffer chamber*
<30 seconds

Less than 15 minutes

Traditional PAGE Purification

1. Prepare gel solutions
30 minutes
 2. Cast gel
2 hours
 3. Pre-run the gel
30 minutes
 4. Load sample
1 minute
 5. Electrophorese
30-60 minutes
 6. Stain gel to visualize region of interest
10 minutes
 7. Excise desired size fraction
5 minutes
 8. Soak crushed gel with elution buffer
overnight
 9. Collect first elution and elute again
2 hours
- 22-24 hours

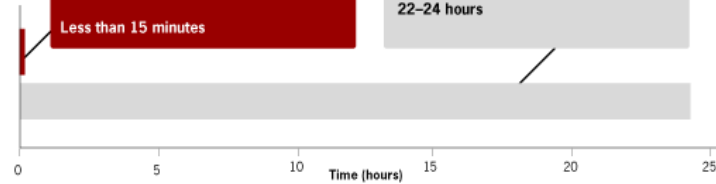

15min

20hours

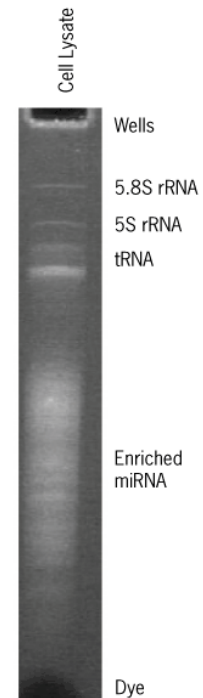
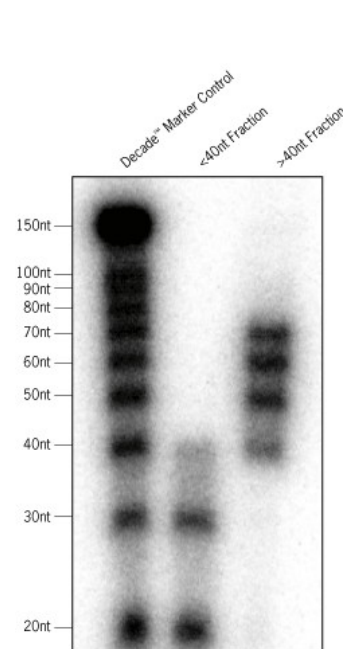

Stabilita microRNA :

Stabilita po izolaci

Stabilita v FFPE (formalin-fixed parafin-embedded tissue)

RNA

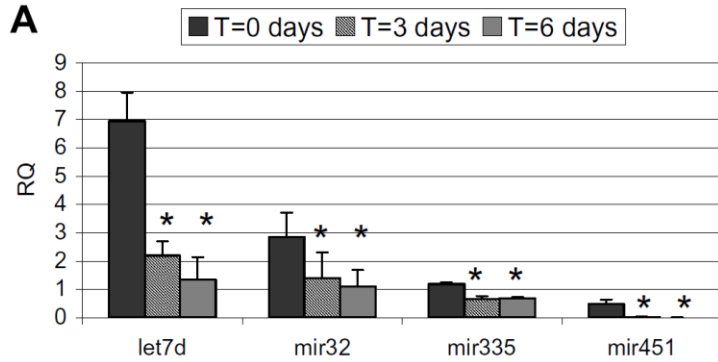

cDNA

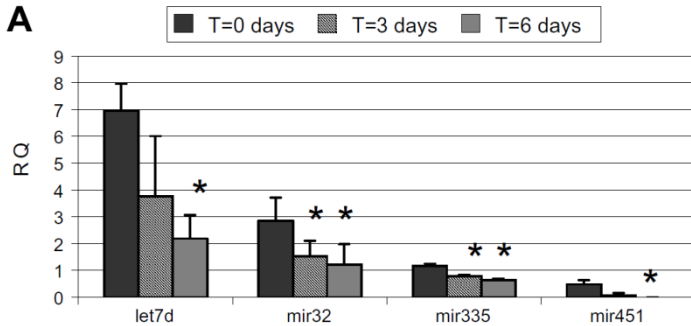

Bravo et al., 2007

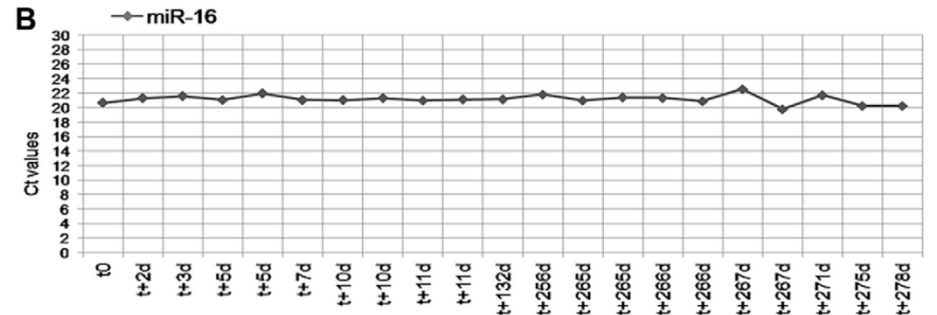
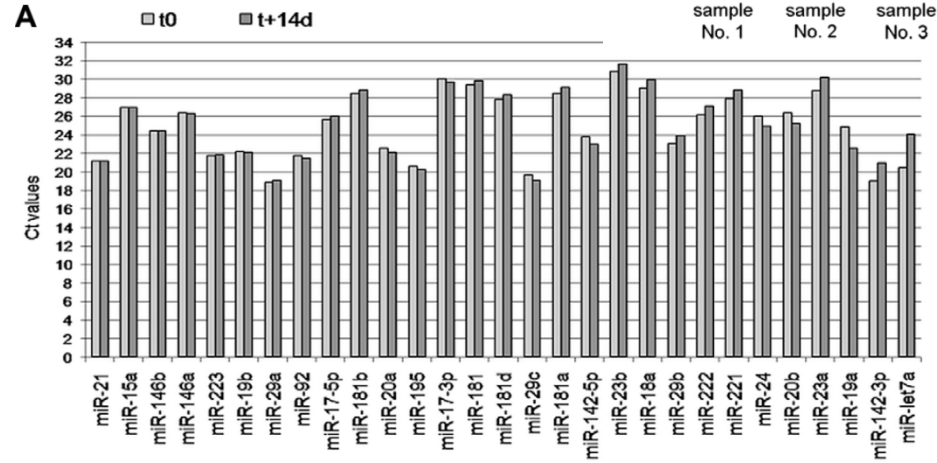
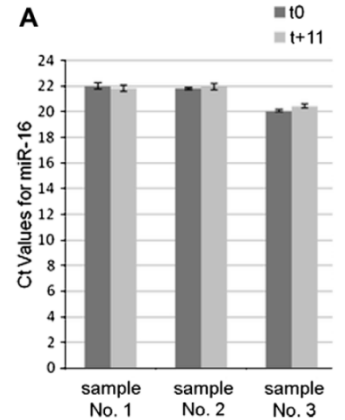

Mráz et al., 2009

Stabilita microRNA :

Stabilita v FFPE (formalin-fixed parafin-embedded tissue)

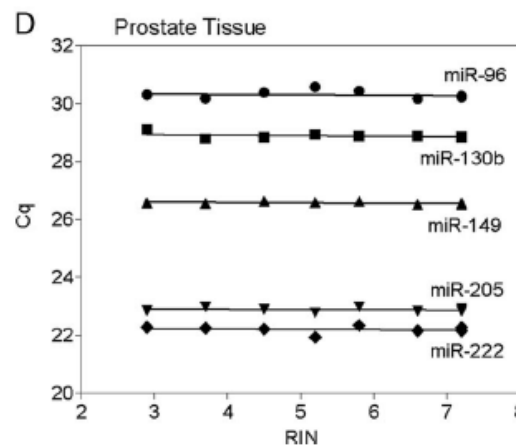
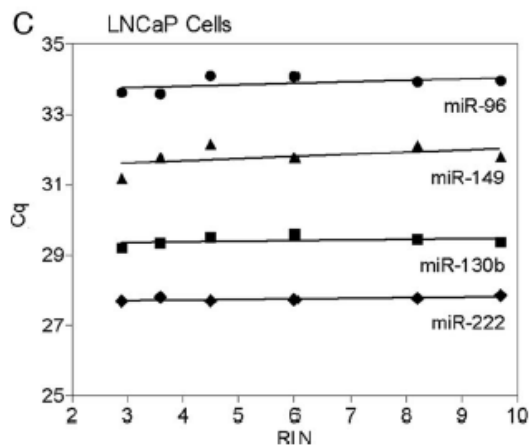
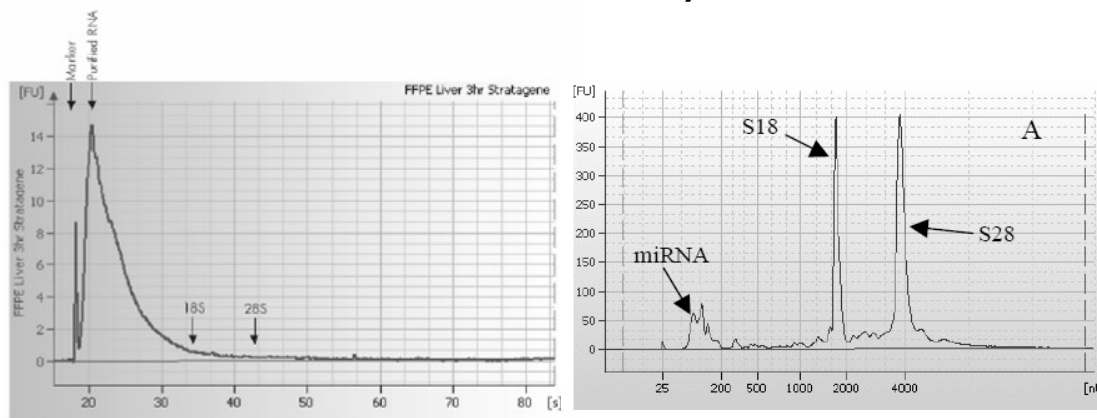
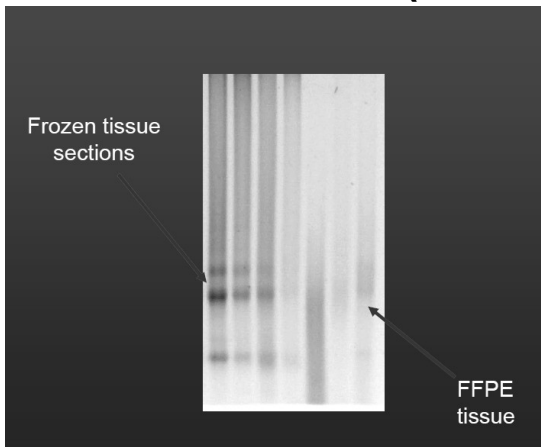
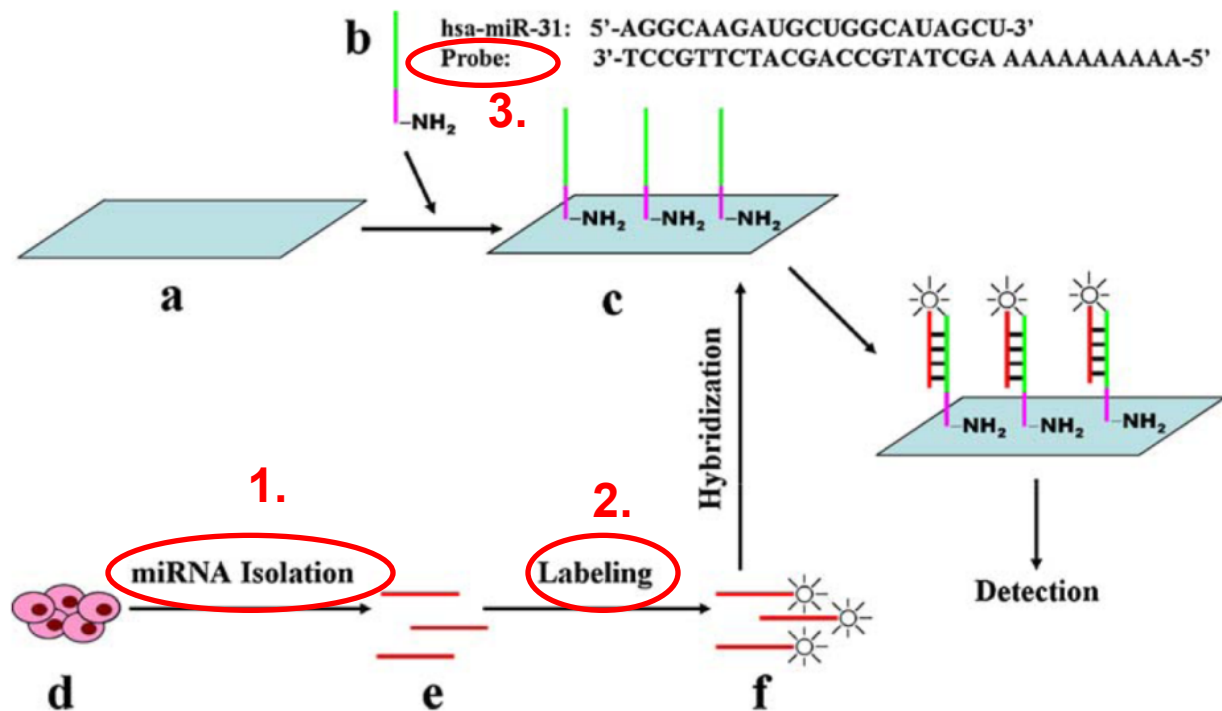

Fig. 2. Influence of RNA integrity on miRNA gene expression.

(A), miR-141, miR-155, miR-200c, and miR-210 in RNA samples from ccRCC cell line Caki-2. (B), miR-141, miR-155, miR-200c, and miR-210 in RNA samples from the renal tissue pool. (C), miR-96, miR-130b, miR-149, and miR-222 in RNA samples from PCa cell line LNCaP. (D), miR-96, miR-130b, miR-149, miR-205, and miR-222 in RNA samples from the prostate tissue pool. For further details, including regression line characteristics, 95% CIs of the slopes, and *P* values indicating significant deviations from 0, see Table 5 in the online Data Supplement.

Expression microarrays pro microRNAs:

- velmi malé molekuly – 22nt – specifikum izolace, specifické značení i design sond
- malé zastoupení ve vzorku – separace microRNA
- v lidském genomu cca 2000 genů – menší počet sond na čipu
- některé mají velmi podobnou sekvenci – rozdíl 1nt
- pre-miR, pri-miR, mature-miR
- málo se ví o jejich funkcích – obtížná interpretace výsledků
- zatím málo zkušeností a standardizace



3/ Labeling – značení:

- ❑ Není možný labeling pomocí značených polyT při reverzní transkripci
- ❑ Přímé značení (direct labeling) – většinou nějaká fluorescenční barva
- ❑ Nepřímé značení (indirect labeling) – probíhá nějaká reverzní transkripce/PCR

Přímé značení:

Jednoduché, rychlé a „čím méně kroků tím méně vnesených chyb a variability“

1/ Značení guaninu v microRNA

Fluochromem vážícím se na guanin jsou označeny miRNA (Ulysis Alexa Flour 546/647)

Všechny lidské miRNA obsahují guanin, ale v různém množství

Nemožnost usuzovat na vzájemnou expresi různých miRNA (různý obsah guaninu)

(Babak et al., 2004)

2/ Značení pomocí Poly (A) polymerázy

Můžu se rozhodnout jak dlouhý bude poly(A)

a tím ovlivnit sílu signálu

(Shingara et al., 2005)

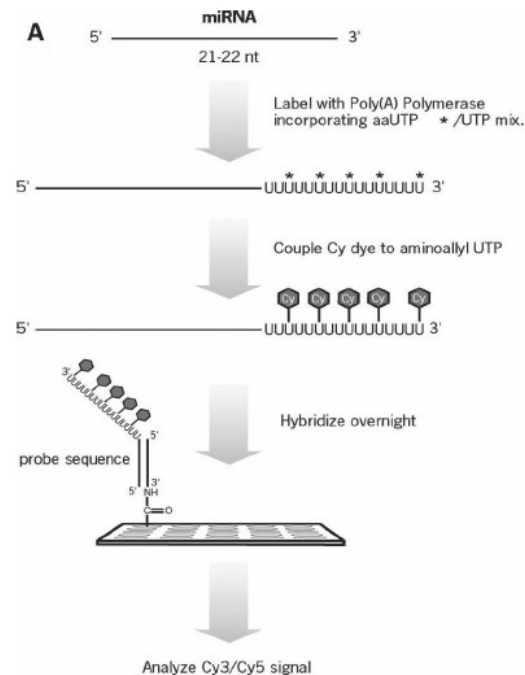

4/ značení pomocí T4 ligasy

Krátký značený oligonukleotid

je připojen T4 ligásou k 3'konci

Výhodou je přednostní vazba

na RNA o velikosti 18-30bp ->total RNA

(Thomson et al., 2004; Castoldi et al., 2007)

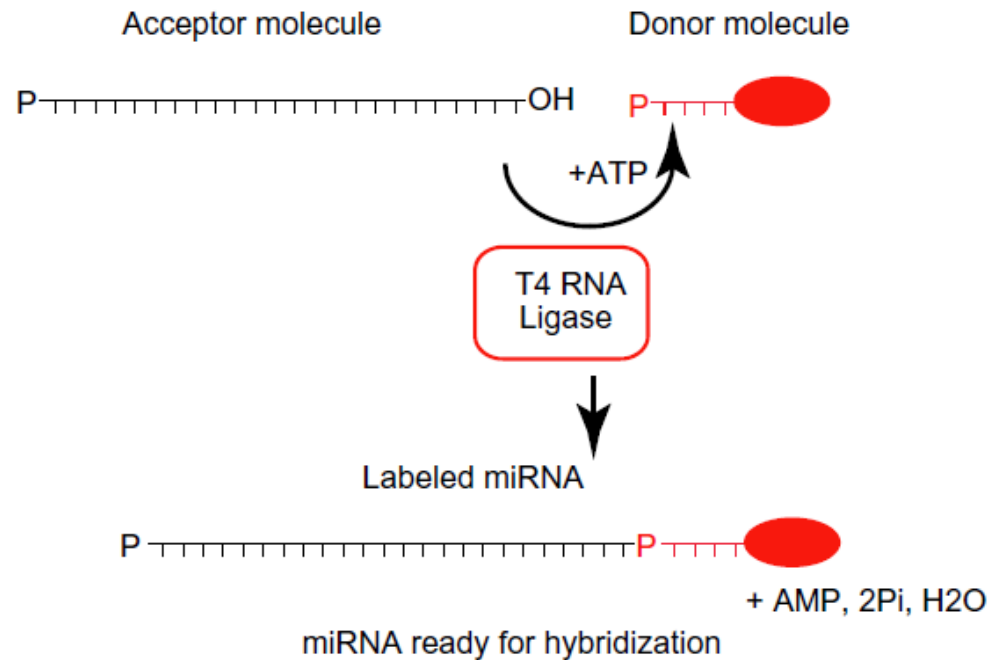

Fig. 2. Schematic representation of the miRNA labeling principle: a short Cy-dye labeled RNA-linker (donor molecule) is ligated to the single-stranded miRNA (acceptor molecule) by T4 RNA ligase in the presence of ATP.

Nepřímé značení:

Značen je produkt reverzní transkripce či PCR

Výhody: cDNA je pak stabilní a lze uchovat, Pre-amplifikace a tím snadnější detekce méně exprimovaných miRNA

1/ značení reverzního transkriptu miRNA

Reverzní transkripce pomocí náhodných 8-merů značených 2 biotiny (3'-(N)8 – (A)12-biotin-(A)12-biotin-5' (Liu et al., 2004)

Reverzní transkripce pomocí náhodných neznačených 7-merů, následně označeny s pomocí terminální transferázy a biotin-dideoxy-UTP (Sun et al., 2004)

Nebezpečí chyb z nespecifické vazby primeru

2/ značení produktu RT-PCR

Výhoda: snadná pre-amplifikace

Dva adaptory

fluorescenčně-značený primer (k adaptoru)

(Miska et al., 2004)

Nevýhoda: antisense strand přiroten při hybridizaci

Rešením je různá délka sense a antisense ->PAGE

(Baskerville, 2005)

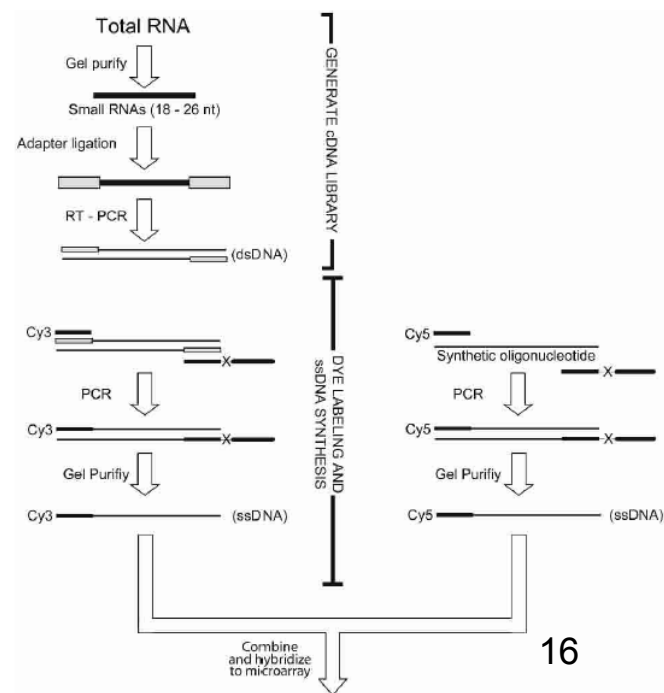

3/ Microarrays/ Próby: Problémy: krátké RNA, malé rozdíly v sekvenci, Tm

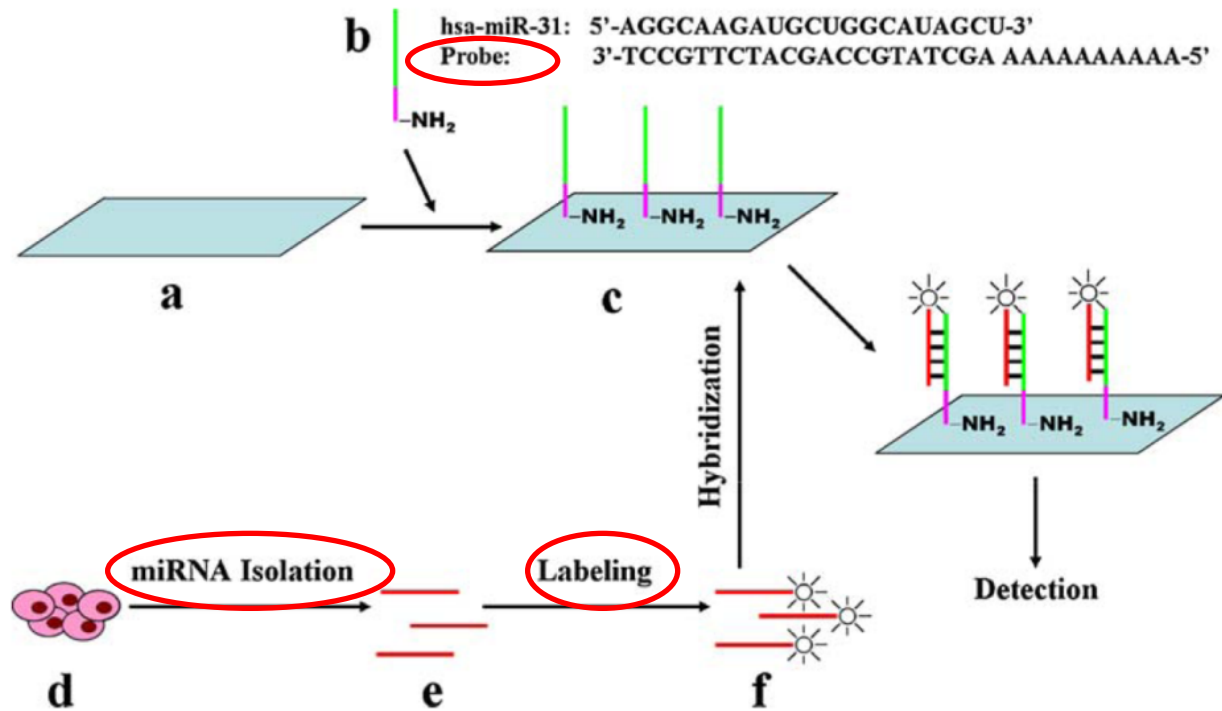

T_m – melting temperature určité próby
T – hybridizační teplota

$T_m < T$ nižší efektivita vazby miRNA
 $T_m > T$ vyšší efektivita vazby miRNA

- Je třeba navrhnout próby tak, aby měly všechny podobnou T_m
- To se u „dlouhých“ mRNA řeší vhodným výběrem oblasti genu k němuž bude sonda komplementární nebo délkou sondy
- navíc některé miRNA jsou téměř sekvenčně totožné

```
let-7b : TGAGGTAGTAGGTTGTGTGGTT : 22
let-7e : TGAGGTAGGAGGTTGTATAGT- : 21
let-7d : AGAGGTAGTAGGTTGCATAGT- : 21
let-7a : TGAGGTAGTAGGTTGTATAGTT : 22
let-7f : TGAGGTAGTAGATTGTATAGTT : 22
let-7i : TGAGGTAGTAGTTTGTGCT--- : 19
let-7g : TGAGGTAGTAGTTTGTACAGT- : 21
      tGAGGTAGtAG TTGt gt
```

ÚPRAVA DÉLKY

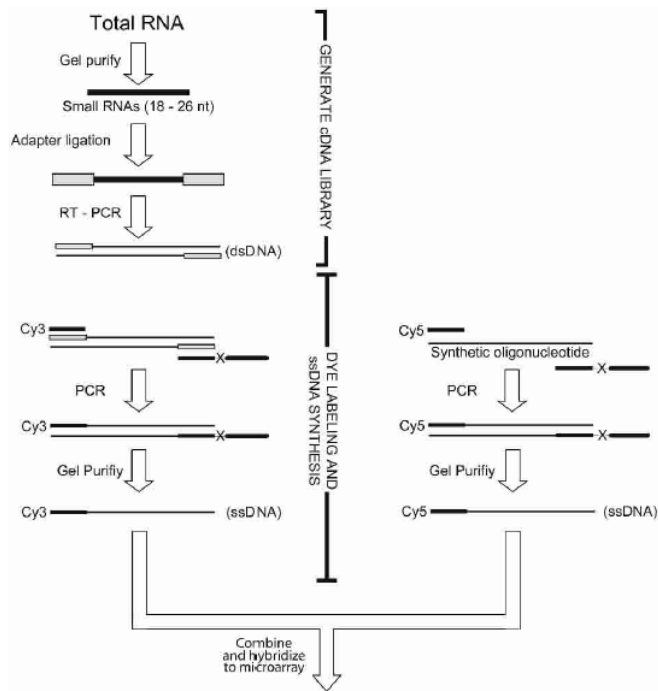
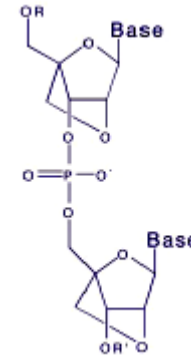

FIGURE 1. Microarray sample preparation and reference oligonucleotide synthesis. Small RNAs were fractionated on a polyacrylamide gel, and oligonucleotide primers were then ligated to the 5' and 3' ends of the small RNA library (Lau et al. 2001). A cDNA library was generated through reverse transcription, and the product was amplified using PCR. Using a pair of modified oligonucleotide primers in a second PCR, the sense strand of the library was fluorescently labeled and the antisense strand was selectively lengthened (Williams and Bartel 1995). The sense strand of the asymmetric duplex was purified away from the antisense strand in a denaturing gel, and this purified dye-labeled ssDNA sample was used for hybridization and detection on the array. At each feature, the signal from the miRNA sample was compared to that from a reference sample, which had been generated by amplifying and labeling synthetic oligonucleotides using the same strategy as for the miRNA sample.

ÚPRAVA SÍLY VAZBY NUKLEOTIDŮ

LNA próby (Locked Nucleic Acid)

ribózový kruh je „uzamčen“ methylenovým můstkem mezi atomy 2'-O a 4'-C



Použití LNA pro některé báze v próbě

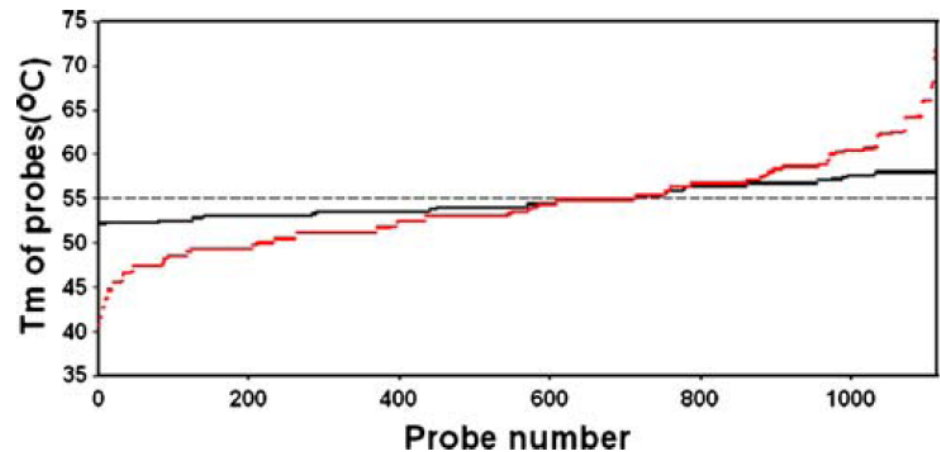

Fig. 2 T_m (melting temperature) distribution for microRNA probes for human, rat and mouse. *Red and black curves* represent the T_m distributions of the raw and normalized probes, respectively

**SÍLA VAZBY:
LNA vs DNA próba
Tm až 72°C
(Castoldi et al., 2006)**

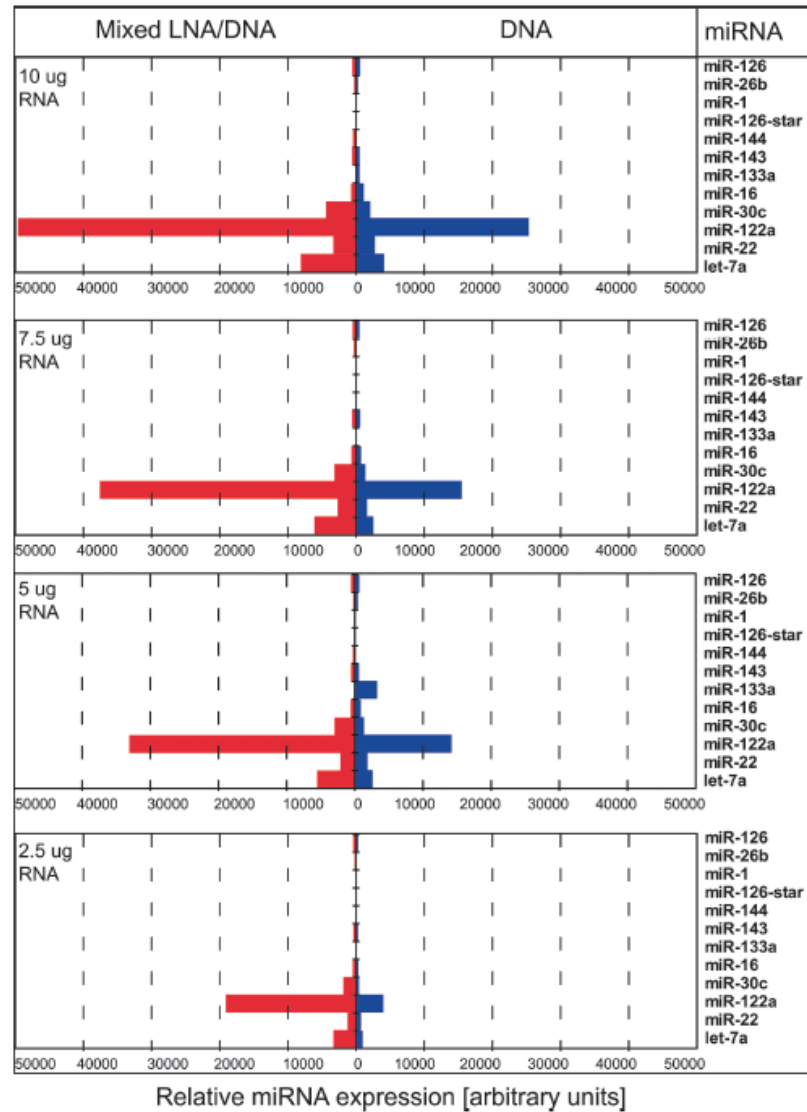
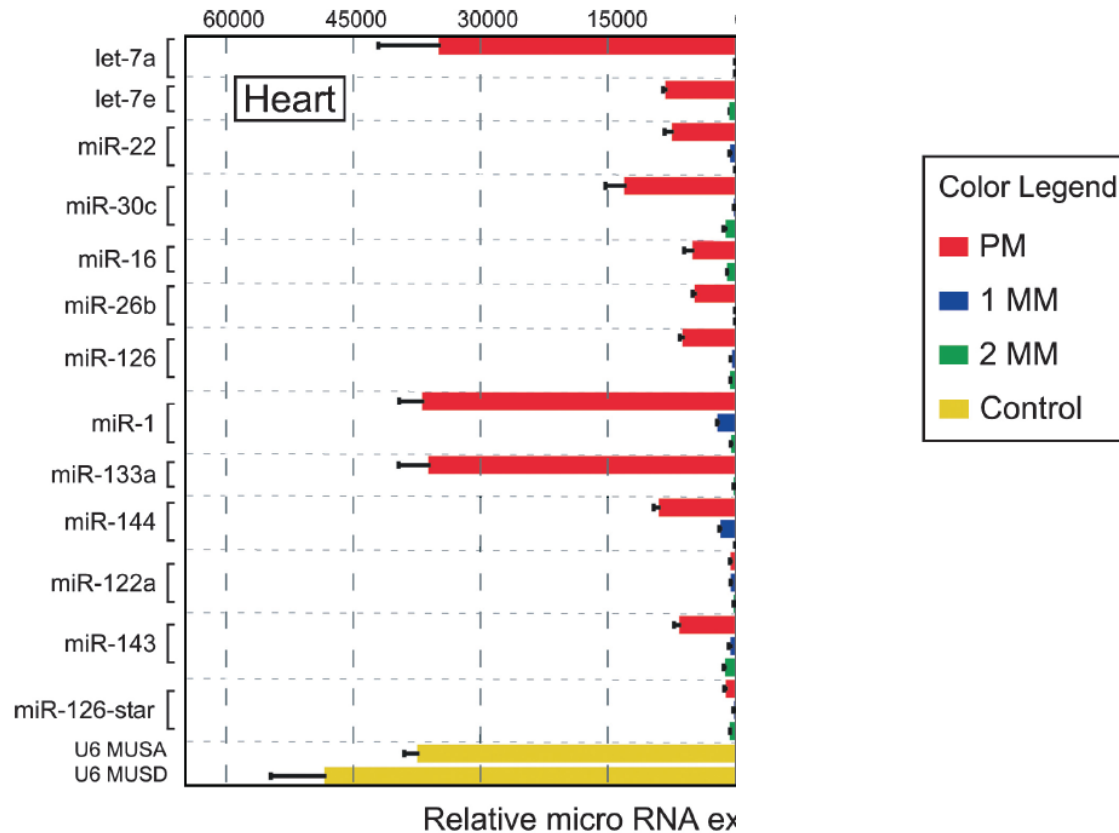

FIGURE 1. Mixed DNA/LNA capture probes display increased sensitivity for miRNA detection. miRNA expression was assessed in murine liver using a test set of LNA-modified (*left*) or unmodified DNA oligonucleotide capture probes (*right*). Decreasing amounts of total RNA were used as input material for miRNA analysis. Data are presented as median intensity (four replicas per miRNA capture probe; a representative experiment is shown).

SPECIFITA VAZBY: LNA vs DNA próba

(Castoldi et al., 2006)



miRCURY LNA Array, Exiqon : 3 dny

Protocol overview

miRCURY™ LNA microRNA Power Labeling Kit

CIP treatment

Mix: RNA sample
Spike-In miRNA kit



Labeling reaction

Mix: CIP'ed RNA sample
Labeling buffer
Hy3™ or Hy5™
DMSO
Enzyme



miRCURY™ LNA microRNA Array Kit

Mix samples

Mix: Hy3™ labeled sample
Hy5™ labeled sample
Hybridization buffer
Denature sample



Hybridize

Hybridize at 56°C for 16 hours



Stringency wash

Wash 2 min. in buffer A at 56°C
Wash 2 min. in buffer B at 23°C
Wash 2 min. in buffer C at 23°C
Dry slides



Image acquisition

Scan slides (recommended scan at 5µm)
Download relevant GAL files from
www.exiqon.com

Co se nemusí podařit:

Nekvalitní RNA

Nepodaří se značení

Nepodaří se hybridizace

Nepodaří se promývání

Technická variabilita čipů je větší než ta biologická

Nepodaří se validace dat pomocí RT-PCR, atd

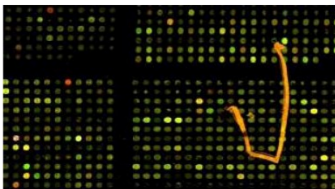

Fiber or scratch?

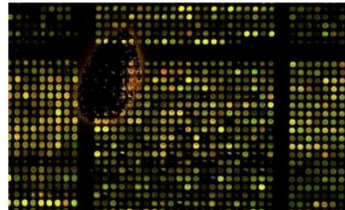

Bubble

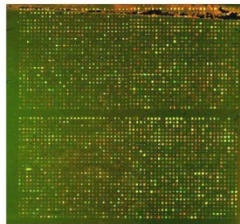

Edge effect

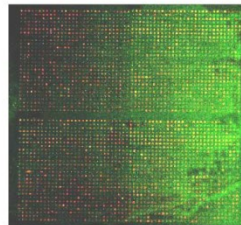

Background haze

Práce s miRNA čipy je velmi obtížná. Všeobecně nižší míra standardizace. Obtížná interpretace získaných dat z pohledu biologického smyslu např. deregulace několika miRNA (nádor vs. zdravá tkáň apod.)

RT-PCR

TaqMan-based real-time PCR quantification of mature miRNAs

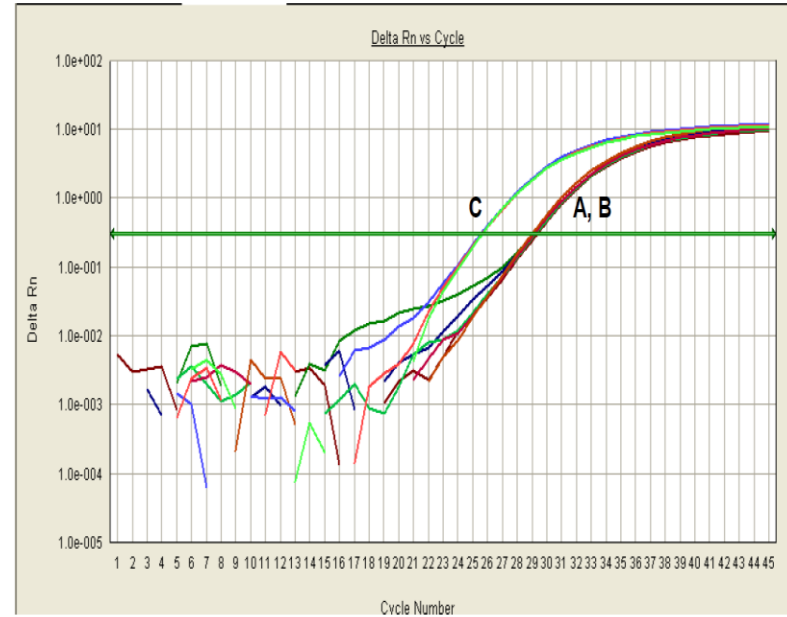
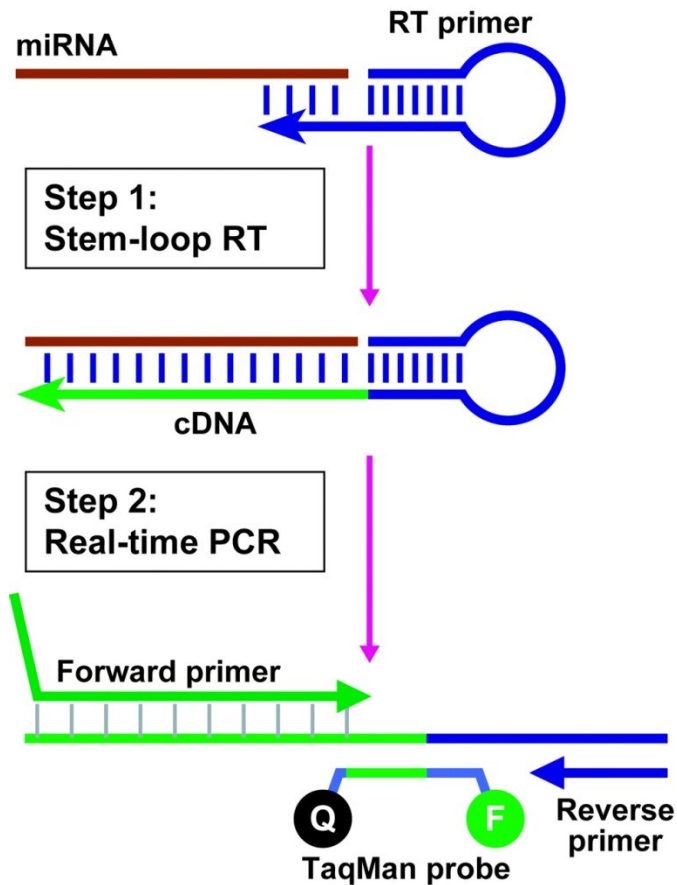

RNA Seq

Sanger vs NGS

‘Sanger sequencing’ has been the only DNA sequencing method for 30 years

.....

NGS has the ability to process millions of sequence reads in parallel rather than few at a time

Next Generation Sequencing

- Takes advantage of miniaturization to engage in massively parallel analysis
 - Essentially carrying out millions of sequencing reactions simultaneously in each of 10 million tiny wells
- Sophisticated computer analysis of huge amounts of information allows “assembly” of a given sequence

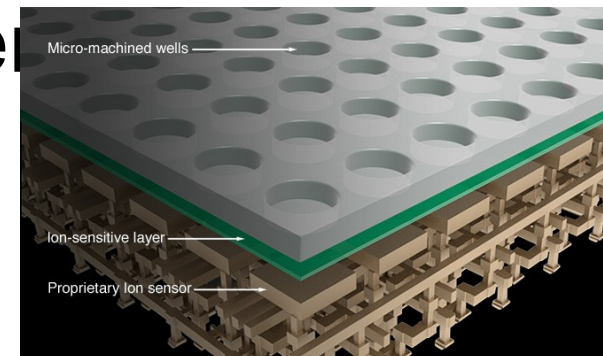

High Parallelism is Achieved in Polony Sequencing

Sanger

Polony

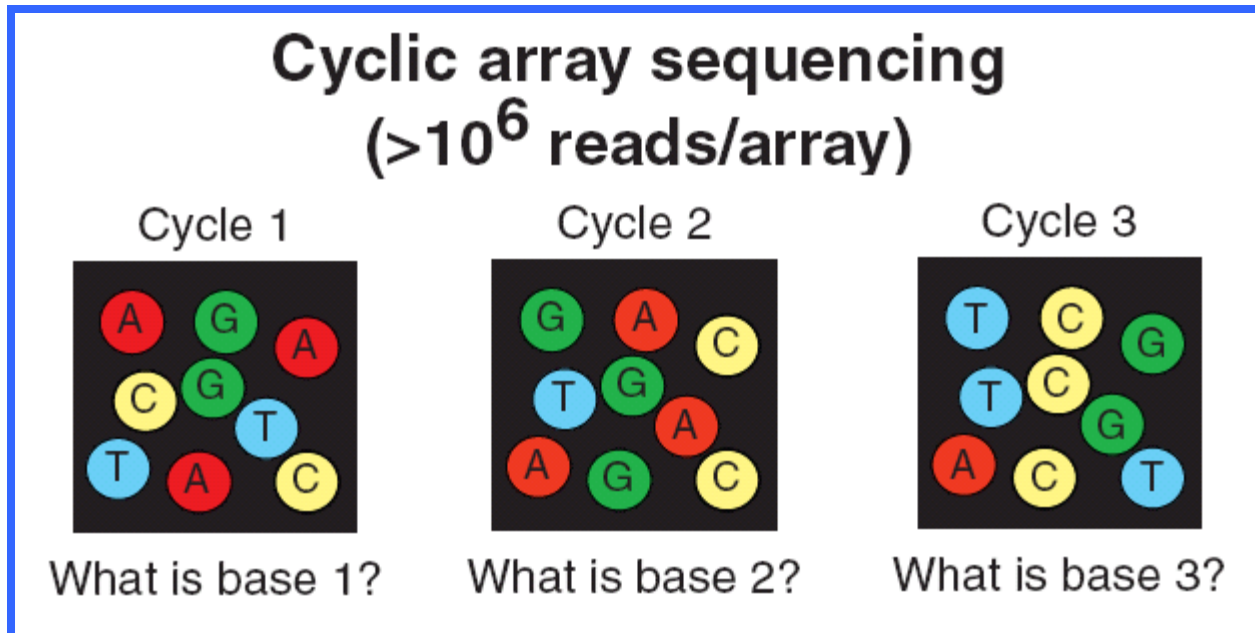

A. Library Preparation

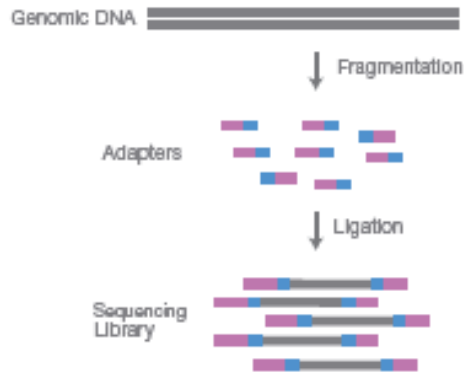

NGS library is prepared by fragmenting a gDNA sample and ligating specialized adapters to both fragment ends.

A. Cluster Amplification

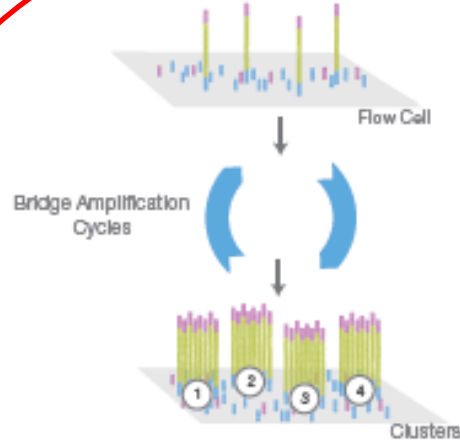

Library is loaded into a flow cell and the fragments hybridize to the flow cell surface. Each bound fragment is amplified into a clonal cluster through bridge amplification.

This is the trick

C. Sequencing

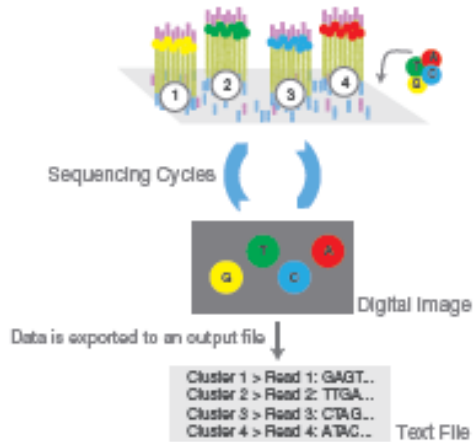

Sequencing reagents, including fluorescently labeled nucleotides, are added and the first base is incorporated. The flow cell is imaged and the emission from each cluster is recorded. The emission wavelength and intensity are used to identify the base. This cycle is repeated "n" times to create a read length of "n" bases.

D. Alignment & Data Analysis

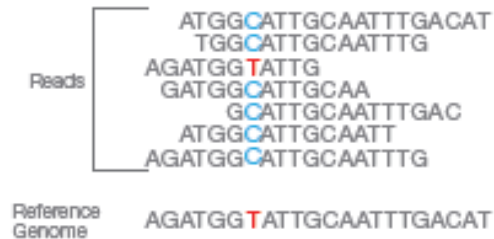

Reads are aligned to a reference sequence with bioinformatics software. After alignment, differences between the reference genome and the newly sequenced reads can be identified.

E



Two PCR primers are attached to the surface of flowcell. One of the primers has a cleavable site

Surface of flow cell coated with a lawn of oligo pairs

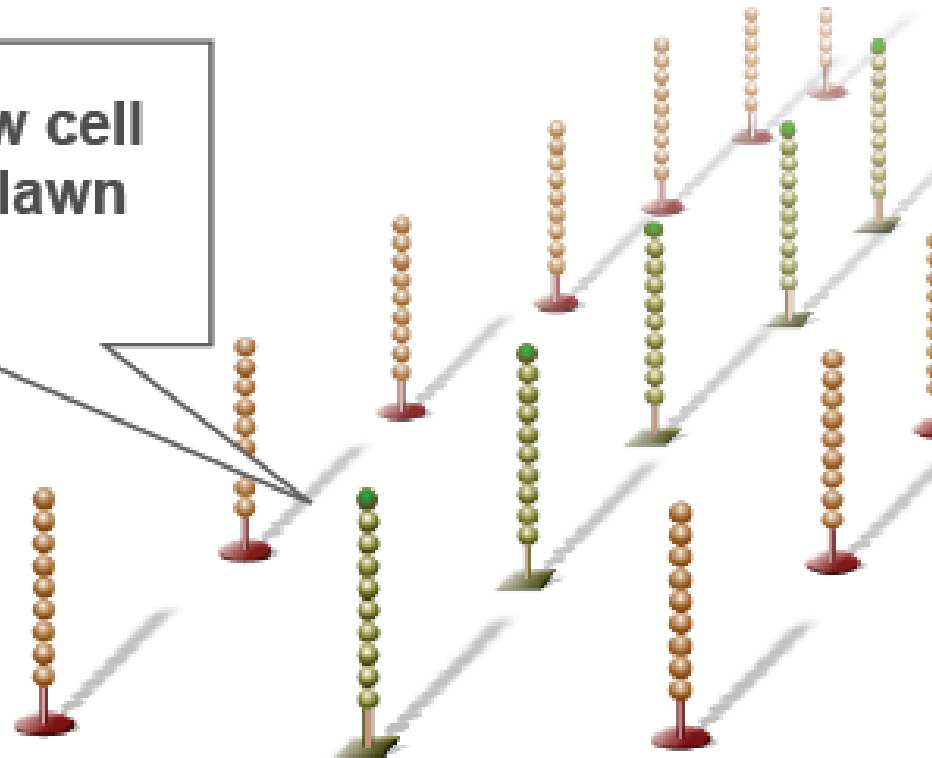

Hybridize Fragment & Extend

Single DNA libraries are hybridized to primer lawn

Bound libraries are then extended by polymerases

Surface of flow cell coated with a lawn of oligo pairs

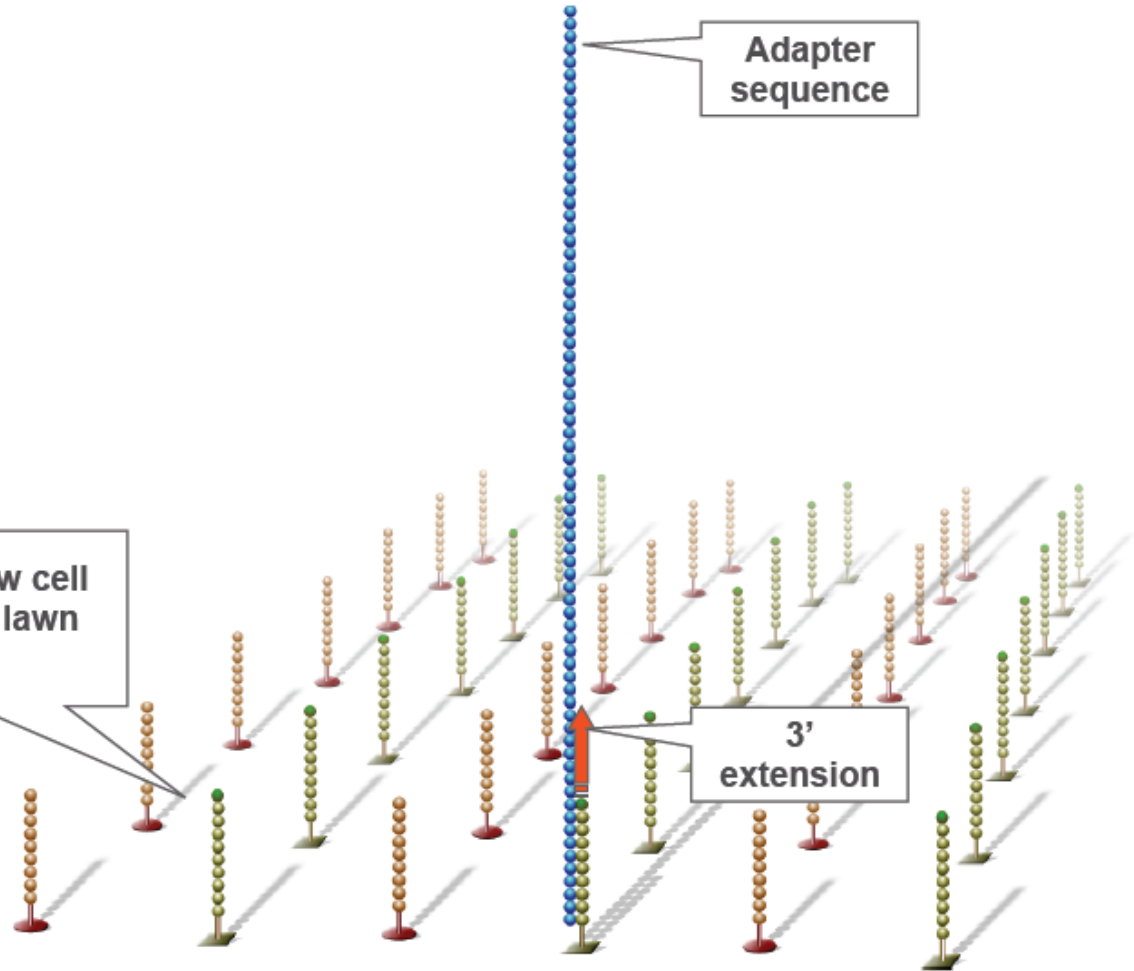

Denature Double-Stranded DNA

Double-stranded molecule is denatured

Original template washed away

Newly synthesized strand is covalently attached to flow cell surface

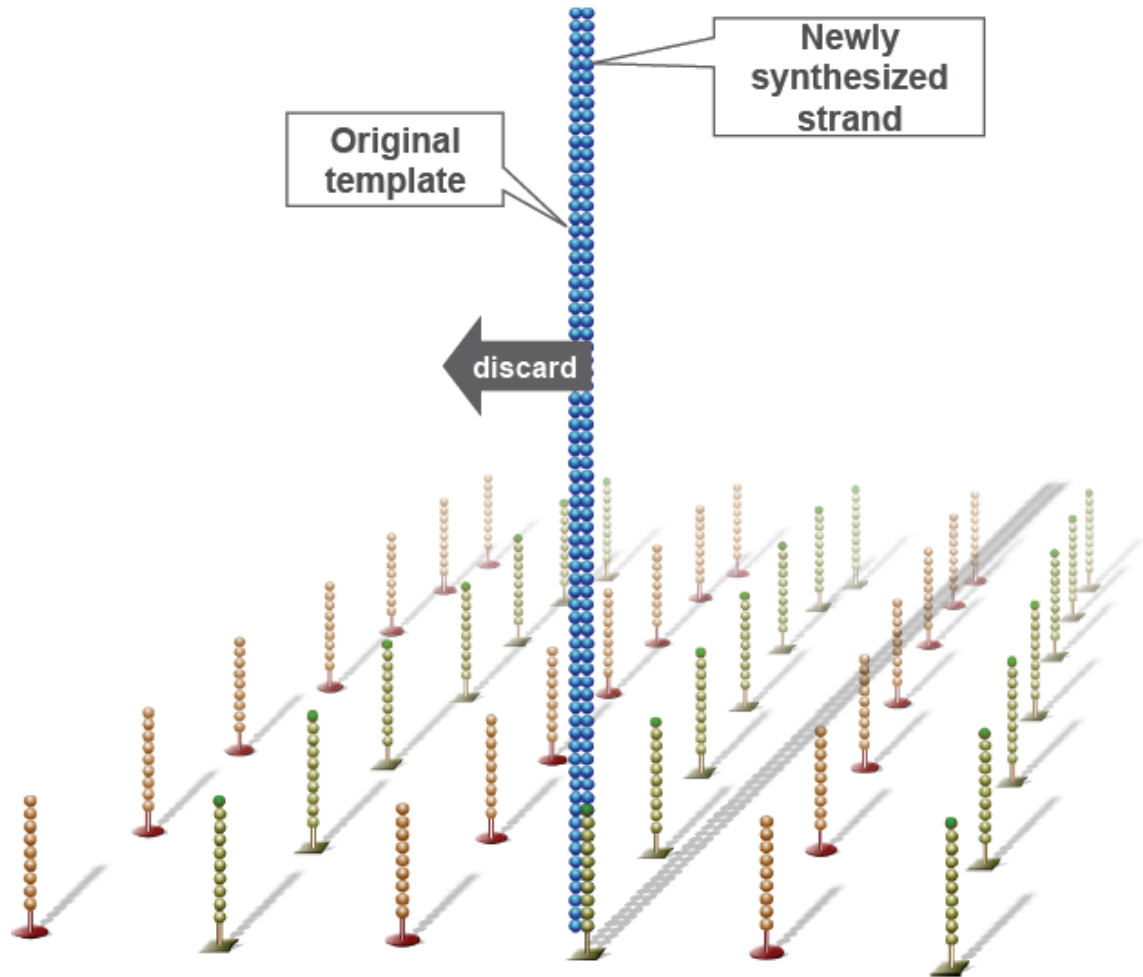

Single-Stranded DNA

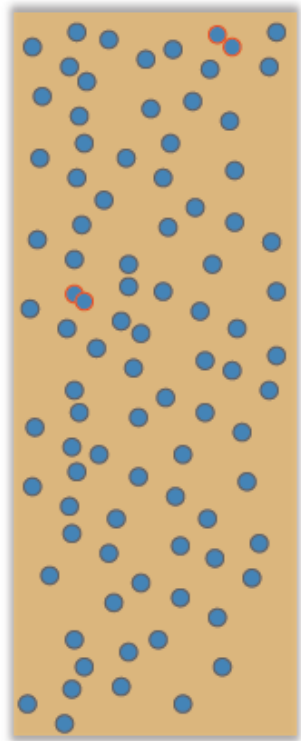

NOTE:
Single molecules bind
to flow cell in a
random pattern

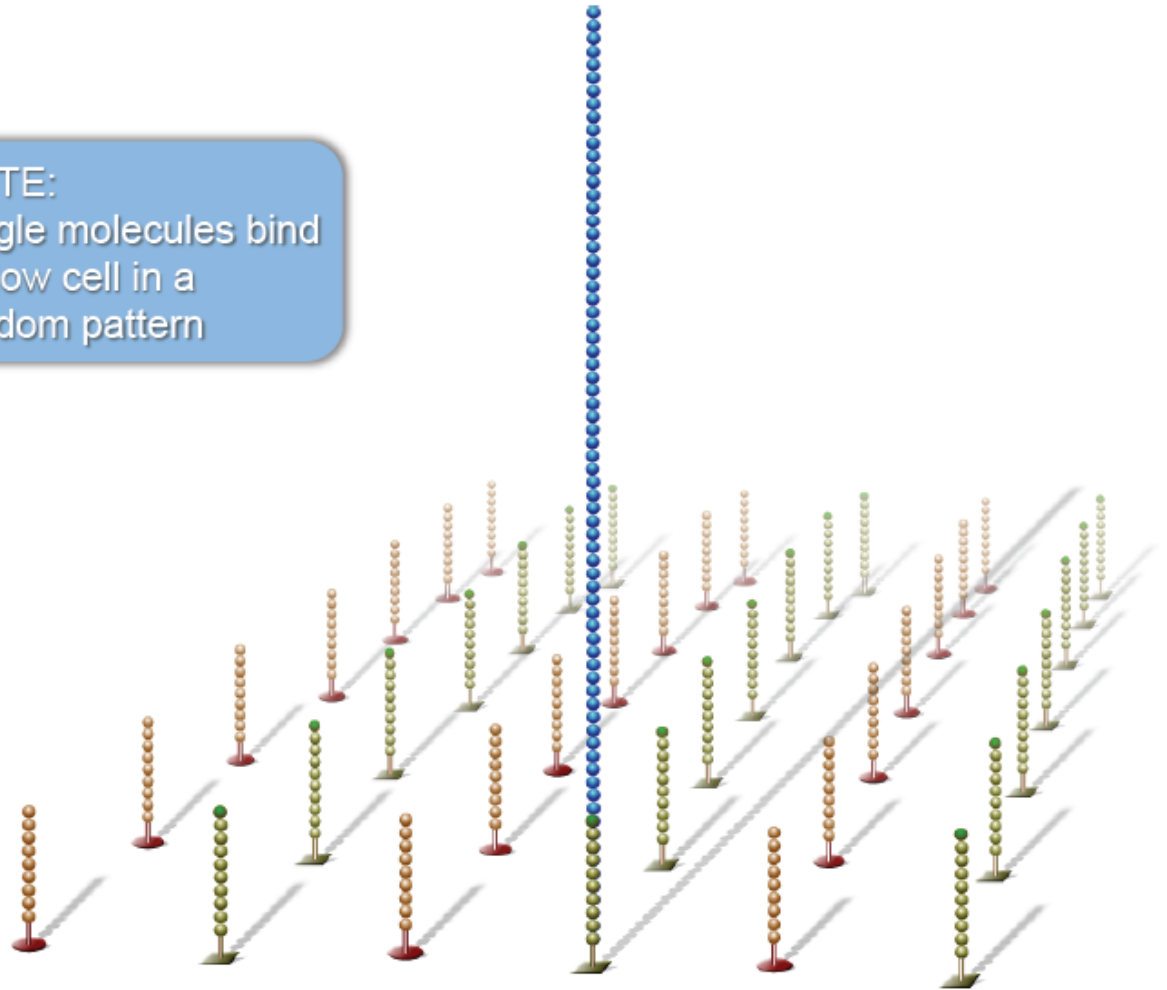

Bridge Amplification

Single-stranded molecule flips over and forms a bridge by hybridizing to adjacent, complementary primer

Hybridized primer is extended by polymerases

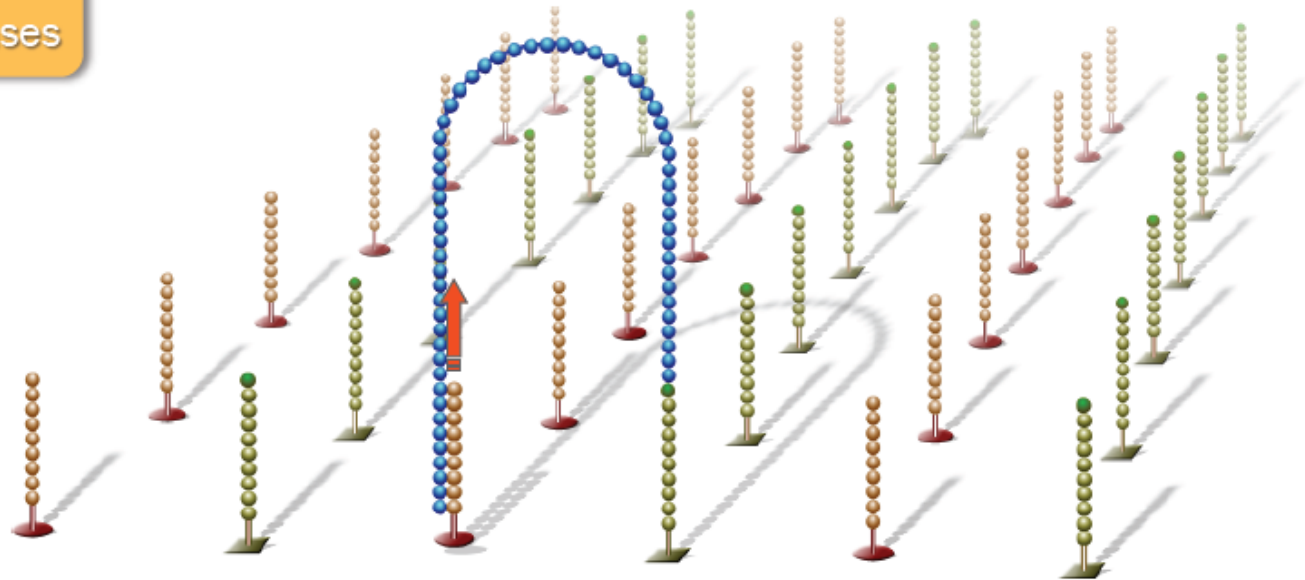

Bridge Amplification

Double-stranded bridge is formed

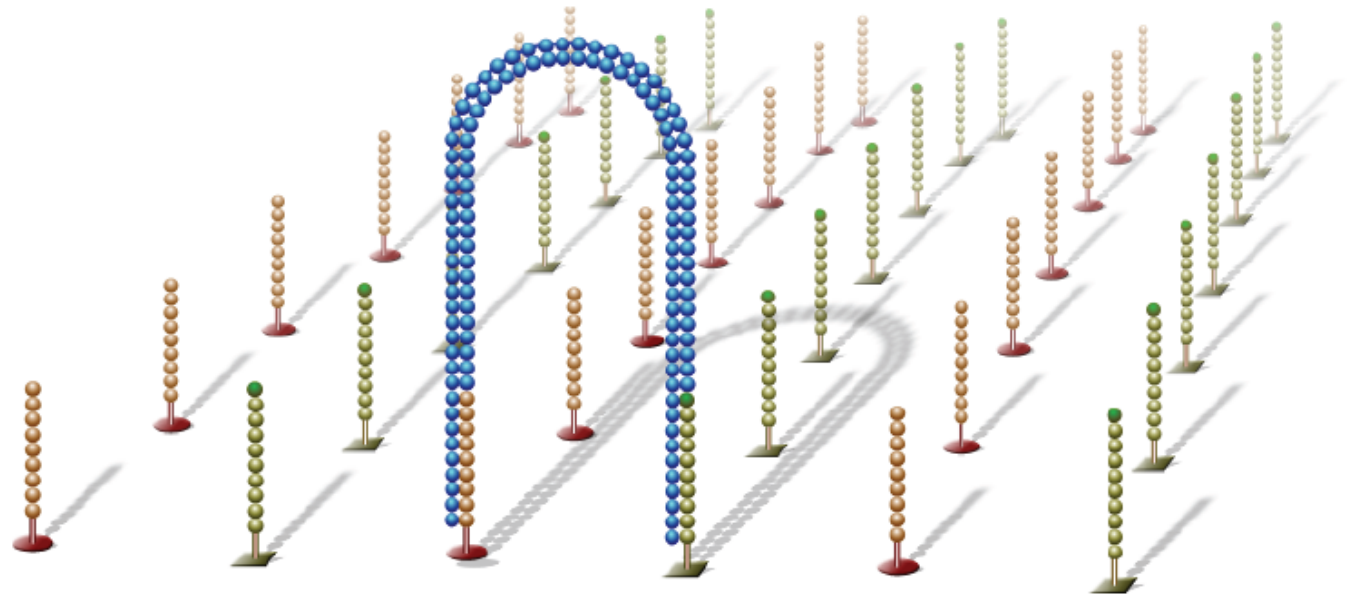

Denature Double-Stranded Bridge

Double-stranded bridge is denatured

Result:
Two copies of covalently bound single-stranded templates

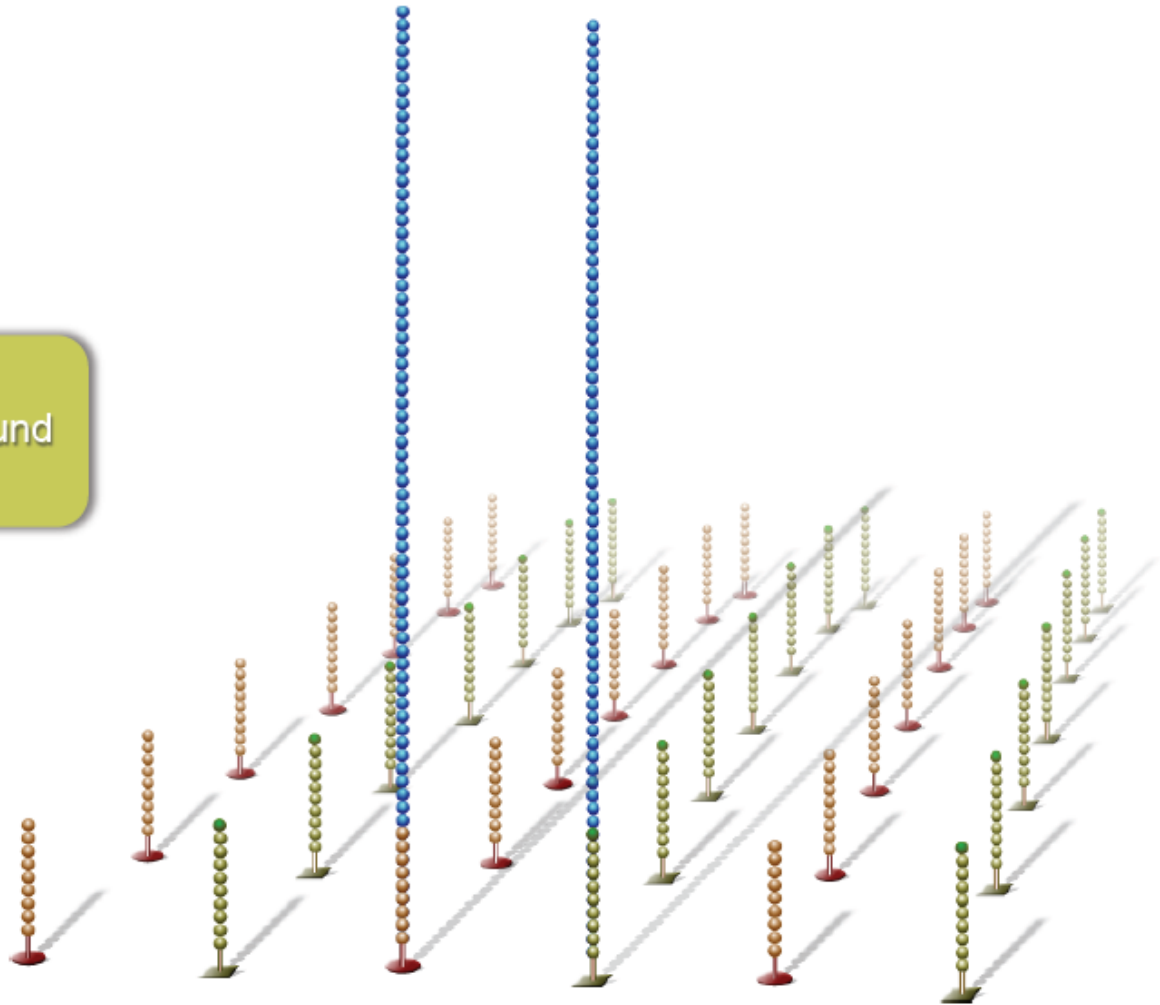

Bridge Amplification

Single-stranded molecules flip over to hybridize to adjacent primers

Hybridized primer is extended by polymerase

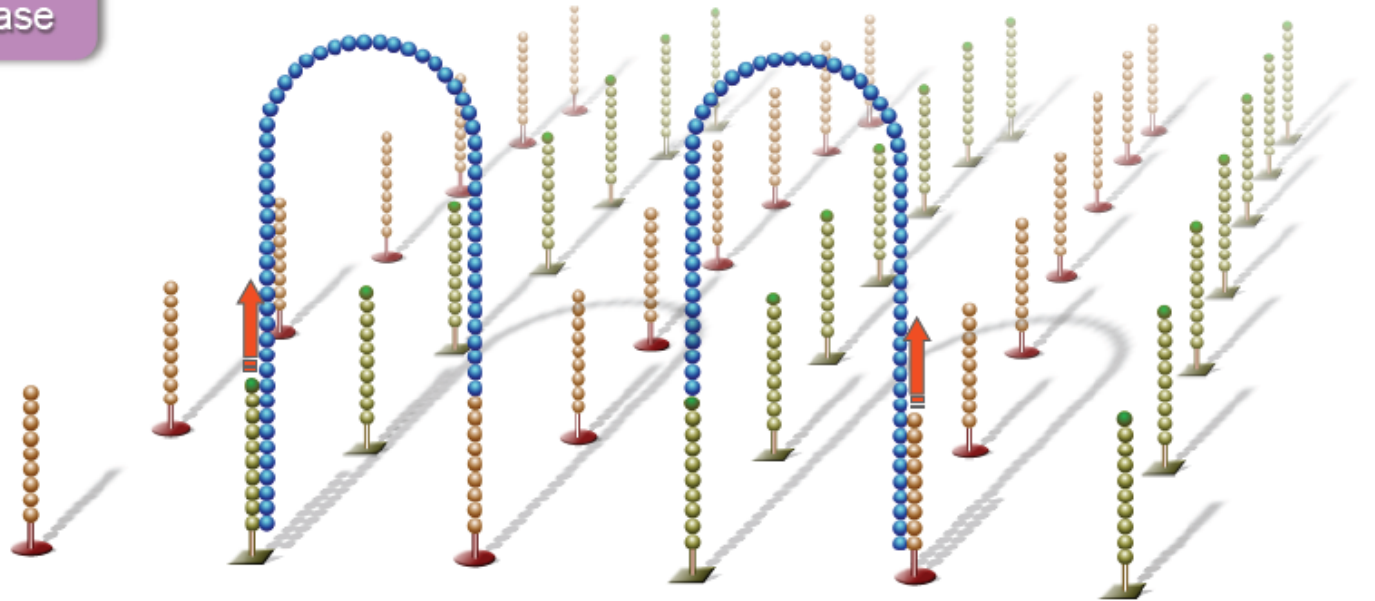

Bridge Amplification

Bridge amplification cycle is repeated until multiple bridges are formed

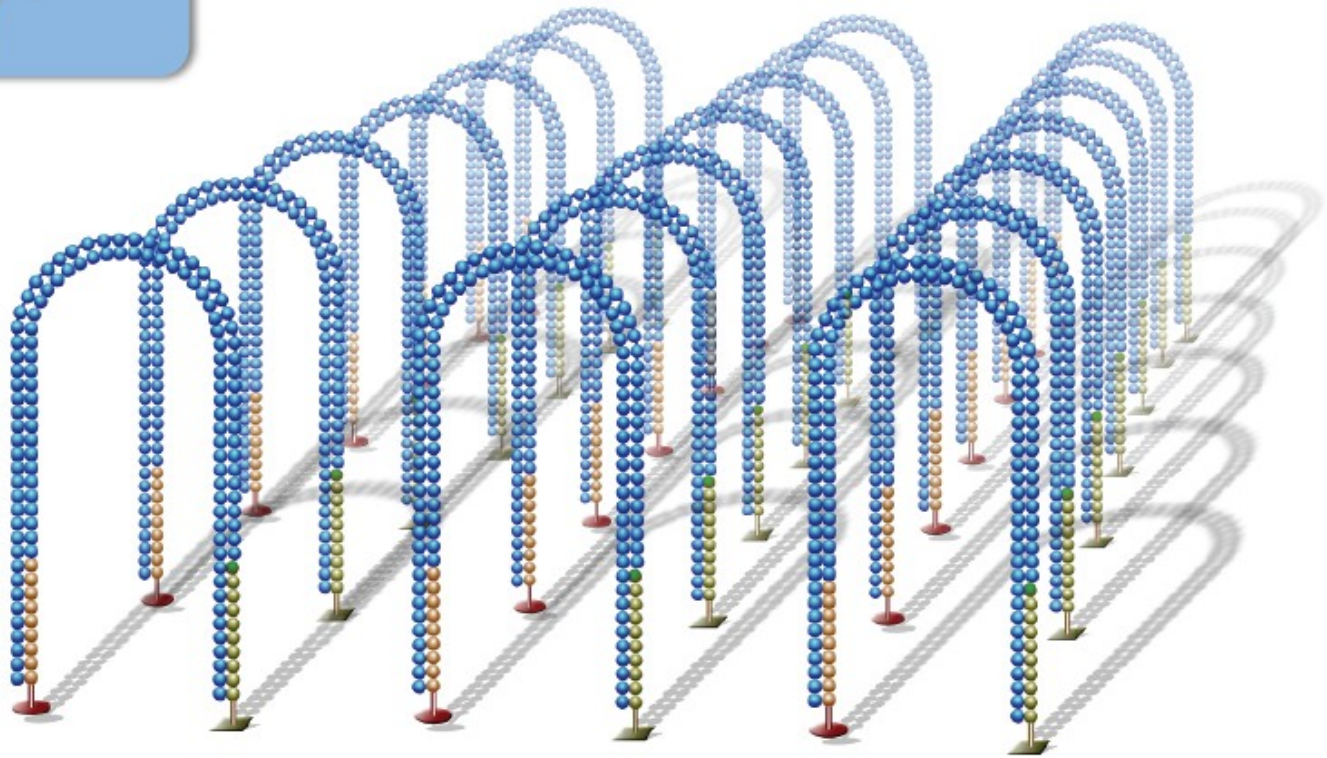

Linearization

dsDNA bridges are denatured

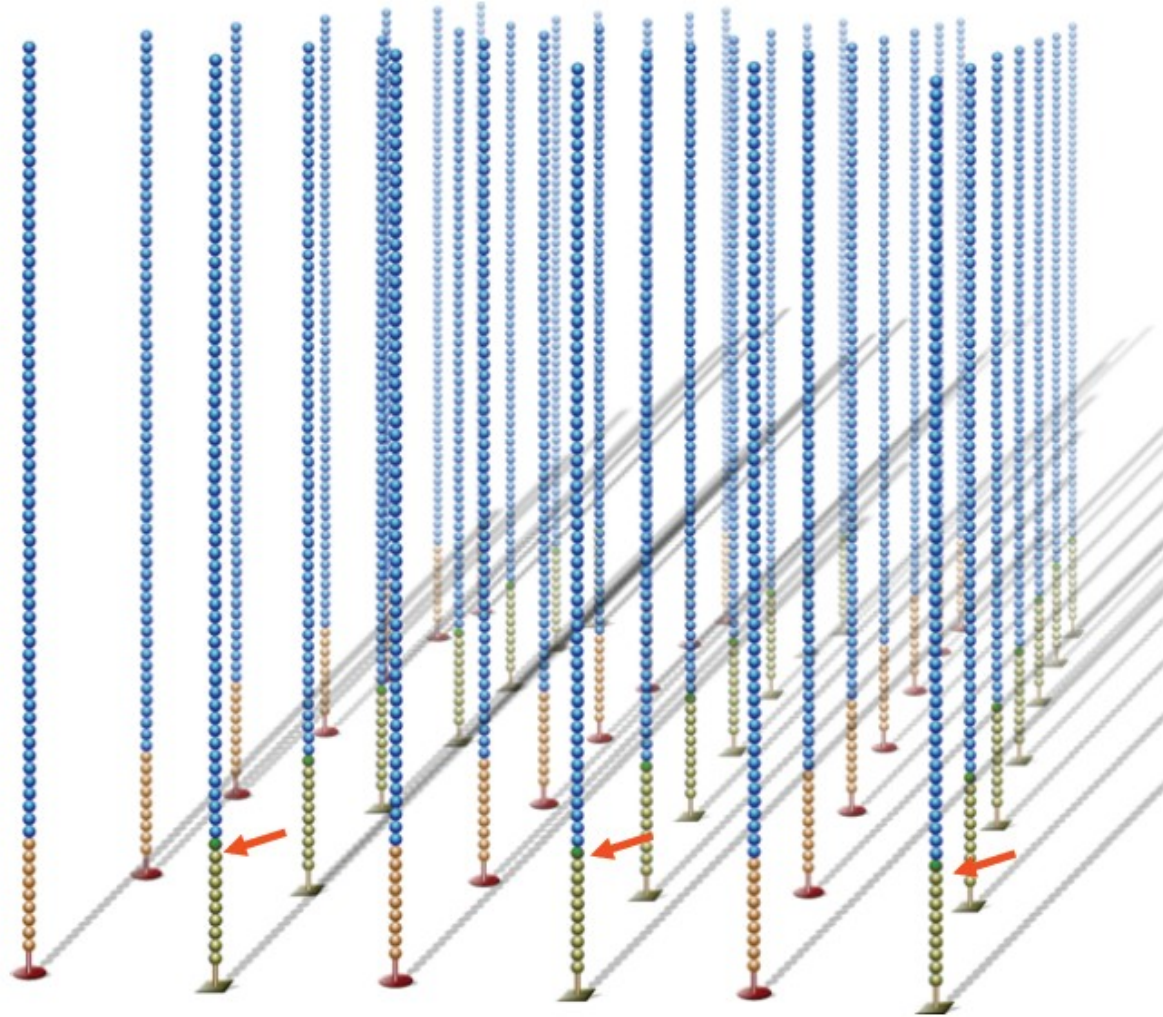

Reverse Strand Cleavage

Reverse strands are cleaved and washed away, leaving a cluster with forward strands only

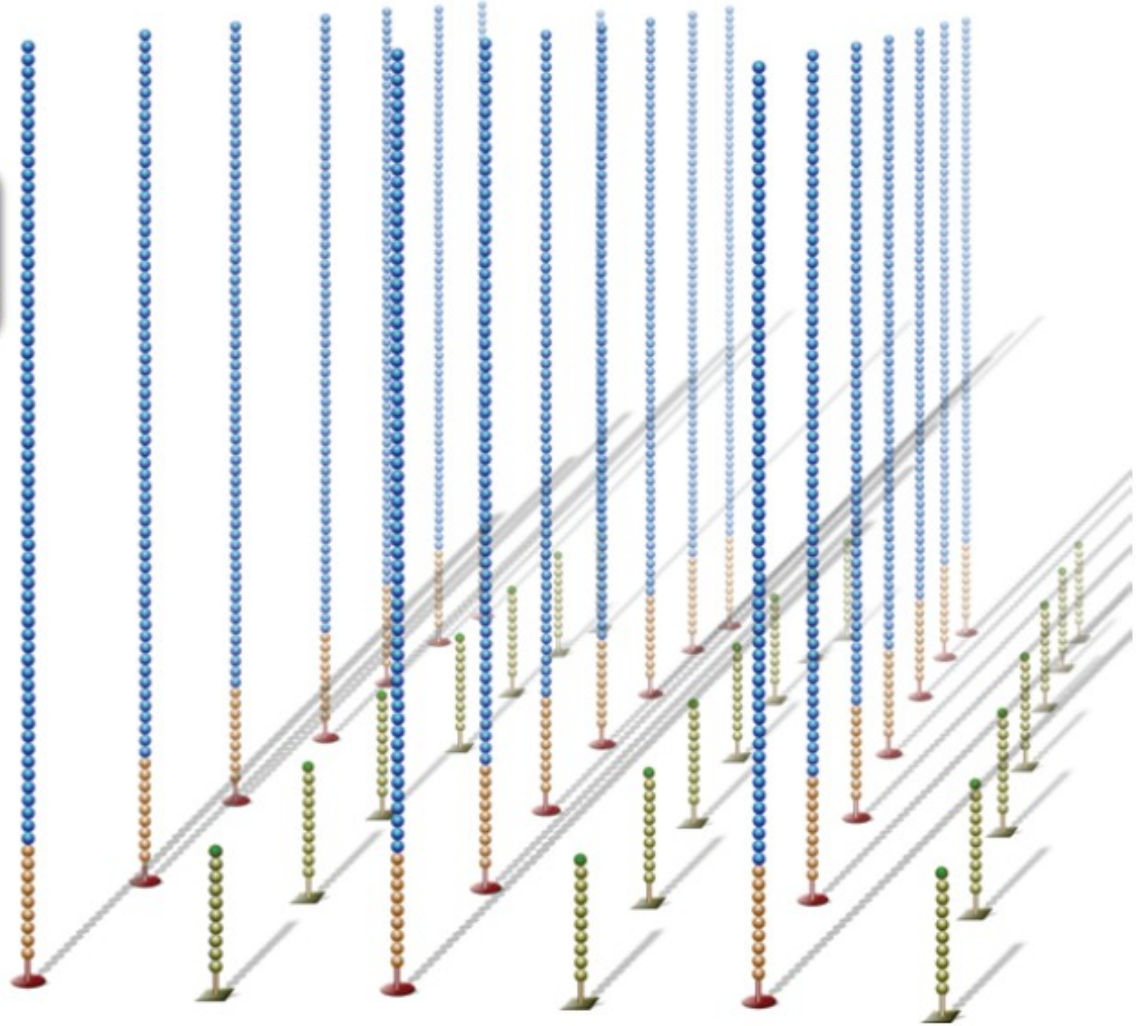

Blocking

Free 3' ends are blocked to prevent unwanted DNA priming

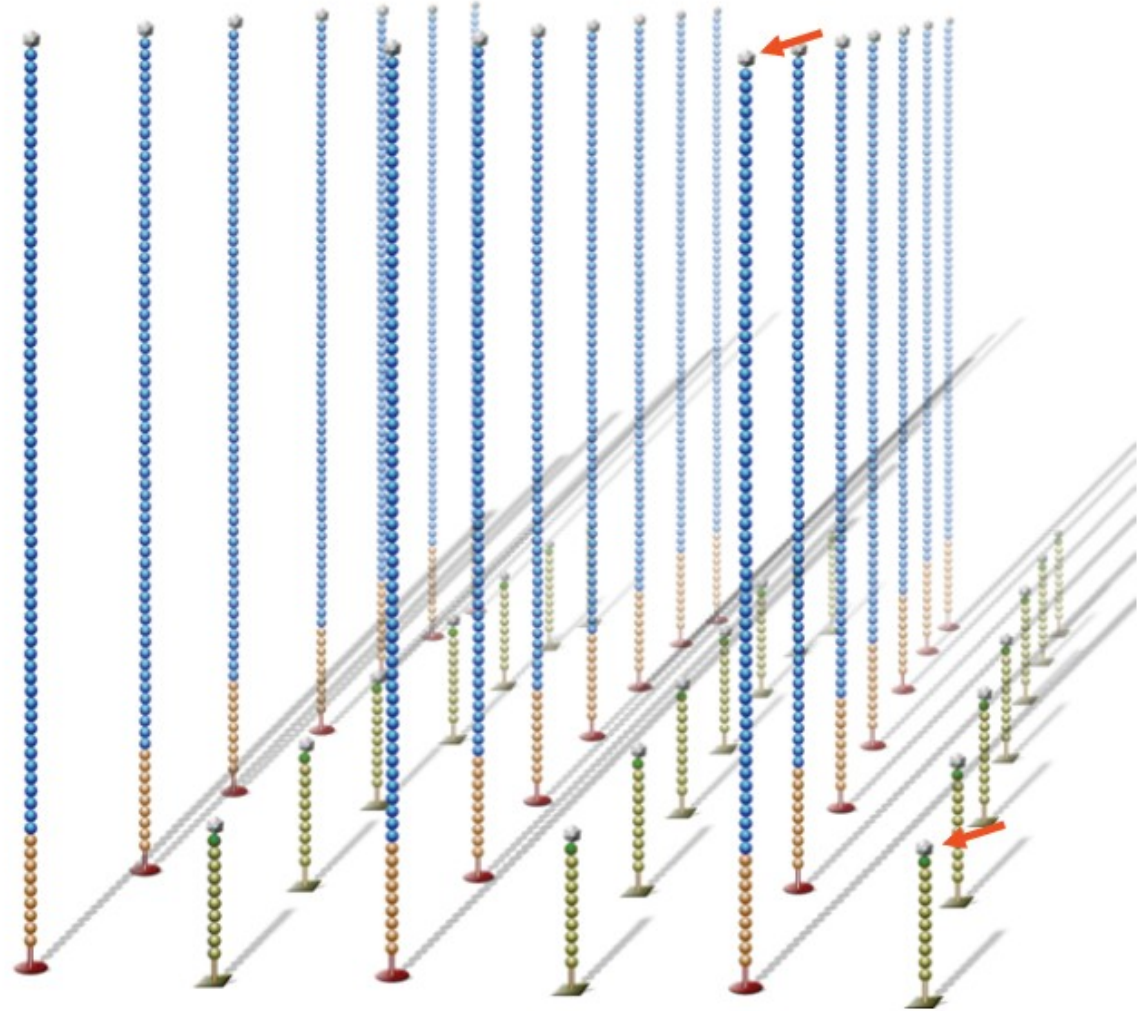

Read 1 Primer Hybridization

Sequencing primer is hybridized to adapter sequence

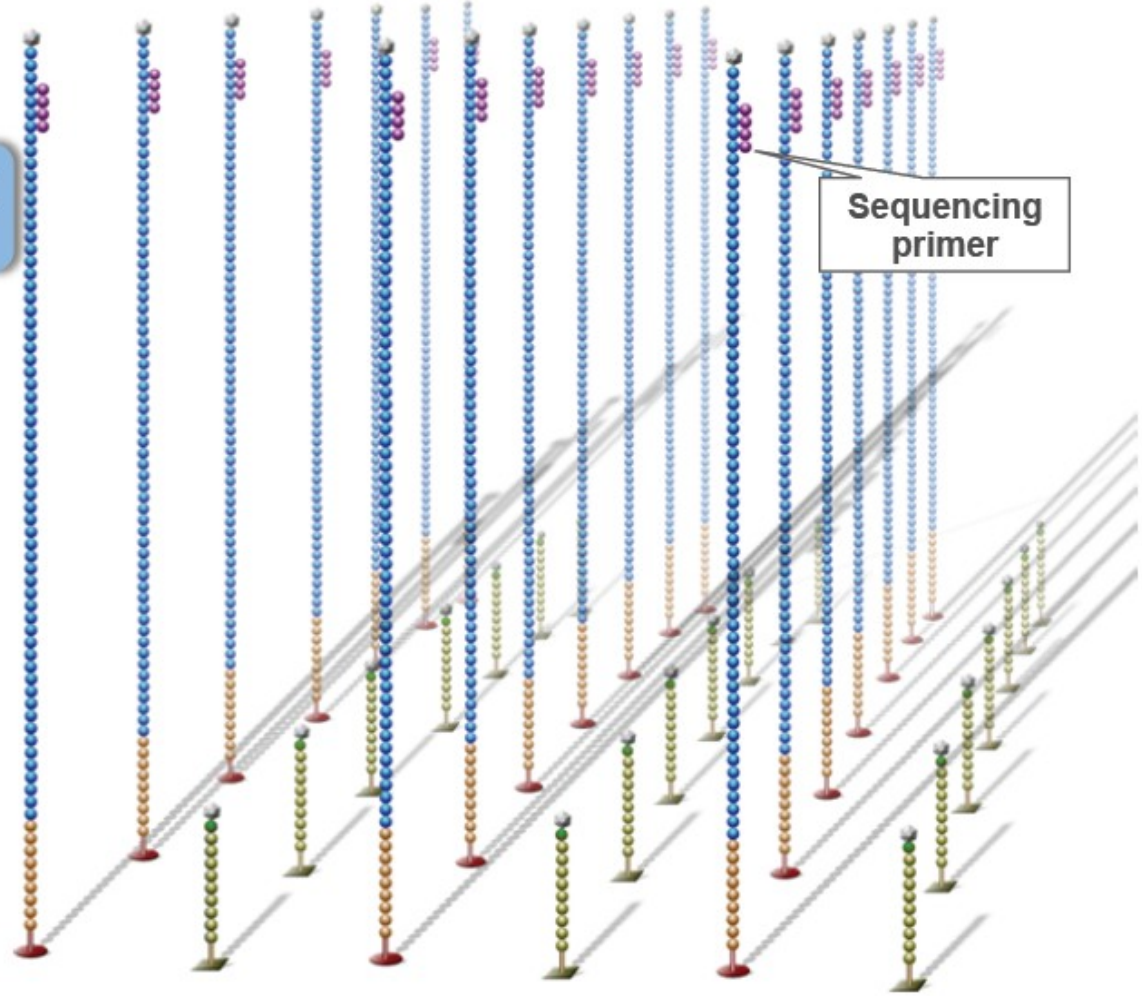

Sequencing by synthesis

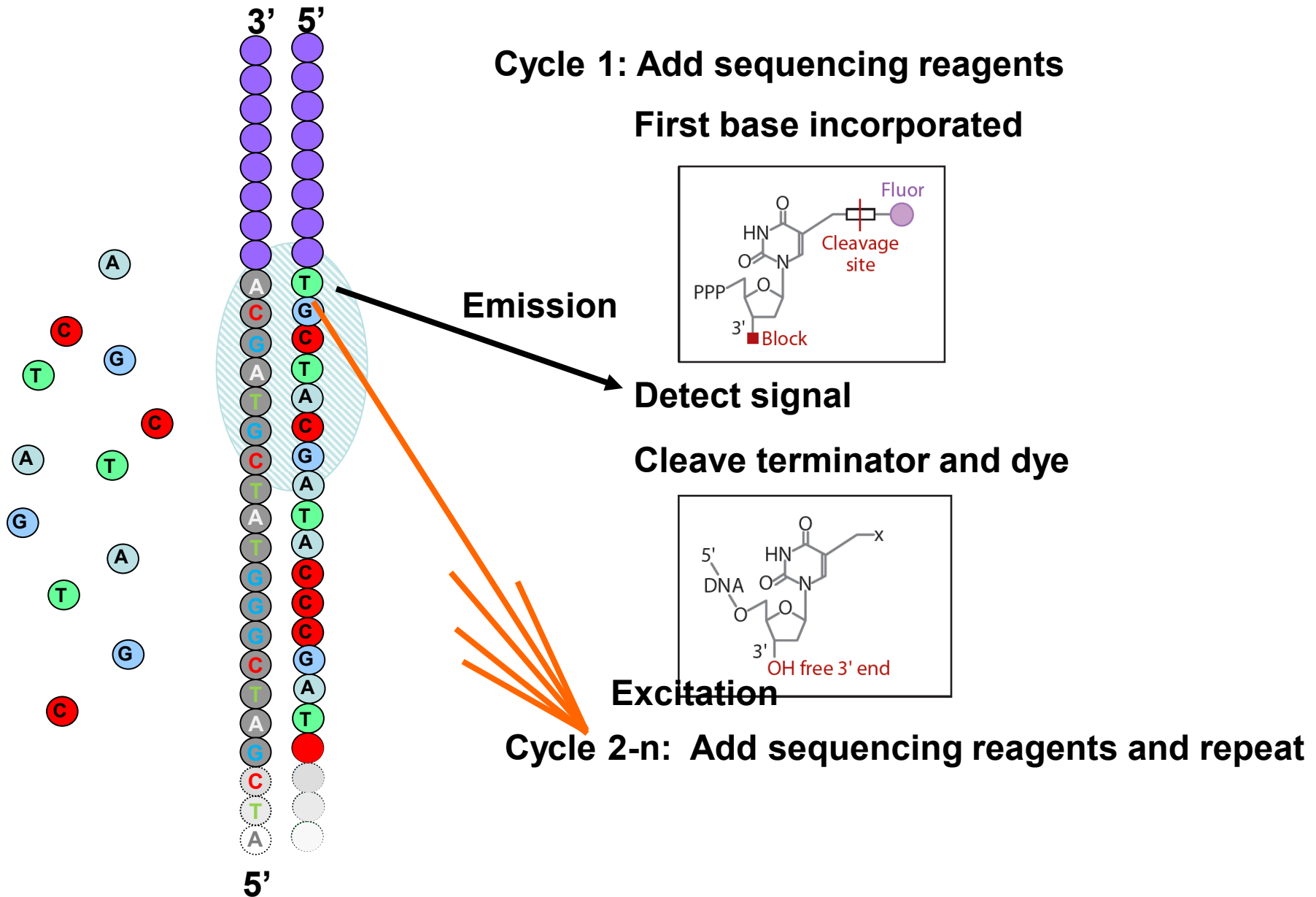

Sequencing by Synthesis - Fluorescently labeled Nucleotides (Illumina)

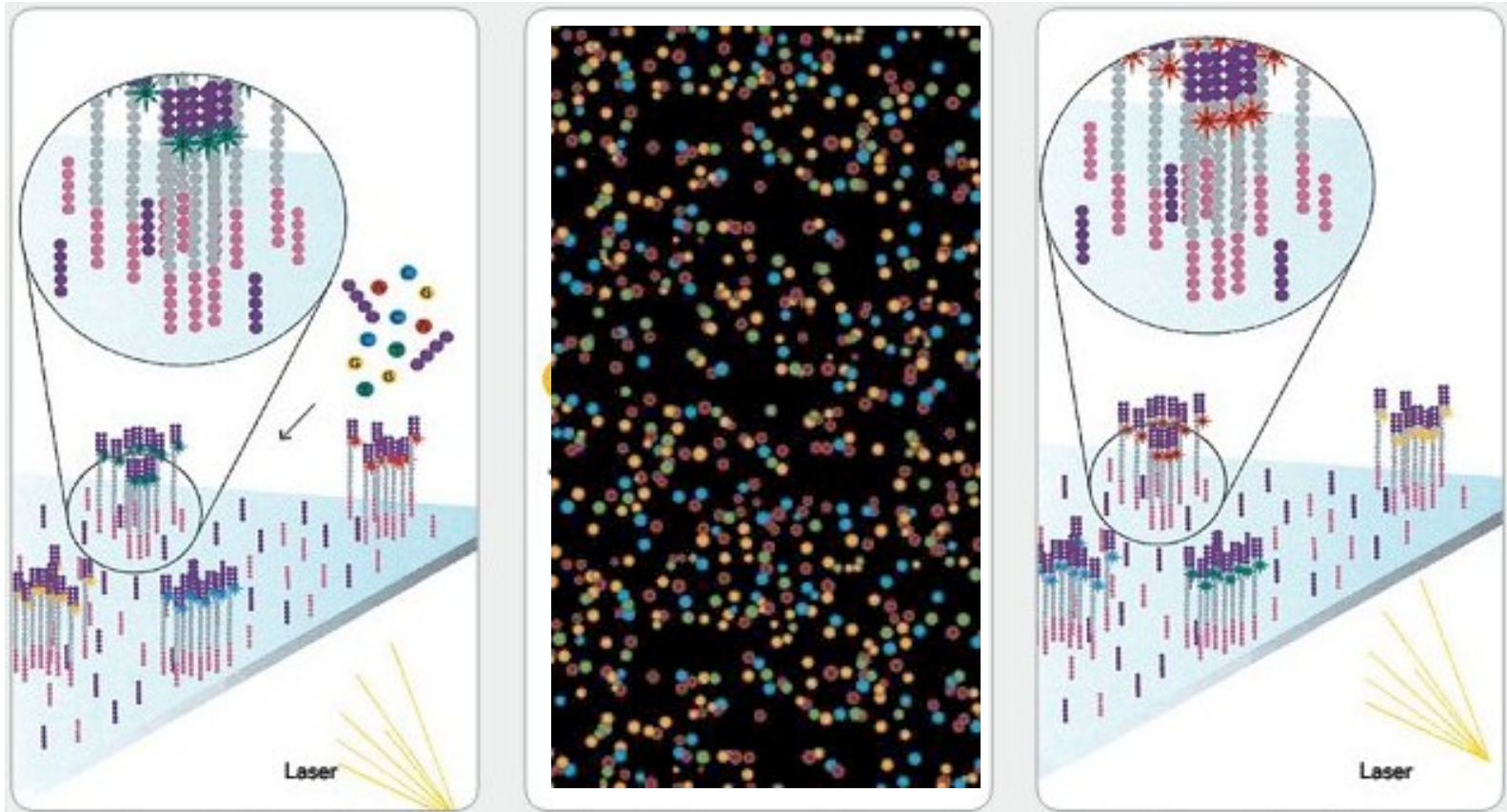

Complementary strand elongation: DNA Polymerase

video

- <https://www.youtube.com/watch?v=womKfikWlxM>

The general experimental procedure for RNA

Transcriptom =
sum of all RNA
(mRNA, rRNA,
tRNA and
noncoding RNA)

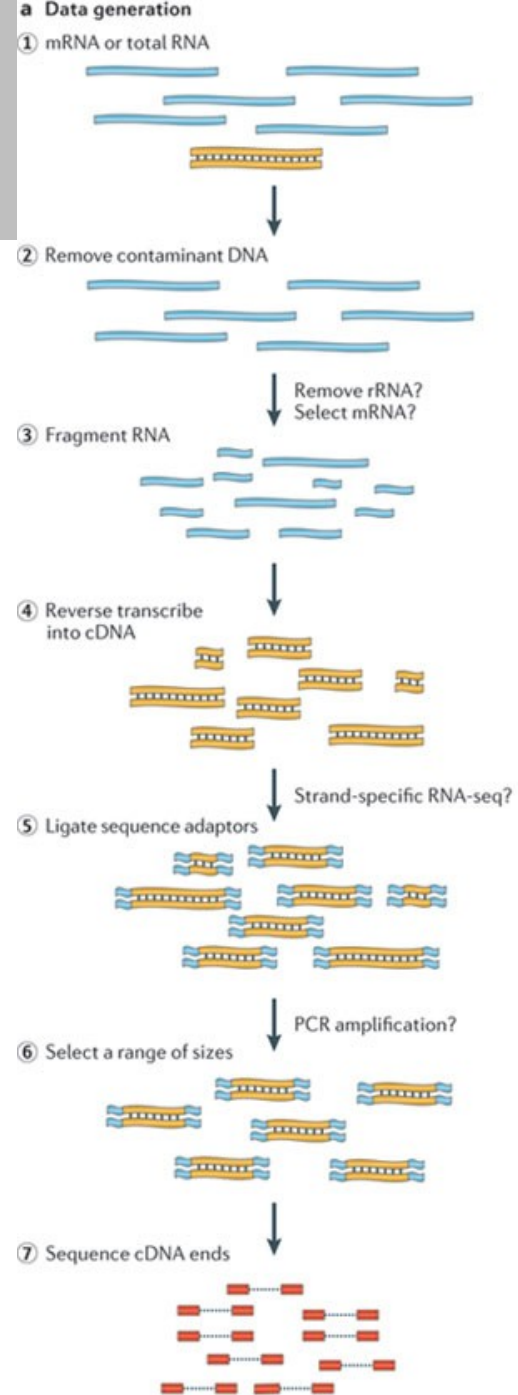

The general experimental procedure for miRNA

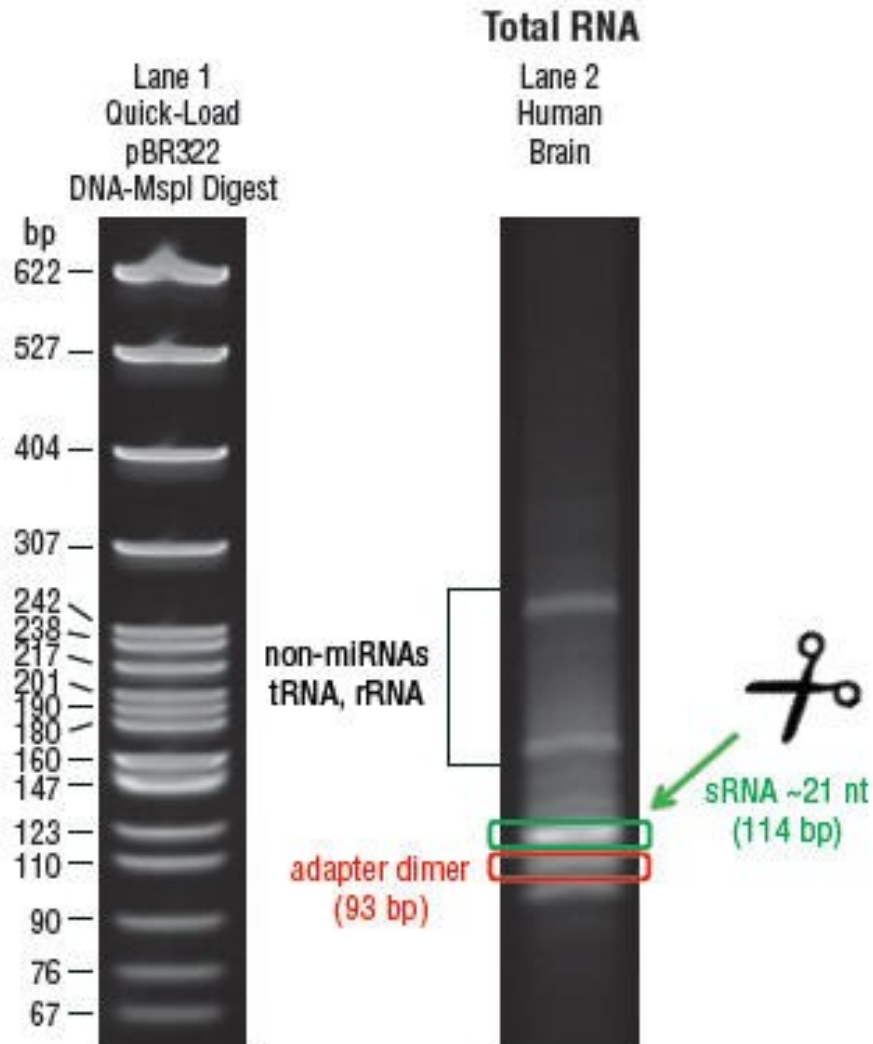

The general experimental procedure for miRNA

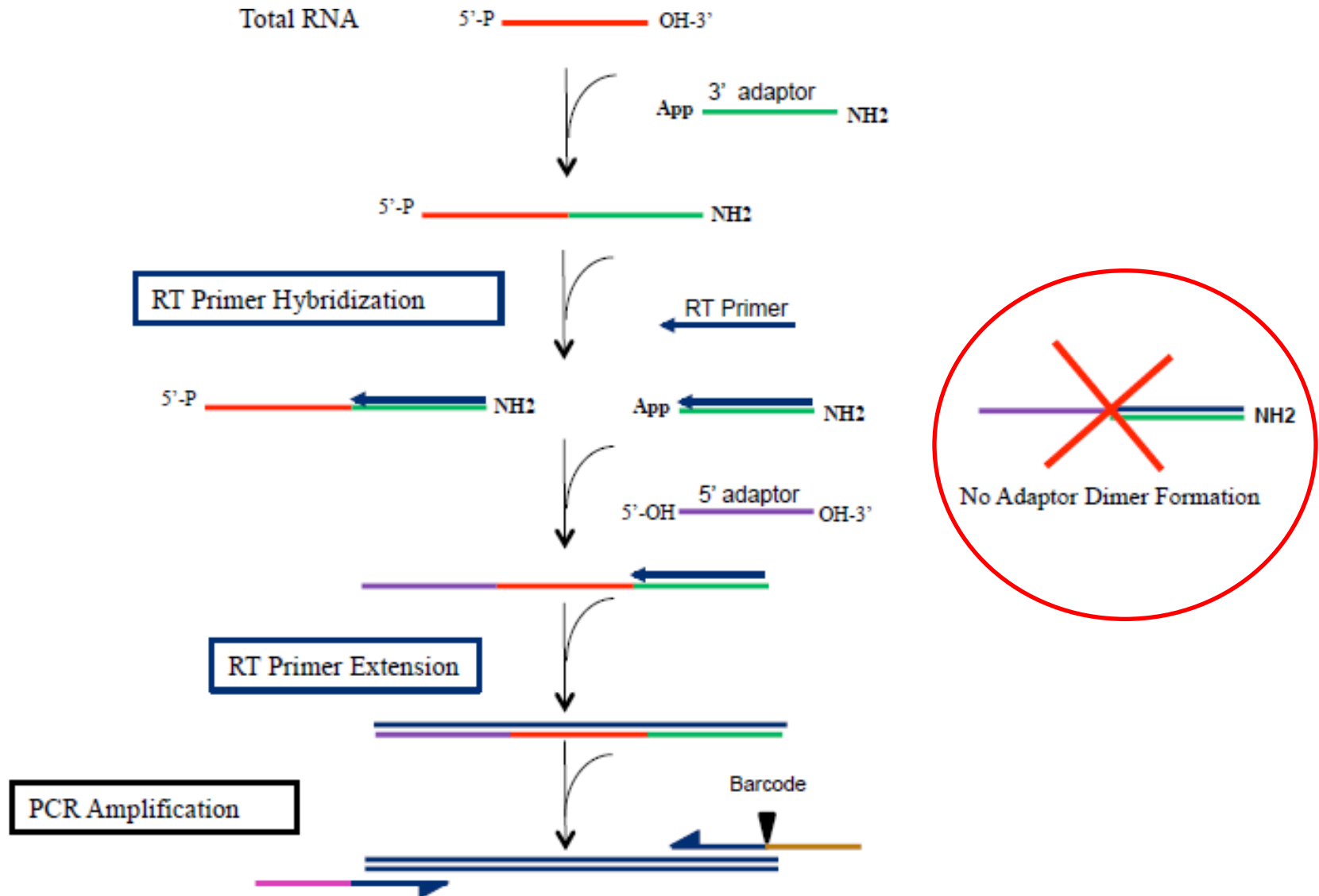

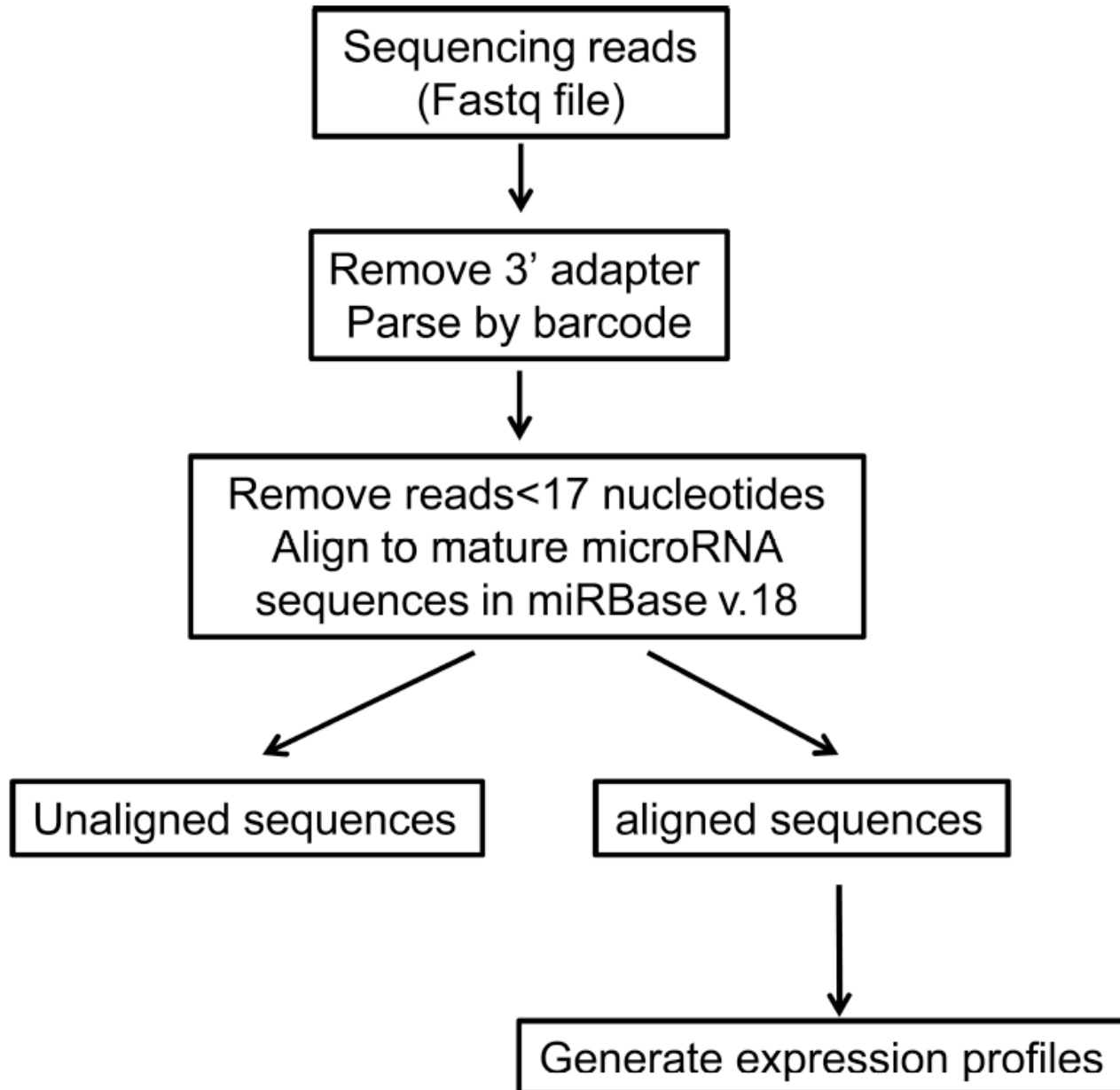

ODPOČINEK

Year 2K “Central dogma” of molecular oncology

Cancer is the GENETIC DISEASE with the most complex mechanism.
Oncogenes and Tumor-suppressors are the two types of PROTEINS deregulated in cancer cells.

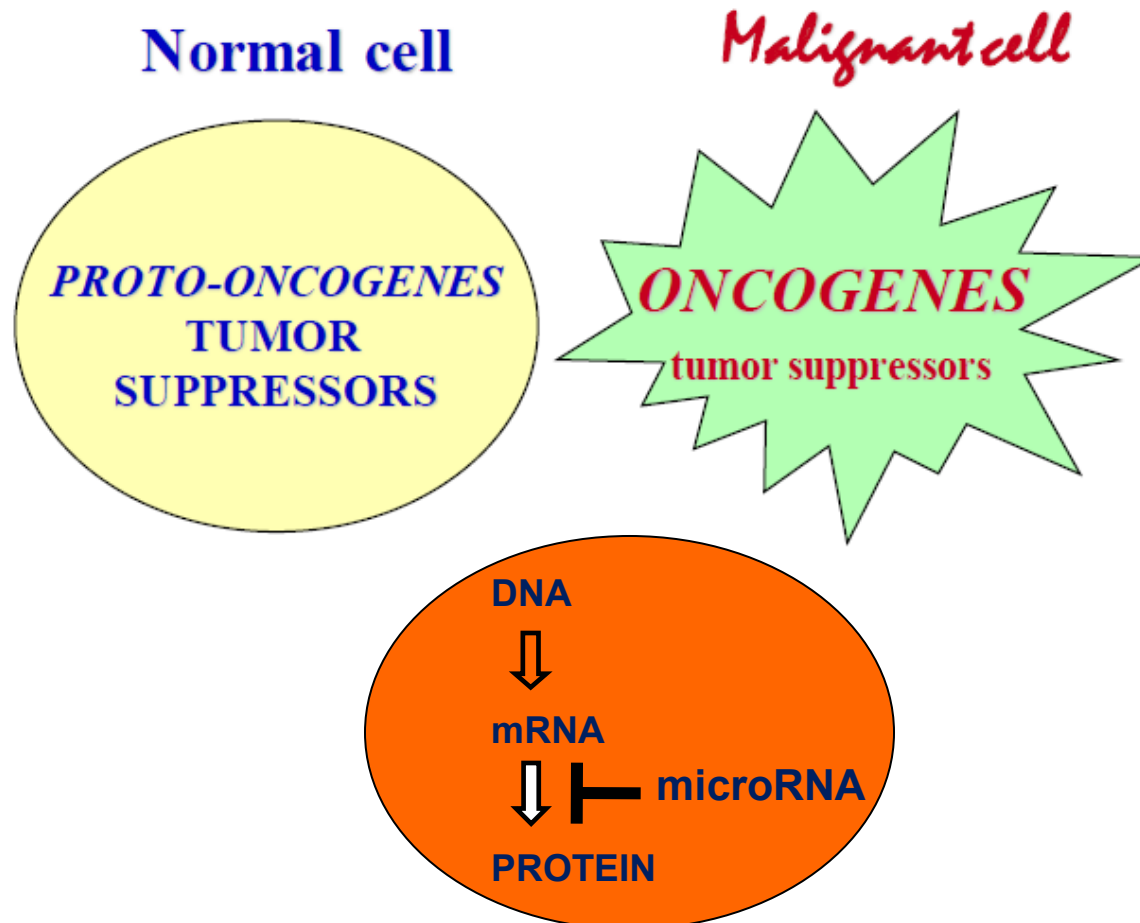

MicroRNAs were discovered by V. Ambros and G. Ruvkun in *C. elegans*

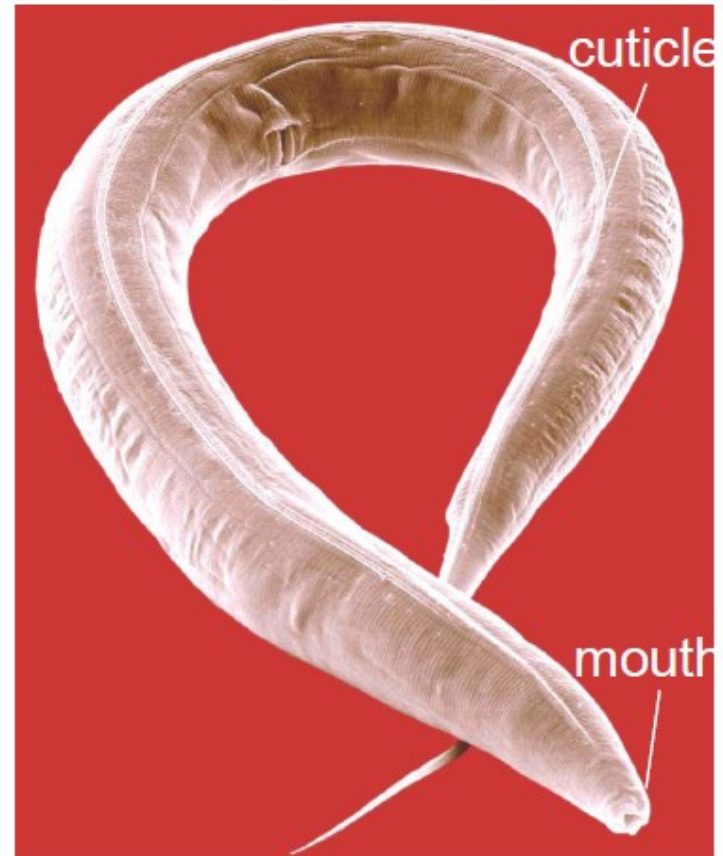
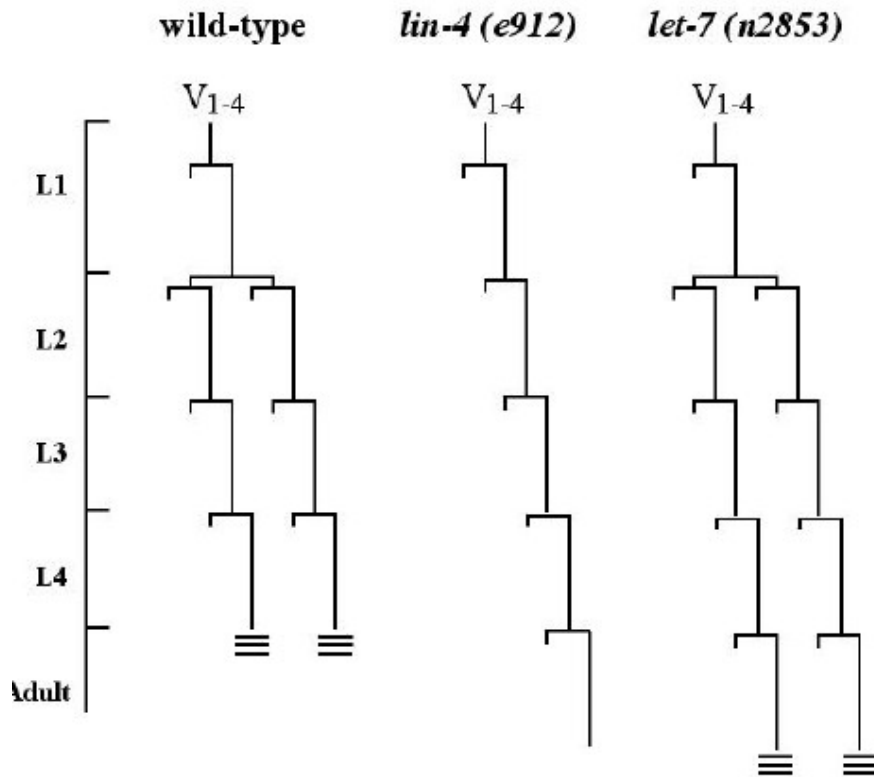

Lee et al. 1993 *Cell*

Reinhart et al. 2000 *Nature*

microRNA exprese je schopná rozlišit původ nádoru

a

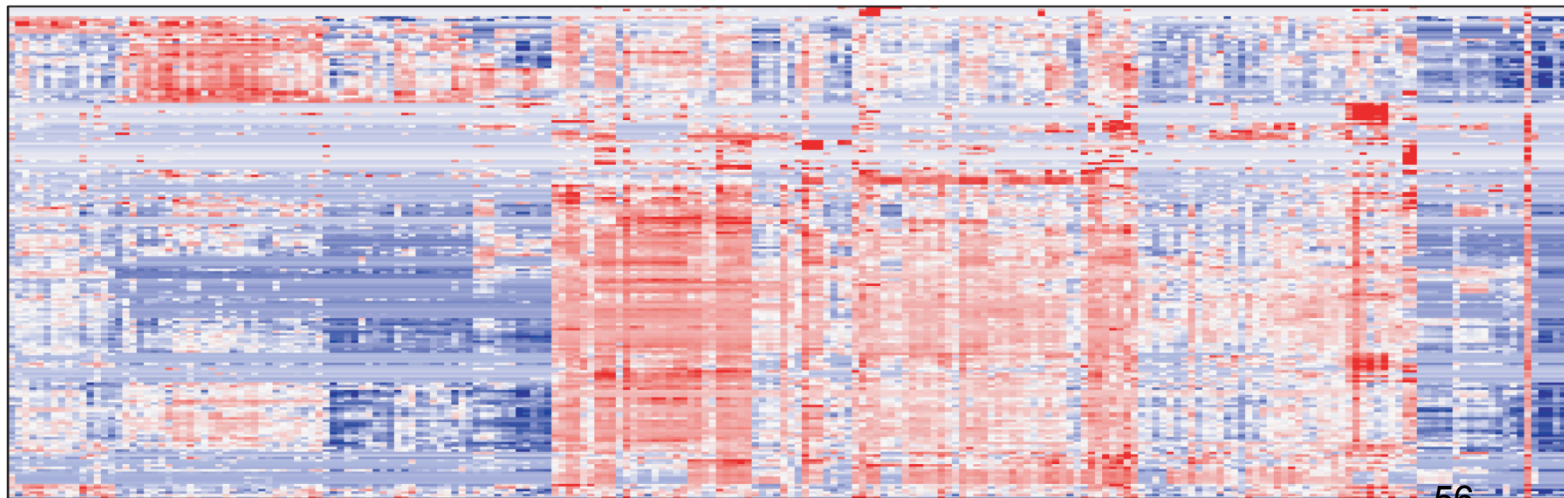
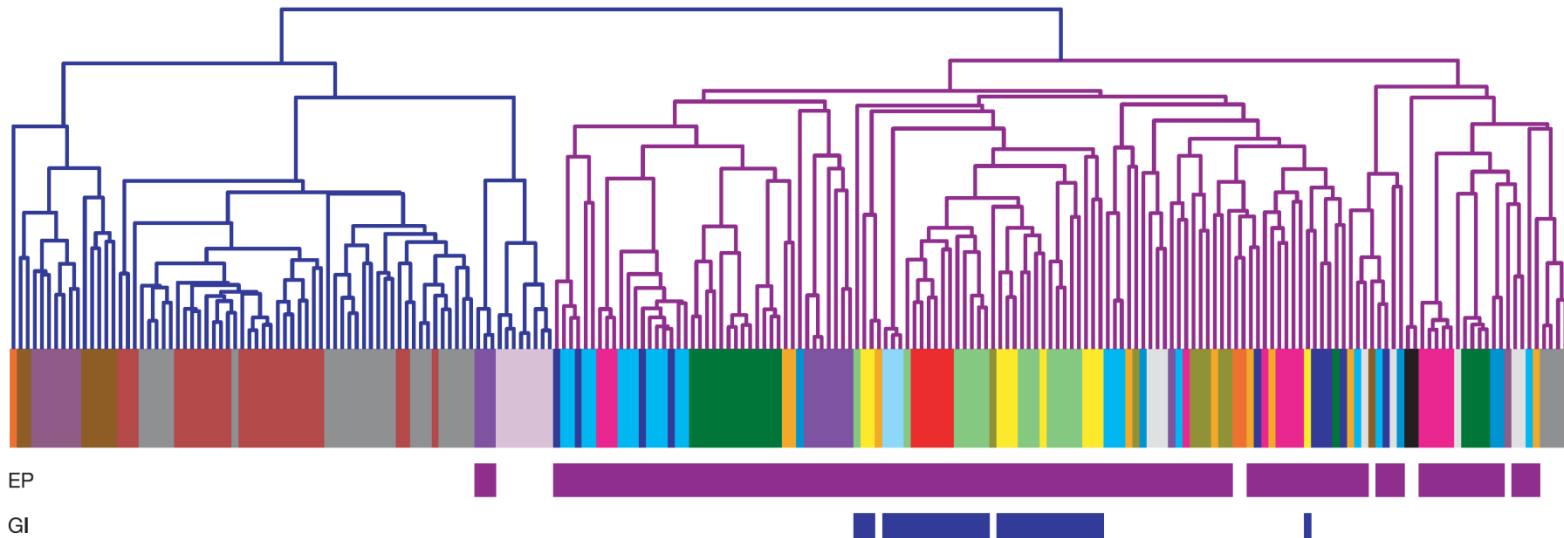

A microRNA expression signature of human solid tumors defines cancer gene targets

Stefano Volinia^{*††}, George A. Calin^{*‡}, Chang-Gong Liu^{*}, Stefan Ambts[§], Amelia Cimmino^{*}, Fabio Petrocca^{*}, Rosa Visone^{*}, Marilena Iorio^{*}, Claudia Roldo^{*}, Manuela Ferracin[¶], Robyn L. Prueitt[§], Nozumu Yanaihara[§], Giovanni Lanza[¶], Aldo Scarpa^{||}, Andrea Vecchione^{**}, Massimo Negrini[¶], Curtis C. Harris[§], and Carlo M. Croce^{*††}

^{*}Department of Molecular Virology, Immunology, and Medical Genetics and Cancer Comprehensive Center, Ohio State University, Columbus, OH 43210; [§]Laboratory of Human Carcinogenesis, Center for Cancer Research, National Cancer Institute, National Institutes of Health, Bethesda, MD 20892; [†]Telethon Facility–Data Mining for Analysis of DNA Microarrays, Department of Morphology and Embryology, and [¶]Department of Experimental and Diagnostic Medicine and Interdepartmental Center for Cancer Research, University of Ferrara, 44100 Ferrara, Italy; ^{||}Department of Pathology, University of Verona, 37100 Verona, Italy; and ^{**}Department of Histopathology, Sant'Andrea Hospital, and University of Rome "La Sapienza," 00185 Rome, Italy

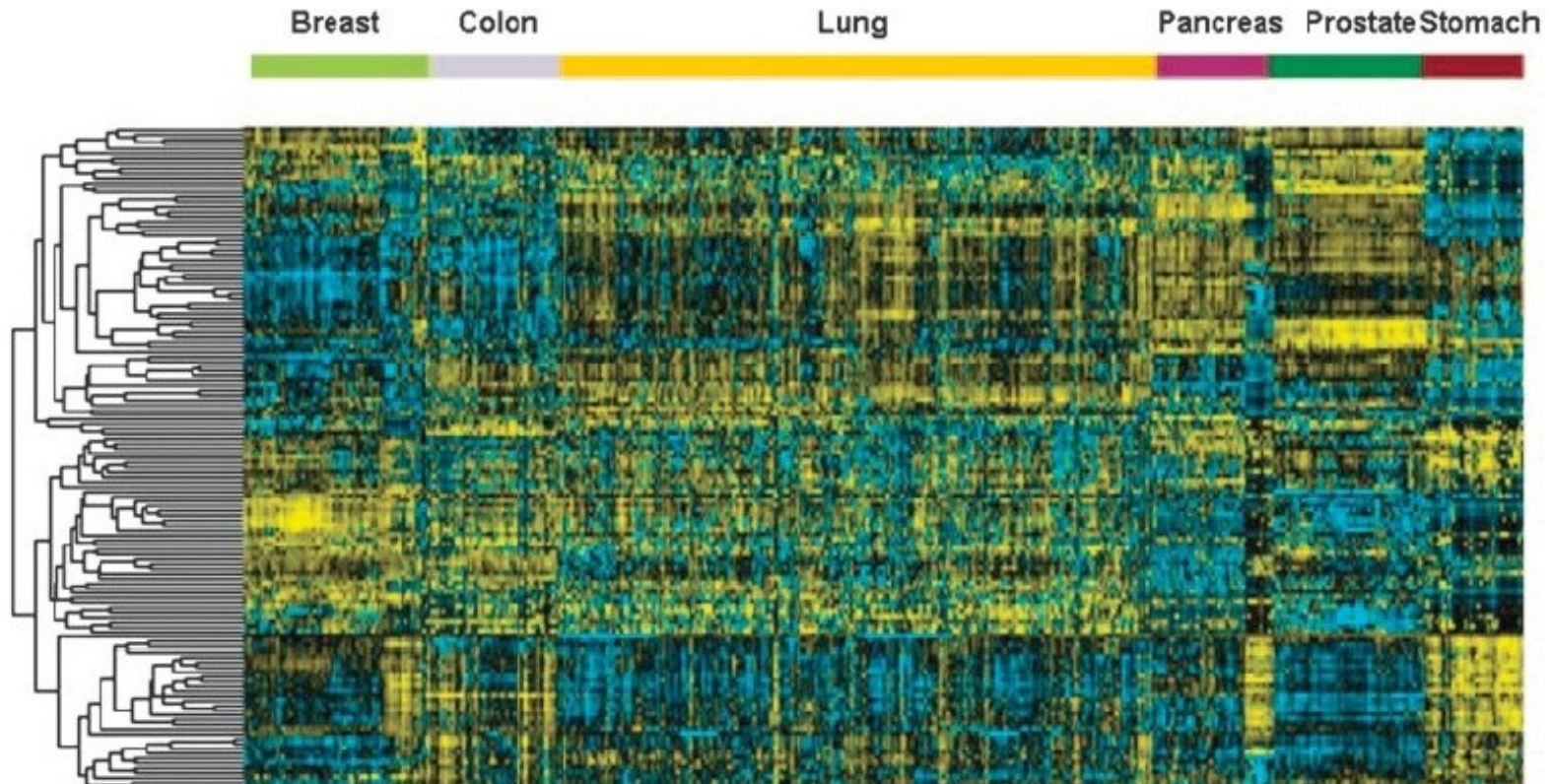
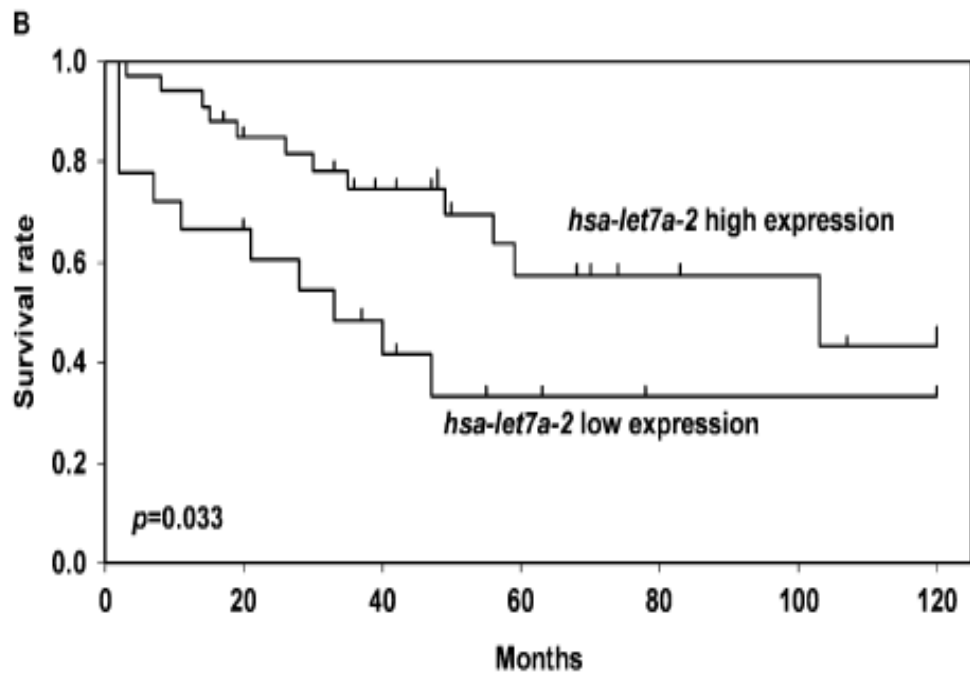
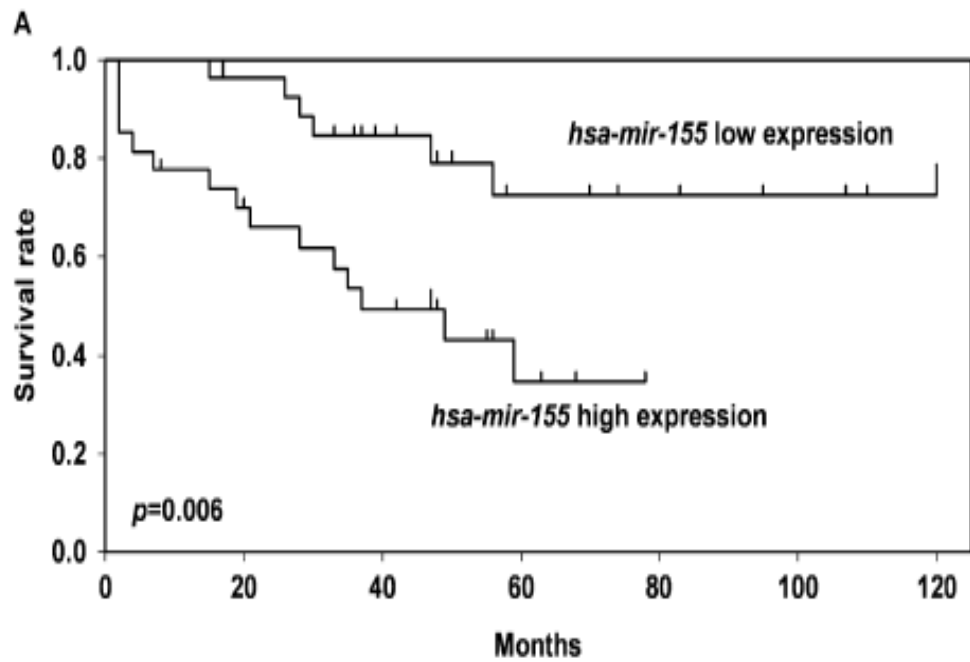

Table 2. The miRNAs shared by the signatures of the six solid cancers

| miR | <i>N</i> | Tumor type |
|------------|----------|--------------------------------------------------|
| miR-21 | 6 | Breast, colon, lung, pancreas, prostate, stomach |
| miR-17-5p | 5 | Breast, colon, lung, pancreas, prostate |
| miR-191 | 5 | Colon, lung, pancreas, prostate, stomach |
| miR-29b-2 | 4 | Breast, colon, pancreas, prostate |
| miR-223 | 4 | Colon, pancreas, prostate, stomach |
| miR-128b | 3 | Colon, lung, pancreas |
| miR-199a-1 | 3 | Lung, pancreas, prostate |
| miR-24-1 | 3 | Colon, pancreas, stomach |
| miR-24-2 | 3 | Colon, pancreas, stomach |
| miR-146 | 3 | Breast, pancreas, prostate |
| miR-155 | 3 | Breast, colon, lung |
| miR-181b-1 | 3 | Breast, pancreas, prostate |
| miR-20a | 3 | Colon, pancreas, prostate |
| miR-107 | 3 | Colon, pancreas, stomach |
| miR-32 | 3 | Colon, pancreas, prostate |
| miR-92-2 | 3 | Pancreas, prostate, stomach |
| miR-214 | 3 | Pancreas, prostate, stomach |
| miR-30c | 3 | Colon, pancreas, prostate |
| miR-25 | 3 | Pancreas, prostate, stomach |
| miR-221 | 3 | Colon, pancreas, stomach |
| miR-106a | 3 | Colon, pancreas, prostate |

The list includes 21 commonly up-regulated microRNAs in 3 or more (*N*) types of solid cancers (P value = 2.5×10^{-3}).



A unique miRNA signature is associated with lung cancer prognosis

Table 5. Postoperative survival of patients with lung adenocarcinoma in relation to clinicopathological characteristics and miRNA expression analyzed by microarray analysis

| Variable | Subset | Hazard ratio (95% confidence interval) | p |
|-------------------------------------------------|-------------------|----------------------------------------|-------|
| → Univariate analysis (n = 65) | | | |
| Age | age ≥ 67/age < 67 | 1.41 (0.67–3.06) | 0.348 |
| Sex | male/female | 1.36 (0.64–2.93) | 0.413 |
| Stage | II–IV/I | 2.51 (1.29–6.82) | 0.010 |
| Smoking history | current/former | 1.32 (0.63–2.79) | 0.456 |
| → hsa-mir-155 (n = 55) | high/low | 3.42 (1.42–8.19) | 0.006 |
| → hsa-let-7a-2 (n = 52) | low/high | 2.35 (1.08–6.86) | 0.033 |
| → Multivariate analysis (n = 55) ^{a,b} | | | |
| Age | age ≥ 67/age < 67 | 1.92 (0.71–5.17) | 0.195 |
| Sex | male/female | 1.23 (0.47–3.22) | 0.669 |
| Stage | II–IV/I | 3.27 (1.31–8.37) | 0.013 |
| Smoking history | current/former | 1.49 (0.51–4.34) | 0.457 |
| → hsa-mir-155 | high/low | 3.03 (1.13–8.14) | 0.027 |

^aMultivariate analysis, Cox proportional hazard regression model.
^bhsa-let-7a-2 low/high was not statistically significant (p = 0.129).

A polycistronic cluster of microRNAs are overexpressed in cancer

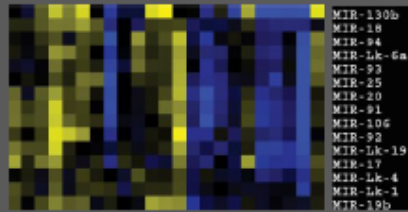

Proliferation

Angiogenesis

Apoptosis

Invasiveness



Ch13-ORF25



OncomiR-1 (Oncogenic microRNA-1)

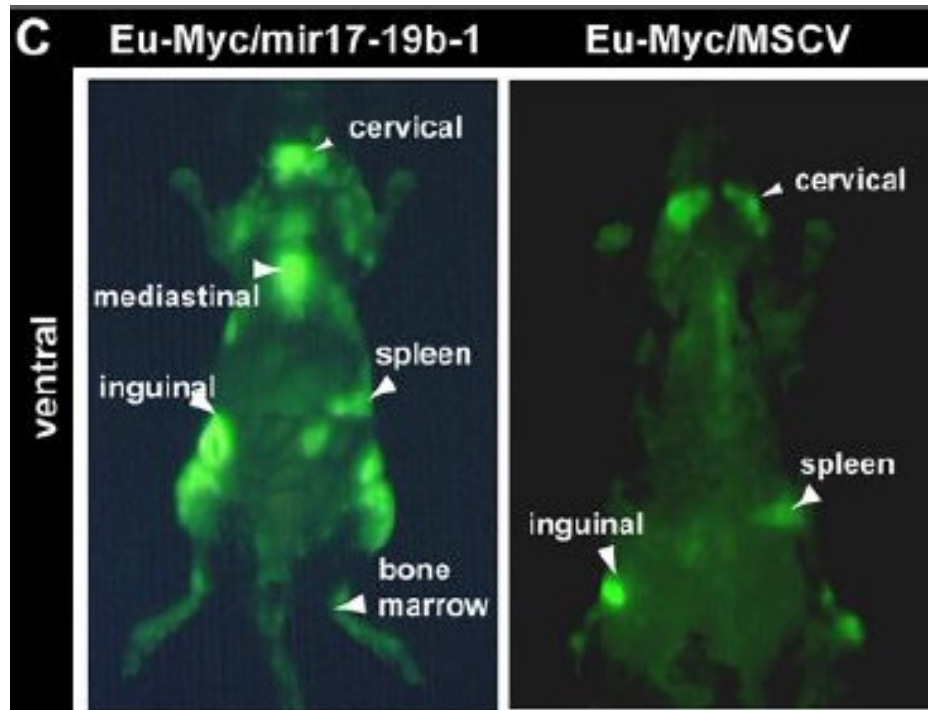
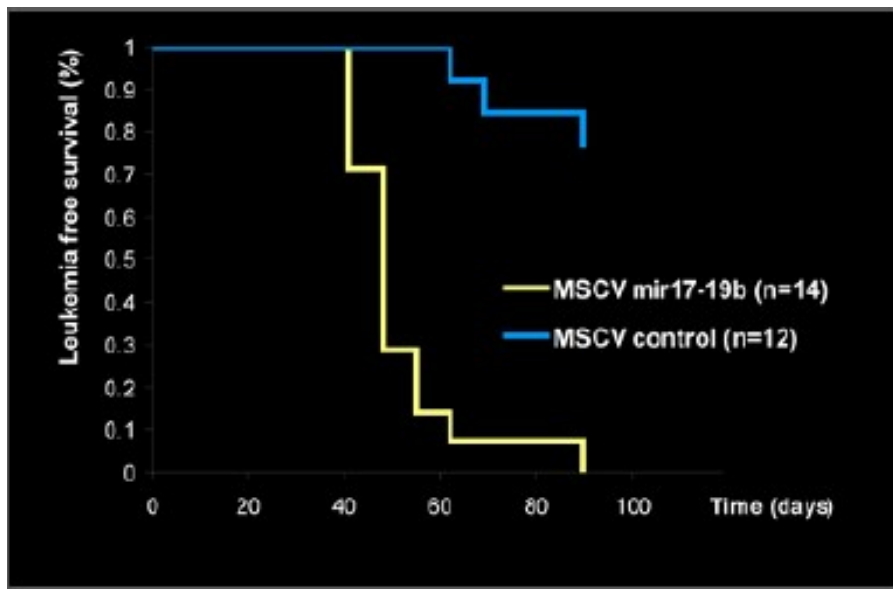

Chronická lymfatické leukémie

- ❑ Z maturovaných B lymfocytů
- ❑ Nejčastější leukémie dospělých
- ❑ Extrémně variabilní prognóza
- ❑ Nejčastější aberace del13q14 – obsahuje 2 miRNA (miR-15a, miR-16)

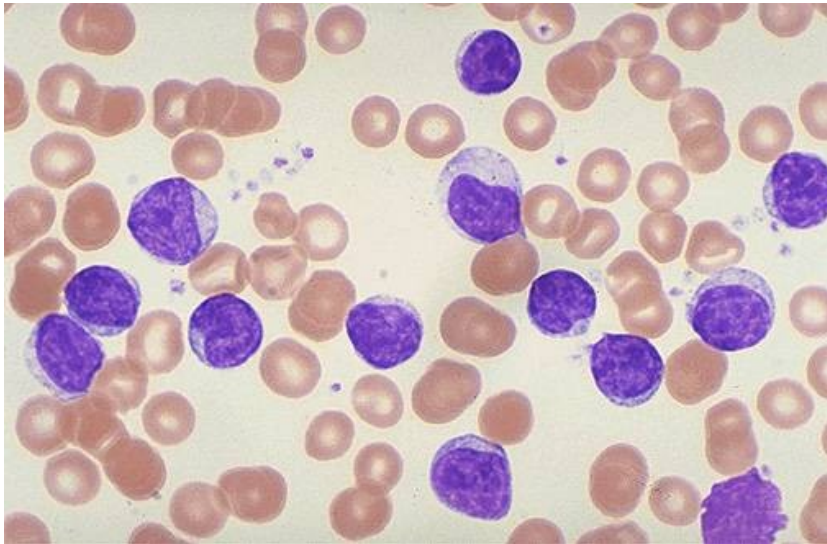

Expresse miRNA asociuje s prognostickými subtypy CLL

~ 20 miRNAs

Calin et al., 2005
Fulci et al, 2007
Zenz et al., 2009
Stamatopoulos et al., 2009
Mraz et al., 2009a, 2009b, 2012, 2014

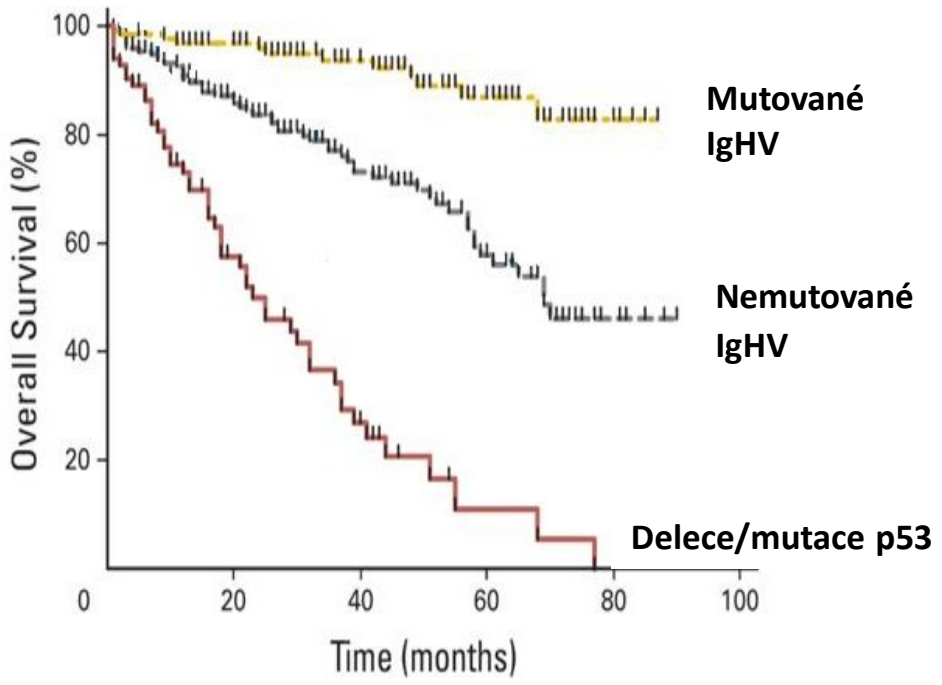

Nižší hladiny miR-150 asociují s kratším celkovým přežitím a časem do první léčby

n = 168

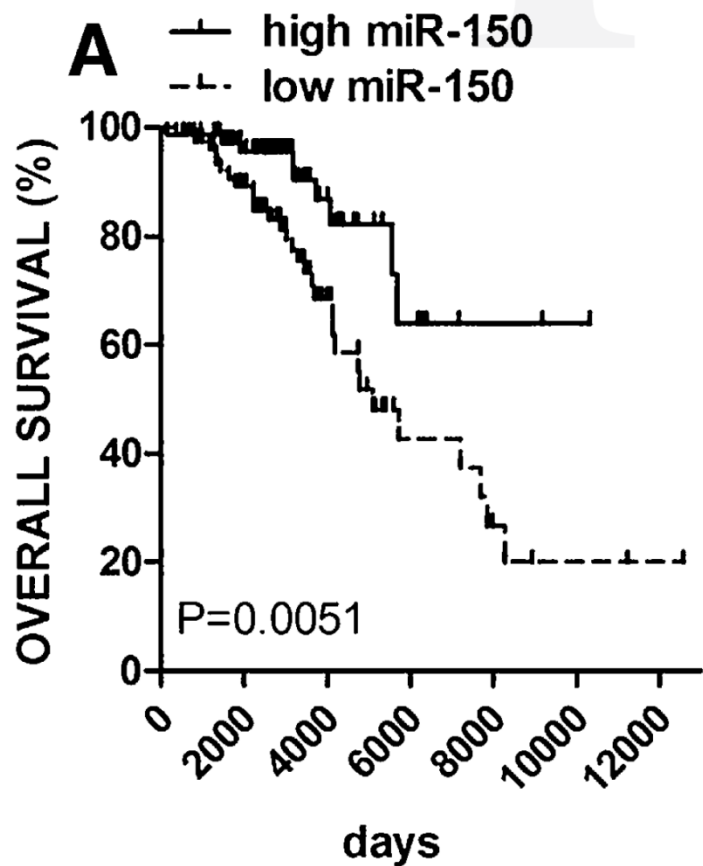

| Variable ^{&} | HR [#] | CI [#] | P-val [#] | |
|----------------------------------|------------------|-----------------|--------------------|------|
| miR-150 (\leq vs. $>$ median) | 5.6 | 2.1-14.9 | 0.001 | |
| IGHV (unmut. vs. mut.) | 2.8 | 0.9-9.1 | 0.08 | |
| ZAP-70 (pos. vs. neg.) | 5.6 | 1.7-17.9 | 0.004 | |
| CD38 (pos. vs. neg.) | 1.4 | 0.7-2.9 | 0.37 | |
| Gender (male vs. female) | 2.9 | 1.3-6.5 | 0.008 | |
| Rai stage | I vs. 0 | 4.9 | 1.4-17 | 0.01 |
| | II vs. 0 | 6.6 | 1.7-25.8 | 0.01 |
| | \geq III vs. 0 | 3.6 | 1-13.1 | 0.05 |
| Age ($>$ vs. \leq median) | 3.0 | 1.4-6.8 | 0.01 | |

Jak identifikovat cíle miR-150 u CLL?

(HG-U133 Plus 2.0, Affymetrix)

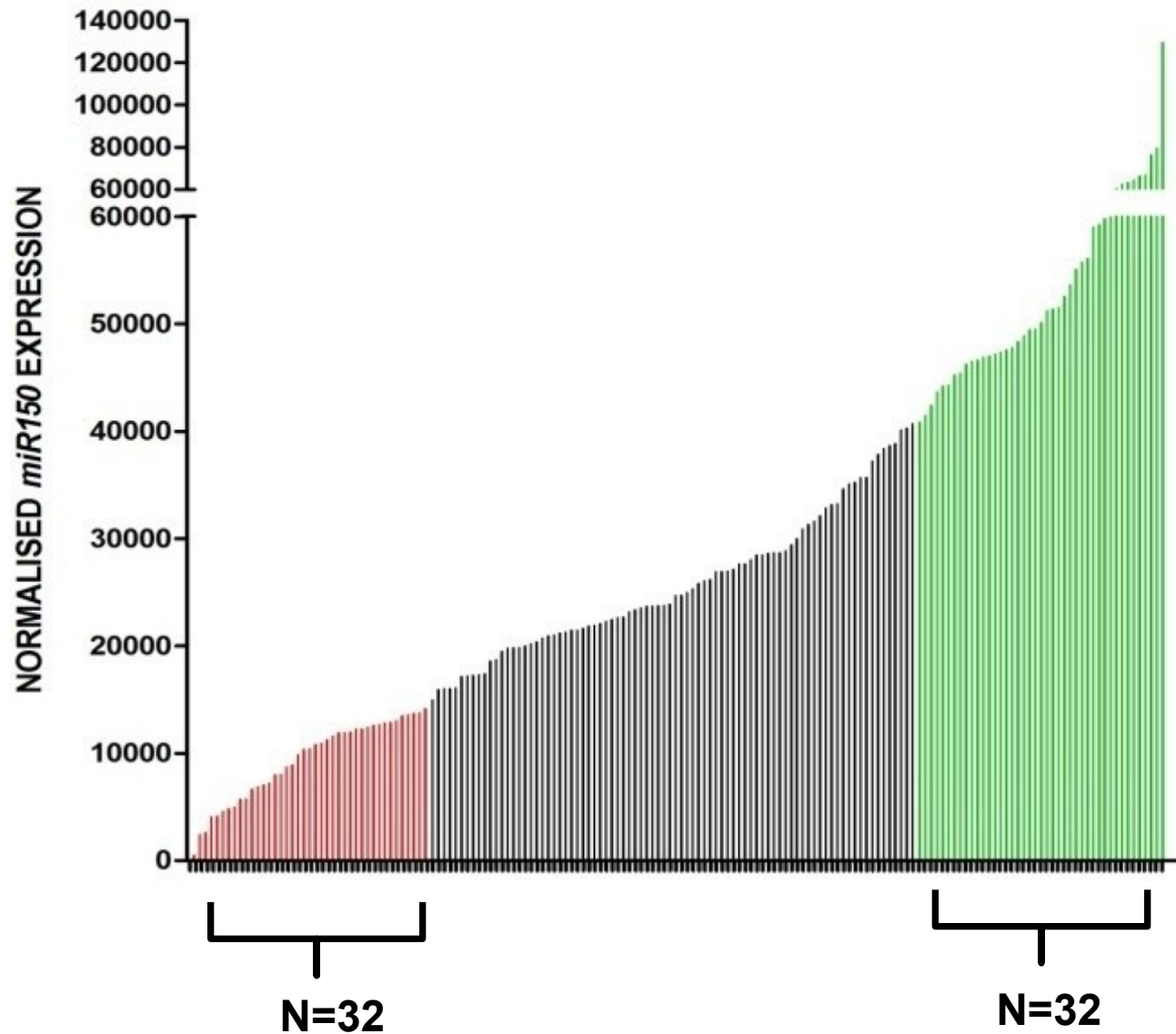

Genové expresní čipy pro CLL s nízkou vs vysokou hladinou miR-150

- 58 rozdílně exprimovaných genů
- 2 geny s evolučně konzervovanými vazebnými místy pro miR-150 – **GAB1 a FOXP1**

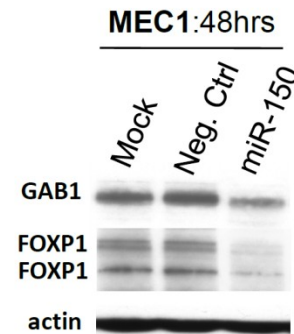
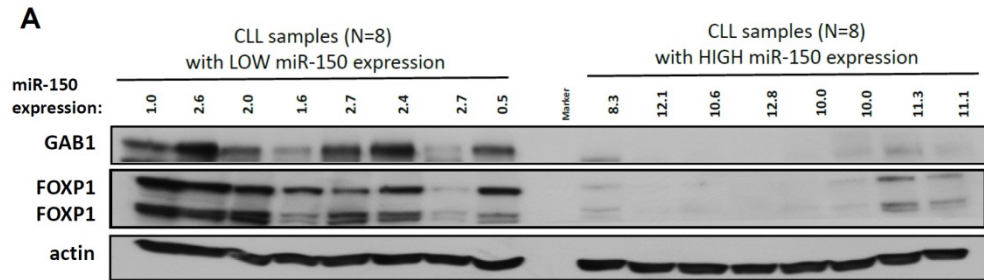
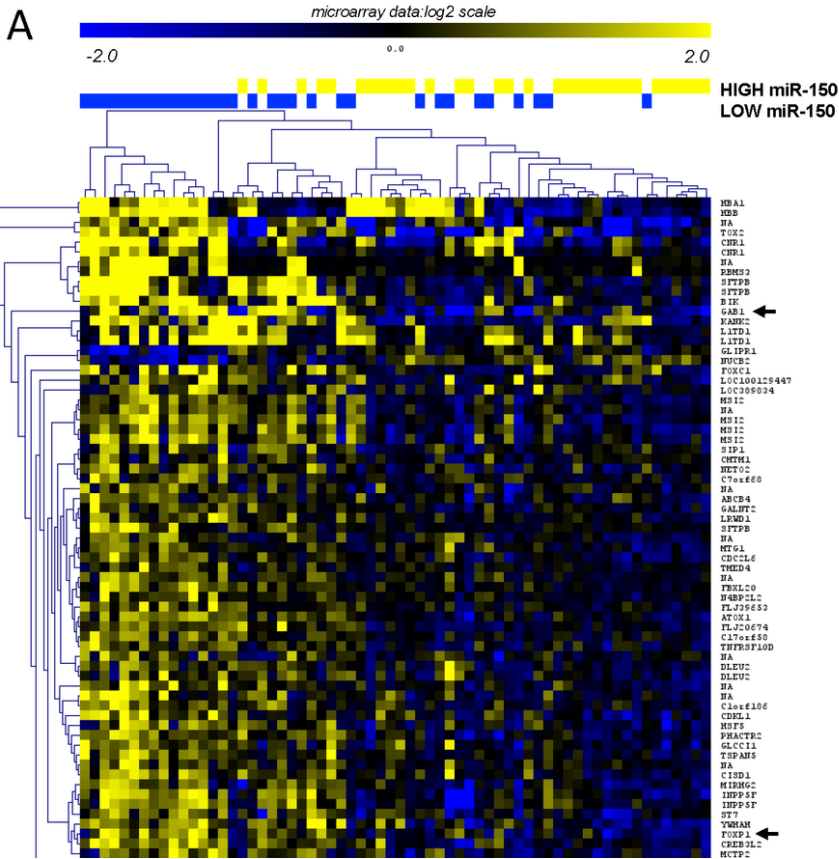

GAB1 je adaptorová molekula, která je nutná k vazbě PI3K na membránu a amplifikaci BCR signalizace (Ingham et al. JBC, 2001).

FOXP1 je transkripční faktor důležitý pro vývoj B lymfocytů a asociovaný s ABC DLBCL a progresí B buněčných lymfomů (Hu et al. Nat Immunol, 2006).

Adaptivní imunity- centrální dráha BCR

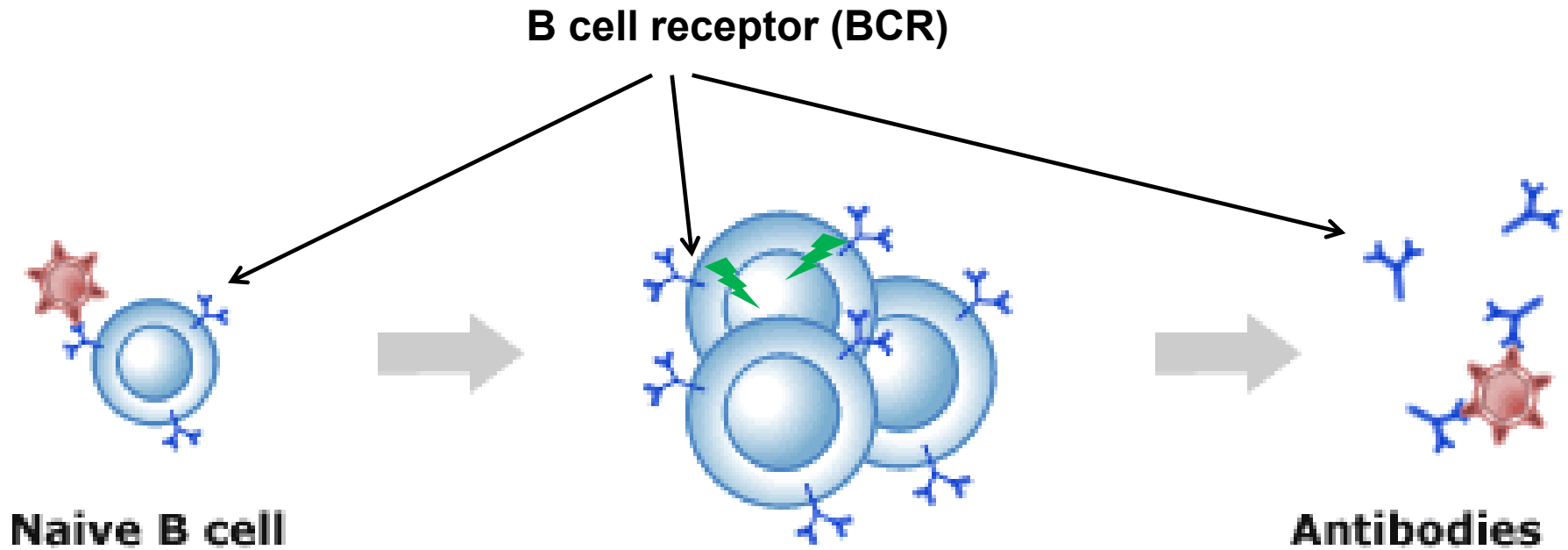

Vyšší hladiny GAB1 nebo FOXP1 znamenají silnější BCR signalizaci

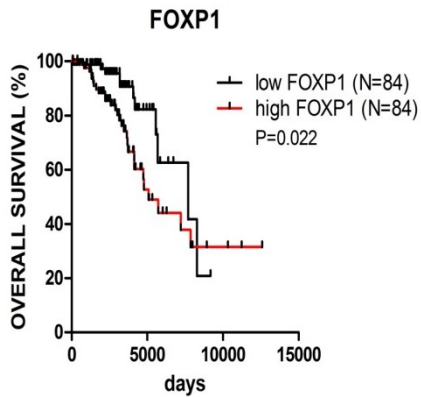
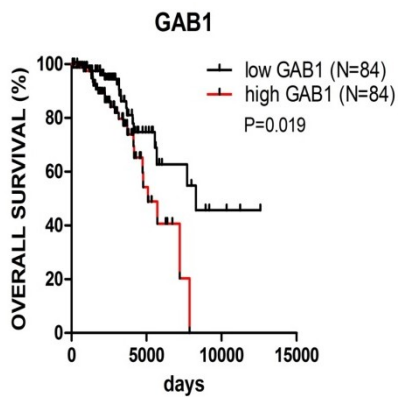
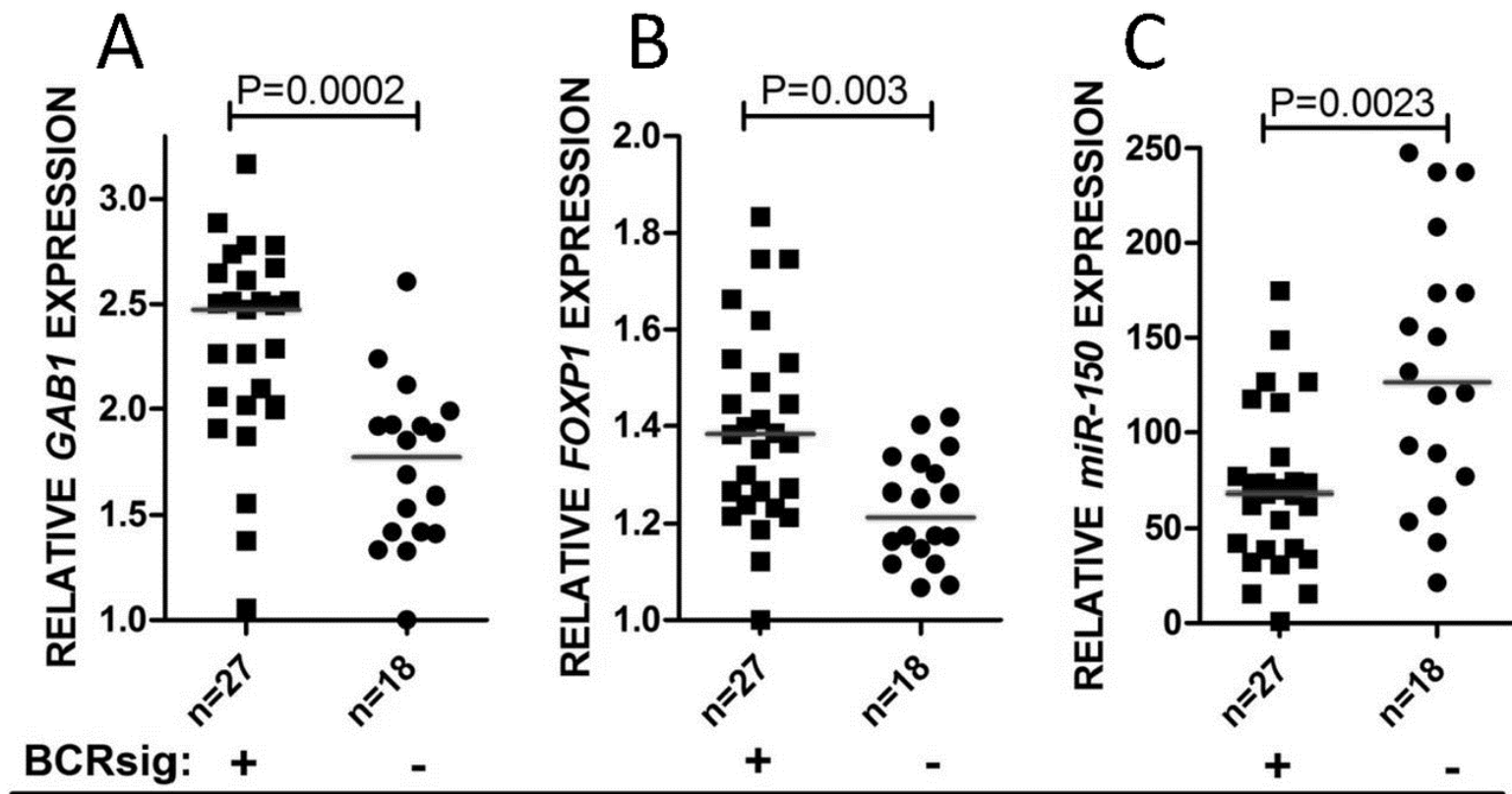

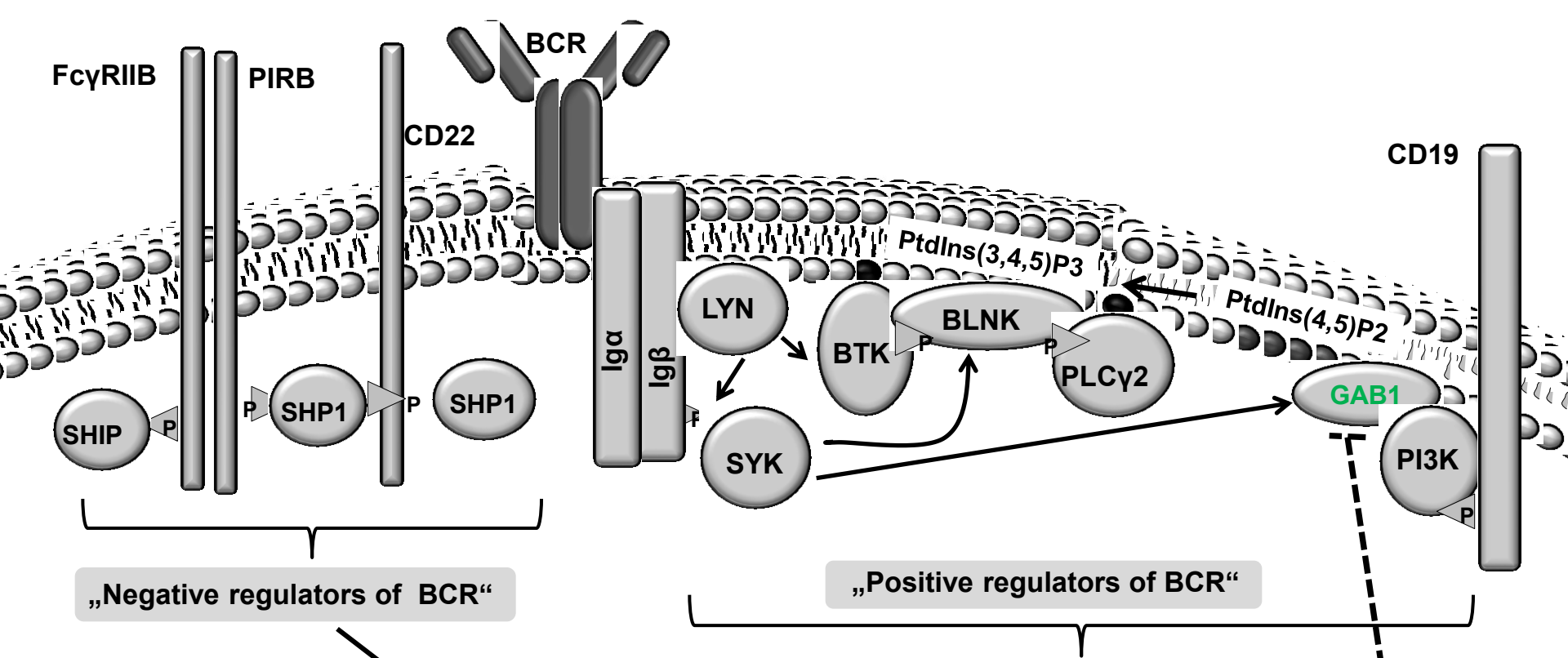

Popsali jsme první
příklad regulace BCR
signalizace
prostřednictvím
microRNA

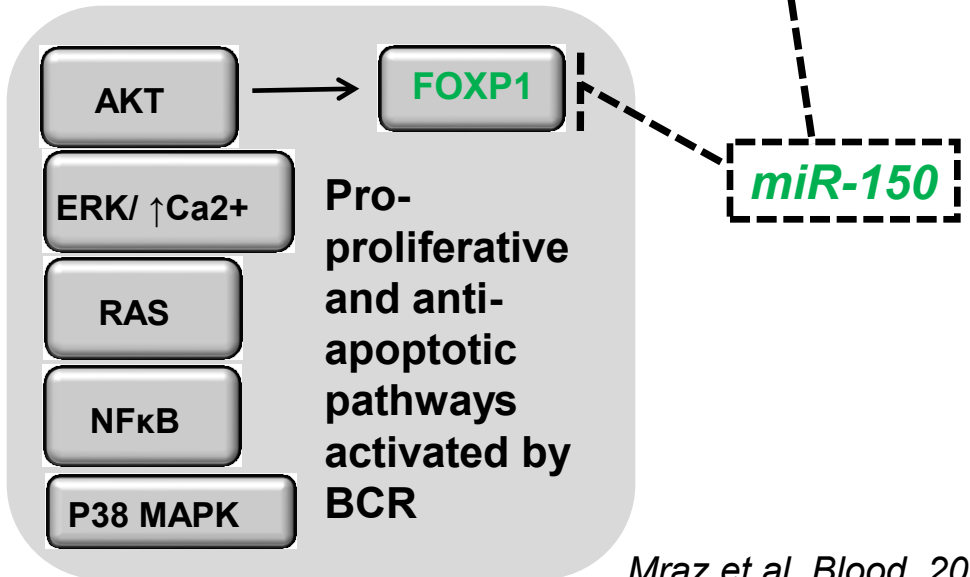

First description of miRNAs role in BCR signalling...not only in CLL

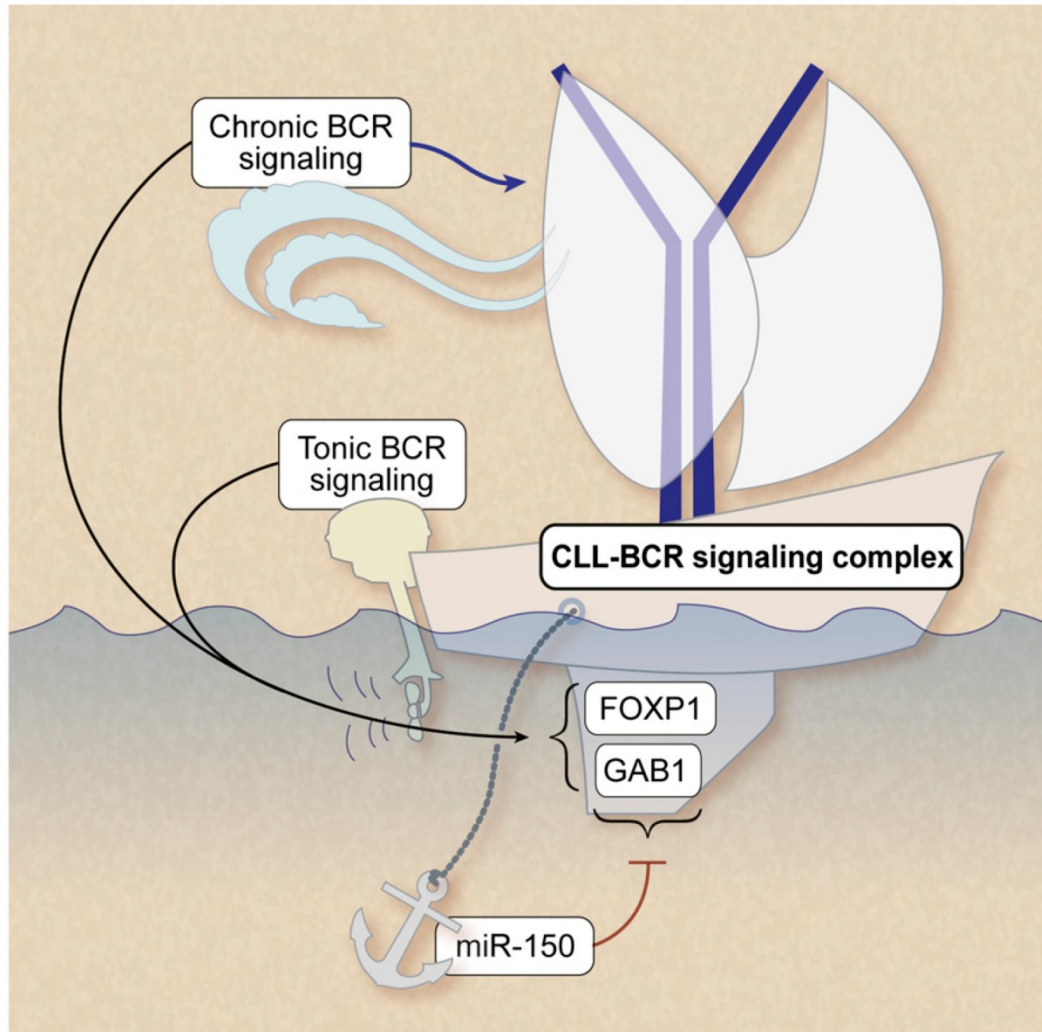

Ligand-independent ("tonic") and ligand-dependent ("chronic") BCR signaling play a pivotal role in CLL survival and growth. miR-150 dampens the threshold for BCR signaling by repressing expression levels of GAB1 and FOXP1. Professional illustration by Debra T. Dartez.

miRNAs přispívají k regulaci mnoha drah

Figure 3

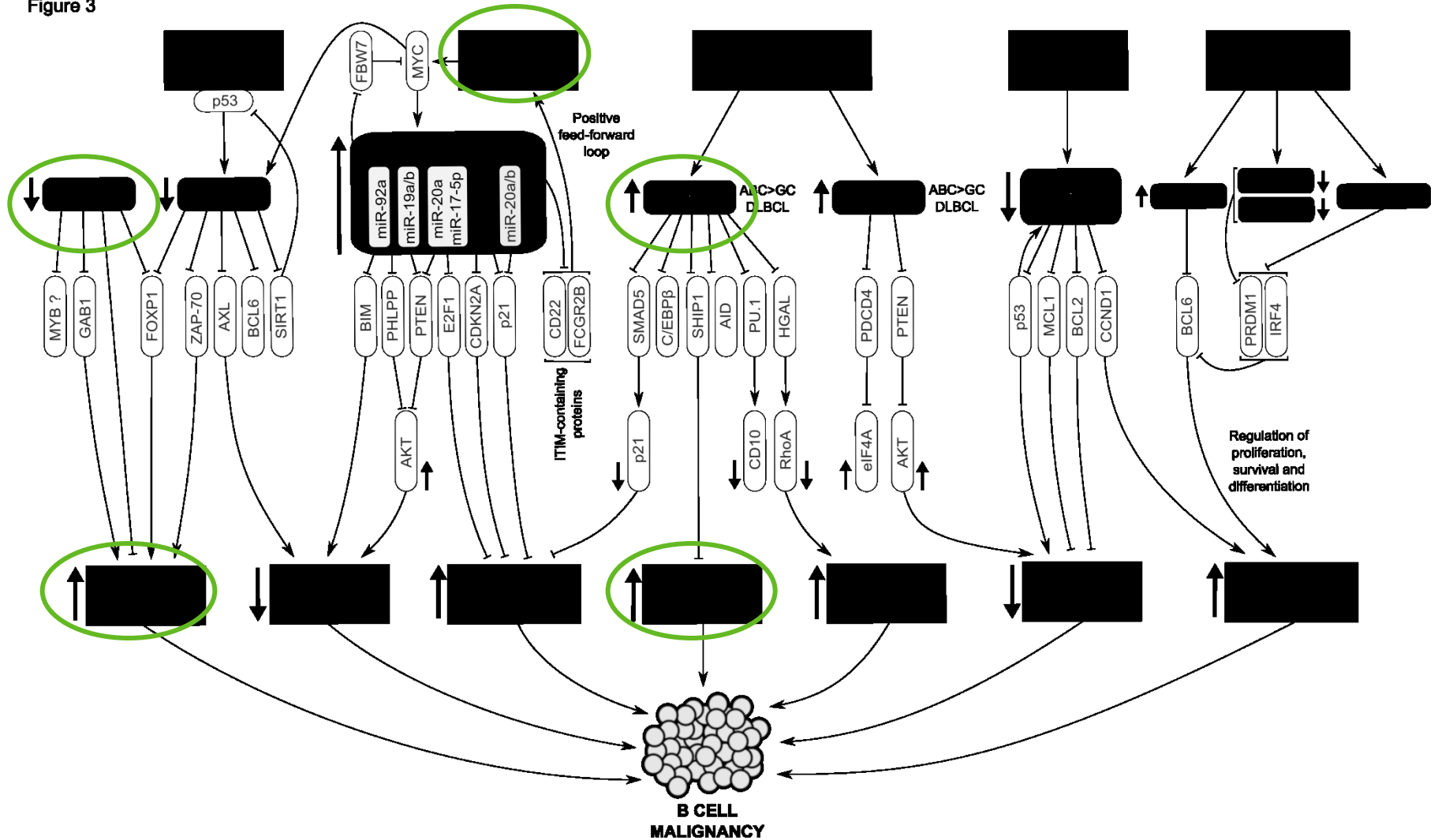

- potentially useful as **therapeutic targets**

nature Vol 452 | 17 April 2008 | doi:10.1038/nature06783

LETTERS

LNA-mediated microRNA silencing in non-human primates

Joacim Elmén^{1*}, Morten Lindow^{1*}, Sylvia Schütz², Matthew Lawrence³, Andreas Petri¹, Susanna Obad¹, Marie Lindholm¹, Maj Hedtjärn¹, Henrik Frydenlund Hansen¹, Urs Berger⁴, Steven Gullans³, Phil Kearney¹, Peter Sarnow², Ellen Marie Straarup¹ & Sakari Kauppinen^{1,5}

PCR based therapeutics?!

blood

2012 120: 1678-1686
Prepublished online July 13, 2012;
doi:10.1182/blood-2012-02-410647

LNA-mediated anti-miR-155 silencing in low-grade B-cell lymphomas

Yong Zhang, Aldo M. Roccaro, Christopher Rombaoa, Ludmilla Flores, Susanna Obad, Stacey M. Fernandes, Antonio Sacco, Yang Liu, Hai Ngo, Phong Quang, Abdel Kareem Azab, Feda Azab, Patricia Maiso, Michaela Reagan, Jennifer R. Brown, To-Ha Thai, Sakari Kauppinen and Irene M. Ghobrial

Díky za pozornost

CEITEC MU

Mraz Lab: Katerina Cerna, Katerina Musilova, Vasek Seda,
Gabriela Pavlasova, Veronika Svobodova, Sonali Sharma, Jan Oppelt

Marek.Mraz@email.cz

Hledáme nadšené studenty (Bc, Mgr, PhD) a post-doky