



# Digestive system 1

- Oral cavity:
  - Lips
  - Tongue
  - Palate – soft
    - hard
- Tooth

# Common structure of the wall of GIT tube



- **The mucosa**
  - epithelial lining
  - lamina propria  
/loose connect. tissue/
  - the muscularis mucosae
- **The submucosa**  
/loose connect. tissue + Meissner's nerve plexus/
- **The muscularis**
  - circular
    - myenteric nerve plexus
  - Longitudinal smooth muscle
- **The serose or adventitia**  
/loose connect. tissue -  
/type of the lining/

# The oral cavity

(the mucosa)

## The epithelium

Nonkeratinized  
stratified squamous ep.

## Lamina propria

loose connective tissue

The muscularis mucosae  
is missing!!!

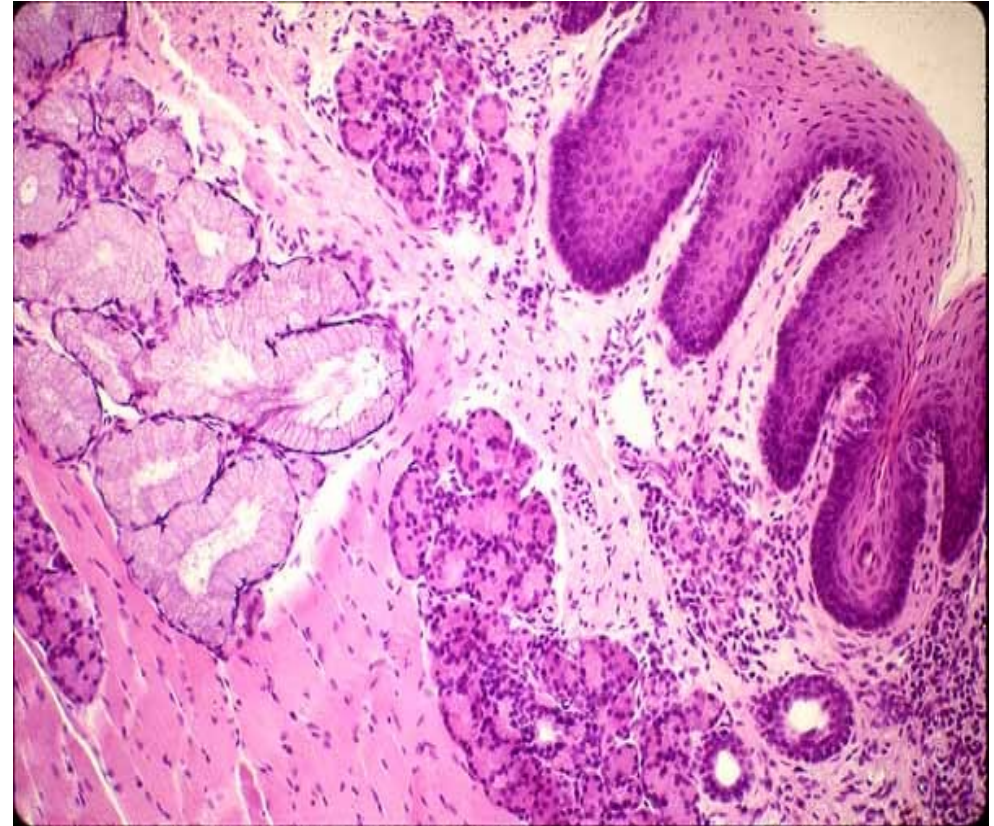

Lam. propria → the submucosa (loose connect. tissue) / periost / muscle



# Labium oris

External surface - skin

hair follicles

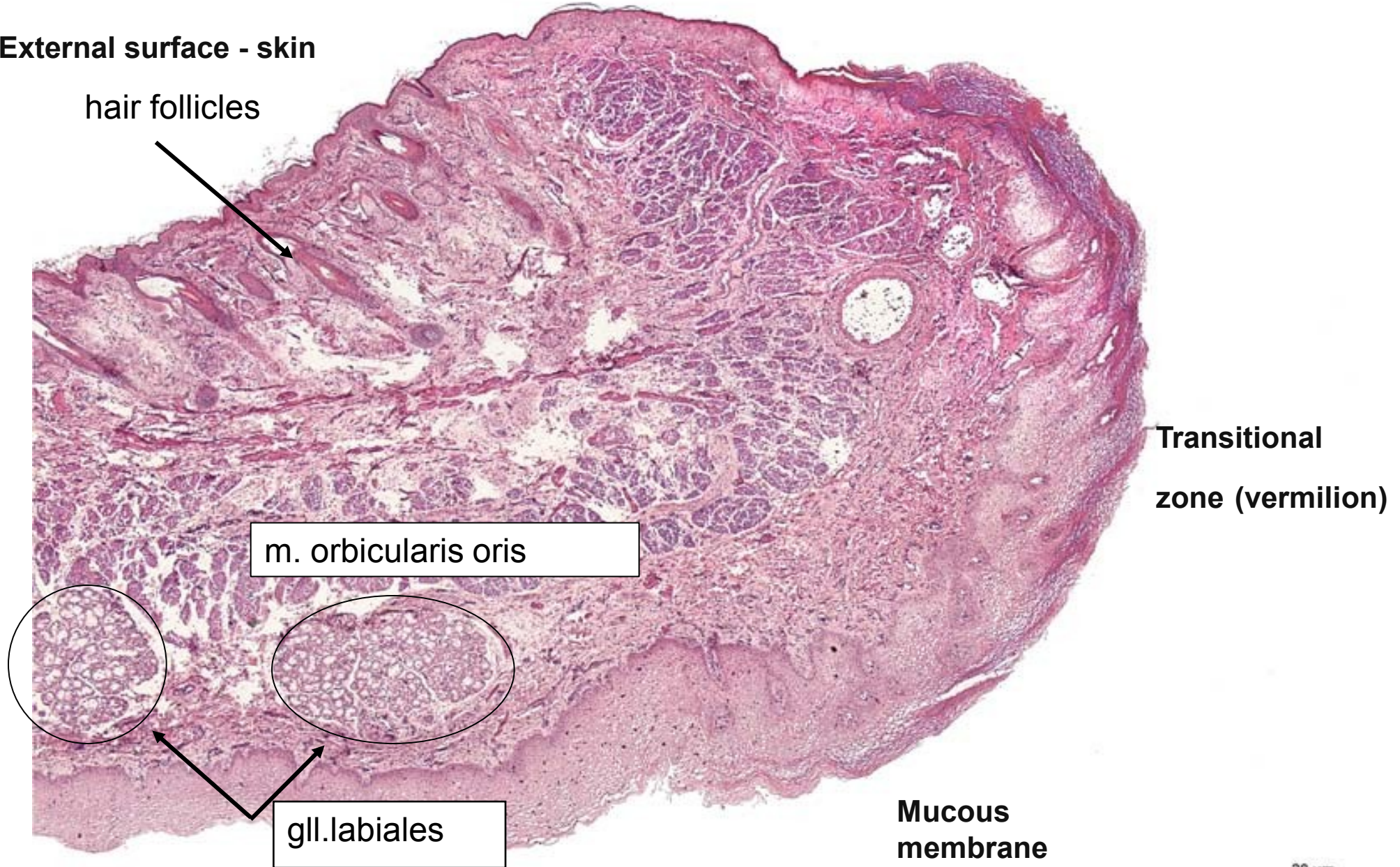

Transitional  
zone (vermillion)

m. orbicularis oris

gll. labiales

Mucous  
membrane

20  $\mu$ m



# Lips *labia*

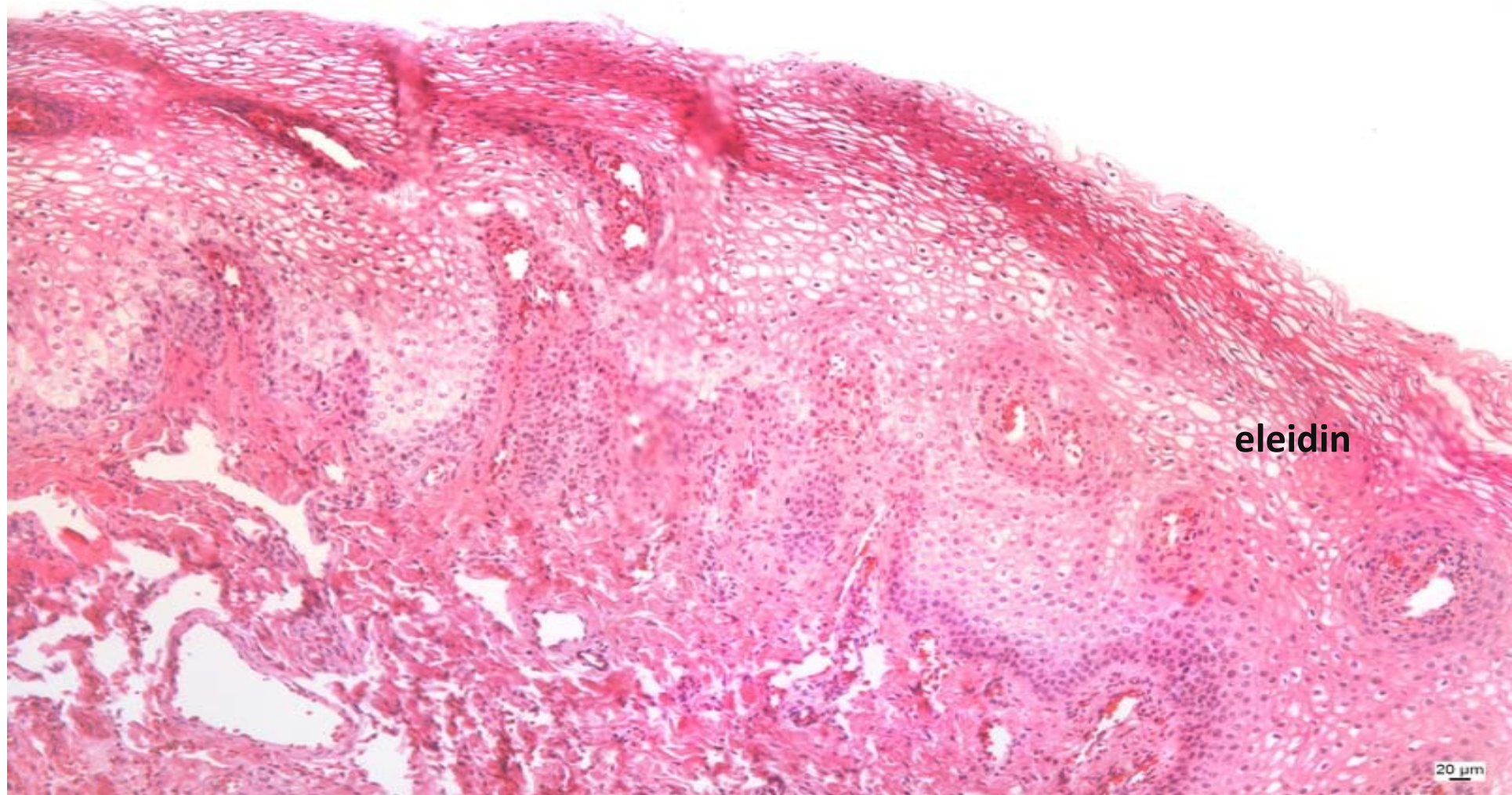

eleidin

- The epithelium is somewhat thicker than in other parts of the facial skin. C.t. papilla extend deep into the epithelium and are heavily vascularized. It is the proximity of these vessels to the surface of the epithelium which gives the prolabium it's red appearance.



Labium oris – inner surface , (HE), objektiv 10x

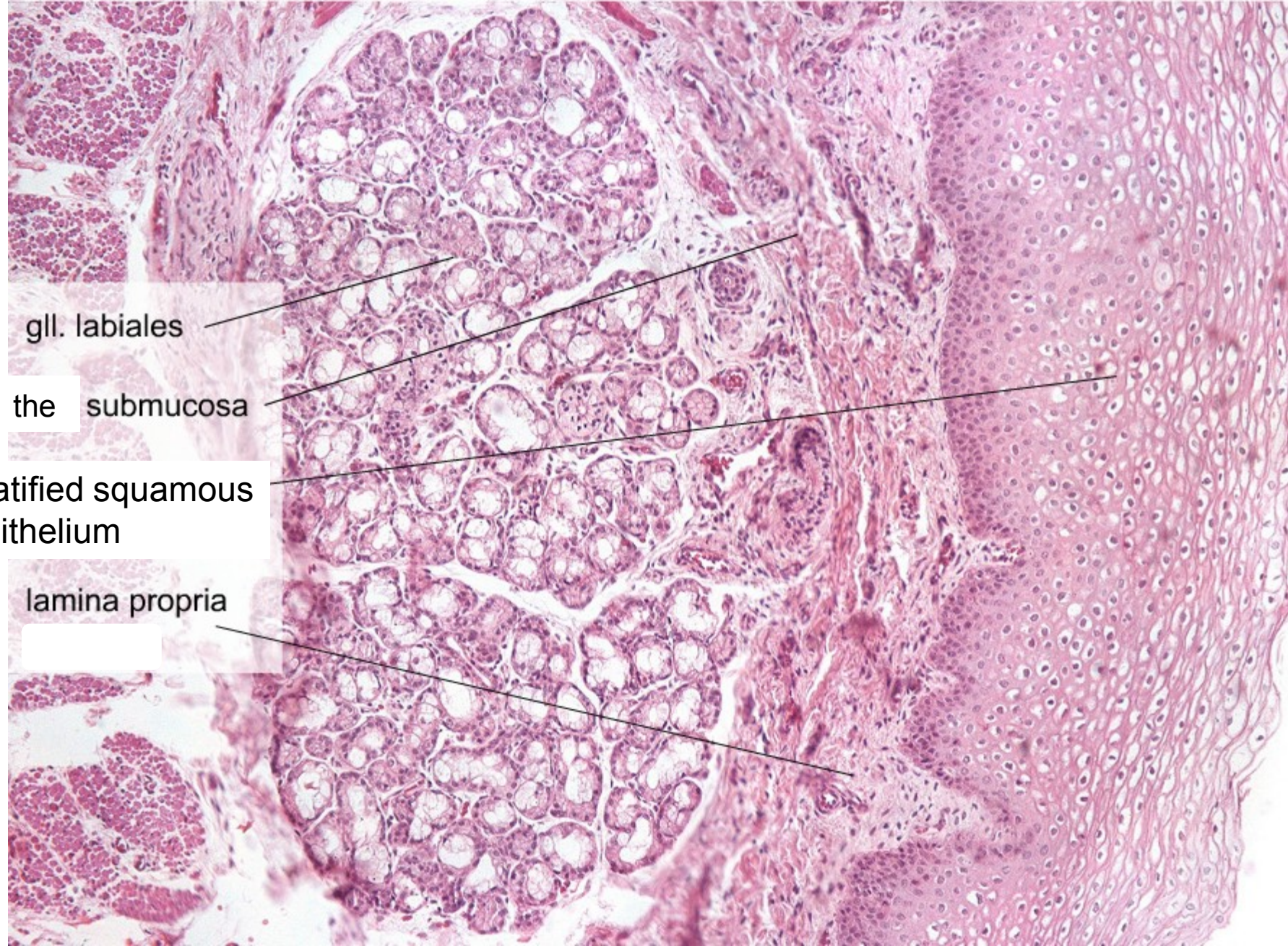

gll. labiales

the submucosa

stratified squamous  
epithelium

lamina propria



# Tongue

- dorsal surface

The mucosa – filiform, fungiform, circumvallatae, foliatae pap.  
(the submucosa is missing!)  
aponeurosis linguae

- inferior surface (mylohyoidea)

The mucosa – without papillae  
the submucosa!



-papillae = elevations of the oral epithelium  
and lamina propria

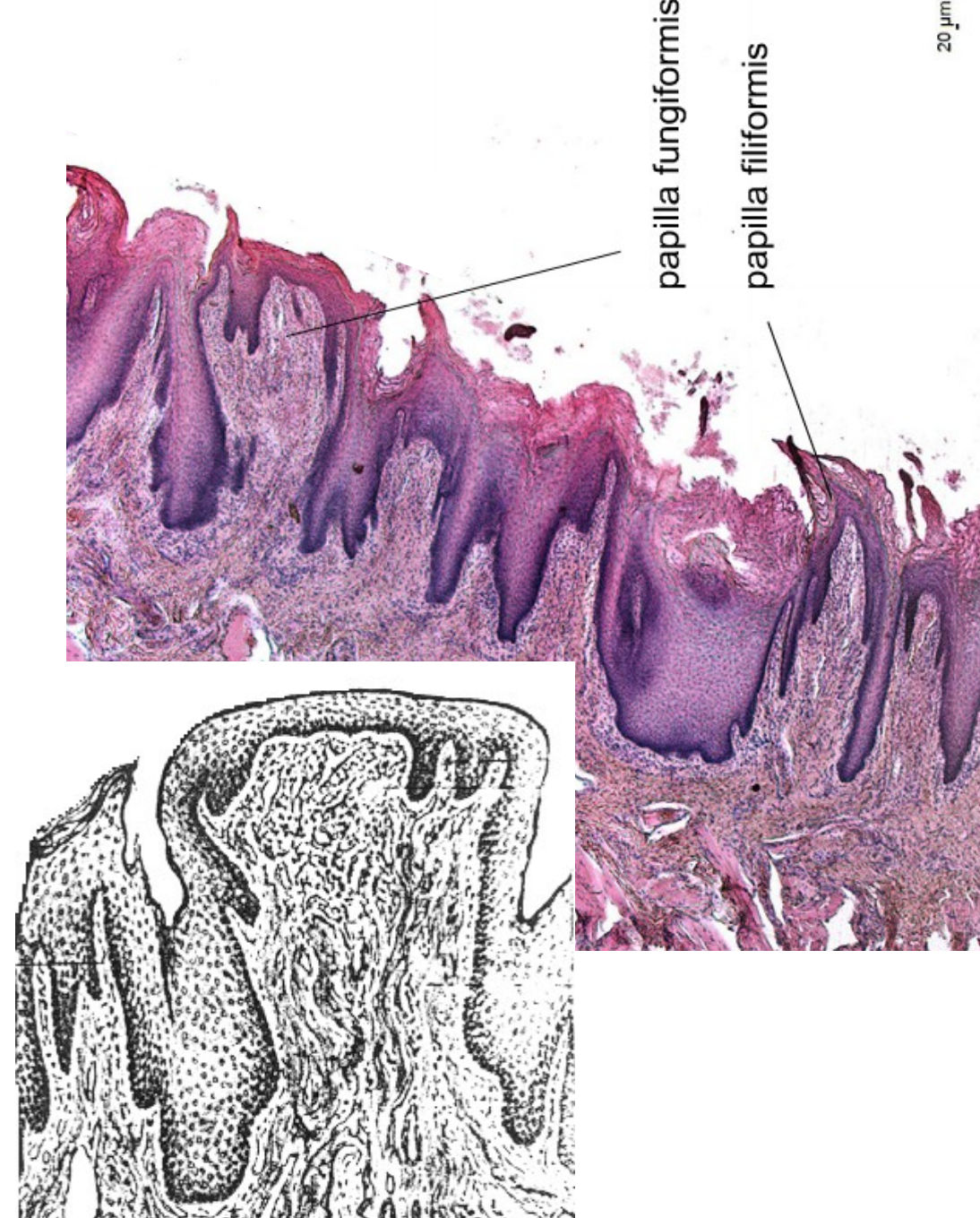



Apex linguae

dorsum linguae

facies mylohyoidea

gl. apicis linguae - Blandini

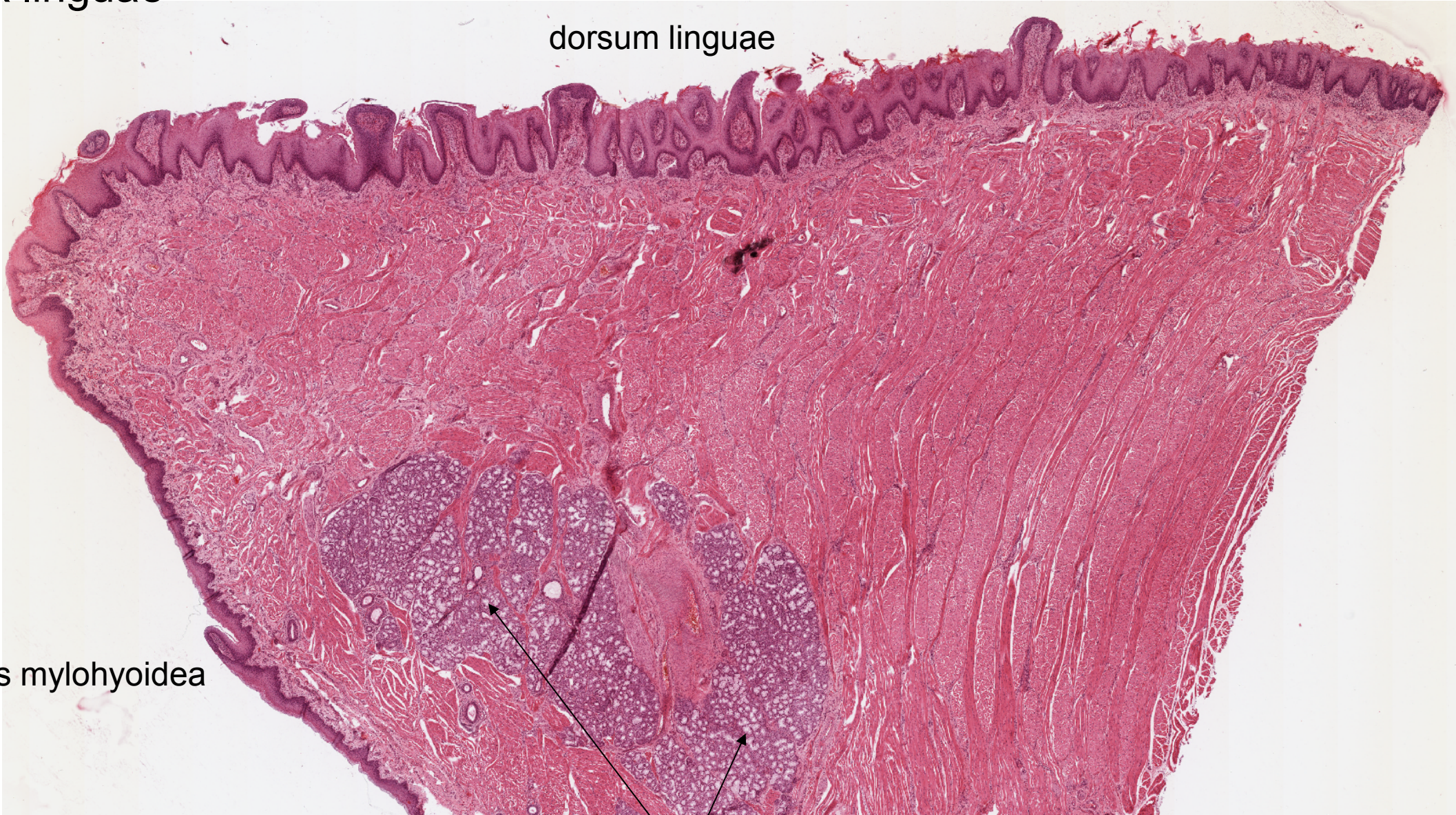



Apex linguae – dorsum, (HE), objektiv 2,5×

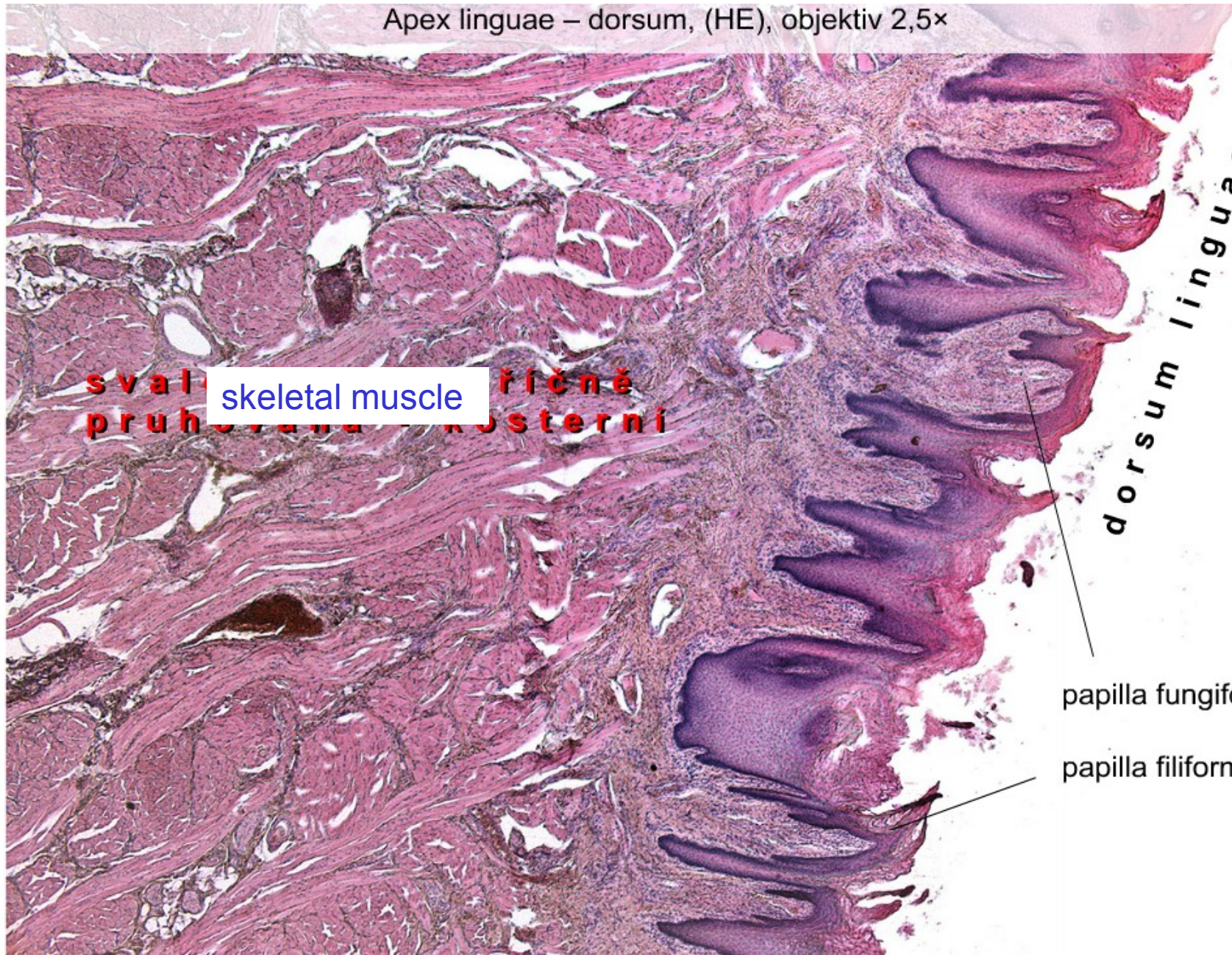

svalni pruhovani kosterni  
skeletal muscle

*dorsum linguae*

papilla fungiformis

papilla filiformis

20 μm



# Apex linguae

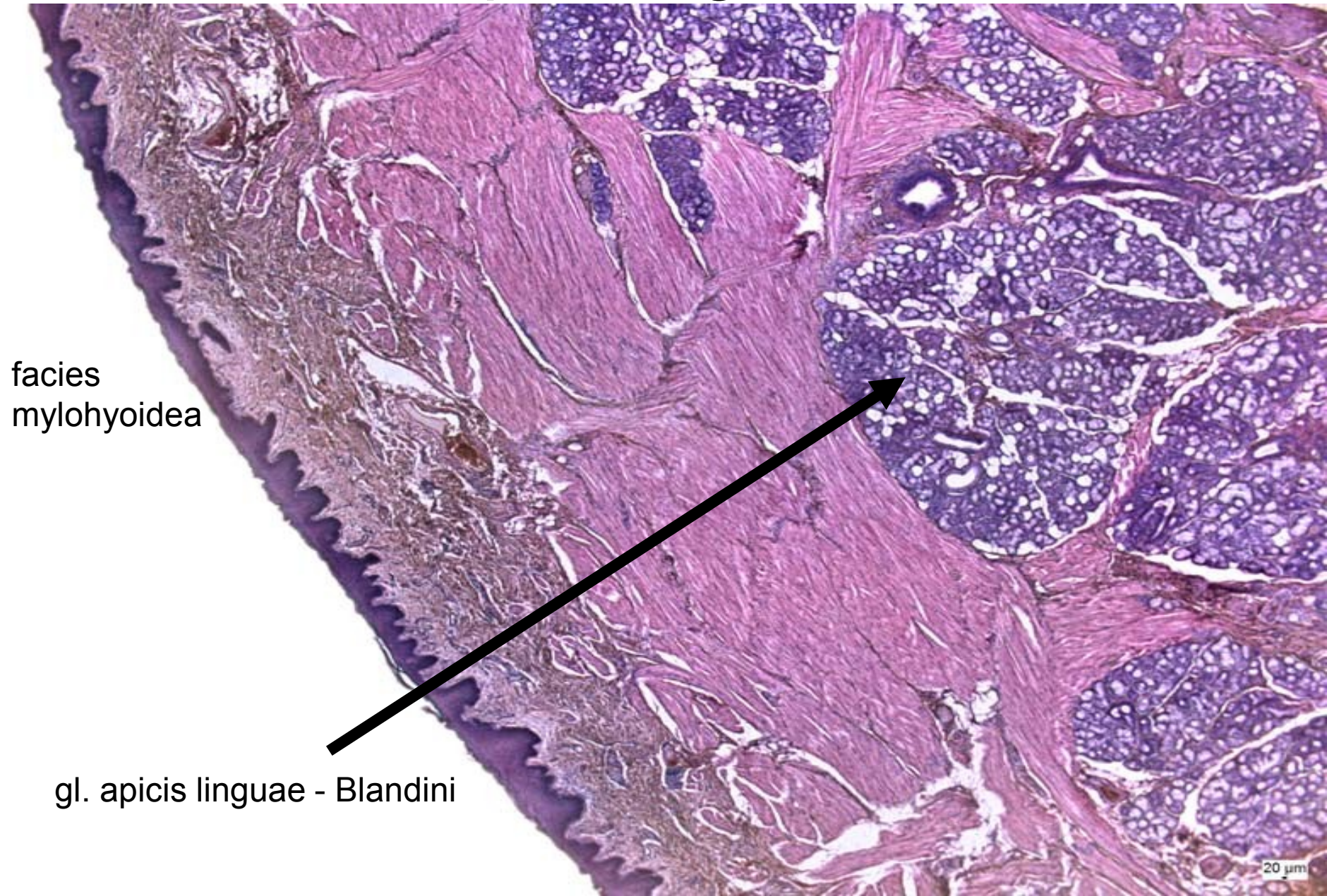

facies  
mylohyoidea

gl. apicis linguae - Blandini

20  $\mu$ m



# Circumvallate Papillae

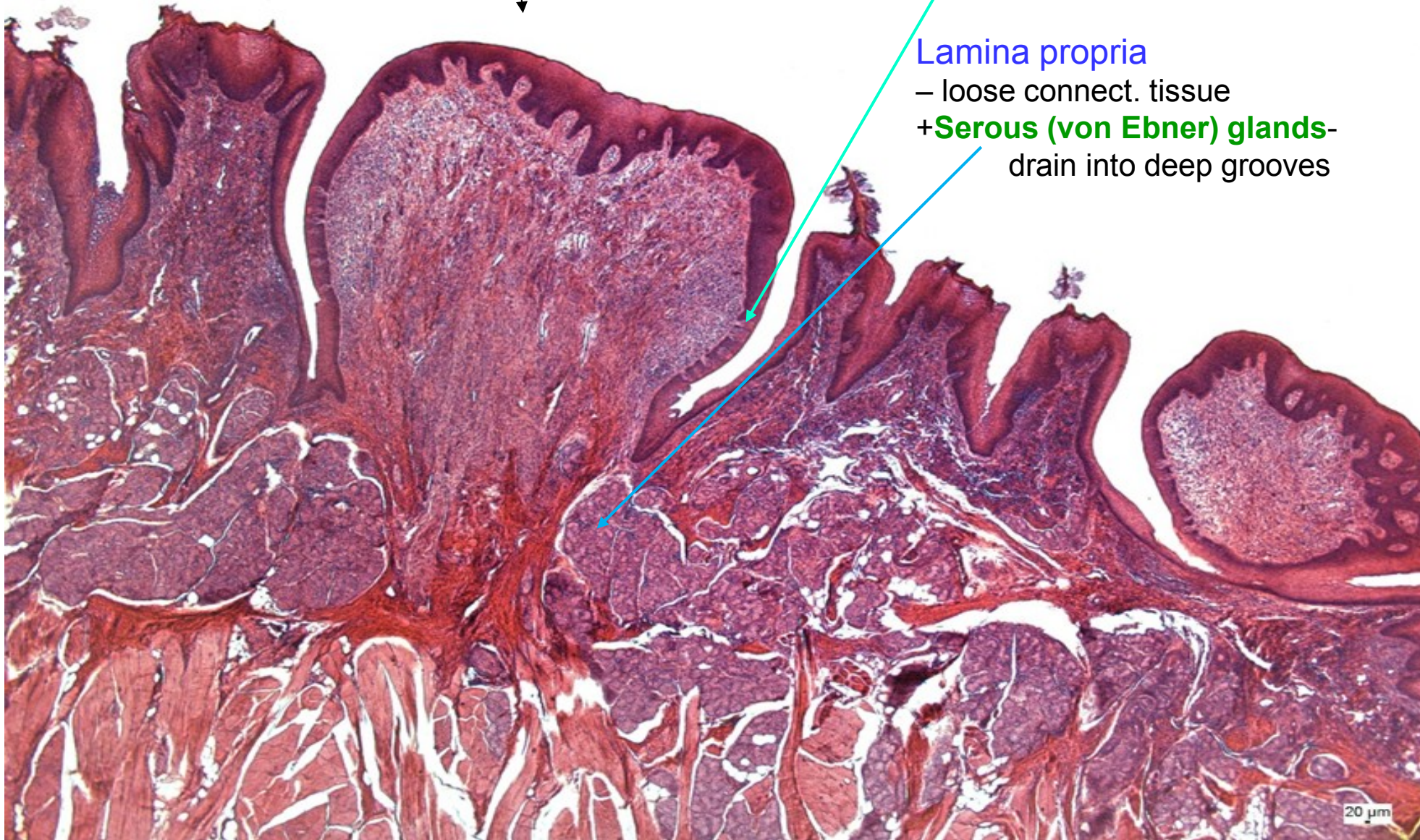

The epithelial lining  
– strat. squam. ep.

+ taste buds

Lamina propria

– loose connect. tissue

+ Serous (von Ebner) glands-  
drain into deep grooves

20 μm



# Circumvallate papilla (HE)

Taste bud



groove

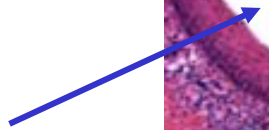

Gland duct



**gll. gustatoriae (Ebneri)**

20 μm



Taste bud

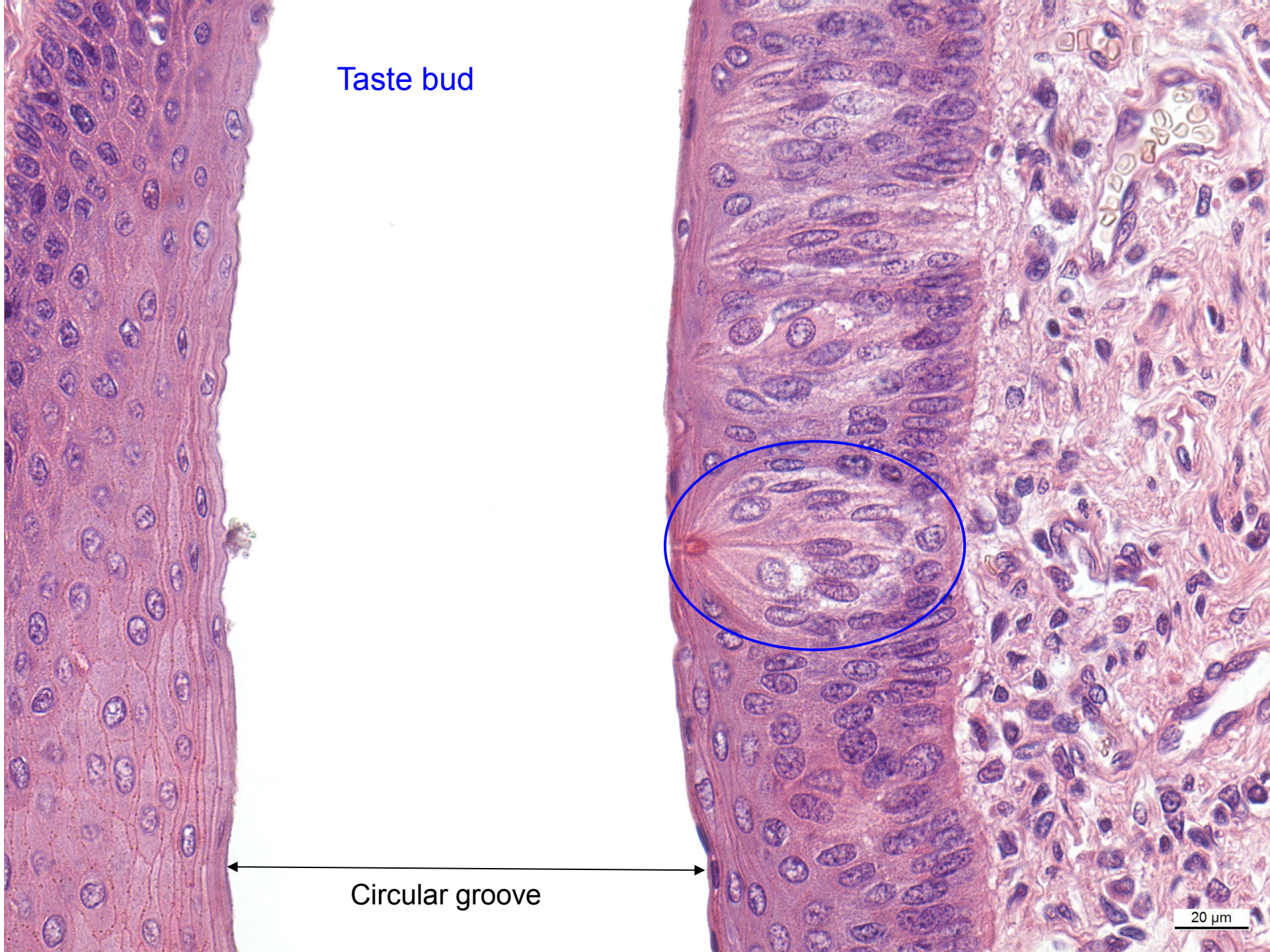

Circular groove

20  $\mu$ m



# The lingual tonsil

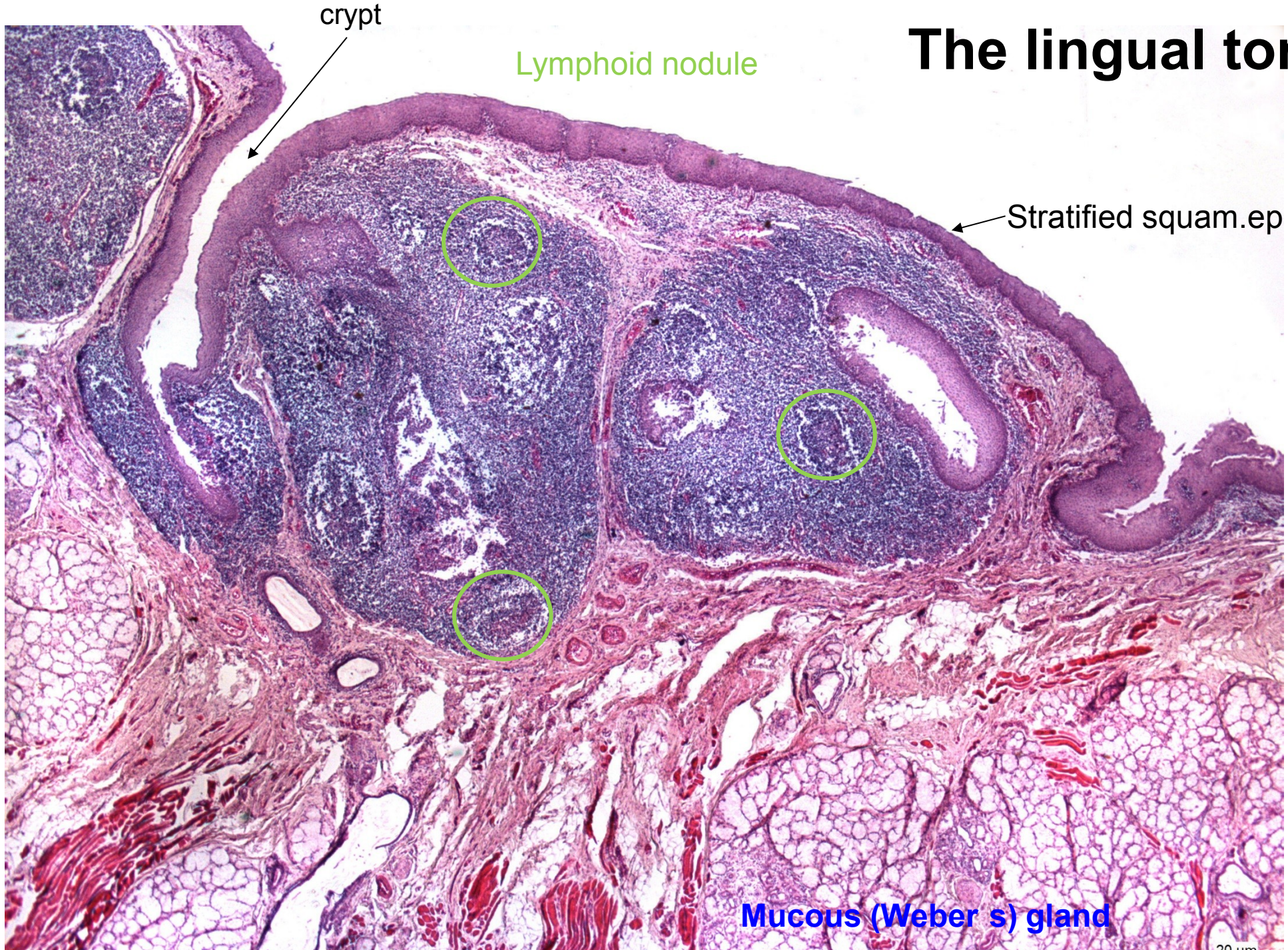



# Soft palate

Nasal surface

Mixed gl. - **gll. nasales**

**aponeurosis palatina-**  
Skeletal muscle+connect. tissue

Mucous glands - **gll. palatinae**,

Oral surface

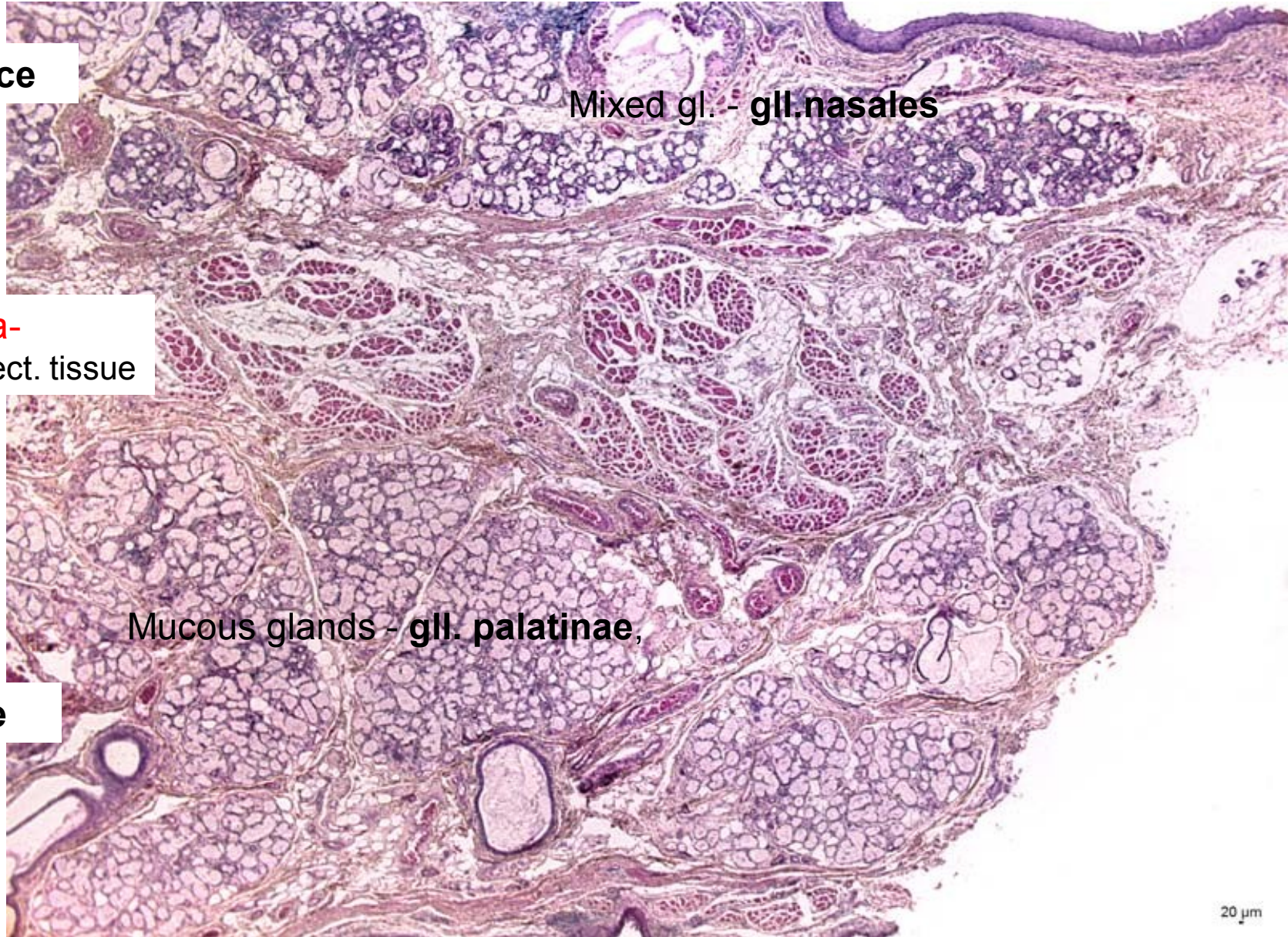



## Nasal surface

- ciliated pseudostrat. columnar ep.(metaplasia)
- gll. nasales (mixed gl.)

stratified squam. ep.

duct

20  $\mu$ m





## Oral surface

- stratified squamous epithelium
- gll. palatinae (MUCOUS gl.)

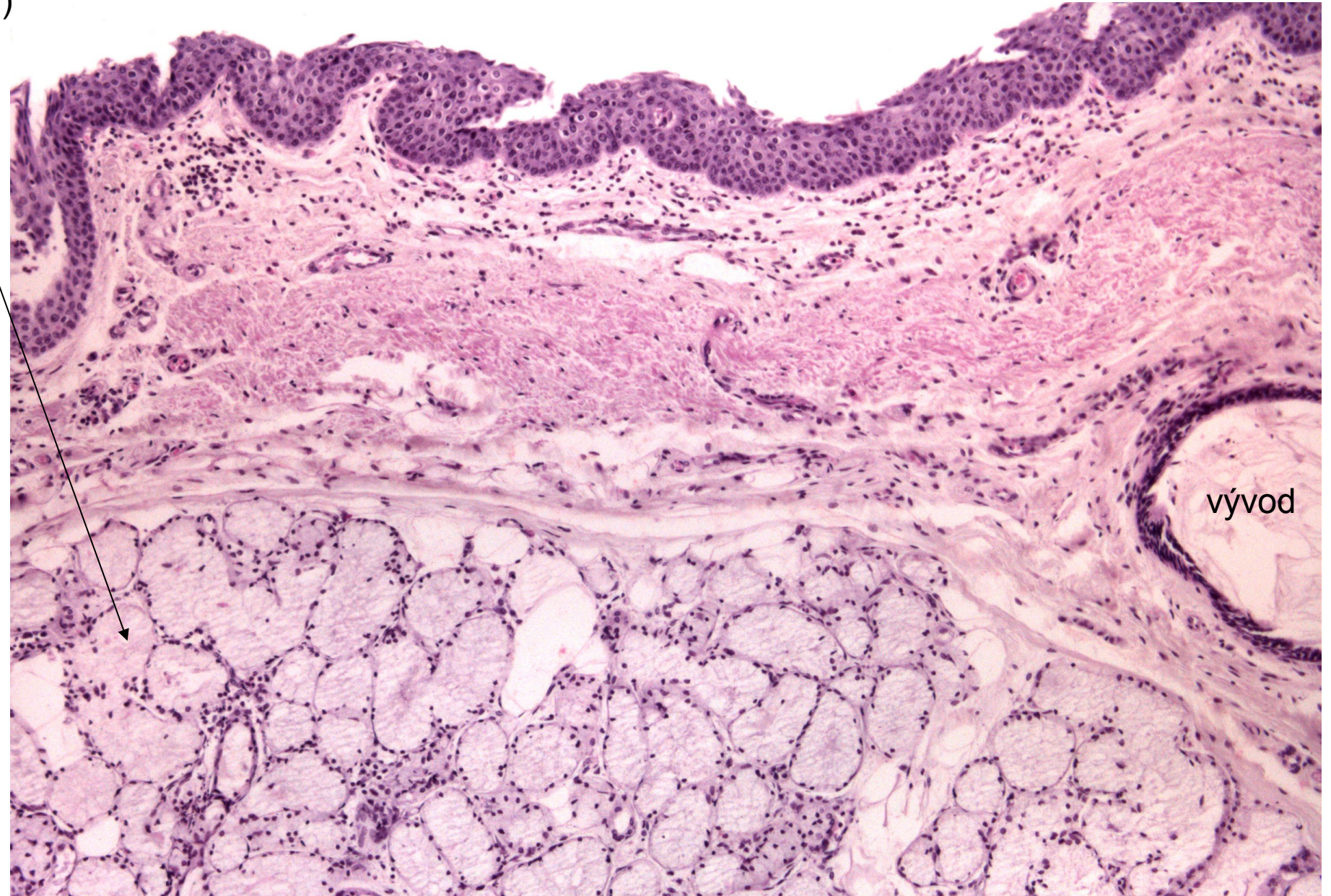



# Tooth (dens)

Deciduous (baby) teeth- 20

Permanent teeth - 28-32

radix (root)



## Anatomy

- Corona dentis (crown)
- Collum (neck)
- Radix (root)
- Cavum et canalis radices dentis (pulp cavity)
- Pulpa dentis
- Apex radices dentis + foramen apicis radices dentis (apical foramen)
- Alveoli
- Periodontal ligament (membrane)**  
dense connective tissue fibers



# Tooth

ROOT

CROWN

cementum

enamel!!!!

dentin

dentinal tubules with odontoblast processes (Tomes' fibers)

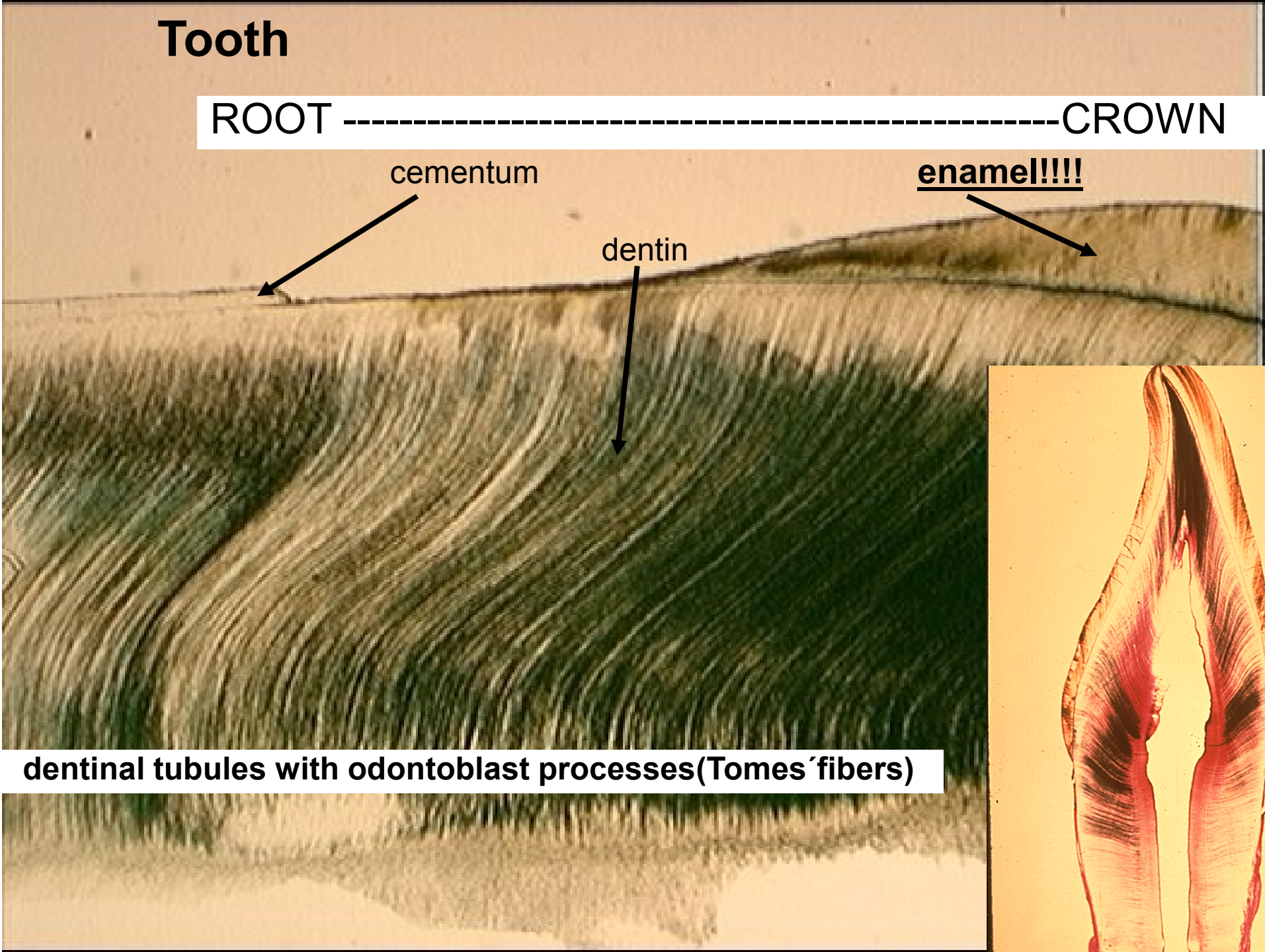



Tooth – (HE) 5x

periodontium

cement

dentin

predentin

odontoblasts

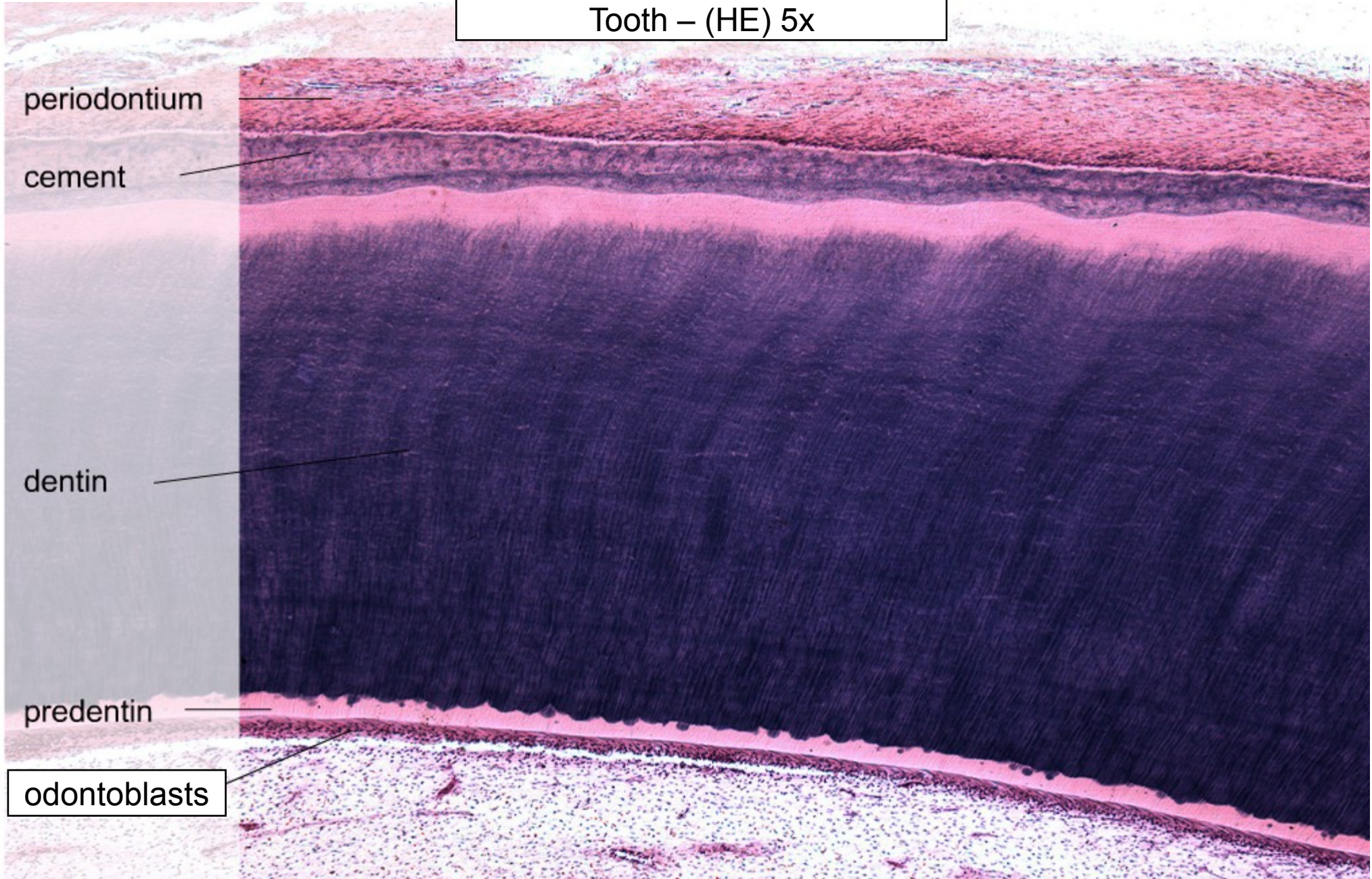





**Enamel is missing!!!**

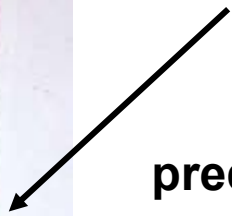

**predentin** – unmineralized dentin with nerve fibers

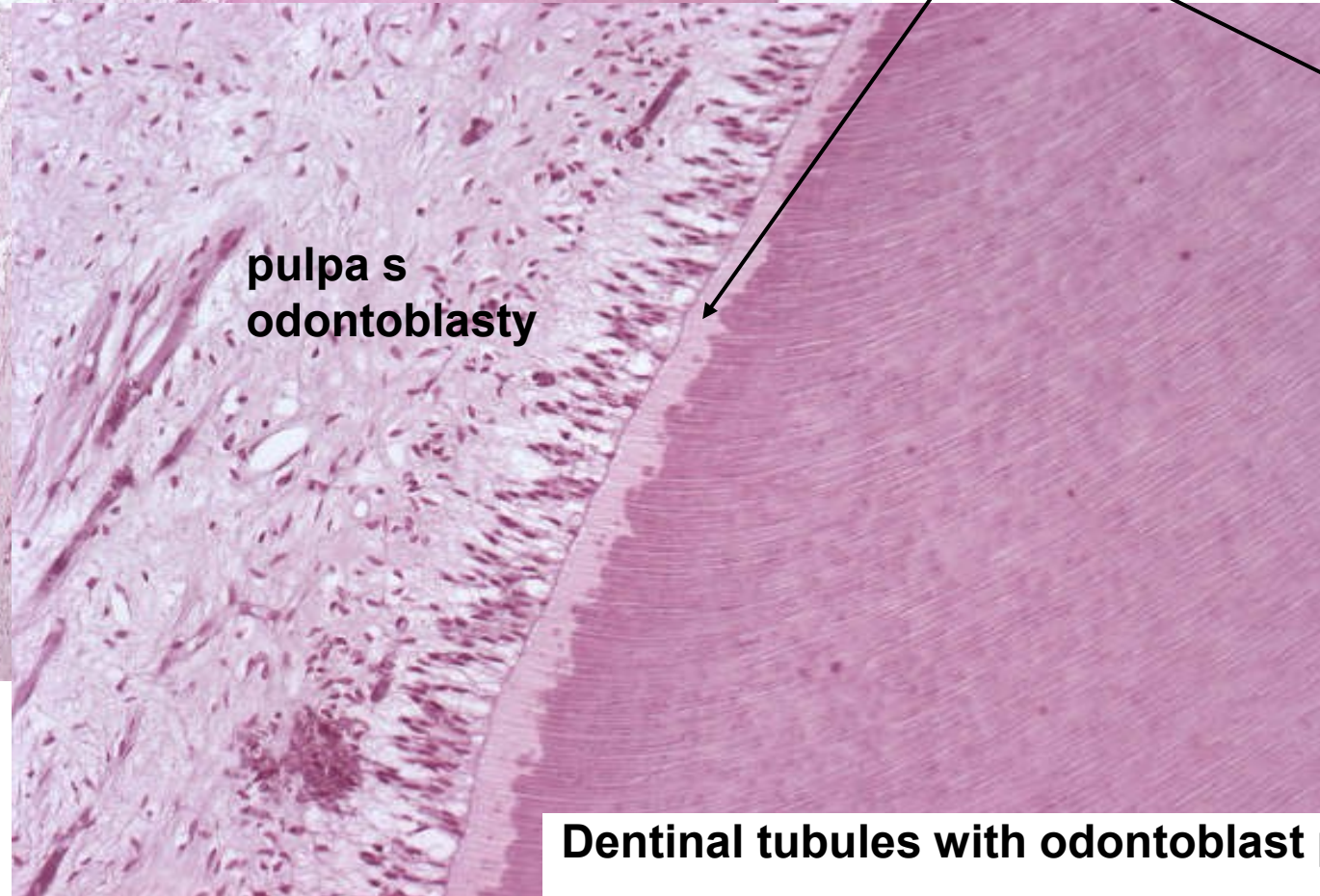
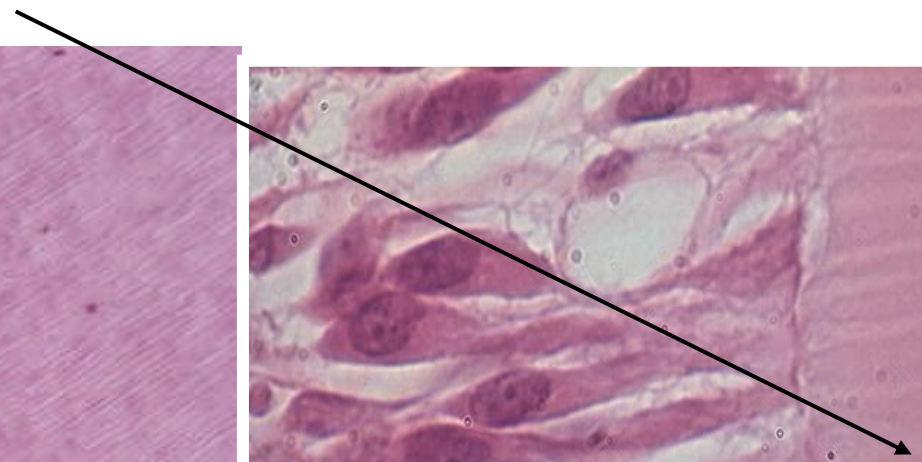

**pulpas odontoblasty**



**Dentinal tubules with odontoblast processes(Tomes' fibers)**





K  
O  
S  
T

D  
E  
N  
T  
I  
N

C  
E  
M  
E  
N  
T

P  
E  
R  
I  
D  
O  
N  
T  
I  
U  
M

**Periodontal ligament** –  
dense connective tissue  
**Alveolar bone** – woven bone  
**Gingiva** connective tissue  
papillae+stratif.squamous ep.  
**Epithelial attachment of  
Gottlieb**



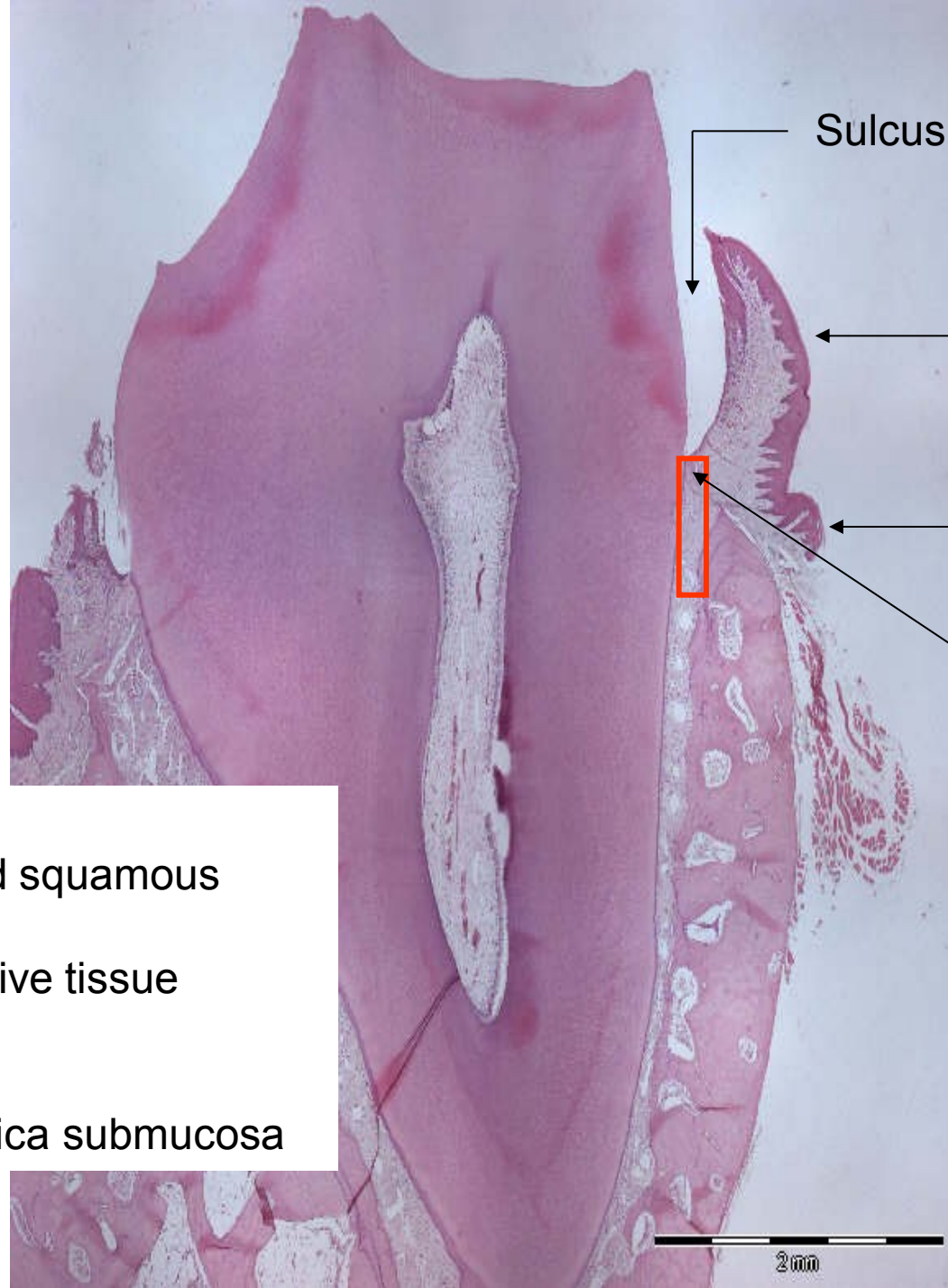

Sulcus gingivalis

Gingiva libera

Gingiva affixa

Epithelial attachment  
of Gottlieb  
= epith. of gingiva is  
bound to the tooth  
enamel

**GINGIVA**

- Stratified squamous epith.
- Connective tissue papillae

NO!!! Tunica submucosa

2mm



**1.**

# **Digestive system – I**



**Slides :**

- 1. Labium oris (HE)**
- 2. Apex linguae (HE)**
- 3. Papilla circumvallata(HE)**
- 4. Tonsilla lingualis (HE)**
- 5. Palatum molle(HE)**
- 7. Tooth (HE)**



# Development of the face, stomodeum and cervical region – embryo, day 24

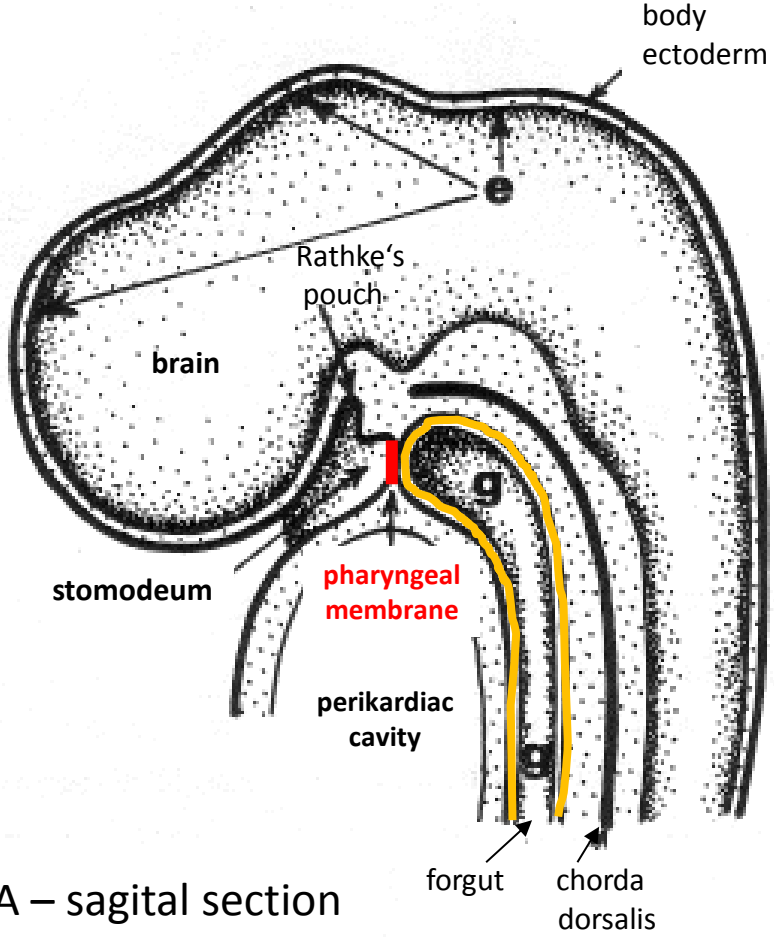

A – sagittal section

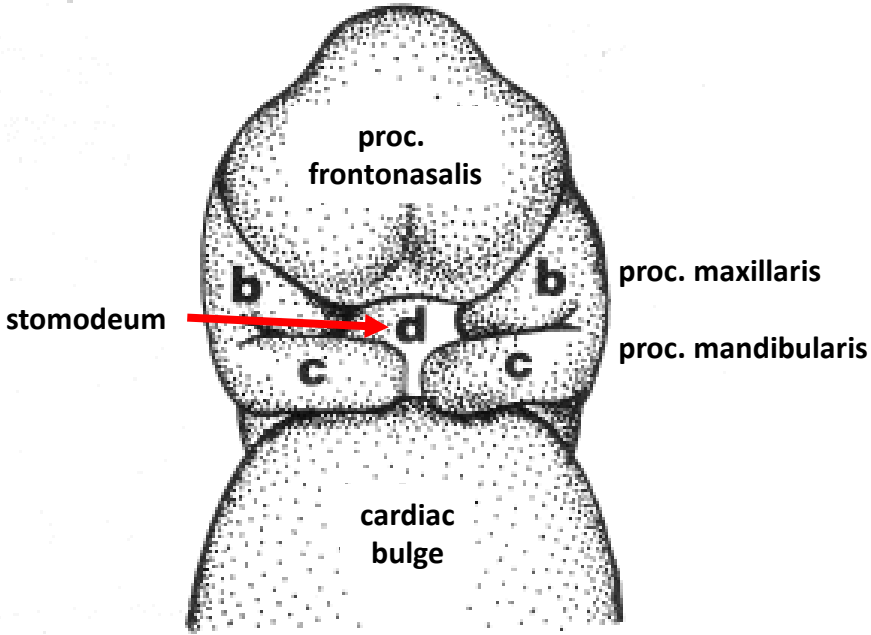

B – frontal view



# Development of the face, stomodeum and cervical region – embryo, day 28

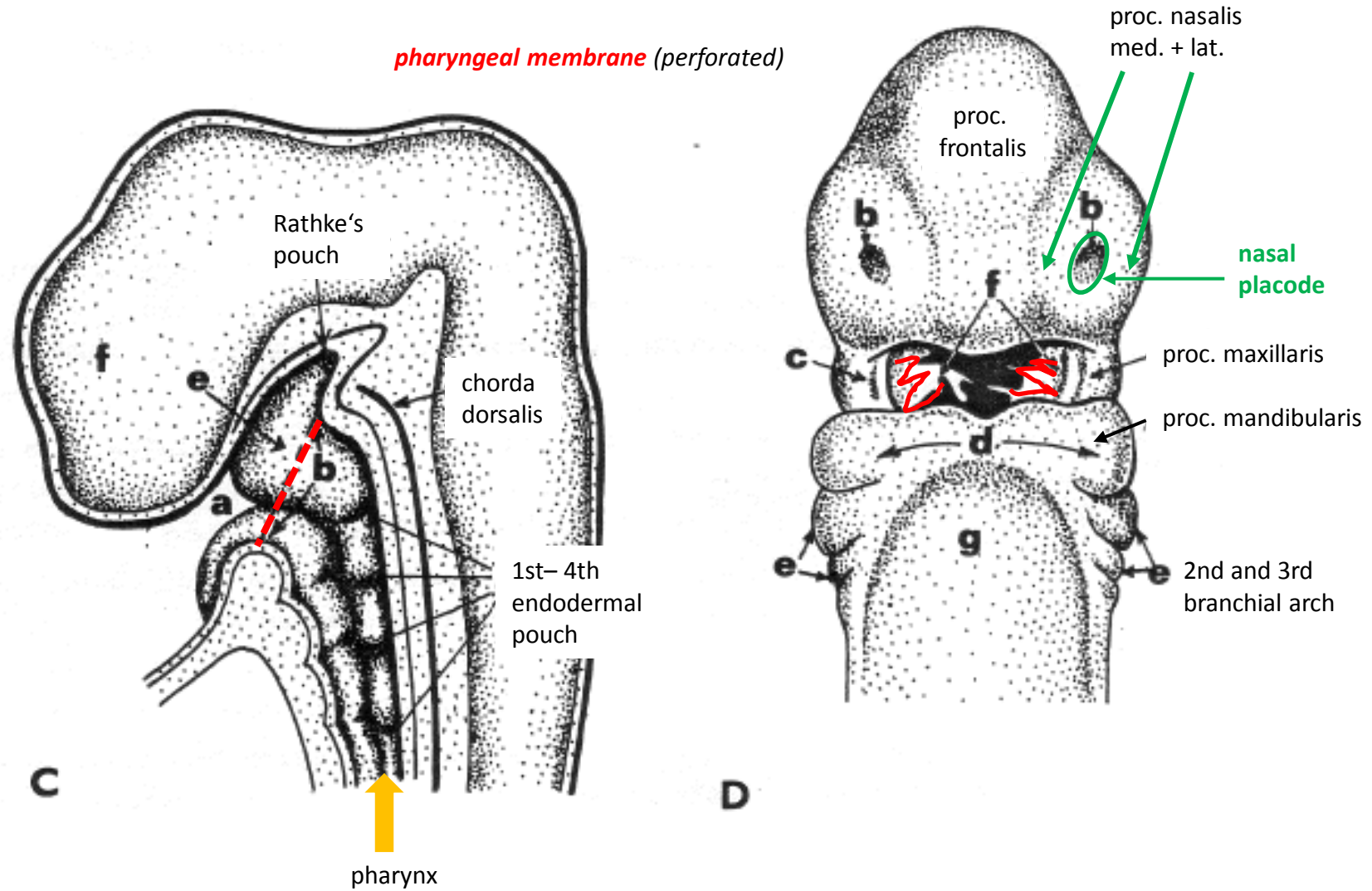



## Development of the face – embryo , end of week 5

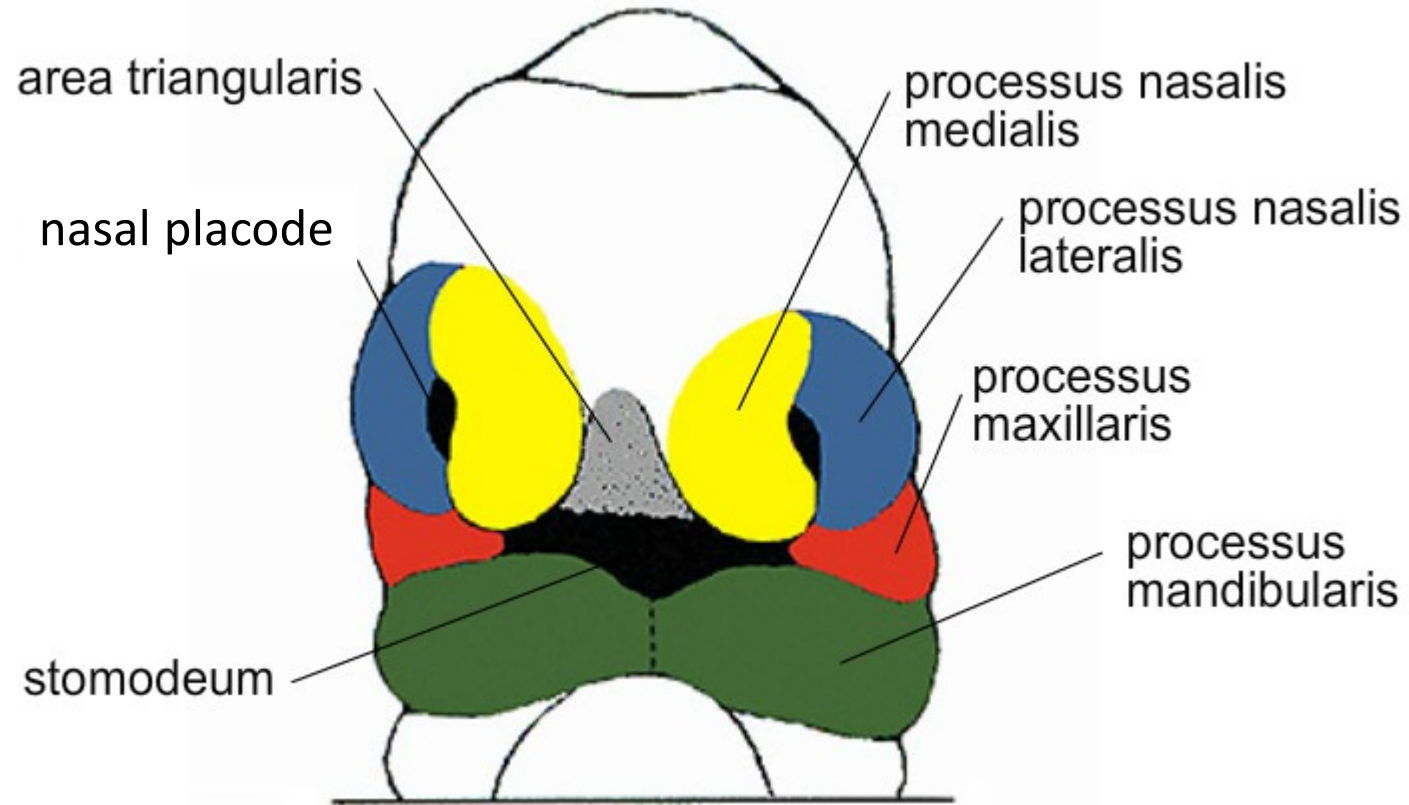
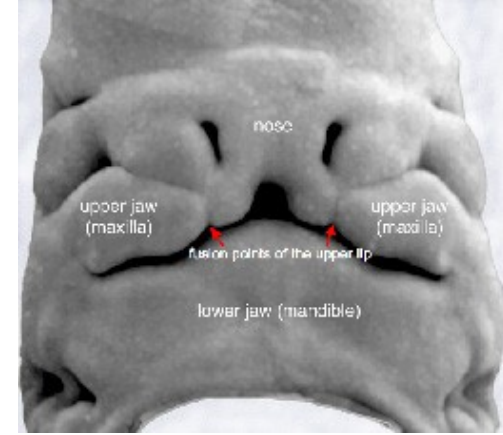



## Development of palate – embryo, A – week 7, B – week 8, C – week 10

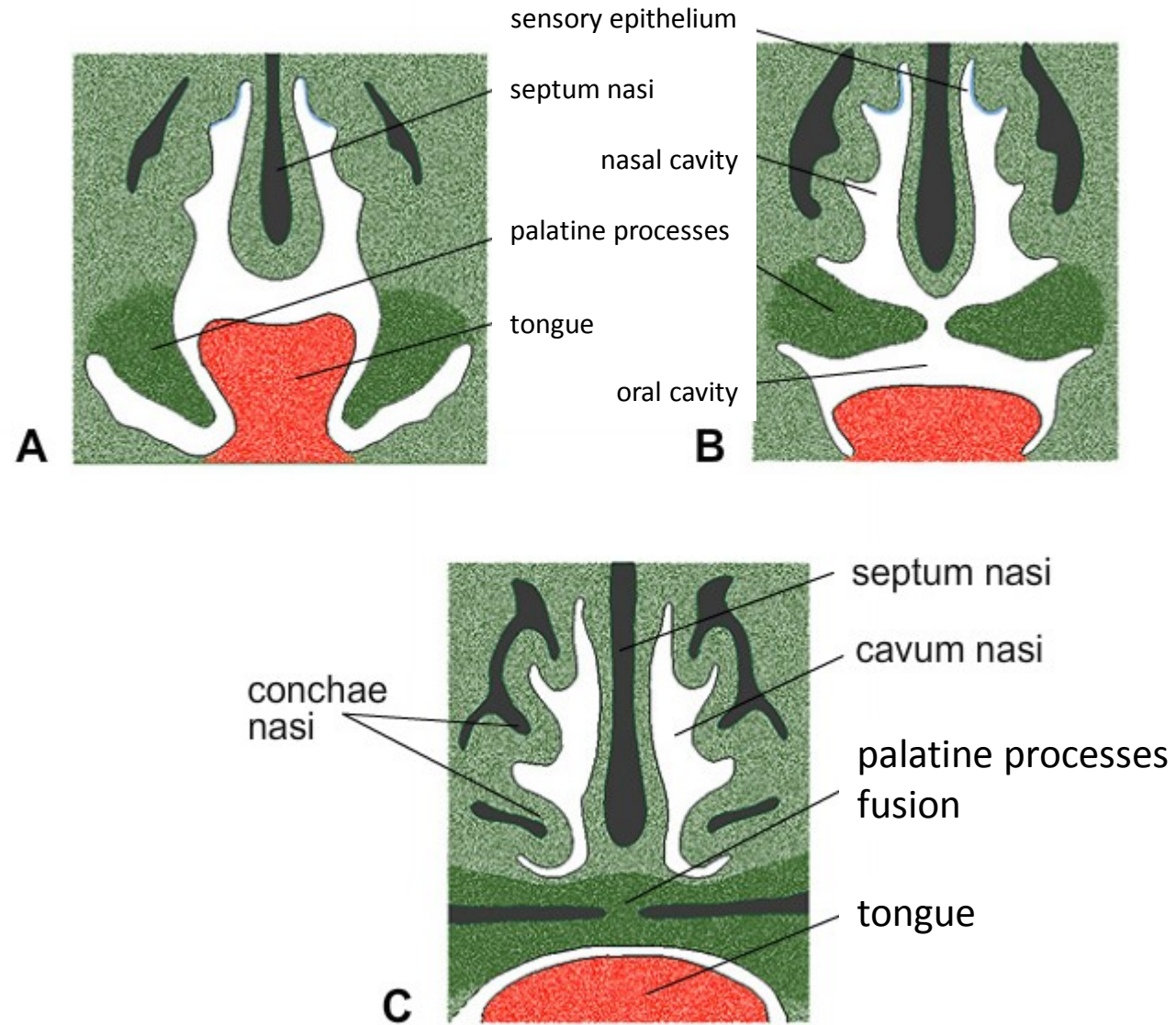



Development of the oral cavity – embryo, week 6

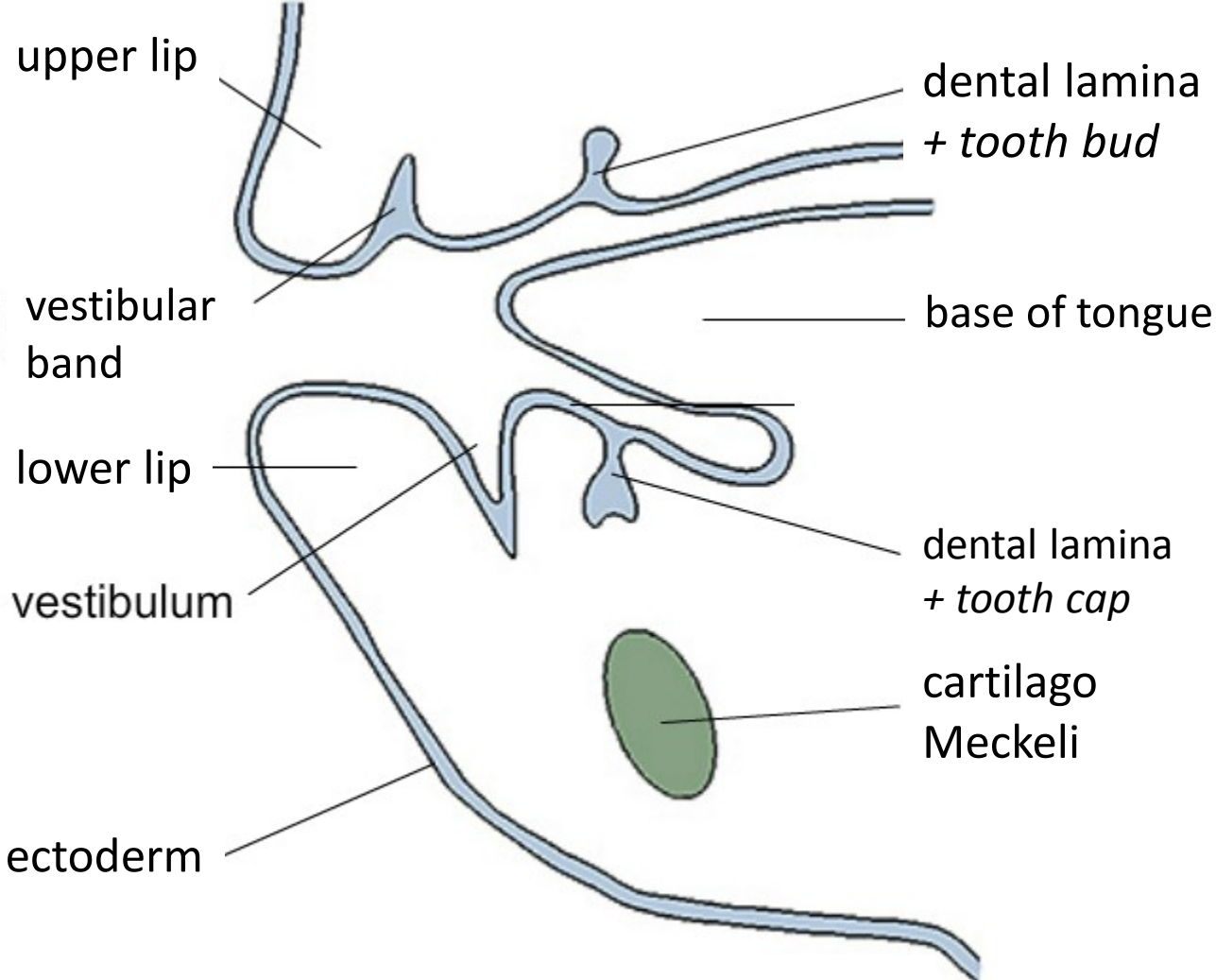



# Development of pharyngeal (branchial) apparatus – embryo, week 6

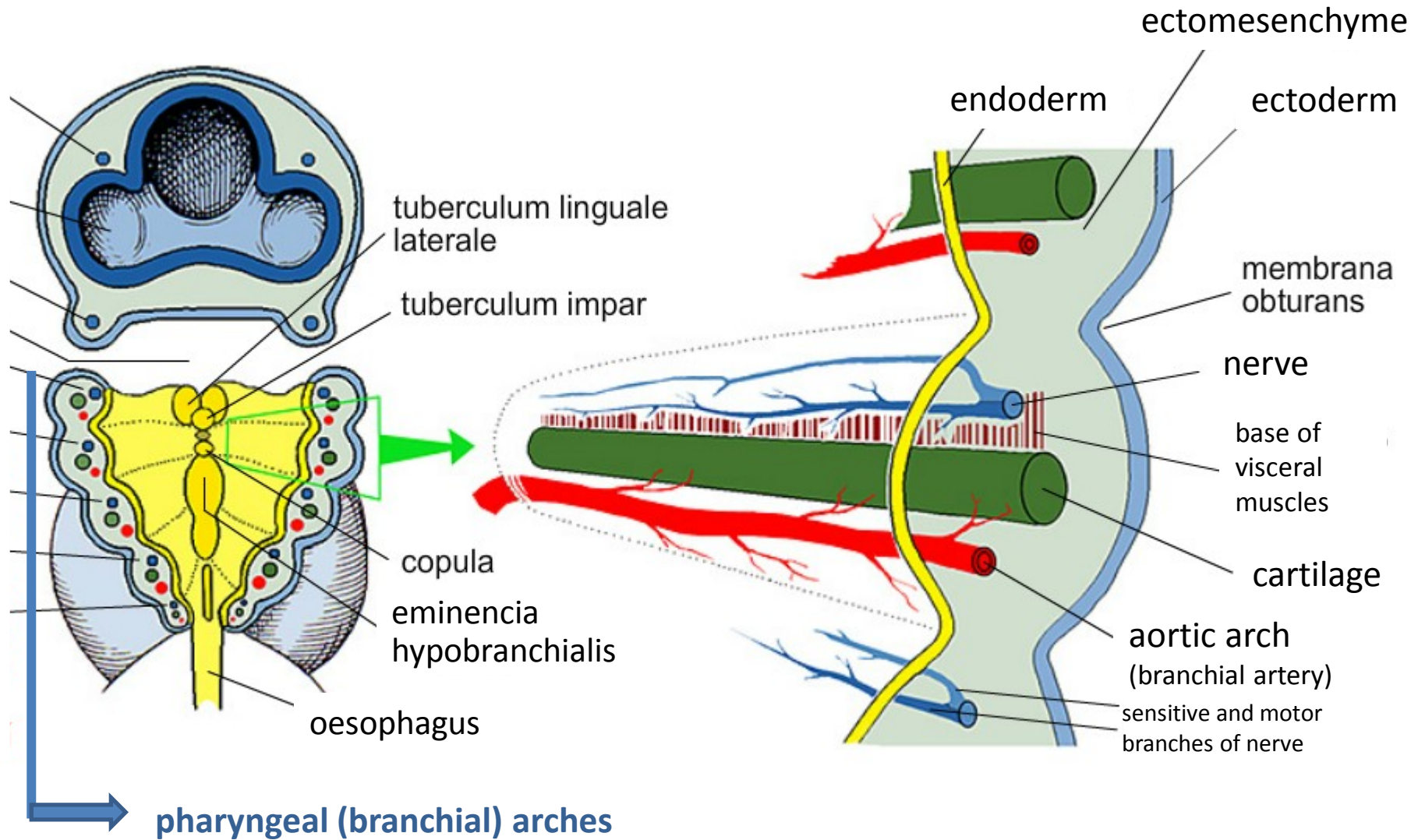



# Development of tongue

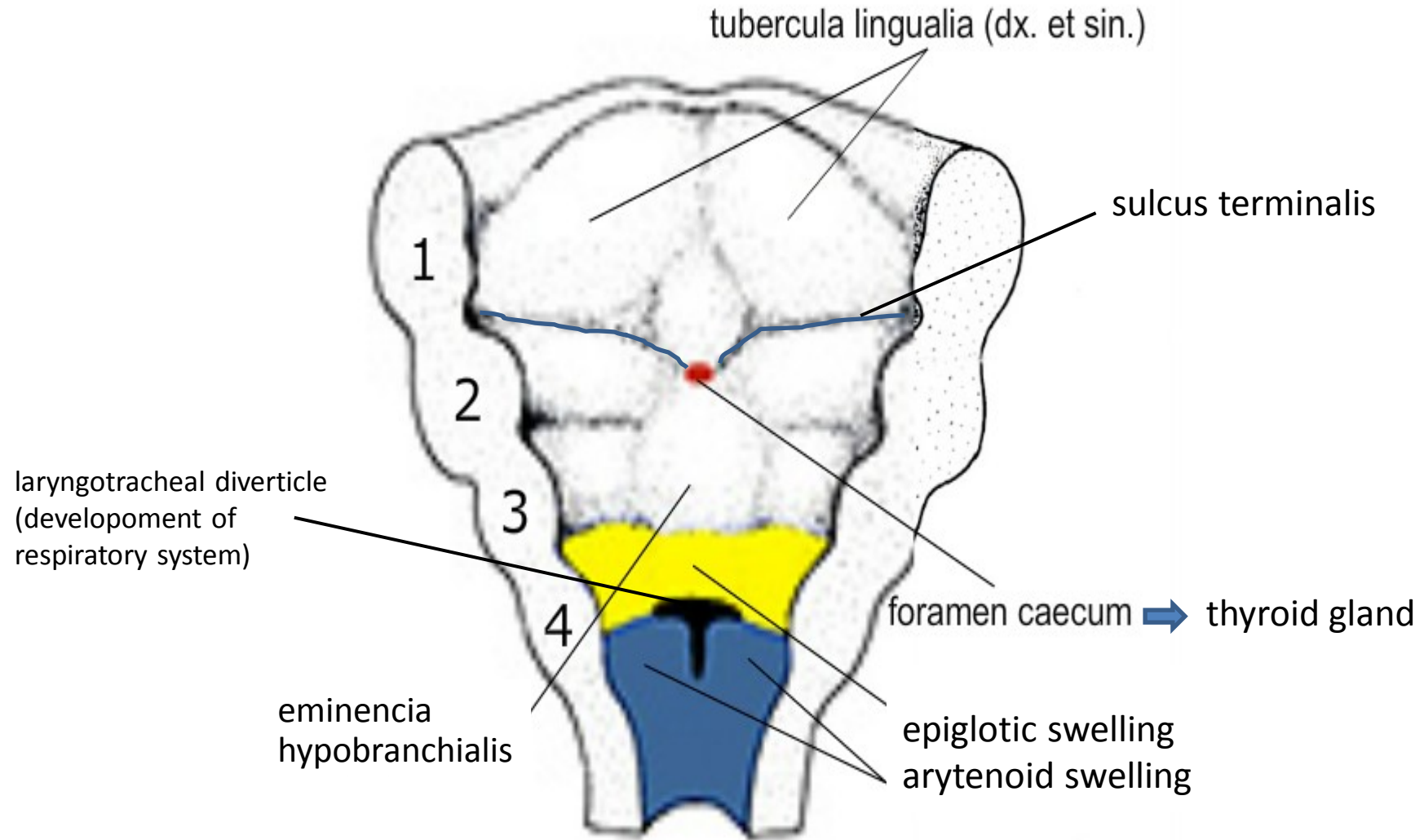



## ECTODERMAL CLEFTS and ENDODERMAL POUCHES – embryo, week 5

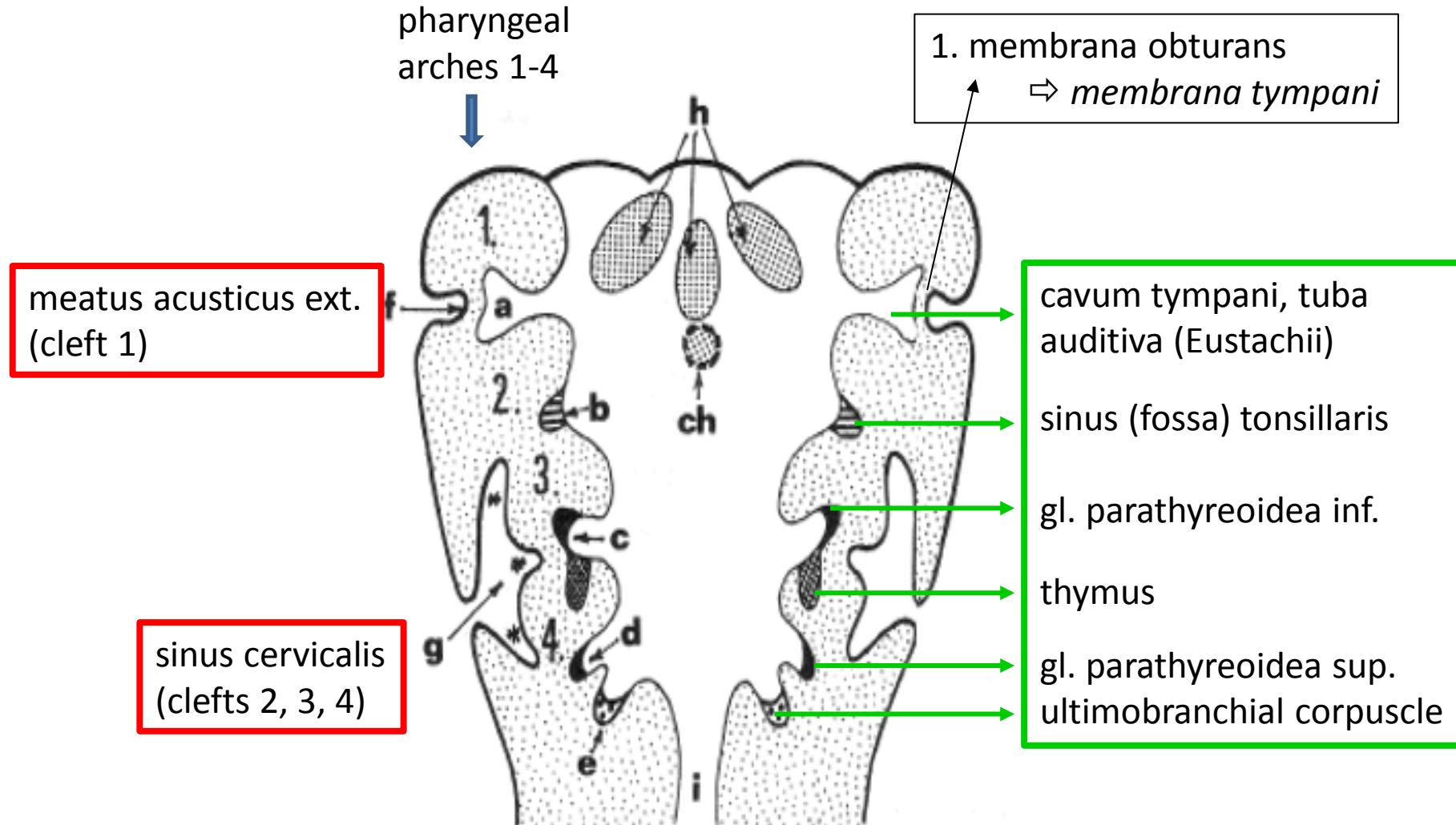



Descensus of thyroid gland and thymus with gl. parathyroideae inf. – embryo, week 6

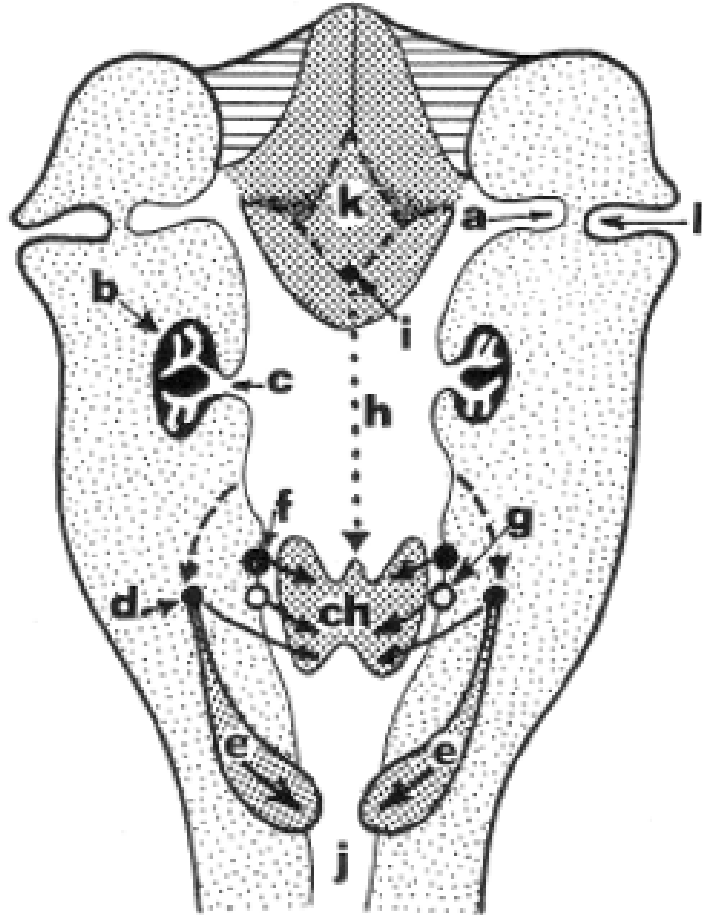

tongue (k),  
foramen caecum (i),  
ductus thyreoglossus (h),  
gl. thyroidea(ch),  
thymus (e),  
gl. parathyroideae inf. (d),  
gl. parathyroideae sup.(f),  
ultimobranchial corpuscle (g)



# Embryology

Development of the tooth



**Development of the oral cavity – embryo, week 6**

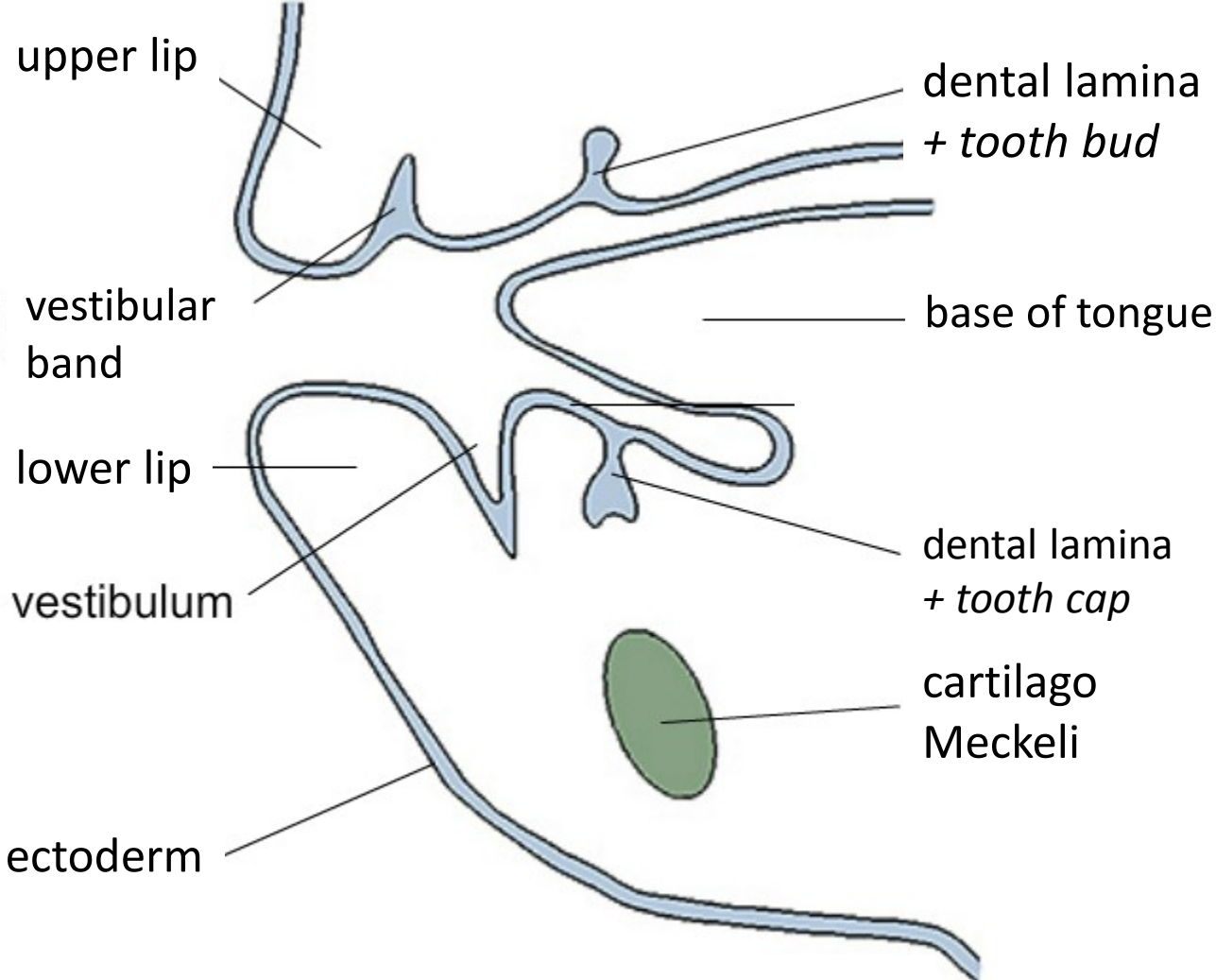

labium    vestibulum    dentogingival lamina

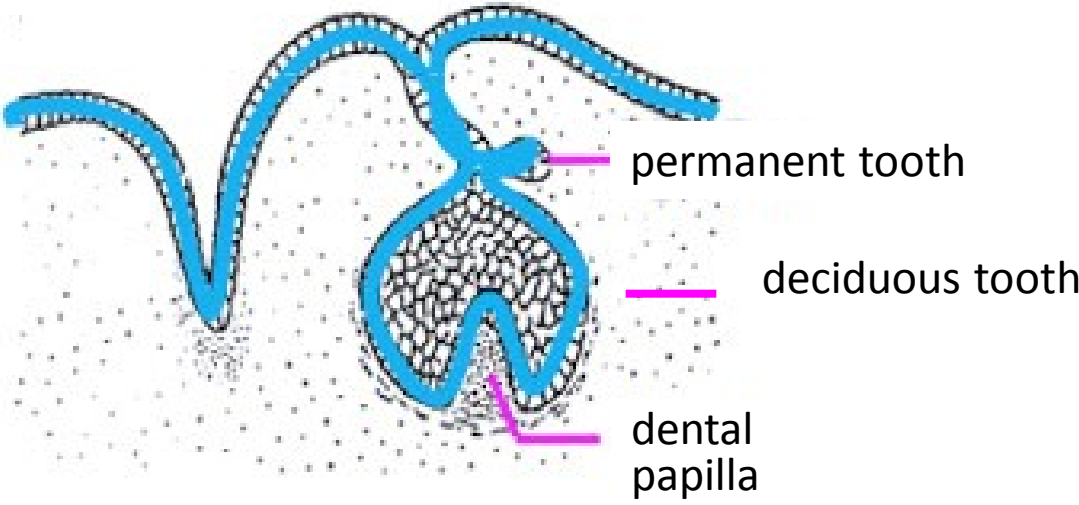
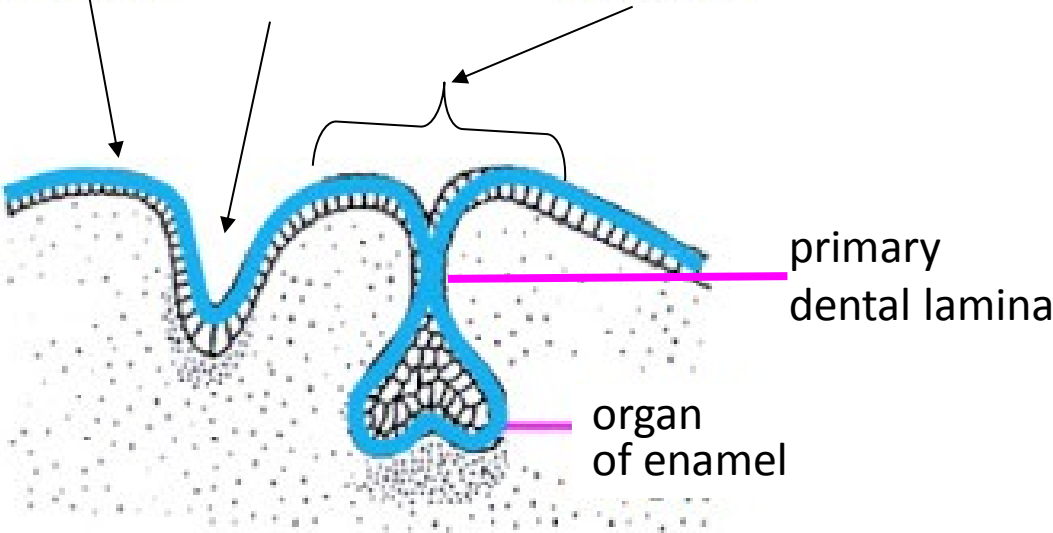



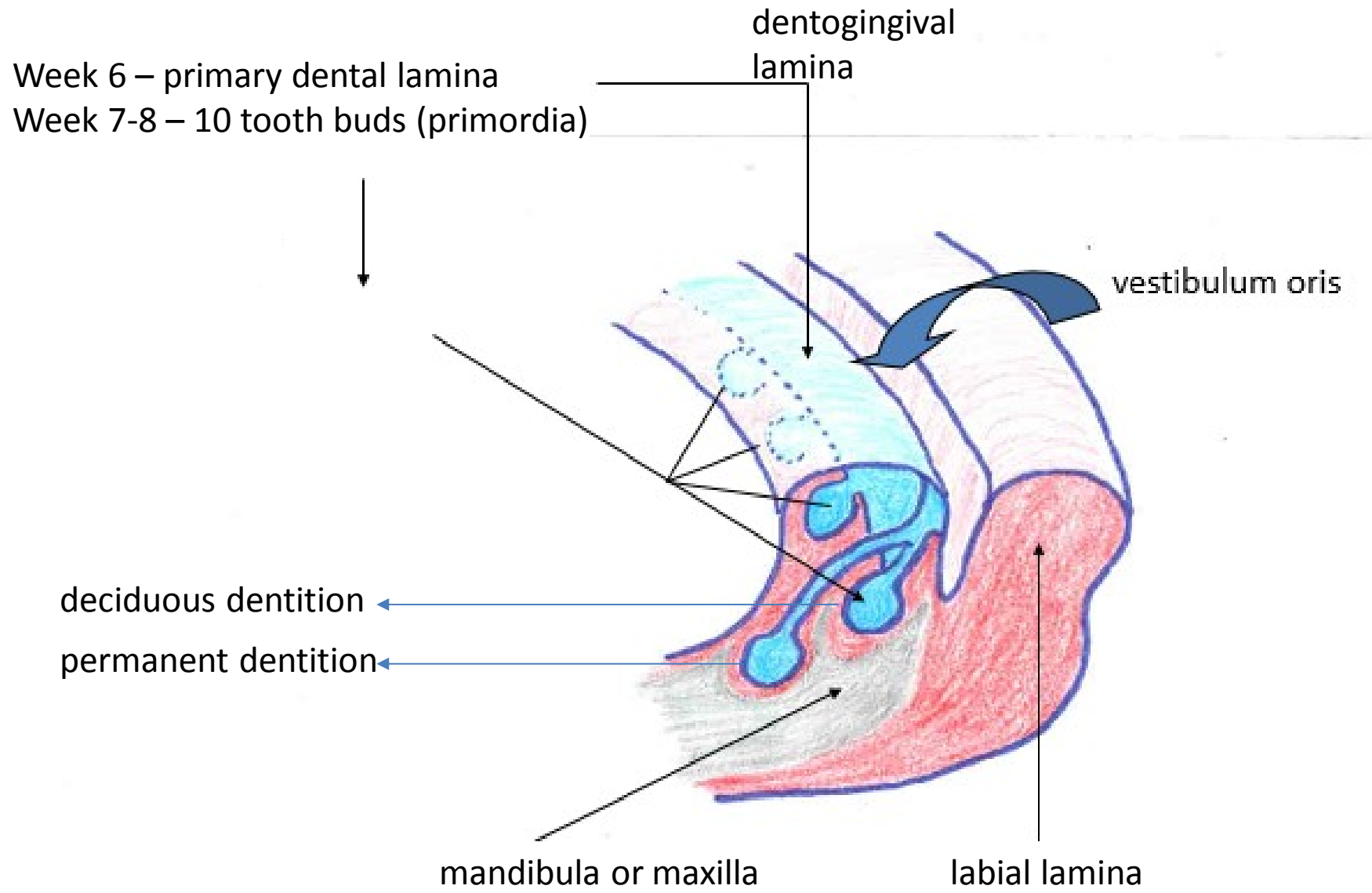

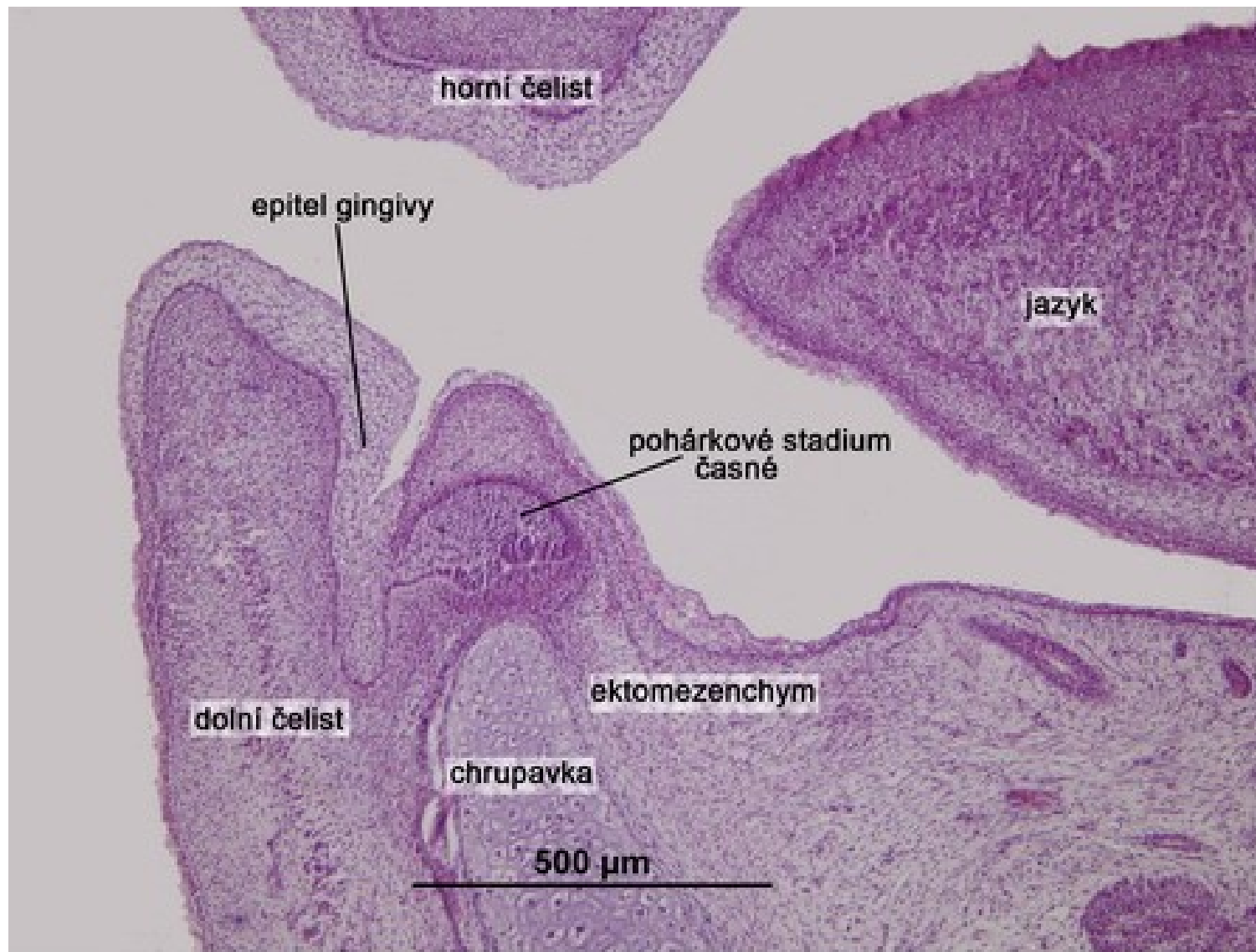

VÝVOJ ZUBU, barveno HE



# Developmental stages of tooth

## primary dental lamina

1. stage of dental bud (primordium)
2. stage of dental cap
3. stage of dental bell
4. stage of apposition
5. stage of eruption

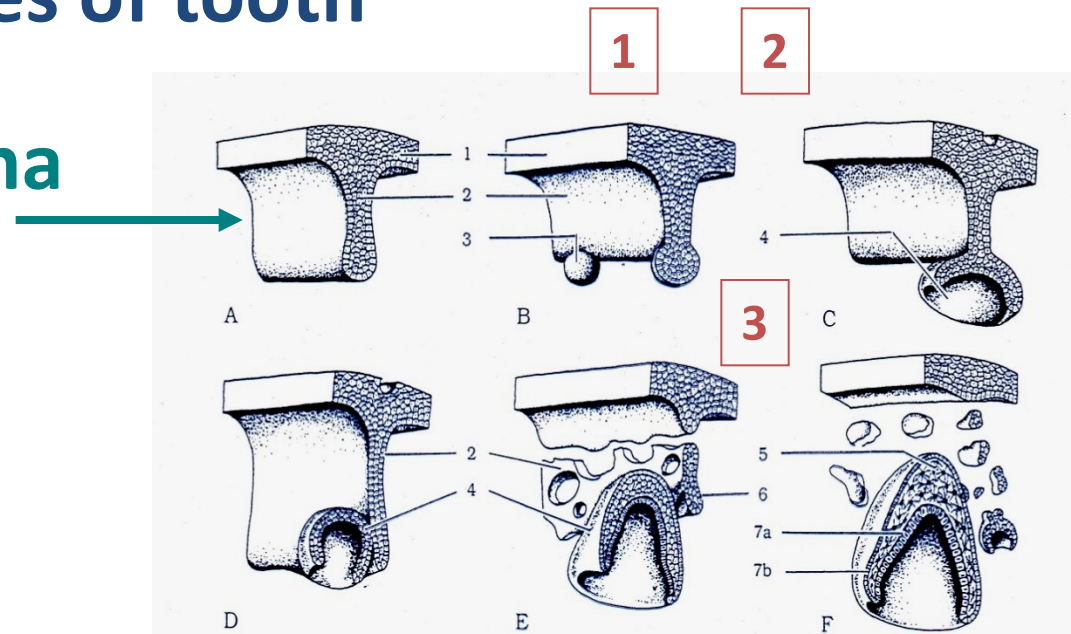

Obr. 13.12 Vývoj sklovinových orgánov zo zubnej lišty  
 Schematicky sú znázornené iba deriváty ektodermu: A - 6. týždeň, B - 7. týždeň, C - 8. týždeň, D - 10. týždeň, E - 14. týždeň, F - 18. týždeň vývoja: 1 - ektodermálny epitel ústnej dutiny, 2 - zubná lišta, 3 - epitelový uzlík, 4 - sklovinový orgán, 5 - sklovinová pulpa, 6 - základ trvalého zuba, 7a - vnútorné ameloblasty, 7b - vonkajšie ameloblasty

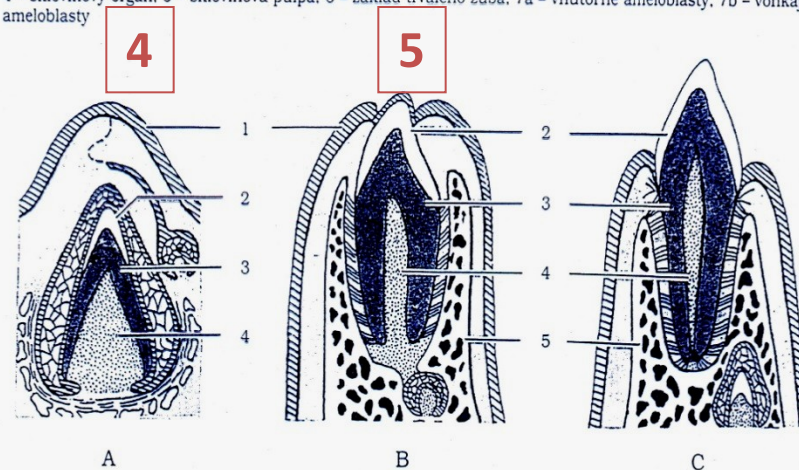

Obr. 13.13 Schematické znázornenie vývoja zuba (podľa Moorea, 1980)  
 A - 28. týždeň vývoja, B - asi 6. mesiac po narodení, C - prerezanie zuba po 6. mesiaci veku dieťaťa: 1 - epitel ústnej dutiny, 2 - email (biela), 3 - dentín (tmavosivá), 4 - zubná papila (pulpa), 5 - kosť zubnej alveoly (bielo-čierna)