



Nobel Prize (1895): in Physiology or Medicine

Schémata zpracovalo

Servisní středisko pro e-learning na MU

CZ.1.07/2.2.00/28.0041

Centrum interaktivních a multimediálních studijních opor pro inovaci výuky a efektivní učení



INVESTICE DO ROZVOJE VZDĚLÁVÁNÍ

*Life is a dynamic system with focused behavior, with autoreproduction, characterized by **flow of substrates, energies and information.***

PHYSIOLOGY

- Science about living systems (Fernel, 1642)
- Experimental science (W. Harvey, 1643; C. Bernard, J.E. Purkyně)



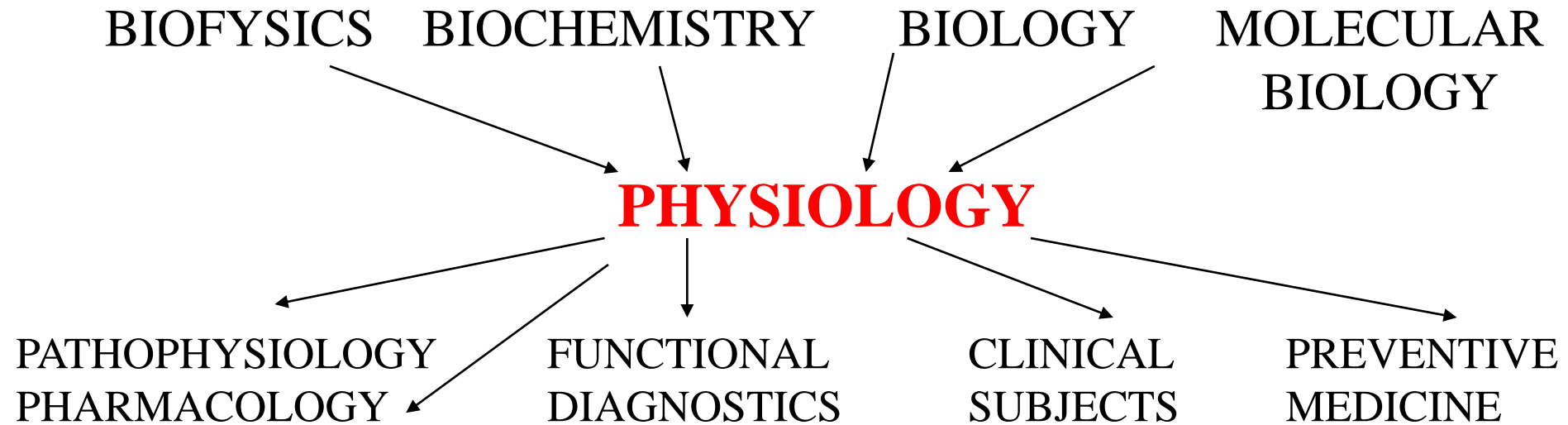

Aims of the course:

1. Learn the terms
2. Learn basic facts
3. Understand functional relations
4. Understand clinical consequences

Teaching forms – lecture, seminar, demonstration, practical (lab)

PHYSIOLOGY – science about functions (dynamics)

- General
- Special
- Comparative
- Evolutional
- Applied

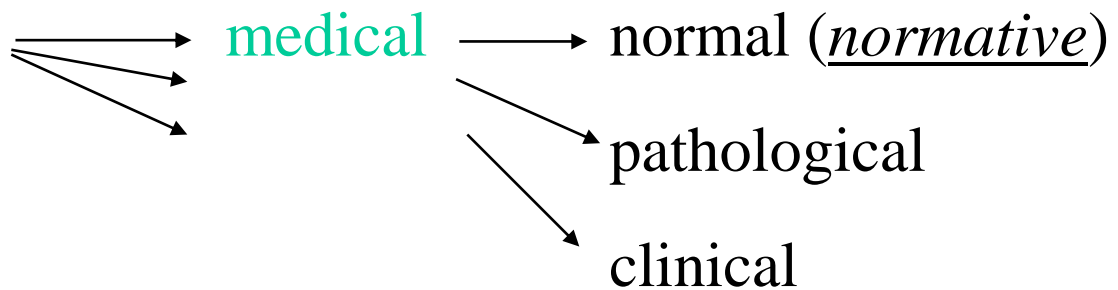

- **FUNCTIONAL ORGANISATION OF THE BODY**
- **EXCHANGE AND TRANSPORT OF COMPOUNDS**
- **INTERCELLULAR CONTACTS AND SIGNALLING**

Functions are studied at 5 levels: molecular, cellular, tissue, organ, organism

STRUCTURE AND FUNCTIONS OF CELL, ORGANELLES

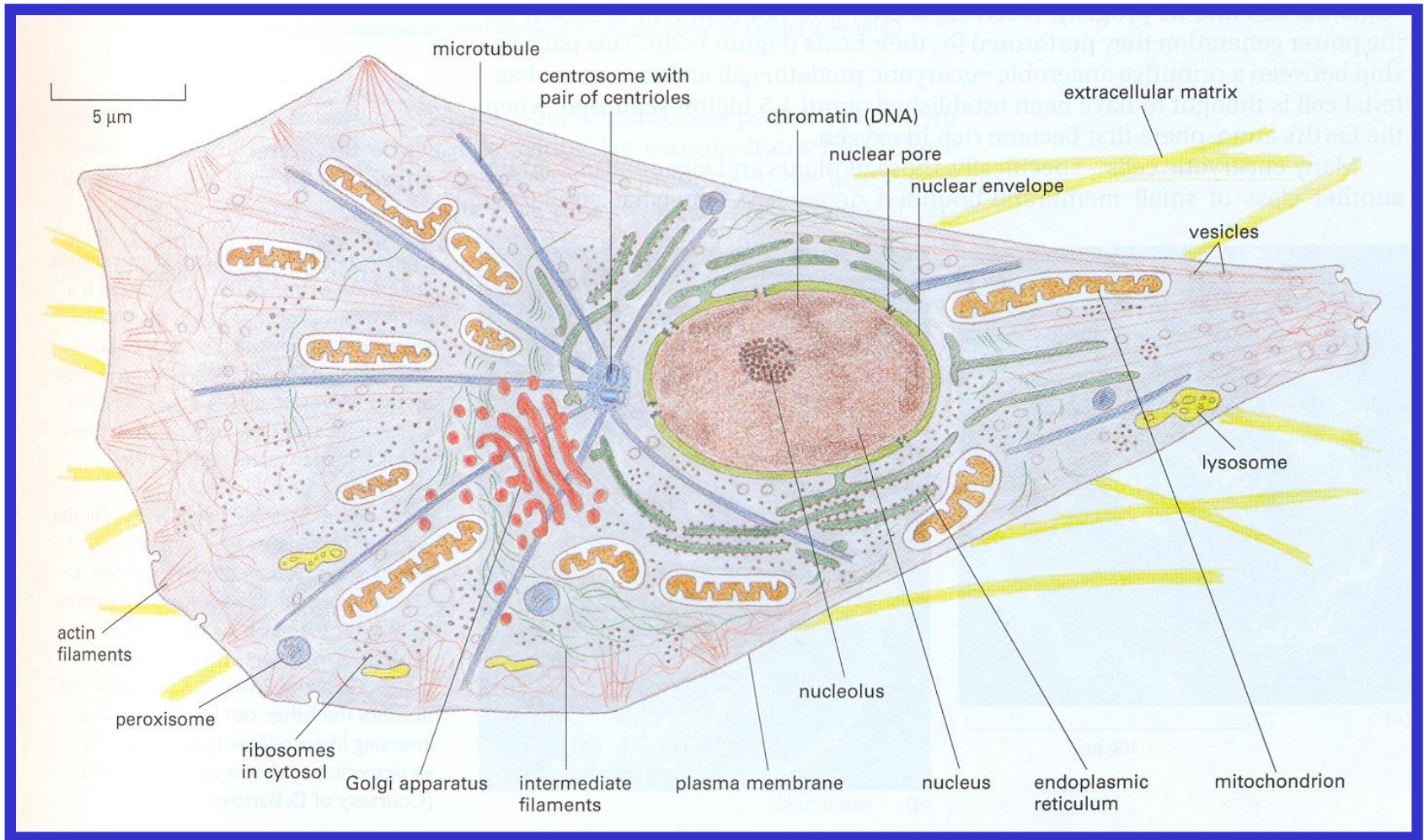

PLASMATIC MEMBRANE

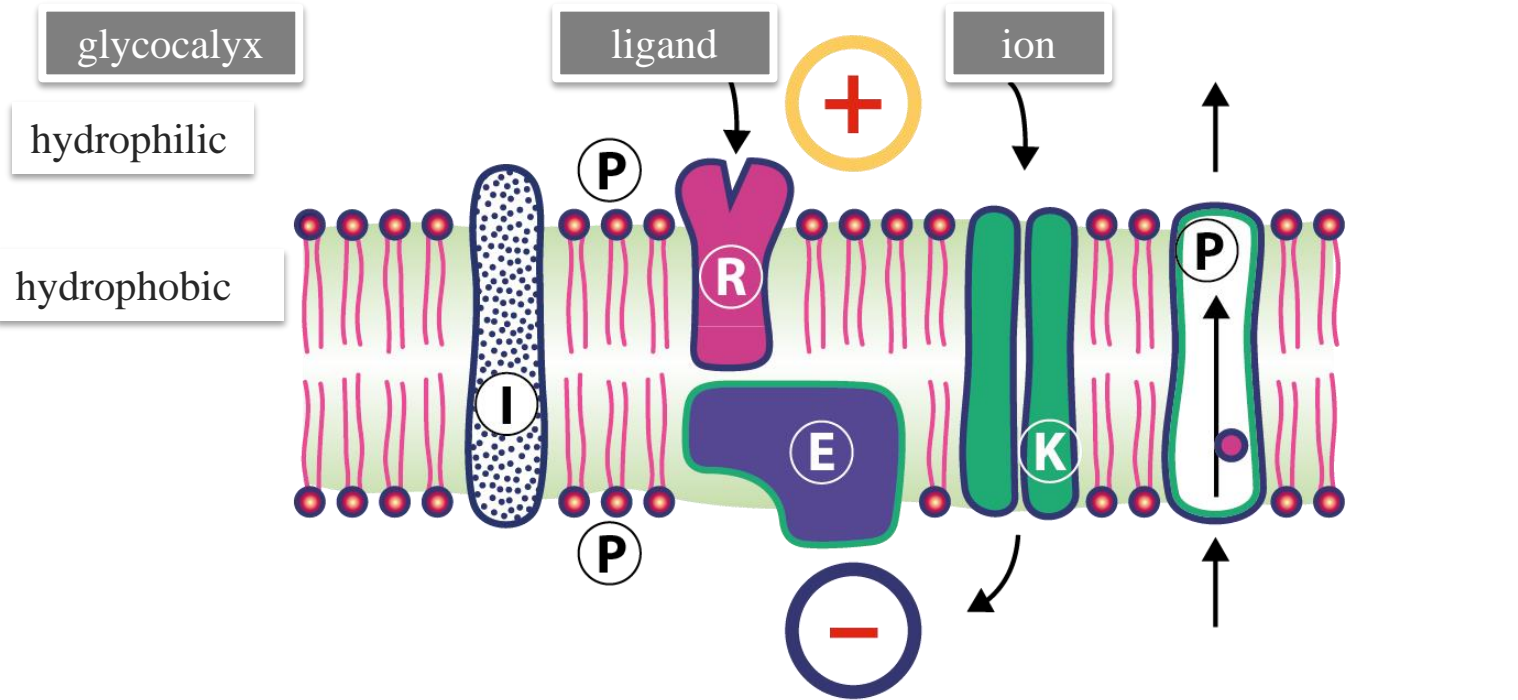

I – integral protein
R – receptor
E – enzyme
K – channel
P – pump (ATP-ase)

Membrane molecules

Protein molecules

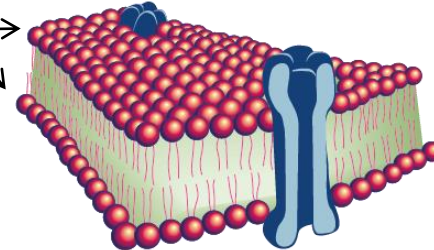

COMPARTMENTALISATION OF BODY FLUIDS

GIT, lungs, kidney, skin

Plasma

5% - 3,5 litres

Evans blue, ¹³¹I

Interstitial
fluid

15% - 10,5 litres

Inulin, manitol, sacharose

Extracellular
fluid (incl. plasma)

Intracellular
fluid

40% - 28 litres

Antipyrin, D₂O

Total volume of
fluids

BODY FLUIDS

BODY COMPOSITION

Water	60% (80-50%) of body mass
Proteins	18%
Lipids	15%
Minerals	7%

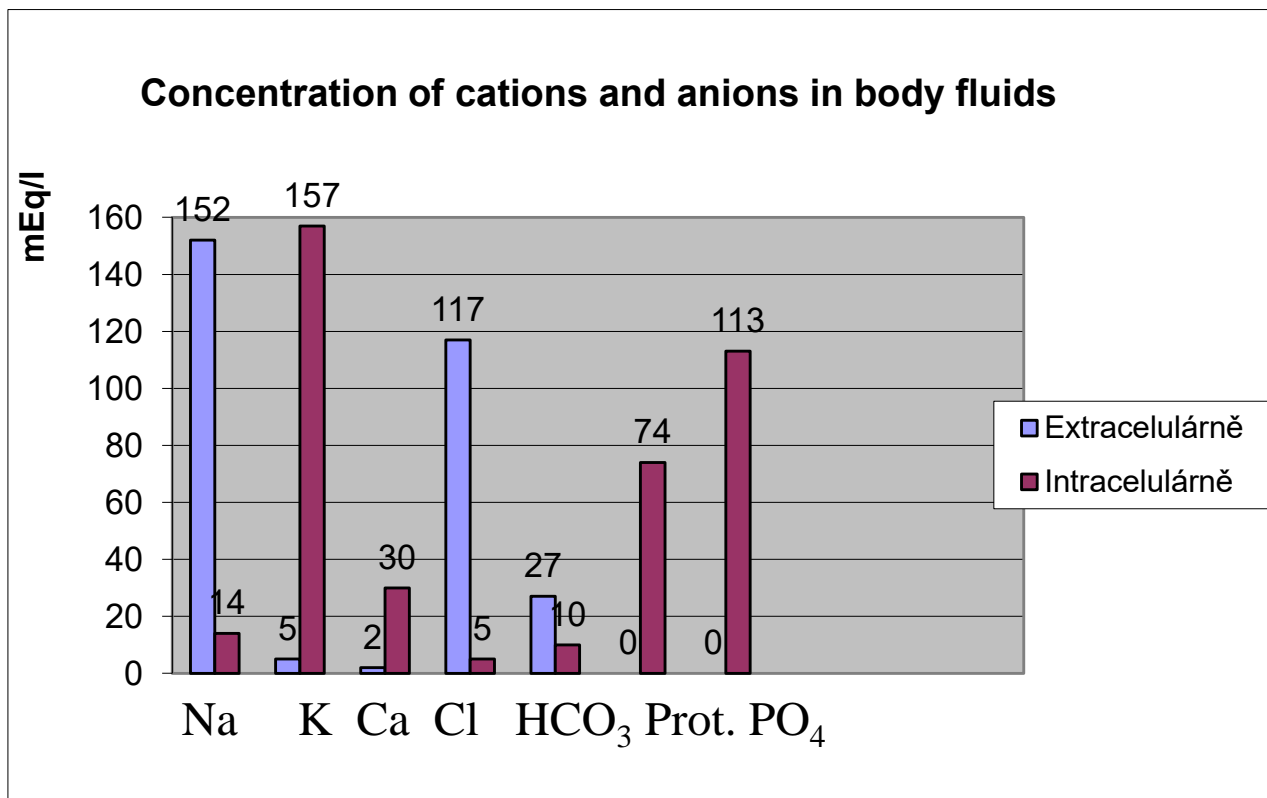

PASSIVE TRANSPORT MECHANISMS

Differences in body fluids composition result from features of barriers and forces responsible for transport.

DIFUSION

Transport of gases, substrates, metabolites (up to m.w. 60 thous. in direction of concentration gradient of diluted compound.

It depends on solubility in water and lipids.

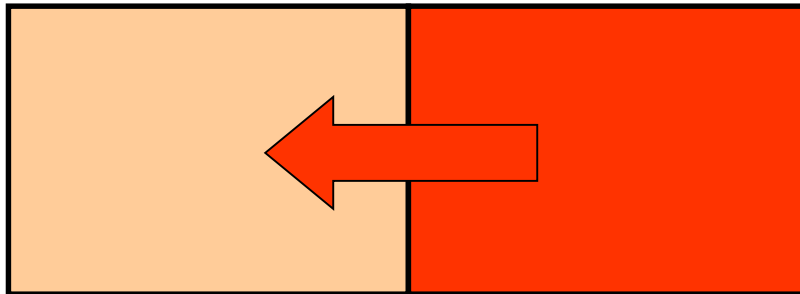

OSMOSIS

Transport of water across semipermeable membrane in direction to higher concentration of diluted compound (e.g. in direction to lower concentration of water). It depends on number of particles.

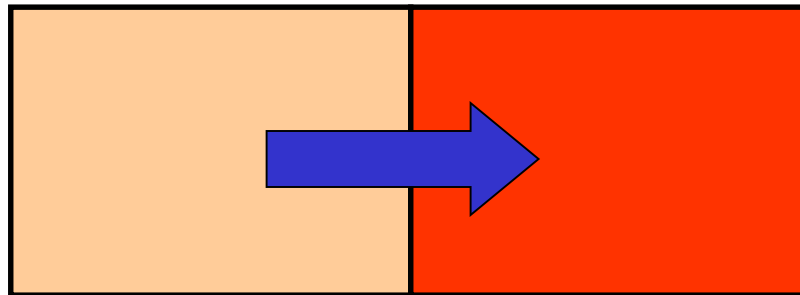

Osmolarity x osmolality
Iso-, hyper-, hypotonicity
Oncotic pressure

FILTRATION

Movement of solvent as a result of osmotic and hydrostatic pressure.

Production and resorption of interstitial fluid (**Starling forces**).

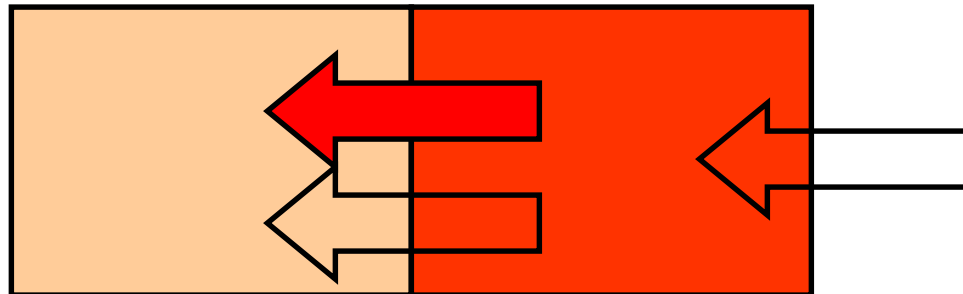

REGULATED TRANSPORTS

FACILITATED DIFUSION

selective carrier
limited capacity

amino acids
phosphate

COTRANSPORT

transported compound uses concentration
gradient of Na^+ as the driving force

SYMPORT in the same direction

glucose, AMK

ANTIPOINT in opposite direction

Ca^{2+} , H^+

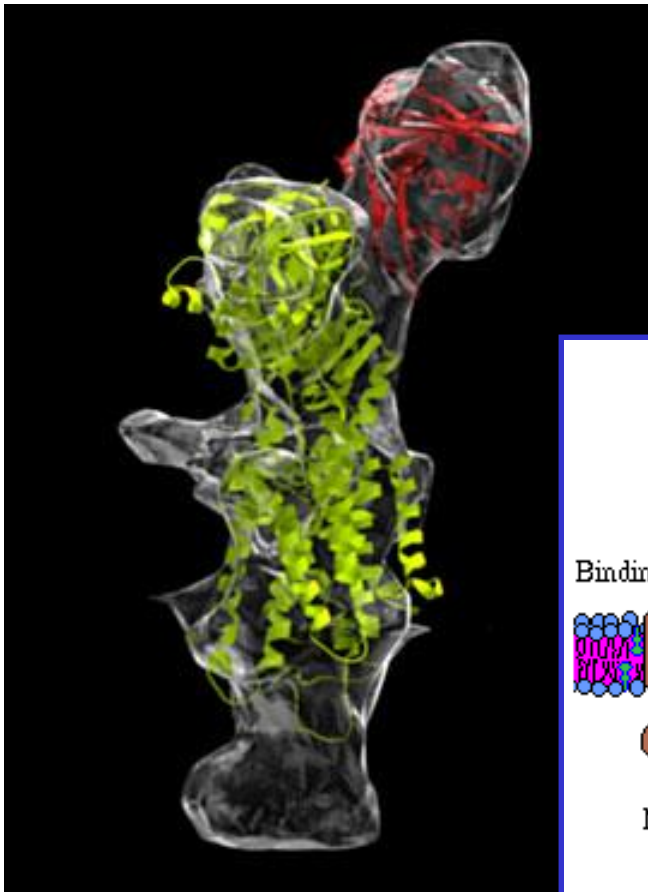

ACTIVE TRANSPORTS

Na^+/K^+ ATP-ase (exchanger)
AGAINST concentration gradient

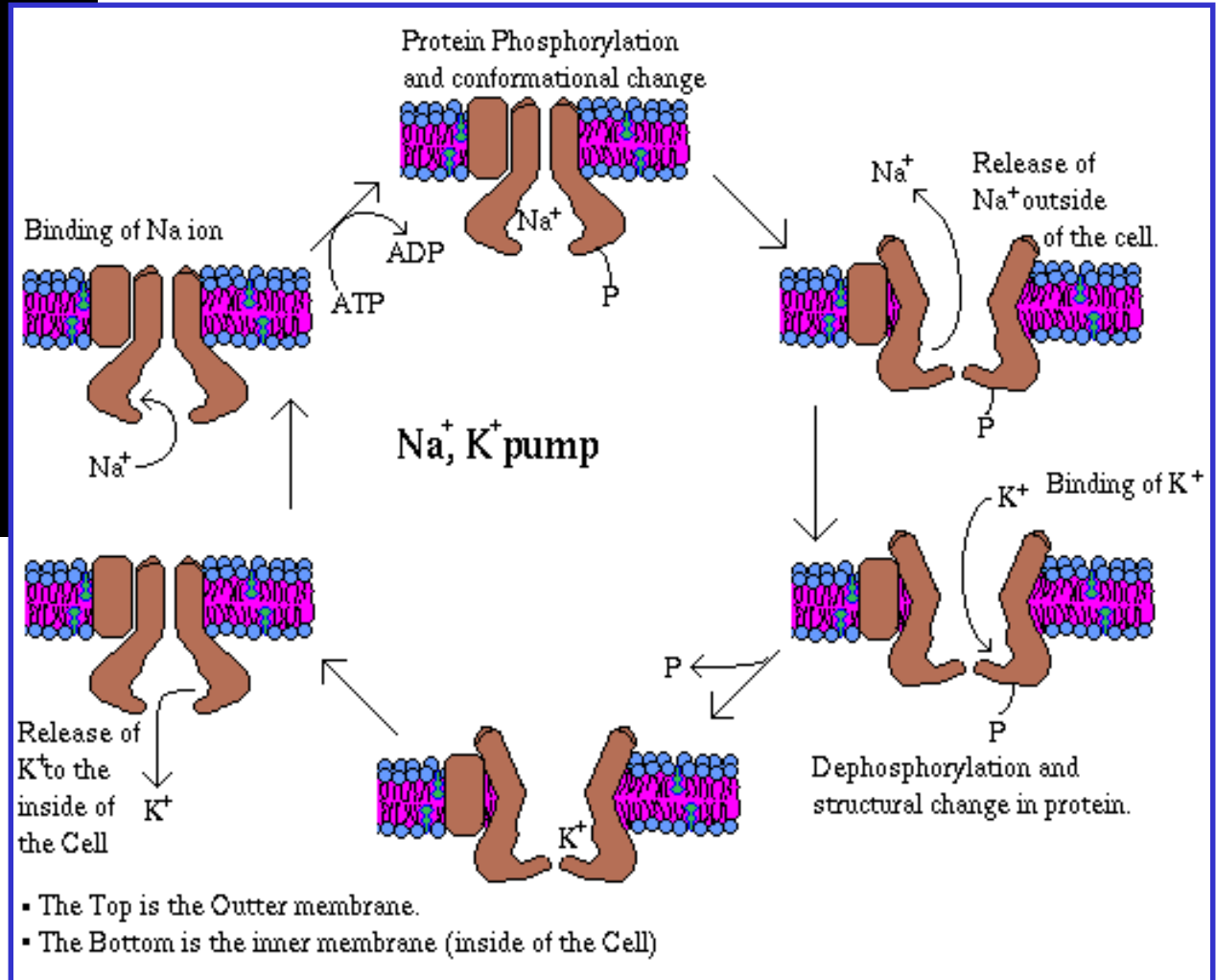

Similar transports:

- $\text{Ca}^{2+}/\text{H}^+$
- Na^+/K^+
- K^+/H^+
- Na^+/H^+

PLASMATIC MEMBRANE

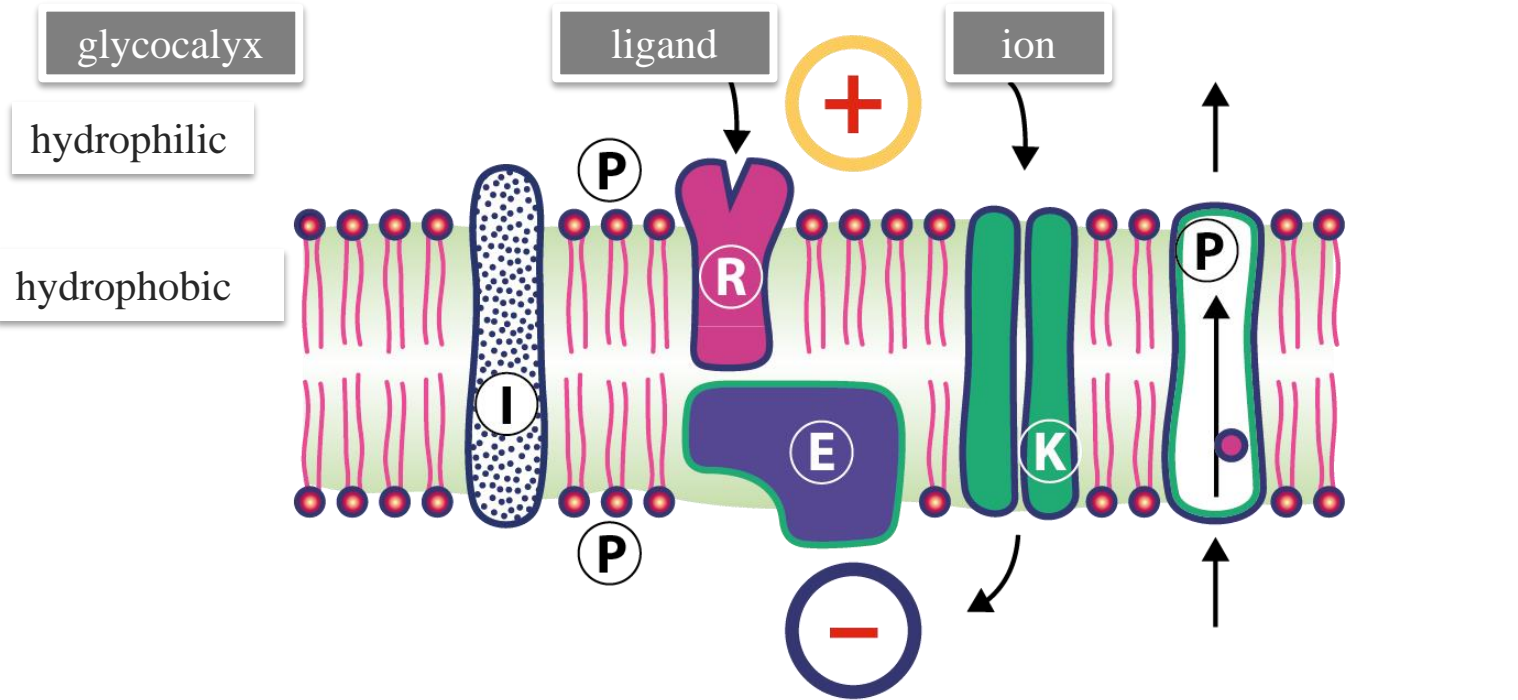

I – integral protein
R – receptor
E – enzyme
K – channel
P – pump (ATP-ase)

Membrane molecules

Protein molecules

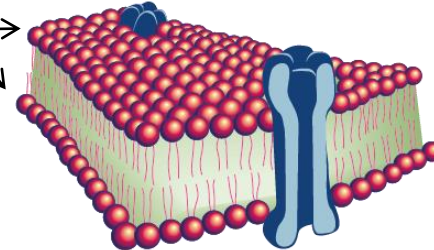

IONIC CHANNEL

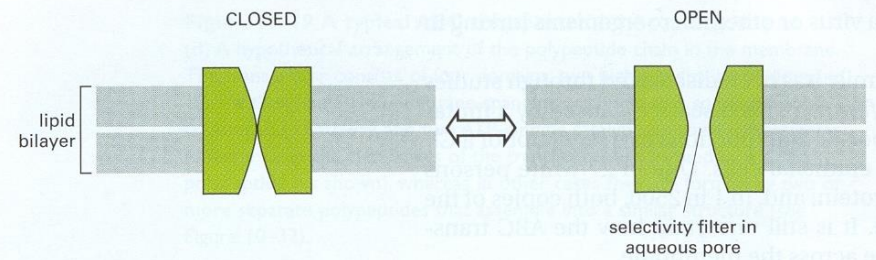
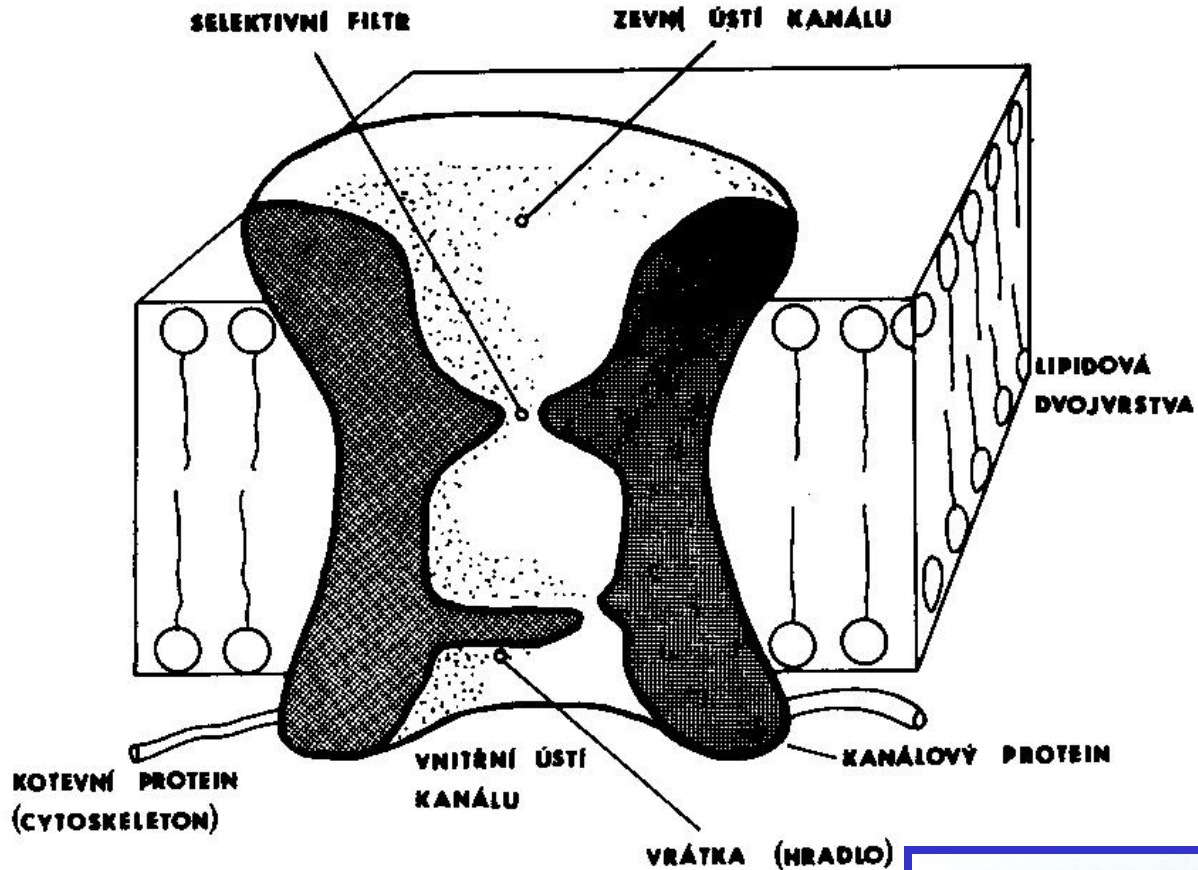

Membránová elektrofyziologie myokardu, P. Pučelík, Avicenum, 1990

Molecular biology of the cell. B. Alberts et al., Garland Science 2002

GATING

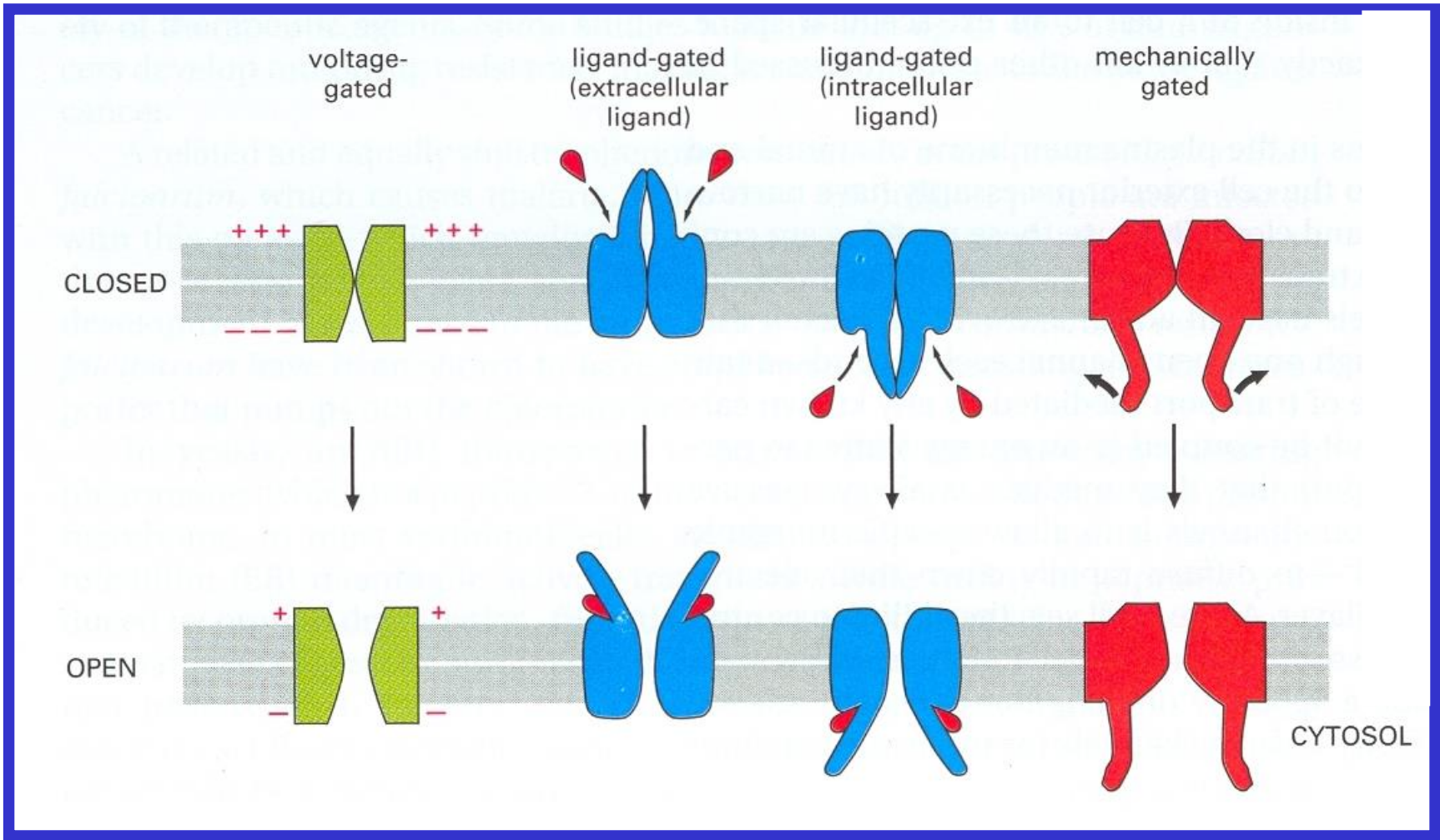

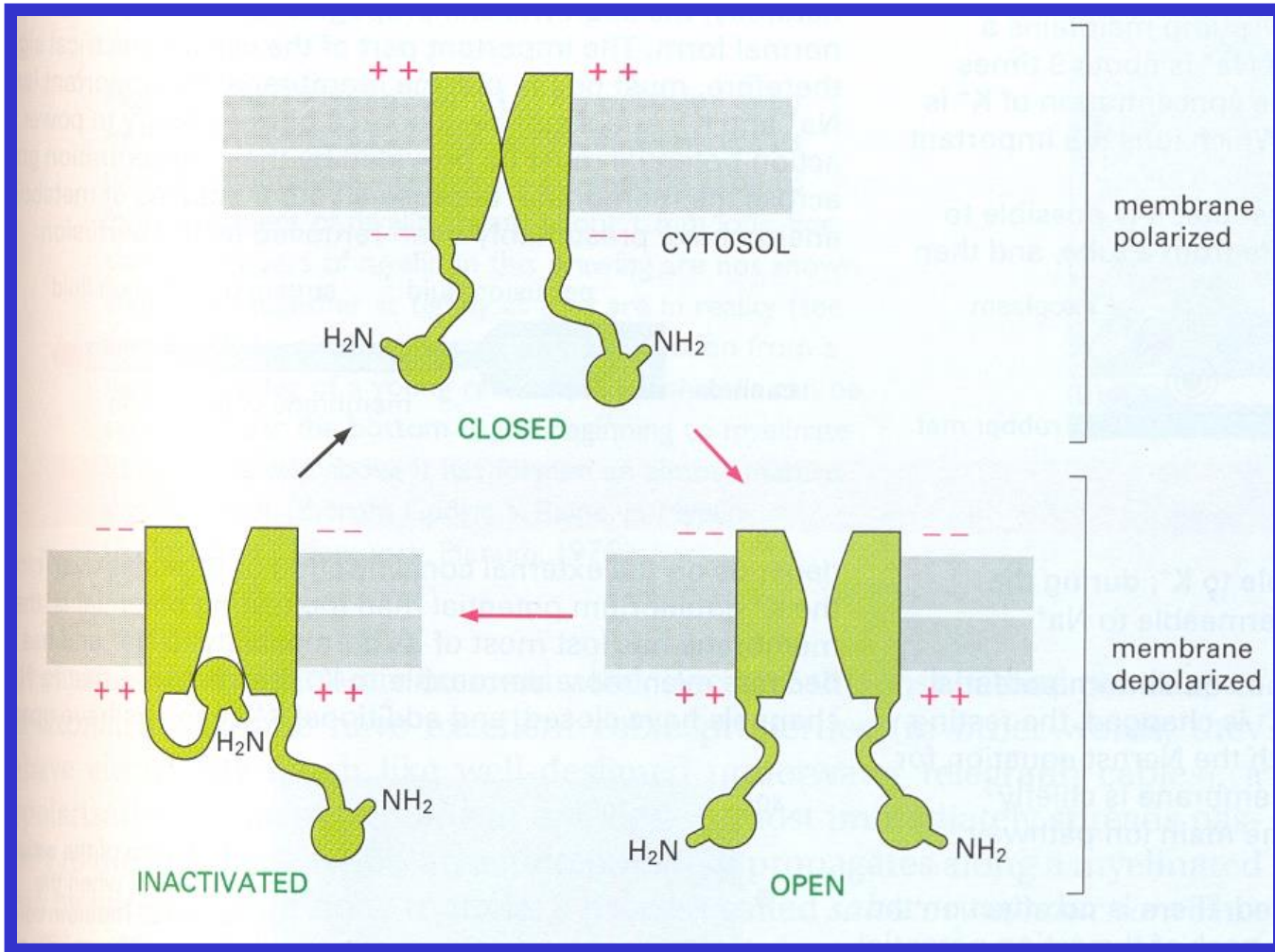

Repolarisation reserve

K^+

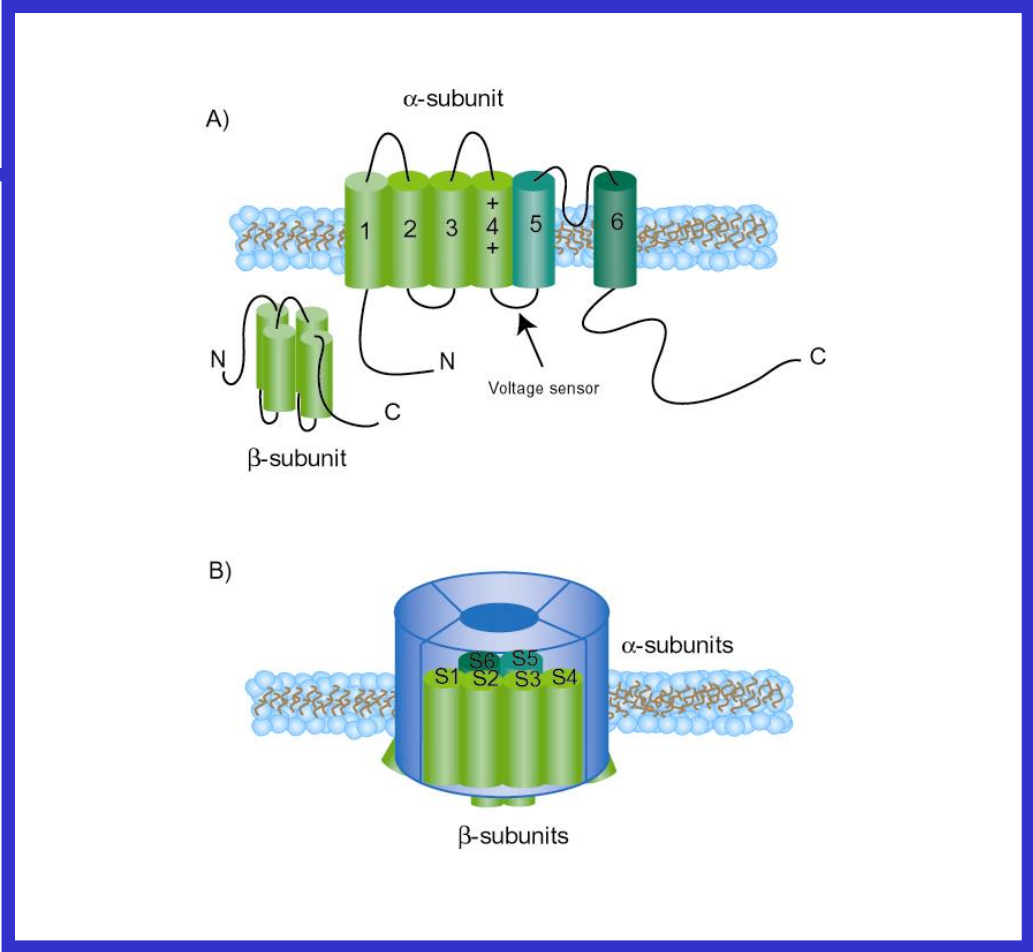
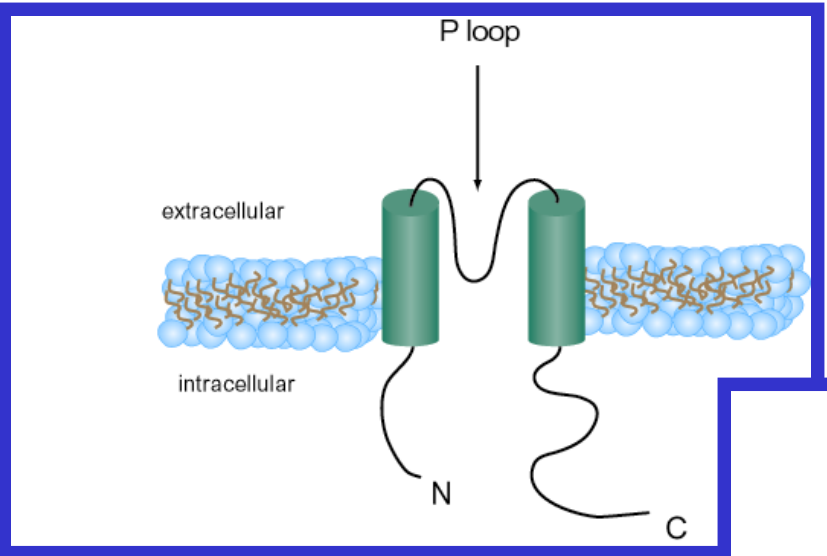

Cl^-

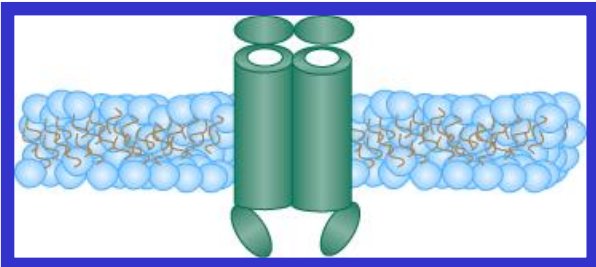

Na⁺

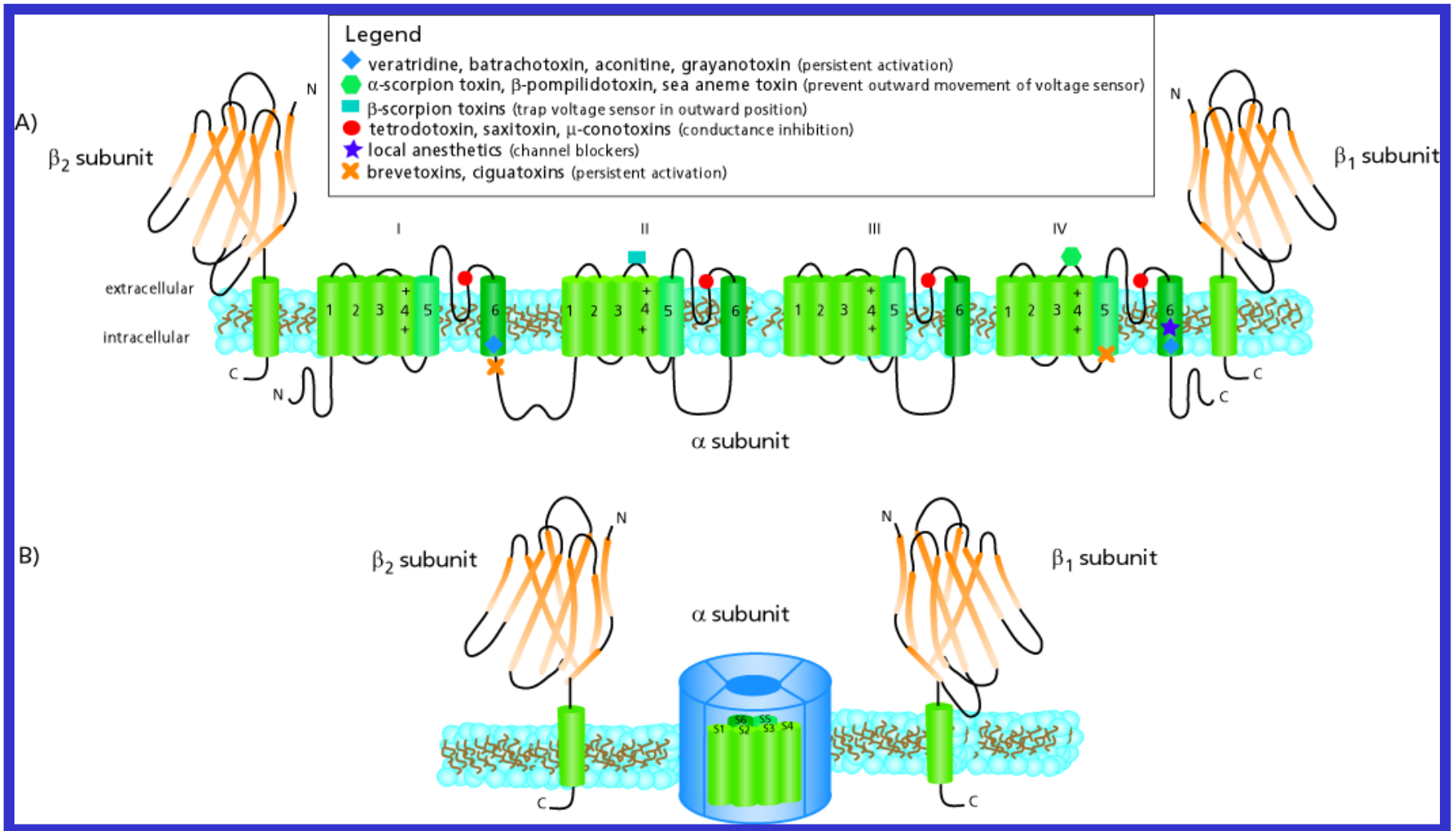

Ca⁺

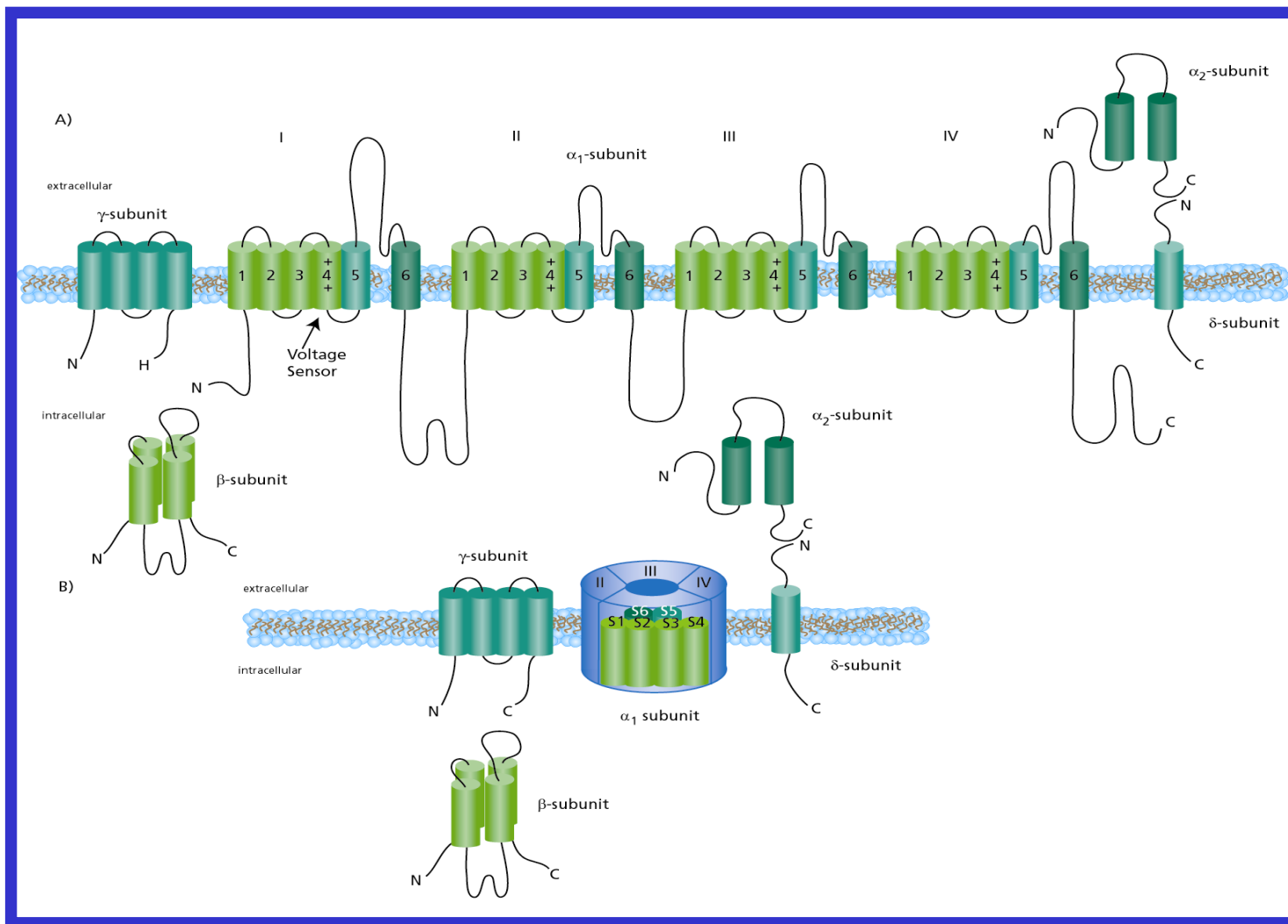

L, T, N type

SIGMA RBI, www.sigma-aldrich.com

COMMUNICATION BETWEEN THE CELLS

MECHANICAL CONNECTION

- desmosomes (macula adherens; cell adhesion and mechanical stability of tissues) – epidermis, liver, myocardium

ELECTRICAL CONNECTION

- gap junction (nexus) (in intercalar disc; consists of connexons)

HUMORAL CONNECTIONS (REGULATION)

- autocrine
- paracrine
- endocrine
- juxtacrine
- neurocrine

Receptor, ligand, second messenger.

NERVOUS CONNECTIONS (REGULATION)

INTEGRATION OF HUMOURAL AND NERVOUS SYSTEMS:

- synapse
- hypothalamus - pituitary gland
- adrenal medulla

HOMEOSTASIS - MAINTENANCE OF CONSTANT CONDITIONS IN THE INTERNAL ENVIRONMENT

IN A BROAD SENSE – in body fluids

IN A STRICT SENSE – in particular compartments

(blood.....organelles) or maintenance of certain parameter
(blood pressure, muscular tension, etc.)

REGULATED PARAMETERS:

body temperature, volume of body fluids, osmotic pressure, pH, pO_2 , pCO_2 , concentration of ions, glycaemia, etc.

(isohydria, isovolemia, isoionia, isoosmia, ...)

REGULATION

Control of living systems.

Living systems – open systems; their existence depends on flow of energy and substances between organism and environment in both directions.

Appears at all levels of system (cell – whole organism).

ASSOCIATION OF DIFFERENT LEVELS OF REGULATION

Systemic regulation – nervous and humoral

Local regulation (metabolic) – chemical – pO_2 , pCO_2 ,
pH,
prostaglandins

Autoregulation

myogenic – constant blood flow during changing
perfusion pressure

in the heart – homeometric and heterometric

DISTURBANCES IN BODY FLUIDS

- **Communication with surroundings**

lungs, GIT, kidneys, skin

- **Internal sources of instability**

metabolism

Extracellular fluids represent transport systems

BASIC TYPES OF FEEDBACK

SERIAL

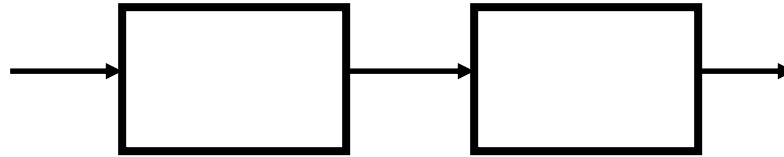

PARALLEL

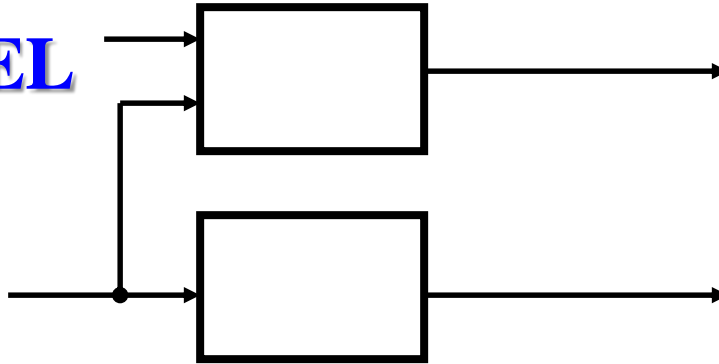

NEGATIVE DIRECT

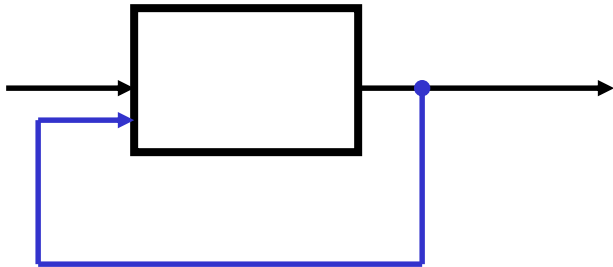

NEGATIVE INDIRECT

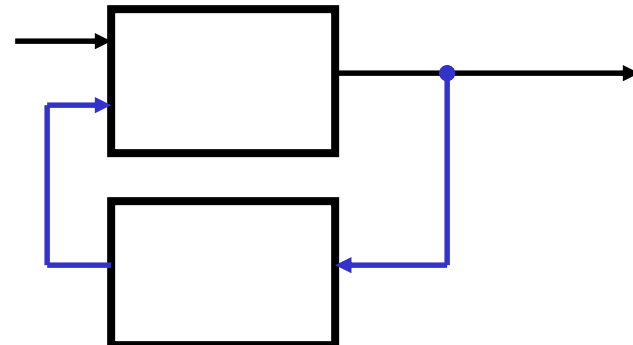

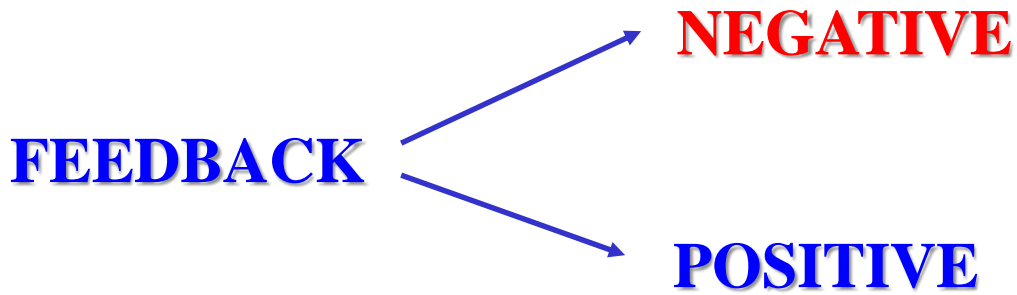

Deviation from desired value **oscillates** or continuously increases.

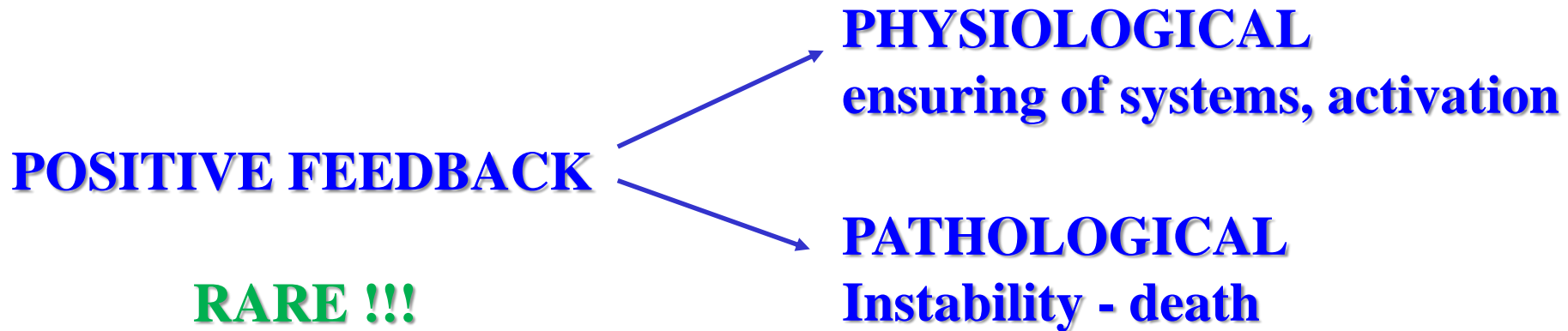

BASIC FEATURES OF REGULATORY SYSTEMS

- System is stable at least within the range of its functional range
- Not a single real regulatory system regulates **ideally**
- **Regulatory time** = time till the moment, when regulated parameter returns to its original (resting) values

VICIOUS CIRCLE AND DEATH

BLEEDING → ↓ FILLING OF THE HEART

→ ↓ CARDIAC OUTPUT → ↓ BP

→ ↓ CORONARY FLOW →

→ ↓ CONTRACTILITY →

→ ↓ CARDIAC OUTPUT → ↓ BP

→ ↓ CORONARY FLOW →

→ ↓ CONTRACTILITY →

