

9

Vision I

Light

Electromagnetic radiation with wavelengths in range of 400 – 700 nm

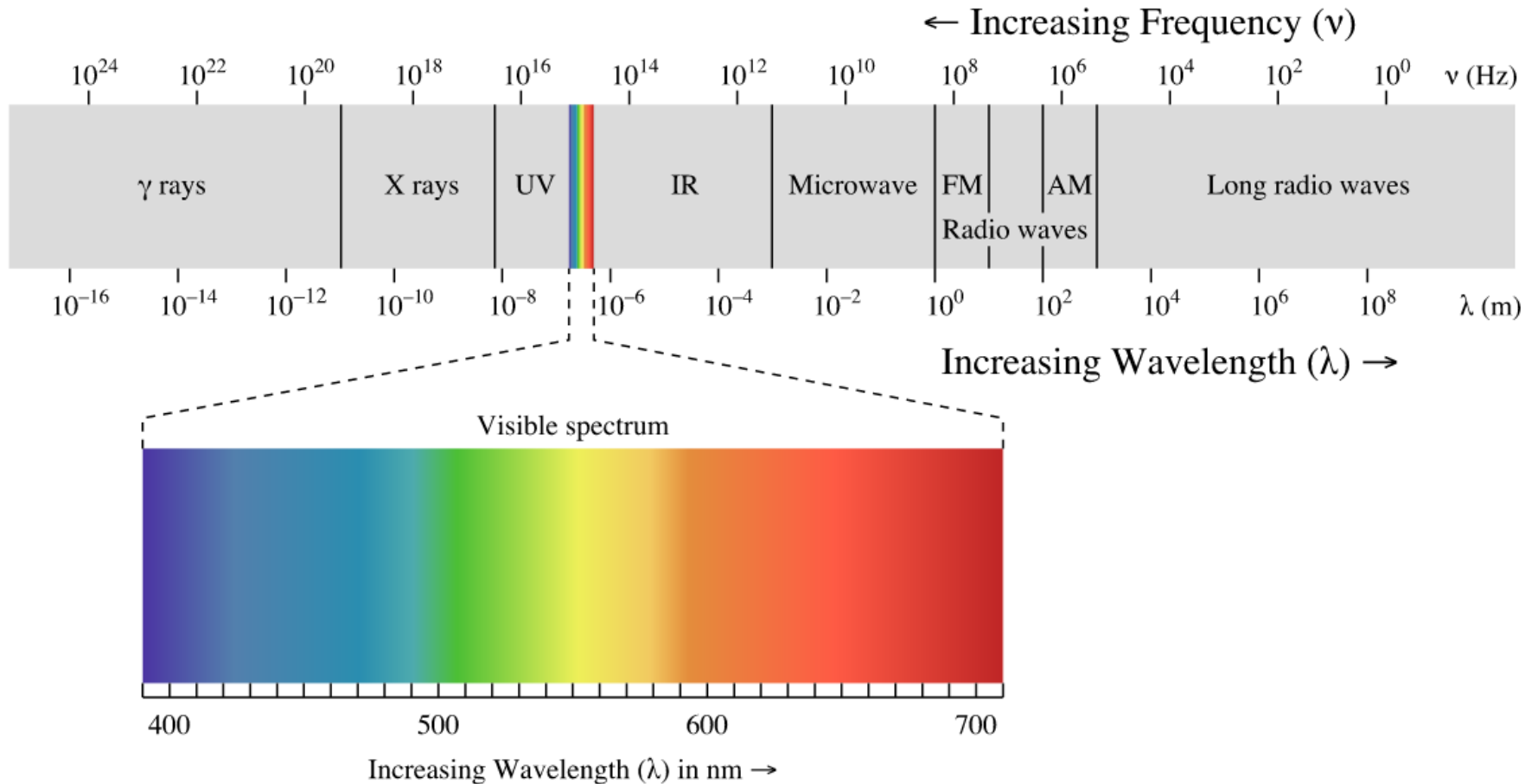

Color mixing

RGB

Additive
Color



mixing light

RED GREEN BLUE

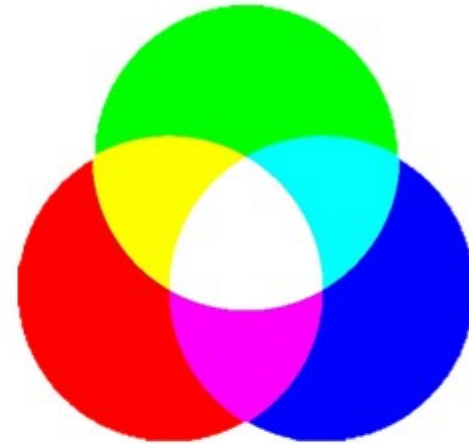

CMYK

Subtractive
Color



mixing ink

CYAN MAGENTA YELLOW

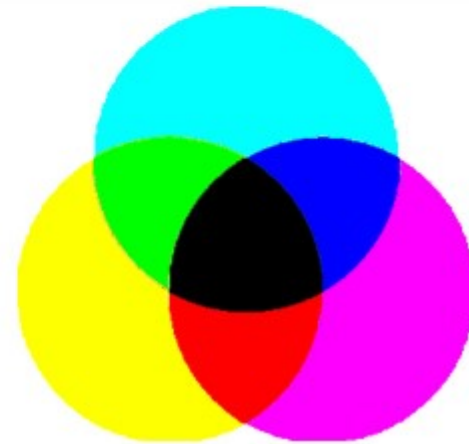

Photoreceptive organ

✓ Light detection

✓ Image formation

Light detection

- Circadian activity
 - Both prokaryotes and eukaryotes
 - Day/night cycle is the most influential and the most stable biorhythm

Light detection

- Circadian activity
 - Both prokaryotes and eukaryotes
 - Day/night cycle is the most influential and the most stable biorhythm



Light detection

- Circadian activity
 - Both prokaryotes and eukaryotes
 - Day/night cycle is the most influential and the most stable biorhythm
 - Oscillation with a period of aprox. 24 hours even without signals from environment
 - Environmental signals synchronize circadian activity
- Seasonal activity

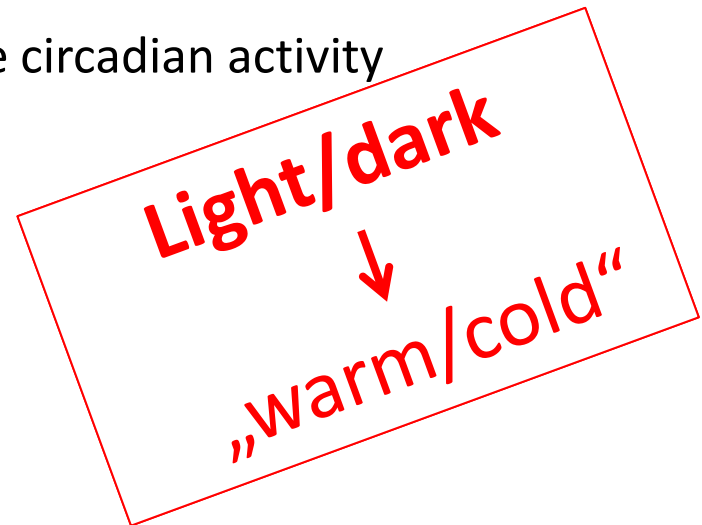

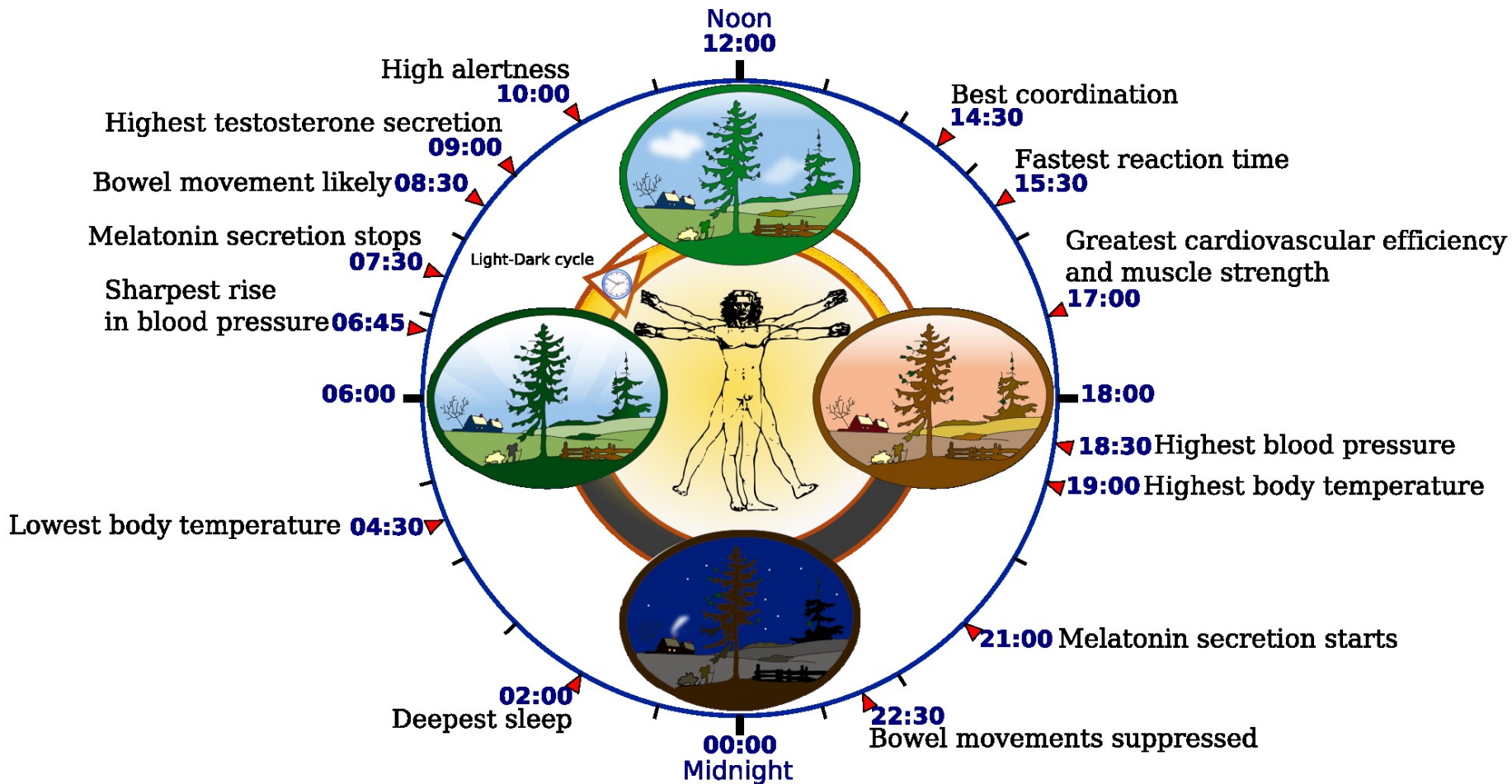

https://upload.wikimedia.org/wikipedia/commons/thumb/3/30/Biological_clock_human.svg/2000px-Biological_clock_human.svg.png

Biological clock

- Cellular level
 - Group of proteins rhythmically expressed creating interconnected feedback loops (about 24hours)
 - Peripheral Clock protein expression

Biological clock

- Cellular level
 - Group of proteins rhythmically expressed creating interconnected feedback loops (about 24hours)
 - Peripheral Clock protein expression
- Tissue level
 - Peripheral oscillators
 - Adrenal gland, lung, liver, pancreas, skin
 - Influenced by neurohumoral factors and also by light

Biological clock

- Cellular level
 - Group of proteins rhythmically expressed creating interconnected feedback loops (about 24hours)
 - Peripheral Clock protein expression
- Tissue level
 - Peripheral oscillators
 - Adrenal gland, lung, liver, pancreas, skin
 - Influenced by neurohumoral factors and also by light
- Central pacemaker
 - Hypothalamus (nucleus suprachiasmaticus)
 - Central clock protein expression
 - Information about illumination from retina (specialized ganglion cells) – synchronization of central pacemaker
 - Pineal gland - melatonin
 - Autonomic nervous system – adrenal gland - cortisol

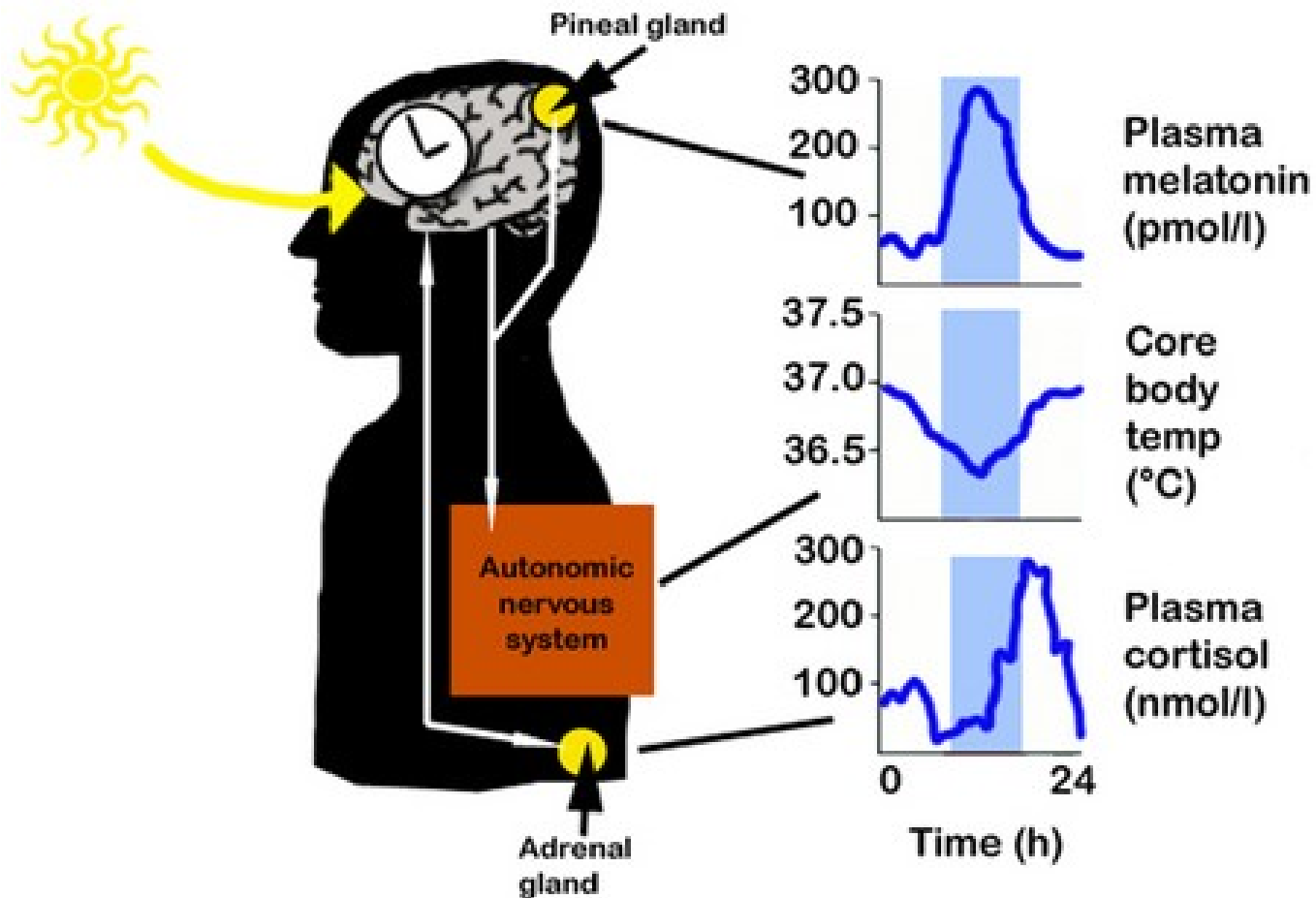

A.J. Hesse, G.E. Duffield

adapted from Hastings, M. BMJ 1998;317:1704-1707

Image formation

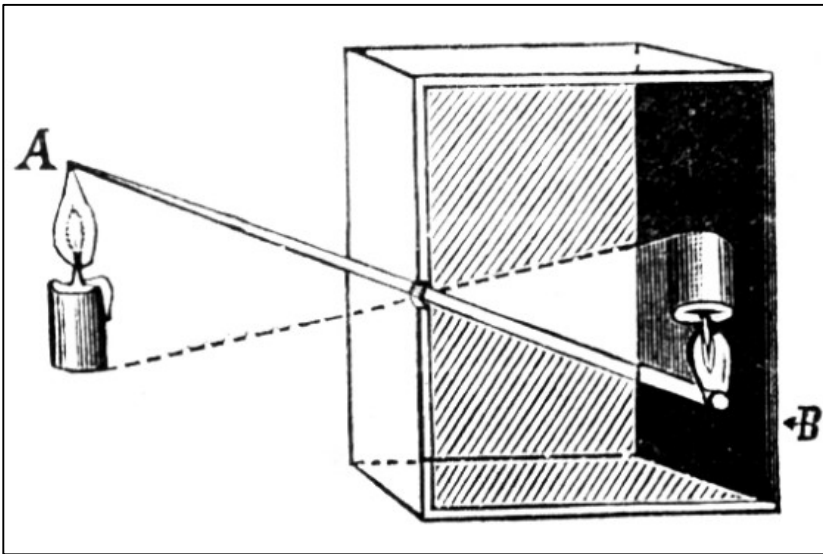

https://www.fotoskoda.cz/images/manufacturers/camera_obscura.png

Image formation

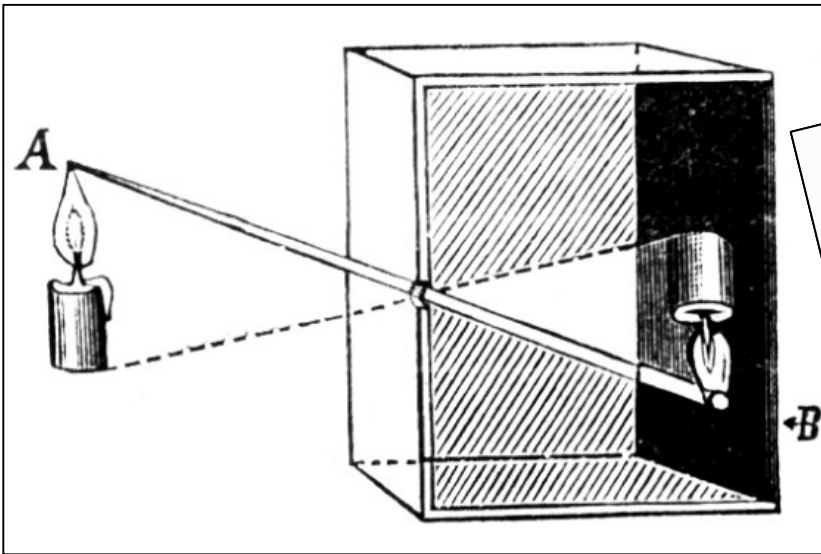

https://www.fotoskoda.cz/images/manufacturers/camera_obscura.png

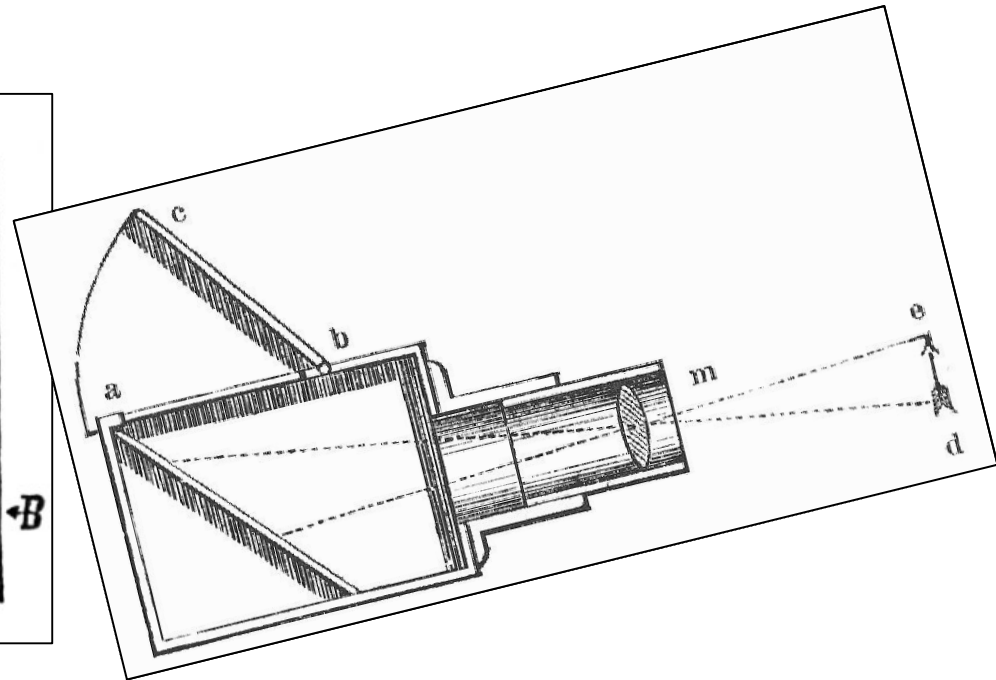

<http://de.academic.ru/pictures/meyers/large/030717c.jpg>

Image formation

- Shape
- Color
- Localization
- Movement
- Image interpretation

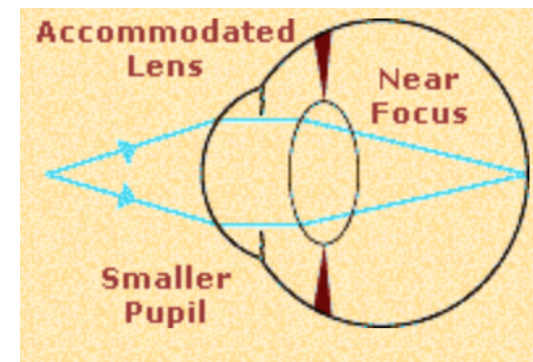
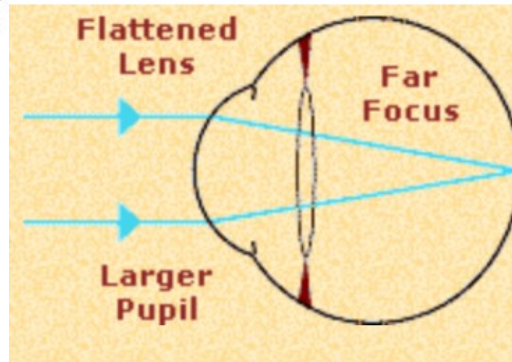
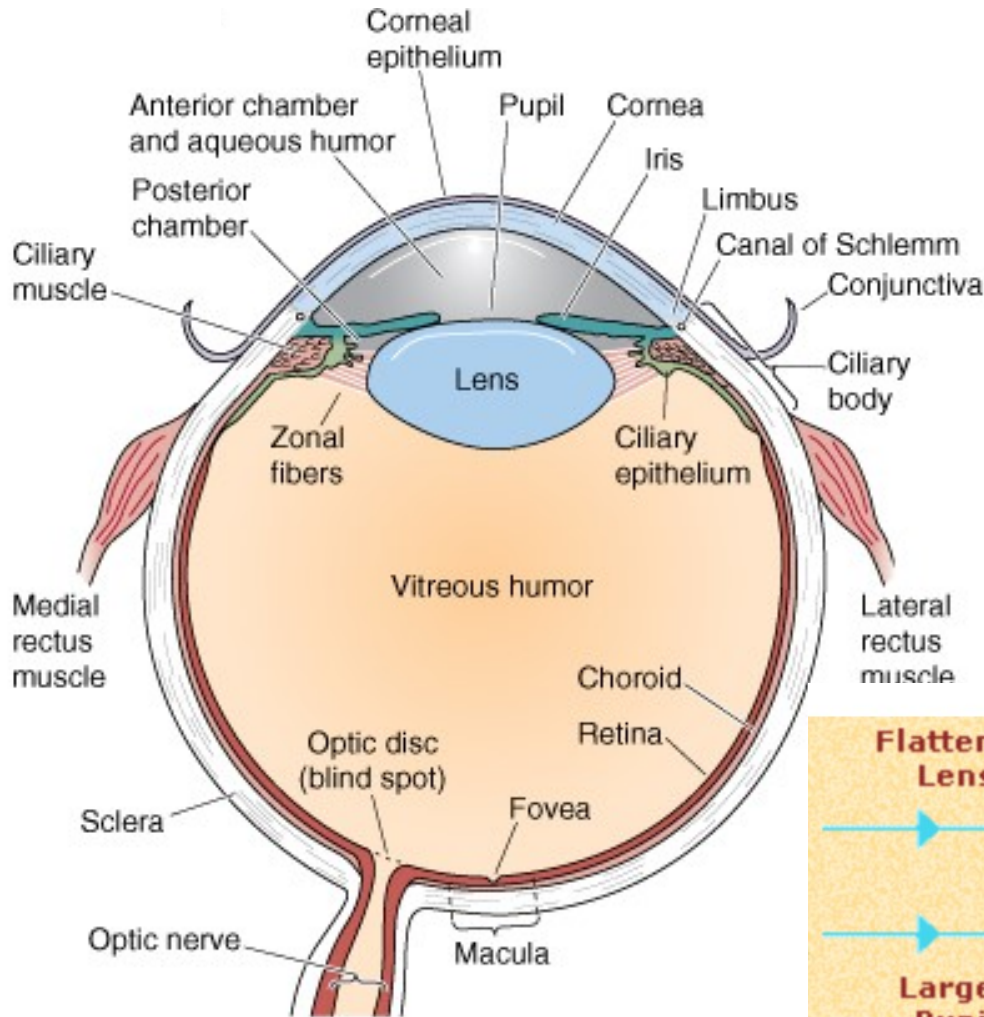

Image formation

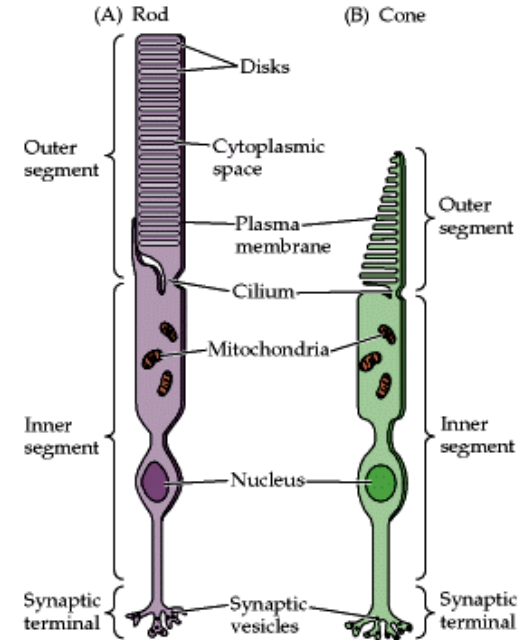
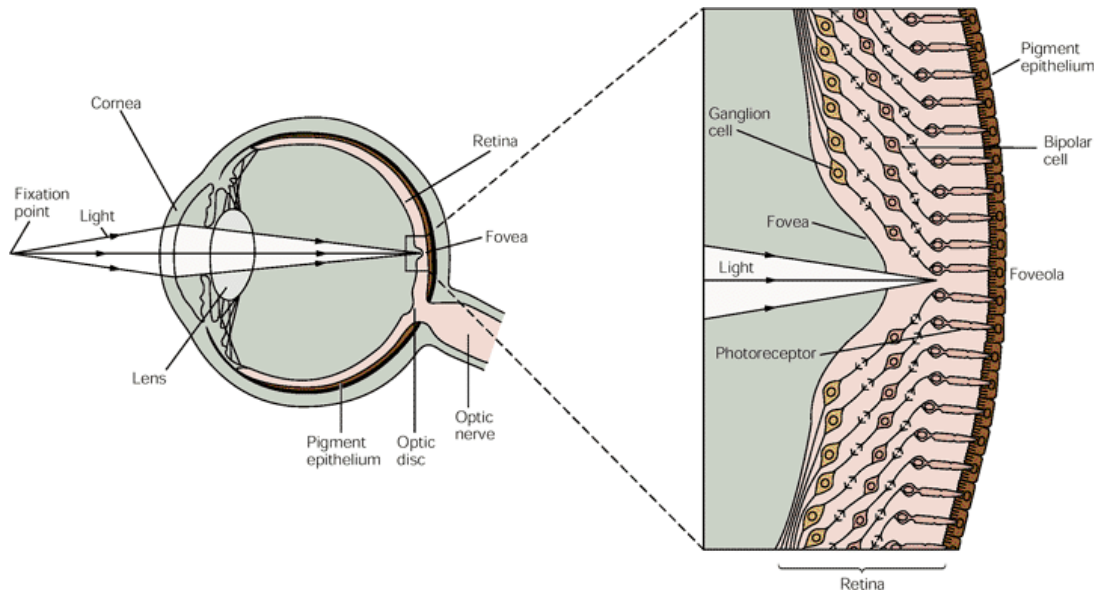
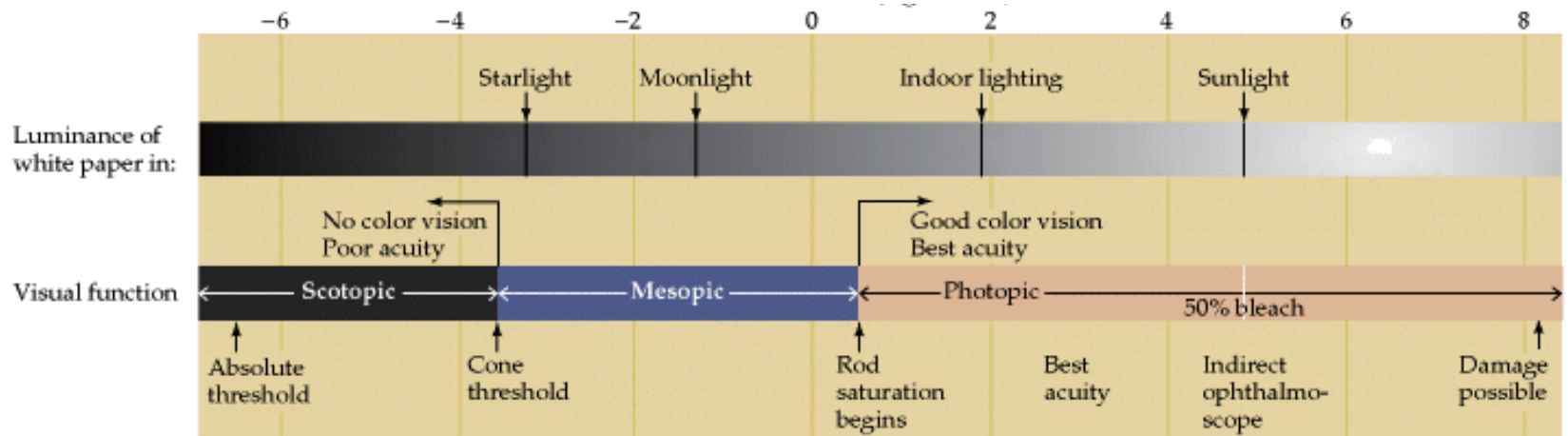
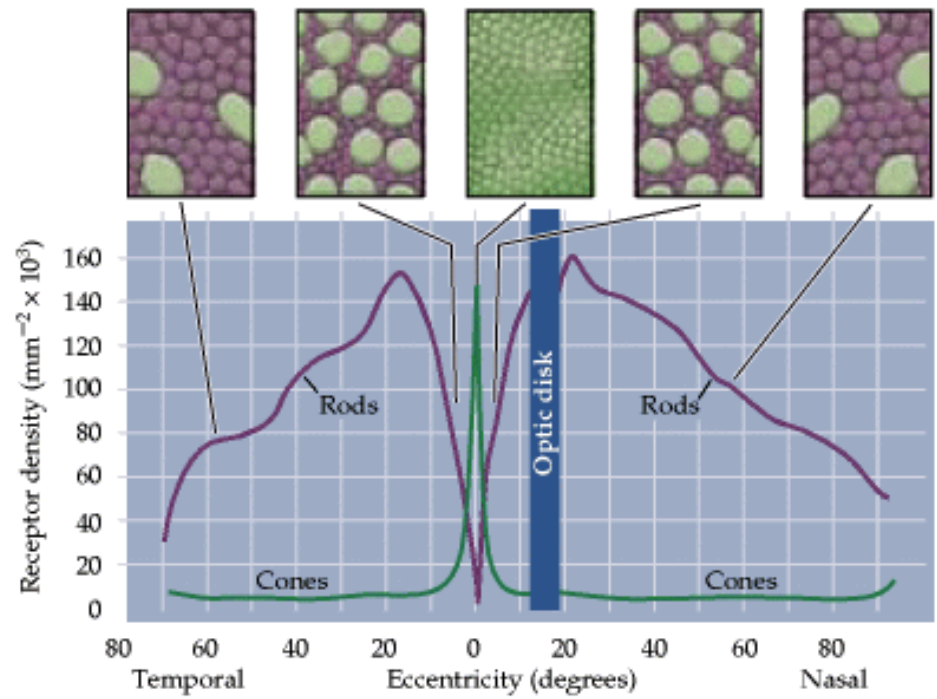

Table 26-1 Differences Between Rods and Cones and Their Neural Systems

Rods	Cones
High sensitivity to light, specialized for night vision	Lower sensitivity, specialized for day vision
More photopigment, capture more light	Less photopigment
High amplification, single photon detection	Lower amplification
Low temporal resolution: slow response, long integration time	High temporal resolution: fast response, short integration time
More sensitive to scattered light	Most sensitive to direct axial rays
Rod system	Cone system
Low acuity: not present in central fovea, highly convergent retinal pathways	High acuity: concentrated in fovea, dispersed retinal pathways
Achromatic: one type of rod pigment	Chromatic: three types of cones, each with a distinct pigment that is most sensitive to a different part of the visible light spectrum



Photopigment of rods

Rhodopsin

- Opsin
 - G – protein

- Retinal
 - Aldehyd retinolu (vit. A)

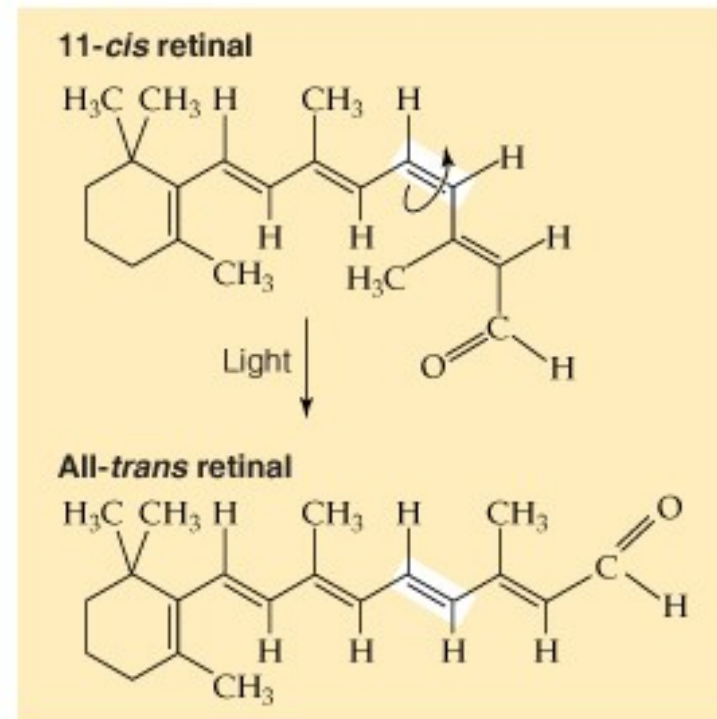
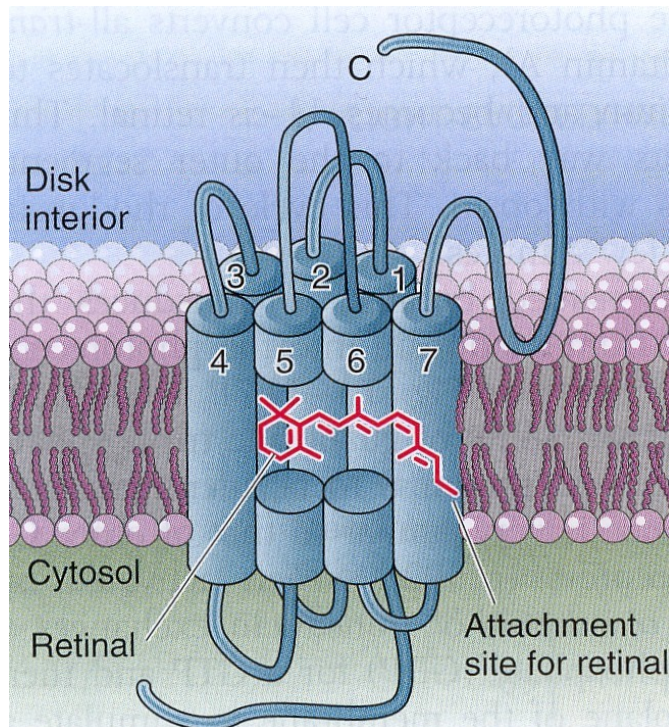

Photopigments of cones

- 3 types of cones - 3 types of photopigment
 - Blue(420nm)
 - Green (530nm)
 - Red (560nm)

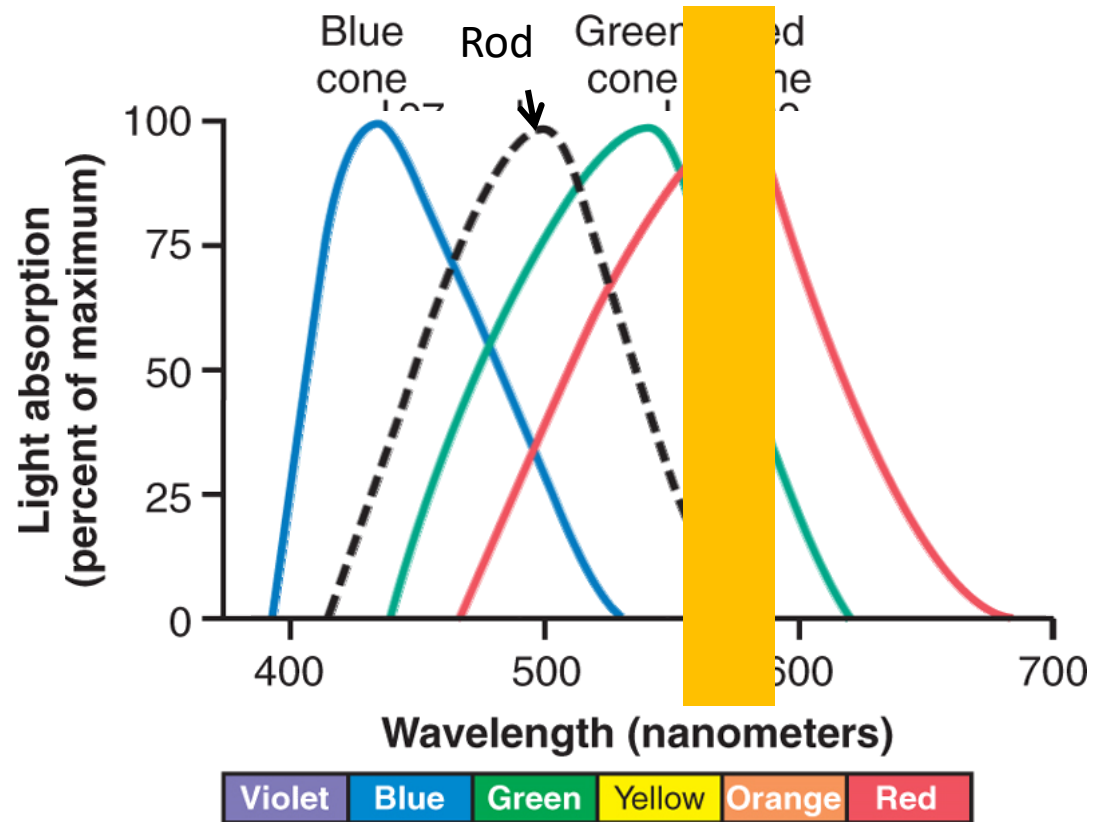

Hall: Guyton and Hall Textbook of Medical Physiology, 12th Edition
Copyright © 2011 by Saunders, an imprint of Elsevier, Inc. All rights reserved.

<http://www.slideshare.net/CsillaEgri/presentations>

Photopigments of cones

- 3 types of cones - 3 types of photopigment

- Blue(420nm)
- Green (530nm)
- Red (560nm)

- Color is interpreted by ratio of cone stimulation

- Orange (580nm)
 - Blue: 0%
 - Green: 42%
 - Red:99%

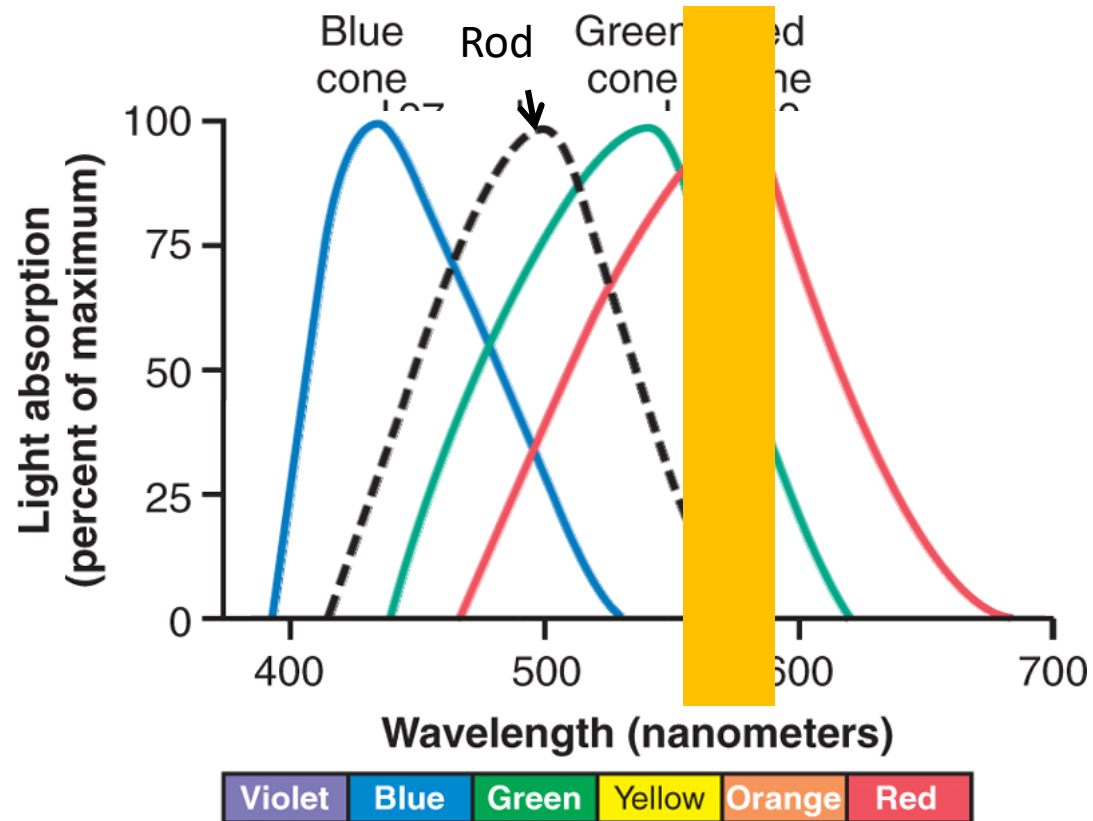

Hall: Guyton and Hall Textbook of Medical Physiology, 12th Edition
Copyright © 2011 by Saunders, an imprint of Elsevier, Inc. All rights reserved.

<http://www.slideshare.net/CsillaEgri/presentations>

Phototransduction

- Photoreceptors continuously release neurotransmitter (glutamate) in darkness
- In response to the light, the membrane **hyperpolarizes** and release less neurotransmitter

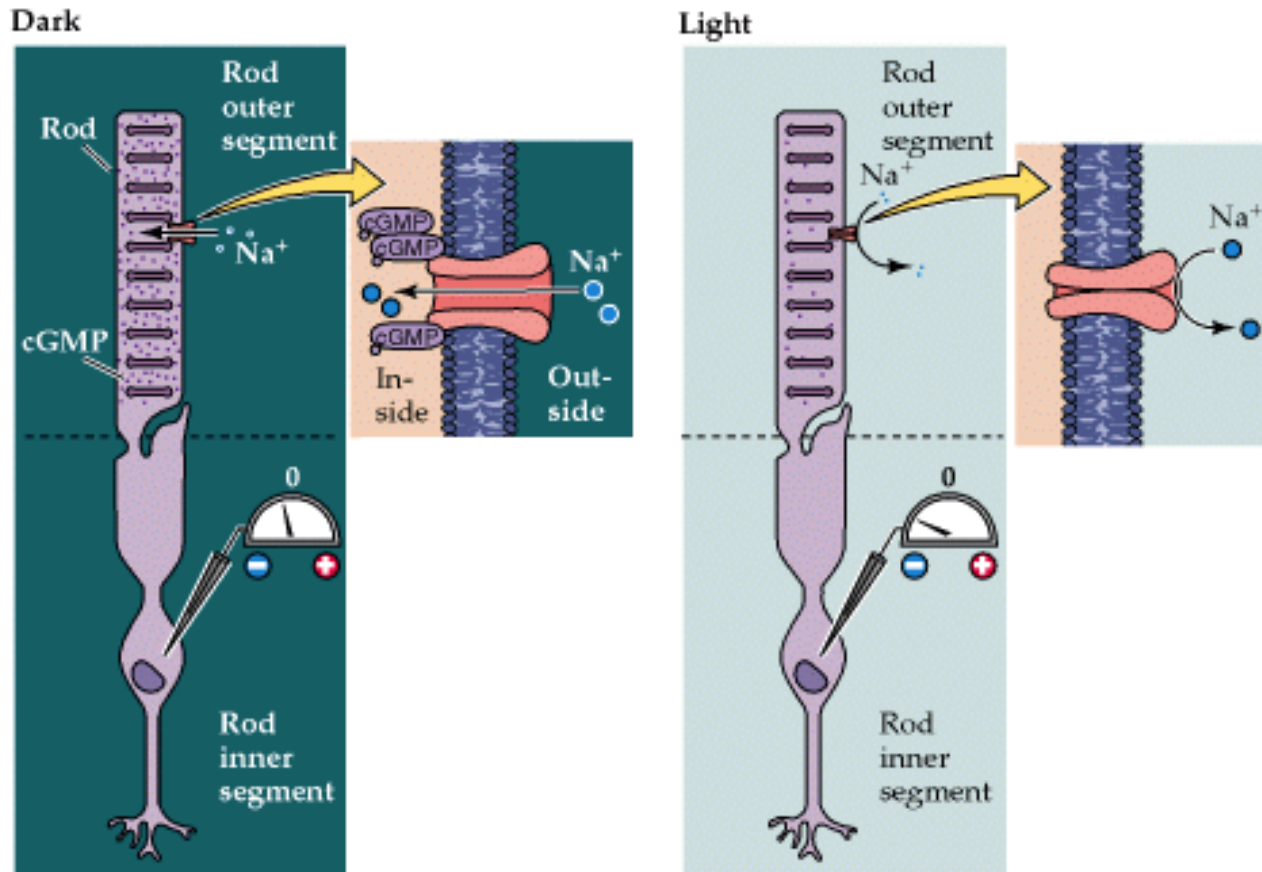

Phototransduction - darkness

- Guanylate cyclase
 - cGMP
- cGMP-gated Na^+ channels
 - Na^+ influx
- Voltage gated Ca^{2+} channels
 - Release of glutamate
- The balance is kept by
 - K^+ efflux
 - Na^+/K^+ exchanger
- Resting membrane potential: -40mV

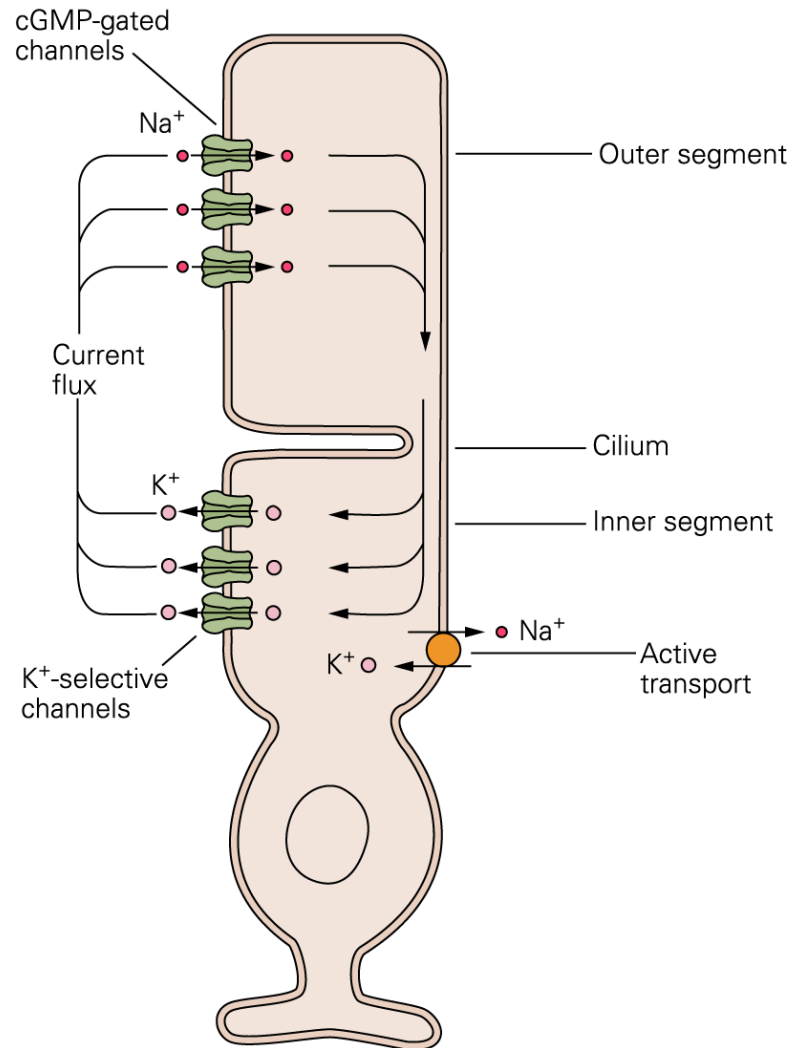

Phototransduction - light

- Photon is absorbed by photopigment
- Isomerization of retinal
- Cascade of reactions result in cGMP phosphodiesterase
 - cGMP levels decreased
- Deactivation of cGMP gated Na^+ channel
- K^+ efflux continues
- Membrane hyperpolarization
 - Deactivation of voltage Ca^{2+} channels
 - Decrease in glutamate release

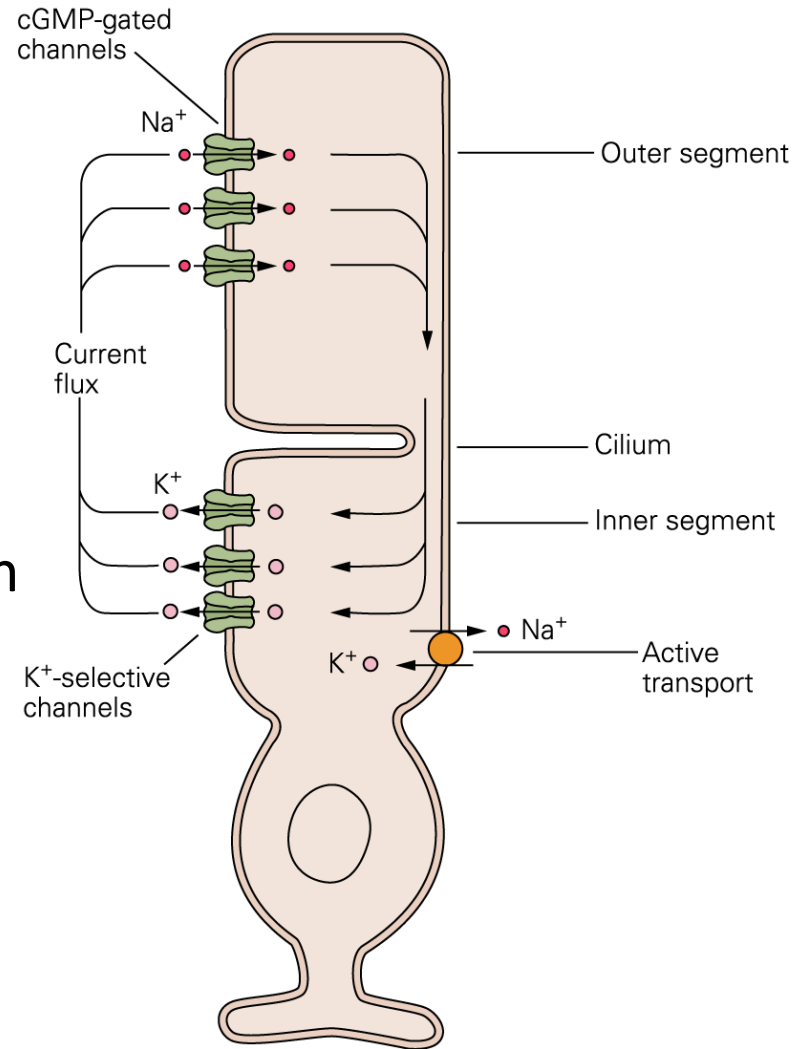

Adaptation to the light/darkness

- **Optic adaptation**
 - Constriction of pupils
- **Photoreceptor adaptation**
 - Ca^{2+} inhibits guanylate cyclase
 - Light
 - Ca^{2+} decreased - cGMP increa
 - Darkness
 - Ca^{2+} increased – cGMP decreased
 - cGMP gated Na^+ channels...

