



Changes of Phases

The Foundation Course on Physics

Professor Vojtěch Mornstein

Phases

Gas – energy of thermal motion of particles is **greater** than the energy of different bonds between the particles.

Liquid - energy of thermal motion of particles is **about the same** like the energy of different bonds between the particles (van der Waals bonds – see next slide).

Solid - energy of thermal motion of particles is **smaller** than the energy of different bonds between the particles. The bonds can be covalent (diamond), ionic (salt crystal), metallic (metals), van der Waals (see next slide).

Plasma – highly ionised gas is considered 4th phase. It exists at very high temperatures.

Changes of phases (i.e. phase transitions) are always accompanied by absorption or release of heat!!

Overview of weak chemical bonds (they are responsible for e.g. stable shape of our bodies!)

- Hydrogen bonds
- Hydrophobic interaction
- **Van der Waals bonds**

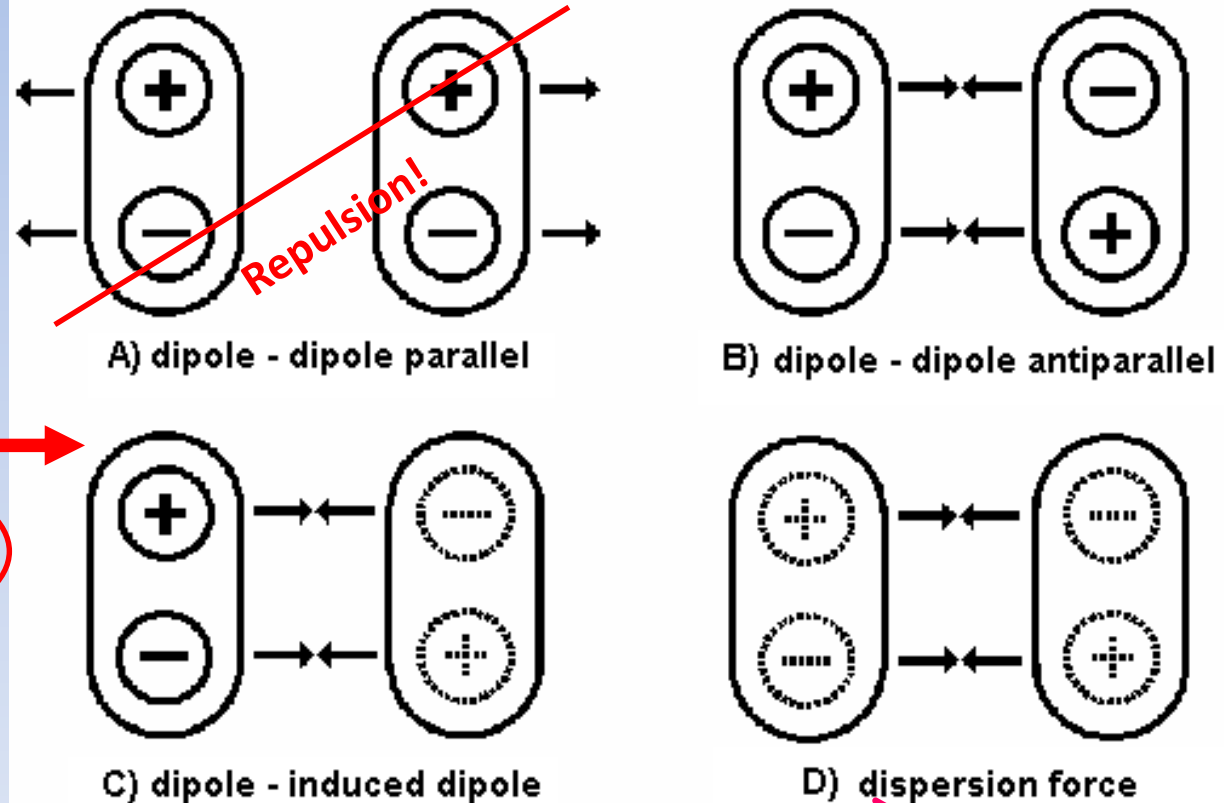

Also called London forces, sometimes not classified as proper van der Waals bonds

Hydrogen bonds between water molecules – stronger than van der Waals bonds

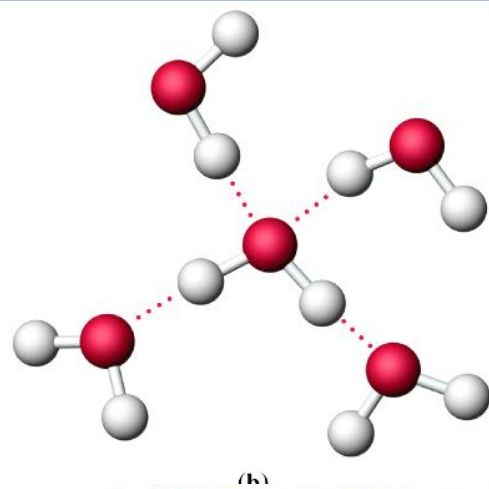
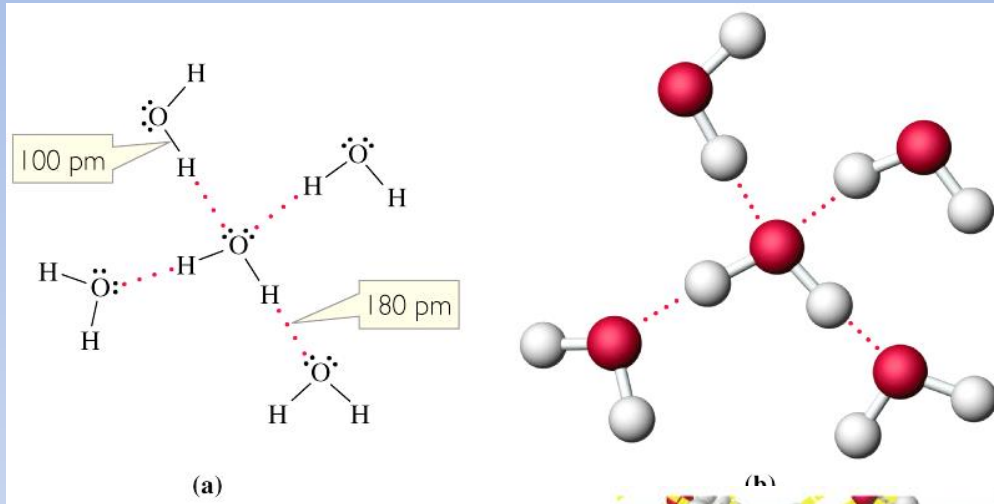

Liquid water

About five molecules of water form the so called **cluster** – a relatively stable body resembling a molecule.

Ice and hexagonal shape of snow flakes

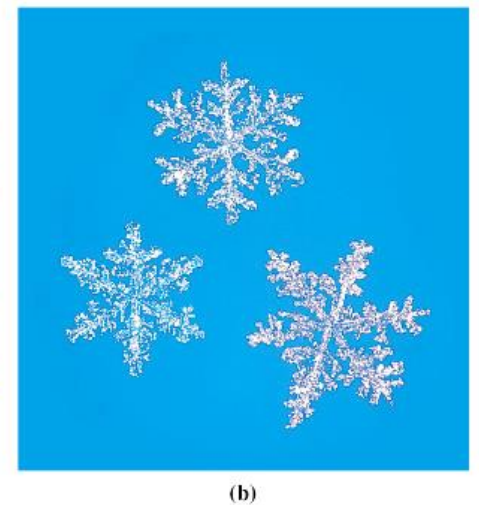
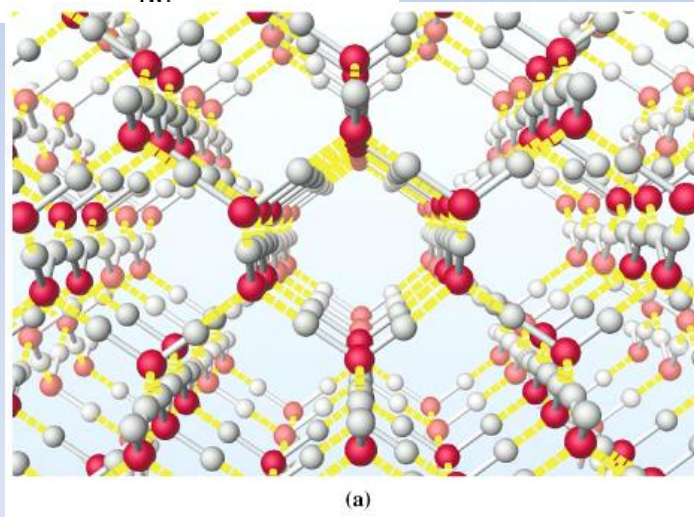

Phase changes

A general rule:

1. To break some bonds we need some energy. Heat is absorbed/delivered from surroundings.
2. A formation of some bond leads to release of some energy. Heat is produced/released into the surroundings.

These rules are valid also for the van der Waals intermolecular forces!!!

Latent Heats

a) Latent heat of fusion (melting) = latent heat of solidification

For unit mass: Specific latent heat of fusion (melting) = specific latent heat of solidification.
It is the heat required per unit mass to melt the substance without change of temperature.

$$l_f = h_f = \frac{Q_f}{m} \quad [\text{J}\cdot\text{kg}^{-1}]$$

b) Latent heat of vaporization = latent heat of condensation:

For unit mass: Specific latent heat of vaporization = specific latent heat of condensation.
Heat required per unit mass to vaporize the liquid without change of temperature.

$$l_v = h_v = \frac{Q_v}{m} \quad [\text{J}\cdot\text{kg}^{-1}]$$

c) **Sublimation and desublimation**, the direct changes of a solid to a gas, and vice versa, are also accompanied by consumption or production of heat.

Mysterious liquids

- Superheated liquid

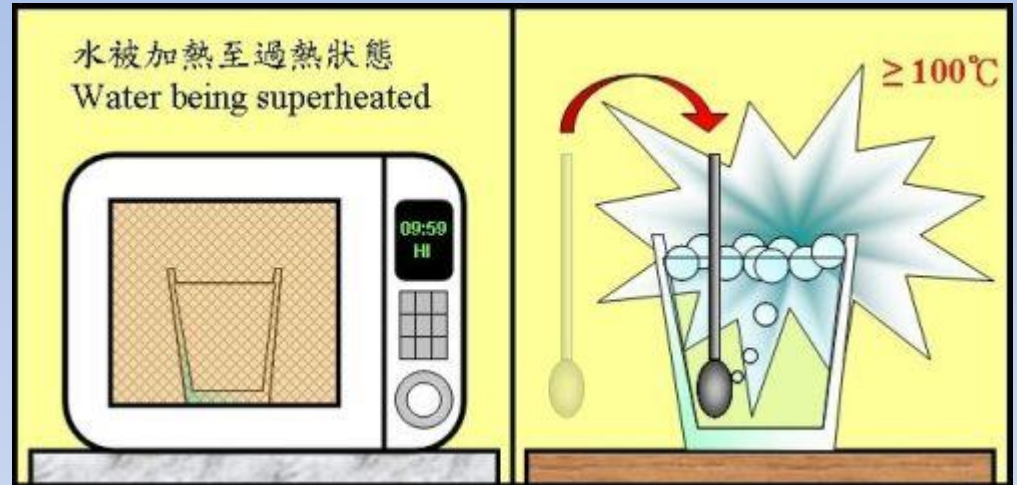

- Supercooled liquid

Start of solidification or boiling needs a **nucleation center** (a seed crystal, dust particle, microbubble etc.)



Very similar phenomenon



Sodium acetate heating pads

Sodium acetate is used in heating pads, hand warmers, and hot ice. Sodium acetate trihydrate crystals melt at $58\text{ }^{\circ}\text{C}$ dissolving in their **water of crystallization**. When they are heated past the melting point and subsequently allowed to cool, the aqueous solution becomes **supersaturated**. This solution is capable of cooling to room temperature without forming crystals! By pressing on a metal disc within the heating pad, a **nucleation center** is formed, causing the solution to crystallize back into solid sodium acetate trihydrate. The process of crystallization is exothermic (latent heat of fusion is about $264\text{--}289\text{ kJ/kg}$).

Thermoregulation due to sweating

- One of the ways how to decrease our body temperature, e.g., in hot days, is production of sweat by small glands we have in our skin. Water is evaporated and heat of vaporisation is absorbed.
- Imagine a hot day with the air temperature of about 30 °C. Compare the body thermoregulation in the Amazonian forest or Sahara dessert at this temperature!

Salt on streets

(it will appear in next days!)

What happens when salt comes in contact with snow or ice? *Keep in mind that dissolving of a substance in water lowers its fusion temperature.*

1. The snow is molten in presence of dissolving salt. Temperature decreases.
2. Heat is absorbed *from* ambient medium (surroundings) so that more snow can be dissolved. Street become free of snow or ice.
3. This mechanism can work up to about $-10\text{ }^{\circ}\text{C}!!$

White Mountain Freezer

(TRIPLE MOTION)

The "World's Best" Ice-Cream Freezer

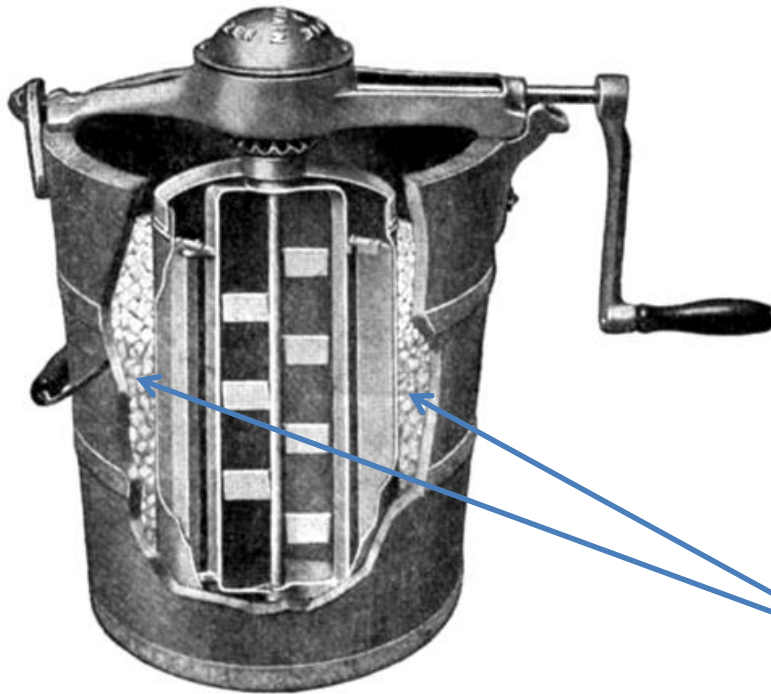

This World-Famous Freezer

Makes the most perfect ice-creams and sherbets in a very few minutes, as well as an unlimited variety of delicious frozen fruits, puddings, and chilled dainties at a very trifling cost. It will surprise you to learn the great extent of "White Mountain" usefulness. Send for our recipe book, "Frozen Dainties," which tells everything you need to know about the making of the most delicious desserts and gives about one hundred recipes.

THE WHITE MOUNTAIN FREEZER COMPANY

NASHUA, N. H.

Freezing mixtures

- How to prepare ice without a refrigerator?

About -20°C can be achieved with a 1 to 3 ratio by weight of sodium chloride to ice.

In the past, ice was collected in winter and sold in summer by e.g. Breweries.

Liquefaction of gases

The Linde liquefaction process

Depends solely on throttling expansion:

- Compression – cooling to ambient temperature (even further by refrigeration) – throttling and liquefaction.

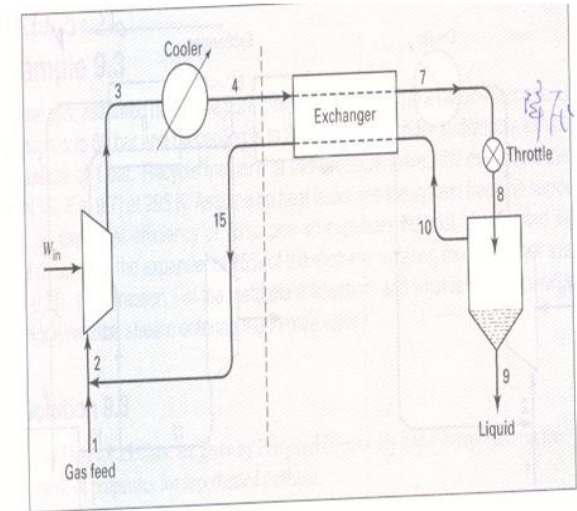

- How to produce liquid gas?
- The most common process for the preparation of liquid air is the Linde cycle using the Joule-Thomson effect. Keep in mind that expansion of a **real gas** leads to a temperature decrease even (seemingly) without doing mechanical work.
- However, *there are some attraction forces between molecules and we need to do some work against them when the distances between molecules increase.*

End of lecture – thank you for your attention!

