

Preclinical dentistry I.

Doc. MUDr. Lenka Roubalíková, Ph.D.

lroubal@med.muni.cz

+420 607 122 064

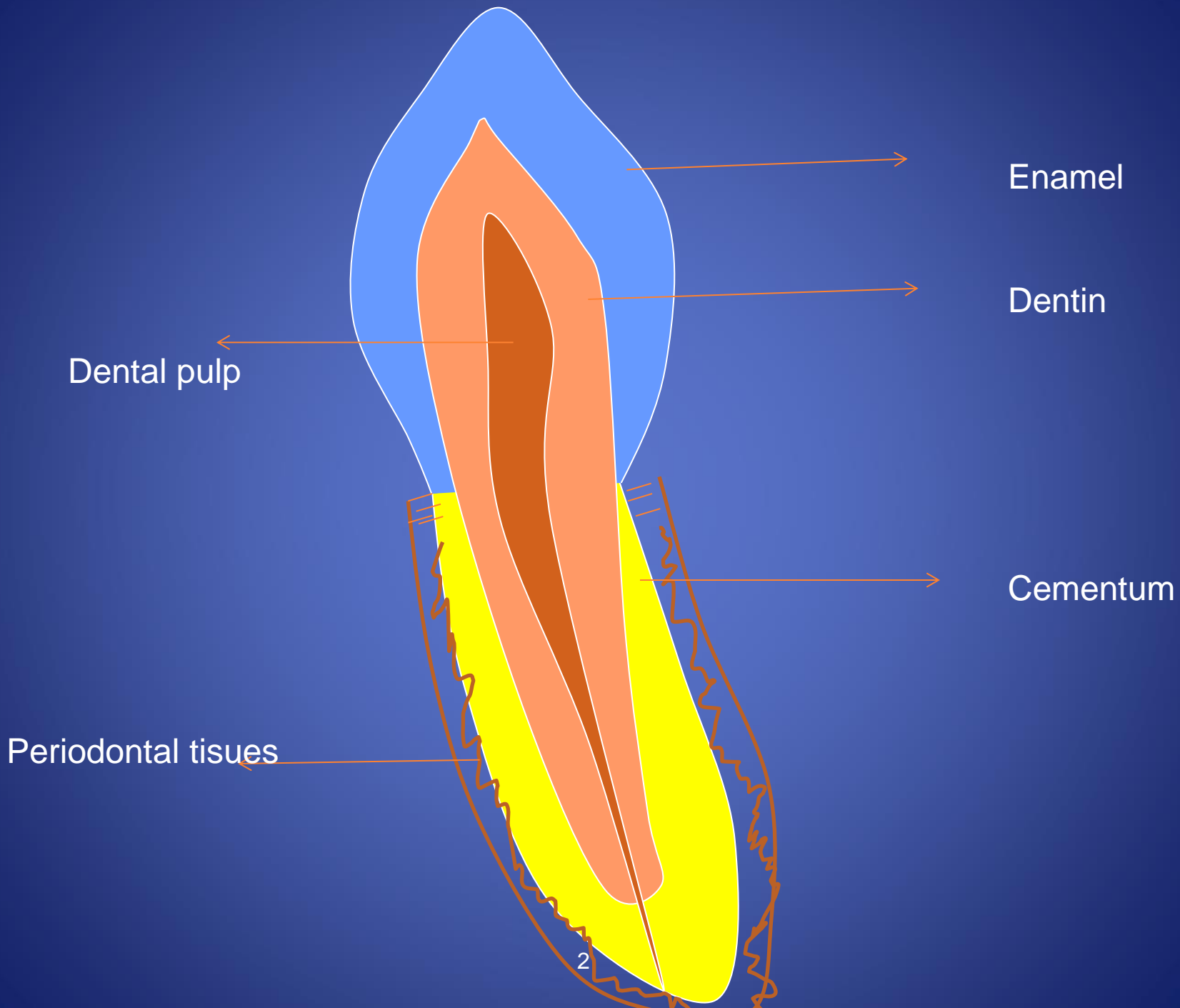

Restorative dentistry

Diseases of hard dental tissues, dental pulp and periodontal tissues (of pulpal origin)

Aethiology, ,pathogenesis,diagnosis,therapy and prevention.

Diseases of hard dental tissues

Congenital – genetic reasons

Postnatal

- Before eruption
- After eruption

Congenital

- Amelogenesis imperfecta

Enamel is affected

- Dentinogenesis imperfecta

Dentine is affected

Before eruption

- Hypomineralization (white, brown spots)
- Defects of enamel (hypoplasia)

Reasons

- local (inflammation, traumatic dental injuries)
- systemic (systemic diseases, antibiotics)

After eruption

- **Dental caries**
- Trauma
- Attrition, abrasion
- Erosion
- V-shaped defects



Antony van Leeuwenhoek

(1632 – 1723)

nizozemský přírodovědec a vynálezce. Obchodník v [Amsterdamu](#) a vědec samouk, byl členem královské společnosti. Zhotovil jednoduchý [mikroskop](#) s jedinou čočkou, který zvětšoval 300krát. Prostudoval řadu mikroorganismů a popsal jejich způsob života. Mj. objevil [krevní kapiláry](#), jako první podal v roce 1683 přesný popis bakterií a prvoků, popsal příčné pruhování svalů. Popisem buněčné stavby rostlin se stal jedním ze zakladatelů rostlinné [anatomie](#).

**First observation
of microbes in oral cavity**

17.century

Dental caries

- **Willoughby Dayton Miller**
(1853 -1907)

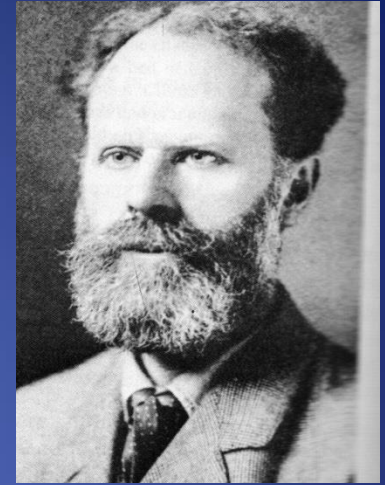

- Explanation – theories

Miller's theory: chemical – bacteriological explanation

Origin of dental caries

- Dental caries originates as decalcification of hard dental tissues. This decalcification is caused by microbes that are present on tooth surfaces in the dental biofilm. These microbes utilize sugars.
- After this decalcification also the decomposition of organic substances follows due to proteolytic microbes.

Dental biofilm – plaque.



Pelicle

- A layer of proteins from saliva that precipitate on the tooth

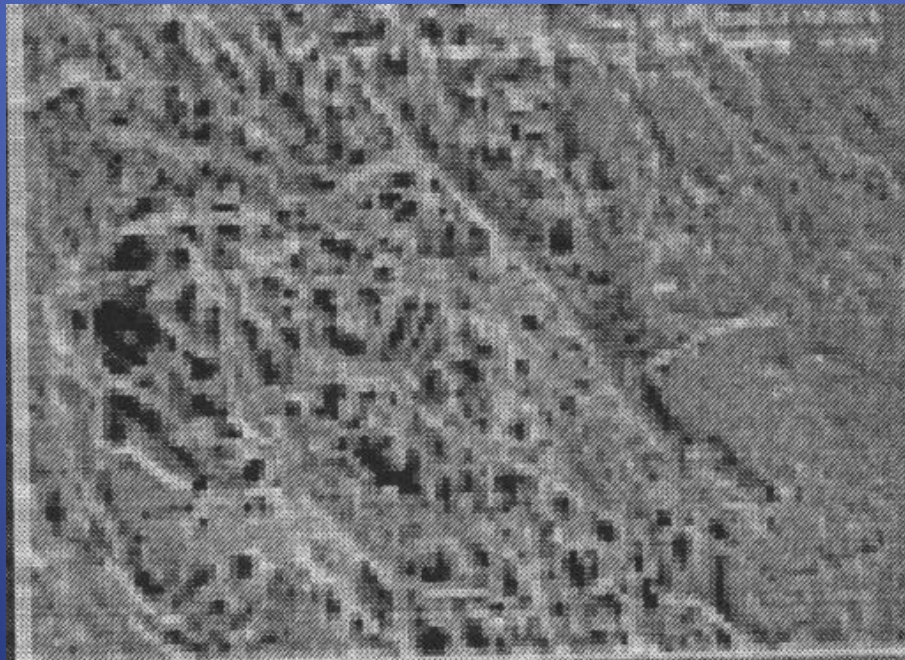

Dental biofilm

- Adherence

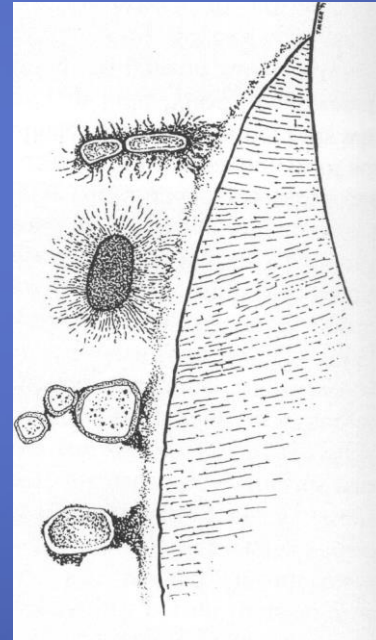
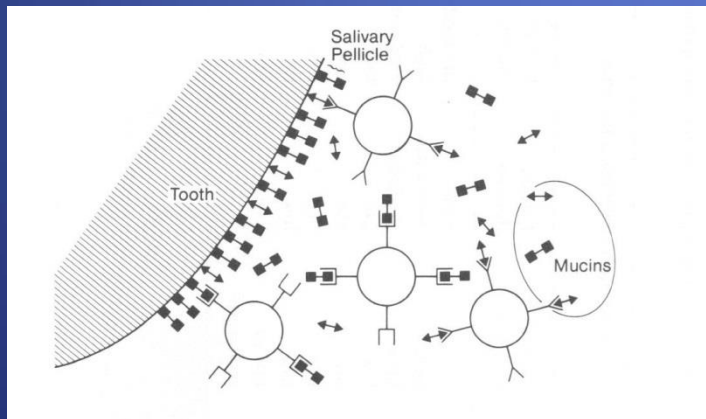

Dental biofilm

- Colonization and coaggregation

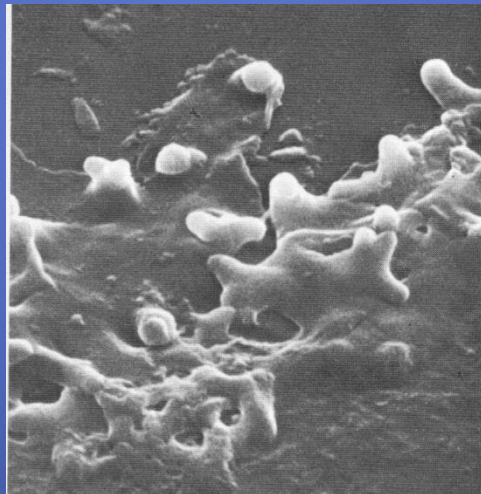
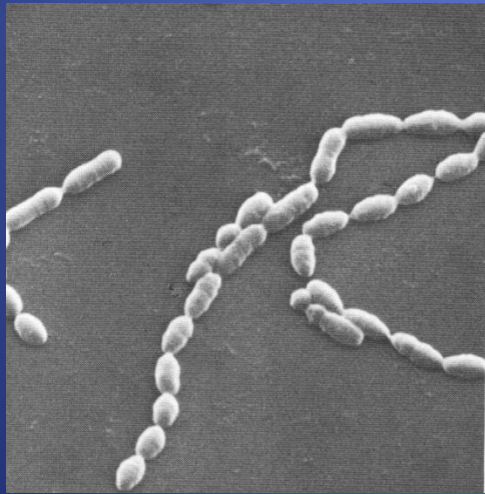

Dental biofilm

- Maturation

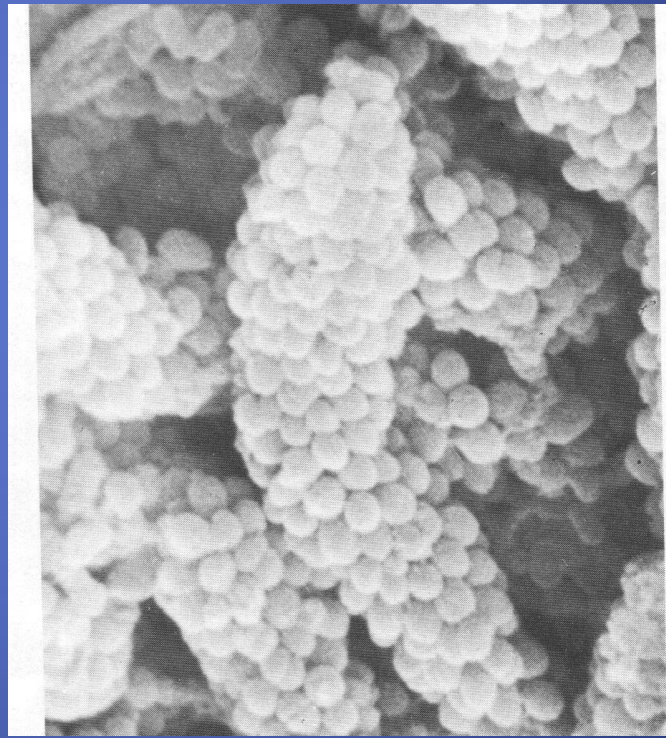

Dental biofilm

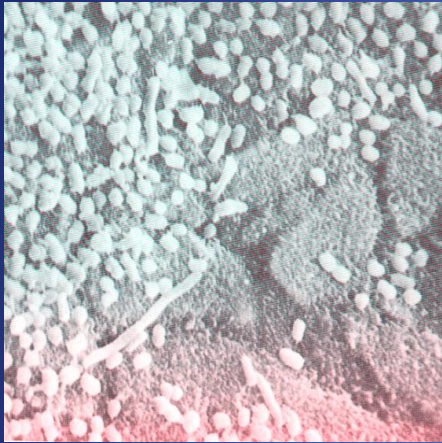

Community

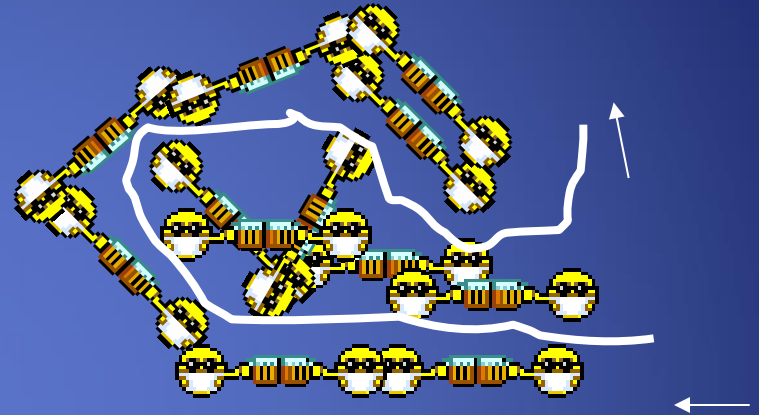

More species,
Better conditions for survival
Higher resistancy
Higher virulency

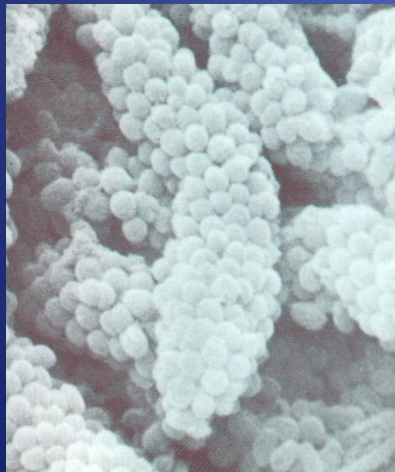

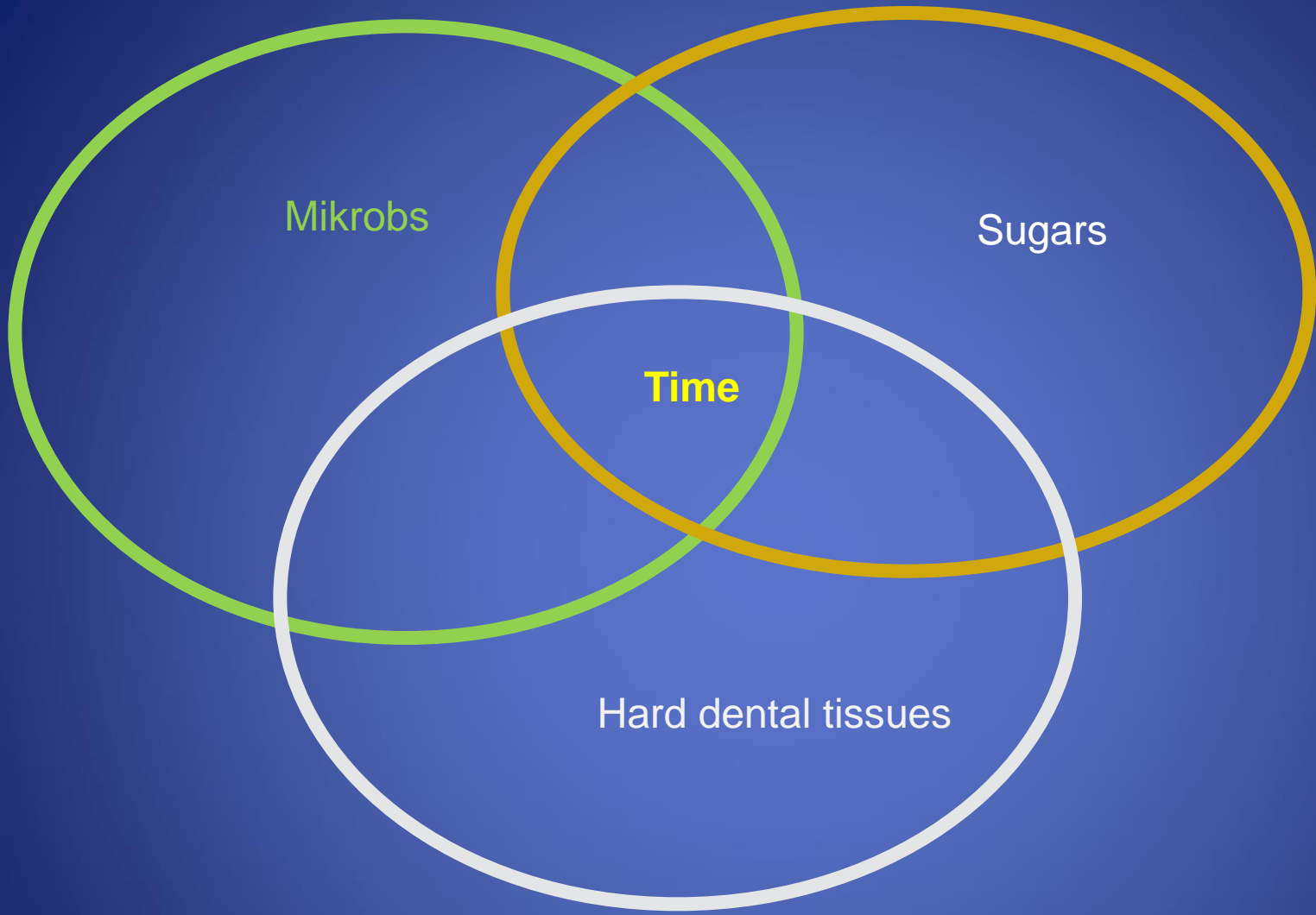

Mikrobs

Sugars

Time

Hard dental tissues

Metabolic activity



Stephan

Dissolving of enamel

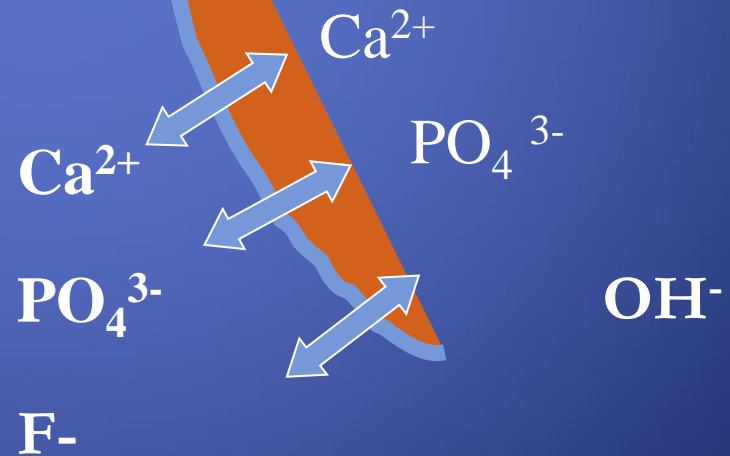
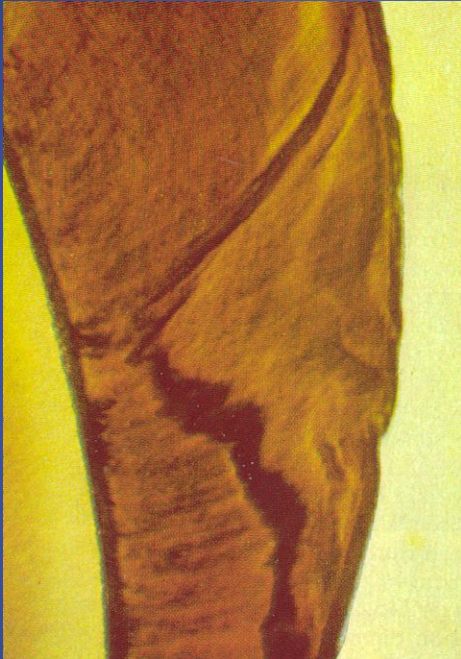

Irreversibil: non cavitated lesion

Demineralization

Reversibil

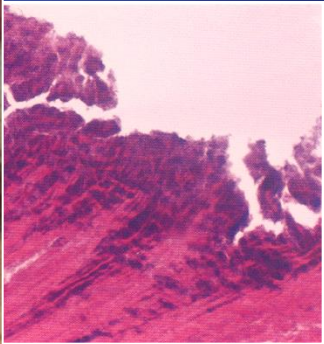

Non cavitated lesion can be healed
Cavitated lesion must be drilled and filled

Time

Dental caries is multifactorial disease

- Essential factors
 - - necessary

- Co condition factors
 - - not necessary but can influence the expansion

Co committans factoras

- Quality of hard dental tissues and position of teeth
- Food – composition and consistency
- Systemic health
- Age
- Heredity (liking of sweetness?)
- Climate

Caries danger areas

- Pits and fissures
- Proximal surfaces below the contact point
- Cervical third of dental crown (area below the maximum convexity)
- Exposed root

= habitually unclean areas







Habitually clean places

- Incisal edges
- Cusps and their slopes
- Areas above the maximal convexity
- Enamel ridges : transverse ridge,
oblique ridge



Classification of dental caries

According to its depth

- Surface caries (caries superficialis)
- Middle caries (caries media)
- { Caries next to dental pulp (caries pulpae proxima)
- { Caries penetrating into dental pulp (caries ad pulpam penetrans)



Deep caries

Surface caries

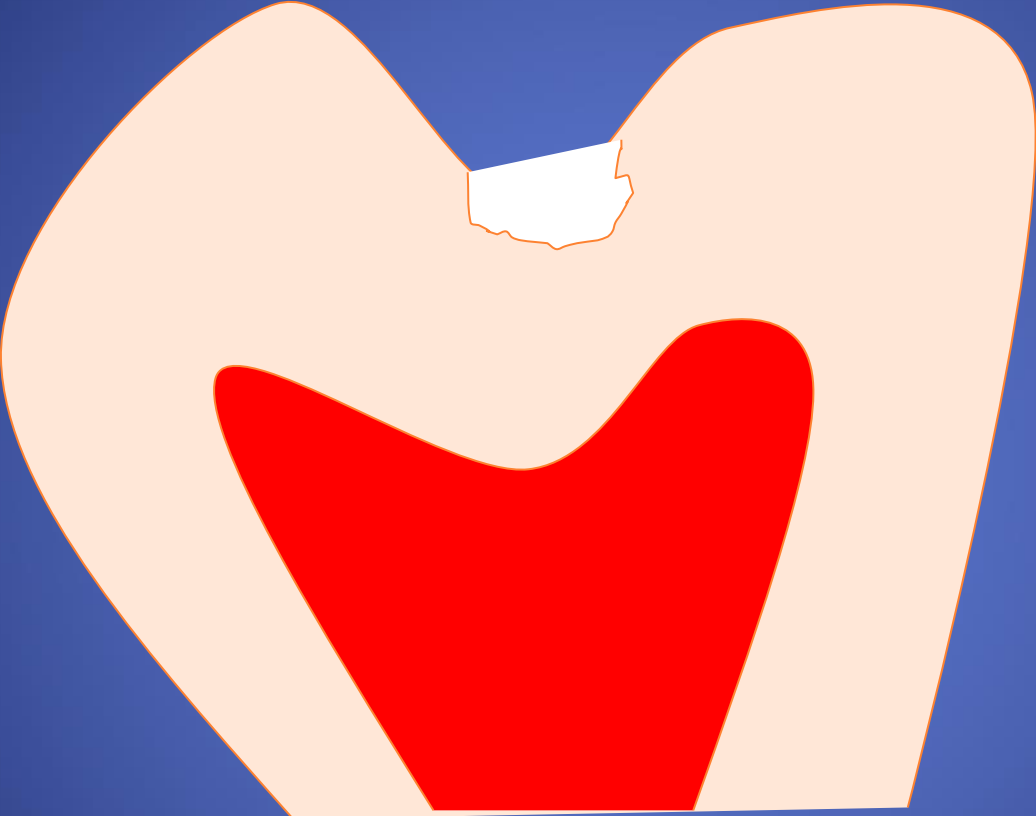

Middle caries

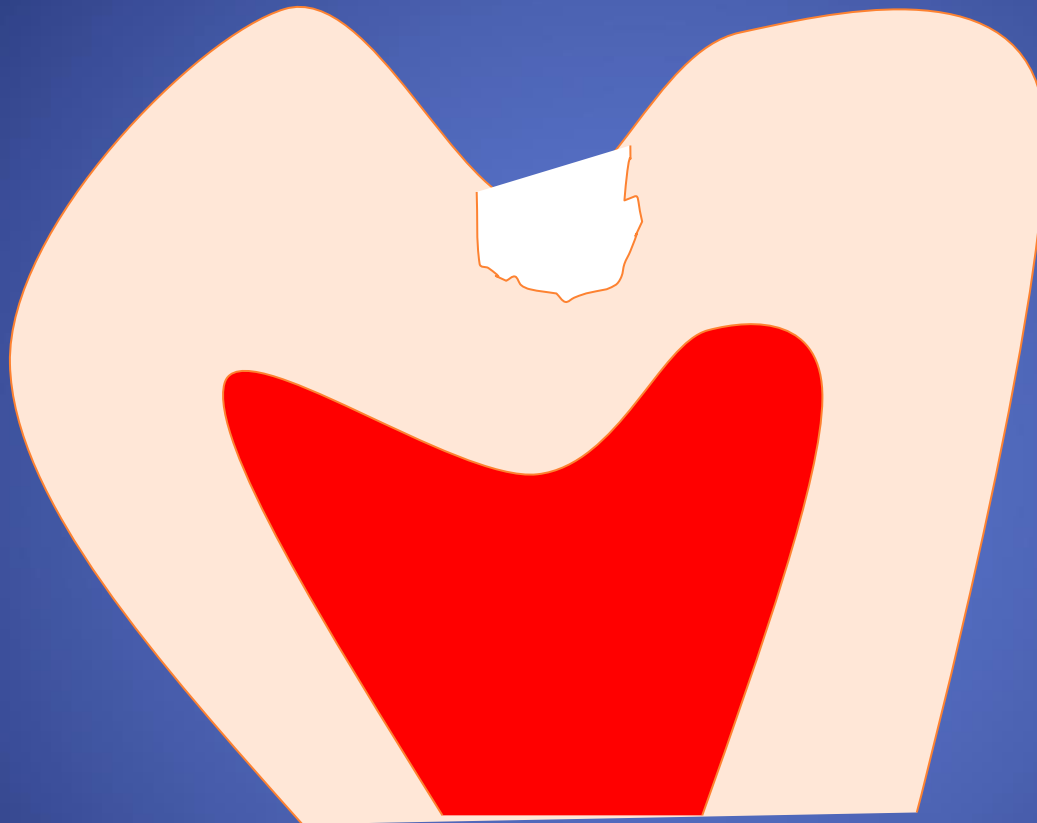

Caries next to dental pulp

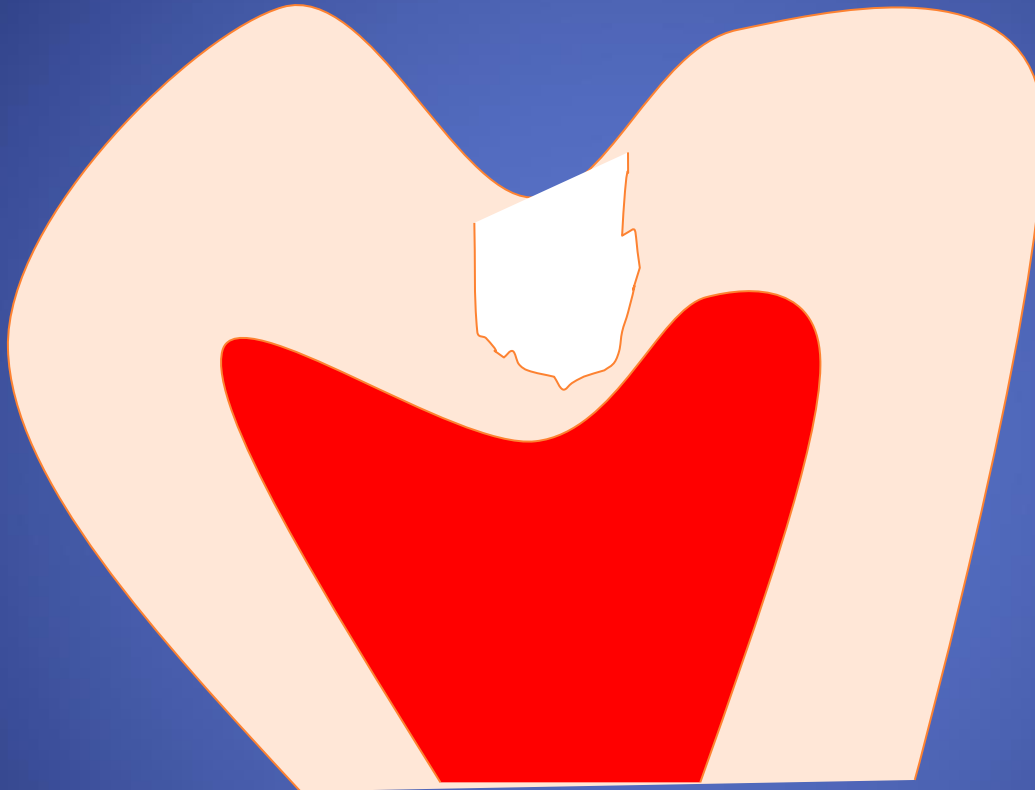

Caries penetgrating into dental pulp

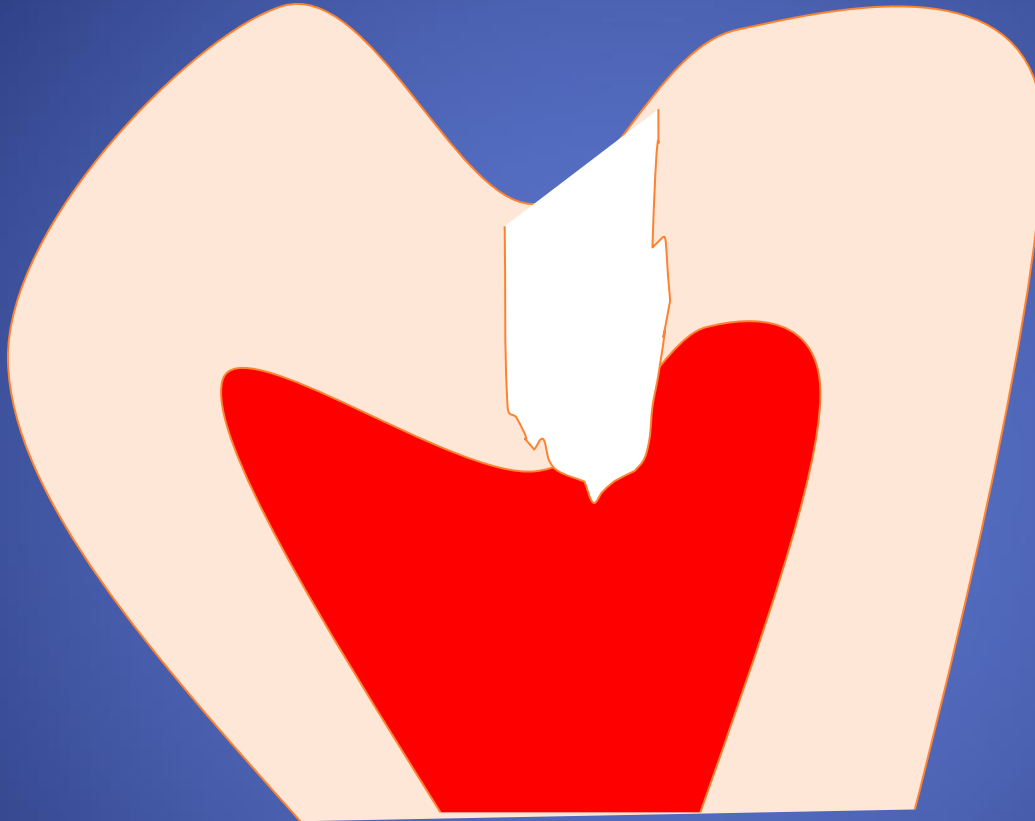

Classification of dental caries

Acc to topograpoy

- Coronal caries
- Root surface caries

According to affected surfaces

- See classification acc to Black

According to affected tissues

- Caries in enamel
- Caries in dentin
- Caries in cementum

Formy kazu

Podle průběhu

- Kaz akutní
- Kaz chronický
- Kaz zastavený

Podle způsobu šíření

- Kaz penetrující
- Kaz podminující

Kaz penetrující

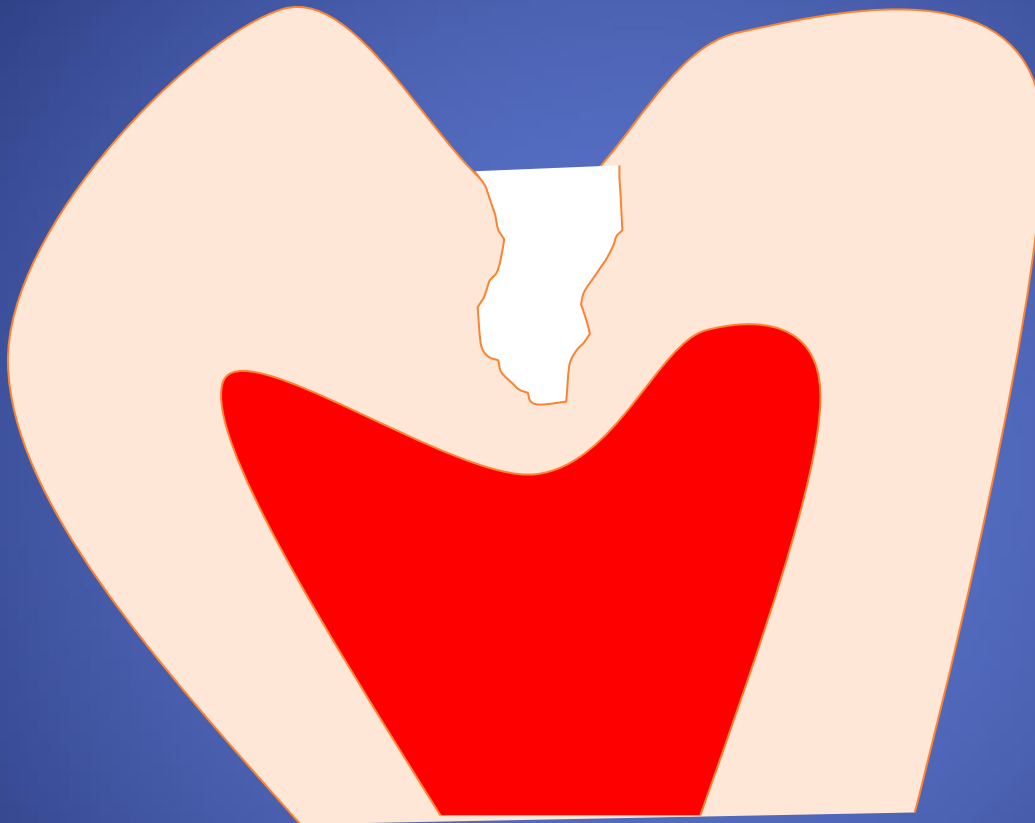

Kaz podminující

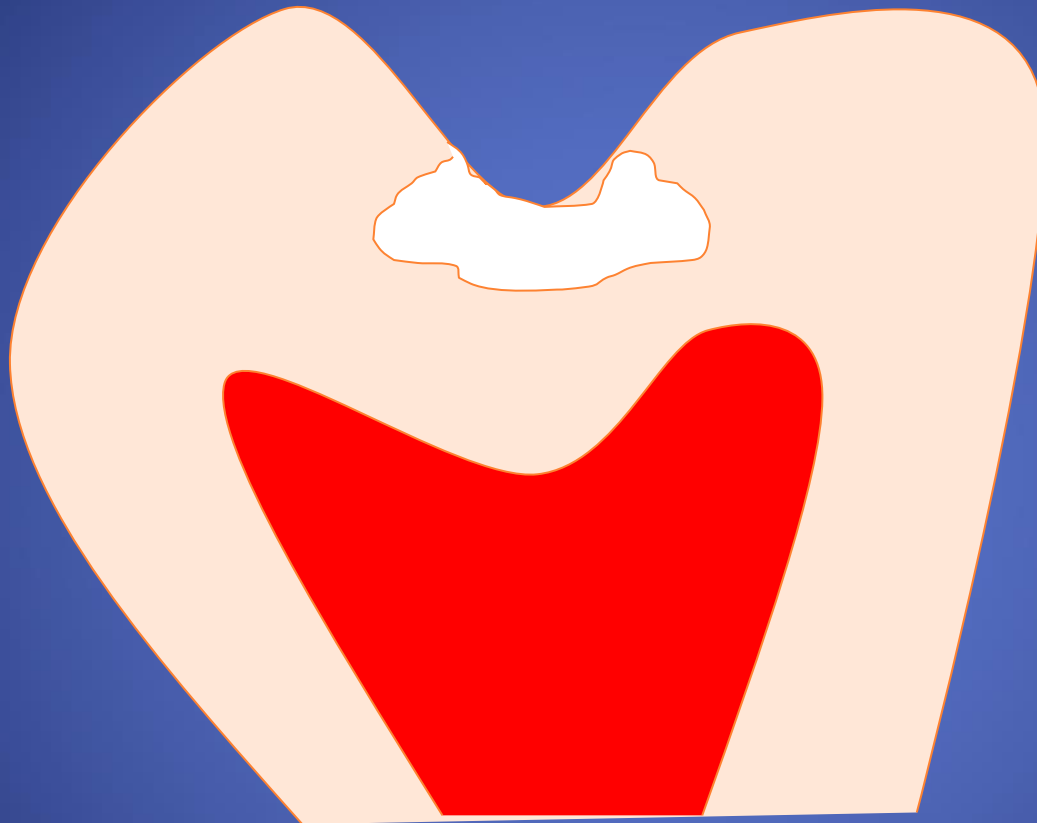

Classification of dental caries

According to origin

- Primary caries
- Secondary caries
- Recurrent caries

Primary caries

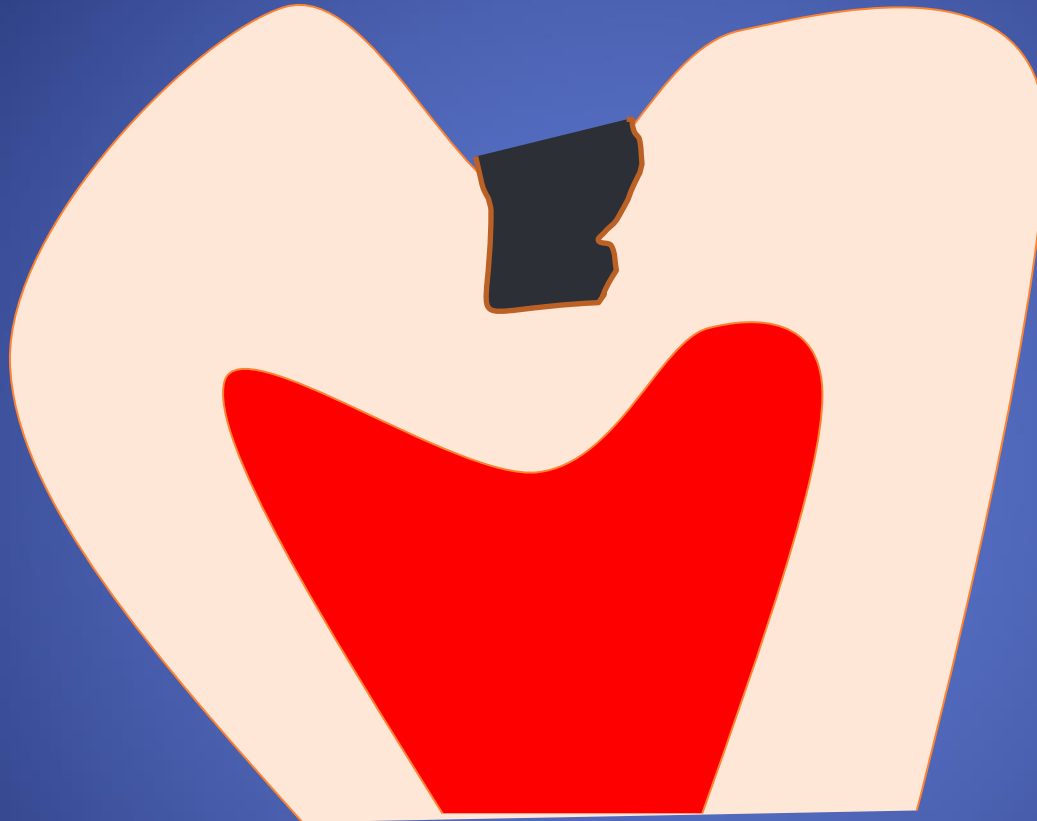

Secondary caries

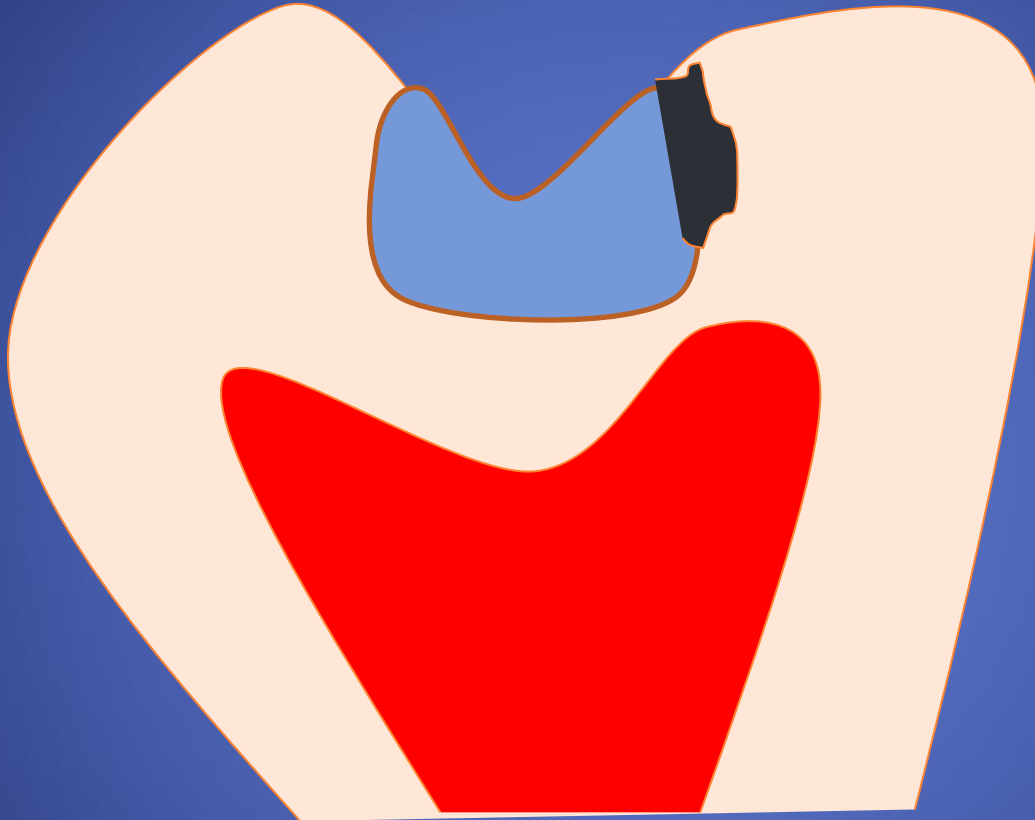

Recurrent caries

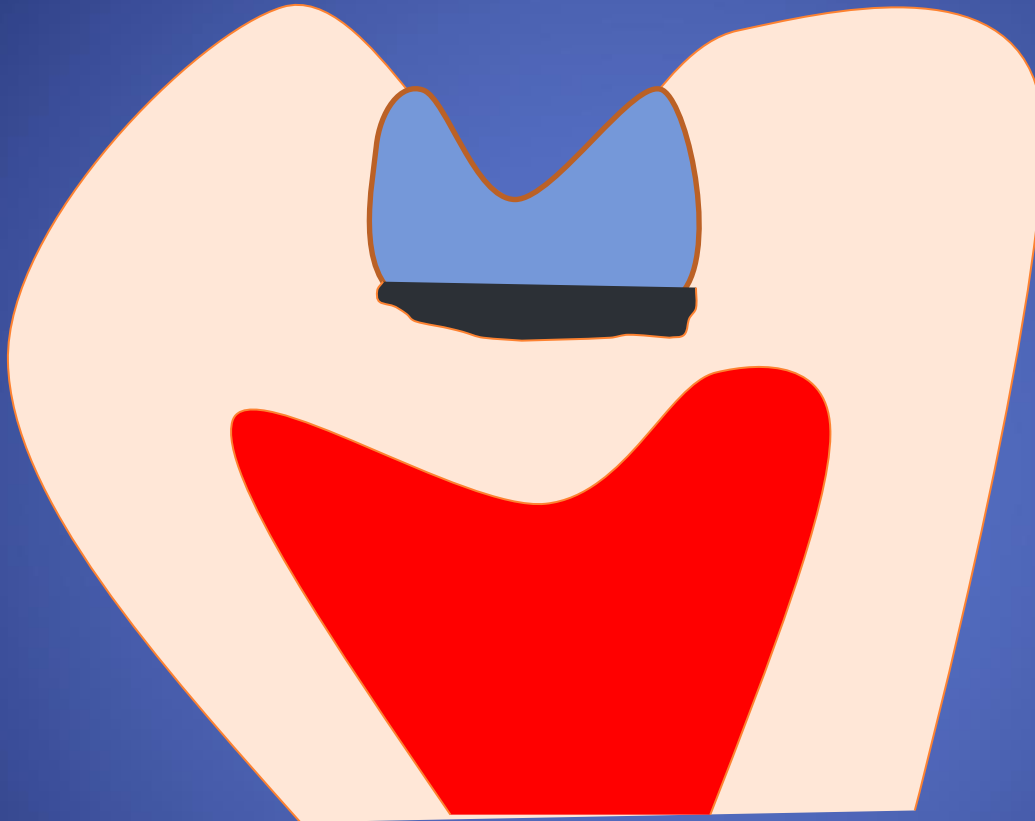

Penetrating caries

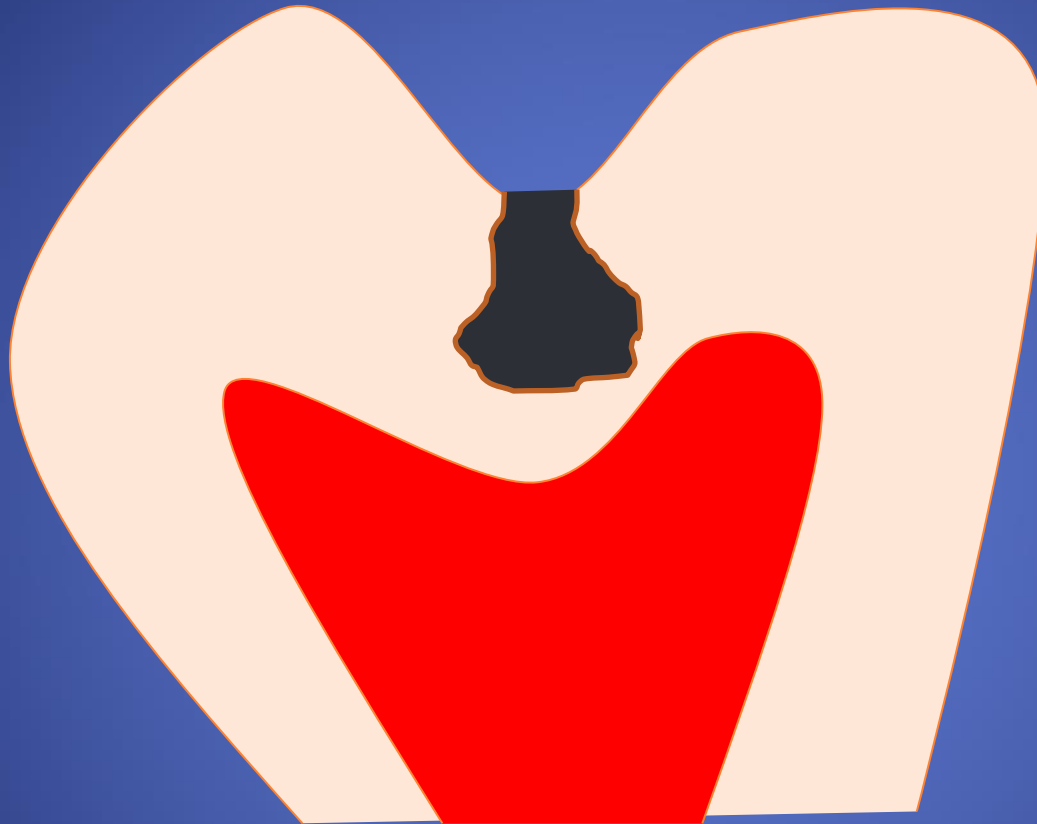

Undermining caries



Nekavitovaná léze

Lze ošetřit dodáním minerálů

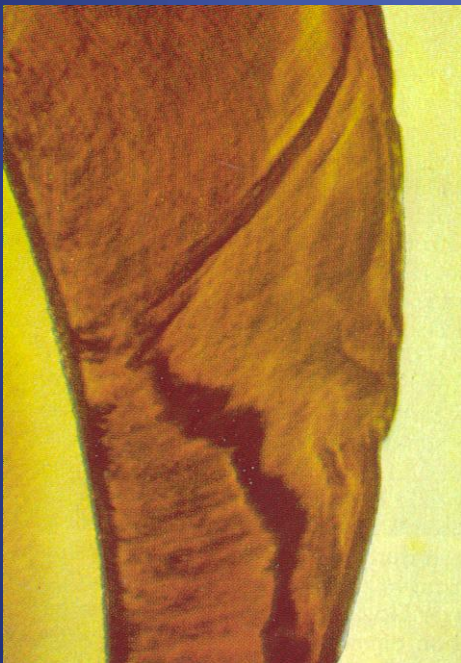

Kavitovaná léze

Ošetřuje se preparací a výplní



Green Vardiman Black

(1836 – 1915)



American professor

Established the scientific bases of dentistry

Formulated basic rules of preparation of cavities

Developed the guidelines for amalgam fillings including the optimal composition of amalgam (balanced alloy)



Preparation

Preparation is an instrumental treatment of the tooth that has been damaged by dental caries in such a way that

- the reconstruction of this tooth is possible
- the filling does not fall out
- the tooth as well as the filling can face up to occlusal forces
- the risk of the caries on treated surface is minimal

(Black 1914)



Preparation

Preparation is an instrumental treatment of the tooth that has been damaged by dental caries in such a way that

- the reconstruction of this tooth is possible
- the risk of the caries on treated surface is minimal- extention for prevention
- the filling does not fall out
- retention
- the tooth as well as the filling can face up to occlusal forces
- resistance

(Black 1914)

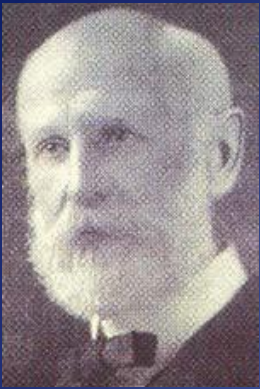

- After we understand the reasons of dental caries we will be able to heal it

(Black 1900)

Classification acc. to Black

- Class I.

Pit and fissure caries



Classification acc. to Black

- Class II.

Proximal surfaces in premolars and molars



Classification acc. to Black

- Class III.

Proximal surfaces of incisors and canines
without
lost an incisal ridge



Classification acc. to Black

- Class IV.

Proximal surfaces of incisors and canines with lost an incisal ridge



Classification acc. to Black

- Class V. cervical lesions



Clasificación acc. to black

- VI. Class
- Caries on incisal edges (abraded)

Obecné zásady ošetření kazu

- Získání přístupu do kazivého ložiska
- Vytvoření obrysu kavity a preventivní extenze – zásada preventivní extenze
- Zásada retence výplně
- Zásada rezistence výplně a zbývajících zubních tkání
- Odstranění kazivého dentinu
- Úprava sklovinných stěn a hran
- Toaleta a konečná kontrola kavity

Obecné zásady ošetření kazu

- Získání přístupu do kazivého ložiska
- Vytvoření obrysu kavity a preventivní extenze – zásada preventivní extenze
- Zásada retence výplně
- Zásada rezistence výplně a zbývajících zubních tkání
- Odstranění kazivého dentinu
- Úprava sklovinných stěn a hran
- Toaleta akonečná kontrola kavity

Probroušením sklovinného valu

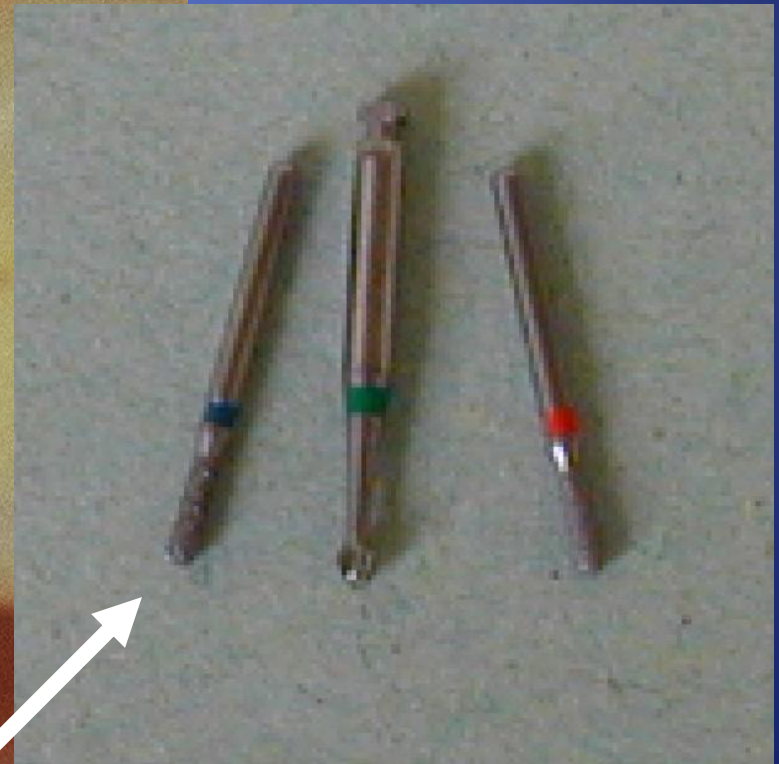
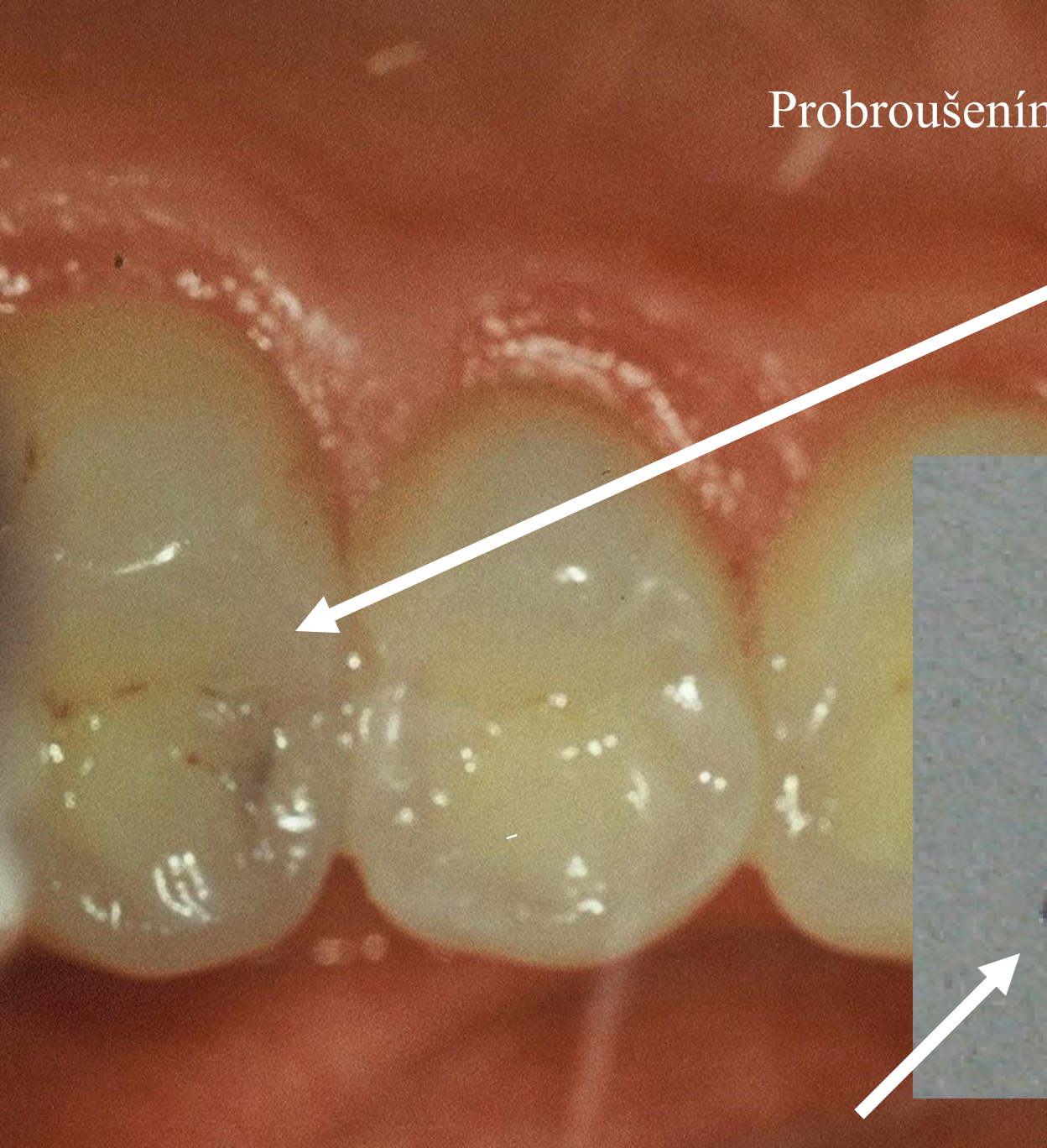



Vylomení sklovinné lamely

Odstranění podmínované skloviny

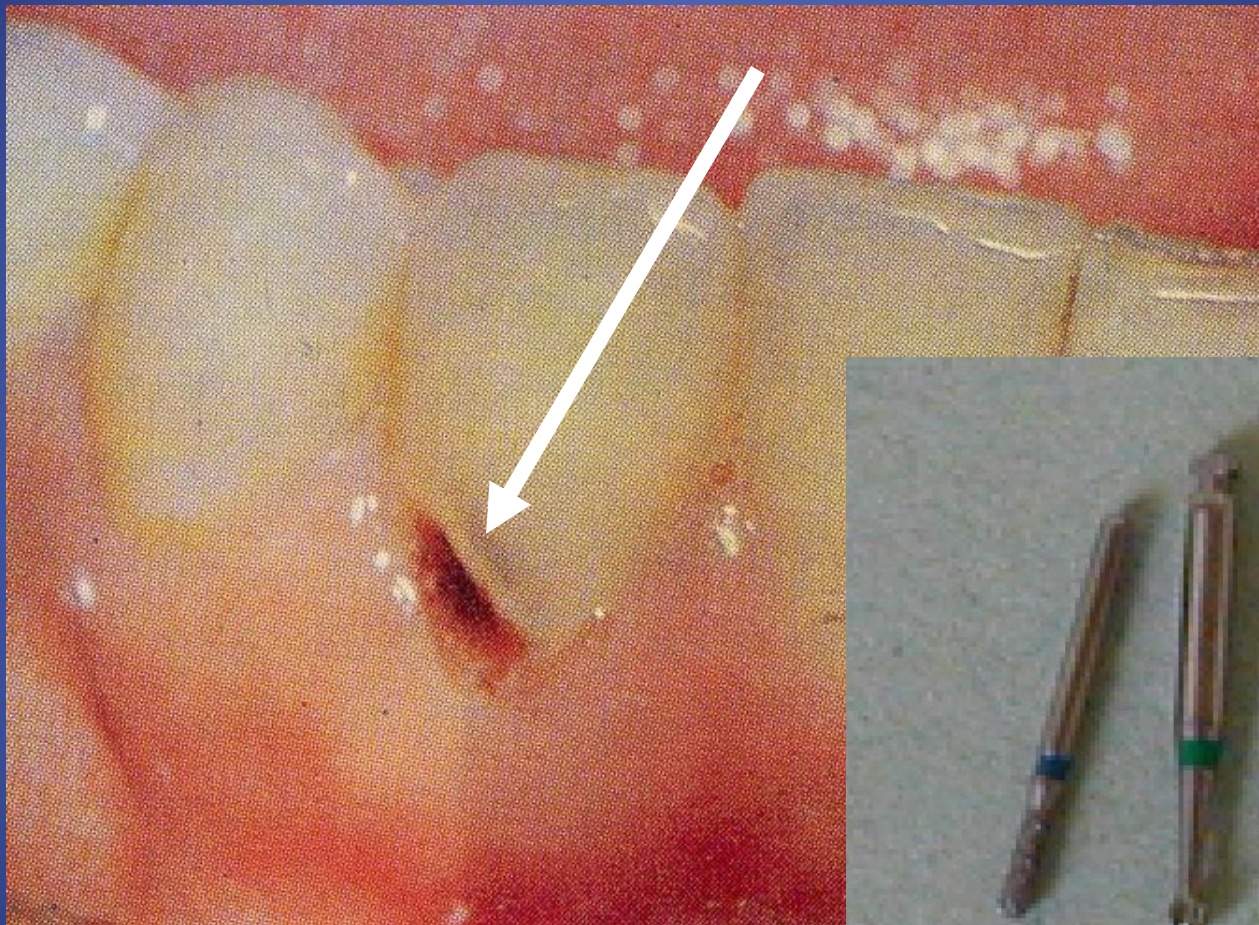



Separace klínkem

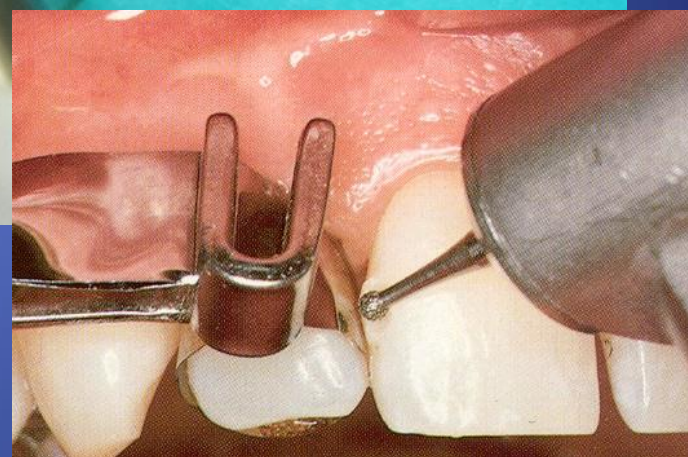

Odstranění staré výplně

Hazards with cutting instruments

Pulpal precautions

Soft tissue precautions

Eye precautions

Ear precautions

Inhalation precautions

Basic rules of preparation

- Extention for prevention
- Retention
- Resistance

Sequence of operations

Access to the cavity

Establishment of the cavosurface margin -
extention for prevention

Retention of the filling

Resistance of the restored tooth (the filling
as well as the restoration)

Excavation of carious dentin

Protection of dentin wound

Finishing of the walls

Final control (light, mirror, magnification)

Sequence of operations

Access to the cavity

Preparation through the hard dental tissues

Removal the undermined enamel

Separation of teeth

Separation or removal of gingiva







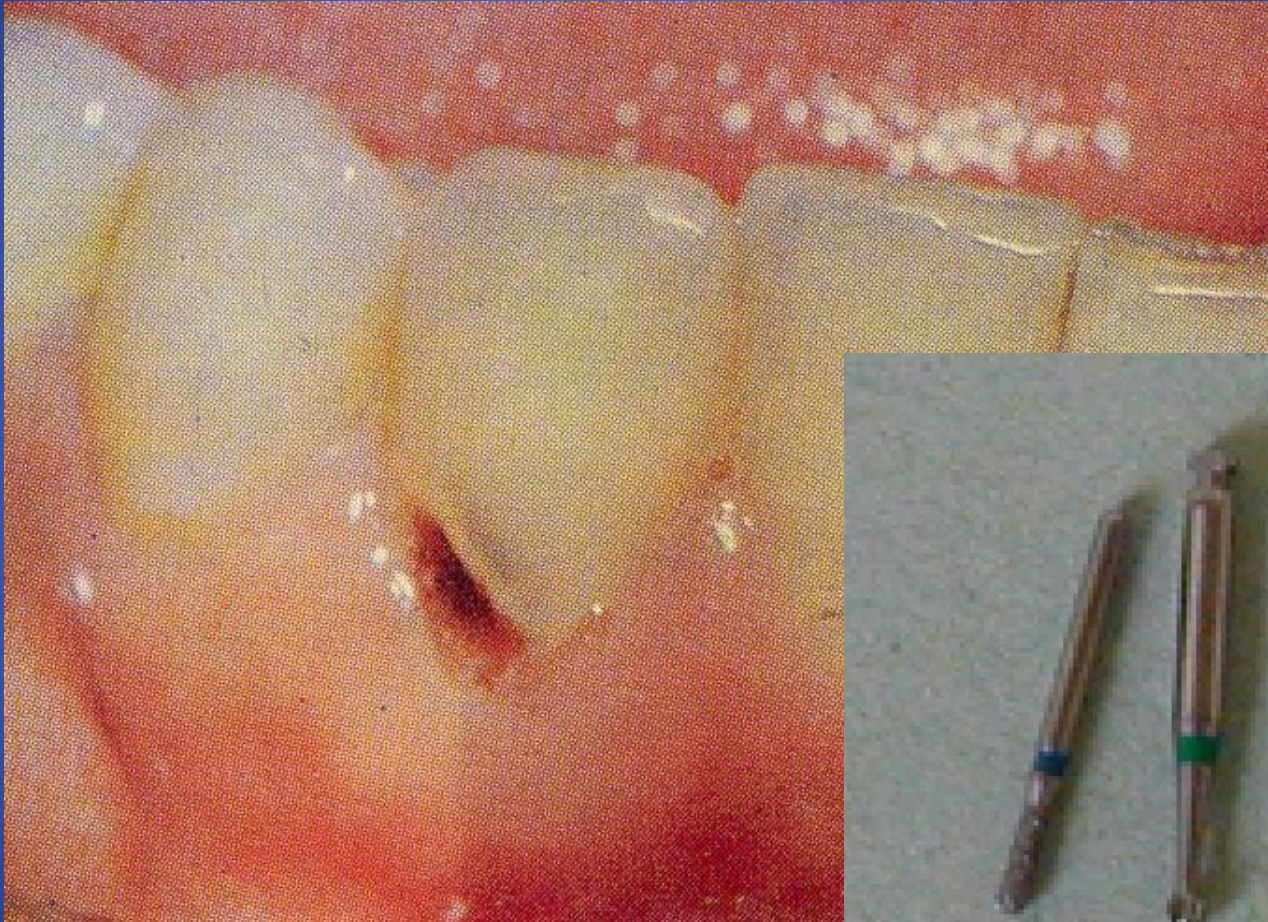

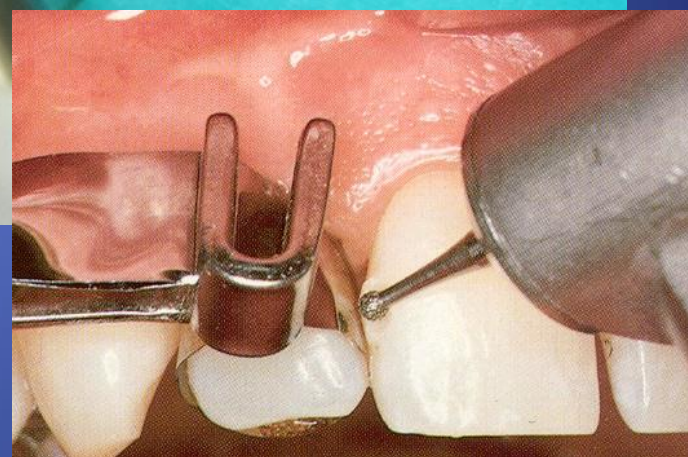

Odstranění staré výplně

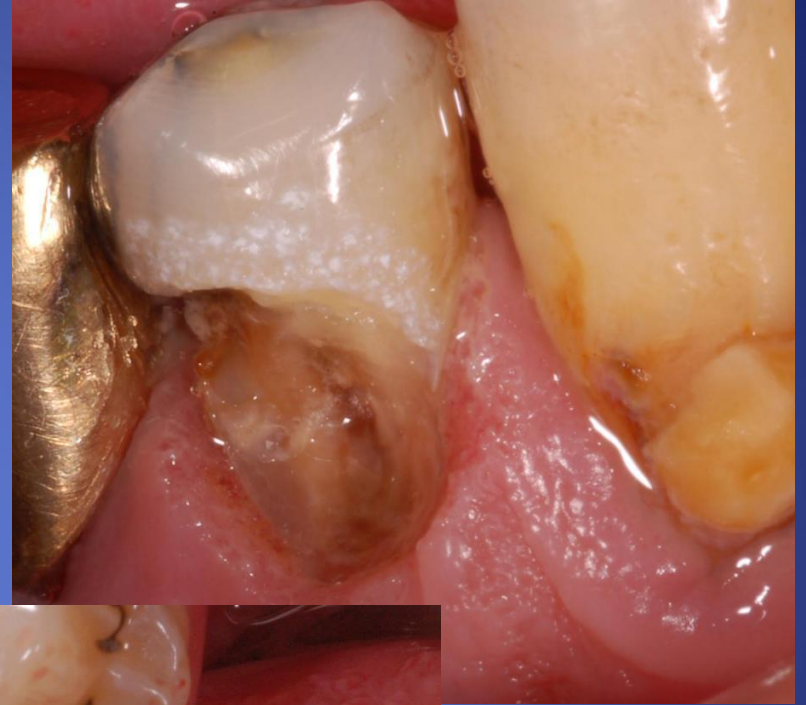
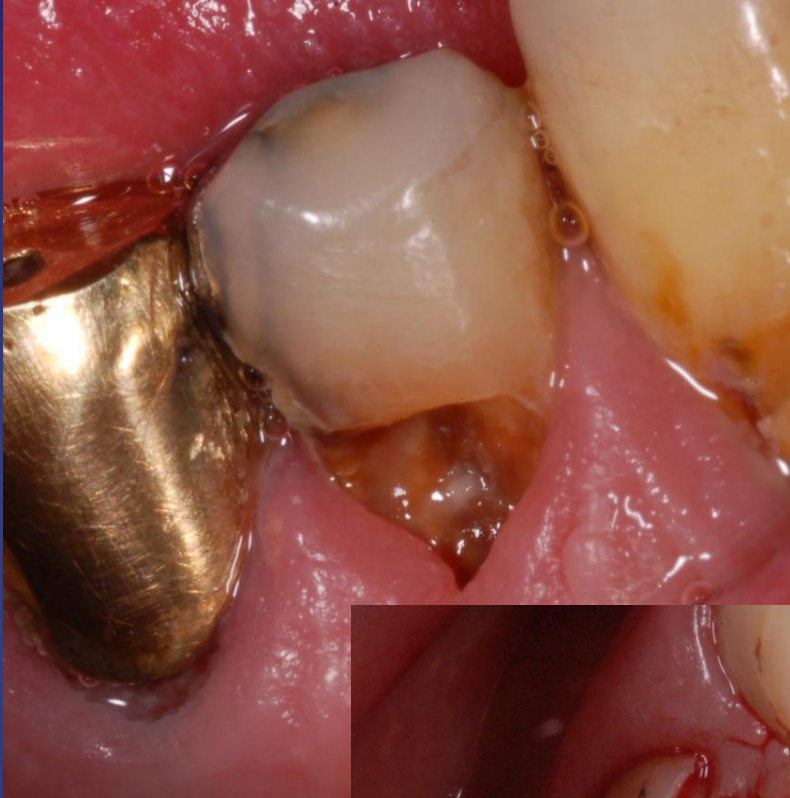

Sequence of operations

Preparation of cavity borders and extention
for prevention (Cavosurface margin)

Depends on

Dental material

Oral hygiene

Precautions of secondary caries

Sequence of operations

Retention of the filling

Precautions of its lost

Macromechanical retention

Micromechanical retention

Chemical retention

Sequence of operations

Resistance of the restored tooth

Against occlusal and other forces

Depends on

- *Material*
- *Individual occlusal forces*

Sequence of operations

Excavation of carious dentin

Necessary (risk of recurrent caries)

Ball shaped (spheric) bur - slow speed (3000 rpm)

or

Excavator (hand instrument)

Sequence of operations

Finishing of the walls

Depends on the kind of material

- *Bevel or without bevel*
- *Fine diamond bur*

Protection of dentin wound

- Filling itself
- Base (below the filling – protection against thermal exposure or toxicity of dental materials)

Sequence of operations

Final control

Direct or indirect view

Good illumination

Magnification

Preparation

- Hand

Excavator, cleaver

- Power driven

- Rotary

- Non standard preparation

Burs, diamonds

Chisel – for enamel Cleaver



Chisel for enamel



Excavator



Motors and handpieces



Turbine

Micromotor

Handpiece

Turbine



Turbine

300.000 - 400.000 rpm

Big force, les control, small torque

Motors – micromotors

Electromotors – maximum 40.000/min

Air motors – maximum 20.000/min

Převody do rychla -

Převody do pomala

Bez převodu 1: 1

Blokování rotace

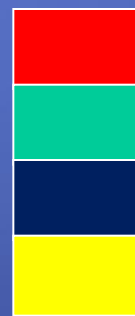

Gear



Blue coded handpiece 1:1

Gear



Red coded handpiece 1:5 to fast

Gear



Green coded handpiece – to slow

2,7 :1

7,5 :1

Hendpieces contraangle straight



Cutting instruments

Burs

Steel

Tungsten carbide

Diamonds

Cutting instruments

Power driven (powered) instruments for cutting

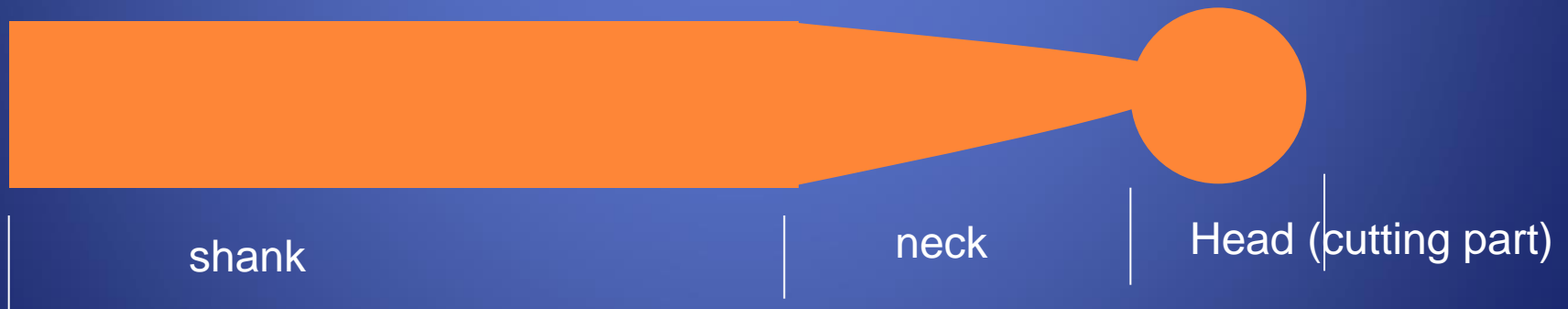

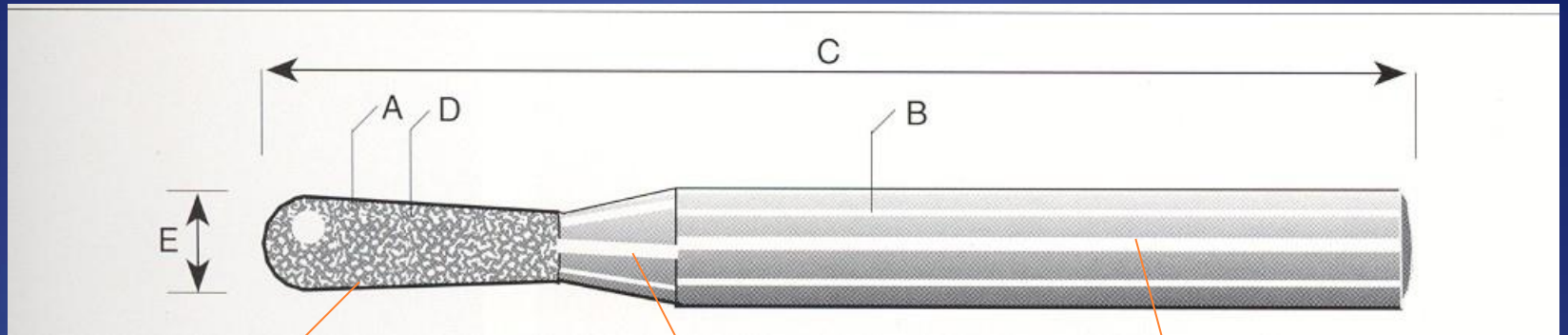

Head (cutting part)

neck

shank

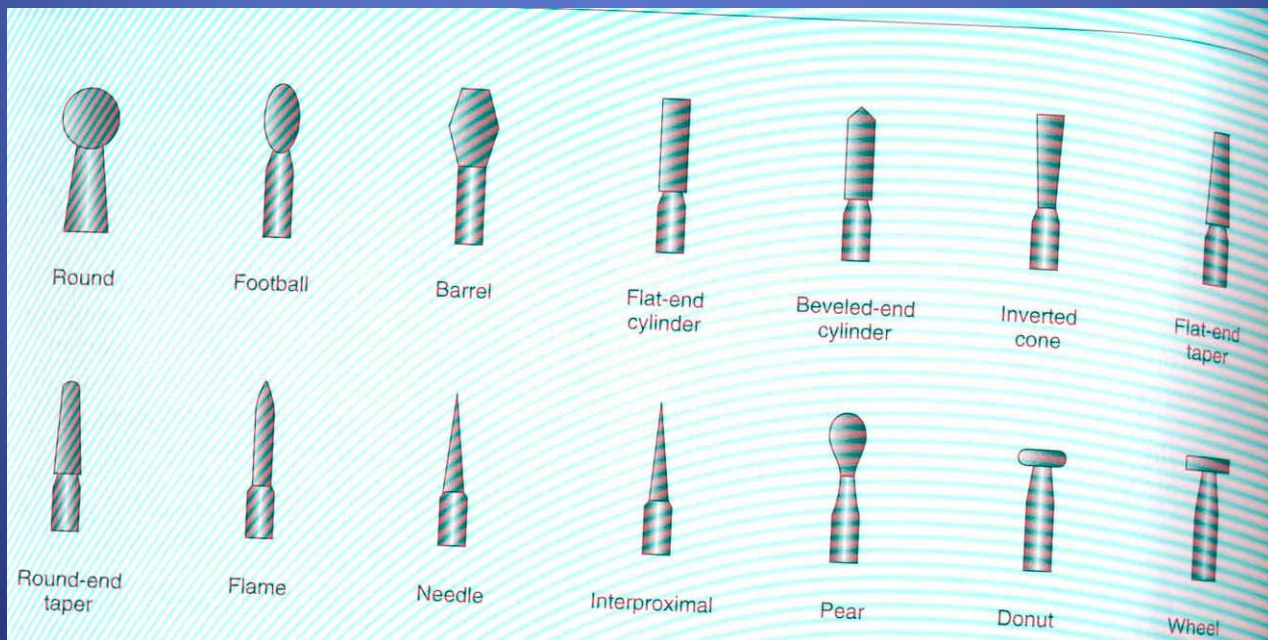

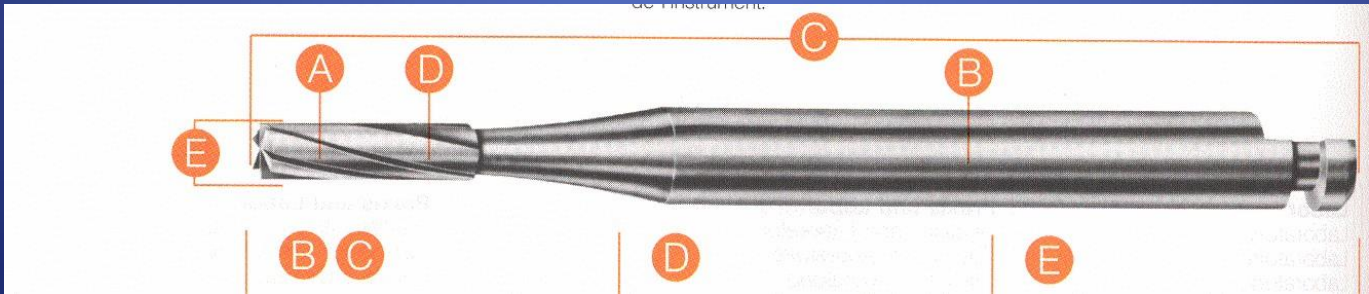
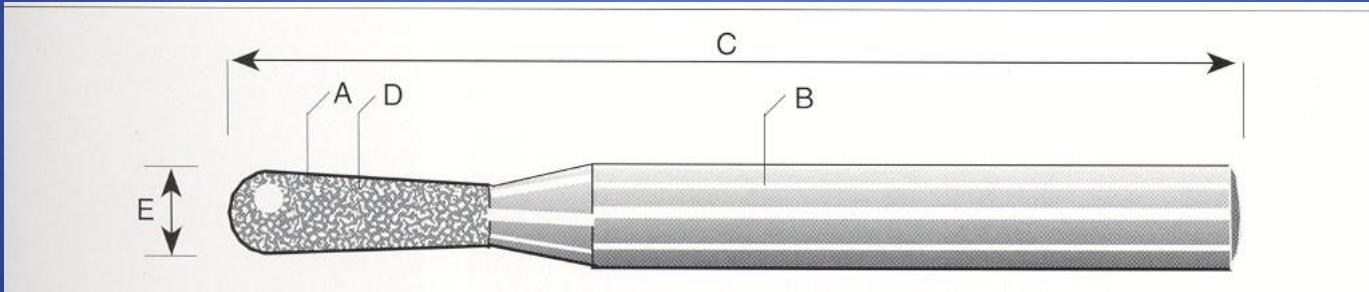

Burs

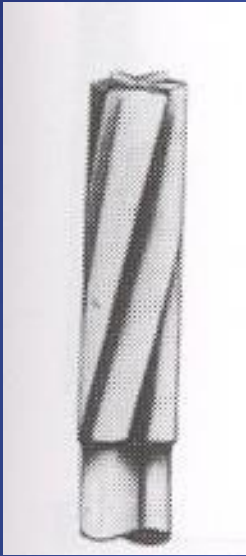

↑
fissure bur , round (ball) bur

↑
pear formed bur,,

↑
inverted cone bur

Cutting instruments – diamonds

Extra coarse – black

Coarse – green

Standard – blue or without any marker

Fine - red

Extra fine - yellow

Ultrafine - white

Cutting instruments – diamonds head shape

- Ball, pear, cylinder,taper,flame, torpedo, lens and others.....

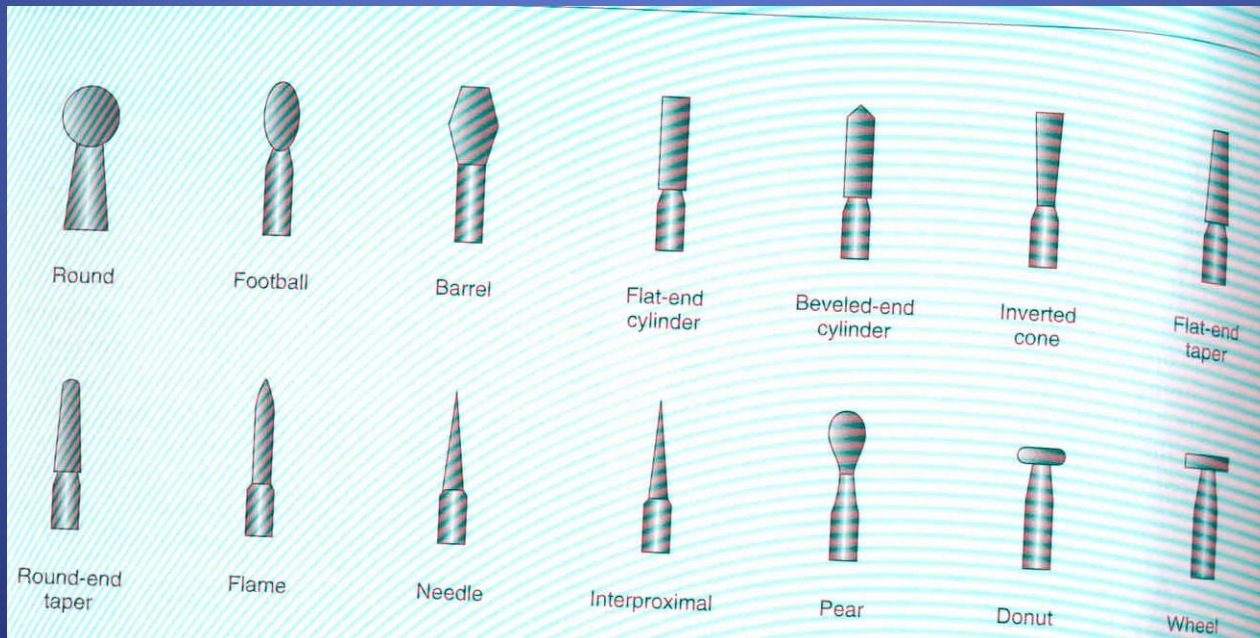

Diamonds

- Blue –standard (90 – 120 μm) ISO 524
Universal



Diamonds

- Extra coarse (150 – 180 μm) ISO 544
- Cutting of crowns, old fillings



Diamonds

- Removal of old fillings, some preparations in prosthetic



Diamantované brousky

- Red fine (20 – 40 μm) ISO 514
- Finishing of borders of cavities

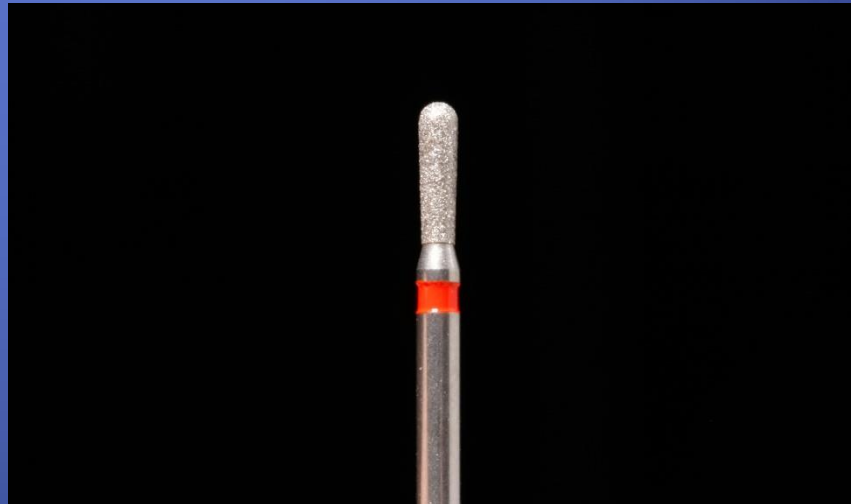

Diamonds

- Extrafine (12 – 22 μm) ISO 504, finishing of composite fillings

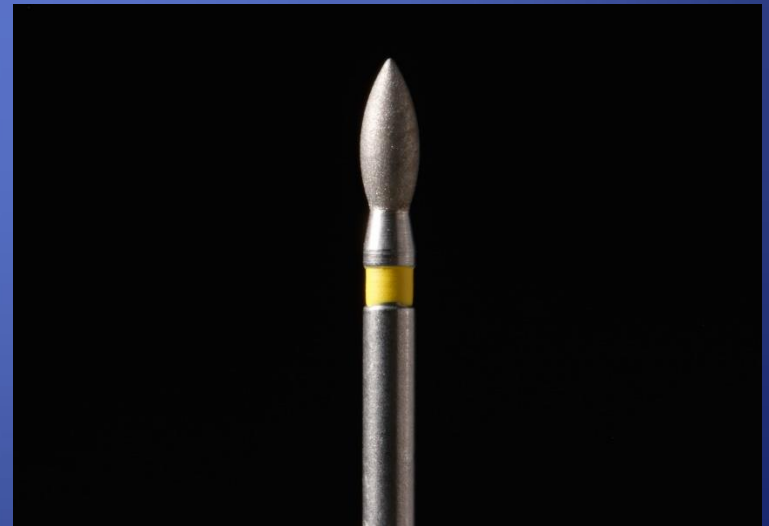

Diamonds

Ultrafine – polishing of composite fillings (6-12 μm) ISO 494

