

Adrenal glands. Stress.

MUNI
MED

Adrenal glands

Adrenal cortex - Steroid hormones

- Glucocorticoids
- Mineralocorticoids
- Androgens

Adrenal medulla

- Catecholamines
 - Epinephrine (adrenaline)
 - Norepinephrine (noradrenaline)
 - Dopamine

Corticomedullary portal system

Function

- Stress response
- Na⁺, K⁺, ECT
- Blood pressure

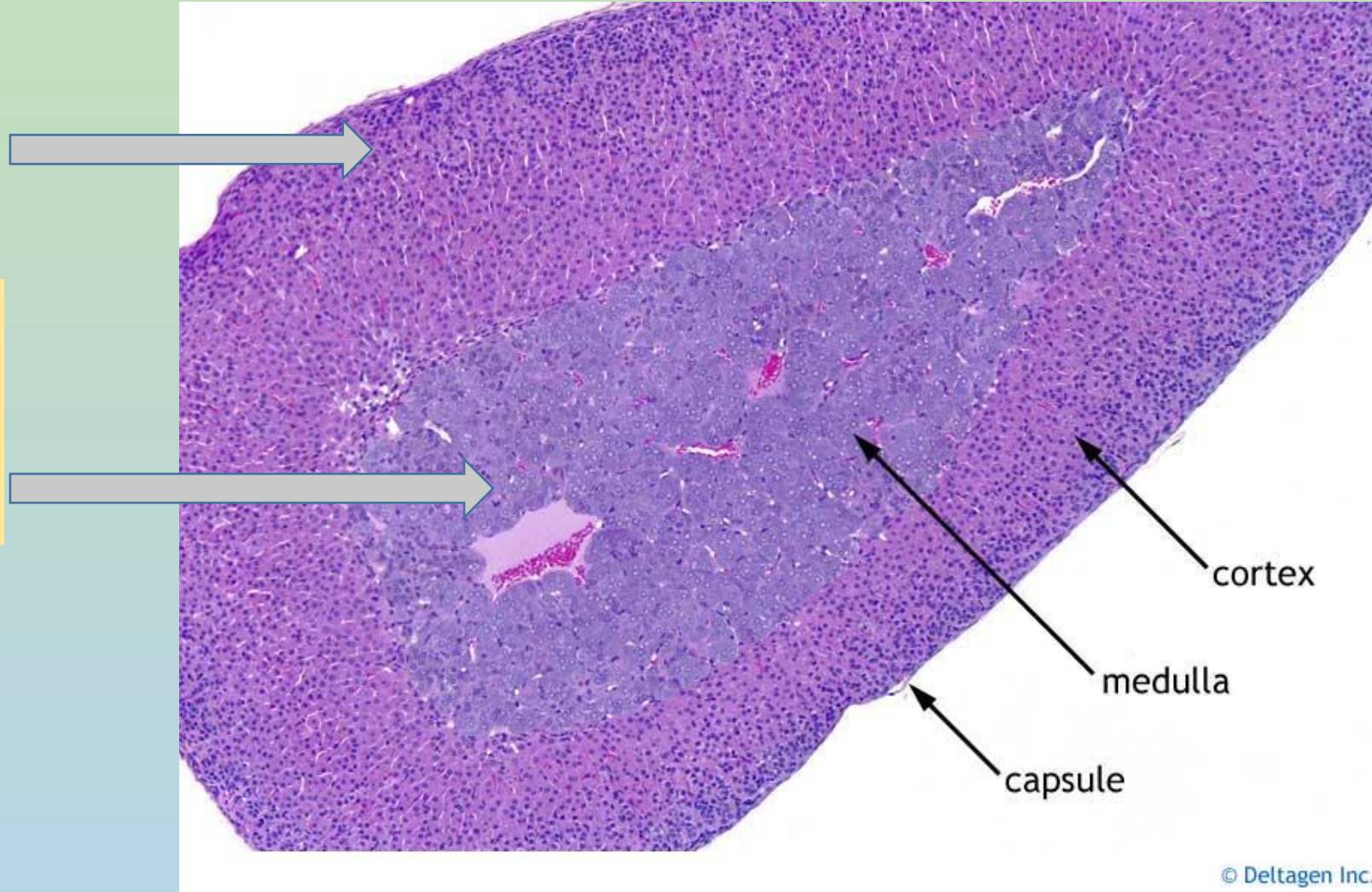

Fetal adrenal gland development

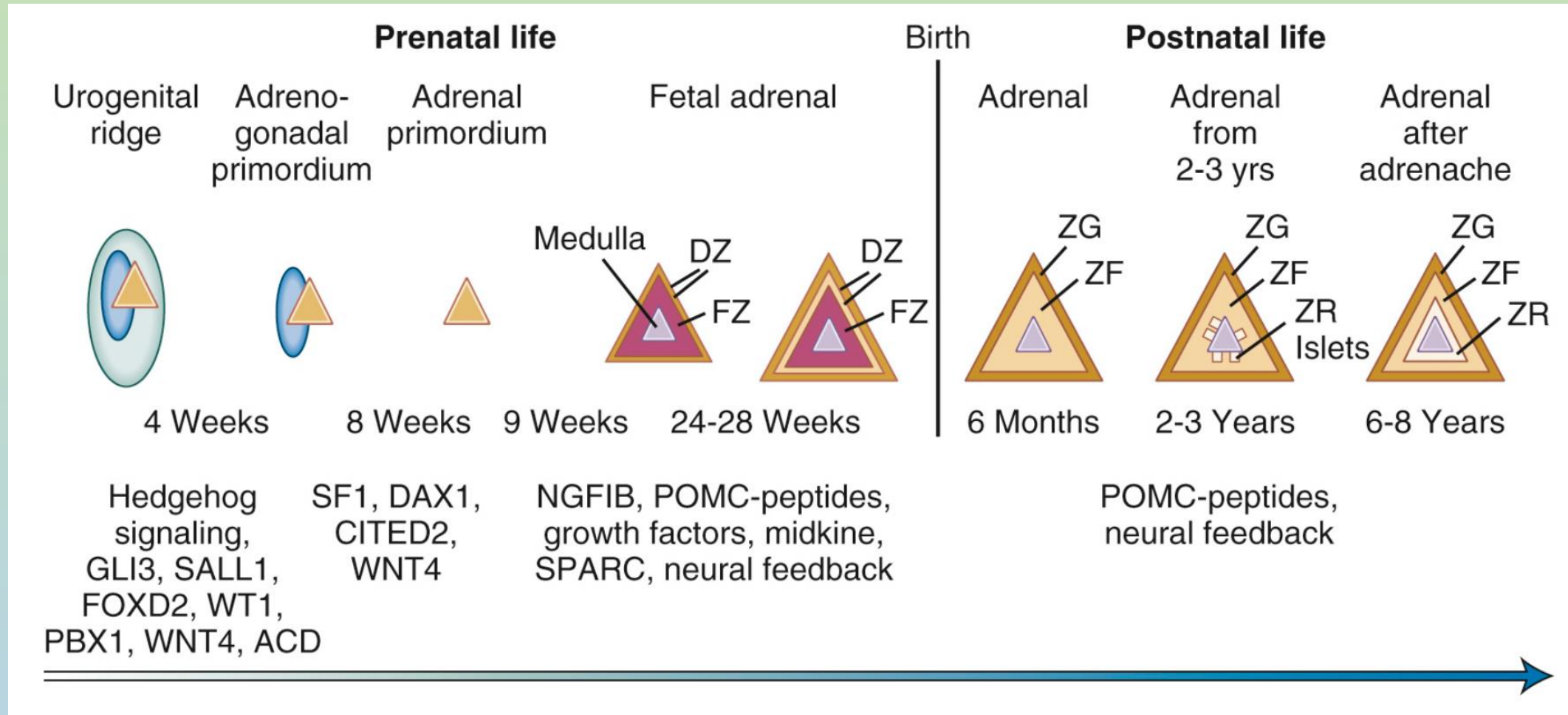

During second trimester the inner fetal zone grows bigger and produces high amount of DHEA and DHEAS.

Fetal adrenal gland and its importance

- Placental CRH stimulates production of DHEA, corresponding sulphate and cortisol in fetal adrenal gl.
- DHEA/DHEAS is in placenta converted to estrogen (preparation and promotion of birth)
- Cortisol upregulates ACTHR, but also prostaglandin and uterotonics in placenta (birth)
- Cortisol is necessary for maturation of fetal lungs
- Progesterone inhibits placental CRH

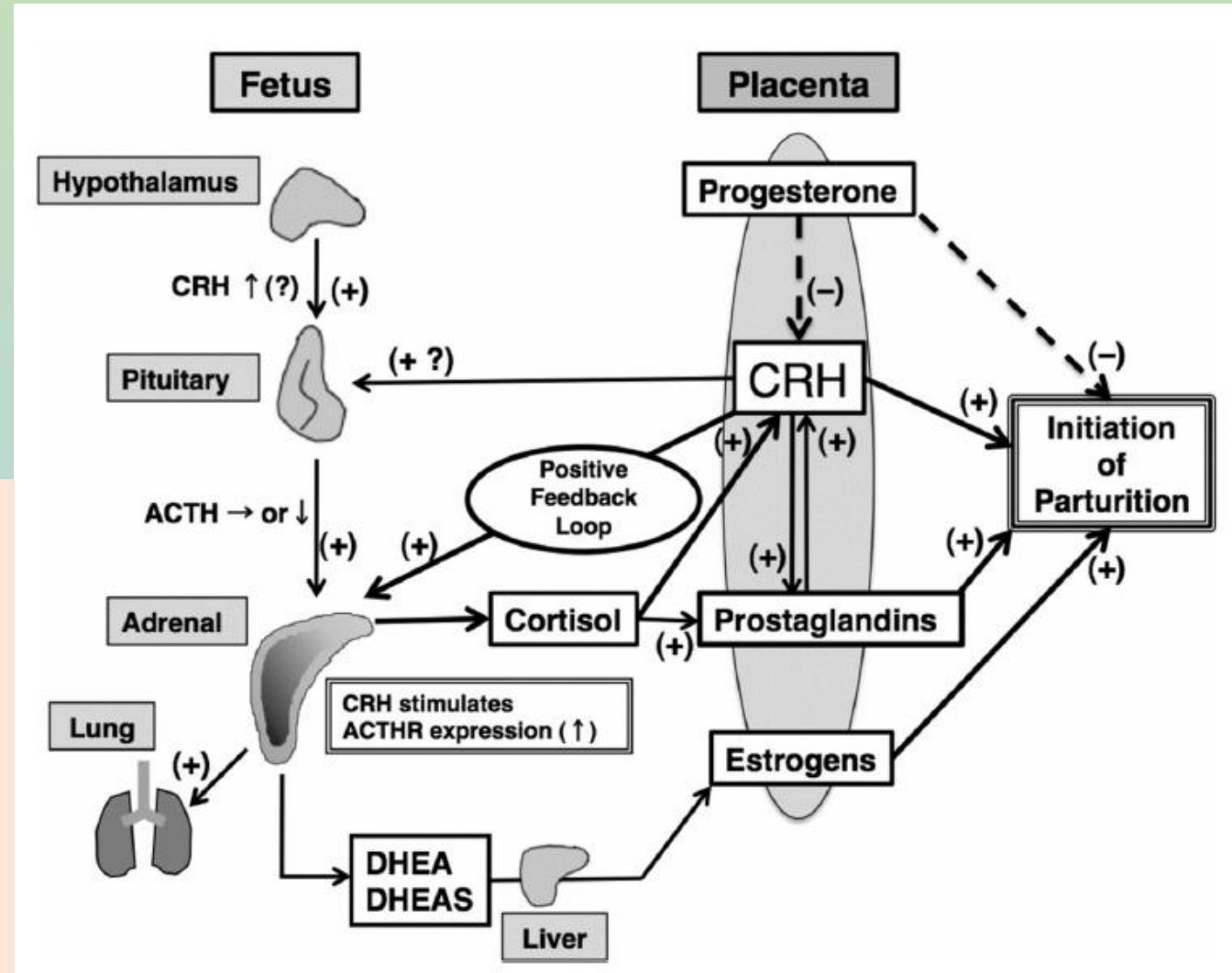

Adrenal gland hormones

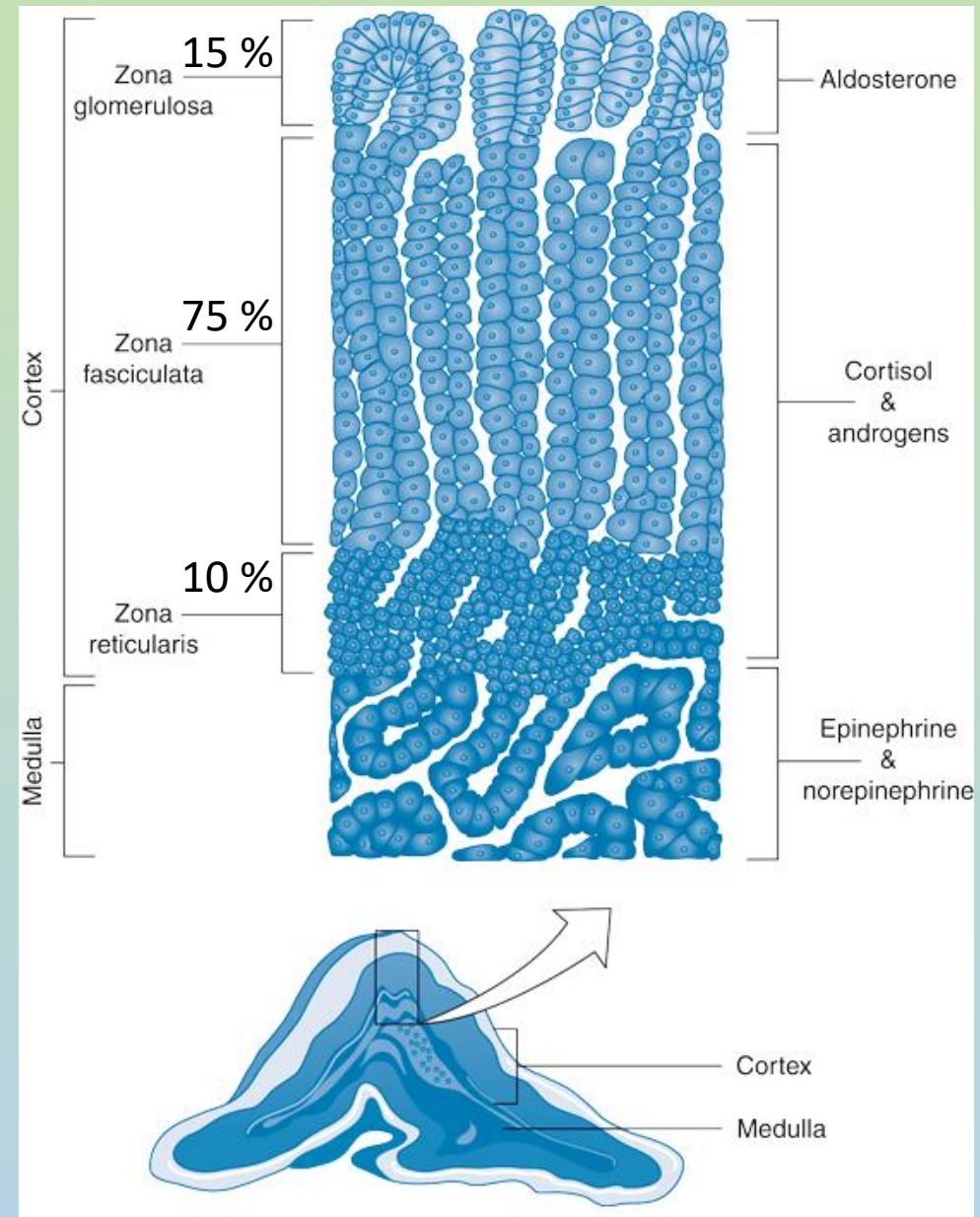
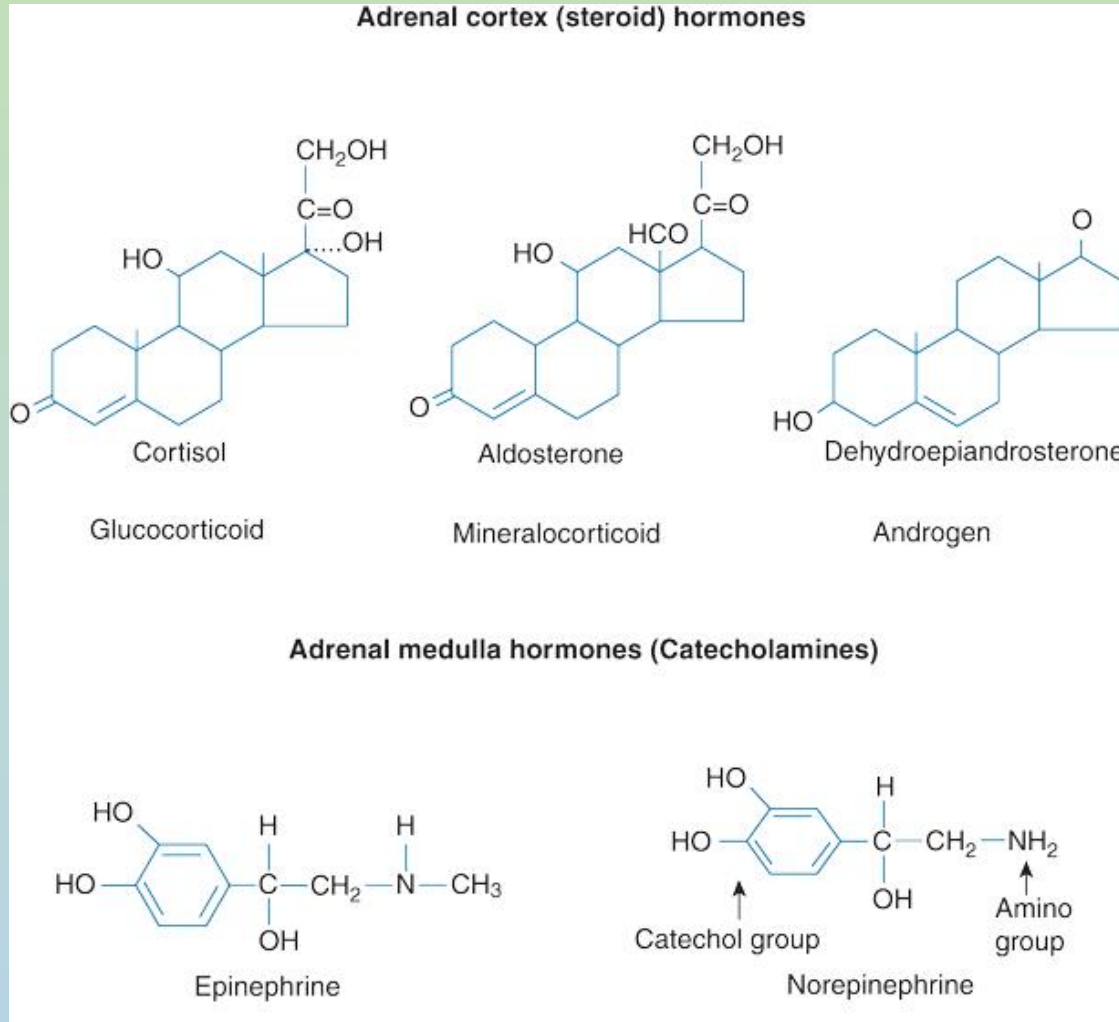

ER ←

← Lipid droplets

Functional architecture of adrenal gland allows transport of steroid hormones into medulla and influences activity of enzymes connected to catecholamine synthesis.

Adrenal medulla

Adrenaline secreting cells
(90 %)

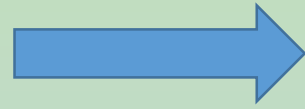

Noradrenaline secreting cells
(10 %)

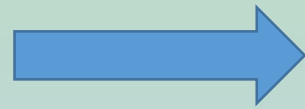

Dopamine secreting cells
(?)

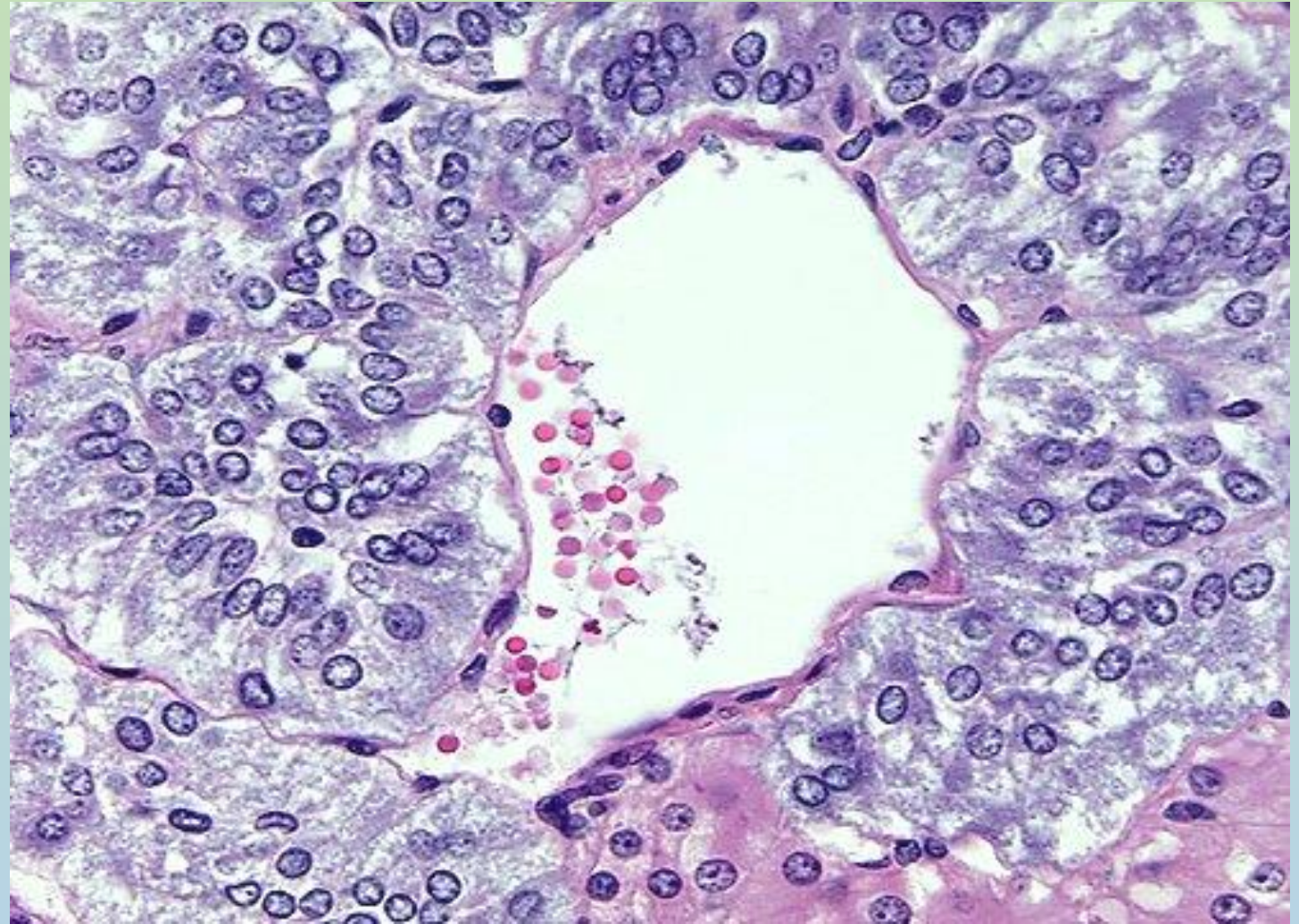
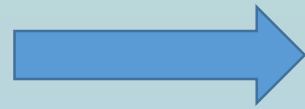

Secretory vesicles contain apart from catecholamines also ATP, neuropeptides – adrenomedullin, ACTH, VIP, calcium, magnesium and chromogranines.

Medulla - NA

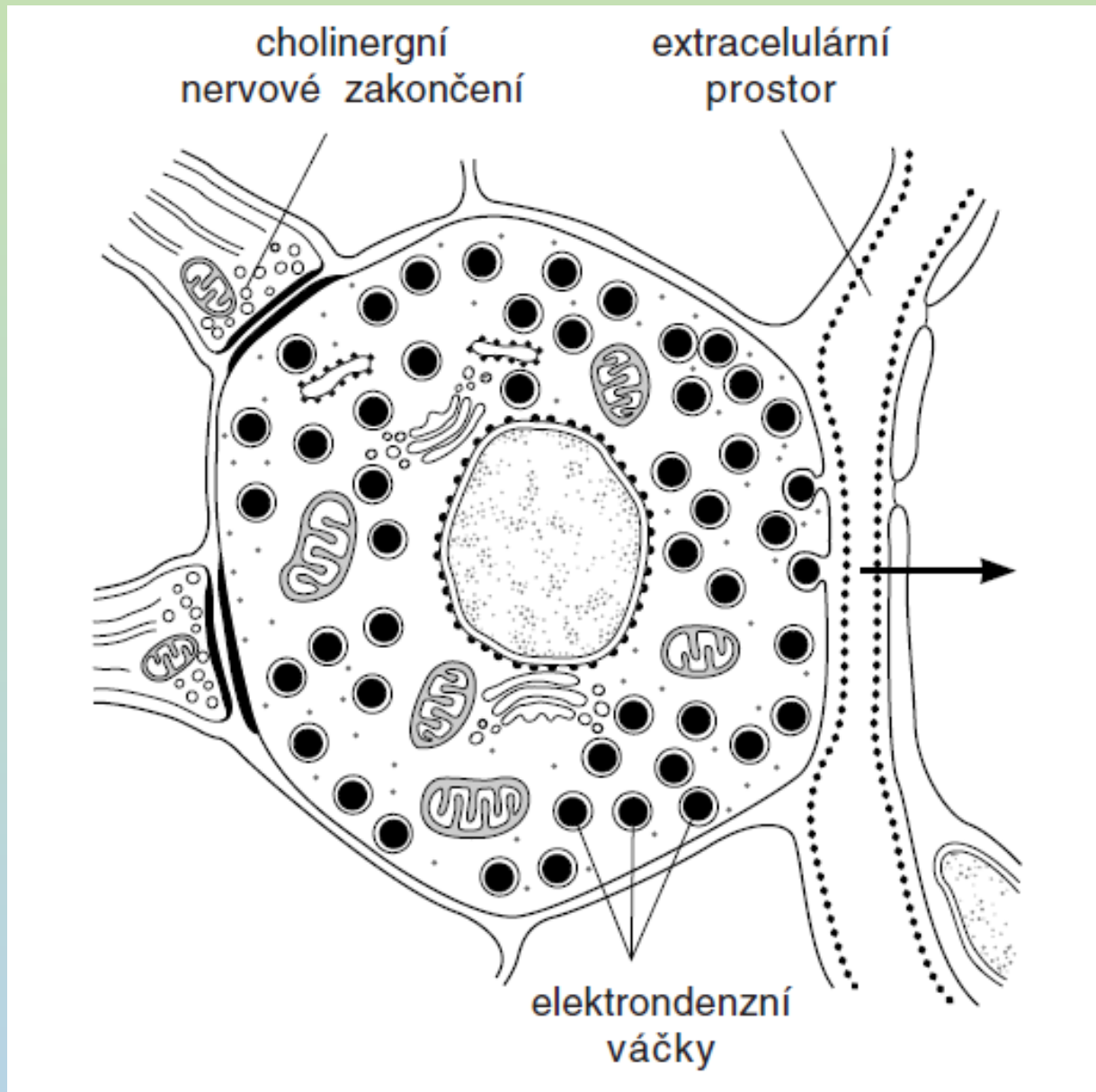

Cortex

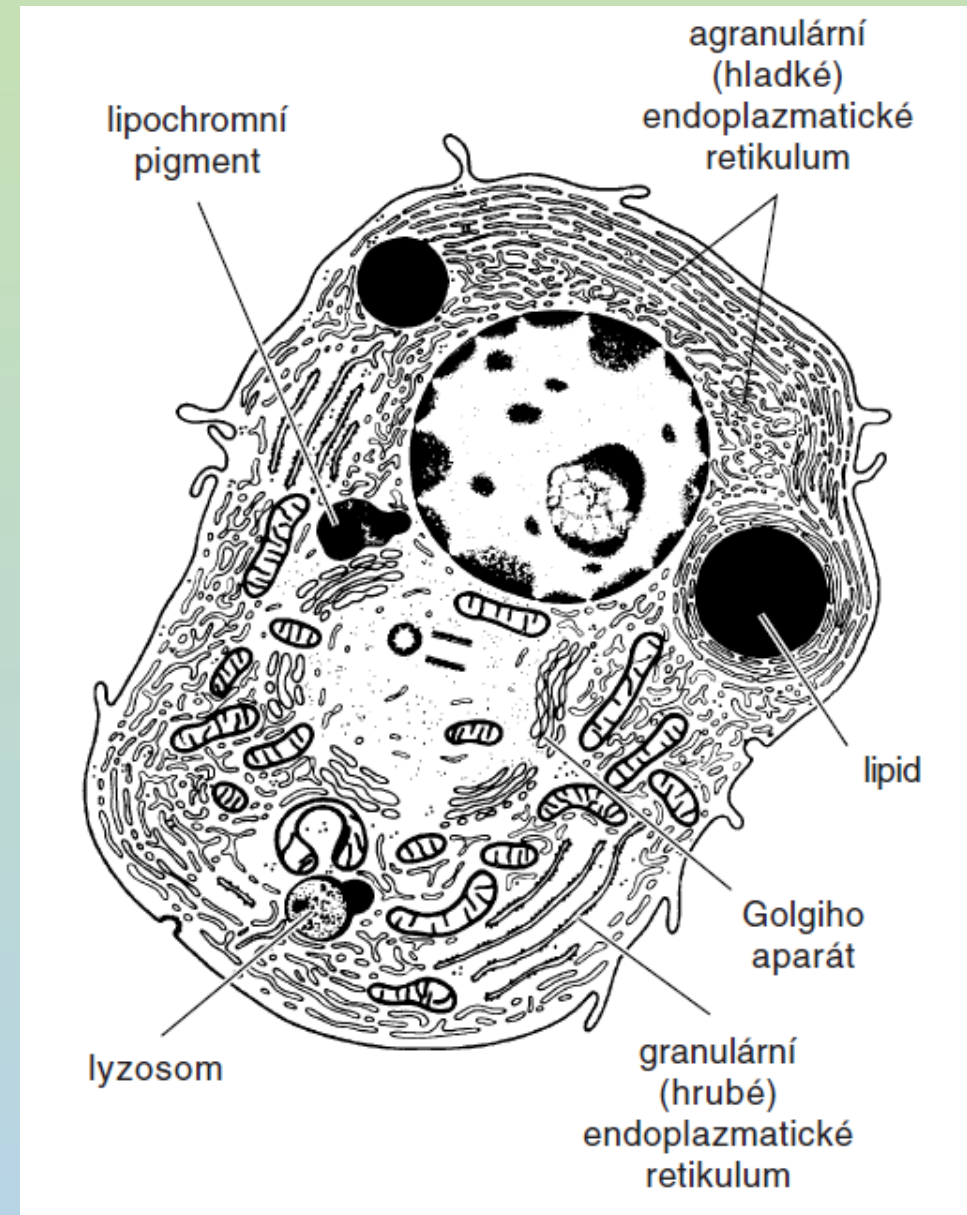

Adrenal medulla

Preganglionic sympathetic neurones

acetylcholine

Sympathetic nervous ganglion – medulla

Cholinergic receptors of chromaffin cells
(feochromocytes)

Catecholamines release

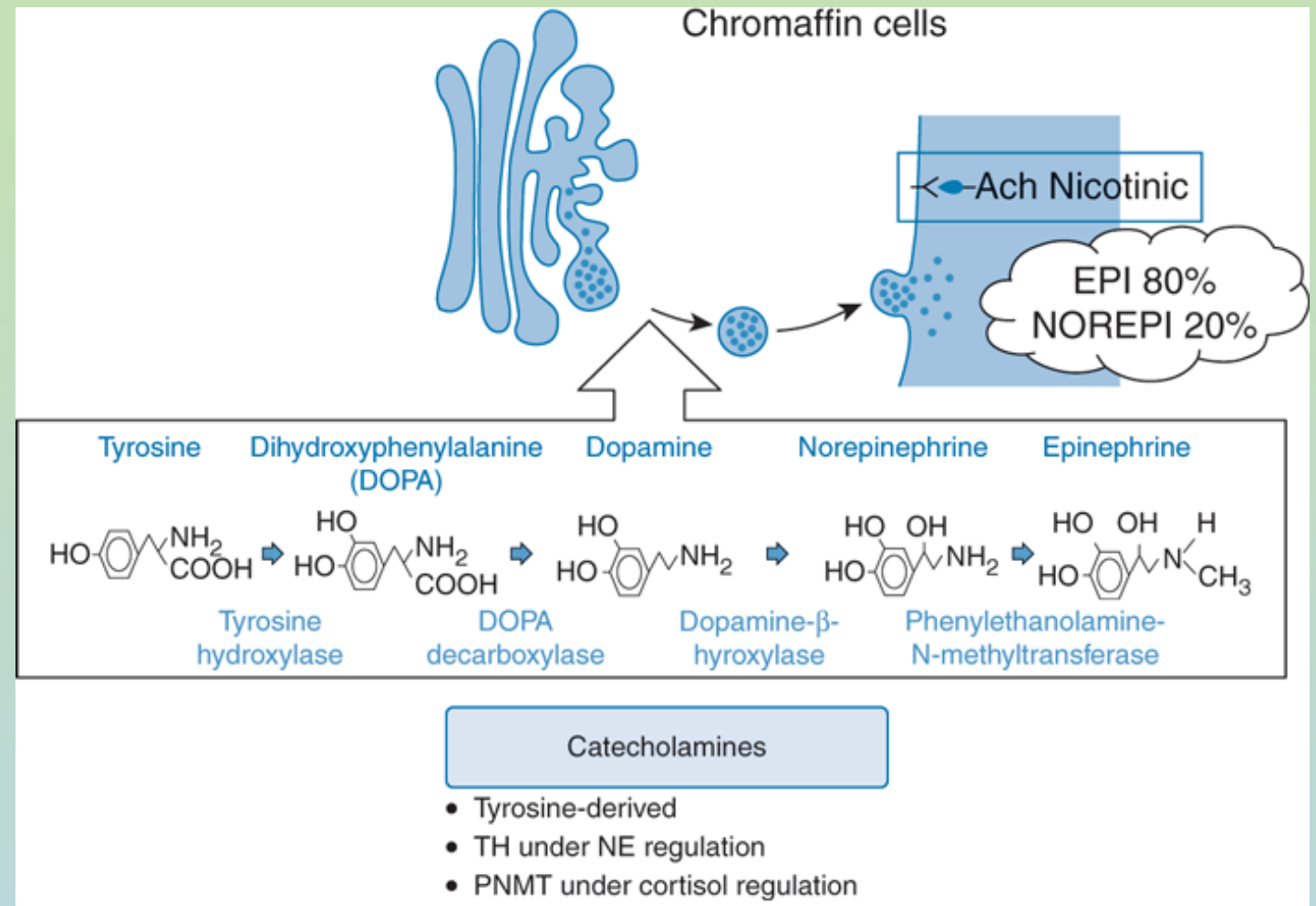

Catecholamine synthesis is regulated by negative feedback loop through effect of noradrenaline.

Adrenaline synthesis is influenced by steroid hormone production in adrenal cortex.

Noradrenaline conversion takes place in cytoplasm. It is then transported into vesicles by ATP-controlled transport (monoamine transporter VMAT1).

Catecholamines secretion

Is determined by direct sympathetic stimulation:

1. Binding of Ach on nicotinic cholinergic receptors (ligand-gated ion channels)
2. Rapid Na^+ influx and depolarization
3. Activation of voltage-gated Ca^{2+} ion channels
4. Influx of Ca^{2+} ions
5. Secretory vesicles associated with voltage-gated Ca^{2+} ion channels
6. Exocytosis – intersticium
7. Modulation of NA release by NA itself through α_2 -AR (inhibition)
8. Transport to target organs

Constitutive secretion

- Spontaneous
- Ca^{2+} independent

Regulated secretion

- Ca^{2+} dependent
- Complex system of sorting and „packaging“

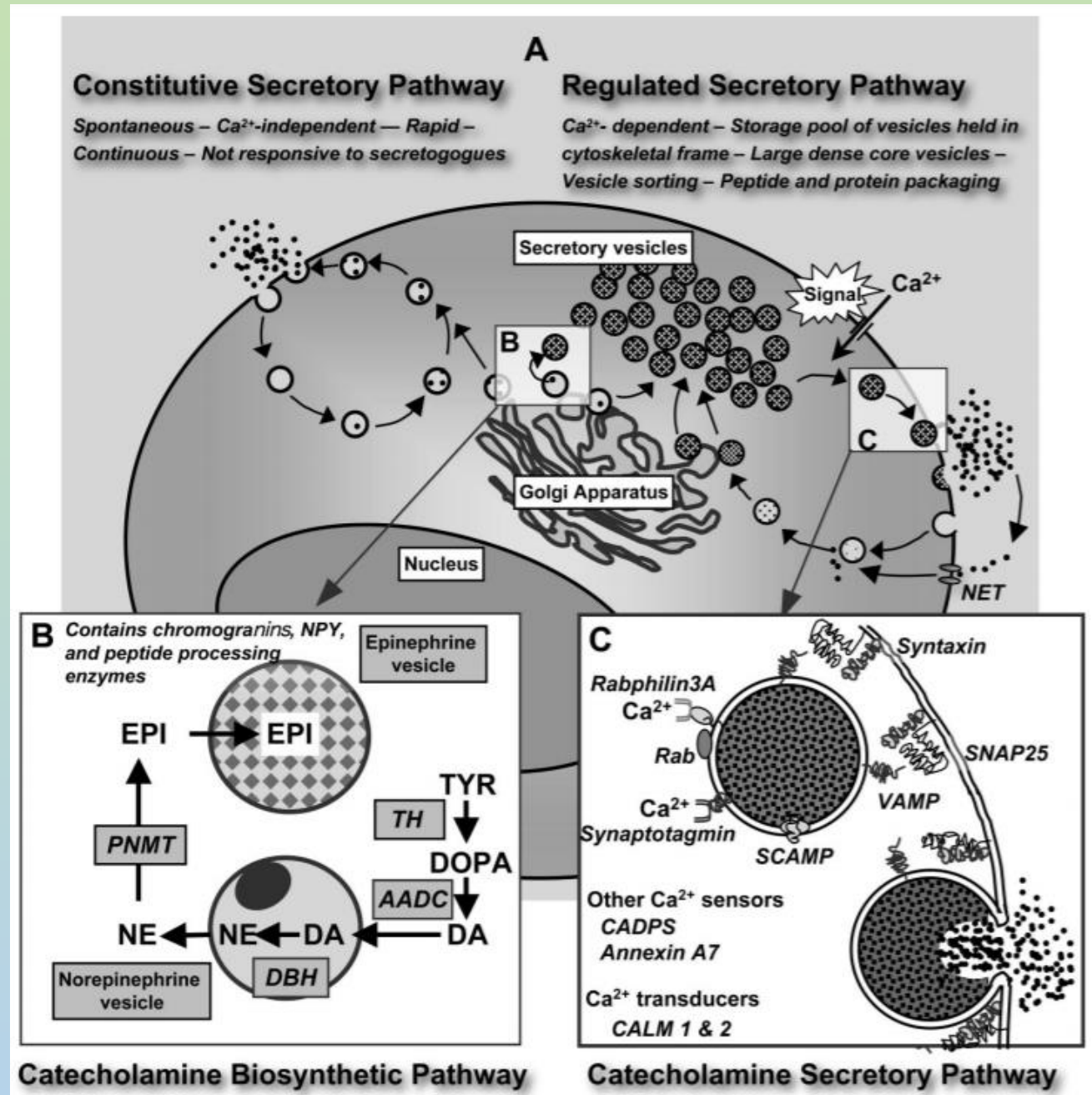

Transport and metabolism of catecholamines

- Very short half-life in circulation (cca 2 min)
- Binds to albumin (50 %) with very low affinity
- Reuptake (up to 90 % - nerve endings, 10 % uptake extraneuronal tissues) and degradation

- Catechol-O-methyltransferase (COMT) – metadrenaline, normetadrenaline
- Monoaminoxidase (MAO) – deamination
- Aldehyde dehydrogenase
- Direct filtration (kidneys)

- Final degradation product is vanillylmandelic acid (A, NA) and homovanillic acid (DOP)

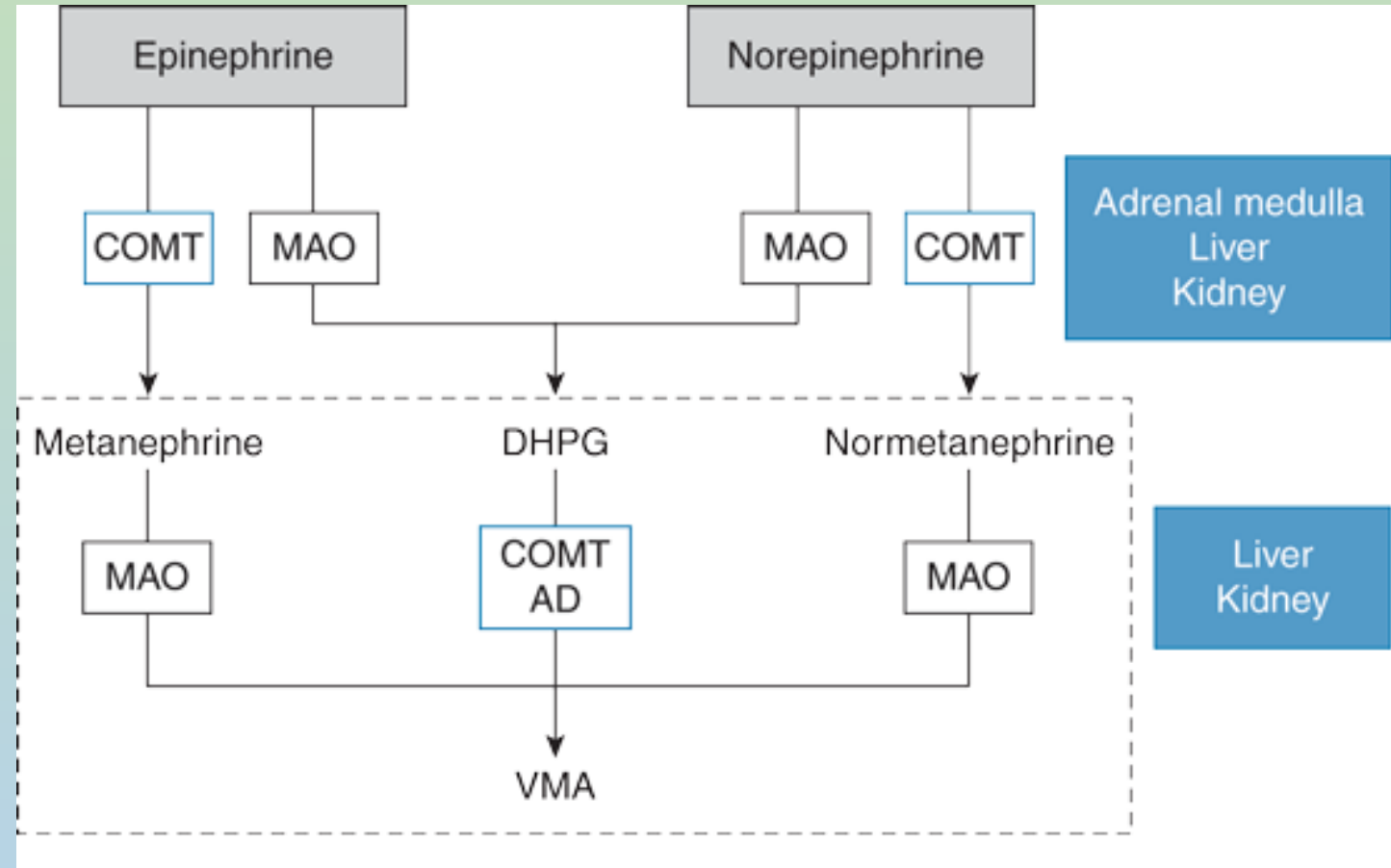

Physiological effects of catecholamines

Adrenergic receptor	G protein	Secondary messenger	Ligand
α 1-adrenergic α 1A, α 1B, α 1D	Mainly $G_{Q/11}$	Activation of PLC α , PKC, increased concentration of intracellular Ca^{2+} ions	Noradrenaline > adrenaline >> (isoprenaline)
α 2-adrenergic α 2A, α 2B, α 2C	Mainly G_{α_i} and G_0	Decreased activity of AC (antagonistic effect to β -AR). Activation of K^+ ICH, inhibition of Ca^{2+} ICH. Activation of PLC β or PLA $_2$.	adrenaline = noradrenaline >> isoprenalin
β 1-adrenergic	G_{α_s}	Activation of AC and increased cAMP concentration	Isoprenalin > adrenaline = noradrenaline
β 2-adrenergic	G_{α_s}	Activation of AC and increased cAMP concentration	Isoprenalin > adrenaline >> noradrenaline
β 3-adrenergic	G_{α_s}	Activation of AC and increased cAMP concentration	Isoprenalin = noradrenaline > adrenaline
D1 family D1, D5	G_{α_s} G_{Olf}	Activation of AC and increased cAMP concentration	dopamine
D2 family D2, D3, D4	G_{α_i}	Inhibition of AC and decreased cAMP concentration	dopamine

Physiological effects of catecholamines are mediated through G-protein-coupled adrenergic receptors. Catecholamines from adrenal medulla cannot cross HEB and affect peripheral tissues.

Main effects of catecholamines - overview

Clinical relevance

- Antagonistic effect of various α_2 AR subtypes
 - A – decreased blood pressure
 - B – increased blood pressure (vasoconstriction)
- Wide use of agonists and antagonists in clinical practice:
 - Cardiology
 - Ophthalmology
 - Internal medicine

Mediated by α -AR	Mediated by β -AR
Vasoconstriction	Vasodilatation
(+) inotropy	(+) chronotropy
Smooth muscle relaxation (GIT)	(+) dromotropy
Sphincter contraction (GIT)	(+) inotropy
Mydriasis	Smooth muscle relaxation (GIT)
Stimulation of saliva and tear secretion	Musculus detrusor relaxation
Bronchoconstriction	Bronchodilatation
Ejaculation	Calorigenesis, thermogenesis
Gluconeogenesis (liver)	Glycogenolysis
(-) insulin secretion	Lipolysis
Thrombocytes aggregation	(+) renin secretion
(+) Na^+ reabsorption (kidneys)	(+) glucagon secretion
Pilomotor muscle contraction	Accommodation of distance vision

Physiological effects of catecholamines

Catecholamine secretion stimuli

- Sympathetic stimulation (generally)
- Stress response (physical, psychical stress)
- Bleeding and blood loss
- Hypoglycemia
- Trauma
- Surgery
- Fear
- „fight or flight“

Acute response to stress stimuli

- e.g. bronchodilatation, sphincter contraction, tachycardia, peripheral vasoconstriction and increased peripheral resistance, inhibition of motility (GIT)

Ensuring energy requirements

- Mobilisation of substrates – liver, muscles, adipose tissue
- Glycogenolysis, lipolysis
- Effect – increased glycemia, concentration of glycerol, FFA

Regulation of adrenergic receptors

- Chronic stimulation = changes in sensitivity (biological response) of target tissues
- **Desensitization of AR** (phosphorylation)
- **Internalization of AR**
- Upregulation:
 - Glucocorticoids
 - Thyroid hormones
 - Different upregulation of various AR receptors!

Biochemical aspects

- Monitoring of catecholamine secretion - urine

Clinical relevance

- Changes in target tissue sensitivity during chronic administration of agonists/antagonists
 - Chronic application of β -agonists – asthma
 - Chronic application of α -agonists – tachyphylaxis (intranasal decongestants)
- Feochromocytom

Dopamine

Functions of dopamine outside of CNS :

- Hormone, paracrine and autocrine factor
- Cannot cross HEB!
- Regulation of ECF volume and ion balance
 - increased GFR
 - natriuretic effect
- Immune function
 - (-) lymphocyte activation
- Endocrine pancreas
 - (-) insulin secretion
- Heart
 - (+) inotropy
 - (+) systolic blood pressure
 - (0) diastolic blood pressure

Clinical relevance

- i.v. application in newborns
- Treatment of acute kidney damage?
- Cardiogenic shock
- Septic shock

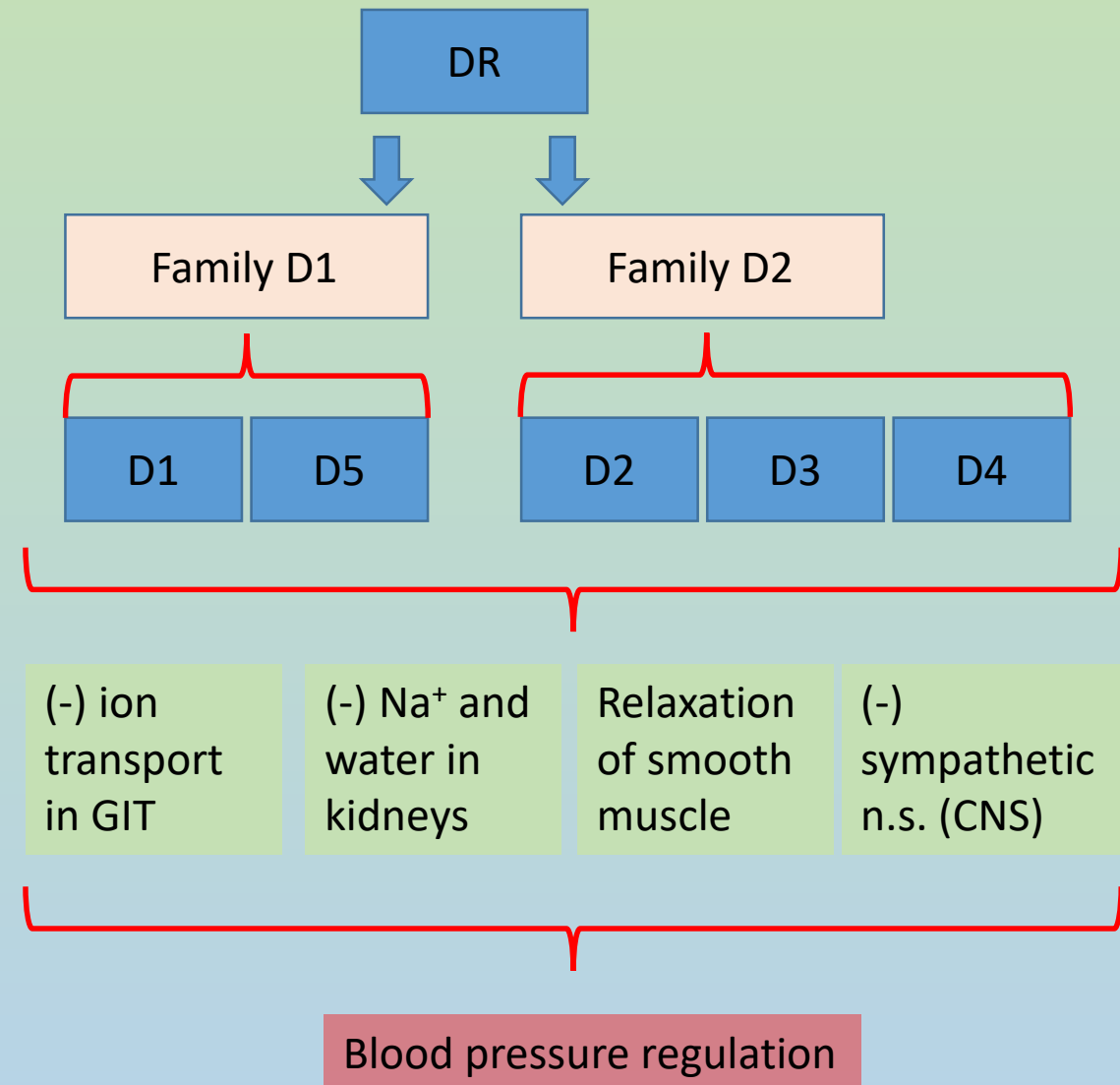

Chromogranin A

Characteristics

- Acidic glycoprotein
- Precursor protein for:
 - Vasostatin-1
 - Vasostatin-2
 - Pancreastatin
 - Catestatin
 - Parastatin
- Chromaffin cells of AM
- β -cells of pancreas
- Paraganglia
- ECL cells



Functions and relevance

- Cardioprotective effect (catecholamines)
- Autoantigen – DM1
- Hormone secreting CgA - marker

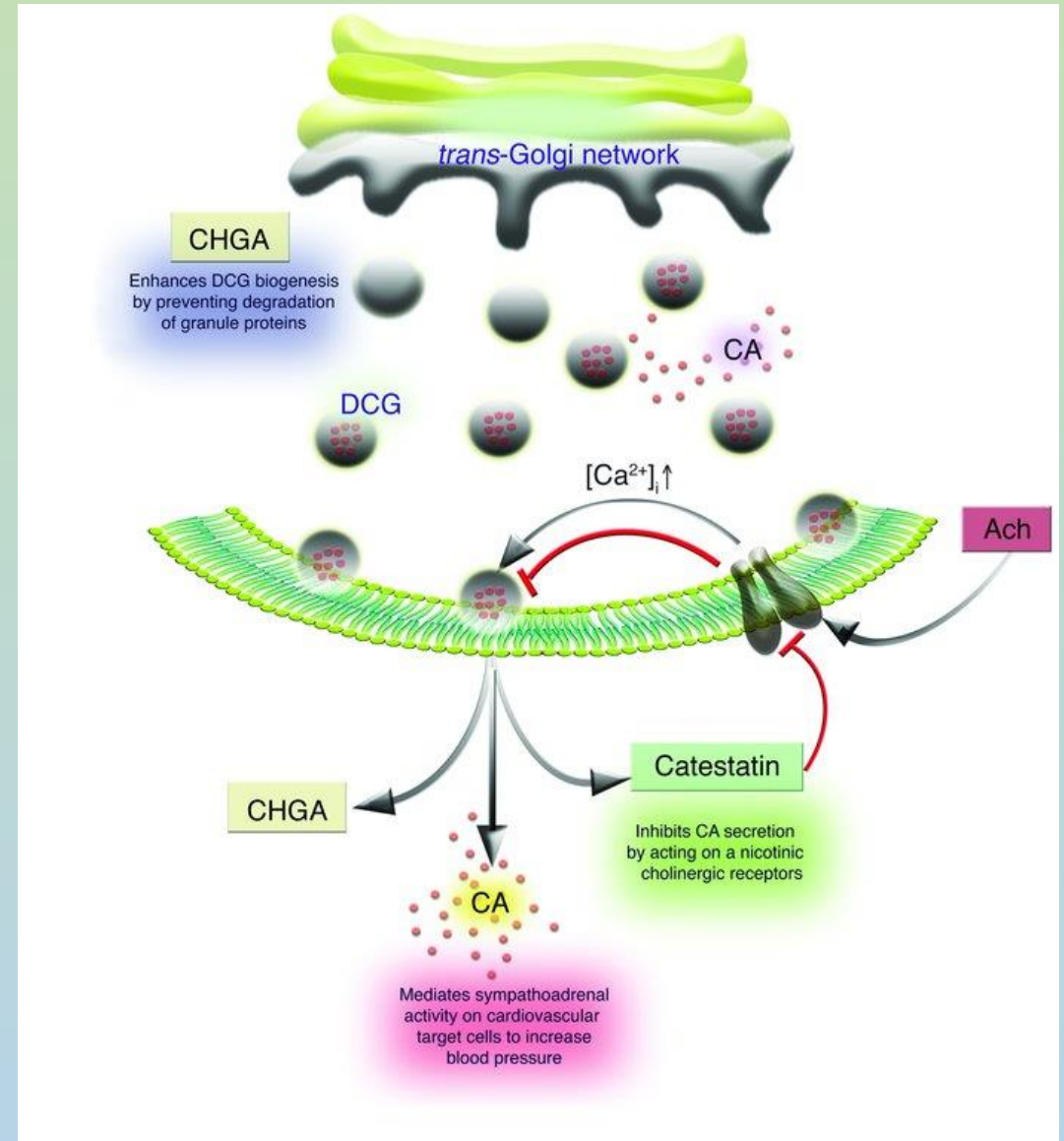

Adrenomedullin - AMD

Characteristics

- Hormone, neuromodulator, neurotransmitter
- Peptide (partial homology with CGRP)
- Receptors – combination of CALCR + RAMP2/3 – AM1/2
- Found in:
 - CNS
 - Blood vessels
 - Myocardium
 - Tumour tissue

Functions

- Vasodilatation (cAMP, NO)
- Cardioprotection
- Protection during oxidative stress
- Protection from hypoxic damage - angiogenesis

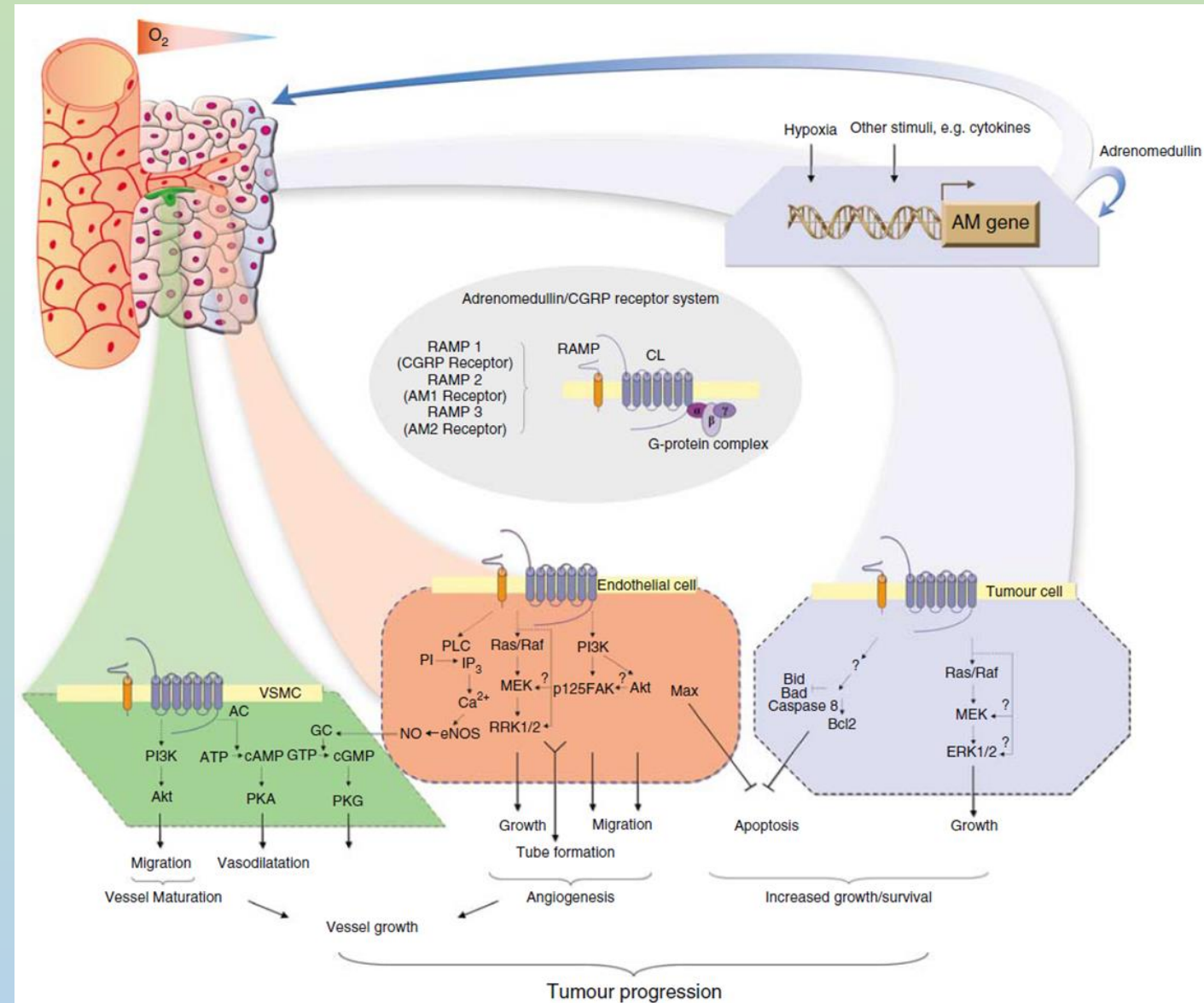

Hormones of adrenal cortex

Hormones of adrenal cortex = cholesterol derivatives

- C21 steroids with two carbon chain in position C17
 - Mineralocorticoids
 - Glucocorticoids
- C19 steroids with keto- or hydroxyl group in position C17
 - Androgens
- C18 steroids with 17-keto or hydroxyl group without angular methyl group in position C10

STAR (Steroid Acute Regulatory) proteins

- Transfer of cholesterol into inner mitochondrial membrane

Regulation of synthesis

- Acute (minutes) versus chronic

Source of cholesterol – cholesterol esters or plasma membrane

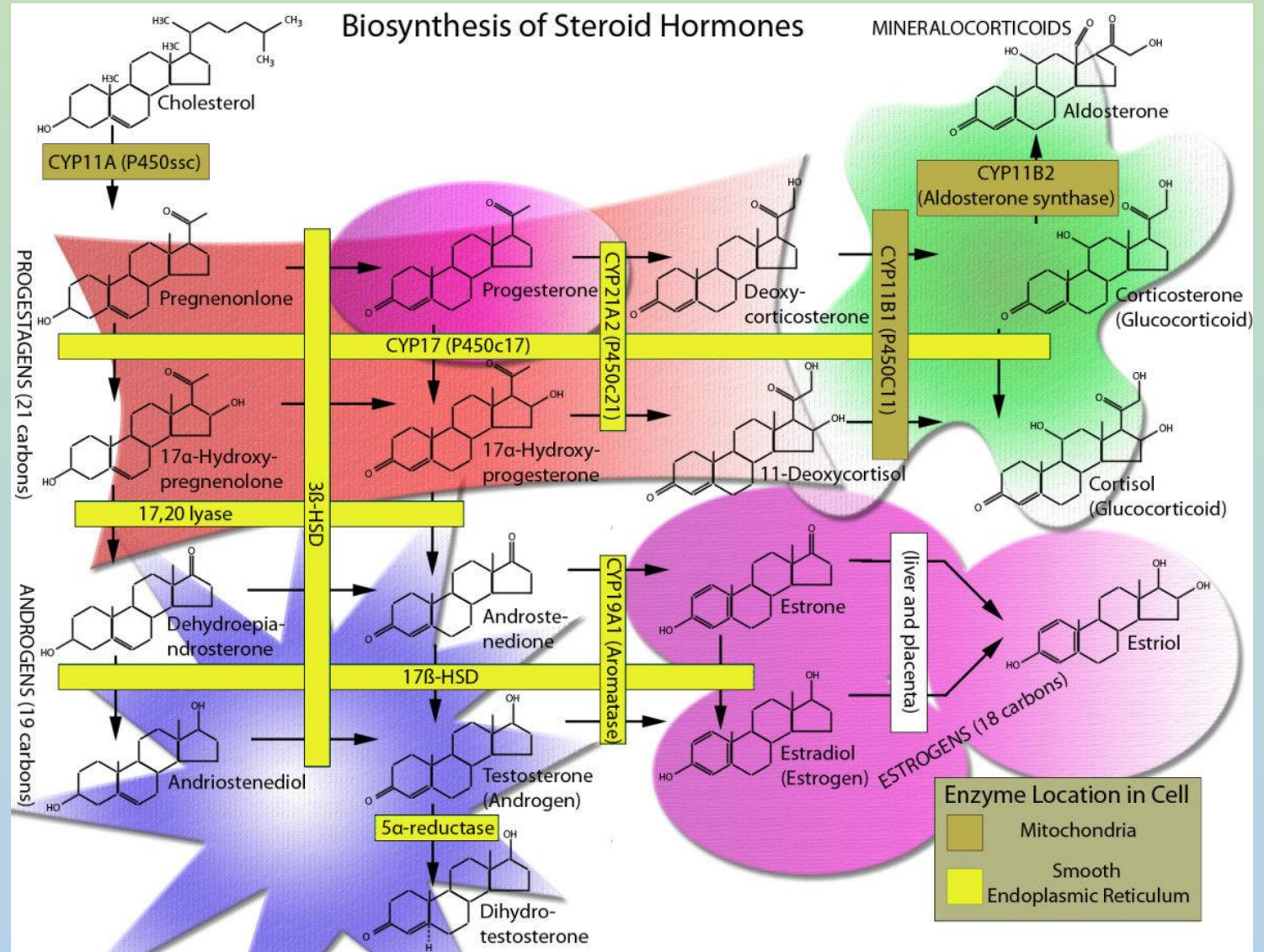

Synthesis and secretion of steroid hormones

Glucocorticoids - pulsatile character under ACTH stimulation (cortisol – 10 – 20 mg/day)

Mineralocorticoids – ACTH only basal secretion, RAAS – angiotensin II (aldosterone – 100 – 150 μ g/day)

Androgens – ACTH (DHEA, DHEAS, androstenedione – 100 – 150 μ g/day)

Different expressions of enzymes catalyzing steps in steroid conversions are responsible for synthesis of various steroid hormones in individual zones of adrenal cortex.

Regulation of synthesis and secretion

Glucocorticoids

- ACTH – $G\alpha_s$ – activation of AC and PAK
- Phosphorylation of cholesterol ester hydrolase
- Increased availability of cholesterol
- Increased STAR synthesis

Mineralocorticoids

- Angiotensin II and extracellular K^+
- ACTH (only basal and acute secretion)
- RAAS system
 - Renin (juxtaglomerular cells)
 - Conversion of angiotensinogen
 - Angiotensin II stimulates aldosteron synthesis and secretion
- Inhibition also by somatostatin and dopamine

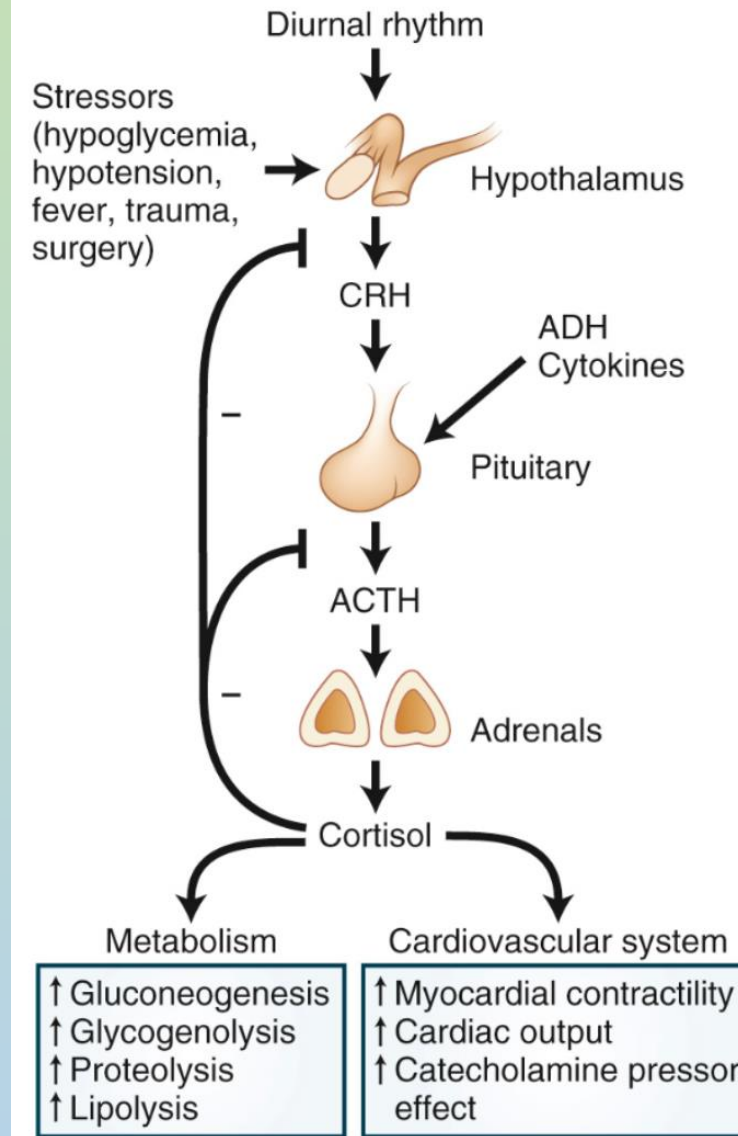

A Regulation of cortisol secretion

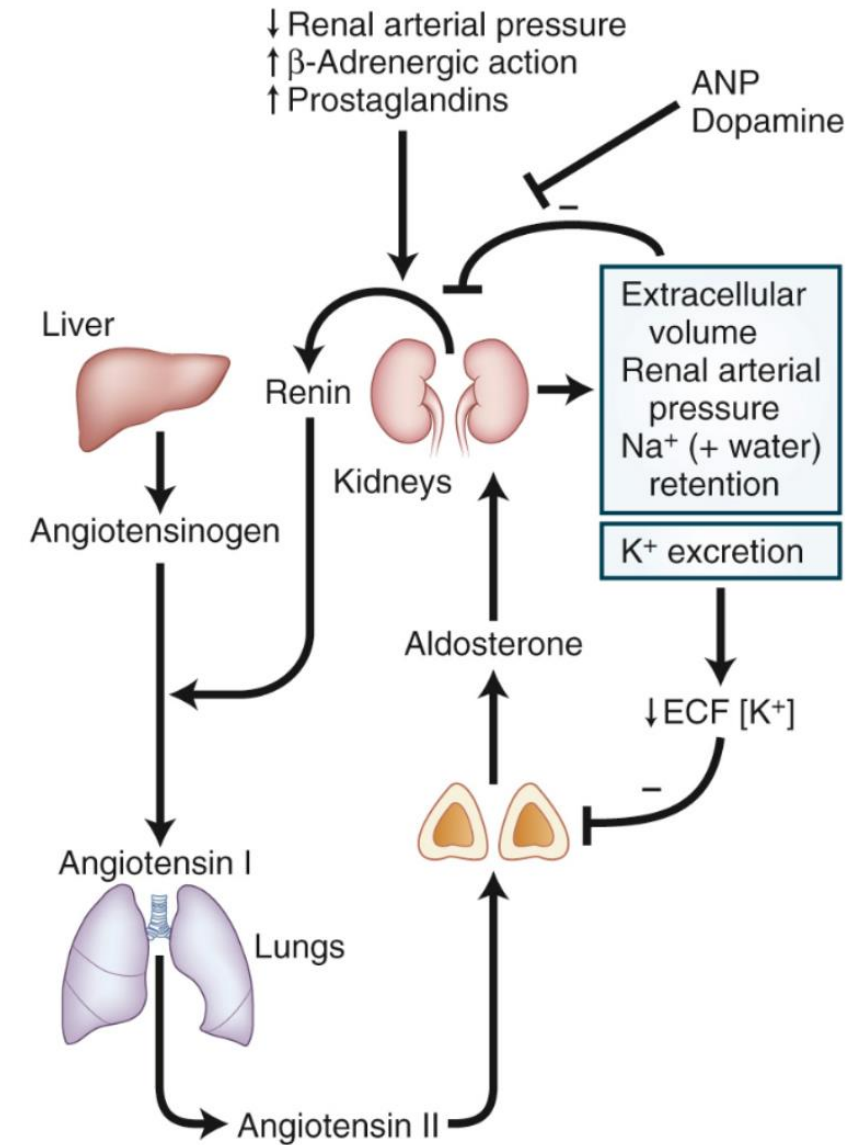

B Regulation of aldosterone secretion

Circadian and pulsatile secretion of ACTH and cortisol

Maximum in early morning

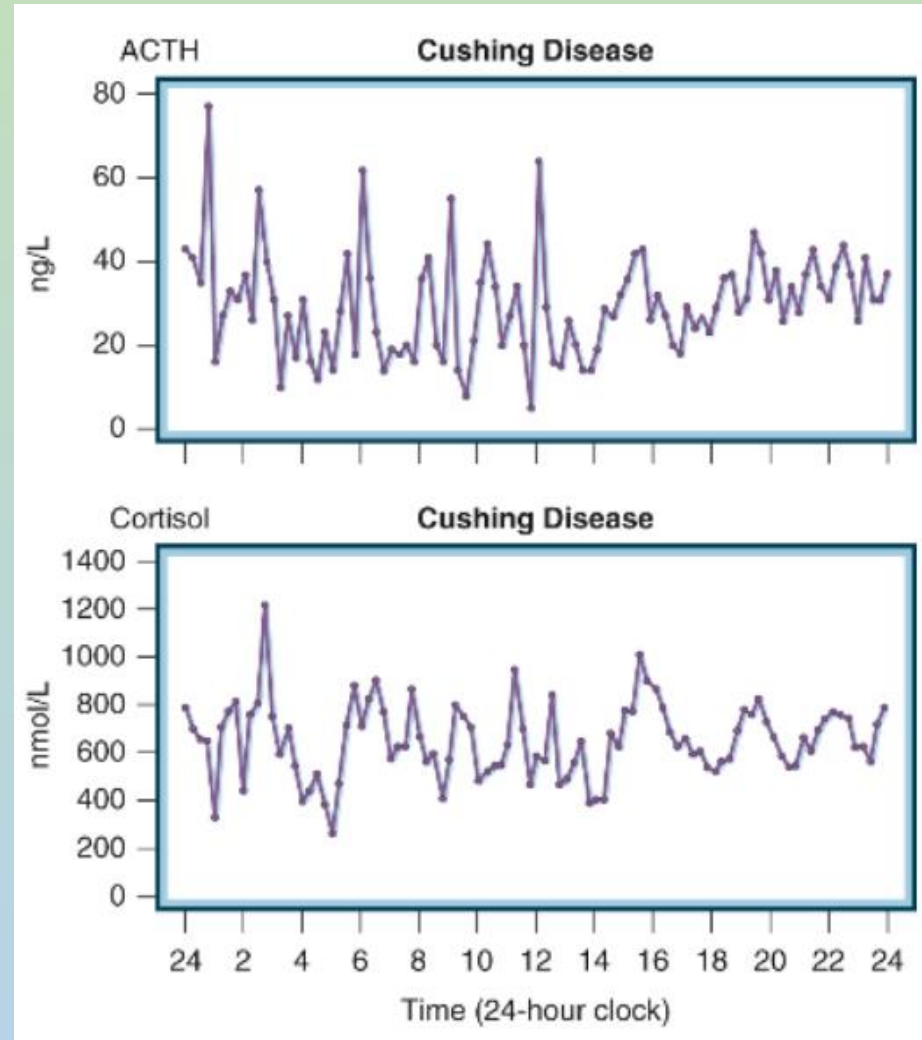
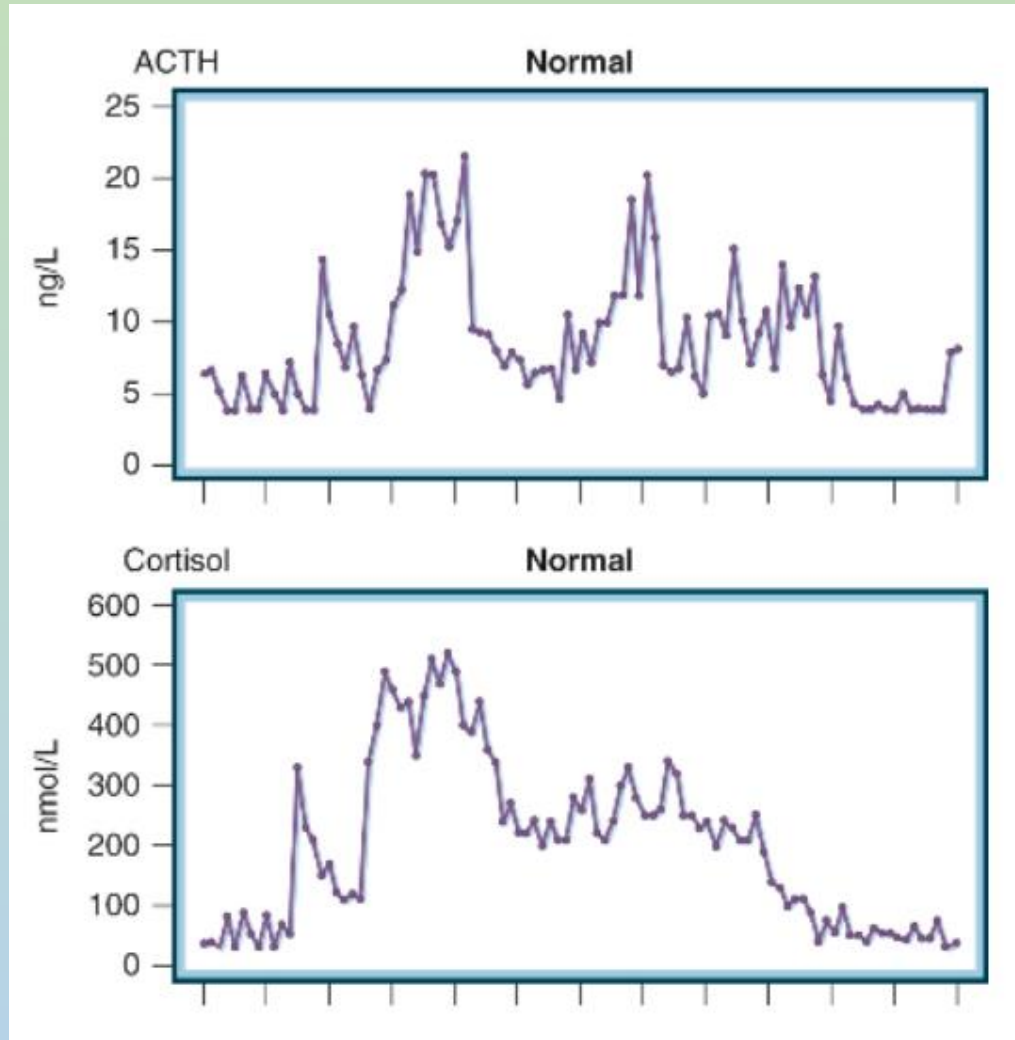

Increased frequency and amplitude of pulses, loss of circadian secretion

Glucocorticoid metabolism

- Lipophilic
 - Conjugates
 - Binding to CBG proteins (transcortin, cortisol-binding globulin) and albumin
- Half-life 70 – 90 min

Detoxication

- Liver
- Kidney
- Reduction, oxidation, hydroxylation and conjugation
- Glucuronides and sulphates

Local glucocorticoid metabolism

- Tissues with different expression of isoforms of 11β -hydroxysteroid dehydrogenase type I (conversion cortisone to cortisol)
 - Liver, adipose tissue, lungs, skeletal muscle, smooth muscles of blood vessels, gonads, CNS
- Tissues with different expression of isoforms of 11β -hydroxysteroid dehydrogenase type II
 - Tubular system

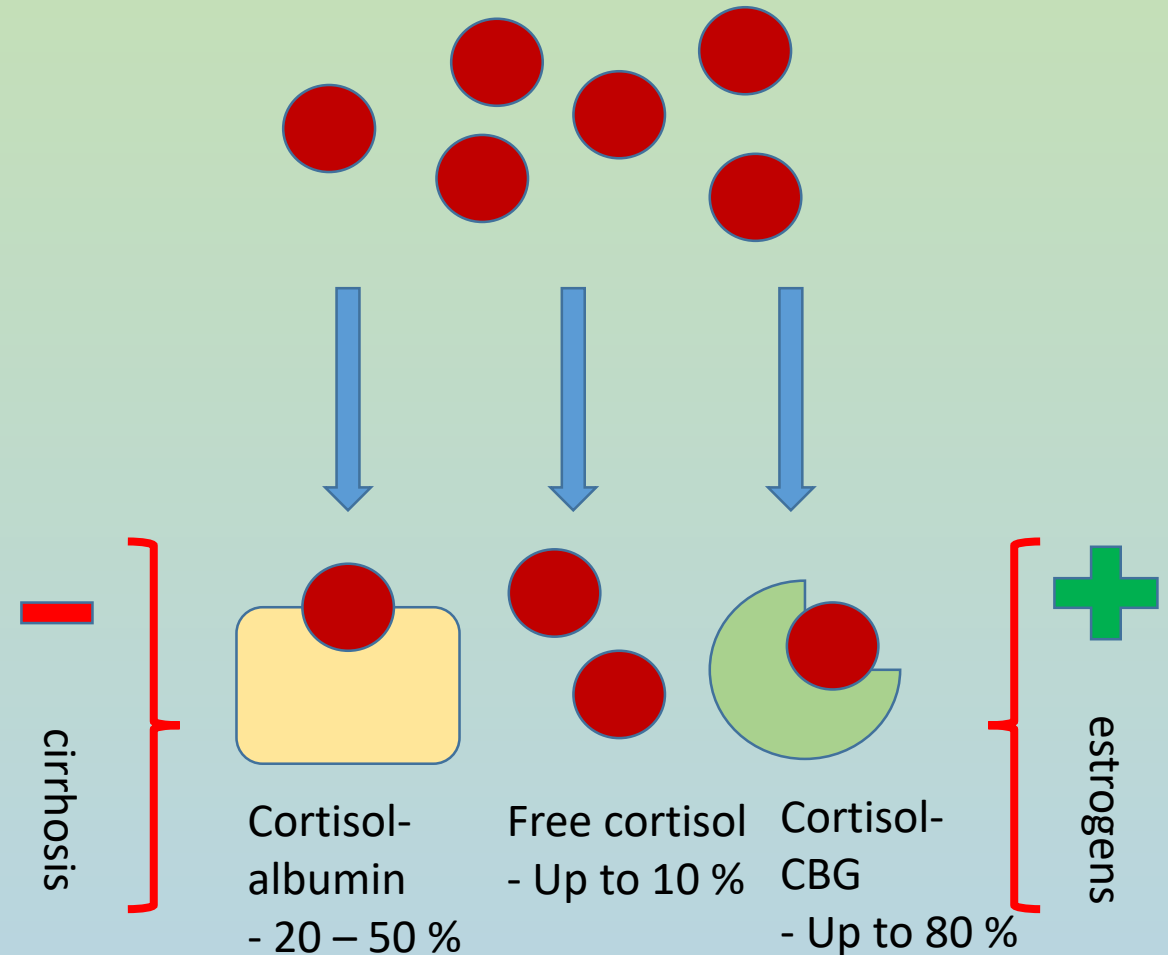

Conversion of cortisol to cortisone is essential for prevention of cortisol binding to mineralocorticoid receptor.

Effects of glucocorticoids

1. Binding of GC on corresponding receptor
2. Conformational change and dissociation of receptor from complex HSP70 and HSP90
3. Migration to nucleus
4. Binding on GRE together with activating protein (AP1)

Glucocorticoids affect intermedial metabolism, stimulate proteolysis and gluconeogenesis, inhibit proteosynthesis (mainly in muscles) and stimulate mobilization of FFAs.

All tissues express glucocorticoid receptors, which causes their wide array of effects.

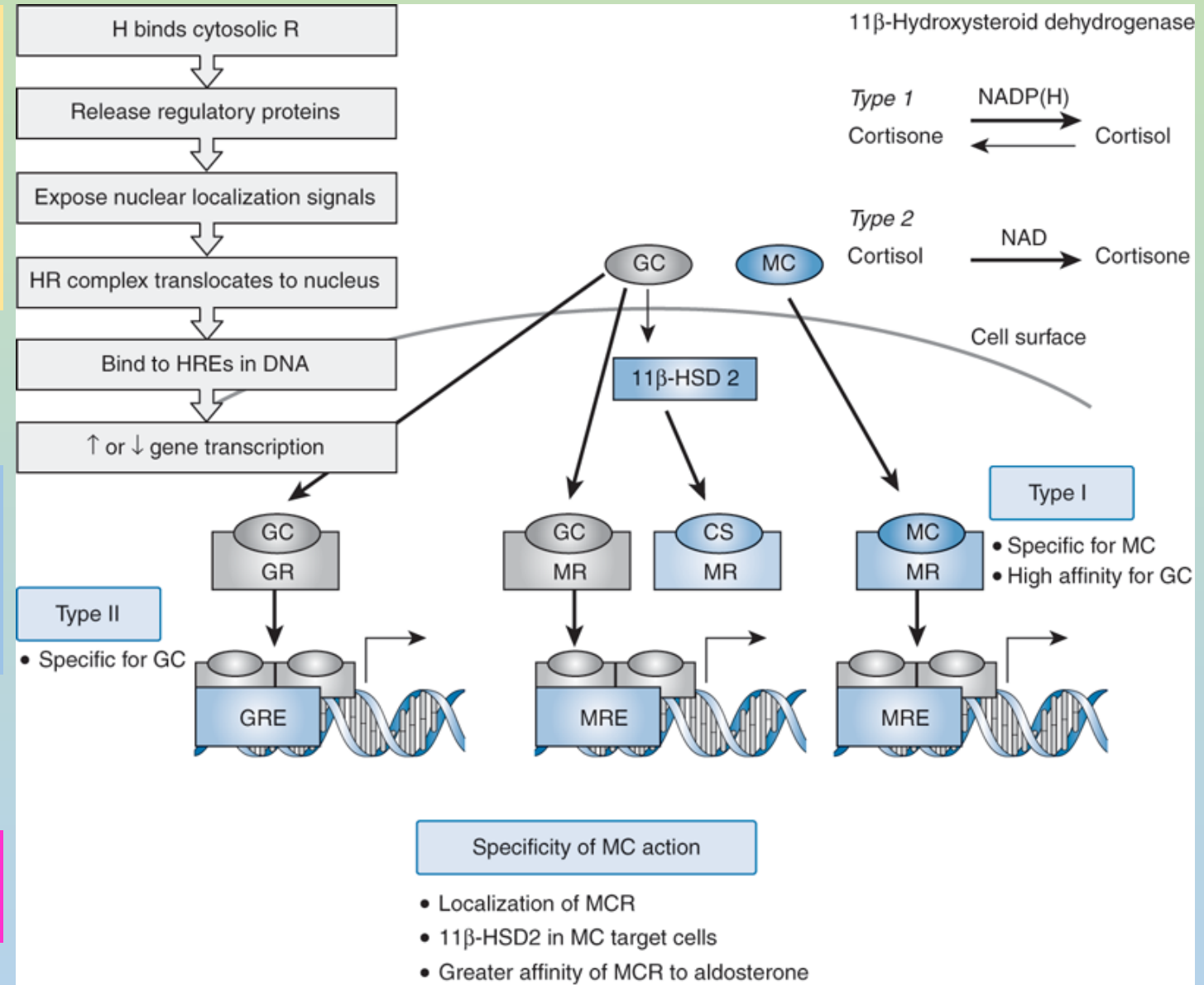

Specific effects of glucocorticoids

System	Induced gene expression	Suppressed gene expression
Immune system	Inhibitor of NF- κ B, haptoglobin, TCR, p21, p27, p57, lipocortin	Interleukins, TNF- α , interferon- γ , E-selectin, COX-2, iNOS
Metabolism	PPAR- γ , glutamine synthase, glycogen synthase, Glu-6-phosphatase, leptin, γ -fibrinogen, cholesterol 7 α -hydroxylase	Tryptophan hydroxylase, metalloproteases
Bone tissue	Androgen receptor (AR), calcitonin receptor (CTR), alcalic phosphatase, IGFBP6	Osteocalcin, collagenase
Ion channels and transporters	ENaC- α , - β a - γ , SGK, aquaporin 1	
Endocrine system	Basic FGF, VIP, endothelin, RXR, GHRH receptor, receptors for natriuretic peptides	GCR, prolactin, POMC/CRH, PTHrP, ADH
Growth and development	Surfactant proteins A, B, C	Fibronectin, α -fetoprotein, NGF, erythropoietin, G1 cyclins and CDKs

Effects of glucocorticoids - overview

Cardiovascular system:

- Increased sensitivity to catecholamines (α_2 -AR)
- Increased sensitivity to angiotensin II
- Inhibition of NO-mediated vasodilatation
- Stimulation of angiotensinogen synthesis
- HSD11B2-activity-dependent increase in Na^+ retention in distal tubulus and increased K^+ excretion
- Increased GFR
- Increased resorption of Na^+ in proximal tubulus

Increased blood pressure

Immune system:

- Decrease in lymphocyte count (T more than B) based on redistribution to spleen, lymphatic nodes and bone marrow
- Increased number of neutrophils
- Decreased number of eosinophils and basophils
- Inhibition of monocyte-macrophage differentiation
- Inhibition of immunoglobulin synthesis
- Inhibition of cytokine synthesis
- Inhibition of histamine and serotonin secretion from mast cells
- Inhibition of prostaglandine synthesis

Anti-inflammatory and immunosuppressive effect

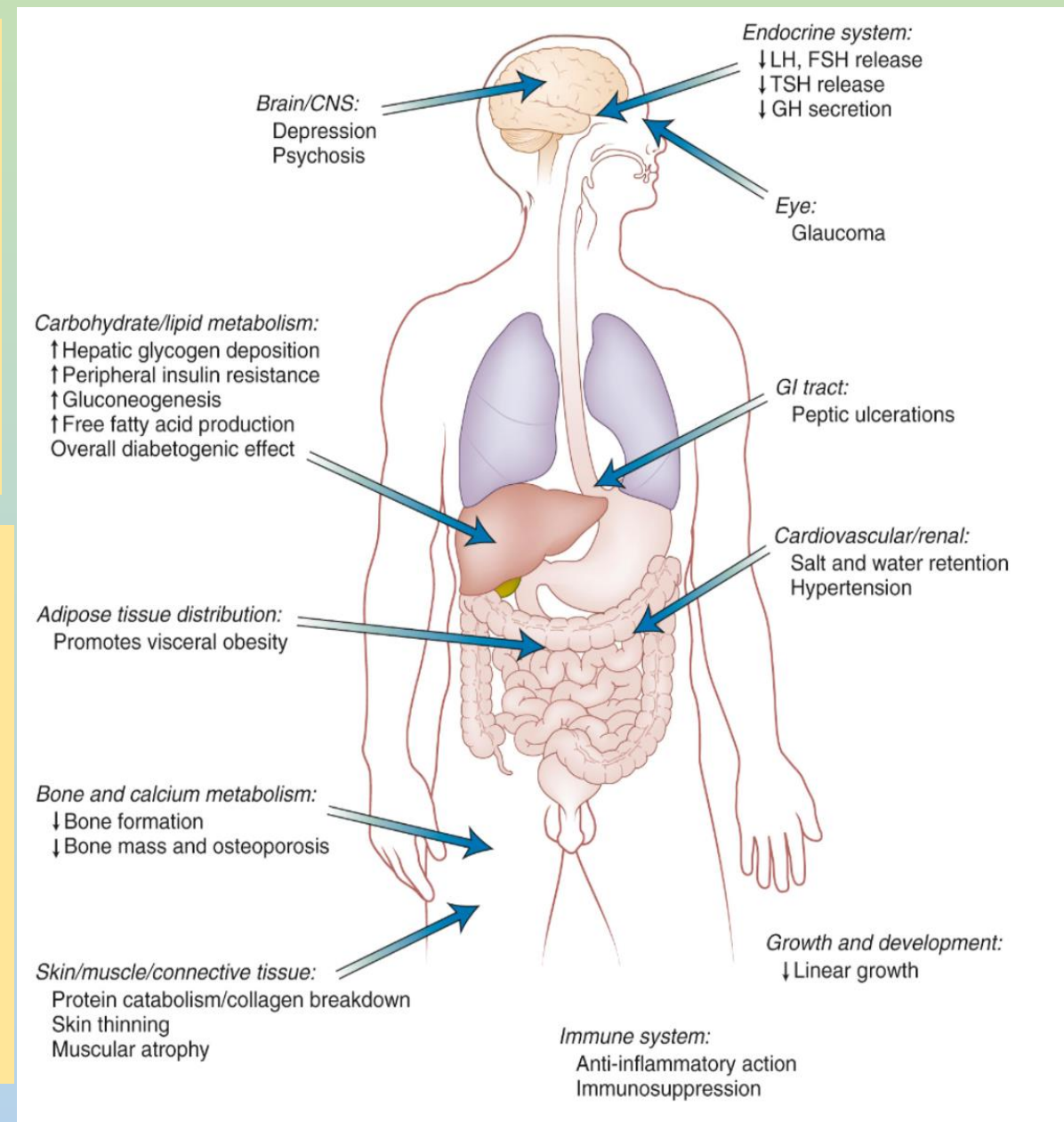

Glucocorticoids – clinical aspects

Field	Utilization
Endocrinology	Substitution therapy
Dermatology	Dermatitis
Haematology, hematooncology	Leukemia, lymphoma, haemolytic anemia, immune thrombocytopenic purpura
Gastroenterology	Ulcerative colitis, Crohn's disease
Internal medicine, Infectious diseases	Chronic active hepatitis, transplantation, nephrotic syndrome, vasculitis
Neurology	Cerebral edema, increased intracranial pressure
Pneumology	Asthma, angioedema, anaphylaxis, sarcoidosis, obstructive pulmonary diseases
Rheumatology	Systemic lupus erythematosus, arteritis, rheumatoid arthritis

Long-term glucocorticoid application:

- Steroid diabetes
- Secondary osteoporosis
- Dexamethasone test
- Metyrapone test
- CRH stimulation test

Glucocorticoids are characteristic by not only glucocorticoid, but also mineralocorticoid activity and by ability to affect axis CRH-ACTH-GC by feedback loop.

Glucocorticoids – clinical aspects



Cushing syndrom

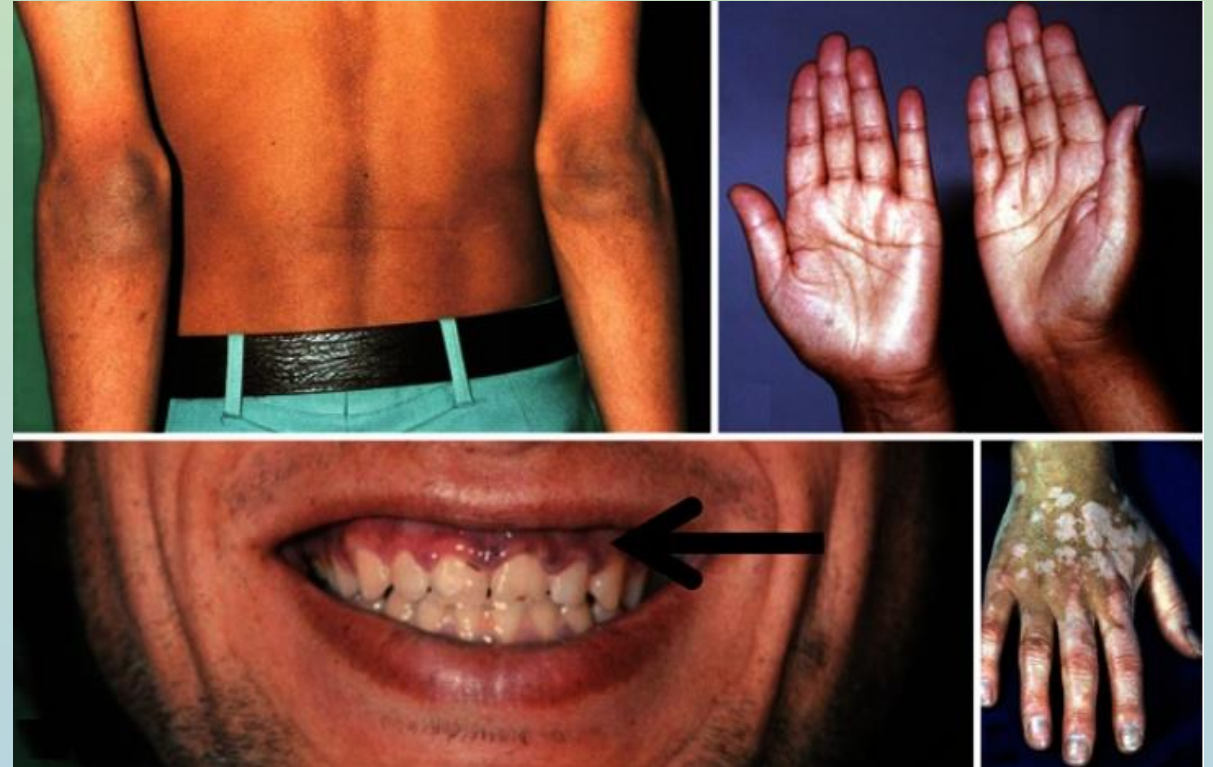

Addison disease

Mineralocorticoids – regulation of aldosterone secretion

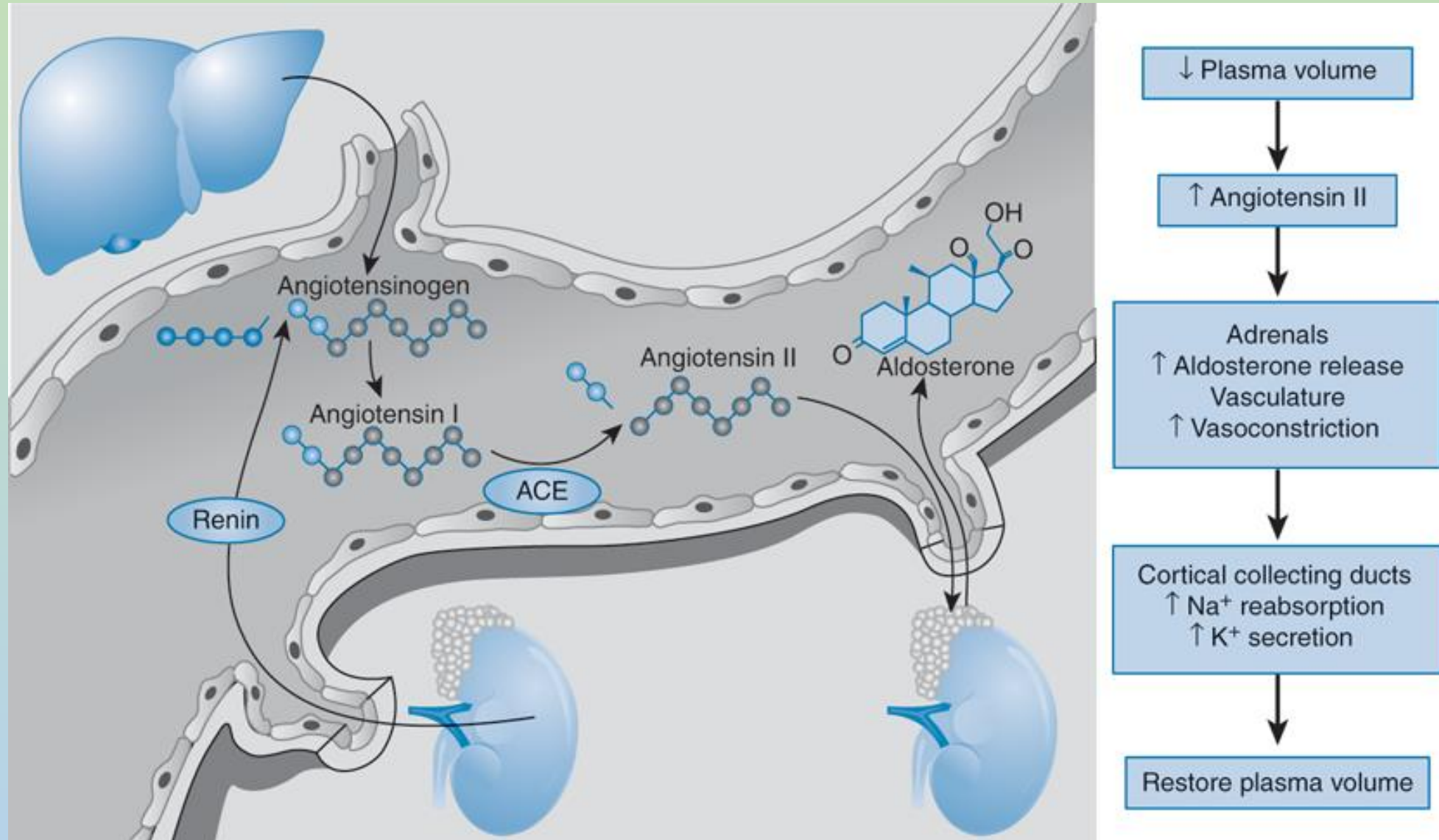

Effects of mineralocorticoids

Receptors

- Limited distribution
- Keratinocytes
- Neurons (CNS)
- Myocytes
- Smooth muscle cells in large blood vessels

Main effects of aldosterone

- Stimulation of epithelial Na transport
 - Distal tubulus and collecting duct
 - Distal colon
 - Salivary glands

Mechanism of effect

- (+) synthesis of Na^+ IK
- (+) synthesis of Na^+/K^+ -ATPase
- (+) activity of Na^+/K^+ -ATPase
- (+) synthesis of H^+ -ATPase
- (+) synthesis of $\text{Cl}^-/\text{HCO}_3^-$ exchanger

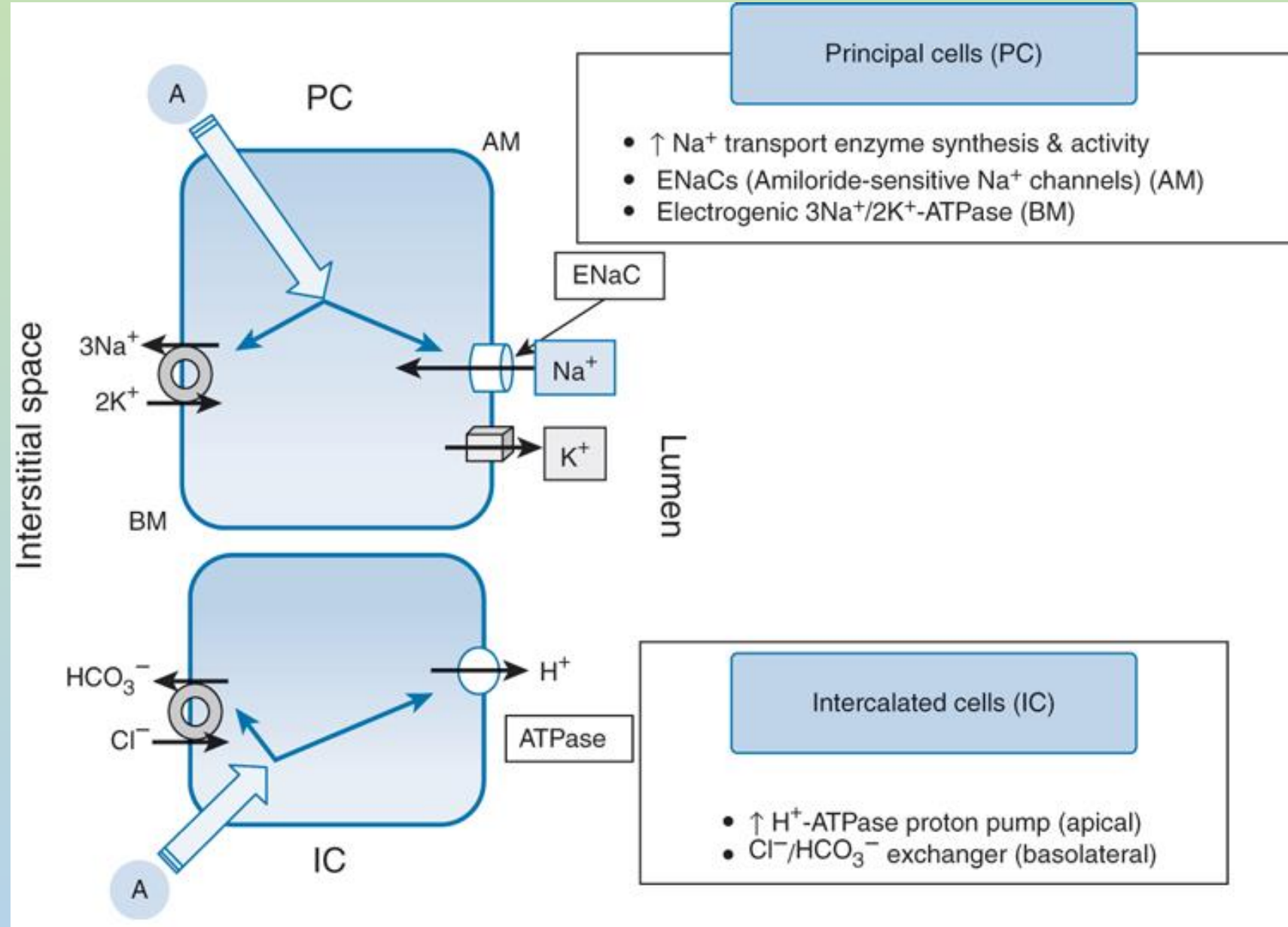

Adrenal gland androgens

- DHEA is important precursor for sex hormones synthesis
- Conversion by enzymes from β -hydroxysteroid dehydrogenase group and aromatase in **peripheral tissues**
- Possible presence of CASH (cortical androgen-stimulating hormone)

Possible functions of adrenal gland androgens

- Libido and its „regulation“
- Cardioprotective effects in men
- Possible protective role from ovarian and breast carcinoms in premenopausal women
- Neuroprotection
- Effect on synthesis and secretion:
 - IGF-1
 - Testosterone and dihydrotestosterone
 - Estradiol

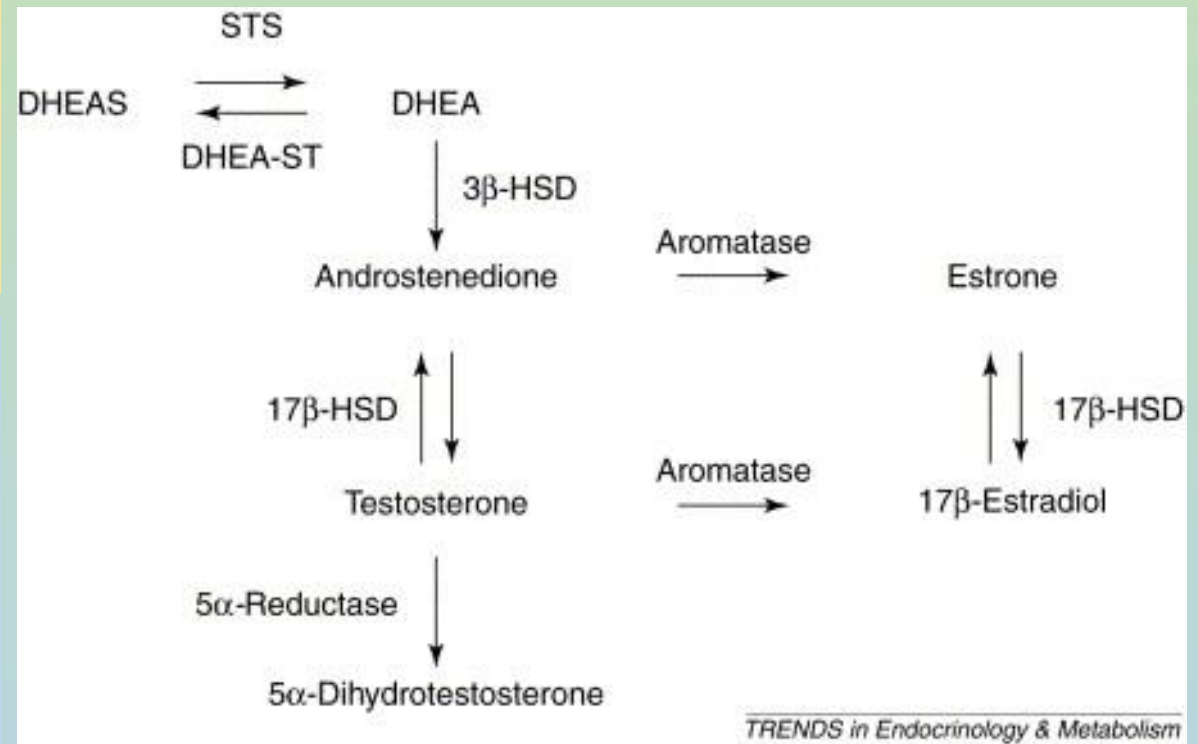

Androgens produced in adrenal glands represent more than 50 % of circulating androgens in premenopausal women. In men dominates the testicular production.

Clinical aspects

- **Congenital adrenal hyperplasia (CAH)**
 - prenatal virilization (high androgen concentration *in utero*)
 - Deficit of 21 β -hydroxylase, „salt wasting form“
 - Deficit of 11 β -hydroxylase, „hypertensive form“
 - Deficit of 3 β -hydroxysteroid dehydrogenase II
 - Deficit of 17 α -hydroxylase
- **Congenital lipid adrenal hyperplasia**
 - Defective conversion of cholesterol to pregnenolone
- **Adrenogenital syndrome**
- **Hyperaldosteronism**
 - Primary hyperaldosteronism
 - Secondary hyperaldosteronism with increased renin level
- **Secondary adrenal insufficiency (ACTH)**
- **Tertiary adrenal insufficiency (CRH)**
- **Hyporeninemic hypoaldosteronism**
- **Pseudohypoaldosteronism**

- Apparent mineralocorticoid excess syndrome
- Inhibition or absence of 11 β -hydroxysteroid dehydrogenase II



Watch out for liquorice 😊