

Lectures on Medical Biophysics

Department of Biophysics, Medical Faculty,
Masaryk University in Brno





Lectures on Medical Biophysics

Department of Biophysics, Medical Faculty,
Masaryk University in Brno

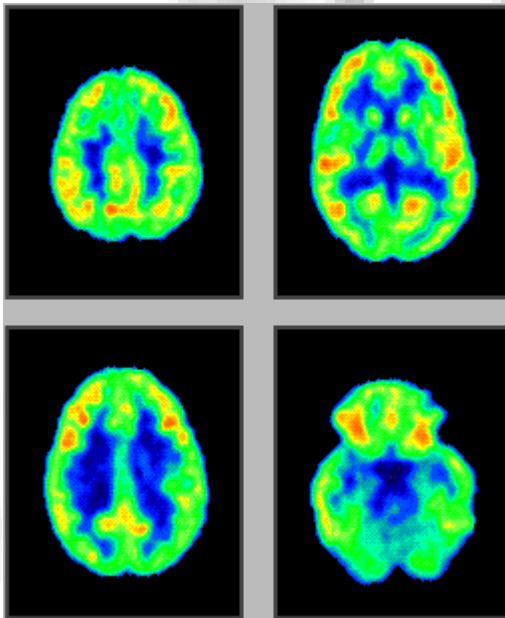

Nuclear medicine and radiotherapy

Nuclear medicine and radiotherapy



In this lecture we deal with selected methods of nuclear medicine and radiotherapy including their theoretical background:

Radioactive decay

Interactions of ionising radiation with matter

Biological effects of ionising radiation

Nuclear medicine

- *Simple metabolic examinations*
- *Imaging*

Radiotherapy

- *Sources of radiation – radioactive and non-radioactive*
- *Methods of radiotherapy*



Radioactivity

- **Radioactivity** or **radioactive decay** is the spontaneous transformation of unstable nuclei into mostly stable nuclei. This is accompanied by the emission of gamma photons, electrons, positrons, neutrons, protons, deuterons and alpha particles. In some transformations, neutrinos and antineutrinos are produced. Unstable nuclei can be found naturally or created artificially by bombarding natural stable nuclei with e.g. protons or neutrons.
- Radioactive decay has a stochastic character: it is not possible to determine which nucleus will decay at what time (tunnel effect).



Laws valid for radioactive decay

- Law of mass-energy conservation
- Law of electric charge conservation
- Law of nucleon number conservation
- Law of momentum conservation
-



Law of radioactive decay

The activity A of a radioactive sample at a given time (i.e., the number of nuclei disintegrating per second, $A = dN/dt$) is proportional to the total number of *undecayed* nuclei present in the sample at the given time:

$$-\frac{dN}{dt} = N\lambda$$

λ is the decay or transformation constant

Units of A are **becquerel (Bq)** [disintegrations per second, s^{-1}]

(in the past: curie, $1 \text{ Ci} = 3.7 \cdot 10^{10} \text{ Bq}$)

The negative sign indicates that the number of *undecayed* nuclei is decreasing.

This equation is solved by integration:

$$N_t = N_0 \cdot e^{-\lambda \cdot t}$$

A more useful equation  for nuclear medicine and radiotherapy is (obtained by dividing the above equation by dt on both sides):

$$A_t = A_0 \cdot e^{-\lambda t}$$

A is activity



Physical half-life

- T_p – time in which the sample activity A_t decreases to one half of the initial value A_0 . Derivation:

$$A_0/2 = A_0 \cdot e^{-\lambda T_p} \quad \text{thus} \quad 1/2 = e^{-\lambda T_p}$$

- taking logarithm of both sides of the equation and rewriting:

$$T_p = \ln 2 / \lambda_p \quad \text{thus} \quad T_p = 0.693 / \lambda_p$$



Biological and effective half-life

- T_b – biological half-life – time necessary for the physiological removal of half of a substance from the body
- λ_b – biological constant – relative rate of a substance removal
- Biological and physical processes take place simultaneously. Therefore, we can express the T_{ef} – *effective half-life* and

λ_{ef} – *effective decay constant*

- The following equations hold: $\lambda_{ef} = \lambda_b + \lambda_p$ and $1/T_{ef} = 1/T_p + 1/T_b$,

thus

$$T_{ef} = \frac{T_p T_b}{T_p + T_b}$$



Technetium generator

During radioactive decay, a daughter radionuclide is produced. In cases when the half-life of the parent radionuclide is much longer than the half-life of the daughter radionuclide both parent and daughter end up with the same activity (radioactive equilibrium).



$$\lambda_1 N_1 = \lambda_2 N_2$$

An example of practical importance of the radioactive equilibrium in clinical practice – production of technetium for diagnostics: Mo-99 half-life is 99 hrs., Tc-99m half-life is 6 hrs.

Classes of radioactive decay



α (alpha) decay



Seaborgium transforms in rutherfordium. Helium nucleus – α particle – is liberated. Daughter nucleus recoils as a consequence of the law of momentum conservation.

(<http://www2.slac.stanford.edu/vvc/theory/nuclearstability.html>)



Classes of radioactive decay

β decay is an isobaric transformation in which besides the β particles are formed also neutrinos (electron antineutrino $\bar{\nu}_e$ or electron neutrino ν_e)

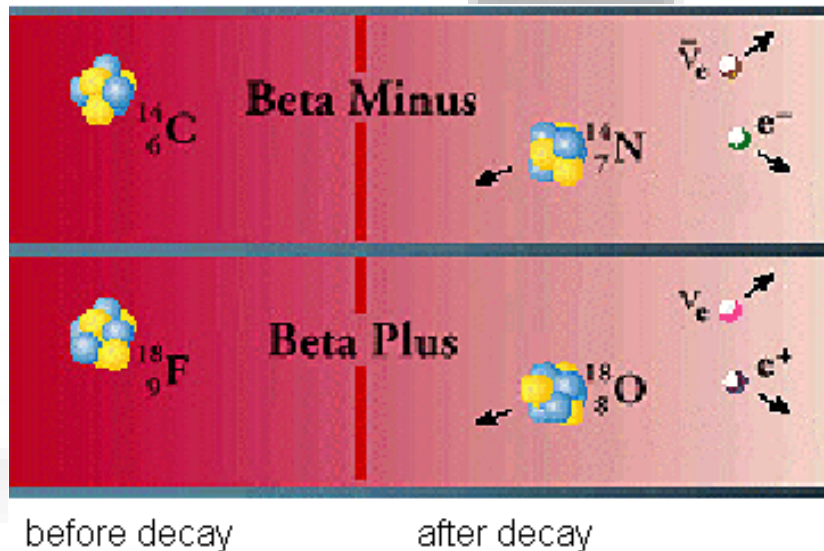

β (beta) decay = emission of an electron or positron

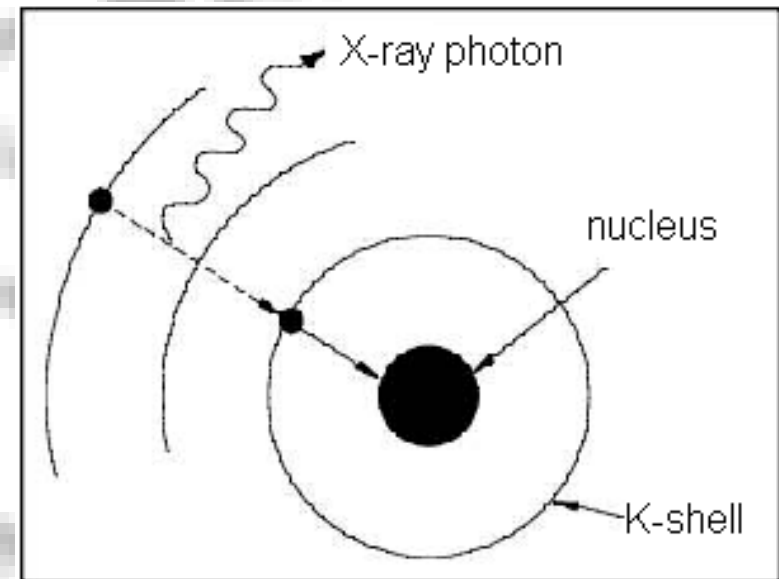
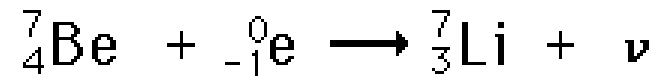

K-capture

Classes of radioactive decay



γ (gamma) decay

Transformation of dysprosium nucleus in excited state



The other classes of radioactive decay:

- Emission of proton, deuteron, neutron ...
- Fission of heavy nuclei

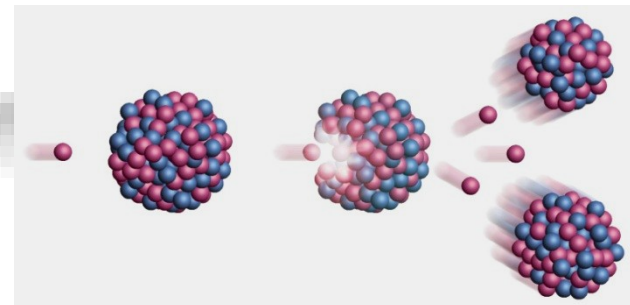

Interaction of ionising radiation with matter



- The interaction of radiation with matter is usually accompanied by the formation of **secondary radiation** which differs from the primary radiation by lower energy and often also by kind of particles.
- Primary or secondary radiation directly or indirectly **ionises** the medium, and creates also **free radicals**.
- A portion of the radiation energy is always transformed into **heat**.
- The energy loss of the particles of primary radiation is characterised by means of LET, **linear energy transfer**, i.e. energy loss of the particle in given medium per unit length of its trajectory. The higher the LET the more damaging is the radiation to tissues and the higher the risk from the radiation.



Attenuation of X / gamma radiation

When a beam of X or gamma radiation passes through a substance:

$$\text{absorption} + \text{scattering} = \text{attenuation}$$

A small decrease of radiation intensity $-dl$ in a thin substance layer is proportional to its thickness dx , intensity I of radiation falling on the layer, and a specific constant μ :

$$-dl = I \cdot dx \cdot \mu$$

After rewriting:

$$dl/I = -dx \cdot \mu$$

After integration:

$$I = I_0 \cdot e^{-\mu x}$$

I is intensity of radiation passed through the layer of thickness x , I_0 is the intensity of incident radiation, μ is **linear coefficient of attenuation** [m^{-1}] (depending on photon energy, atomic number of medium and its density).

Interactions of photon radiation (X-rays and gamma rays)



- **Photoelectric effect and Compton scattering** – see the lecture on X-ray imaging.
- **Electron - positron pair production (PP)** – **very high energy photons only**. The energy of the photon is transformed into mass and kinetic energy of an electron and positron. The mass-energy E in each particle is given by:

$$E = m_0 c^2 (= 0.51 \text{ MeV}),$$

m_0 is rest mass of an electron / positron (masses of electron and positron are equal), c is speed of light in vacuum. Energy of the photon must be higher than *twice* the energy calculated using the above formula (1.02 MeV). We can write:

$$E = hf = (m_0 c^2 + E_{k1}) + (m_0 c^2 + E_{k2})$$

- Terms in brackets: mass-energies of created particles, E_{k1} a E_{k2} kinetic energies of these particles.
- The positron quickly interacts (annihilates) with any nearby electron, and two photons originate, each with energy of 0.51 MeV.

Electron - positron pair production

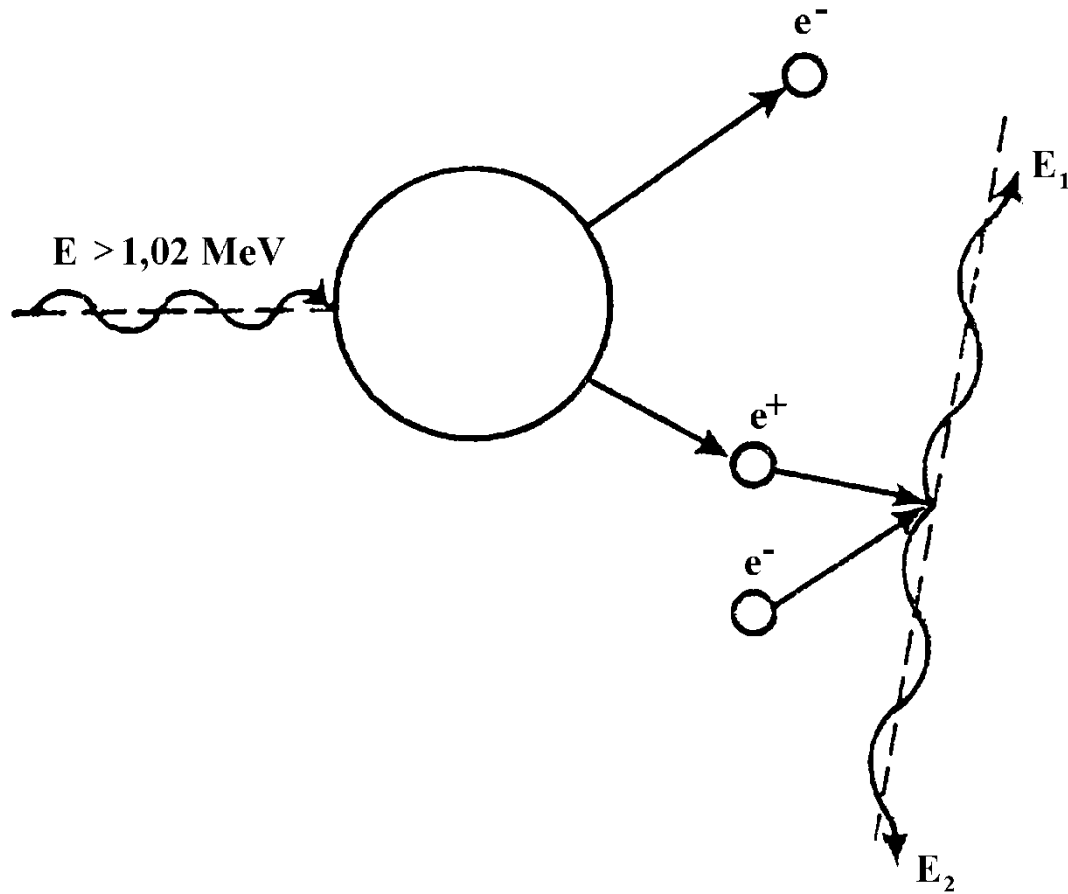



Interaction of corpuscular radiation with tissue

- **β radiation** = fast electrons or positrons – ionise the medium as in X-ray production. Trajectory of a β particle is several millimetres in aqueous medium.
- **α radiation** ionises directly by impacts. There is formed big number of ions along its very short trajectory in medium (μm) – so it loses energy very quickly along a short trajectory (= very high LET) .
- **Neutrons** ionise by elastic and non-elastic impacts (scatter) with atomic nuclei. The result of an **elastic scatter** differs according to the ratio of neutron mass and atom nucleus mass. When a **fast neutron** hits the nucleus of a heavy element, it bounces off almost without energy loss. Collisions with light nuclei lead to big energy losses. In **non-elastic scatter**, the slow (**moderated, thermal**) neutrons penetrate into the nucleus, and if they are emitted from it again, they do not have the same energy like the incident neutrons. They can lead to the emission of other particles or fission of heavy nuclei.

Main quantities and units for measurement of ionising radiation



➤ Absolute value of particle energy is very small. Therefore, the **electron volt (eV)** was introduced. 1 eV is the kinetic energy of an electron accelerated from rest by electrostatic field of the potential difference 1 volt.

$$1 \text{ eV} = 1.602 \cdot 10^{-19} \text{ J.}$$

➤ Energy absorbed by the medium is described by **absorbed dose (D)** - unit **gray, Gy**). It is the amount of energy absorbed per unit mass of tissue. Gray = J·kg⁻¹

➤ **Dose rate** expresses the absorbed dose in unit time [J·kg⁻¹·s⁻¹]. The same absorbed dose can be reached at different dose rates during different time intervals.

➤ The radiation hazard to biological objects depends mainly on the absorbed dose and the type of radiation. The **radiation weighting factor** is a number which indicates how hazardous a type of radiation is (the higher the LET the higher the radiation weighting factor).

➤ **Equivalent dose D_e** is defined as the product of the absorbed dose and the radiation weighting factor. The unit of Equivalent dose is the **sievert (Sv)**.

➤ **Effective dose (Sv)** – kind of irradiated tissue is also considered.

Biological effects of ionising radiation



- **Physical phase** – time interval of primary effects. Energy of radiation is absorbed by atoms or molecules. Mean duration is about 10^{-16} s.
- **Physical-chemical phase** – time interval of intermolecular interactions (energy transfers). About 10^{-10} s.
- **Chemical (biochemical) phase** – free radicals are formed. They interact with important biomolecules, mainly with **DNA** and proteins. About 10^{-6} s.
- **Biological phase** – a complex of interactions of chemical products on various levels of the living organism and their biological consequences. Depending on these levels, the duration ranges from seconds to years.



Biological effects of ionising radiation

- **Direct action (hits)** – physical and physical-chemical process of radiation energy absorption, leading directly to changes in important cellular structures. It is the most important action mechanism in cells with low water content. Theory of direct action is called **target theory**. It is based on physical energy transfer.
- **Indirect effects** are mediated by water radiolysis products, namely by free radicals H^* and OH^* . It is most important in cells with high water content. The free radicals have free unpaired electrons which cause their high chemical reactivity. They attack chemical bonds in biomolecules and degrade their structure. Theory of indirect action – **radical theory** – is based on chemical energy transfer.



Effects on the cell

In proliferating cells we find these levels of radiation damage:

- **Transient stopping of proliferation**
- **Reproductive death of cells** (vital functions are maintained but proliferation ability is lost)
- **Instantaneous death of cells**

Cell sensitivity to ionising radiation (radiosensitivity), or their resistance (radioresistance) depends mainly on the repair ability of the cell.



Effects on the cell

Factors influencing biological effects in general:

- **Physical and chemical:** equivalent dose, dose rate, temperature, spatial distribution of absorbed dose, presence of water and oxygen.
- **Biological:** species, organ or tissue, degree of cell differentiation, physiological state, spontaneous ability of repair, repopulation and regeneration.

Sensitivity of cells is influenced by:

- **Cell cycle phase** (S-phase!)
- **Differentiation degree.** Differentiated cells are less sensitive.
- **Water and oxygen content.** Direct proportionality (+,+)

Very sensitive are e.g. embryonic, generative, epidermal, bone marrow and also **tumour cells**



Tissue sensitivity

Arranged according to the decreasing radiosensitivity:

lymphatic
spermatogenic epithelium of testis
bone marrow
gastrointestinal epithelium
ovaries
cells of skin cancer
connective tissue
liver
pancreas
kidneys
nerve tissue
brain
muscle

Typical symptoms of radiation sickness:

1. Non-lethal – damage to the erythropoiesis (bone marrow), effects on gonads
2. Lethal – gastrointestinal syndrome (damaged epithelium), skin burning, damage to suprarenal glands, damaged vision, nerve syndrome (nerve death)

Late sequels – cumulative –
genetic damage, cancer

Nuclear medicine



Nuclear medicine

- Simple metabolic examinations
- Imaging

Scintillation counter and scintigraphy

(history of medicine)



- **Scintillation counter** consisted of a scintillation detector, mechanical parts and a lead collimator. The collimator enabled the detection of radiation only from a narrow spatial angle, in which the examined body part was located. Signals of the detector were amplified, counted and recorded.
- **Scintigraphy** was used mostly for examination of kidneys and thyroid gland – by means of gamma-emitters: iodine-131 or technetium-99m. Tc-99m has a short half-life (6 hours vs. 8 days in I-131). Technetium is prepared directly in dept. of nuclear medicine in **technetium generators**.
- Iodine used for thyroid was administered as KI, for kidneys was used technetium-labelled DTPA (diethylen-triamin-penta-acetic acid). Tc-99m is almost an ideal diagnostic radionuclide – fastly excreted, short half-life, almost pure gamma rays. (Iodine-131 produces also β -particles which increases radiation dose without any benefit). Recently, I-123 with half-life of 13.27 hours is also used in SPECT.

The Gamma Camera



photomultiplier tubes
(now being replaced by a flat digital sensor)

parallel hole
Pb
collimator
for
localisation

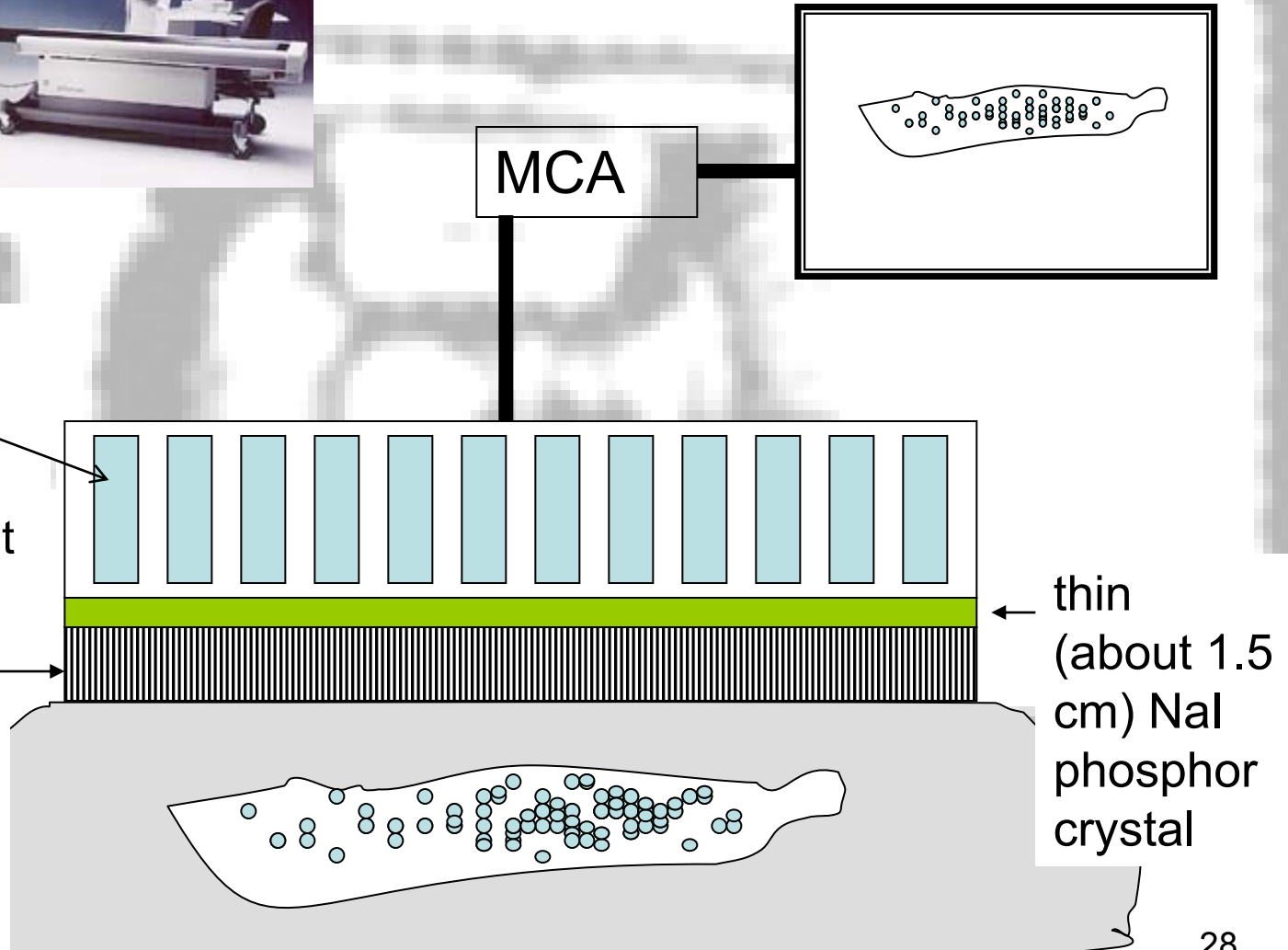



Gamma-camera (Anger camera)

- The digital sensor / photomultiplier signals carry information about the position of the scintillation events. However, a defined point on the crystal has to correspond with defined point of the examined body part – we obtain an image of radionuclide distribution in the body. This can be achieved only by **collimators**.
- Anger cameras show the radionuclide distribution very quickly. Therefore they can be used for observation of fast processes, including blood flow in coronary arteries. They can also move along the body. Physiologic (functional) information is obtained or metastases found (if the radionuclide is entrapped there, mainly technetium-99m or iodine-123).

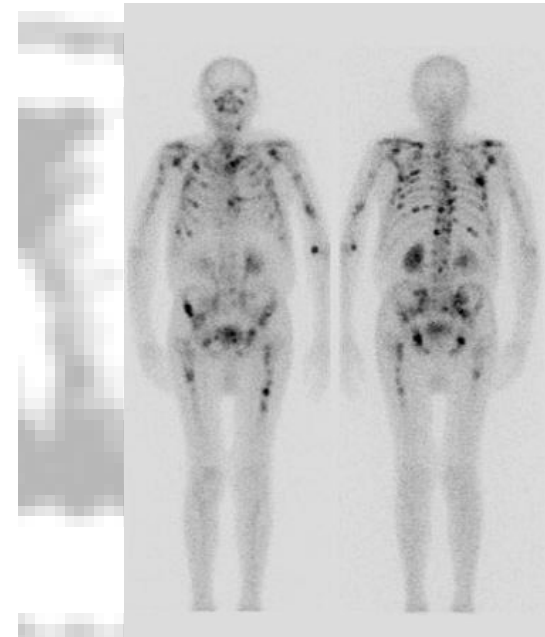

A whole body scan showing metastases of a bone tumour

SPECT – single photon emission computed tomography

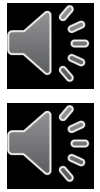

- Photons of radiation are detected from various directions, which allows **reconstruction of a cross-section.**
- Most frequent arrangements and movements of detectors:
 - Anger scintillation camera revolves around the body.
 - Many detectors are arranged around the body in a circle or square. The whole system can revolve around the body in a spiral (helix).

Principle of SPECT

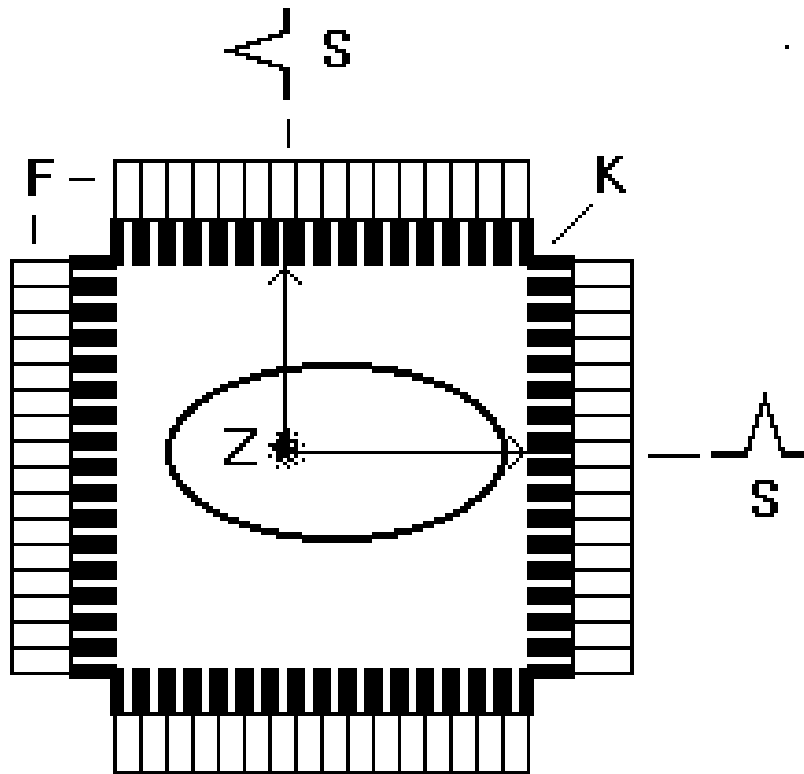

In SPECT, common sources of radiation (mainly technetium-99m) are used.



An object with a radiation source Z (captured technetium compound) is surrounded by scintillation detectors F with collimators K. The collimators allow detection only of gamma-rays falling normally onto the detector blocks. It enables us to localise the source of rays.

SPECT – images

<http://www.physics.ubc.ca/~mirg/home/tutorial/applications.html#heart>

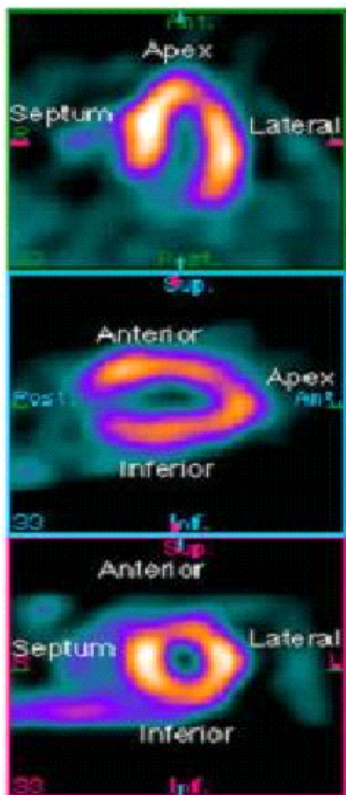

dlouhá osa
vertikálně

dlouhá osa
horizontálně

krátká osa

Perfusion of heart in different planes. „Hot“ regions are well blood supplied parts of the heart

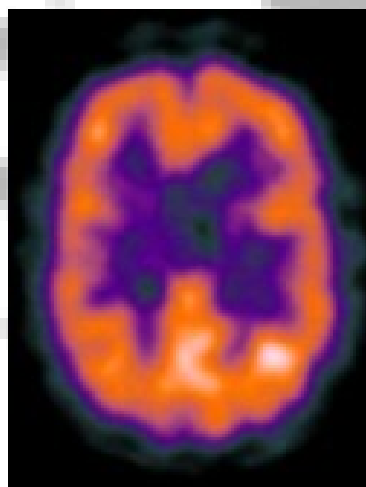

Brain with „hot“
regions



PET - *positron emission tomography*

- In PET, **positron emitters** are used. They are prepared in accelerators, and their half-lives are very short – max. hours. For that reason, the examination must be done close to the accelerator, in a limited number of medical centres.
- The positrons travel only very short distance, because they annihilate with electrons forming two gamma photons (0.51 MeV), which **move in exactly opposite directions**. These photons can be detected by two opposite detectors connected in a coincidence circuit. Voltage pulses are recorded and processed only when detected simultaneously in both detectors. Detectors scan and rotate around the patient's body.
- The spatial resolution of PET is substantially higher than in SPECT. The positron emitters are attached to e.g. glucose derivatives, so that we can obtain also **physiological (functional) information**. PET of brain visualises those brain centres which are at the moment active (have increased uptake of glucose). PET allows to follow CNS activity on the level of brain centres.



PET principle

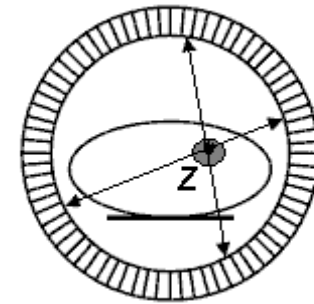
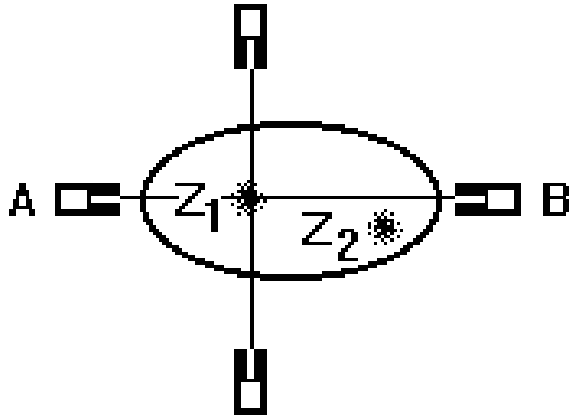

More realistic scheme

Explanation of the **high spatial resolution of PET**: The opposite detectors in a coincidence circuit. A source of radiation Z is detected only when lying on a line connecting the detectors. Detector A but not the detector B can be hit through a collimator from the source Z_2 , because this source is outside the detection angle of B. In SPECT, the signal detected by A from Z_1 would be partially overlapped by the signal coming from source Z_2 .

Functional PET of brain



http://www.crump.ucla.edu/software/lpp/clinpetneuro/lggifs/n_petbrainfunc_2.html

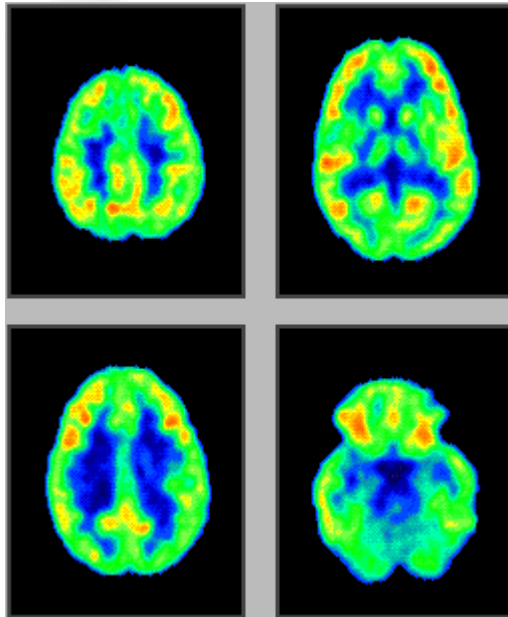

resting

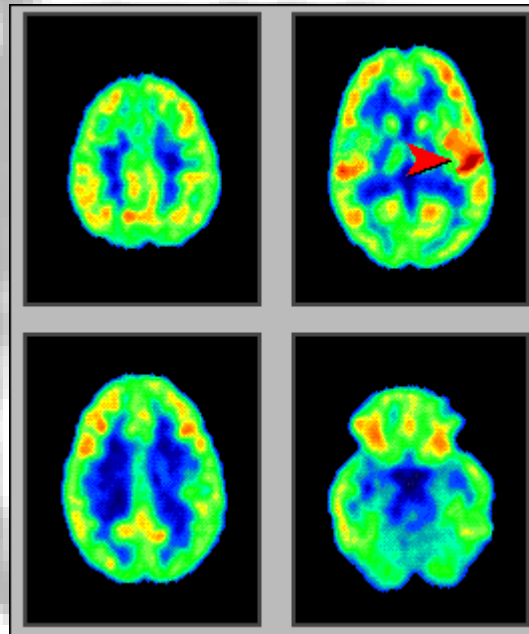

Music – a non-verbal acoustic stimulus

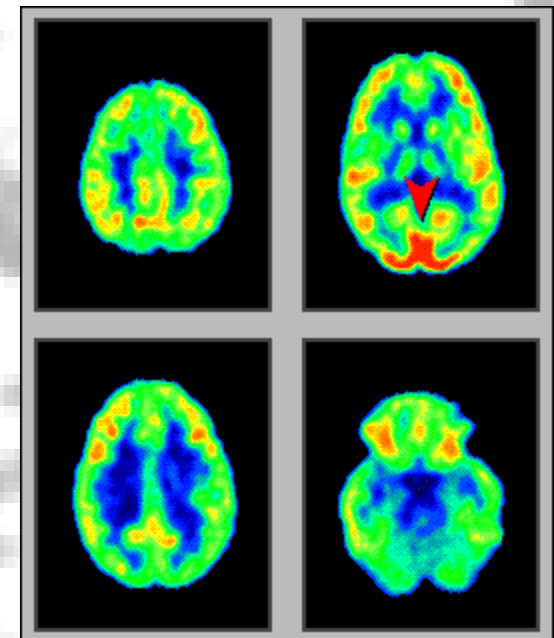

Visual stimulus

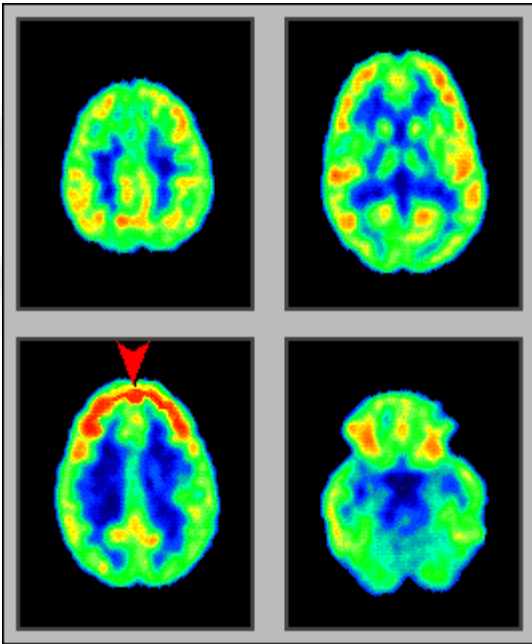

intensive thinking

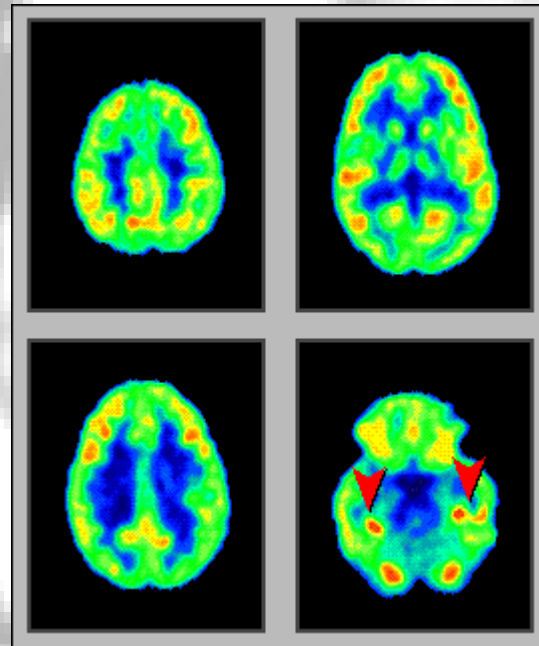

remembering a picture

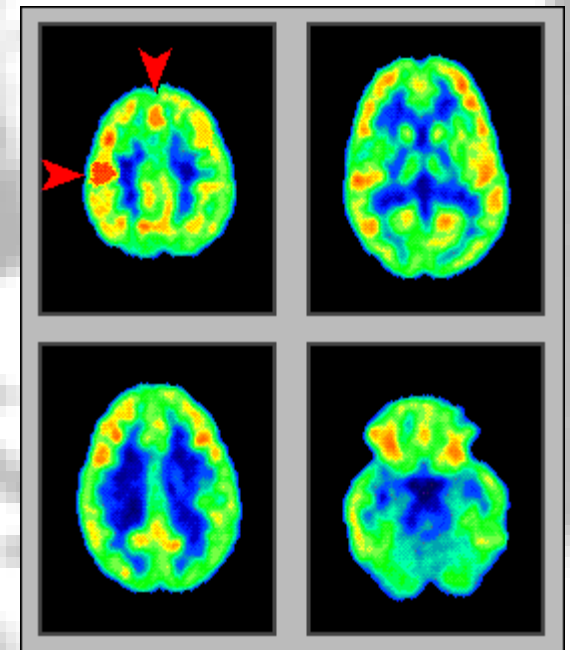

skipping on left leg

Brain tumour - astrocytoma

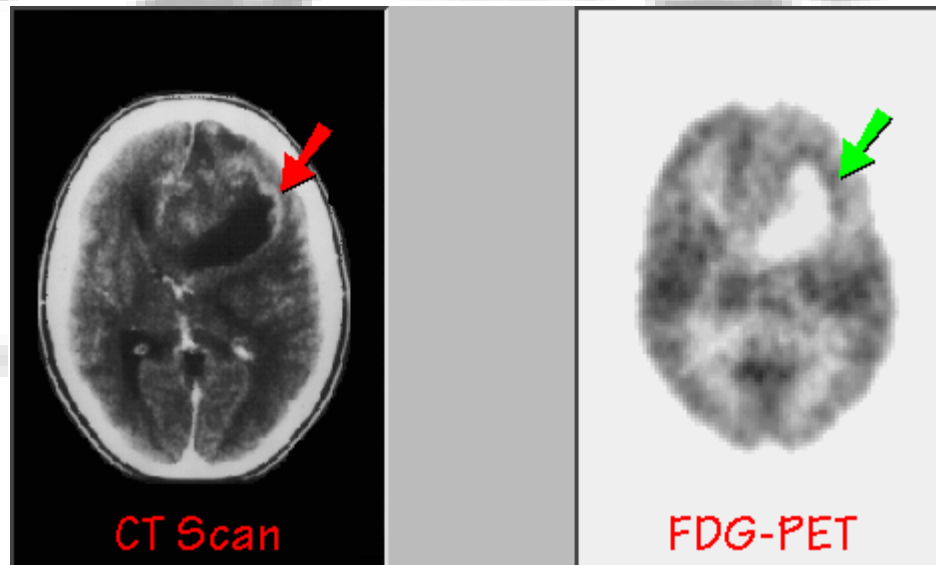

FDG – fluorodeoxyglucose, F-18

Radiotherapy



- Sources of radiation
 - radioactive
 - non-radioactive
- Methods of radiotherapy



Sources of radiation - radioactive

- Artificial radionuclides are used. The source is in direct contact with a tissue or is sealed in an envelope (open or closed sources).
- The **open sources**:
 - (1) Can be applied by metabolic way. Therapy of thyroid gland tumours by radioactive iodine I-131, which is selectively captured by the thyroid.
 - (2) Infiltration of the tumour by radionuclide solution, e.g. a prostate tumour by the colloid gold Au-198. This way of application is seldom used today as well.
- The **closed sources** are more widely used today:
 - (1) Needles with a small amount of radioactive substance. They usually contain cobalt Co-60 or caesium Cs-137. The needles are applied interstitially (directly into the tumour).
 - (2) The sources are also inserted into body cavities (**intracavitary irradiation - afterloaders**).
 - (3) Large irradiation devices ('bombs') for **teletherapy**. The radionuclide is enclosed in a shielded container. The radioactive material is moved into working position during irradiation. The most commonly used are cobalt Co-60 or caesium Cs-137. These devices are obsolete today.

„The cobalt bomb“



In 1951, Canadian Harold E. Johns used cobalt-60 for therapy first.



„The cobalt bomb“

<http://www.cs.nsw.gov.au/rpa/pet/RadTraining/>

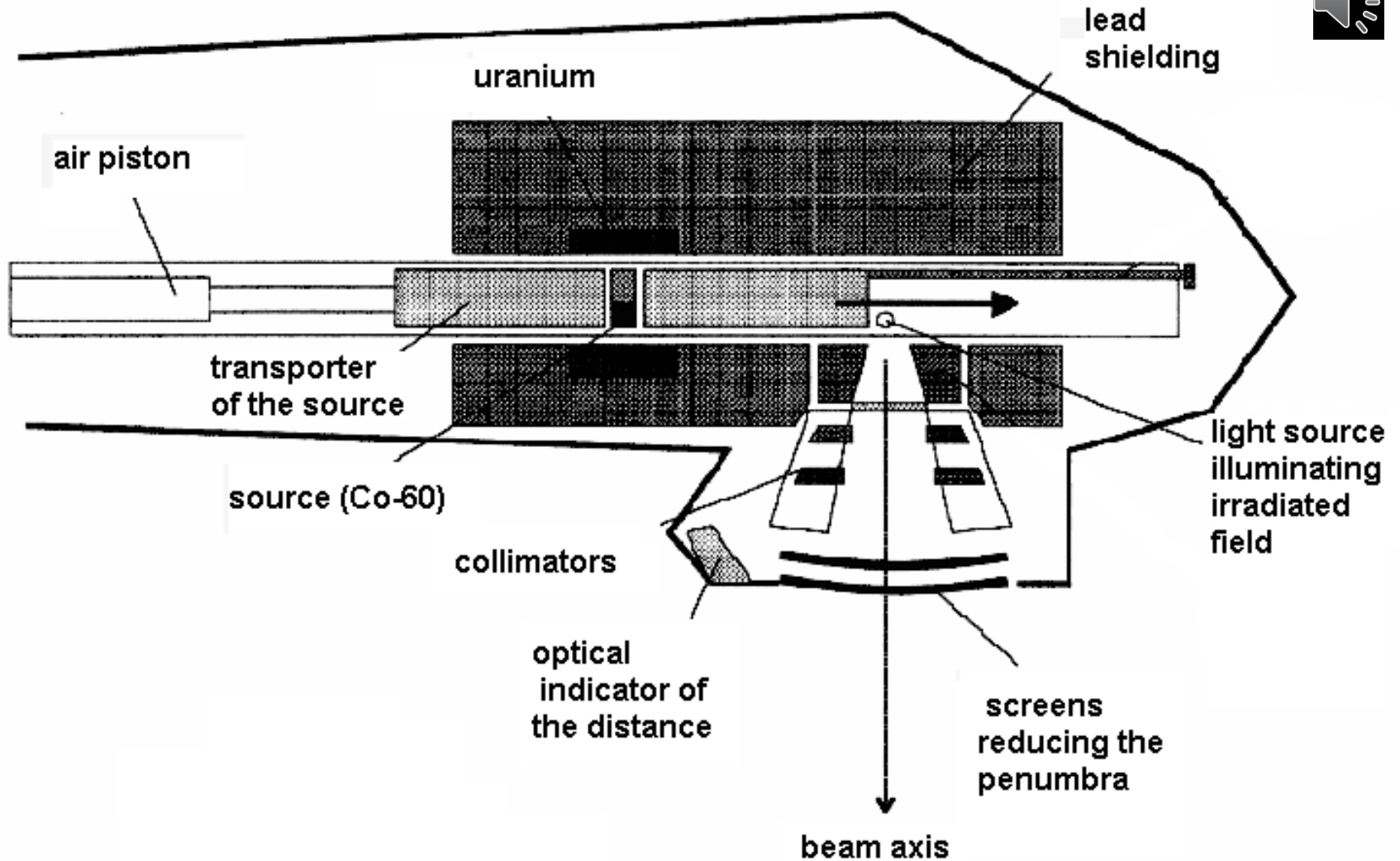

Leksell Gamma Knife (still used)



- 1951 – idea of radiosurgery by L. Leksell of Sweden
- The Leksell Gamma Knife is used for treatment of some brain tumours and other lesions (aneurysms, epilepsy etc.)
- 201 Co^{60} sources are placed in a central unit with diameter of 400 mm in 5 circles, which are separated by the angle of 7.5 degree. Each beam is collimated by a tungsten collimator with a conical channel and a circular orifice (4, 8, 14 a 18 mm in diameter). The focus is in the centre where all the channel axes (beams) intersect. The beams converge in the common focus with accuracy of 0.3 mm.
- The treatment table is equipped by a movable couch. The patient's head is fastened in the collimator helmet. It is attached to the couch, which can move inside the irradiation area.

Leksell Gamma Knife

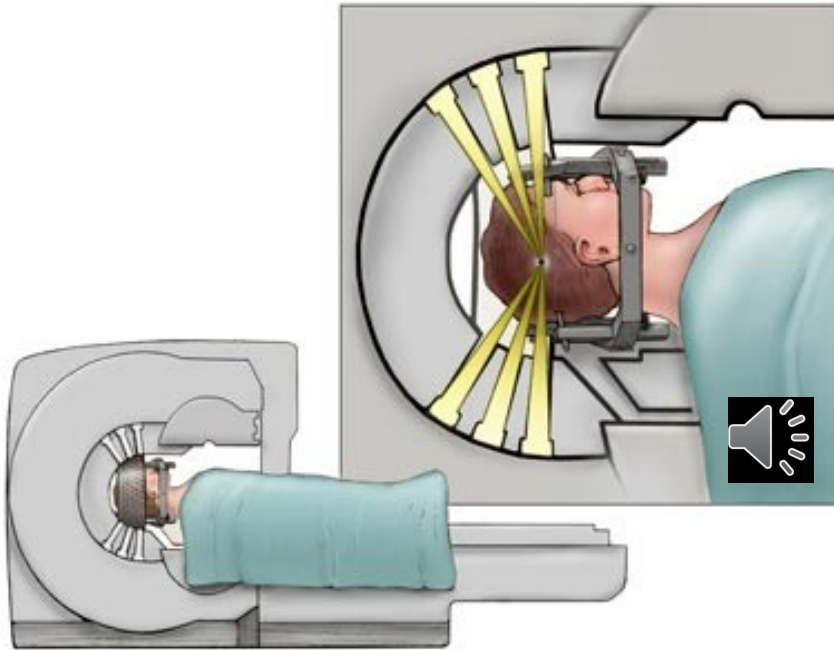

© Mayo Foundation for Medical Education and Research. All rights reserved.

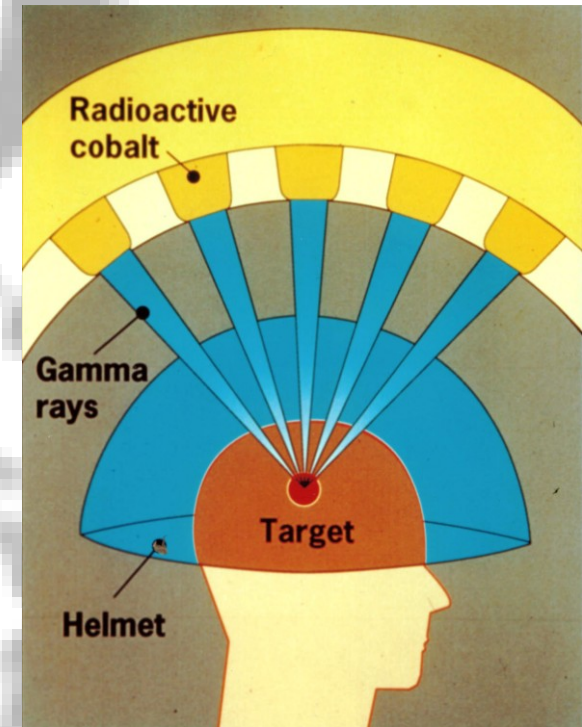

<http://www.nrc.gov/images/reading-rm/photo-gallery/20071114-040.jpg>

Leksell Gamma Knife



- A Leksell stereotactic coordinate frame is attached to patient's head by means of four vertical supports and fixation screws. The head is so placed in a 3D coordinate system, where each point is defined by coordinates x , y , z . Their values can be read on the frame. The target area can be located with an accuracy better than 1 mm.
- A radiological image of the lesion is transferred to the planning system which calculates the total dose from all the 201 sources. By connecting of points with the same dose a curve – isodose – is constructed. The borders of treated lesion should correspond with isodose showing 50-70% of dose maximum. The isodoses copy precisely the outlines of the pathologic lesion in tomographic scans.



Leksell Gamma Knife



Leksell Gamma Knife





Afterloader

works with Ir-192. An instrument for safe intracavitary irradiation.



main unit



applicators



phantom



Control unit



Radiation sources – non-radioactive

- A) X-ray tube devices:** Therapeutic X-ray tubes differ in construction from diagnostic X-ray tubes. They have larger focus area, robust anode and effective cooling. They are (were) produced in three sorts:
- low-voltage (40 - 100 kV) for contact surface therapy. The radiation is fully absorbed by a soft tissue layer 2 - 3 cm thick. e.g., Chaoul lamp.
 - medium-voltage (120 - 150 kV) for brachytherapy – from distance of max. 25cm. They were used to irradiate tumours at max depth 5 cm.
 - ortho-voltage (160 - 400 kV) for teletherapy (deep irradiation from distance). These have been replaced by the radionuclide sources and accelerators.
- B) Electron Accelerators:** X-rays with photon energy above 1 MeV and γ -radiation with photon energy above 0.66 MeV are used for megavoltage therapy. Their sources are mainly electron accelerators. The accelerated electrons are usually not used for direct irradiation but the production of high-energy X-rays.

The linear accelerator



CLINAC 2100C in Masaryk memorial institute of oncology in Brno



The linear accelerator

<http://www.cs.nsw.gov.au/rpa/pet/RadTraining/MedicalLinacs.htm>

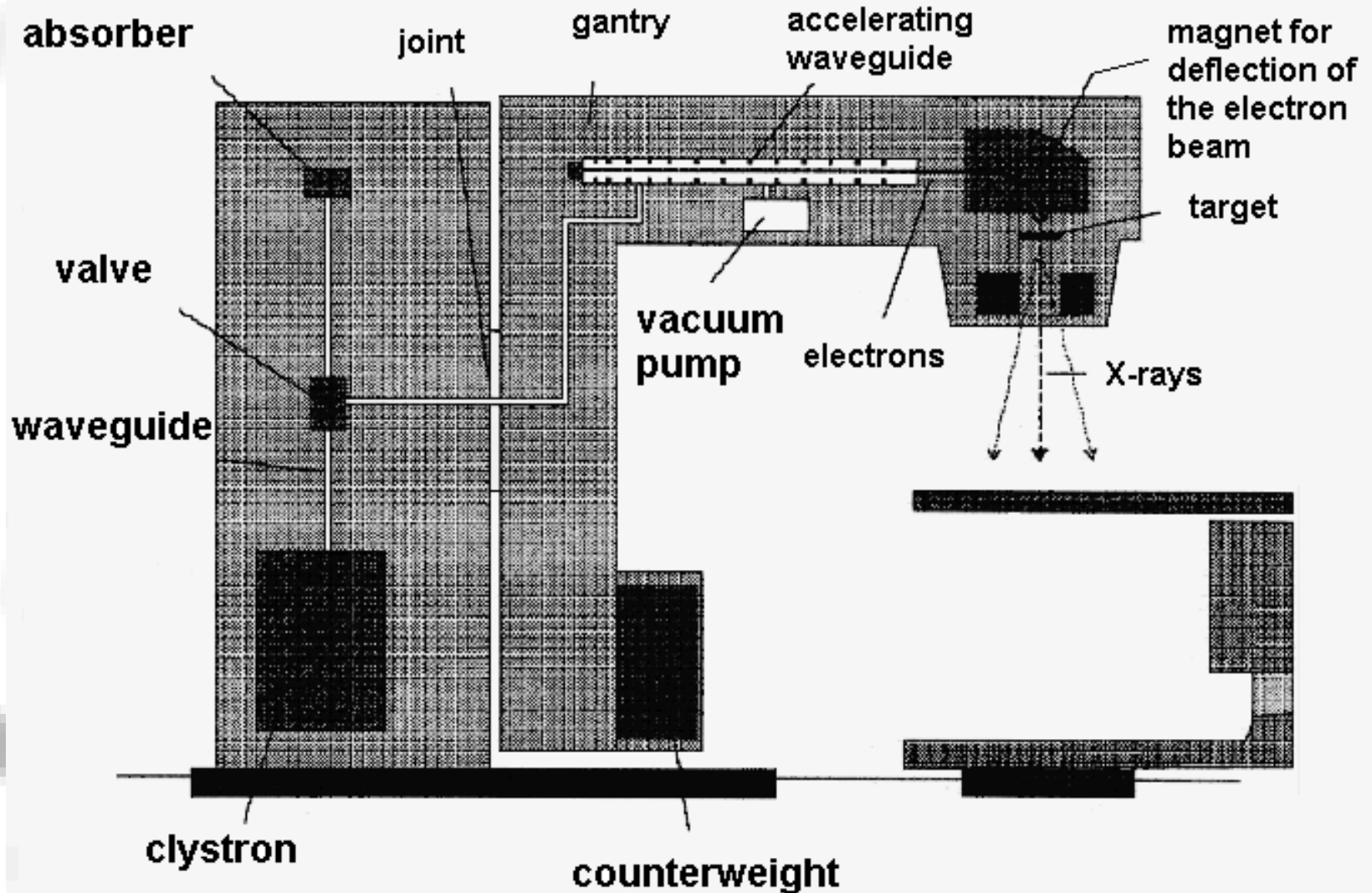



The cyclotron

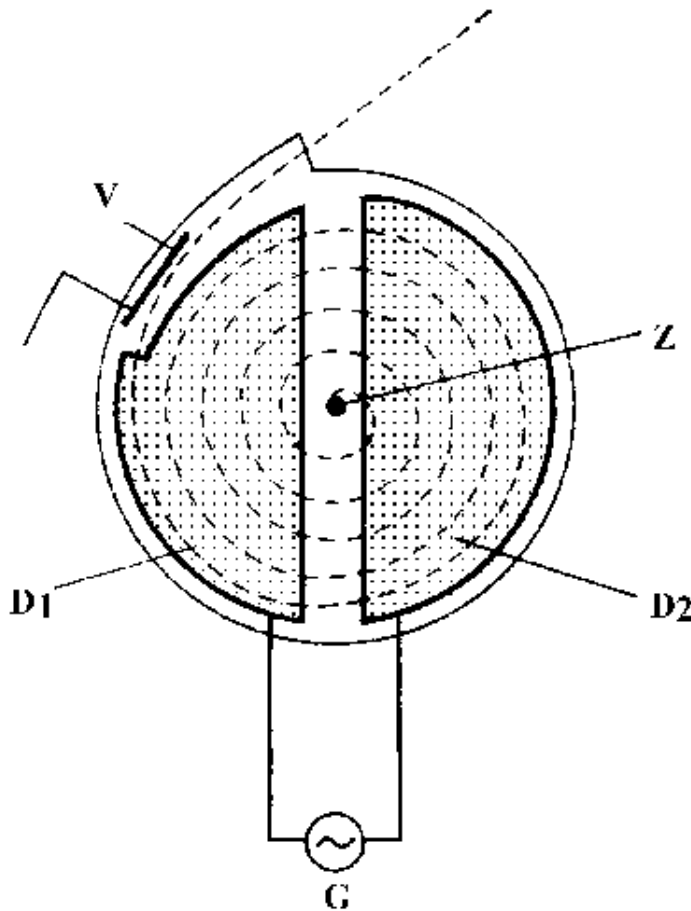

Z – source of the accelerated particles (protons),

D₁ and D₂ – duants or dees,

G - generator of high-frequency voltage.

$$f = \frac{Bq}{2\pi m}$$

The cyclotron

<http://www.aip.org/history/lawrence/first.htm>



1933 – one
of the first
cyclotrons in
background



Ernest O. Lawrence
(1901-1958)





The cyclotron in oncology – proton (hadron) therapy



The Sumitomo cyclotron

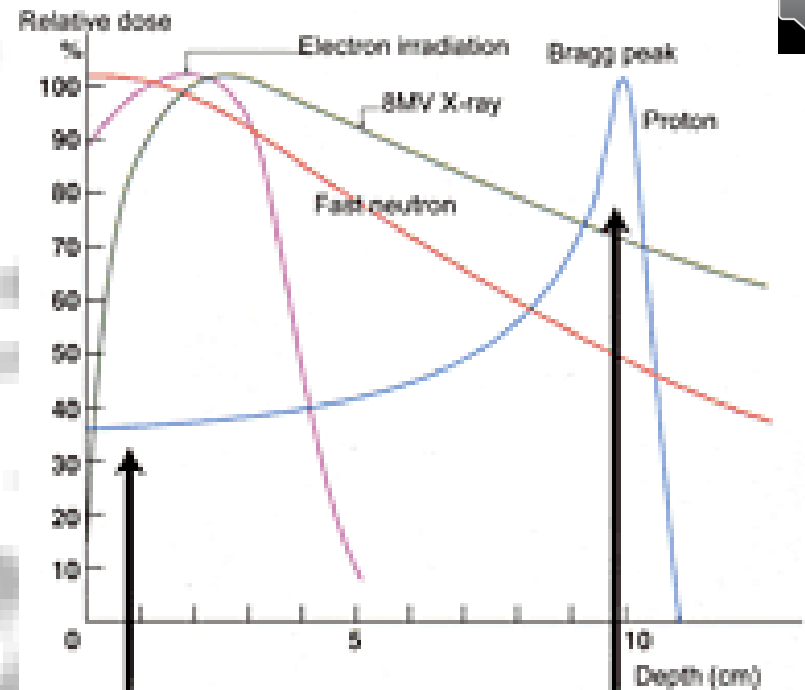

Hadron radiotherapy



Hadrons (protons and light ions) lose their energy mainly in collisions with nuclei and electron shells. The collisions with electrons are dominant for energies used in radiotherapy. The energy deposited is indirectly proportional to the second power of hadron velocity. It means practically that the hadrons deposit most of their energy shortly before end of their tracks in the tissue. This fact is exploited in hadron therapy because (in contrary to the conventionally used photons) the tissues lying in front of the **Bragg peak** receive a much smaller dose compared with the target area. The tissues behind the target are not irradiated. The target can be precisely determined and thus damage to the surrounding healthy tissue is minimised. The Bragg peak area is given by energy of the particle. In therapy, the necessary penetration depth is about 2 – 25 cm, which corresponds to an energy of 60 – 250 MeV for protons and 120 – 400 MeV for light ions.



Radiotherapy planning for X-ray beams

After tumour localisation, the radiotherapist determines the best way of irradiation in co-operation with a medical physicist. The tumour has to receive maximum amount of radiation but the healthy tissues should be irradiated minimally and some should be totally avoided. When irradiating the tumour from only one side, the tissues in front of it would receive higher dose than the tumour and the near side of the tumour more than the far one. That is why irradiation is performed from different directions. The skin area, through which the radiation beam enters the body, is called the **irradiation field**; irradiation from different directions (2, 3, 4) is called multi-field treatment. In some cases (tumours of oesophagus and prostate) the multi-field treatment is replaced by moving beam treatment – the source of radiation moves above or around the patient in circle or arc (tumour-centred) during irradiation. The radiotherapeutic plan involves the energy of radiation, daily and total dose of radiation, number of fractions etc.

Simulator

X-ray simulator is an XRI device having the same geometry as the accelerator. It is used to locate the target tissues which should be irradiated. To ensure always the same patient positioning both in the simulator and the accelerator, there is a system of laser lights in the room. An identical system of laser beams is used in the accelerator room.



Radiotherapeutic simulator Acuity 56

Geometry of irradiation



For irradiation of surface tumours, we have to use radiation of low energy, for deep tumours, the energy must be substantially higher.

In radiotherapy, mainly X-ray sources are used (the accelerators for the so-called megavoltage therapy) as well as the cobalt-60 γ -radiation sources. The radiation dose is optimised by means of simulators. To achieve maximum selectivity of deep tumour irradiation, the appropriate **irradiation geometry** must be applied:

- **Focal distance effect.** Intensity of radiation decreases with the square of source distance. The ratio of surface and deep dose is higher when irradiating from short distance. Therefore, surface lesions are irradiated by soft rays from short distances (**contact therapy, brachytherapy**). Deep tumours are treated by penetrating radiation from longer distance (**teletherapy**).
- Irradiation from different directions or by a moving source. The lesion must be **precisely localised**, the irradiation conditions must be reproducible. **Advantage:** The dose absorbed in the lesion (tumour) is high – radiation beams intersect there. Dose absorbed in surrounding tissue is lower.



Geometry of irradiation

The effectiveness of repair processes in most normal tissues is higher than in tumours. Therefore, partition (fractionation) of the therapeutic dose in certain number of fractions or use of „moving beam treatment“ spares the normal tissue.

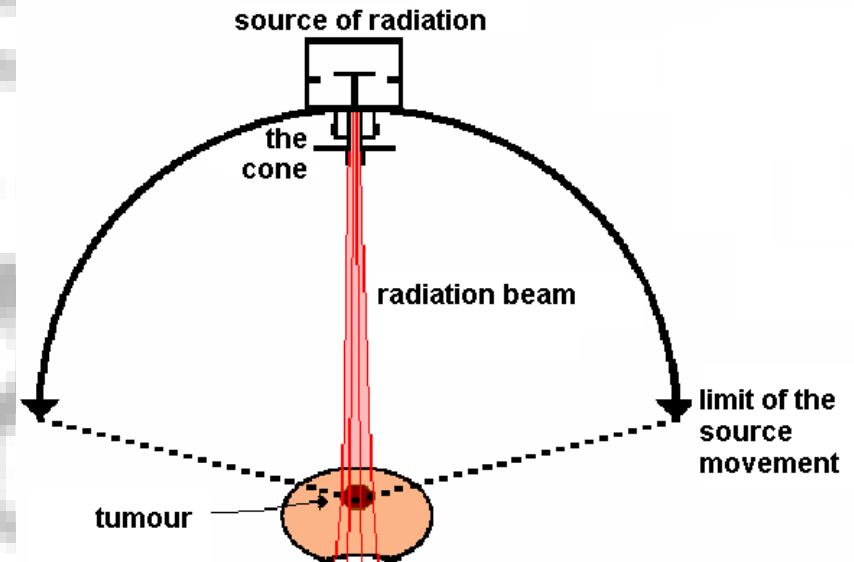

„moving beam treatment“

Authors:

Vojtěch Mornstein, Ivo Hrazdira

Content collaboration and language revision:
Carmel J. Caruana

Presentation design:
Lucie Mornsteinová

Last revision: December 2018