

# Cytogenetics and molecular genetics in oncology

Karla Plevová

# Outline of the presentation

1. Differences in molecular genetics and cytogenetics of congenital disorders vs cancer
2. Application of molecular-genetic and cytogenetic findings in oncology
3. Material sources and material used
4. Methods used and practical examples

MG: molecular genetics  
CG: cytogenetics

# Cancer as a genetic disease

Two levels:      Cancer hereditary syndromes – germline mutations  
Genetic alterations gained during a lifetime - somatic

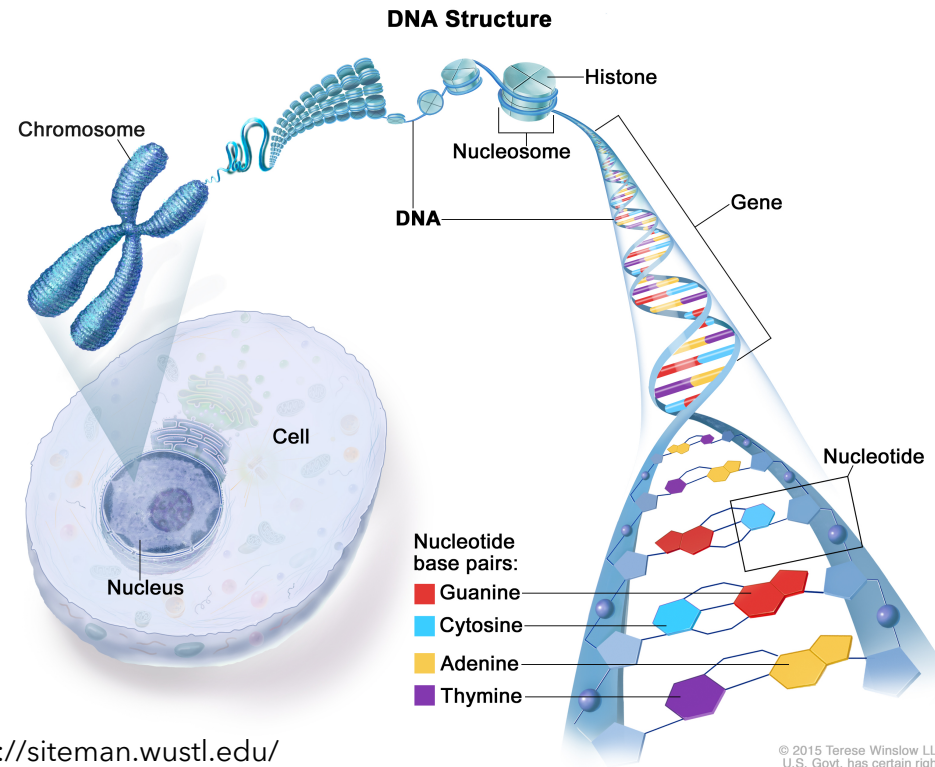

Why molecular genetics and cytogenetics in oncology can be interesting for a dentist?



Acute myeloid leukemia (AML) manifesting by blast infiltration in gums.

# 1. Differences in MG and CG of congenital disorders vs cancer

Characteristics	Congenital disorders	Cancer
Prevailing origin of genetic defects	Germline	Somatic
Extent of genetic abnormalities	Single or small number of changes	Variable, typically higher
Type of abnormalities	One/two types present per case	Combination of all types
Mosaicism	Rare	Common

## **2. Application of MG and CG findings in oncology**

- Hereditary predisposition assessment
- Establishing and refining diagnosis
- Disease prognostication
- Treatment optimization
- Disease activity monitoring
- Disease complication diagnostics

# Requirements on the techniques

- High specificity and high sensitivity, limit of detection
- Fast processing - range of few hour to few days
- Tools for data analysis (bioinformatics for NGS)
- Standardization and validation
- Availability of reference material (positive/negative controls),  
reference sequences
- Regular quality assessment
- Compliance with legislation regulations

# Hereditary predisposition assessment

- Cases of cancer accumulated in families
- Autosomal dominant and recessive inheritance
- Typical onset at young age
- Genetic counseling
- Screening for causative variants

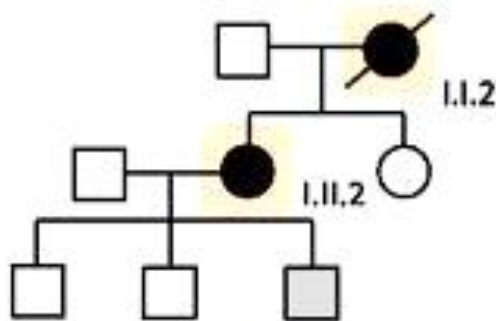
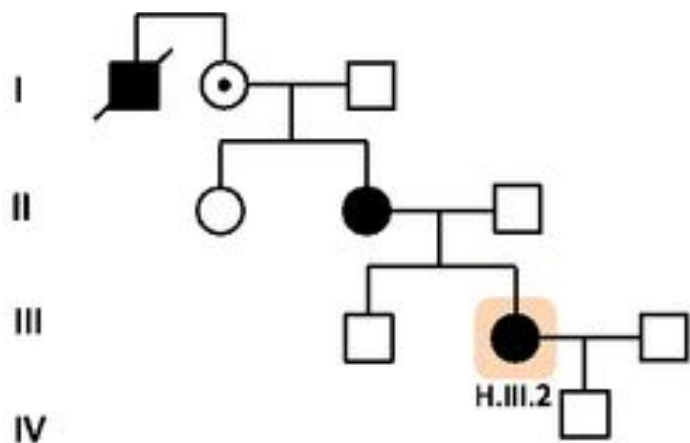

Tawana et al, Blood 2015

## Breast-Cancer Susceptibility Loci and Genes.

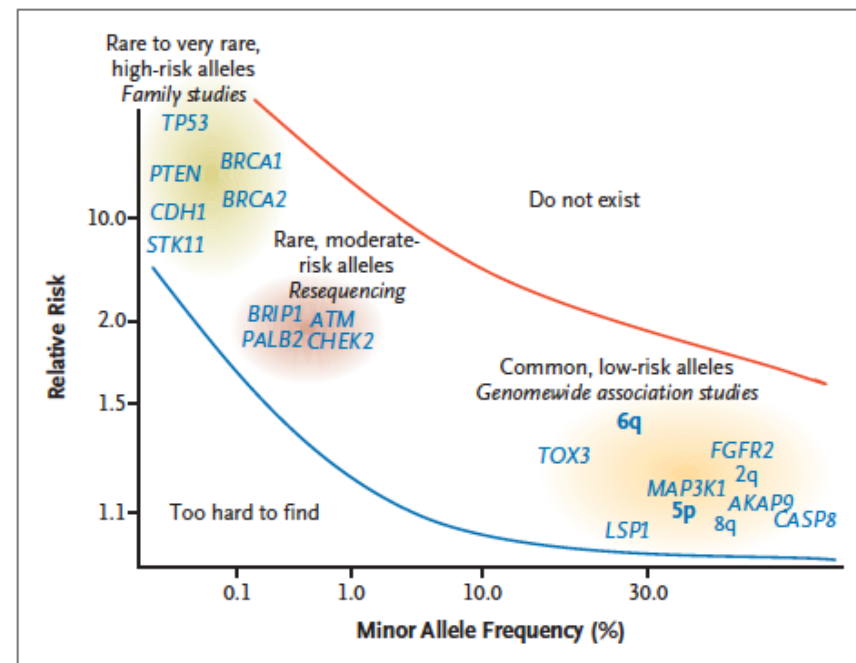

Foulkes, NEJM 2008



# Hereditary predisposition assessment

## WHO classification of myeloid neoplasms with germ line predisposition and guide for molecular genetic diagnostics

WHO classification
<b>Classification*</b>
Myeloid neoplasms with germ line predisposition without a preexisting disorder or organ dysfunction
AML with germ line <i>CEBPA</i> mutation
Myeloid neoplasms with germ line <i>DDX41</i> mutation <sup>†</sup>
Myeloid neoplasms with germ line predisposition and preexisting platelet disorders
Myeloid neoplasms with germ line <i>RUNX1</i> mutation <sup>†</sup>
Myeloid neoplasms with germ line <i>ANKRD26</i> mutation <sup>†</sup>
Myeloid neoplasms with germ line <i>ETV6</i> mutation <sup>†</sup>
Myeloid neoplasms with germ line predisposition and other organ dysfunction
Myeloid neoplasms with germ line <i>GATA2</i> mutation
Myeloid neoplasms associated with bone marrow failure syndromes
Juvenile myelomonocytic leukemia associated with neurofibromatosis, Noonan syndrome, or Noonan syndrome-like disorders
Myeloid neoplasms associated with Noonan syndrome
Myeloid neoplasms associated with Down syndrome <sup>†</sup>

**Table 2** - ACMG list of hereditary cancer syndromes, most with childhood onset, for reporting incidental findings.

Syndrome	Gene	Inheritance
Li-Fraumeni	<i>TP53</i>	AD
Peutz-Jeghers	<i>STK11</i>	AD
Familial adenomatous polyposis	<i>APC</i>	AD
Von-Hippel Lindau	<i>VHL</i>	AD
Multiple endocrine neoplasia	<i>MEN1</i> (type 1); <i>RET</i> (type 2)	AD
Hamartomatosis	<i>PTEN</i>	AD
Retinoblastoma	<i>RB</i>	AD
Paraganglioma-pheochromocytoma	<i>SDHAF2</i> , <i>SDHB</i> , <i>SDHC</i> , <i>SDHD</i>	AD
Tuberous sclerosis complex	<i>TSC1</i> , <i>TSC2</i>	AD
Neurofibromatosis type 2	<i>NF2</i>	AD
WT1-related Wilms tumor	<i>WT1</i>	AD

AD, autosomal dominant.

# Establishing and refining diagnosis

- Diagnosis confirmation based on detection of specific (marker) gene or chromosomal abnormalities
- Incorporation of genetic/cytogenetic markers in WHO classification
- Resolving ambiguous cases
- Markers specific for the whole diagnostic entity or only for a subset of a disease (implications for treatment)
- Examples
  - Mantle cell lymphoma - translocation t(11;14)
  - Hairy cell leukemia - BRAF V600E mutation

# Establishing and refining diagnosis

## Clonality

- Typical characteristics of lymphoid (but also other) malignancies
- Analysis of antigen receptor rearrangements, translocations and gene mutations
- Monoclonal vs polyclonal picture - distinguishing of malignant vs reactive conditions
- Quantification of tumor load

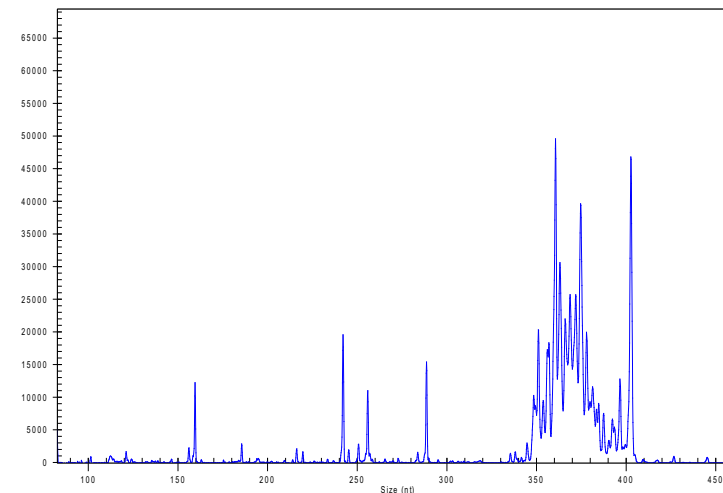
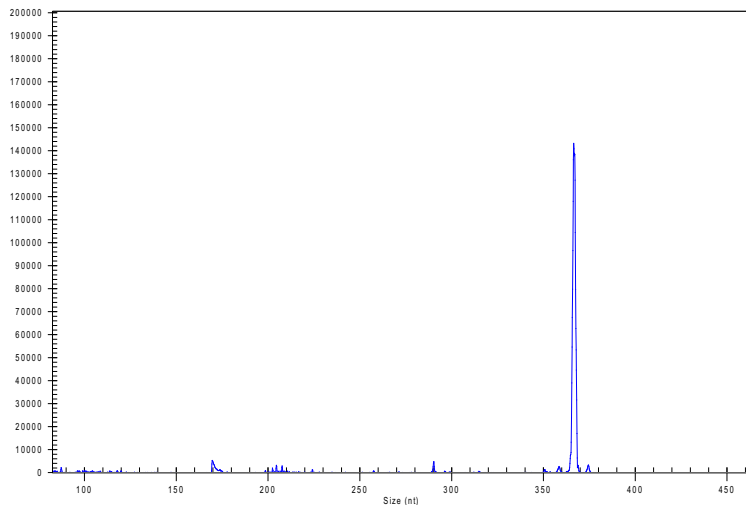

# Disease prognostication

- Genetic and cytogenetic markers associated with certain disease features
- Risk assessment at time of diagnosis
- Genetic markers of various types - gene mutations, chromosomal abnormalities, a type of antigen receptor rearrangement, ...
- Prognostic vs predictive markers

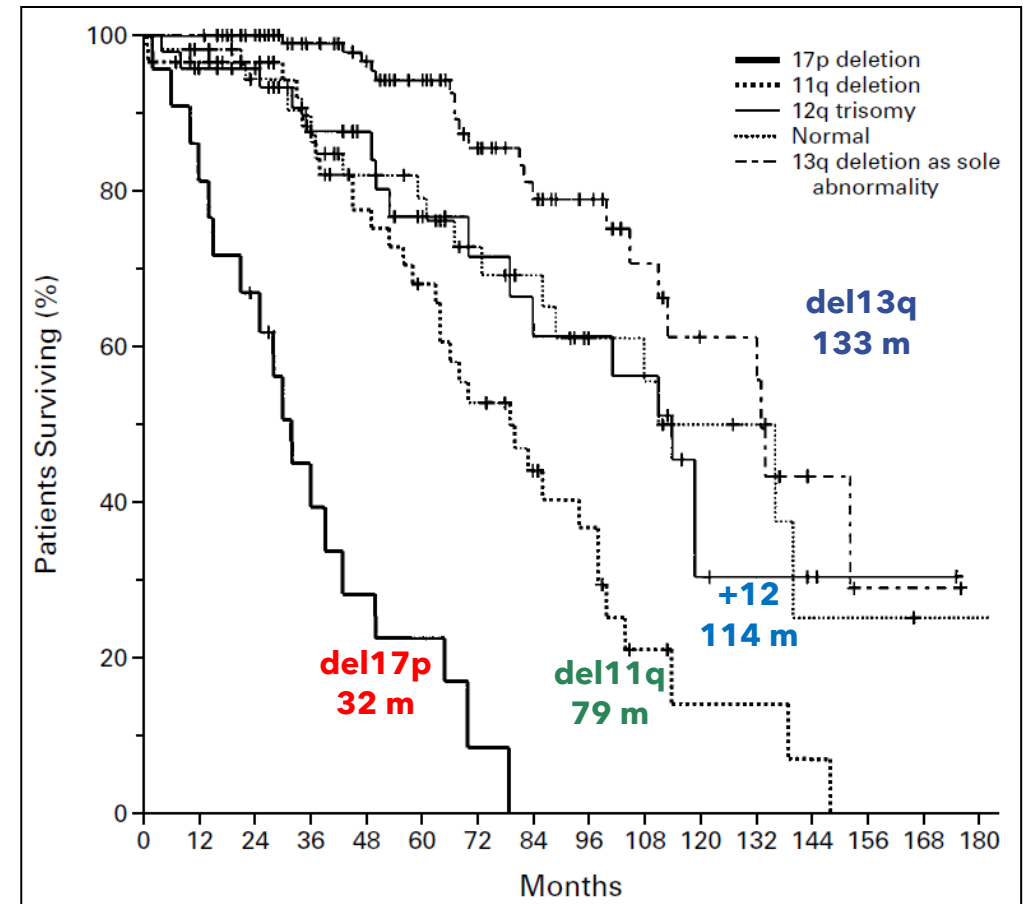

# Disease prognostication

CLL:

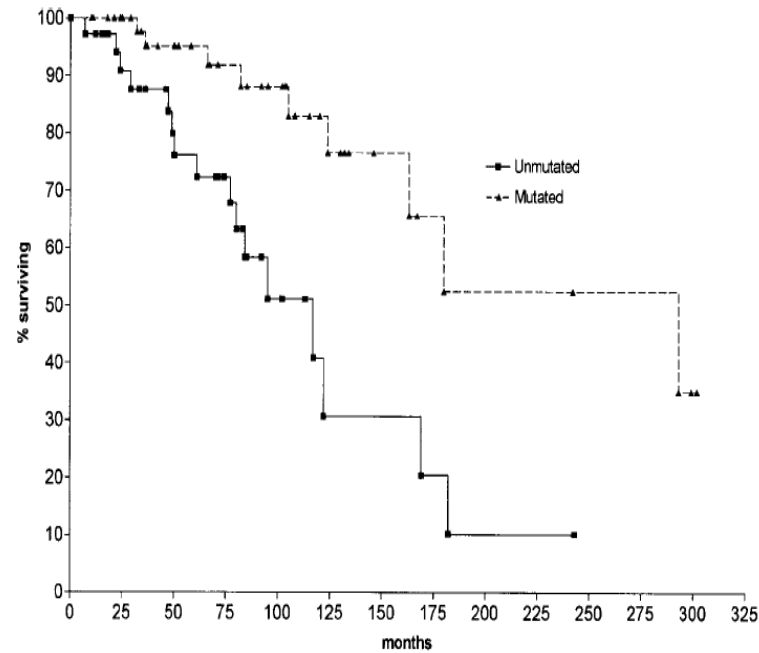

Hamblin et al, Blood 1999

AML:

Risk category	Cytogenetic or molecular genetic abnormality
Favourable	$t(8;21)(q22;q22)$ ; <i>RUNX1-RUNX1T1</i> $inv(16)(p13.1;q22)$ or $t(16;16)(p13.1;q22)$ ; <i>CBFB-MYH11</i> $t(15;17)(q24;q21)$ <i>PM-RARA</i> Mutated <i>NPM1</i> without <i>FLT3-ITD</i> (normal karyotype)
Intermediate	Biallelic mutated <i>CEBPA</i> (normal karyotype) Mutated <i>NPM1</i> and <i>FLT3-ITD</i> (normal karyotype) Wildtype <i>NPM1</i> and <i>FLT3-ITD</i> (normal karyotype) Wildtype <i>NPM1</i> without <i>FLT3-ITD</i> (normal karyotype) Normal karyotype not classified as favourable.
Poor	$t(9;11)(p22;q23)$ ; <i>MLL3-KMT2A</i> Cytogenetic abnormalities not classified as favourable or poor $inv(3)(q21q26.2)$ or $t(3;3)(q21;q26.2)$ ; <i>GATA2-MECOM (EVI1)</i> $t(6;9)(p23;q34)$ ; <i>DEK-NUP214</i> $t(v;11)(v;q23)$ ; <i>KMT2A</i> rearranged $t(9;22)(q34.1;q11.2)$ ; <i>BCR-ABL1</i> -5 or $del(5q)$ ; -7; -17/ $abn(17p)$ Complex karyotype (>3), monosomal karyotype Wild type <i>NPM1</i> and <i>FLT3-ITD</i> Mutated <i>RUNX1</i> Mutated <i>ASXL1</i> Mutated <i>TP53</i>

# Treatment optimization

- Concept of personalized treatment - tailored for individual patients
- Treatment response related to genetic abnormalities detected in cancer cells
- Targeted treatment - blocking the growth and spread of cancer by interfering with specific molecules ("molecular targets")
- Synthetic lethality - blocking or inactivation of two genes leads to cell death

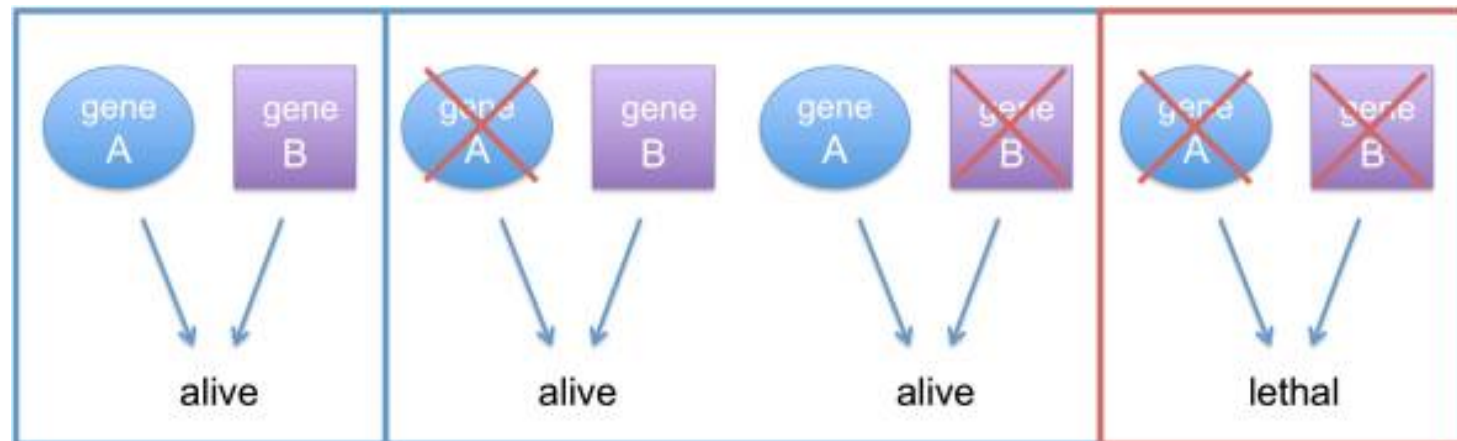

# Treatment optimization - examples

Diagnosis	Genetic defect	Treatment option
Chronic myeloid leukemia	BCR-ABL fusion gene	Tyrosine kinase inhibitors (imatinib, dasatinib etc.)
Breast cancer	BRCA1 mutations	PARP inhibitor olaparib
Non-small cell lung cancer	EGFR mutations	EGFR inhibitors (erlotinib, afatinib etc.)
Non-small cell lung cancer	ALK gene rearrangements	ALK inhibitors (crizotinib, ceritinib etc.)
Melanoma	BRAF mutations	BRAF inhibitors (dabrafenib, vemurafenib etc.)
Colorectal cancer	KRAS mutations	Contraindication for targeting EGFR by cetuximab and panitumumab

# Disease activity monitoring

- Minimal residual disease (MRD) - cancer cells remaining after therapy
- Need for MRD marker identification before therapy
- Monitoring of MRD markers after therapy
- Design of patient-specific and sensitive assays
- Typical markers:
  - Gene rearrangements
  - Fusion genes
  - Gene mutations

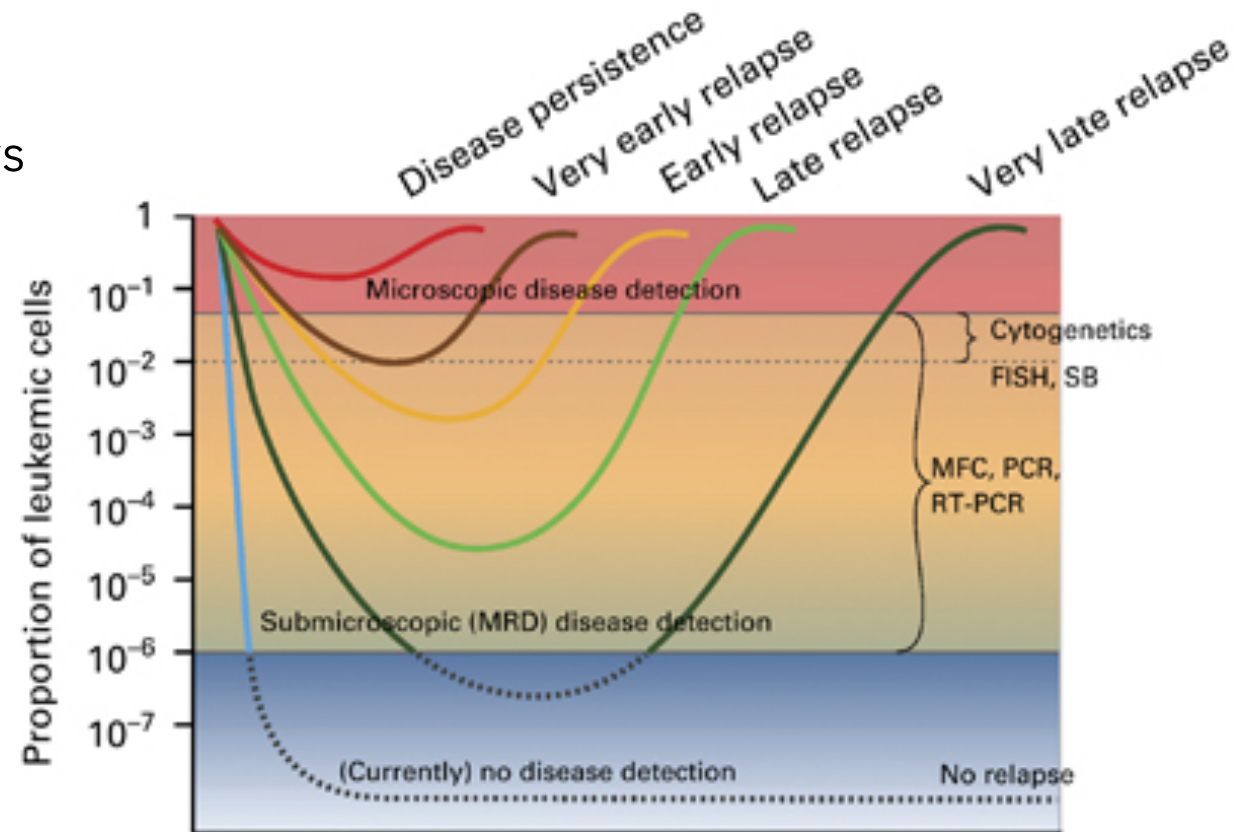



# Disease complication diagnostics

Infection complications related to cancer treatment

- Opportunistic infections - otherwise common pathogen causing severe symptoms
- Related to bone marrow (BM) and peripheral blood stem cell (PBSC) transplantation and other cancer-specific treatment (e.g. alemtuzumab)

Molecular diagnostics - typing of pathogens

according to their DNA/RNA sequence

- (multiplex) PCR, real-time PCR, NGS
- Quantification and monitoring of pathogen load

Table 2.  
Pathogen Frequency by Treatment Arm

Organism	BM	PBSC
Bacterial infections		
<i>Staphylococcus</i> (coagulase negative)	123 (82)	101 (67)
<i>Enterococcus</i> (all species)	54 (42)	49 (40)
<i>Clostridium difficile</i>	69 (52)	54 (41)
<i>Staphylococcus</i> (coagulase positive)	10 (9)	30 (20)
<i>Escherichia</i> (also <i>E. coli</i> )	16 (15)	23 (19)
Viral infections		
CMV	78 (61)	81 (57)
Polyomavirus	27 (25)	27 (24)
Herpes simplex (HSV1, HSV2)	16 (14)	22 (17)
EBV	15 (12)	21 (15)
Influenza	22 (19)	13 (13)
Fungal/parasitic infections		
Other (suspected) fungus	12 (11)	13 (12)
Yeast other than <i>Candida albicans</i>	5 (4)	12 (10)
<i>Candida albicans</i>	6 (6)	10 (8)
<i>Aspergillus fumigatus</i>	5 (5)	6 (5)
Mucormycosis ( <i>Zygomycetes</i> , <i>Rhizopus</i> )	5 (4)	2 (2)
<i>Pneumocystis</i>	1 (1)	2 (2)
<i>Toxoplasma</i>	1 (1)	1 (1)

HSV indicates herpes simplex virus; CMV, cytomegalovirus; EBV, Epstein Barr virus.

Only the top 5 organisms for each infection type are listed.

### 3. Materials used and material sources

- Types of samples
  - Cells
  - DNA
  - RNA
  - cfDNA

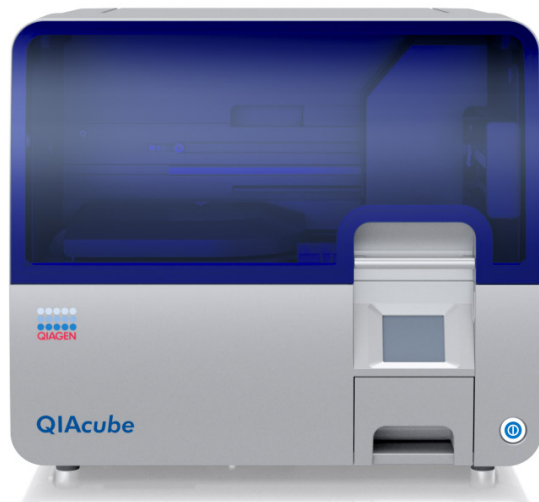
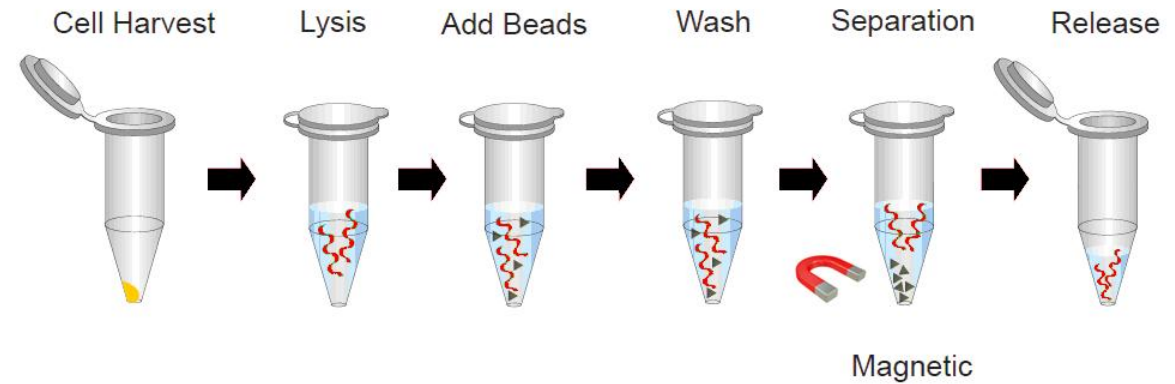
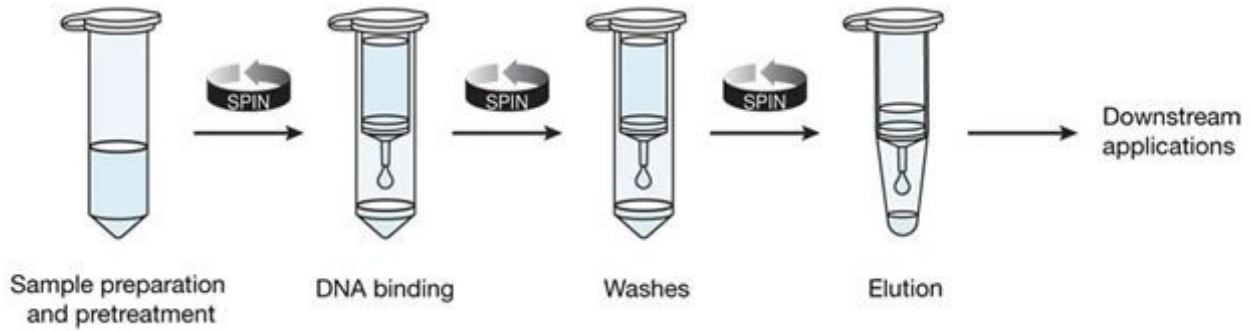

# Materials used and material sources

- Sampling
  - Peripheral blood
  - Bone marrow
  - Liquid biopsies
  - Aspirates
  - Fine-needle biopsies
  - Fresh tissue
  - Formalin-fixed paraffin-embedded (FFPE) tissue
  - Swabs (buccal, NPh, ...)

# Peripheral blood

- EDTA or heparin collection tubes
- Different cell population used according to the application:
  - Leukocytes
  - Mononuclear cells
  - Granulocytes
  - Lymphocytes
  - Specific cell subpopulations

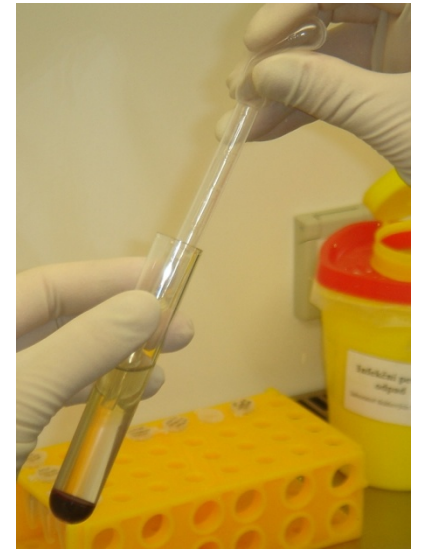

# Why to perform cell separation?

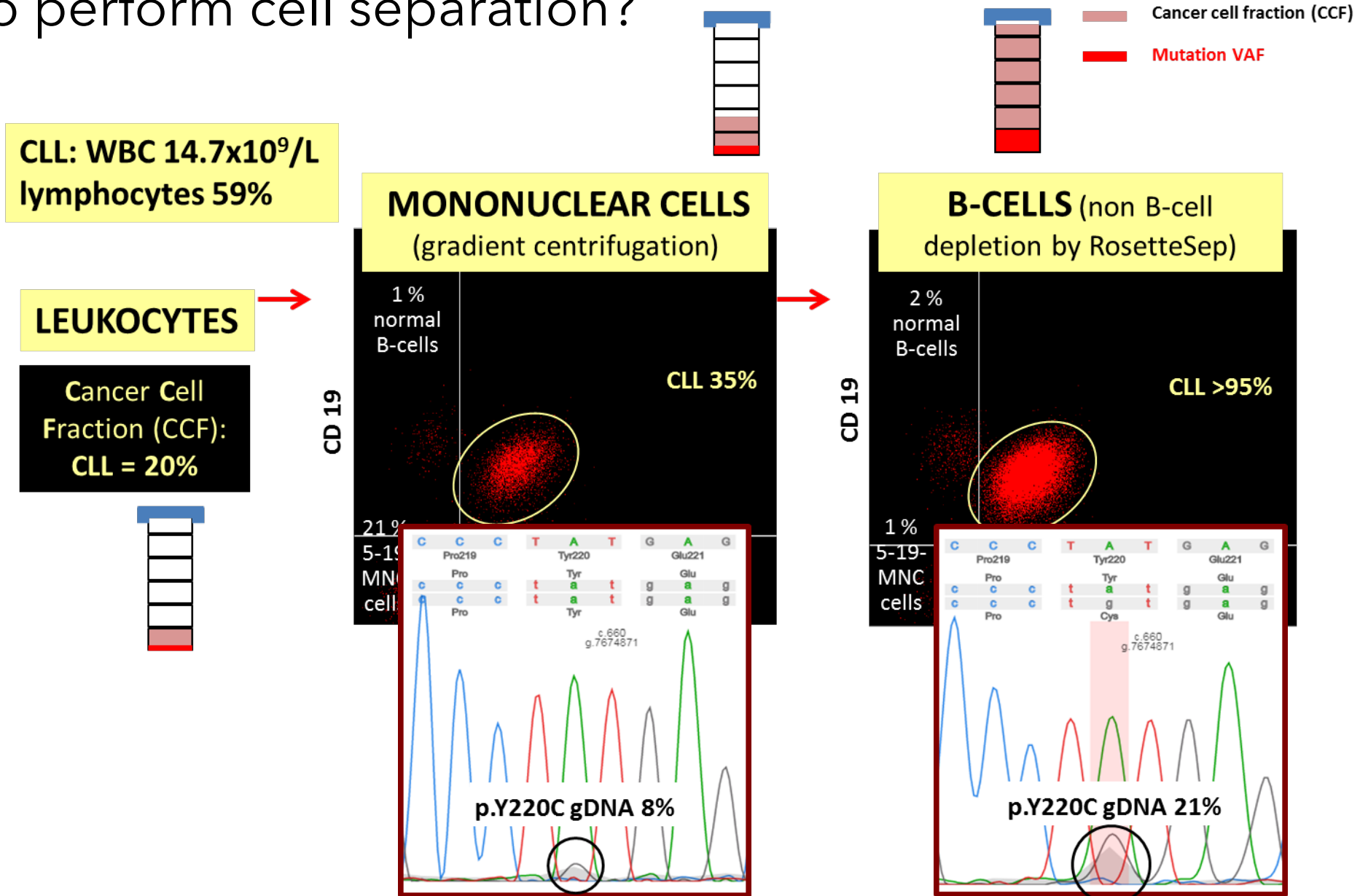

# Liquid biopsies

Very low amount of material

- Plasma / serum
- Urine
- Joint fluid
- Cerebrospinal fluid
- ...

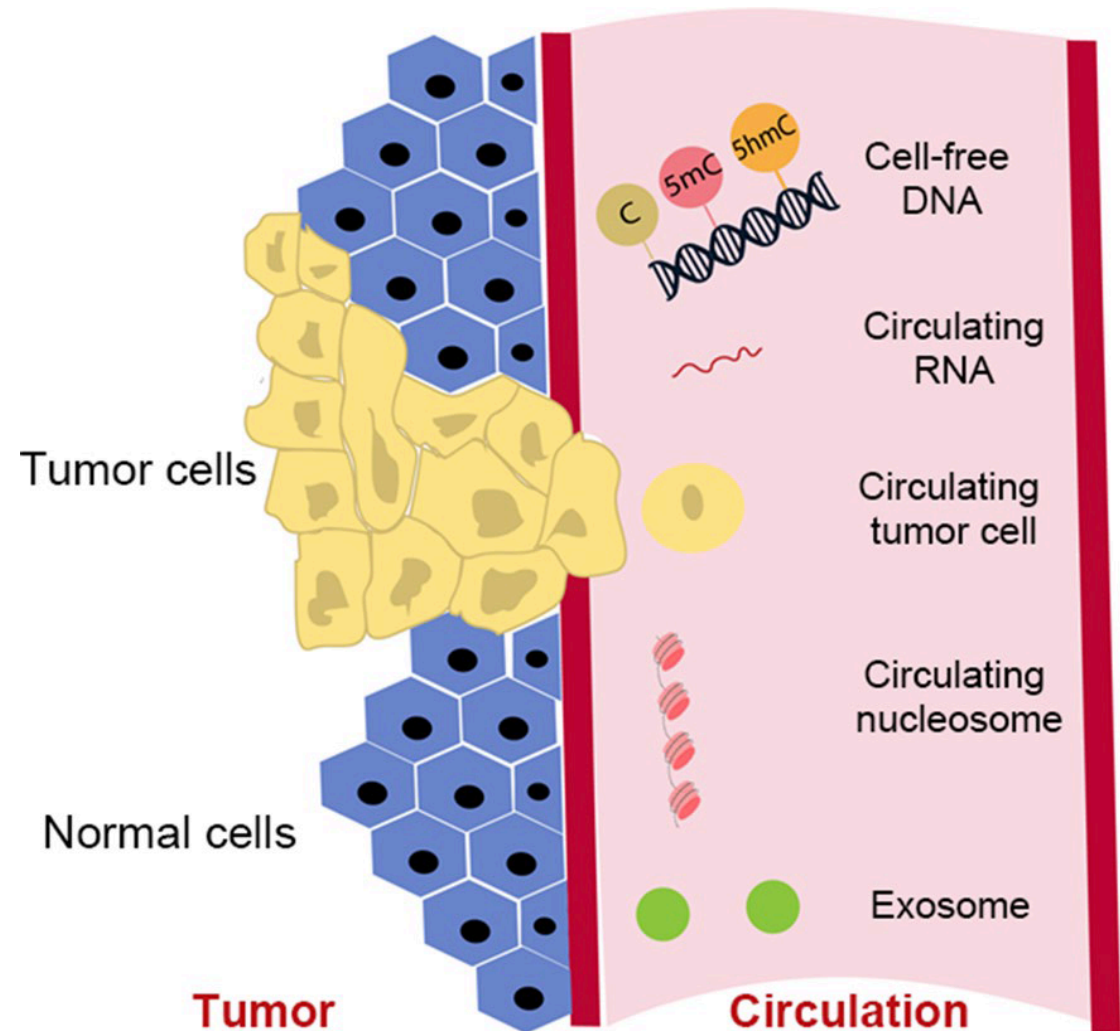

# Liquid biopsies - material collection

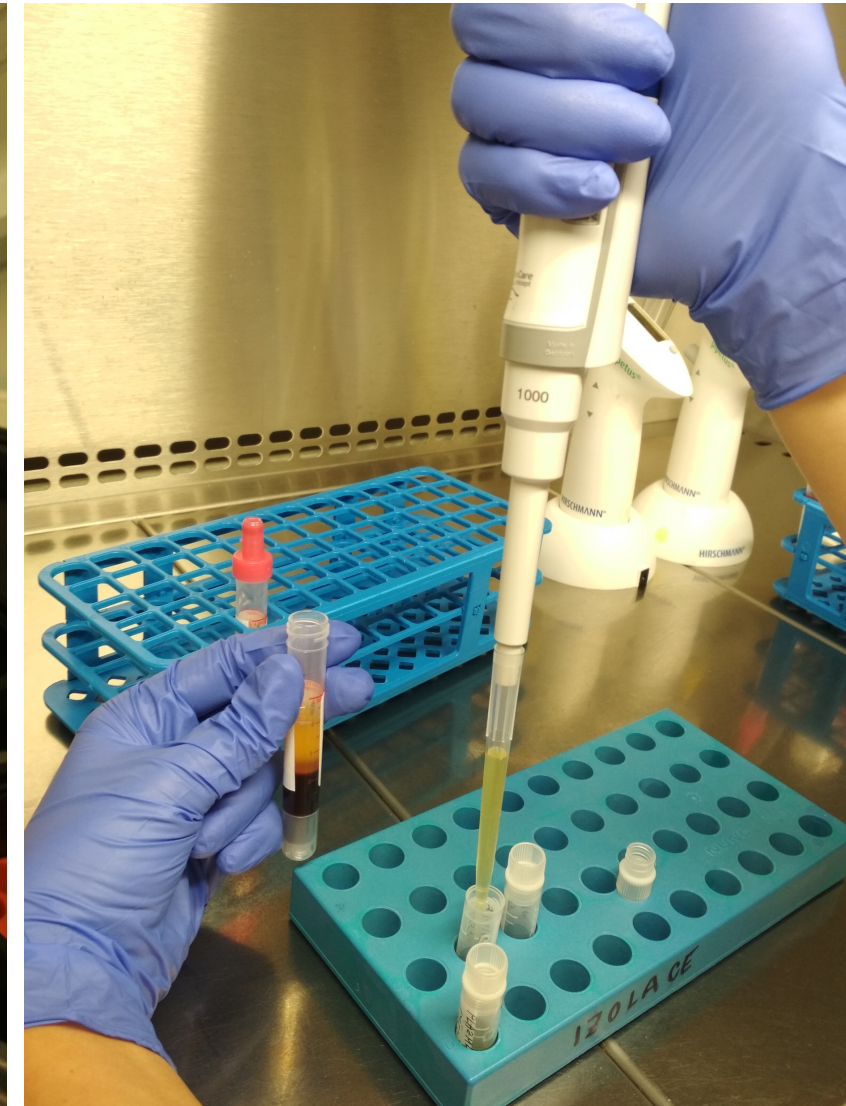
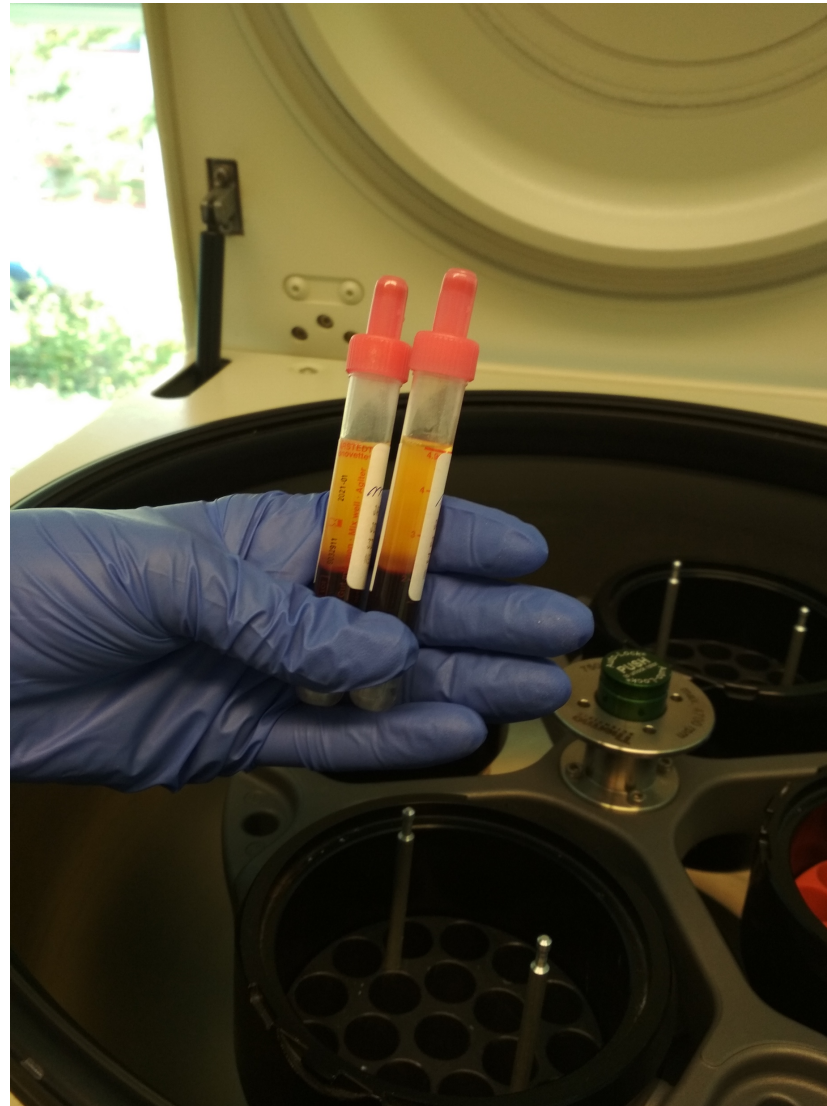

# cfDNA

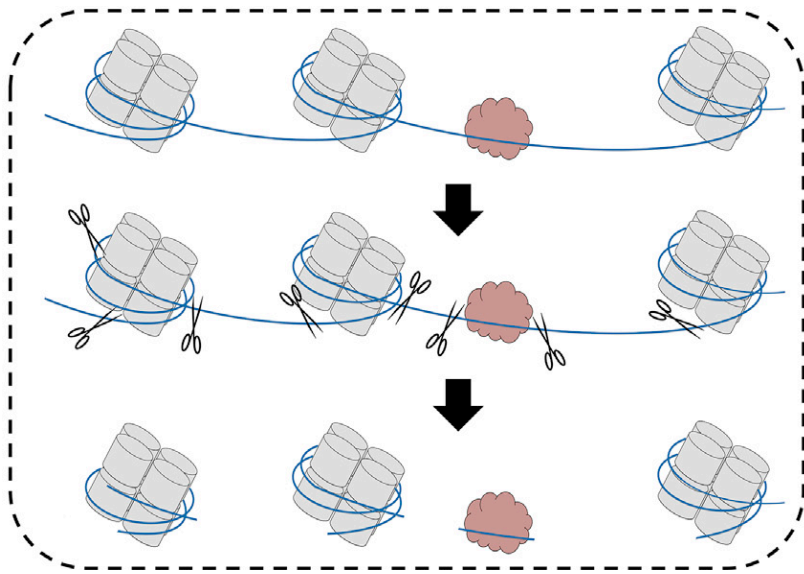

Snyder et al, Cell 2016

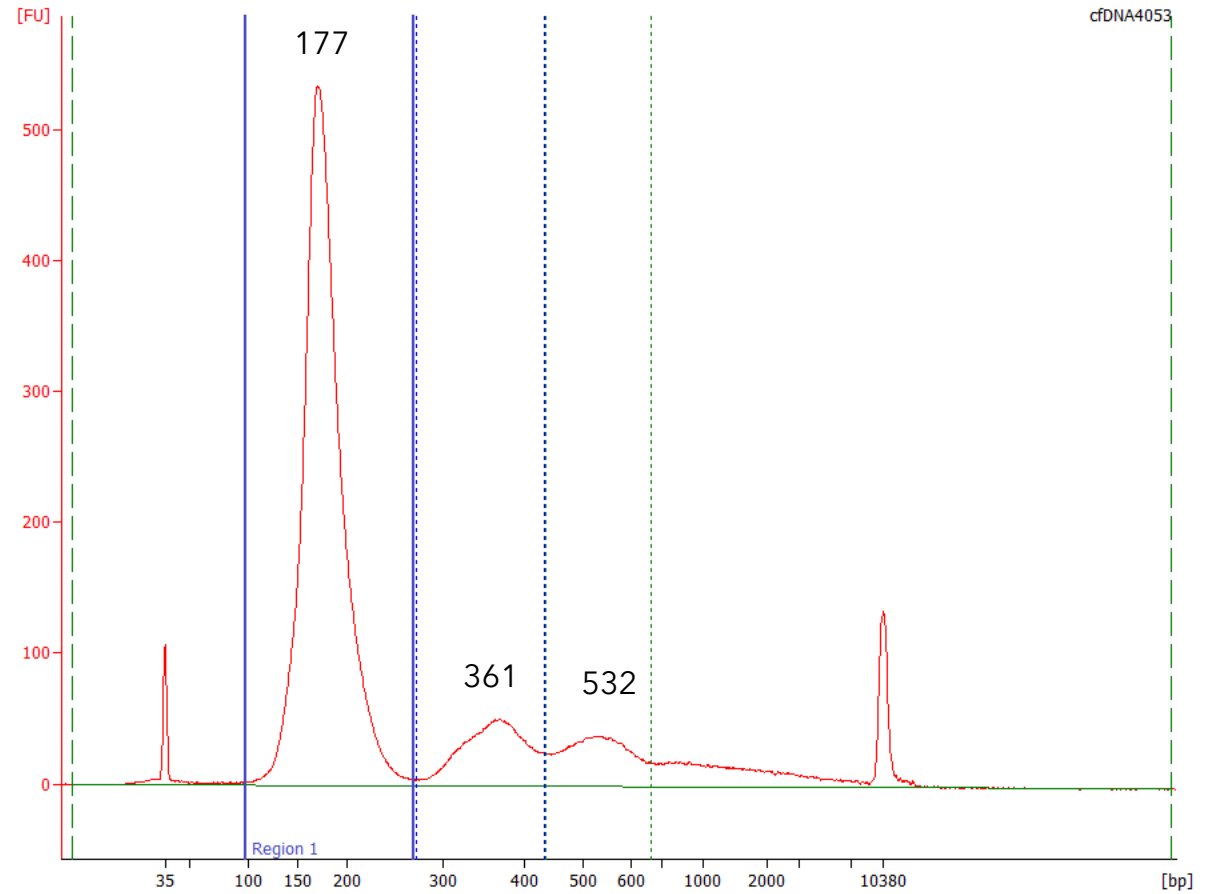



# cfDNA

## Applications

- Diagnosis, early detection
- Genotyping
- Disease risk stratification
- Treatment selection
- Treatment response assessment
- Disease monitoring

Solid tumors and hematological malignancies



Unmet needs

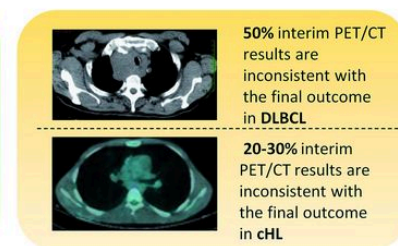
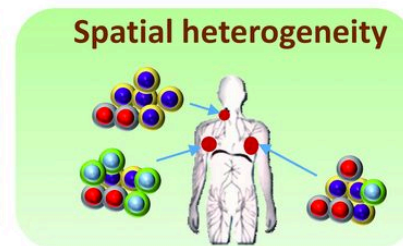
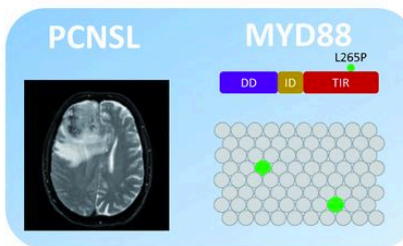

Solutions

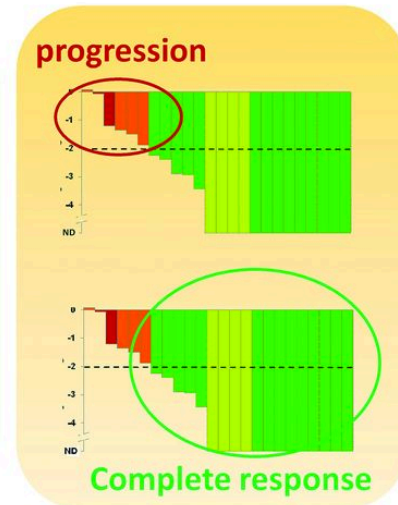
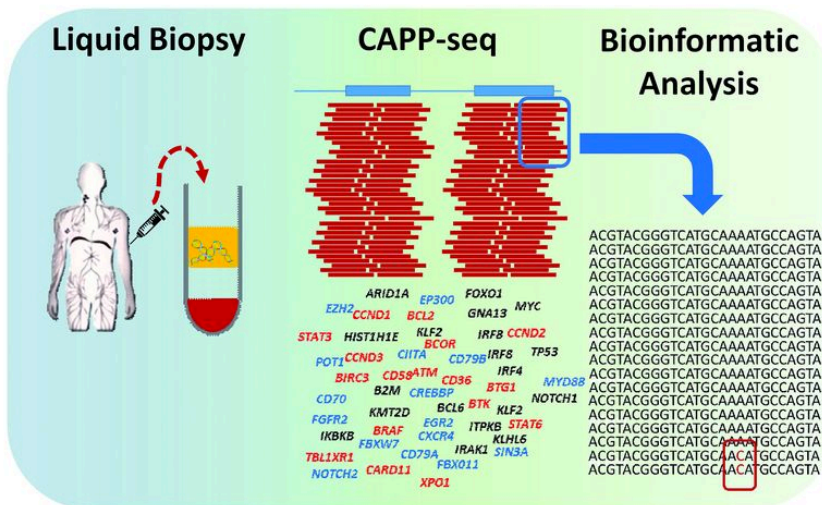

cHL, classical Hodgkin lymphoma; DLBCL, diffuse large B-cell lymphoma; MRD, minimal residual disease; PCNSL, primary nervous system lymphoma.

# cfDNA

## Methods

- NGS - targeted amplicons, gene panels, WGS
- real-time PCR
- FDA approved assays for gene mutation detection

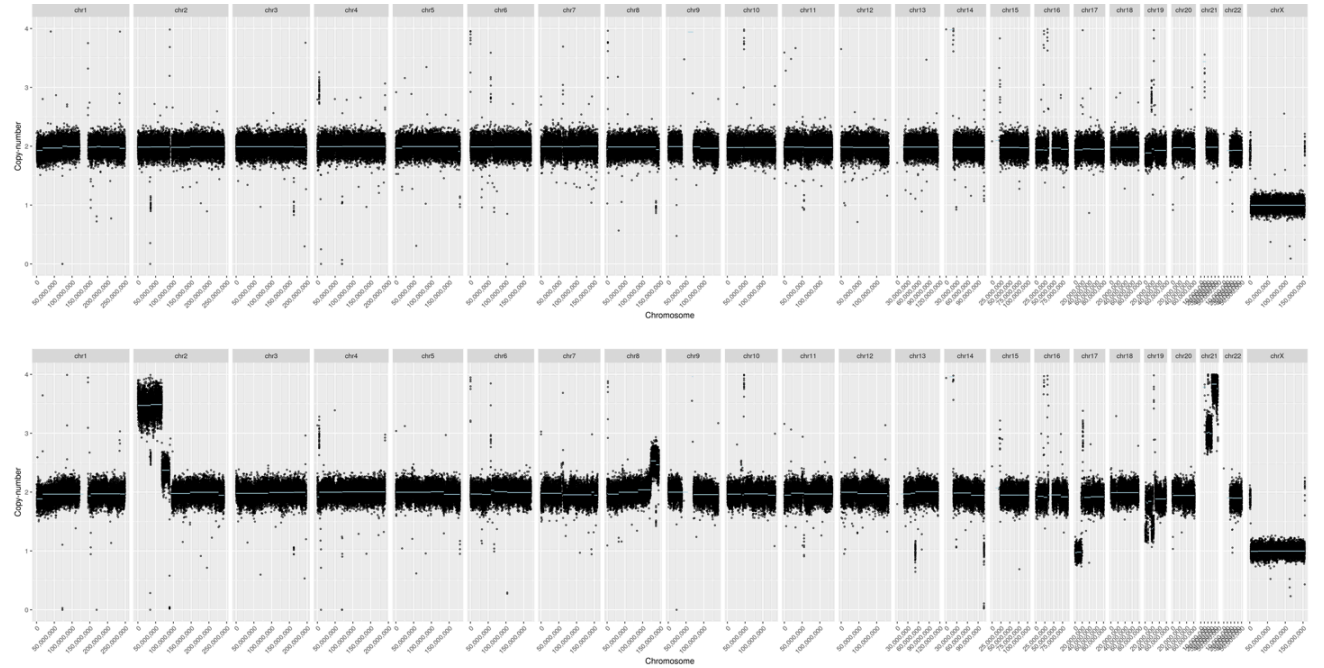

# Tissues

- Biopsies, fine-needle biopsies
- Fresh frozen vs FFPE tissue
- Decreased DNA and RNA quality (fragmented, chemically modified in case of FFPE material)
- Mainly used in diagnostics of solid tumors
- Invasive



# Swabs

Different applications

- Collection of germline material - buccal swabs
- Pathogen analyses - e.g. nasopharyngeal swabs



## 4. Methods used and practical examples

- Chromosome banding techniques
- Fluorescence *in situ* hybridization
- Genomic arrays
- PCR and real-time PCR
- Droplet digital PCR
- Sanger sequencing
- Next-generation sequencing
  - Amplicon sequencing
  - Panel sequencing
  - Whole exome sequencing
  - Whole genome sequencing

# Classical cytogenetics - chromosome banding techniques

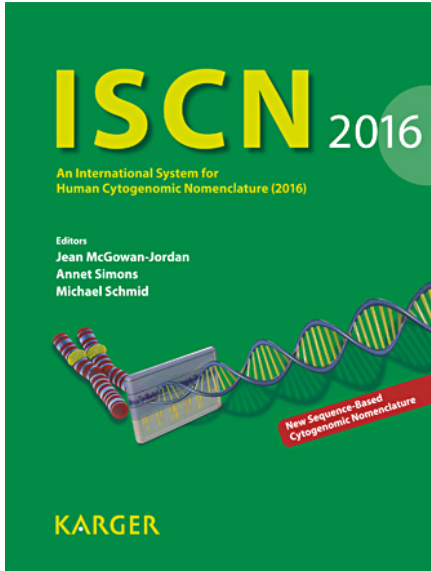
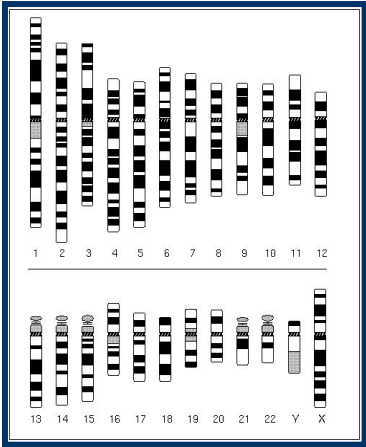
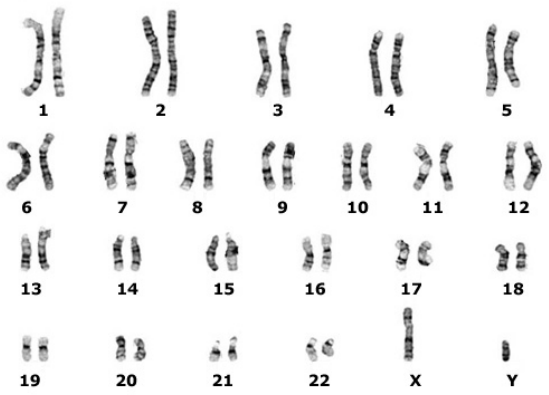
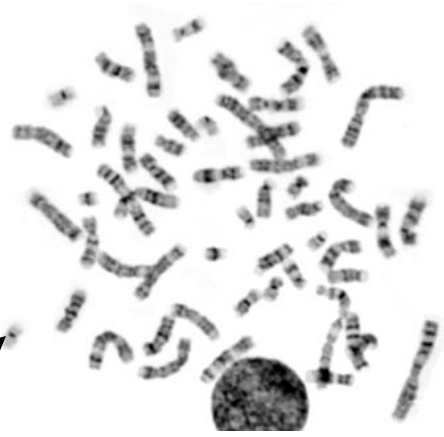
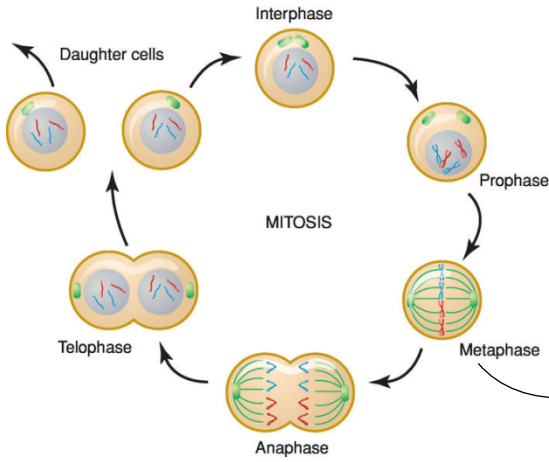
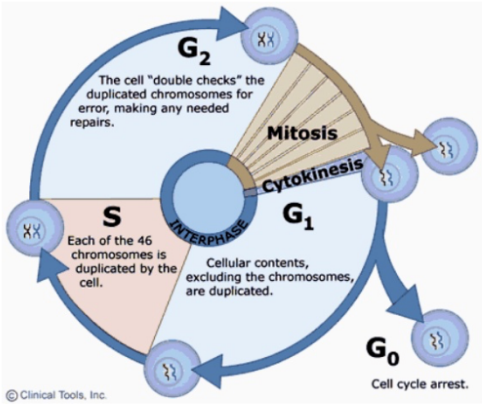

# Classical cytogenetics - chromosome banding techniques

Resolution > 10 Mbp

Applications

- Detection of typical abnormalities
- Complex karyotype assessment  
( $\geq 3$  or  $\geq 5$  abnormalities)

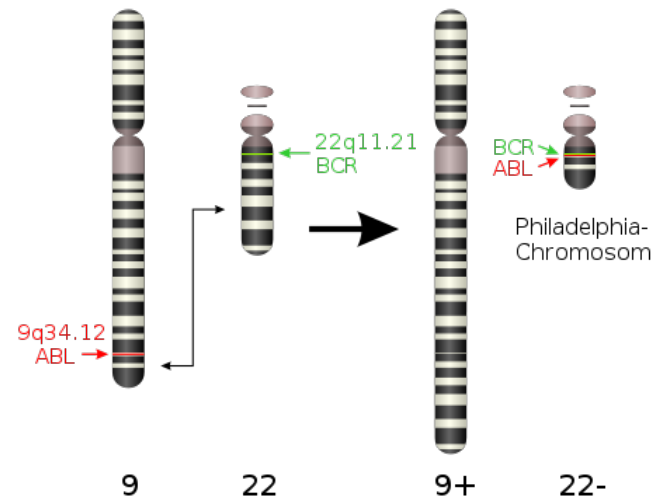
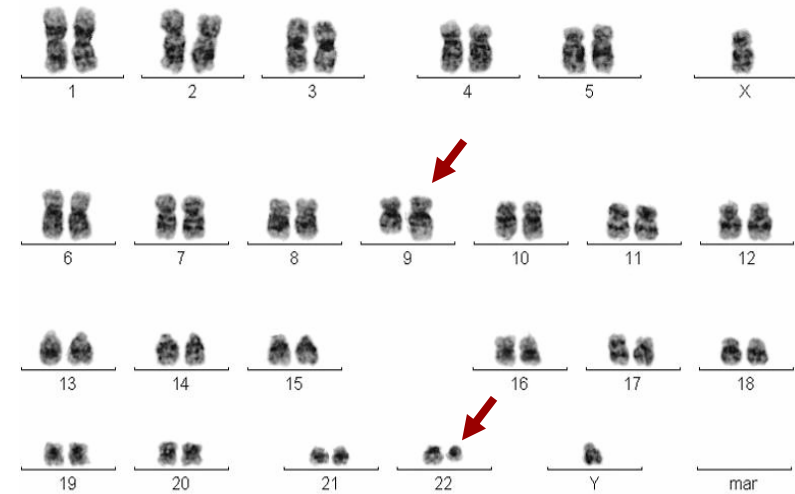
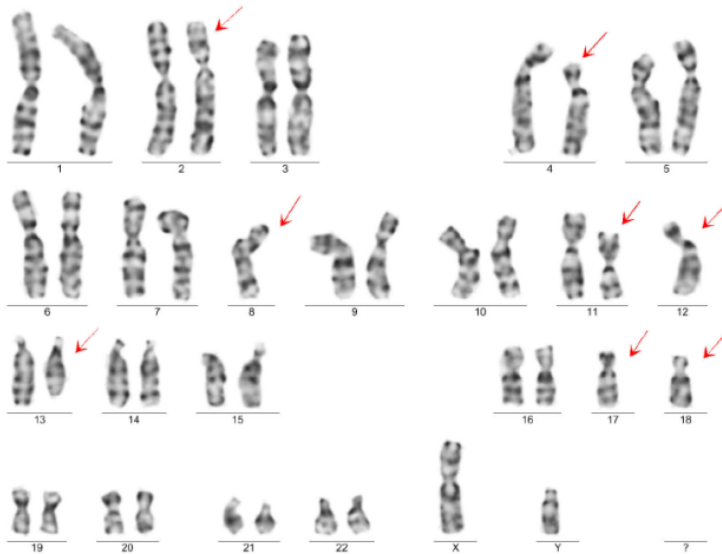

# Molecular cytogenetics

- Fluorescent in situ hybridization (FISH)
- Targets specific regions based on DNA sequence
- Detection of chromosomal abnormalities with diagnostic, prognostic and predictive value

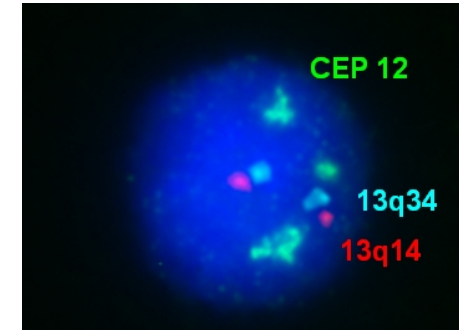

Probe types:

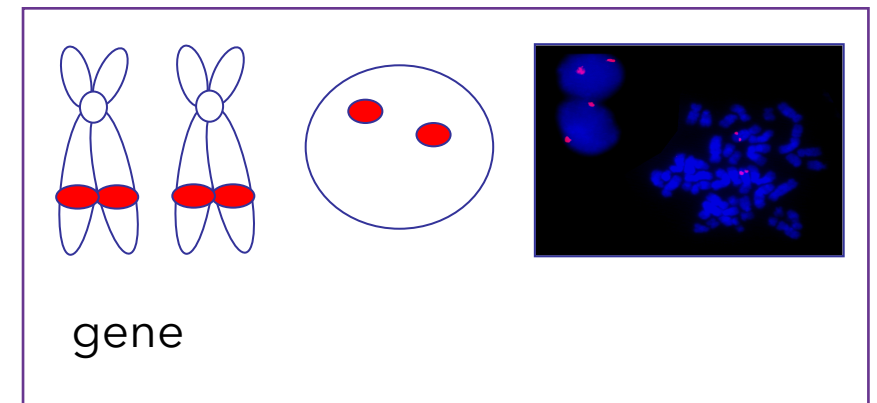
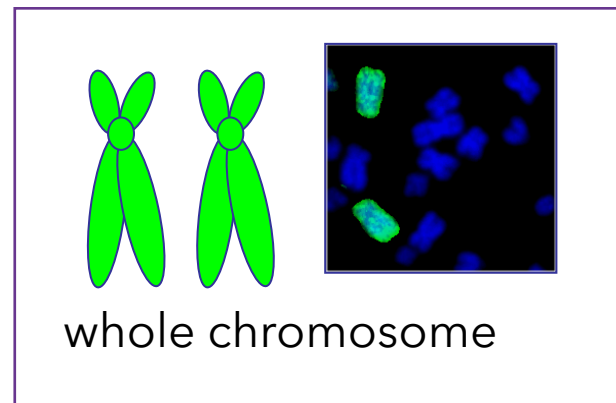
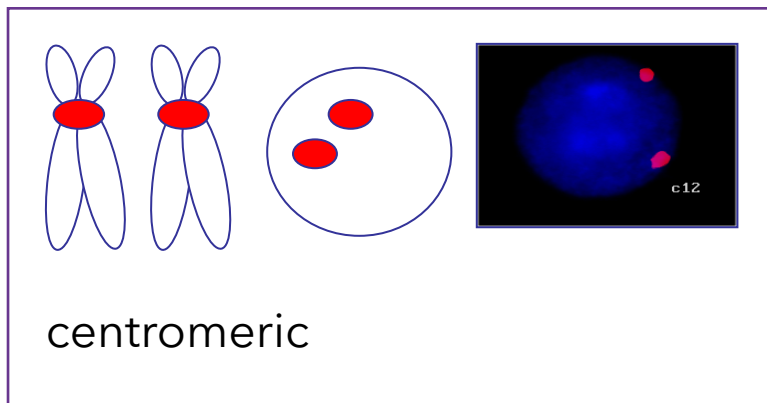



# Molecular cytogenetics

- FISH methods for genome-wide analysis

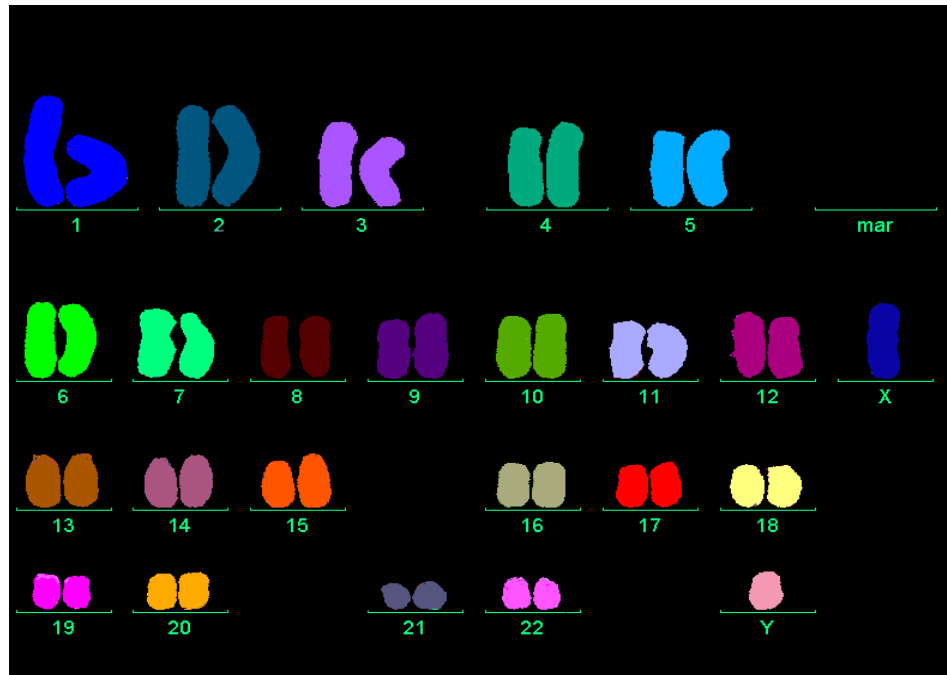

mFISH

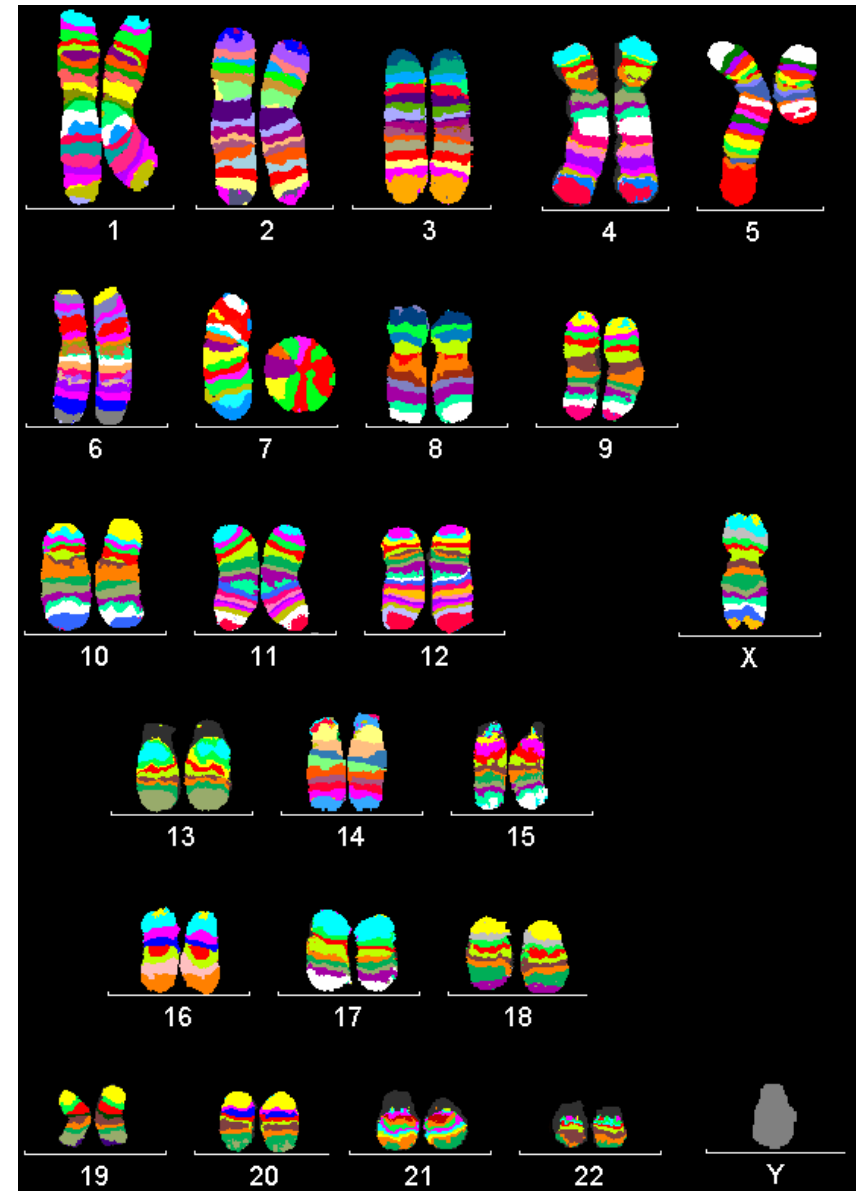

mBAND

# Genomic arrays

- Molecular cytogenetic technique for detection of genomic gains and losses
- Detection of copy-neutral loss of heterozygosity
- Not possible to detect balanced rearrangements
- Precise breakpoint localization, identification of affected genes
- High resolution, genome-wide
- No need for viable cells

arrayCGH & SNP array

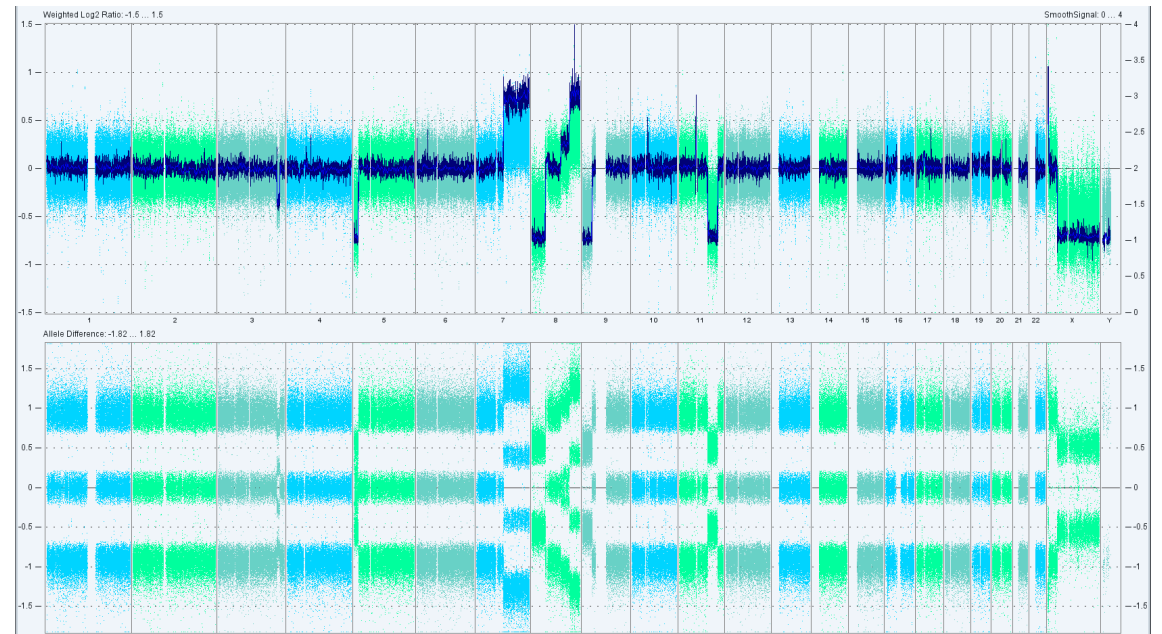
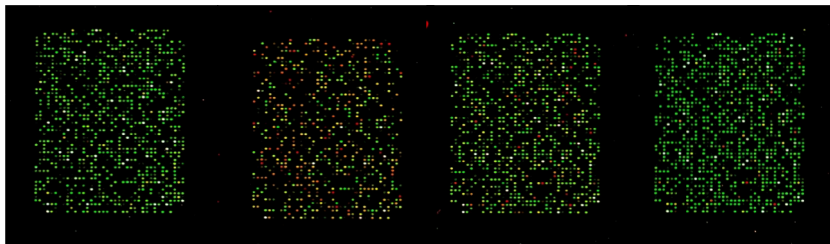

# Comparison of sensitivity of cytogenetic techniques

	<b>Aneu- ploidy</b>	<b>CNA</b>	<b>Poly- ploidy</b>	<b>Clonal heterogeneity</b>	<b>Focal amplification</b>	<b>Balanced rearrangements</b>	<b>Unbalanced rearrangements</b>	<b>cn-LOH</b>
Classical cytogenetics	+++	+	+++	+++	++	+++	+++	-
Interphase FISH	+++	++	+	+++	+++	+++	++	-
ArrayCGH	+++	++	-	+	+++	-	++	-
CGH+SNP array	+++	+++	+	+	+++	-	++	++
SNP array	+++	+++	++	++	+++	-	++	+++

**CNA** - copy number alteration, gains or lossess of genetic material

**cn-LOH** - copy neutral loss of heterozygozity

# Polymerase Chain Reaction (PCR) and real-time PCR

## PCR

- Amplification of region of interest using specific primers
- Cycling reaction condition
- Product of reaction serves as an input for further analyses (Sanger sequencing, fragment analysis, NGS, ...)

## Real-time PCR

- Quantitative method - fluorescent detection of generated products
- Need for specific primers and probes
- Relative vs absolute quantification



ABI 7300

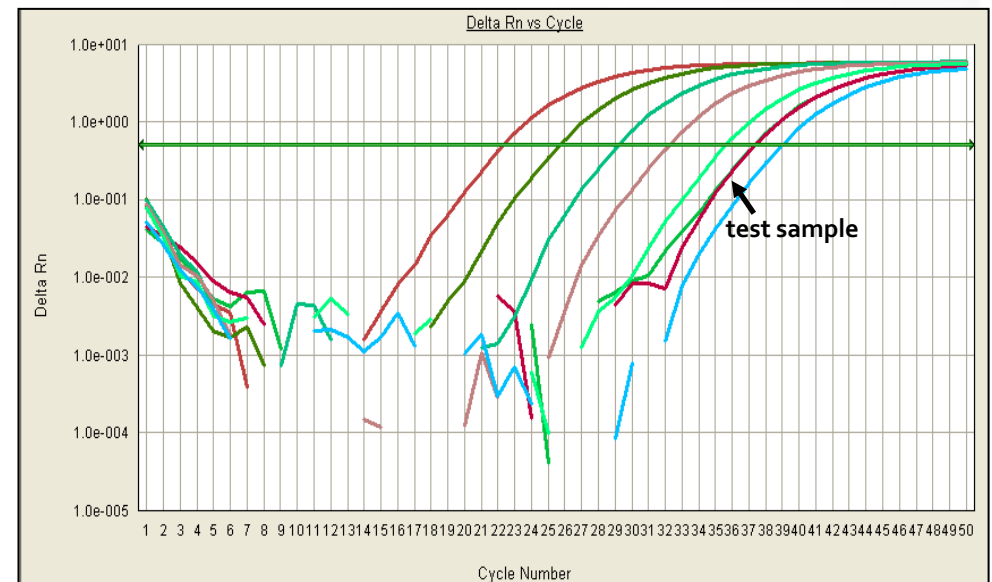

# Real-time PCR applications

- Quantification of minimal residual disease after therapy - detection of tumor specific markers (fusion genes, antigen receptor rearrangements etc.)
- Gene expression analysis
- Pathogen detection and pathogen load quantification

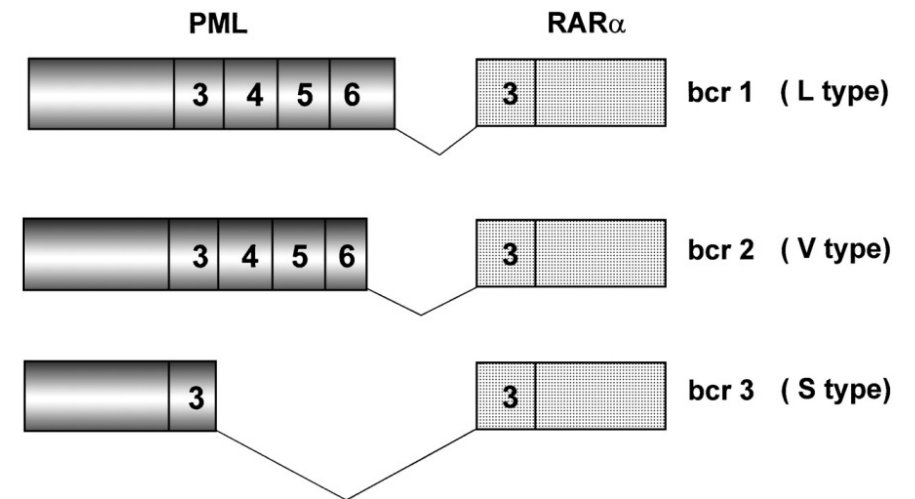
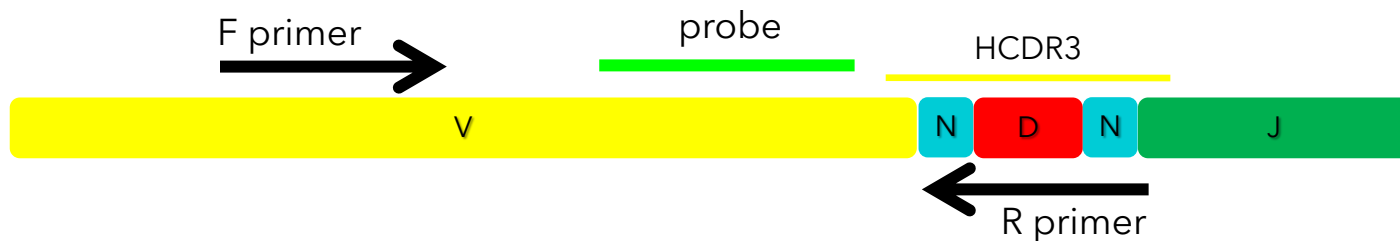

# Droplet digital PCR (ddPCR)

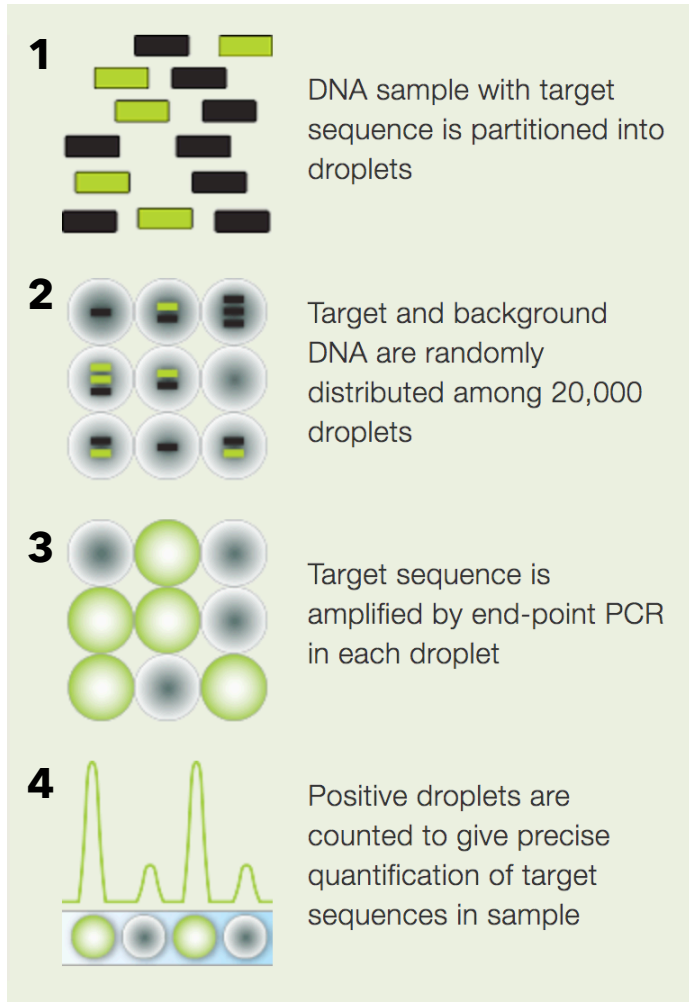

- Alternative method for marker absolute quantification
- Highly precise
- Need for specific instrumentation

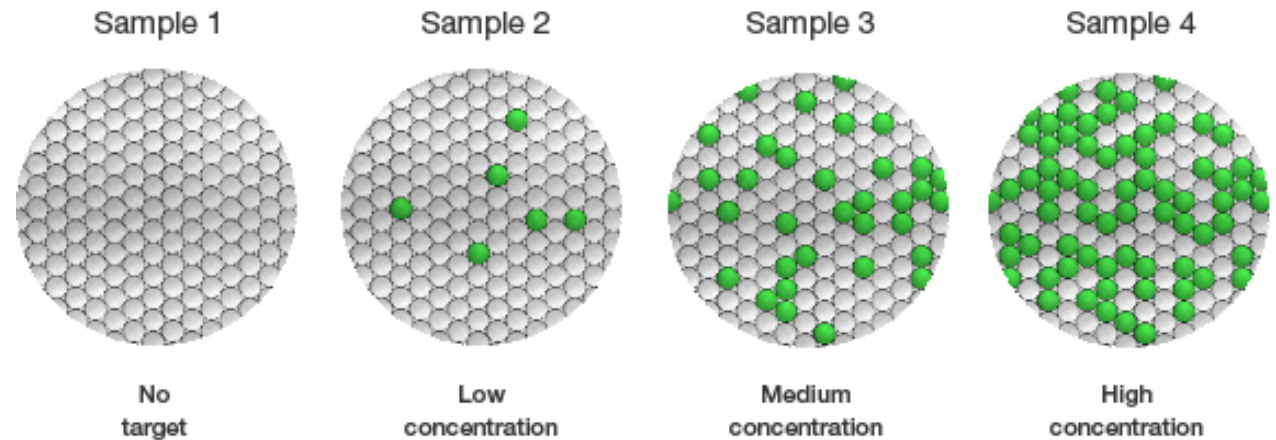

# Sanger sequencing

## Modification of PCR

- single primer extension
- Incorporation of dNTPs and ddNTPs

## Applications

- Basic method for sequence variant detection (mutations, breakpoint localization)

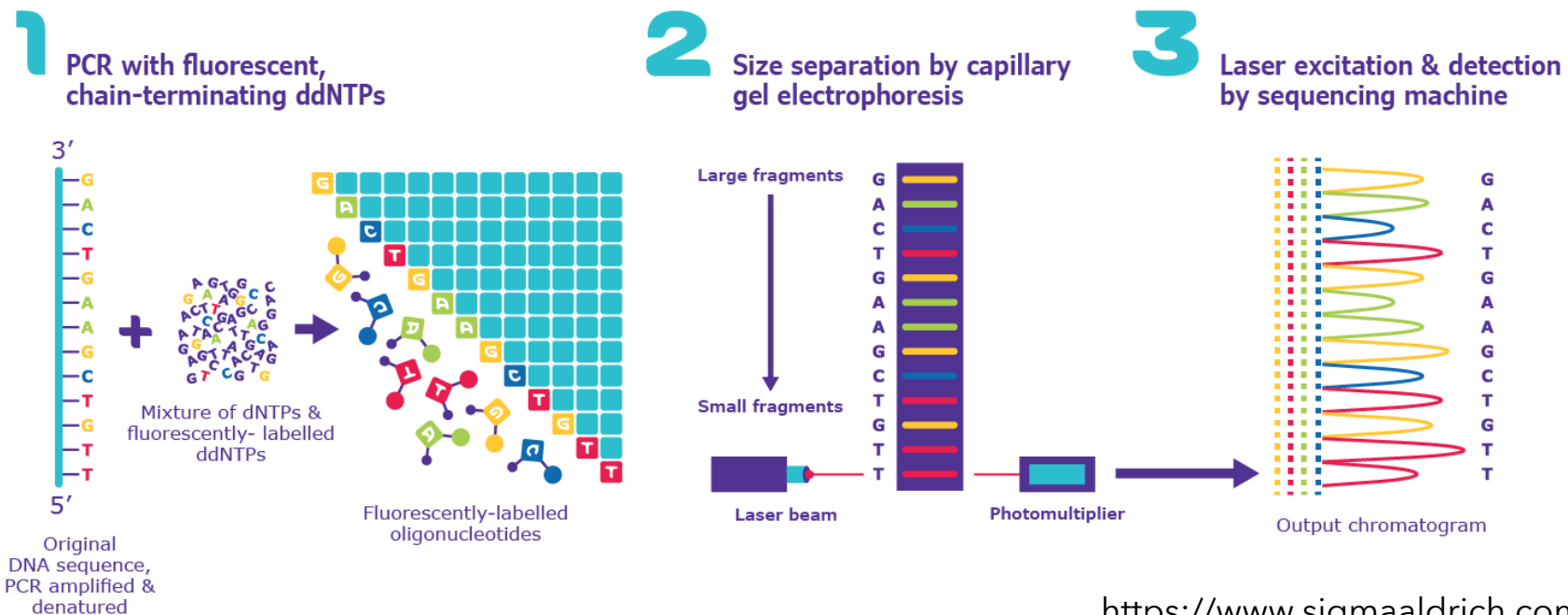

# Sanger sequencing

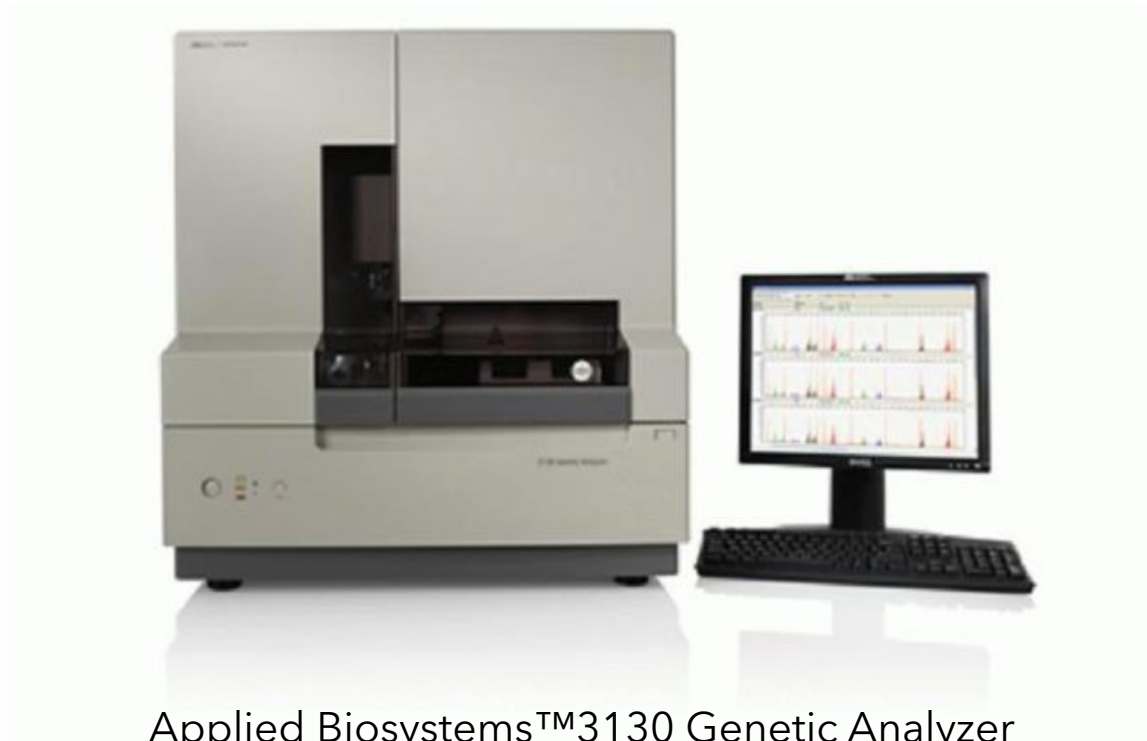

## Sequencing analysis output

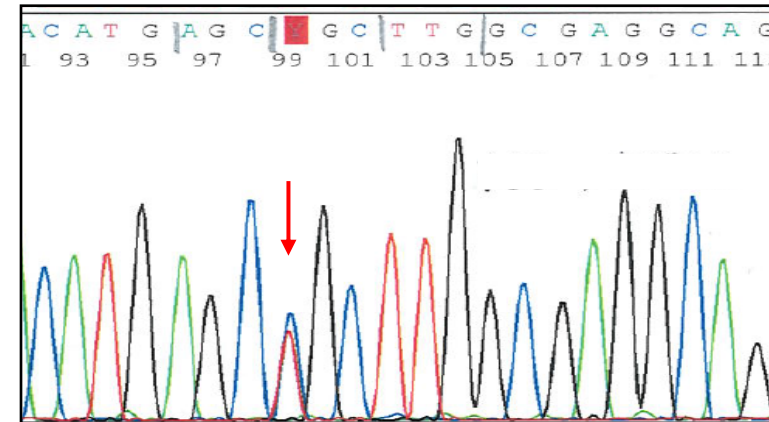

## Fragment analysis - modification of the method

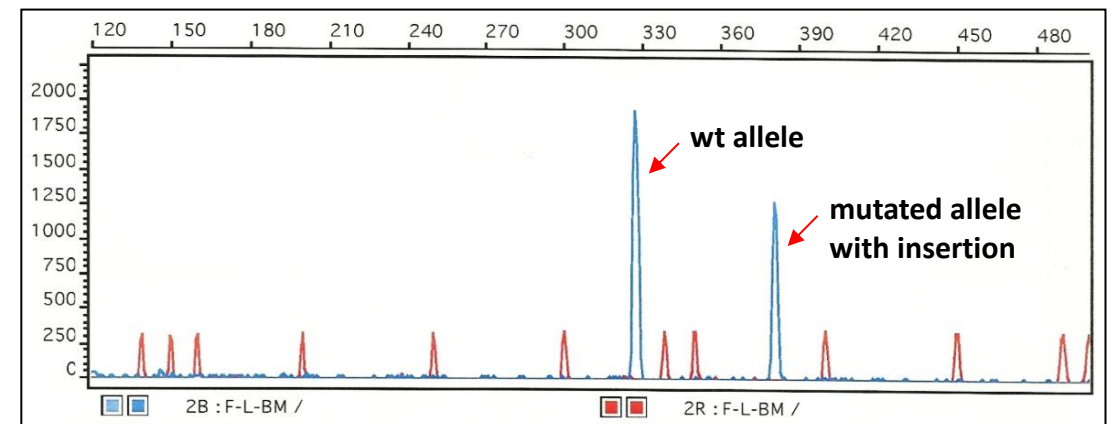



# NGS - principles and targeted regions

Next-generation sequencing (NGS) ~ massively parallel sequencing (MPS)

- PCR amplification of DNA fragments  
or direct sequencing of individual fragments (single molecule sequencing)
- The most common approach -  
sequencing by synthesis (Illumina sequencers)
- Millions of fragments are amplified simultaneously  
(vs capillary sequencer max 96 reactions)
- Short reads (tens to hundreds basepairs)

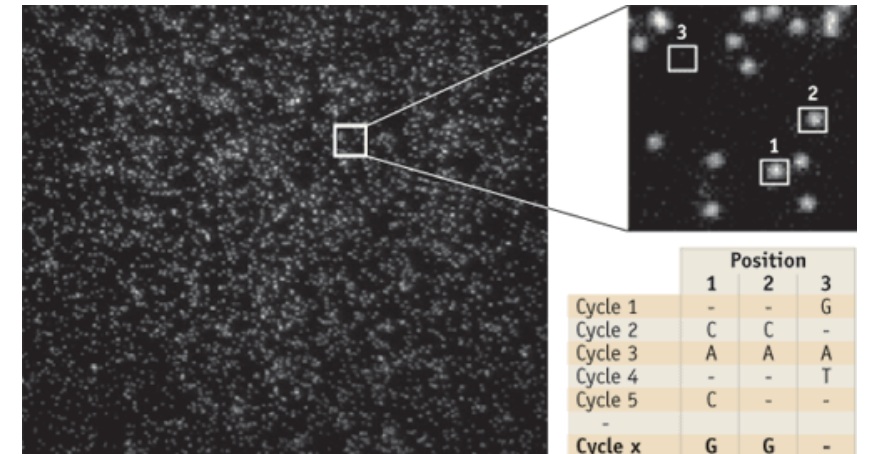

# NGS - principles and targeted regions

Illumina machines and their capacity



**NovaSeq**

48 genomes/run,  
6 TB/run



**HiSeq 4000**

12 genomes/run,  
1.5 TB/run



**NextSeq 500**

1 genome/run,  
120 GB/run



**MiSeq**

0.15 genome/run,  
15 GB/run



**MiniSeq**

0.07 genome/run,  
7.5 GB/run



**iSeq**

0.01 genome/rin,  
1.2 GB/run

# NGS - regions of interest

genome



3 200 000 000 bp  
30 x read depth

exome



20 000 genes  
100 x read depth

selected genes or loci



< 100 genes  
≥ 1000 x read depth

# Amplicon sequencing

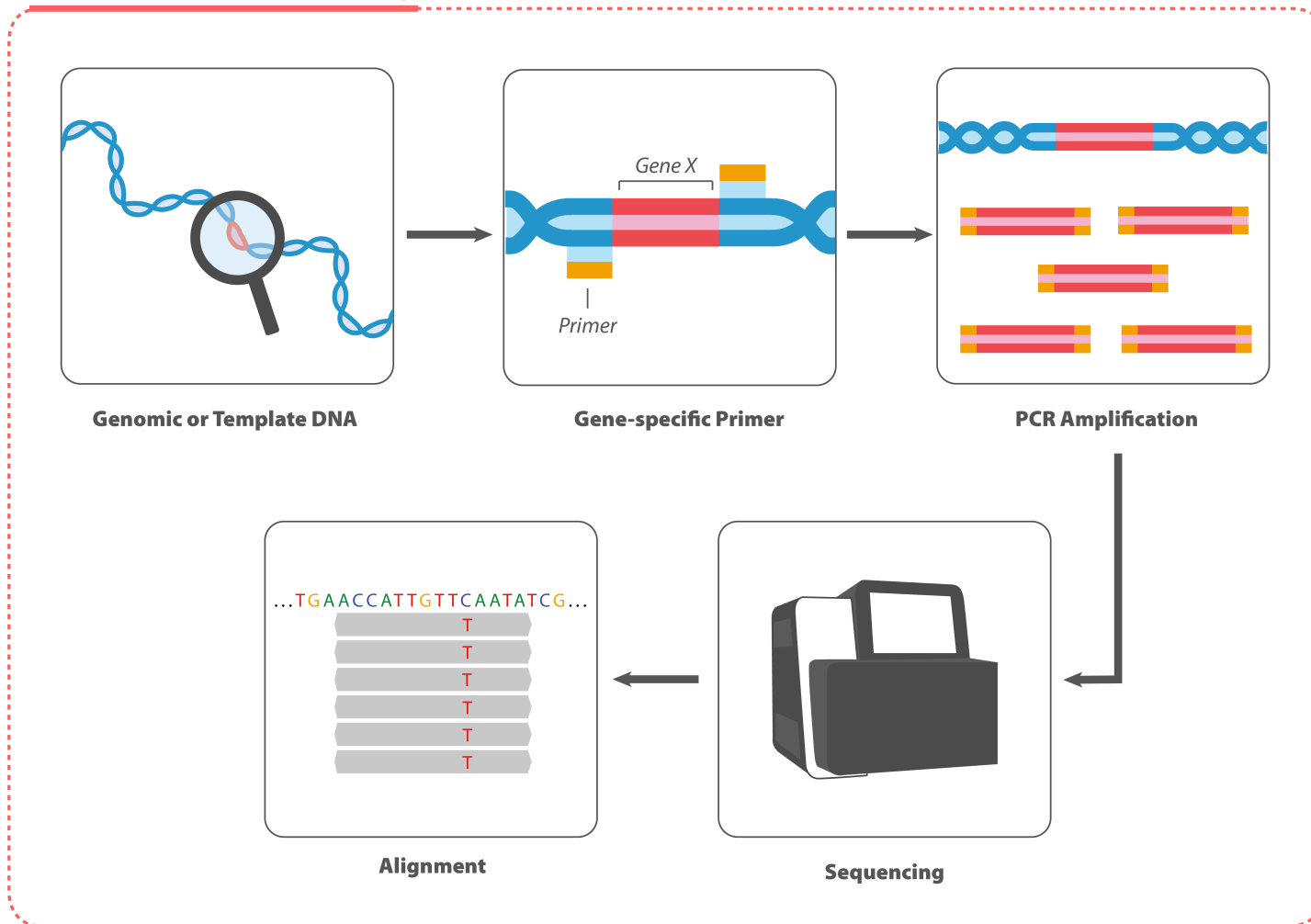

<https://www.abmgood.com/Amplicon-Sequencing-Service.html>

Application: TP53 mutation analysis

- NGS with high coverage (limit of detection 0.1 % of variant allele)
- treatment response prediction

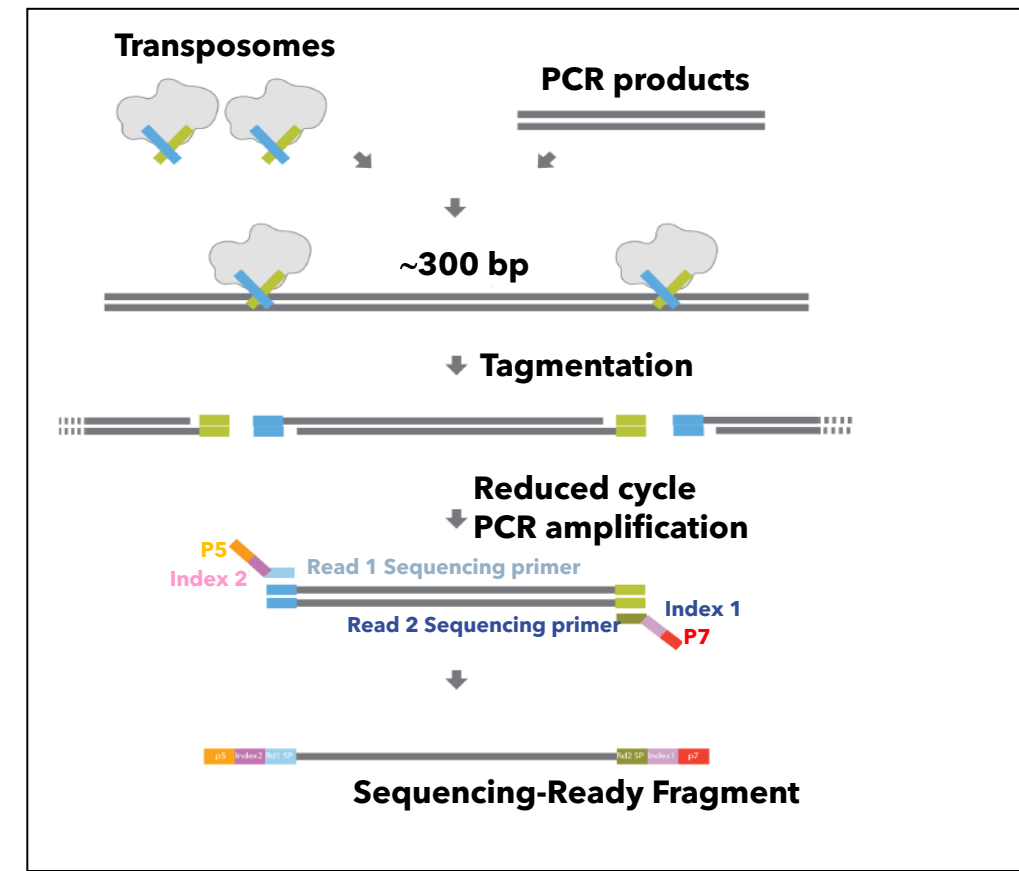

# Panel sequencing

- Sets of selected regions of interest
- Target enrichment by amplification or hybridization

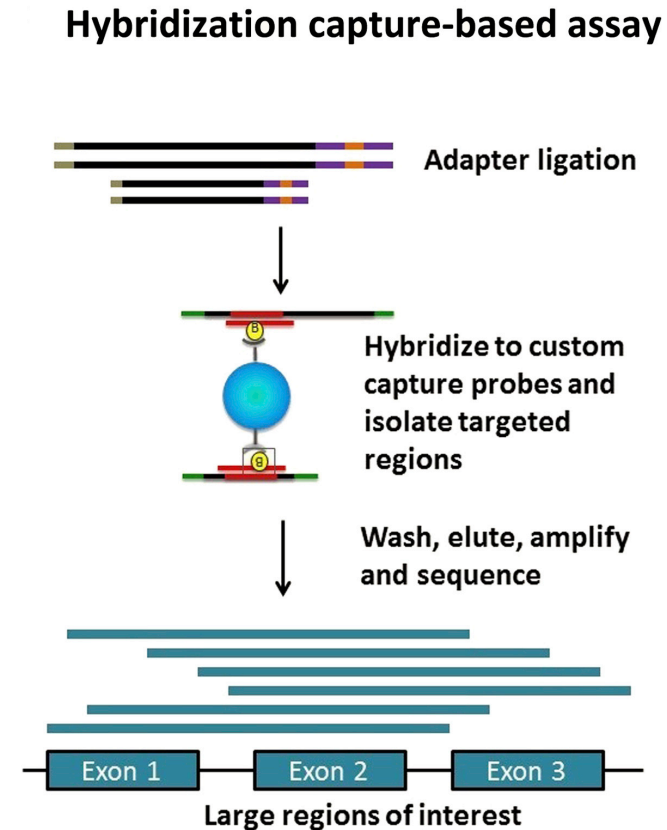
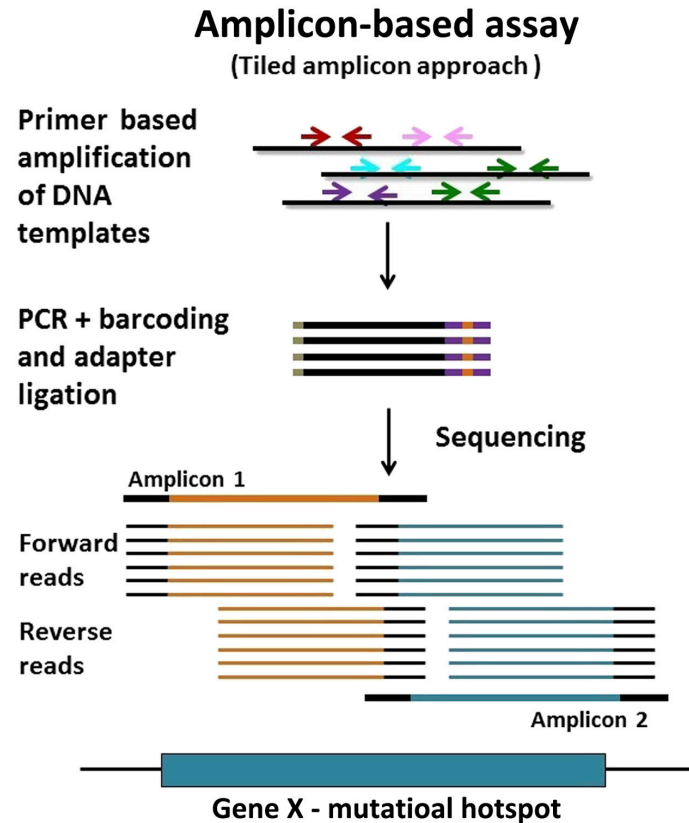

# Panel sequencing

- LYNX panel - diagnostics of molecular markers in lymphoid malignancies  
(<sup>1</sup>CLL, <sup>2</sup>MCL, <sup>3</sup>FL, <sup>4</sup>DLBCL, <sup>5</sup>ALL, <sup>6</sup>Ph-like ALL)

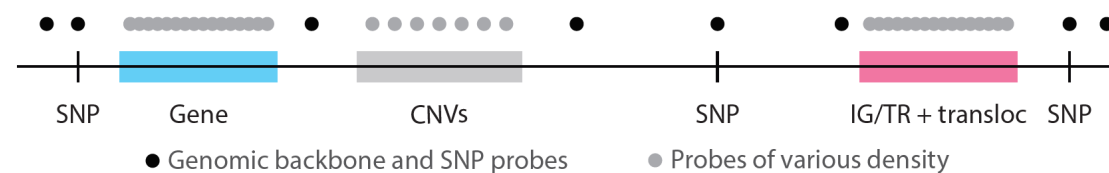

## List of genes

ARID1A <sup>1,3</sup>	ASXL <sup>1,5</sup>	ATM <sup>1,2</sup>	BIRC3 <sup>1,2</sup>	BRAF <sup>1,3-5</sup>
BTG1 <sup>6</sup>	CARD11 <sup>1-4</sup>	CCND1 <sup>2</sup>	CD79A <sup>1,4</sup>	CD79B <sup>1,2,4</sup>
CDKN2A <sup>1-5</sup>	CDKN2B <sup>3-5</sup>	CHD2 <sup>1</sup>	CREBBP <sup>1,3-5</sup>	CRLF2 <sup>5</sup>
CSF2RA <sup>6</sup>	EBF1 <sup>6</sup>	EGR2 <sup>1</sup>	EP300 <sup>1,3,4</sup>	EPOR <sup>6</sup>
ETV6 <sup>5</sup>	EZH2 <sup>3-5</sup>	FBXW7 <sup>1</sup>	FIGNL1 <sup>6</sup>	FLT3 <sup>5</sup>
FOXO1 <sup>3</sup>	HIST1H1E <sup>1</sup>	IKZF1 <sup>5</sup>	IKZF2 <sup>6</sup>	IKZF3 <sup>1,6</sup>
IL2RB <sup>6</sup>	IL3RA <sup>6</sup>	IL7R <sup>5</sup>	JAK1 <sup>1,5</sup>	JAK2 <sup>1,5</sup>
JAK3 <sup>5</sup>	KRAS <sup>1,5</sup>	MEF2B <sup>2-4</sup>	MGA <sup>1</sup>	KMT2A <sup>1,5</sup>
KMT2D <sup>1-4</sup>	MYC <sup>3,5</sup>	MYD88 <sup>1-4</sup>	NF1 <sup>1,5</sup>	NFKBIE <sup>1</sup>
NOTCH1 <sup>1-4</sup>	NOTCH2 <sup>2,4</sup>	NRAS <sup>1,5</sup>	P2RY8 <sup>6</sup>	PAG1 <sup>5</sup>
PAX5 <sup>1,5</sup>	PIM1 <sup>1,4</sup>	PTEN <sup>3-5</sup>	PTPN11 <sup>1,5</sup>	POT1 <sup>1</sup>
RB1 <sup>1,5</sup>	RPS15 <sup>1</sup>	RUNX1 <sup>5</sup>	SAMHD1 <sup>1</sup>	SETD2 <sup>1,5</sup>
SF3B1 <sup>1,2</sup>	SH2B3 <sup>6</sup>	SHOX <sup>6</sup>	TNFRSF14 <sup>3,4</sup>	TP53 <sup>1-5</sup>
TYK2 <sup>6</sup>	UBR5 <sup>2</sup>	WHSC1 <sup>2</sup>	XPO1 <sup>1</sup>	ZMYM3 <sup>1</sup>

| exon-proximal probes   
 | 3' UTR region included   
 | introns included



## Rearrangements<sup>1-5</sup>

IGH@	79 subgenes
IGK@	45 subgenes
IGL@	42 subgenes
TRA@	96 subgenes
TRB@	64 subgenes
TRG@	13 subgenes
TRD@	11 subgenes



## Translocations<sup>2-4</sup>

CCND1/IGH	t(11;14)
BCL2/IGH	t(14;18)
BCL6/IGH	t(3;14)

## CNVs<sup>1-6</sup>

> 6 MB across whole genome



## Reccurent deletions<sup>1,2</sup>

> 300 kb/1 Mb

Del17p	
Del11q	
Del13q	



## Trisomy<sup>1,2</sup>

Tri12	
-------	--



## cnLOH<sup>1-6</sup>

according to SNP probe density

# Whole exome sequencing (WES)

- Mainly experimental approach for exploring unknown variants
- Used in
  - genetic counseling for identification of causative variants
  - discovery of novel genetic markers
  - searching for treatment targets

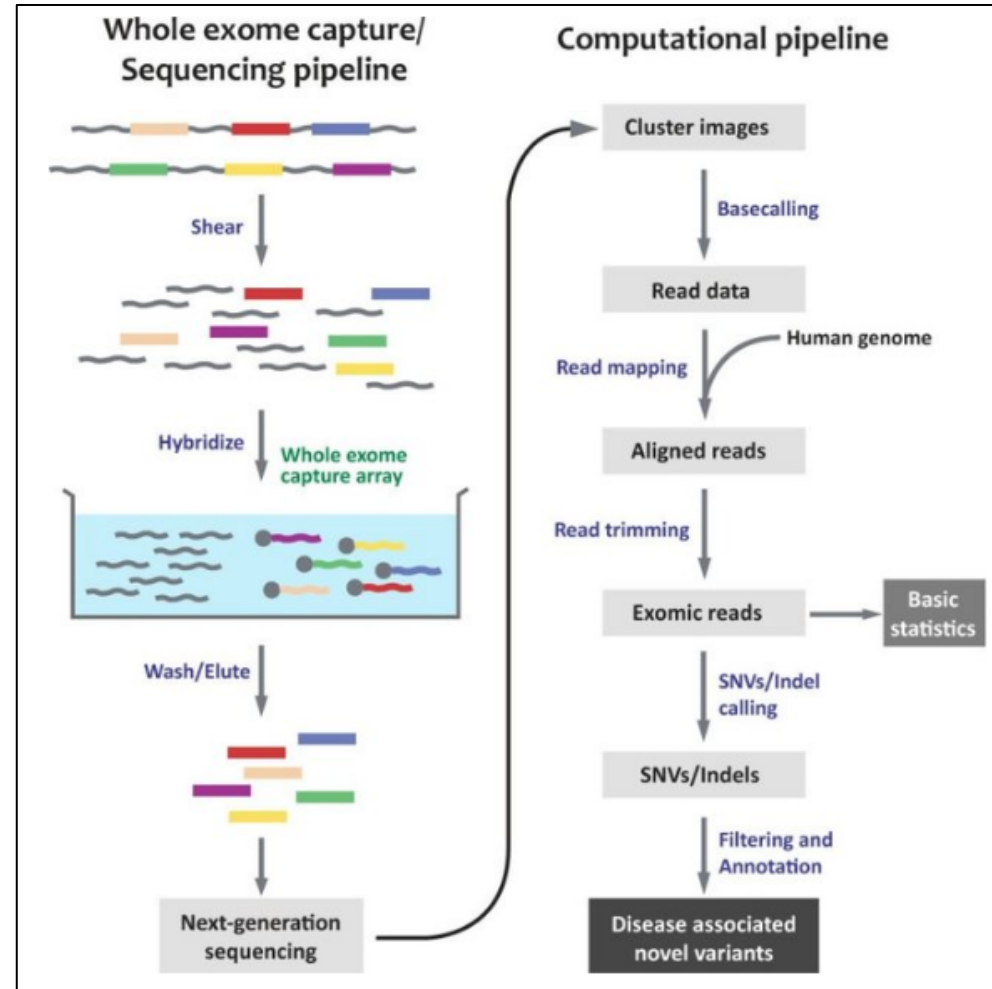

# WES - case report of Shwachman-Diamond syndrome

- a multisystem autosomal recessive disorder
- clinical features: pancreatic exocrine insufficiency, hematologic dysfunction, and skeletal abnormalities
- haematological malignancies (e.g. myelodysplastic syndrome and acute myeloid leukemia) occur in one third of patients
- homozygous or compound heterozygous variations in *SBDS* gene

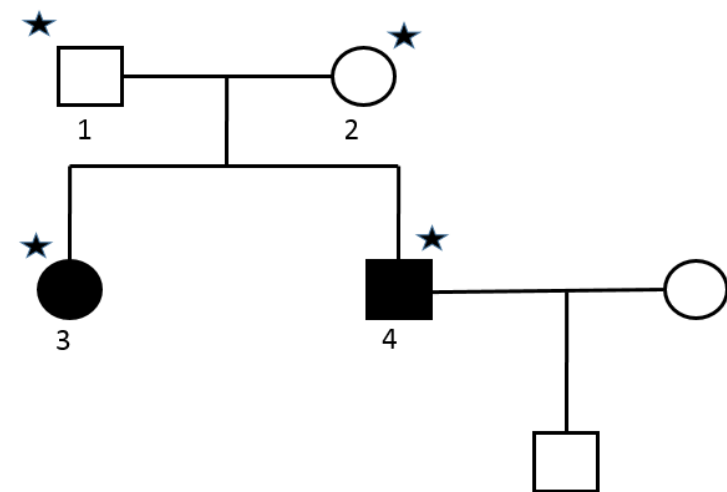



# Whole genome sequencing (WGS)

- Mainly experimental method for exploring unknown variants
- Applications similar to WES, additional information about non-coding regions and chromosomal abnormalities
- Typical sequencing coverage ~ 30-100x - detection of clonal or germline mutations
- Shallow sequencing (~ 0.5-10x coverage) - genome-wide detection of chromosomal abnormalities, low yield of mutation detection
- In clinical practise a potential benefit of combination of shallow and panel sequencing

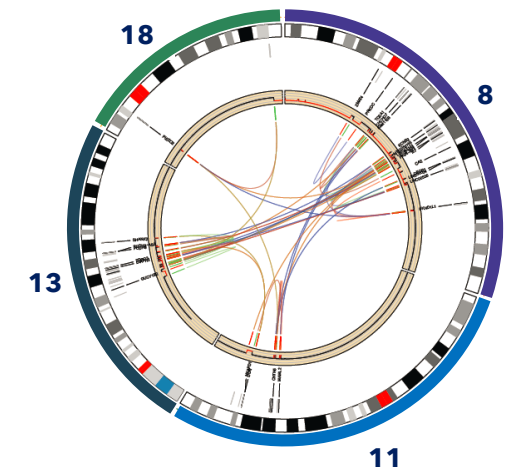
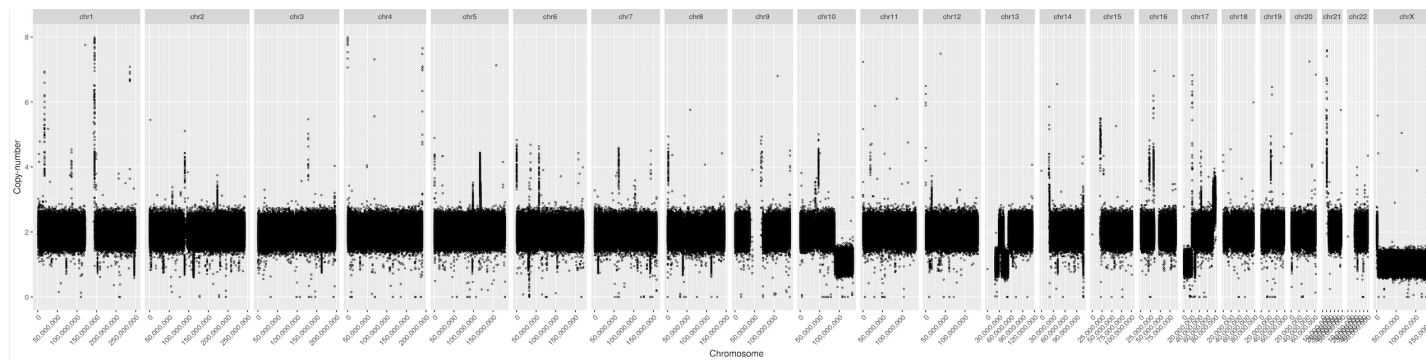

The end...

Contact:

[karla.plevova@mail.muni.cz](mailto:karla.plevova@mail.muni.cz) or [plevova.karla@fnbrno.cz](mailto:plevova.karla@fnbrno.cz)

CEITEC MU A35

Internal Medicine - Hematology and Oncology, University Hospital Brno

Thank you for your attention!