

MUNI



Lectures on Medical Biophysics

Physical Therapy

Hubbard Hydrotherapy Tank,
Carlos Andreson, Watercolour,
1943

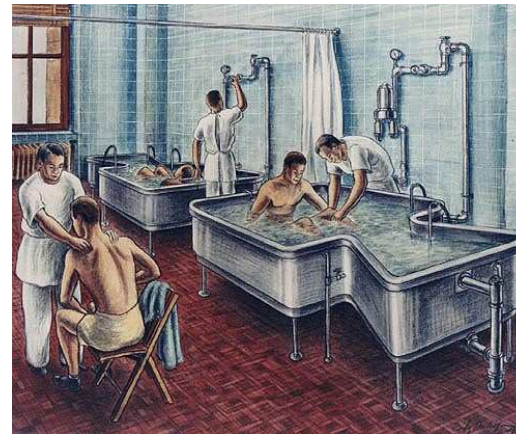

Lecture outline

Main methods of physical therapy:

- Therapy by mechanical treatment
- Non-electric thermotherapy – (heating and cooling, hydrotherapy)
- Electrotherapy
- Ultrasound therapy
- Magnetotherapy
- Phototherapy

Therapy by mechanical treatment - examples

Massages – manual or instrumental
Changes in blood circulation, muscular relaxation



Rehabilitative exercises
increase of body strength and mobility,
psychical effects, improvement of body
posture



Thermotherapy

The application of heat is (from biophysical point of view) an intervention in the body thermoregulation. Heat can be delivered to the organism (**positive thermotherapy**), or taken away from the organism (**negative thermotherapy**).

The body response depends on:

- **the way of application** - heat conduction, convection or radiation (see electrotherapy and phototherapy)
- **the intensity, penetration ability and duration of the heat stimulus.** Non electric thermotherapy causes mainly changes of body surface temperature (to depths of 2 - 3 cm), with electrotherapy we can heat deeper tissues.
- **the size and geometry of the application area** in the case of **local application**: The tissue temperature increases when the heat input from outside exceeds the heat output. Cylindrical body parts are heated faster when the radius is small. Considering only conduction, the **resistance to heat flow** increases linearly with the thickness of tissue layers. In cylindrically shaped tissues it increases non-linearly.
- **the patient's health (ability of thermoregulation).**

Thermotherapy

The following **sources** of heat are used in thermotherapy:

- a) Internal** (heat produced by the organism itself).
- b) External.** Considering the origin and transfer of heat, the thermotherapeutic methods can be divided into five main groups based on:
 - heat conduction
 - heat convection
 - radiation
 - high-frequency electric currents
 - thermal action of ultrasound

Heat conduction

Mainly **packs and compresses**. According to the extent of the covered body part, they can be total or partial, according to the temperature **hot, indifferent** or **cold**, and also wet or dry. The compresses can be dry (blankets, bottles), **peloids (mud)** and **paraffin**. Their temperature ranges from 45 to 55 °C in dry compresses up to 60 - 77 °C in paraffin compresses.



Heat convection – hydrotherapy

- **hydrotherapy** encompasses, besides heat effects, also mechanical action (buoyancy, hydrostatic pressure, impacts of water movement). It acts mainly on the cardiovascular system, vegetative nerves and psychology. Heat helps muscles to relax, reduces pain, accelerates resorption of oedemas. The procedures differ from each other in the **way of heat transfer**, in the **ratio of conduction and convection**, and in the degree of **homogeneity** of heat flux:
- **cold** (less than 18 °C), **cool** (18 – 24 °C), **tepid** (24 – 33 °C), **warm** (33 – 36 °C) or **hot** (37 – 42 °C).
- **Or: hypothermic** (10 - 34 °C, 5 min.), **isothermal** (34 - 36°C, 20 - 30 min), **hyperthermic** (37 - 42°C, short duration).
- The effect of the whole-body bath is given mainly by the surface body temperature. After immersion, the body surface is exposed to the actual medium temperature until thermal equilibrium is formed in several millimetres thick water layer, and the **effective bath temperature** starts to act. Disturbing the layer prevents stabilisation of the effective temperature, thus the patient should not move during the bath.

Whirling baths, underwater massages, hot and cold water jets



Alternative application of sharp hot and cold water jets – a method with outstanding activation effect.



For upper and lower limbs moderately hyperthermic – increasing blood supply and metabolism, skin receptors activated



Sauna



Effects of hot (80 - 100°C) air of low relative humidity (10-30%) are utilised, followed by cooling in cold water. Outstanding tonic action. Steambath: about 45°C, up to 100% humidity.

Cryochamber



Action of dry very cold air (up to -160°C) during some minutes followed by aerobic exercise.



Electrotherapy

Electrotherapeutic methods utilise

- **Direct electric current** (galvanotherapy, iontophoresis)
- **Low-frequency** alternating current or short impulses of direct current (stimulation)
- **High-frequency** alternating current (diathermy)
- **High frequency** electromagnetic radiation

Conduction of electric currents in tissues

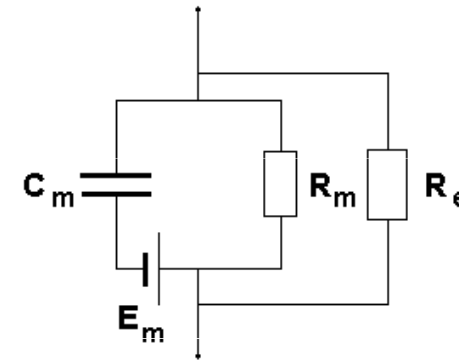

- Passage of electric current through human body obeys the Kirchhoff's laws. Tissue resistance varies. The **ions** are current carriers.
- We can distinguish two types of tissue electric conductivity. Cytoplasm and intercellular medium behaves like conductors whose resistance does not depend on frequency. Membrane structures have properties of capacitors, i.e. their **impedance** Z depends on frequency:

$$Z = \sqrt{R^2 + X_C^2}$$

Resistivity (ρ , rho) of tissues

Tissue	resistivity [Ωm]
cytoplasm	1
body fluids	0,8 - 1,3
muscle tissue	3
parenchymatous organs	4 - 6
fat tissue	10 - 15
bone tissue	30

$$R = \rho \frac{l}{A} \Rightarrow \rho = \frac{RA}{l} \quad [\Omega \cdot m]$$

R is the electrical resistance of a conductor (measured in Ω)

l is the length of the conductor (measured in m)

A is the cross-sectional area of the conductor (measured in m^2)

Tissue polarisation

- The electric charges present in tissues are not always free, they are often bound to macromolecules which are an integral part of cellular structures and their mobility is limited. The macromolecules behave like **electric dipoles** – variously oriented – their dipole moments are mutually compensated.
- The electric dipoles are **oriented** according to the direction of the outer electric field when it is present – their **polarisation** occurs. So an inner electric field of opposite polarity arises, and the intensity of the outer electric field is **lowered**. This turning of polar molecules gives rise to the so-called **displacement current**. **Permittivity** ϵ is a measure of this ability.

Effects of direct electric current (galvanotherapy, iontophoresis)

Continuous direct current (DC) does not stimulate, but can change conditions for that. This effect of DC is called **electrotonus** and is used in **galvanotherapy**.

- Around cathode (-) an increase of stimulation of motor nerves occurs = **catelektrotonus**.
- Around anode (+) a decrease of stimulation of sensitive nerves occurs = **anelectrotonus**.
- Application in electrotherapy.

Electrokinetic phenomena – movement of ions or solvent in electric field – **iontophoresis** – ions are transported inside the body.



Low-frequency AC - electric stimulation

- The excitability is a general feature of living systems. In mammals, it is best expressed in nerve and muscle tissue. **Electric stimulation** - ability of tissue to react on electric stimuli. The direct current has stimulating effects only when suddenly changed.
- The stimulation is a threshold phenomenon, it occurs only after a specific threshold intensity has been reached - **the rheobase**.
- The time factor is more important for quantification of stimulation ability: **Chronaxie** is a time interval necessary for induction of stimulation at the current intensity equal to a two-fold value of rheobase.
- Any skeletal muscle has a characteristic chronaxie. Changes of chronaxie help to determine the degree of excitability impairment and also the degree of muscle impairment.

The shortest chronaxie is found in skeletal muscles (< 1 ms), heart muscle (5 ms), the longest one have smooth muscles (50-700 ms). The chronaxie can be read from the so called **I/t curve**, the dependence of current pulse intensity on its duration.

The I/t curve

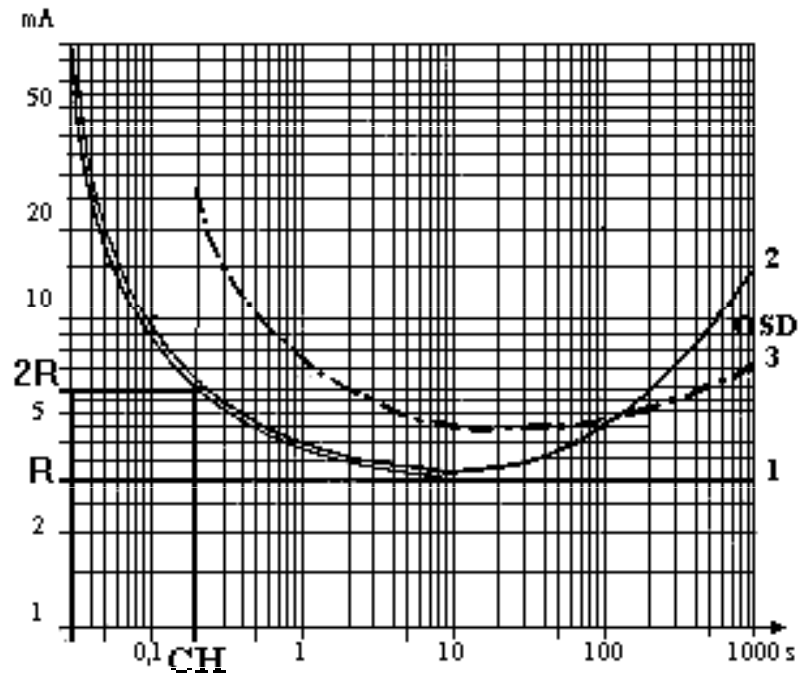

- The skeletal muscle with normal innervations reacts differently on stimulation by electric impulses with rapid onset (rectangular impulses) and with slow onset (triangular impulses).
- In short impulses below about 10 ms, the I/t curve has the same shape.
- For longer rectangular impulses the excitability does not change (curve 1) but the excitability for triangular impulses lowers (curve 2).
- The muscles with damaged innervations (denervated) are not excitable by very short impulses. However, their excitability for long impulses with slow onset increases (curve 3). So arises area of selective excitability („OSD“), which allows stimulation of denervated muscles without stimulation of healthy muscles.

Low-frequency AC - frequency dependence of stimulatory action

- In very low frequencies (< 100 Hz), the stimulatory action grows linearly with frequency. In high frequencies, the growth of stimulatory action becomes smaller and changes in decrease. In the range of 500 - 3000 Hz, the threshold value of stimulating current depends on \sqrt{f} . The stimulatory action starts to decrease above 3000 Hz and at about 100 kHz disappears fully.
- High frequency currents have no stimulatory action because the duration of one period is much more shorter than the shortest chronaxie. They have no electrochemical effects either.

Electrostimulation

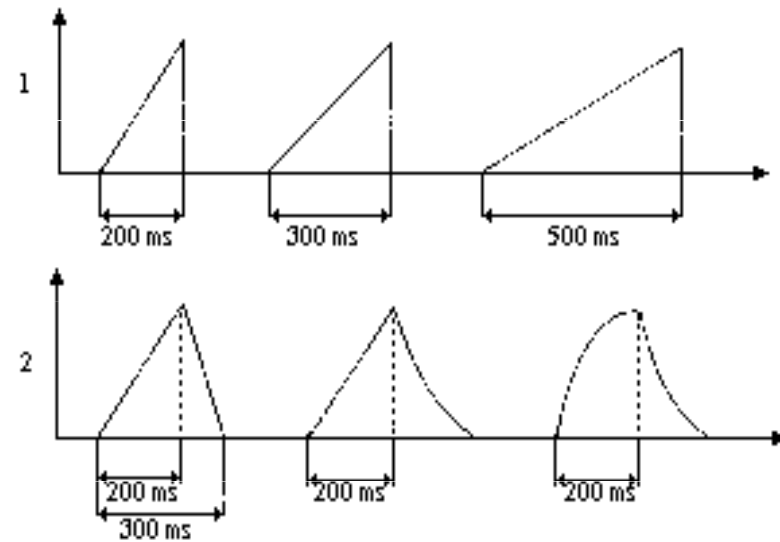

The stimulating effects depend on the amplitude, frequency, shape and modulation of pulses, and the kind of tissue!!!!

Thermal effects of high frequency (HF) currents

- Mechanism of the HF currents action is based on transformation of the absorbed electric energy into heat Q according to **Joule's law**:

$$Q = UIt$$

where U is voltage, t is the time of current / passage. This mechanism of heat production depends on the way of HF currents application.

- **Dielectric heating** (due to dielectric losses) takes place when applying currents by means of a capacitor field.
- When using induction fields, heat is produced by the so called **eddy currents**.

Utilisation of high-frequency (HF) electric currents

- In the case of alternating electric HF currents ($>100\text{kHz}$), the heat effects dominate totally. The heat originates directly in tissues due to dielectric heating, eddy currents or absorption of electromagnetic energy.
- For HF therapy, international agreements specified the following frequencies:
 - **Short-wave diathermy** (27.12 MHz, i.e. wavelength of 11.06 m),
 - **Ultra-short-wave diathermy** 433.92 MHz (69 cm),
 - **Microwave therapy** 2 400 or 2 450 MHz (12.4 or 12.25 cm) .
 - HF therapy makes possible deep heating.

Three ways of application of HF currents:

- 1. The tissue is connected in the electric circuit as a **resistor** by means of contact electrodes – classical diathermy. It is not used in practice today.
- 2. Tissue is connected as **dielectric** placed between insulated electrodes – **heating in the capacitor field**. The heat produced is proportional to the dielectric loss. Amount of heat arising in subcutaneous fat tissue is lower than in the muscles.
- 3. Use of **eddy currents** in magnetic field of a coil – **inductive heating**. An insulated cable is wound round a limb or a coil is laid to the body. The skin is less heated, 2 cm thick muscle layer lowers the heating to one half.

Different ways of HF diathermy

capacitor
field

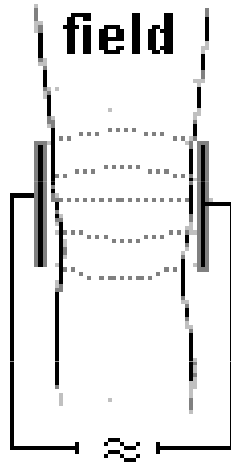

coil field

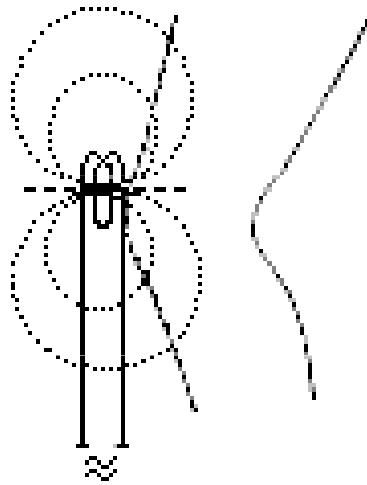

microwave
radiator

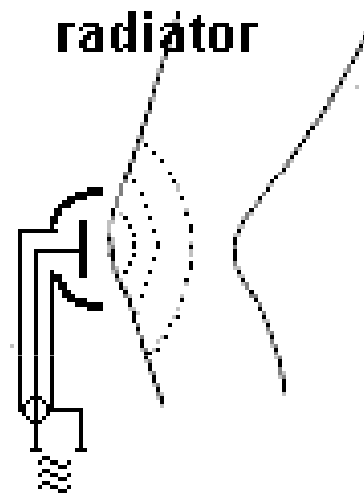

Application of **HF currents**

(a- condenser field, b- inductive, c- microwaves)

Short-wave diathermy – heating in capacitor field



Microwave therapy

Source: **magnetron**. The oscillations of electromagnetic field are led to an emitter - a dipole with a reflector. 1 cm of muscle is enough to lower the intensity to one half, the relation between heat production in the skin and the muscles is almost equalised. Microwaves put electrically charged particles (ions, dipoles) into oscillatory motion which is transformed into heat by friction.

Microwave diathermy

(older type)



MUNI

Potential risks of microwave and radiofrequency radiation

- Mainly thermal effects.
 - Microwave sources
 - Radars
 - Cell phones
 - Radio and TV transmitters
 - Electric mains
 - Trolley lines (wires)
- Some studies showing carcinogenic effects of microwaves or low-frequency electromagnetic fields were not verified sufficiently, but it is prudent to reduce exposures.

Ultrasound therapy

- Ultrasound therapy is based on biological effects of ultrasonic oscillations which are not electric. Despite of that, this therapy is sometimes included in the list of electrotherapeutic methods.
- An ultrasound (US) therapeutic system consists of two main parts: generator of HF electric current and the application probe, the US source itself, which consists of a piezoelectric transducer.
- In therapy, $f = 0.8 - 1$ MHz is used, sometimes up to 3 MHz, with intensity of US - typically $0.5 - 1 \text{ W}\cdot\text{cm}^{-2}$. Exposure time is 5 - 15 min., in 5 - 10 repetitions. US can be applied continuously or pulsed.
- The main therapeutic mechanism is **high-frequency massage** of tissue. Additional effects are tissue **heating** (causing hyperaemia) and some **physico-chemical effects**.
- Acoustic coupling between the probe and the skin is secured by a gel (local application) as well as water (underwater application).
- Main indications of US therapy: chronic joint, muscle and neural diseases. Limited success is reported in healing wounds after surgery, healing injuries and varicose ulcers.

Thermal action of ultrasound

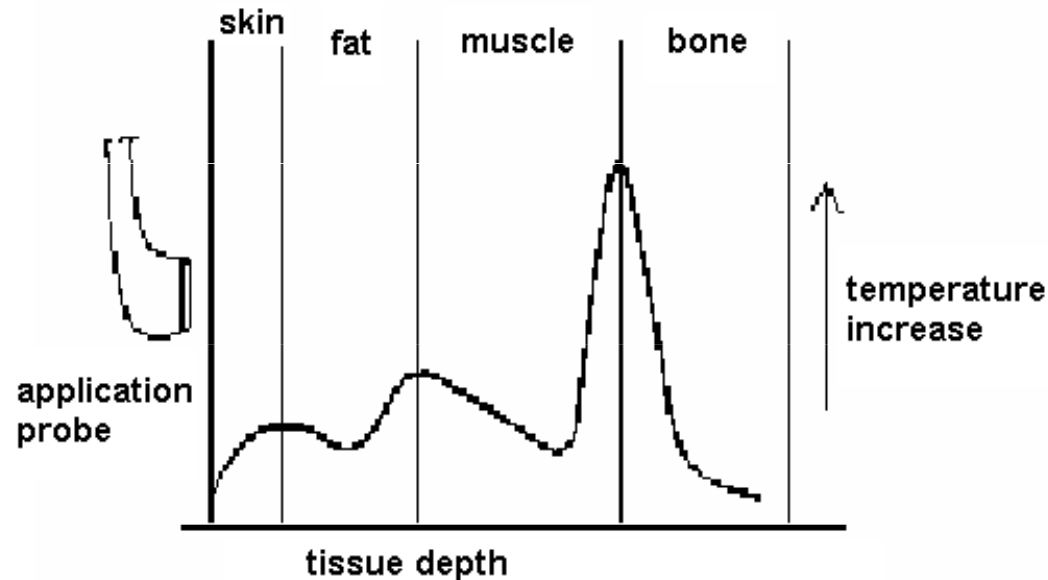

In US therapy, thermal dissipation of acoustic energy takes place. Tissue heating depends on physical properties of tissue and its blood supply. The highest heating appears at the interfaces between tissues of very different acoustic impedances. The thermal action of US cannot be considered without respect to other healing mechanisms (micromassage etc.)

Ultrasound - THERAPY



Effects of magnetic fields - magnetotherapy

- Basic concepts: magnetic fields: static, alternating and pulsed. Homogeneous and non-homogeneous magnetic fields.
- Magnetic flux density B depends on the *magnetic permeability of the medium* μ :

$$\mu = \mu_r \cdot \mu_0$$

- **Ferromagnetic substances** - $\mu_r \gg 1$.
- **Diamagnetic substances** - μ_r is slightly lower than 1
- **Paramagnetic substances** - μ_r is slightly higher than 1.
(μ_0 is permeability of vacuum – $4\pi \cdot 10^{-7} \text{ N}\cdot\text{A}^{-2}$)
- Body tissues are composed almost only from diamagnetic and paramagnetic substances. **Magnetic fields can induce electric voltages and currents** in biological medium (due to action of Lorentz force on moving electrical charges, or by action of Faraday force in varying magnetic fields). The induced voltages are, of course, substantially lower than the membrane potentials.

Magnetomechanical and magnetochemical effects



- In a strong mg field, the diamagnetic and paramagnetic molecules orient themselves to minimise their free energy. In non-homogeneous fields with big gradients, a translation **movement** of ferromagnetic compounds takes place (in living organisms negligible). A strong mg field (over 1 T) would reduce the flow rate of laminar streaming in a tube.
- Further, it is necessary to consider indirect action as well, mediated by free radicals arising as a consequence of **magnetochemical reactions**.
- We can say that a stable magnetic field of high intensity inhibits metabolic processes, but a varying one stimulates them. These changes are transient.
- The interactions of magnetic fields with human tissues are utilised in both diagnostics and therapy. **Magnetotherapy** is an example of healing procedure. **Magnetic stimulation of brain** can be used both in diagnostics and therapy.

Magnets in medicine



Magnetotherapy



Biomagnetism quackery of Franz Messmer 200 years ago



Transcranial magnetic stimulation

Phototherapy

Ultraviolet (UV), visible (VIS) and infrared (IR) light sources are commonly used in medicine, namely in physical therapy.



Light radiation

- **ultraviolet (UV)** 1- 380 nm:
 - UV-A** 380 - 315 nm
 - UV-B** 315 - 280 nm
 - UV-C** 280 - 190 nm
- **visible (VIS)** 380 - 780 nm
- **infrared (IR)** 0.780 - 1 mm:
 - IR-A** 0.78 – 1.4 μm
 - IR-B** 1.4 – 3.0 μm
 - IR-C** 3.0 μm – 1.0 mm
- From a practical point of view, the ultraviolet range begins from the wavelength of 190 nm. The spectral range 1 - 190 nm is so called vacuum UV radiation. It is attenuated strongly even by air and hence its biological effects are rare.

Sources of light

- The only natural source is the **Sun**.
- The other sources are artificial and each of them emits only one part of the optical spectrum:
 - **Hot objects**. The wavelength of radiation depends on source temperature, its spectrum is continuous. Light bulbs and various sources of radiant heat.
 - **Luminescent sources** (fluorescent lamps and tubes). They are based on excitation processes in atoms and molecules. Spectrum of these sources can consist of individual spectrum lines.
 - Both these sources emit non-coherent radiation.
- The only artificial source of intense coherent light is the **laser**.

Sources of visible light

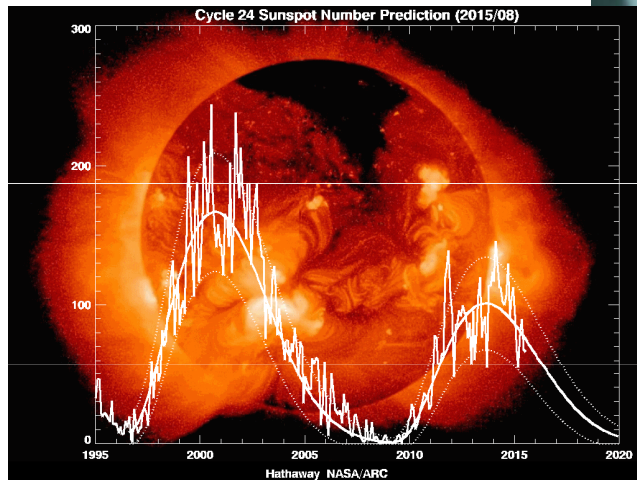
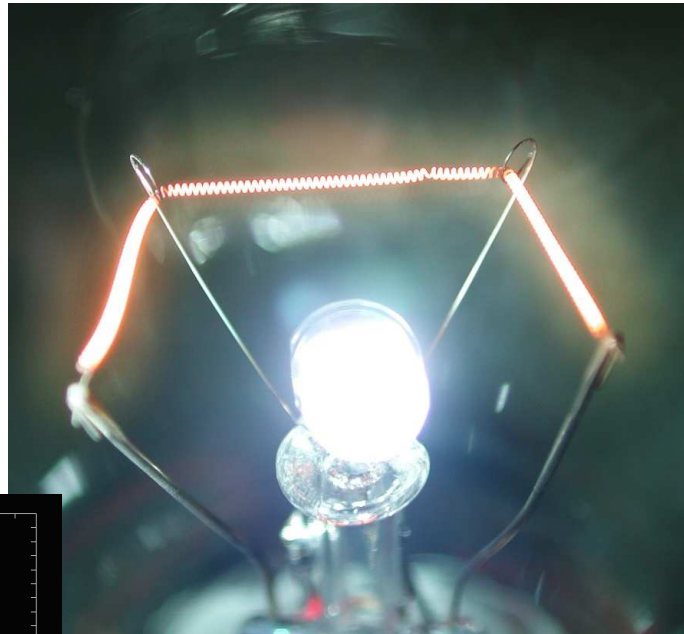

Molecular mechanisms of biological effects of light

- Energy of **single atoms** depends on its electron configuration. Delivery of energy causes electron jumps to higher energy levels (ΔE_e) – an excited state arises. Absorption spectrum is not continuous. The excitation takes place mainly in the valence shell.
- Energetic states ΔE of a **single molecule** are, in principle, sums of electron energies ΔE_e corresponding to the electron configuration, vibration energy ΔE_v and rotation energy ΔE_r :

$$\Delta E = \Delta E_e + \Delta E_v + \Delta E_r$$

- All the three kinds of energy are quantised. The action of the radiation depends on photon energy. The lowest energy have photons of IR-C, it corresponds to the changes of rotation energy of molecules. The energy of IR-B and IR-A photons can influence both the vibration and rotation of molecules. The energy of VIS and UV photons can influence rotation, vibration and also electron configuration.

Effects of visible light

Photosynthesis

↳ biochemistry

Photoreception

↳ biophysics of vision

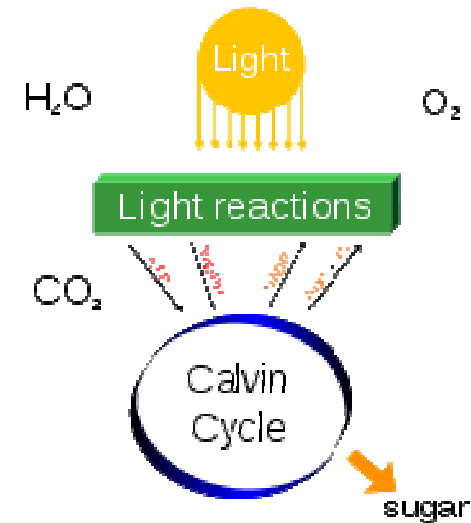
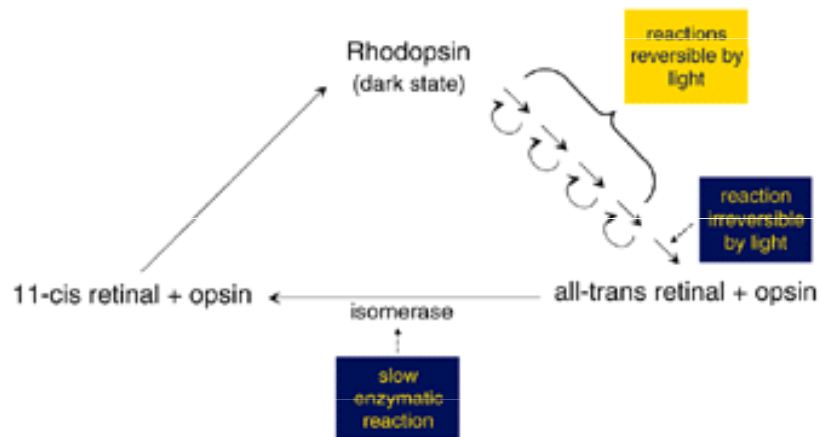

Photosynthesis splits water to liberate O_2 and fixes CO_2 into sugar

From Wikipedia, the free encyclopedia

Molecular effects of ultraviolet radiation

- Considering compounds of biological importance, the most sensitive are those with **conjugated double bonds**.
- In proteins, the most sensitive amino acids are tyrosin and tryptophan. (abs. maximum around 280 nm).
- In NA, the N-bases are sensitive. Their absorbance is higher than the absorbance of proteins, maximum at 240-290 nm.
- UV radiation penetrates only into the surface layers of the skin
- The skin effect of UV light manifests itself as reddening – **erythema** – followed by melanin **pigmentation** ⇒ **protecting mechanism** against further penetration of UV. **Synthesis of vitamin D which controls metabolism of Ca and P** (its lack causes rickets - rachitis), is an important positive effect of UV light. We cannot also exclude the carcinogenic effect of UV since almost 90% of skin cancer appears on uncovered areas of the skin.

Sources of ultraviolet radiation

- Sun
- Mercury discharge tube (used in medicine)
- Hydrogen or deuterium discharge tubes (used in research)
- Xenon lamp
- Electric arc, lightning etc.
- Some lasers

Penetration of UV radiation

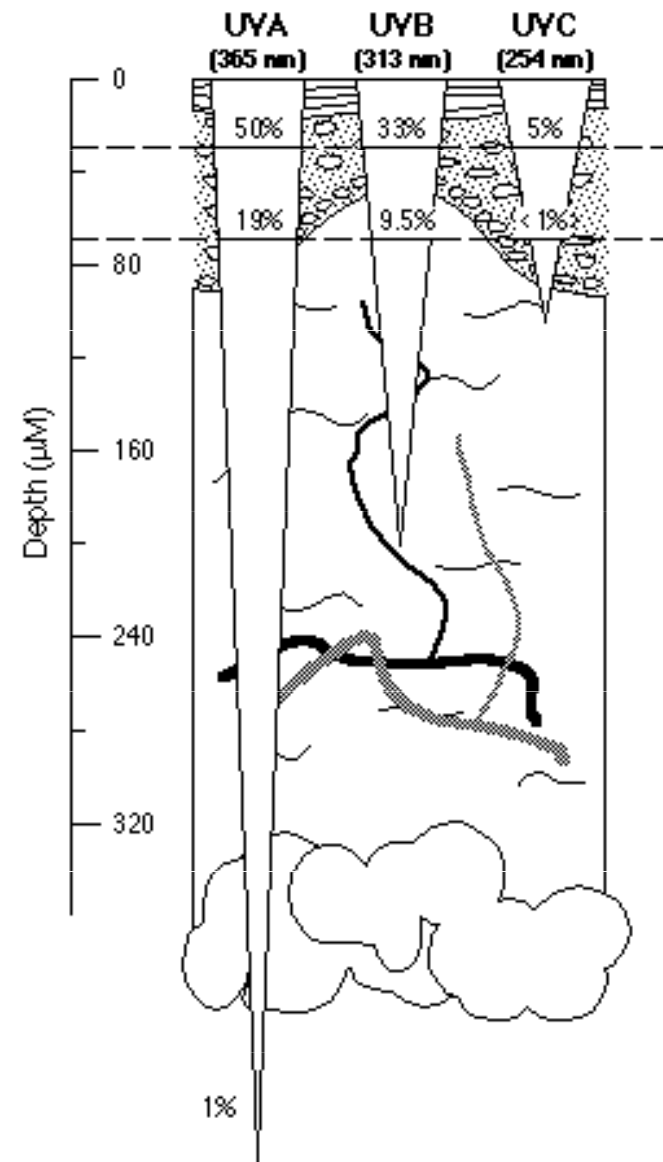

Effects of ultraviolet radiation on living organisms

Sunburns - erythema

Effects on eye: blepharospasm (uncontrollable closure of eye lids) – originates due to damage of cornea by UV radiation. ⇒ protection by goggles with UV filter. Lens cataract can arise (Fig.↓)

UV-C with wavelength below 280 nm has outstanding **bactericidal action**. ⇒ sterilisation of labs, special boxes and surgery rooms.



Sources and effects of infrared light

- All the three ranges of IR radiation have **thermal effects**.
 - IR-A is involved in sun light. It passes through glass and is only little absorbed by water.
 - IR-B is emitted from various lamps and discharge tubes. It passes through glass but is well absorbed by water.
 - IR-C is emitted from heater, hot bodies, humans.... Absorbed by glass and water.
- Almost all IR radiation is absorbed by skin. It causes local vasodilatation and **thermal erythema** which looks like diffuse red patterns and, in contrary to the erythema caused by UV light, its duration is short. Pigmentation is very weak. The irradiation by IR light, however, increases skin sensitivity to the UV light.
- A long exposure of eyes to the IR radiation can cause in some professions (glass-blowers, founders, smelters, steelmen etc.) the so called **heat cataract** (opacity of the lens).

IR radiation heat transfer

Heat action of the visible and IR light from artificial sources:

- Lamp boxes – radiation heat in enclosed space. Skin receptors are stimulated, whole-body heating occurs.
- **IR lamps: Solux, Sirius** - high-power lamps with blue or red filters, radiators of IR light. The radiation is absorbed mainly in body surface. Used mainly in dermatology, ORL and dentistry. Skin receptors are stimulated, suggestive feeling of heat, reflex vasodilatation and muscular relaxation takes place.

Penetration of IR radiation

Lowering light intensity
to 35 % of original value

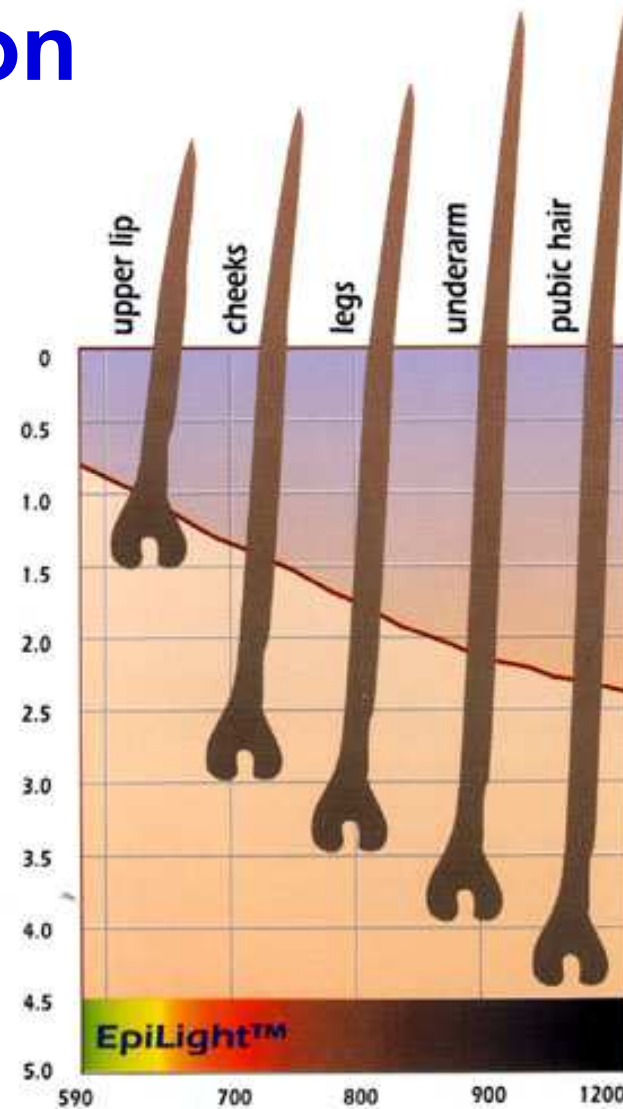

MUNI

<http://www.depilazione.net/news4.htm>

Thermal Erythema

Thermal erythema –
erythema as a
consequence of
excessive use of
electric pad -



Summary – effects of light

CIE band	UV-C	UV-B	UV-A	VISIBLE	IR-A	IR-B	IR-C
	100	280	315	400	700	1400	3000
Adverse Effects	Photokeratitis			Retinal Burns		Corneal Burns	
	Cataracts				Cataracts		
	Erythema			Colour Vision Night Vision Degradation			
			Thermal Skin Burns				

M U N I

Author:

Vojtěch Mornstein

Content collaboration and language revision:
Ivo Hrazdira, Carmel J. Caruana

Last revision November 2021,
soundtrack addition November 2020