

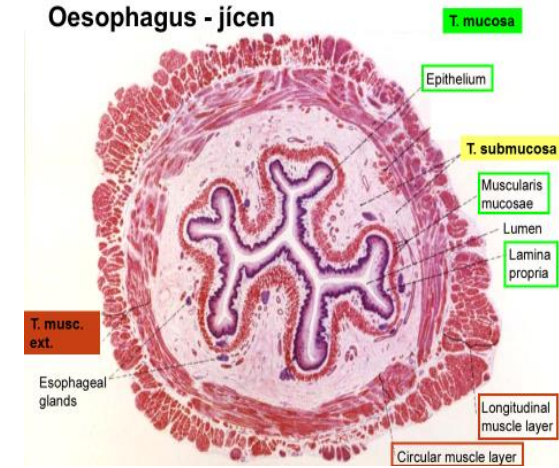

Digestive system 1

- Oral cavity:
 - Lips
 - Tongue
 - Palate – soft
 - hard
- Tooth

Common structure of the wall of GIT tube

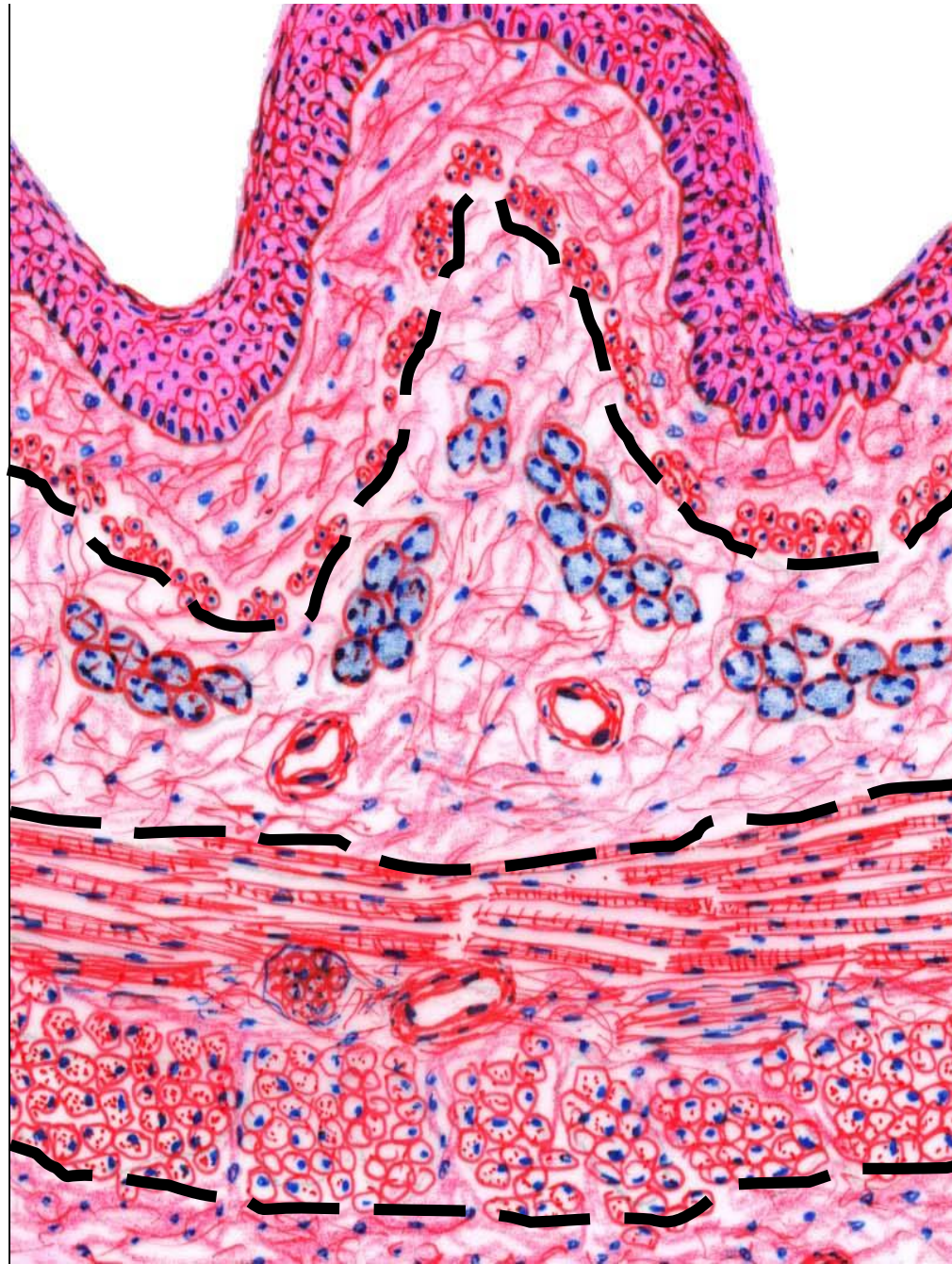

- **The tunica mucosa**
 - epithelial lining
 - lamina propria /loose connect. tissue/
 - lamina muscularis mucosae
- **The submucosa** (*tela* submucosa)
/loose connect. tissue + Meissner's nerve plexus/
- **The tunica muscularis externa**
 - circular
 - myenteric nerve plexus
 - longitudinal smooth muscle
- **The tunica serosa or adventitia**
/loose connect. tissue -/+mesothelium/

The oral cavity (the tunica mucosa)

The epithelium

nonkeratinized stratified squamous ep.

Lamina propria

loose connective tissue

The muscularis mucosae is missing!!!

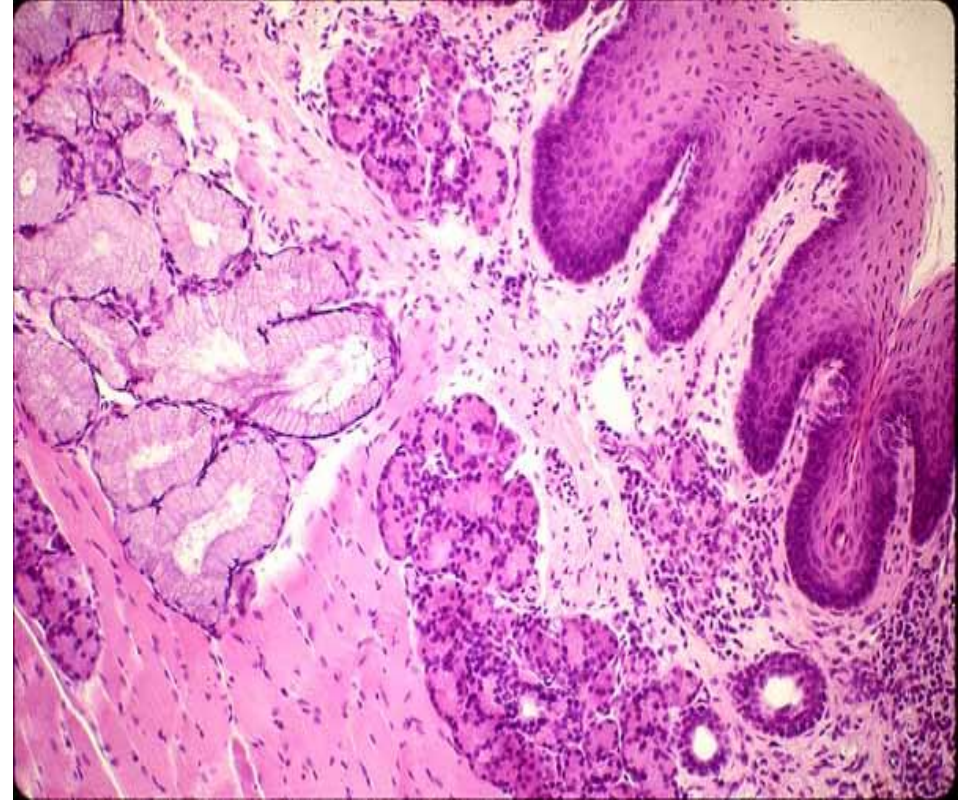

Lam. propria → the submucosa (loose connect. tissue) / periost / muscle

3 functional regions of oral mucosa:

- **covering** - lined with *submucosa* (lips, cheeks, soft palate, fac. mylohyoidea of the tongue)
- **masticatory** – submucosa is missing, mucosa firmly attached to the *periost* of the bone, so called *mucoperiost* (gingiva and hard palate)
- **specialized** – forms *papillae* (dorsum linguae)

Labium oris

External surface - skin

hair follicles

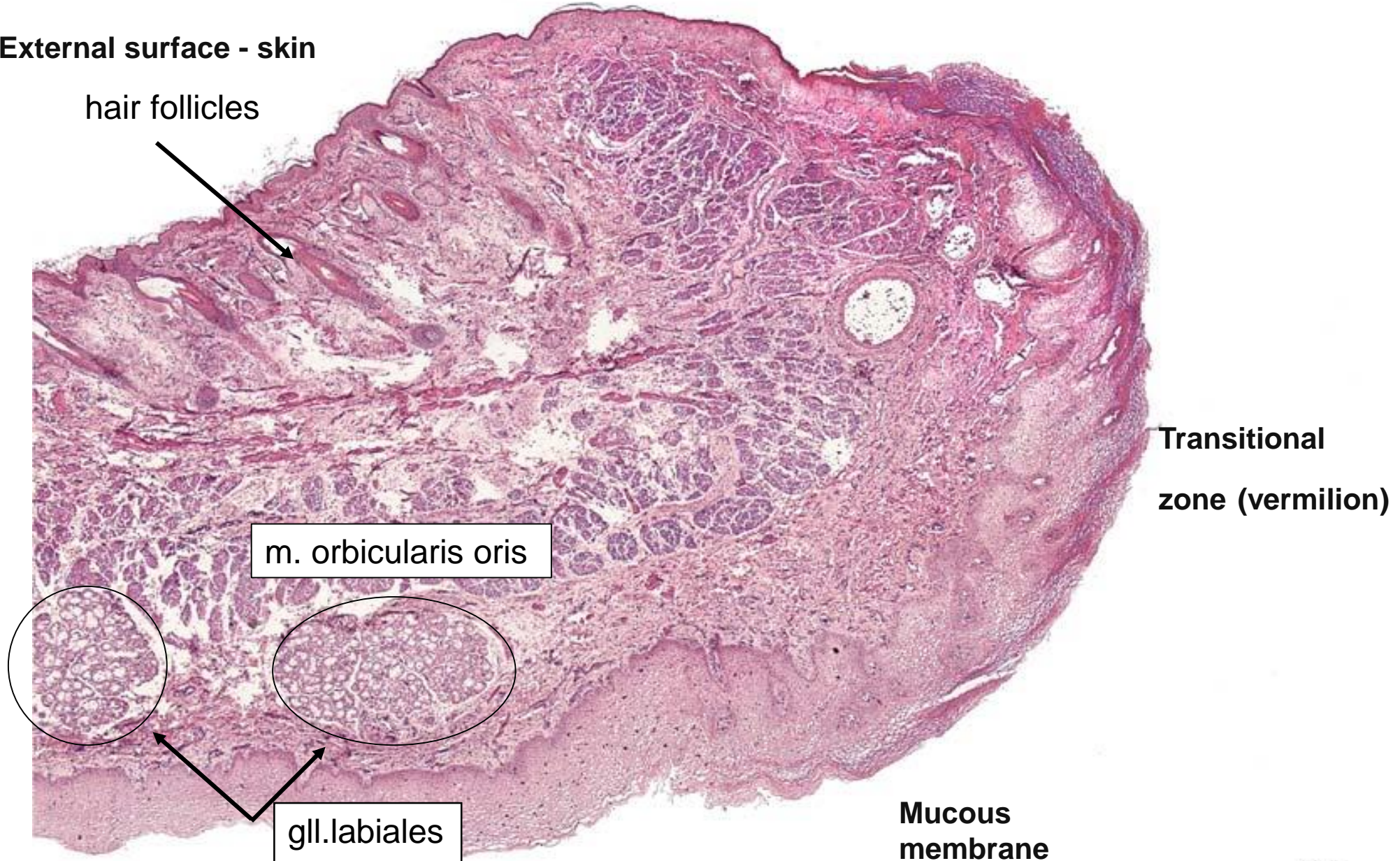

Transitional
zone (vermilion)

m. orbicularis oris

gll. labiales

Mucous
membrane

20 μ m

Lips (*labia*)

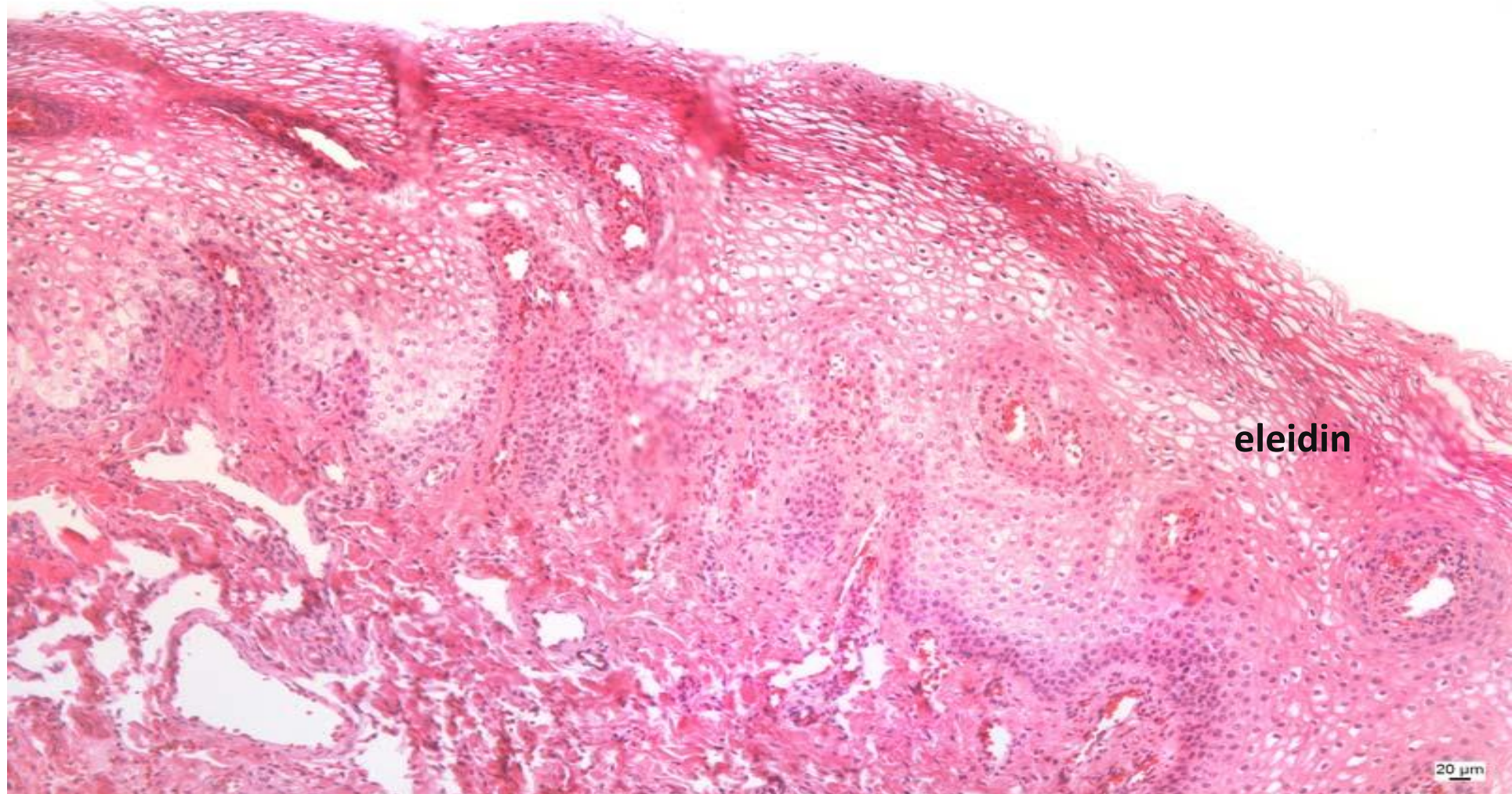

- The epithelium is somewhat thicker than in other parts of the facial skin.
- C.t. papilla extend deep into the epithelium and are heavily vascularized. It is the proximity of these vessels to the surface of the epithelium which gives the prolabium it's **red** appearance (+ presence of protein eleidin).

Labium oris – inner surface , (HE), objektiv 10x

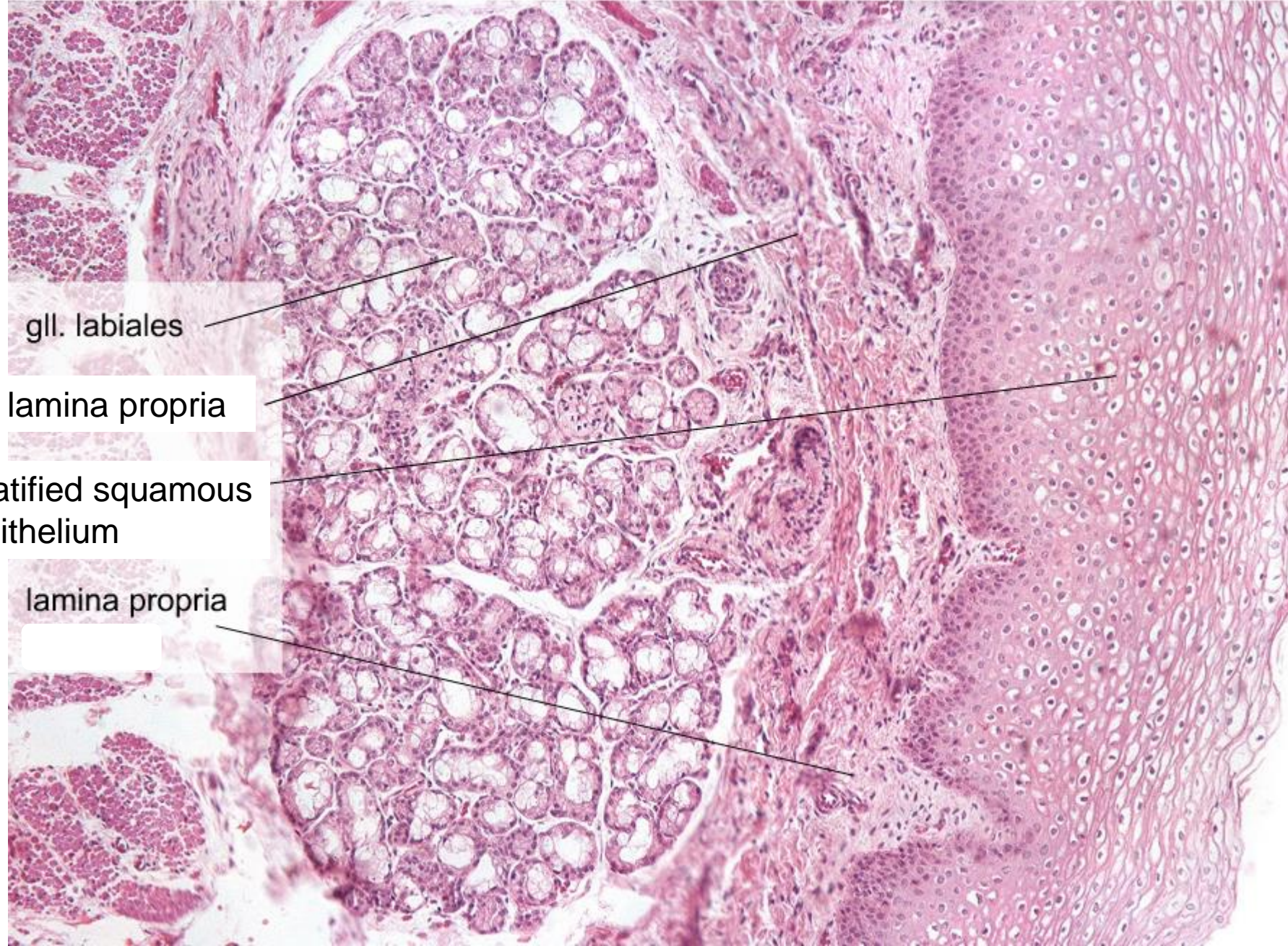

gll. labiales

lamina propria

stratified squamous
epithelium

lamina propria

Apex linguae

dorsum linguae

facies mylohyoidea

gl. apicis linguae - Blandini



Tongue

- dorsal surface

The mucosa – filiform, fungiform, circumvallatae, foliatae pap.
(the submucosa is missing!)
aponeurosis linguae

- inferior surface (mylohyoidea)

The mucosa – without specific papillae
the submucosa!



-papillae = elevations of the oral epithelium
and lamina propria

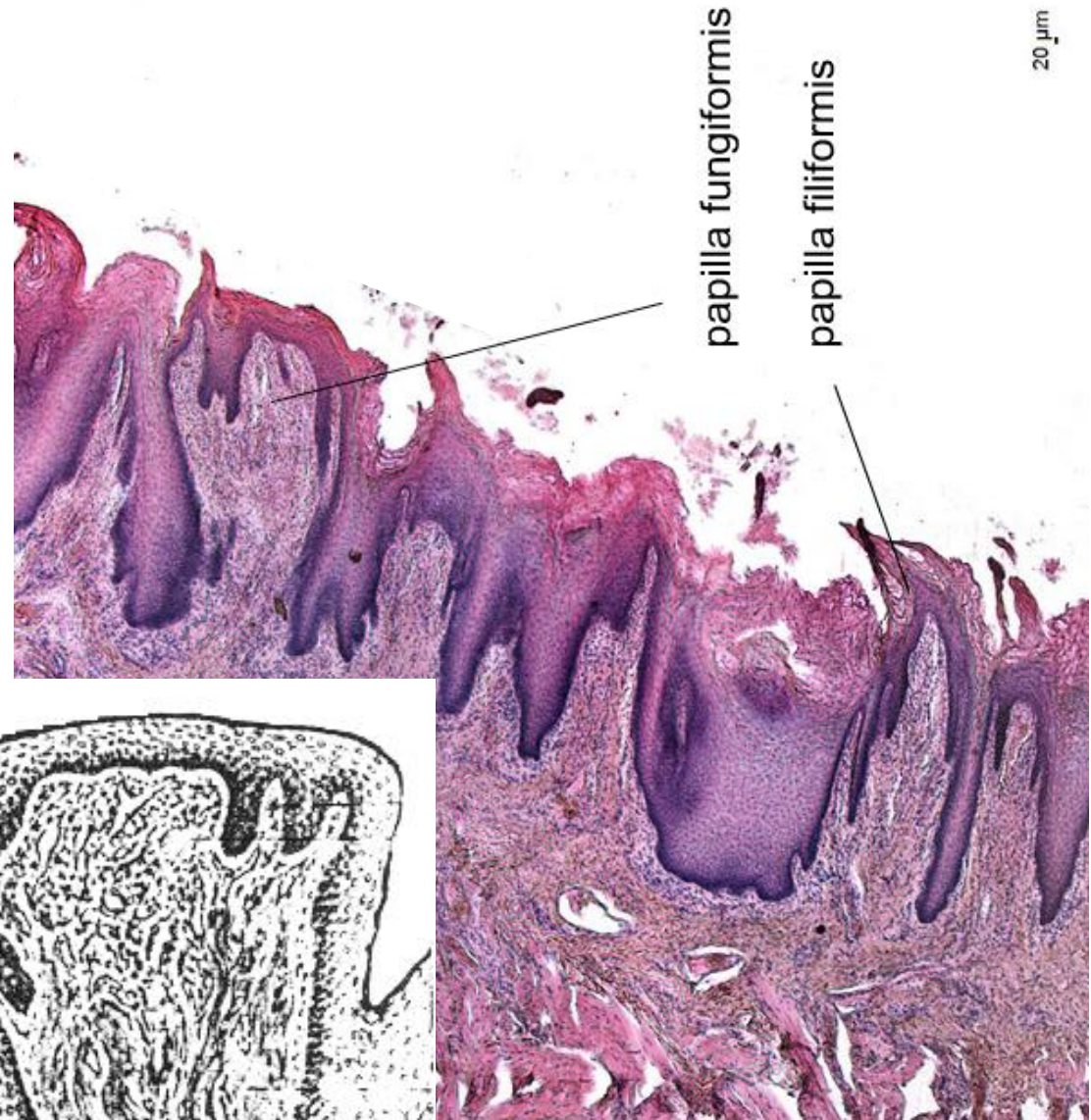

Apex linguae – dorsum, (HE), objektiv 2,5×

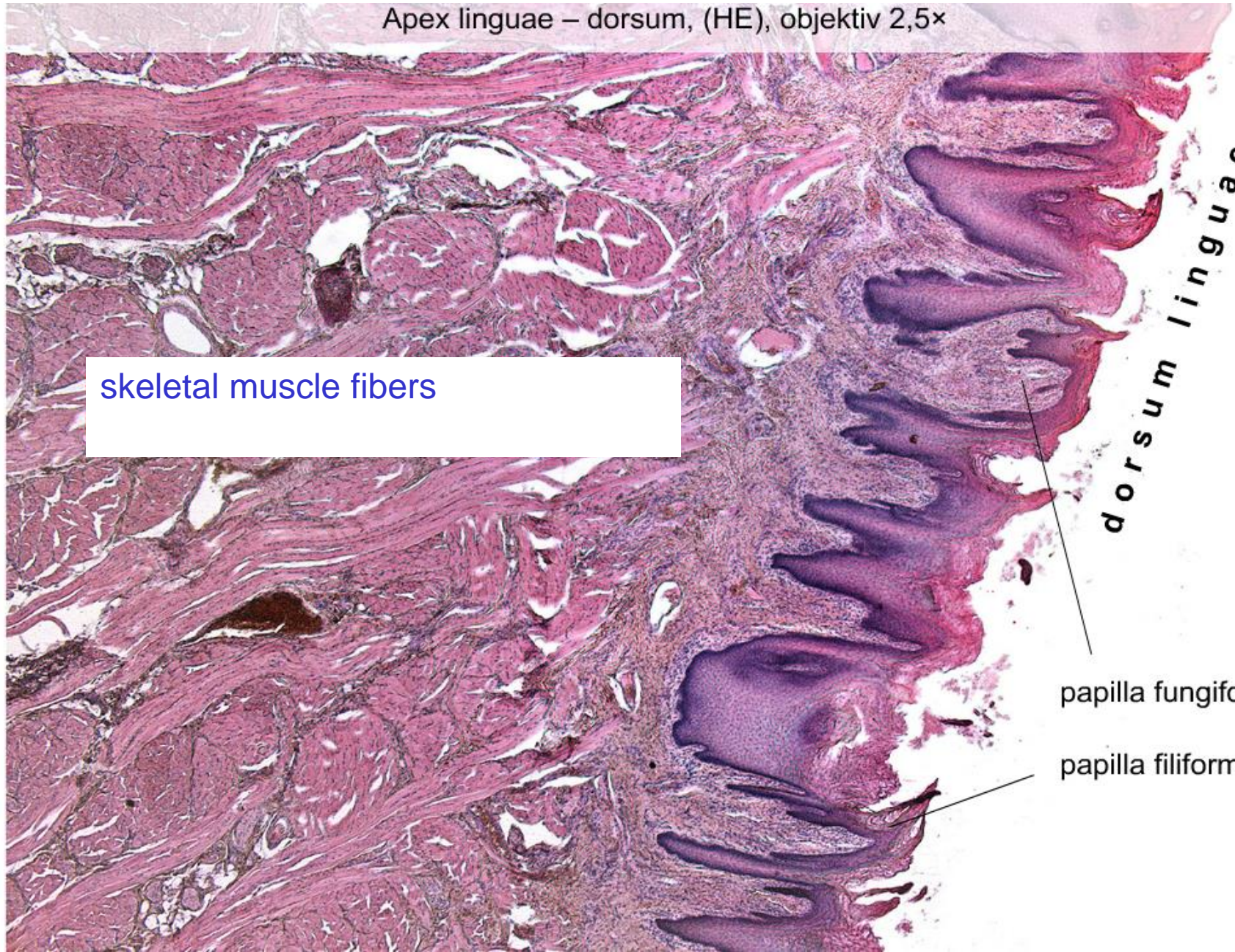

skeletal muscle fibers

dorsum linguae

papilla fungiformis

papilla filiformis

20 μ m

Apex linguae

lamina
propria

tela submucosa

facies
mylohyoidea

gl. apicis linguae - Blandini

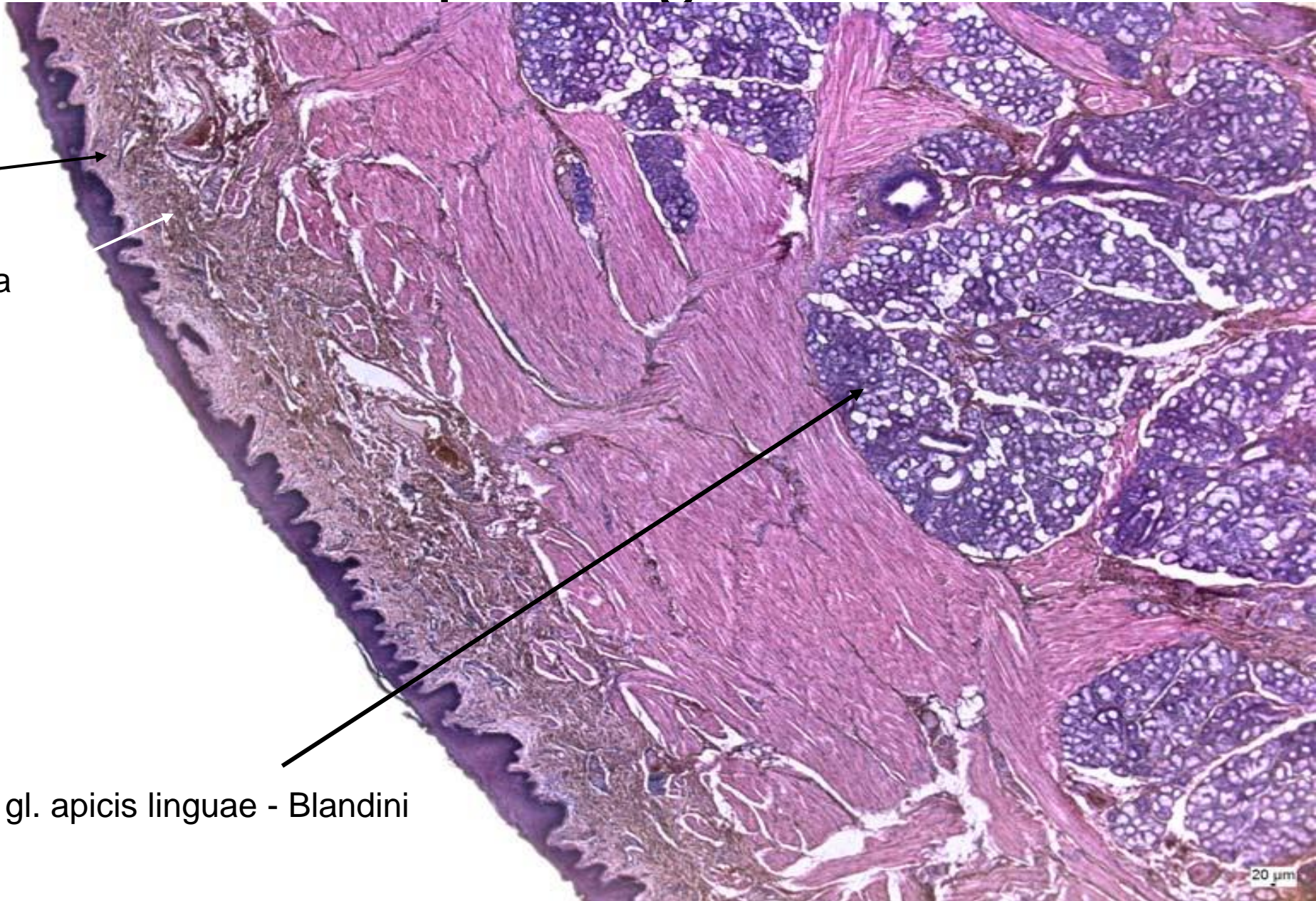

Circumvallatae papillae

The epithelial lining
– strat. squam. ep.

+ taste buds

Lamina propria
– loose connect. tissue
+ serous (von Ebner) glands-
drain into deep grooves

secondary papillae

primary papilla

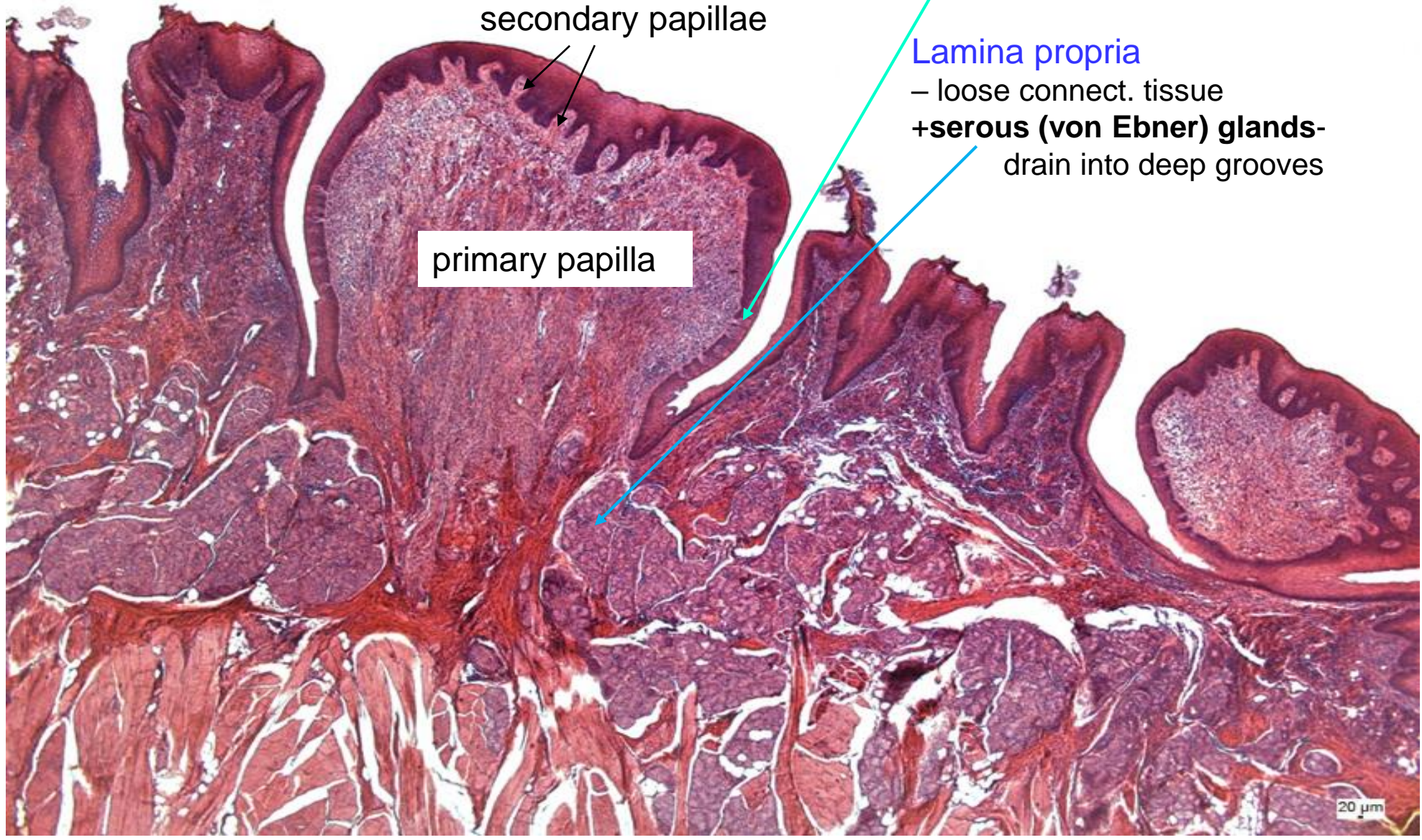

20 μm

Papilla circumvallata (HE)

taste bud



groove

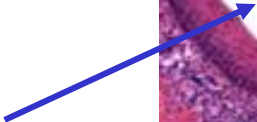

gland duct



gll. gustatoriae (Ebneri)

20 μm



Taste bud

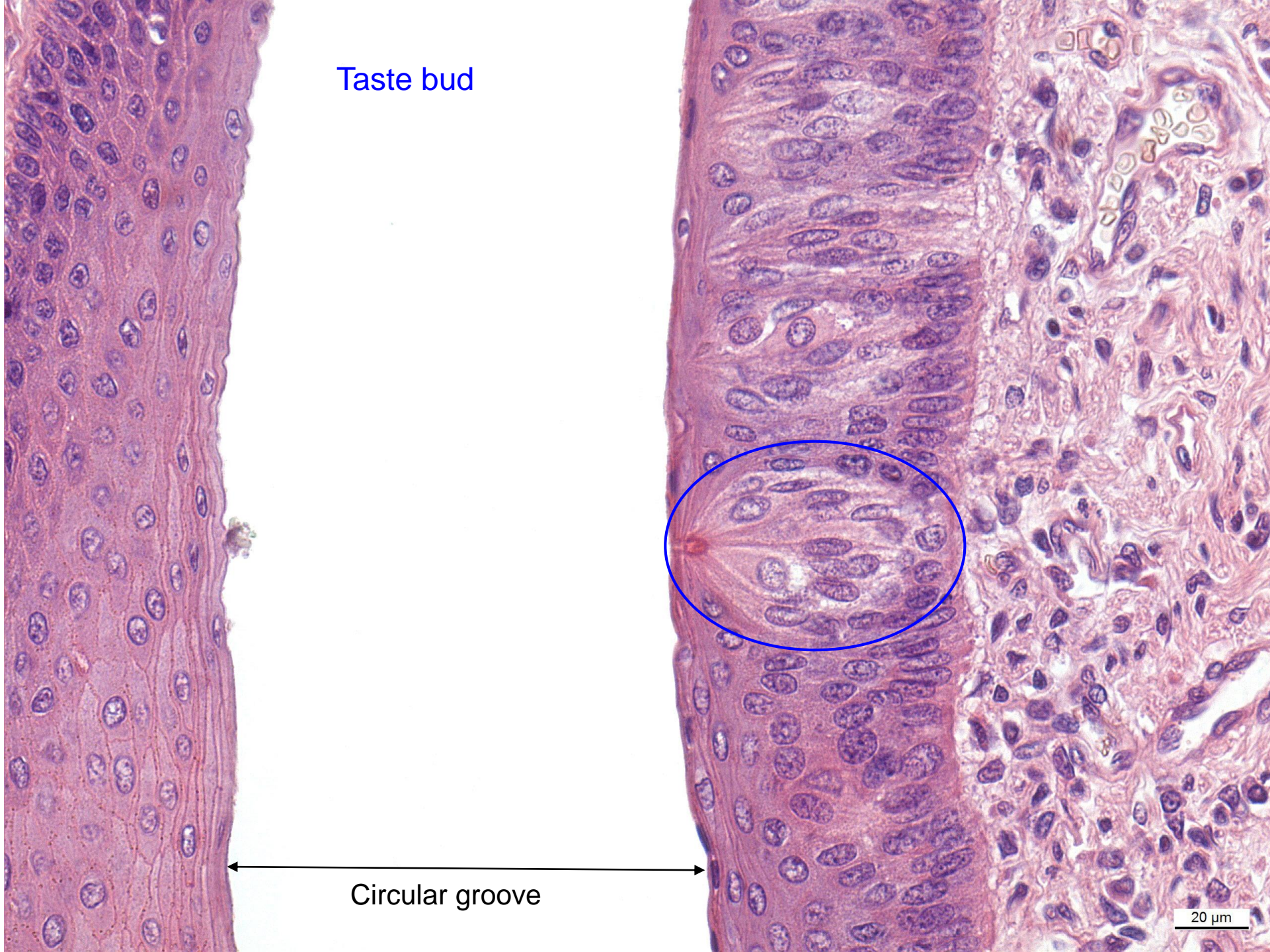

Circular groove

20 μ m

Soft palate

Nasal surface

Mixed gl. - gll.nasales

aponeurosis palatina-
skeletal muscle+connect. tissue

Mucous glands - gll. palatinae,

Oral surface

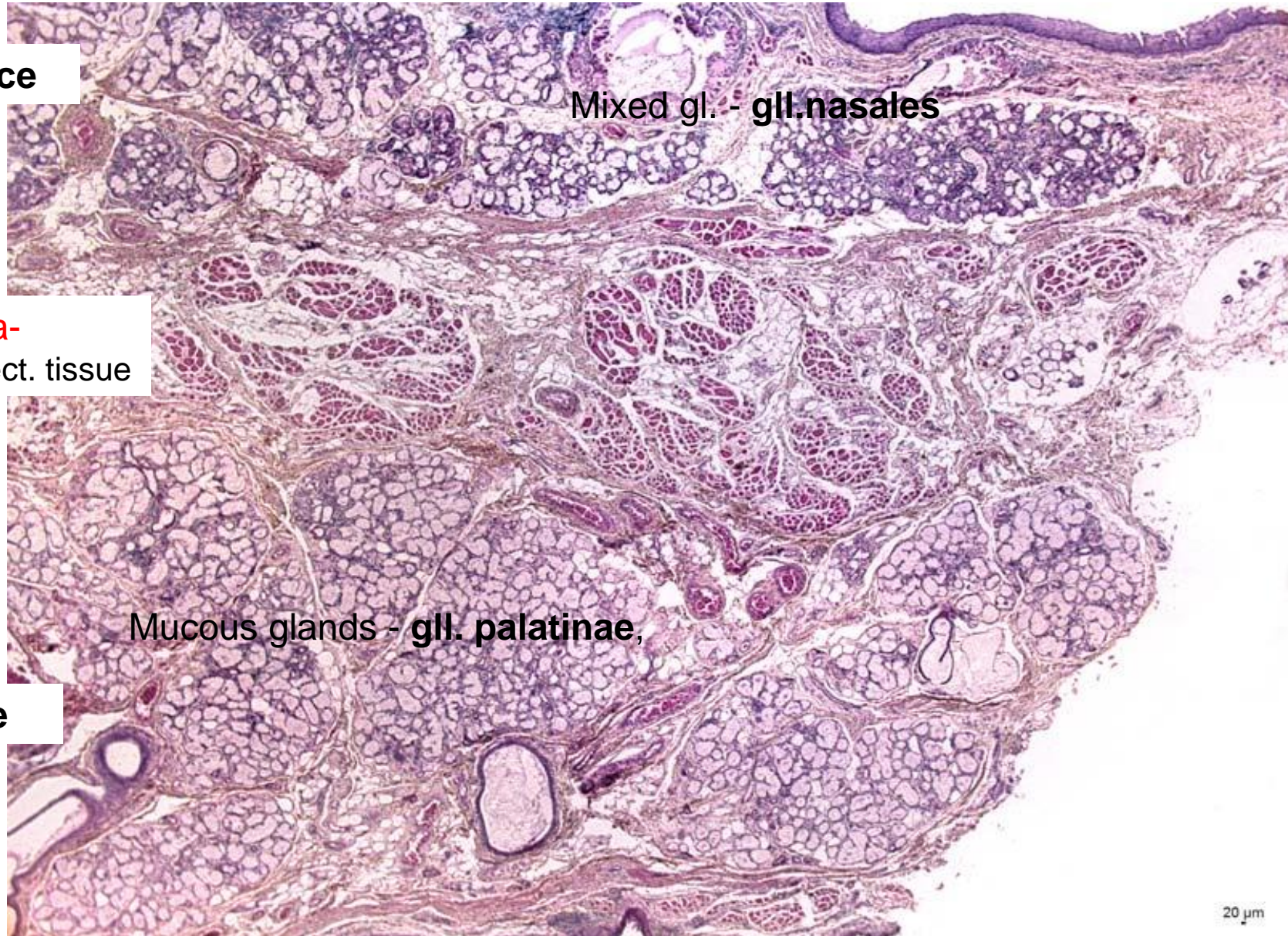

Nasal surface

- ciliated pseudostrat. columnar ep.(metaplasia)
- gl. nasales (mixed gl.)

**basement
membrane ?**

stratified squam. ep.

duct

20 μ m

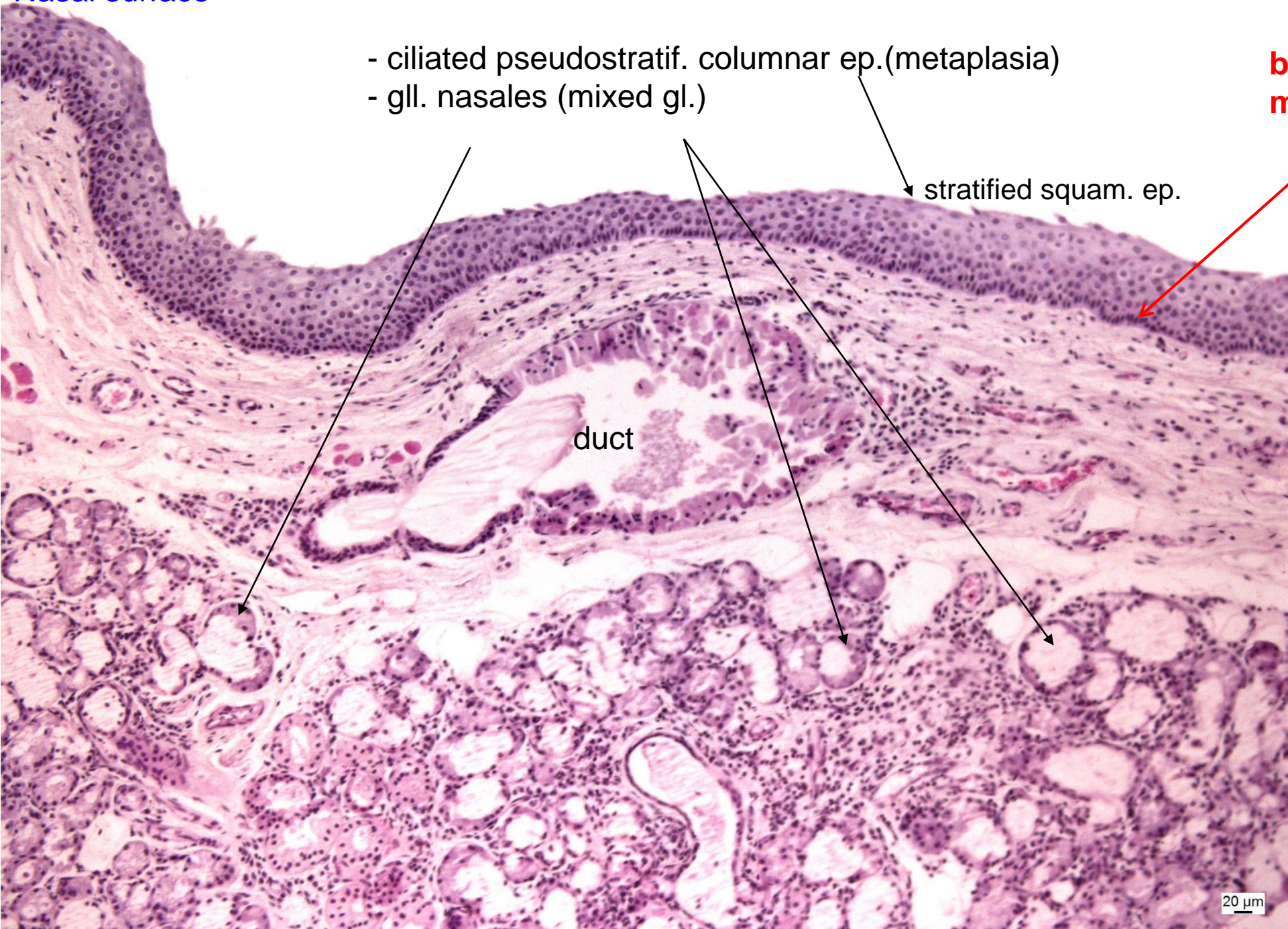

Oral surface

-stratified squamous epithelium

basement membrane ?

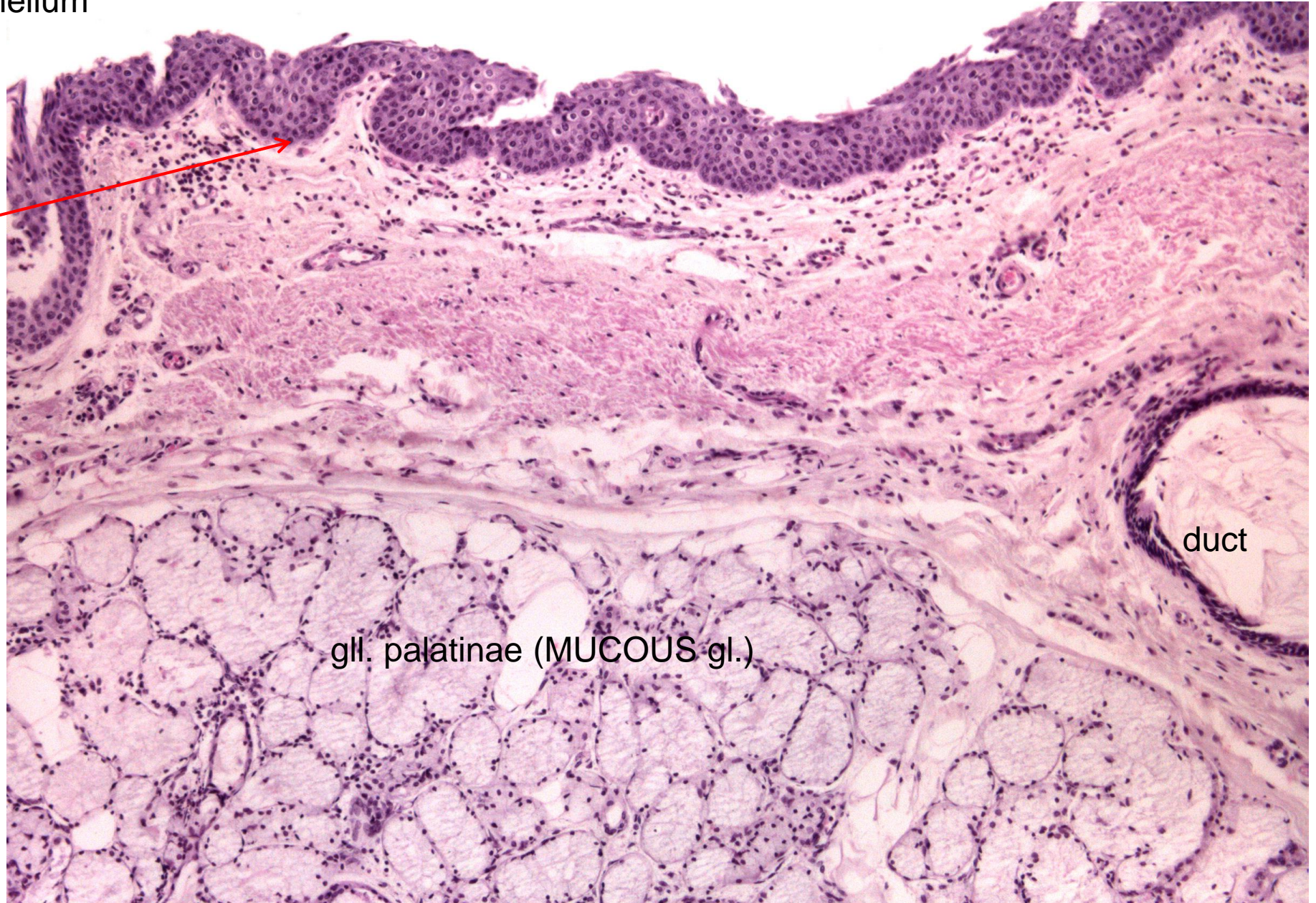

gll. palatinae (MUCOUS gl.)

duct

Tooth (dens)

Deciduous
(baby) teeth- 20

Permanent
teeth
- 28-32

radix (root)

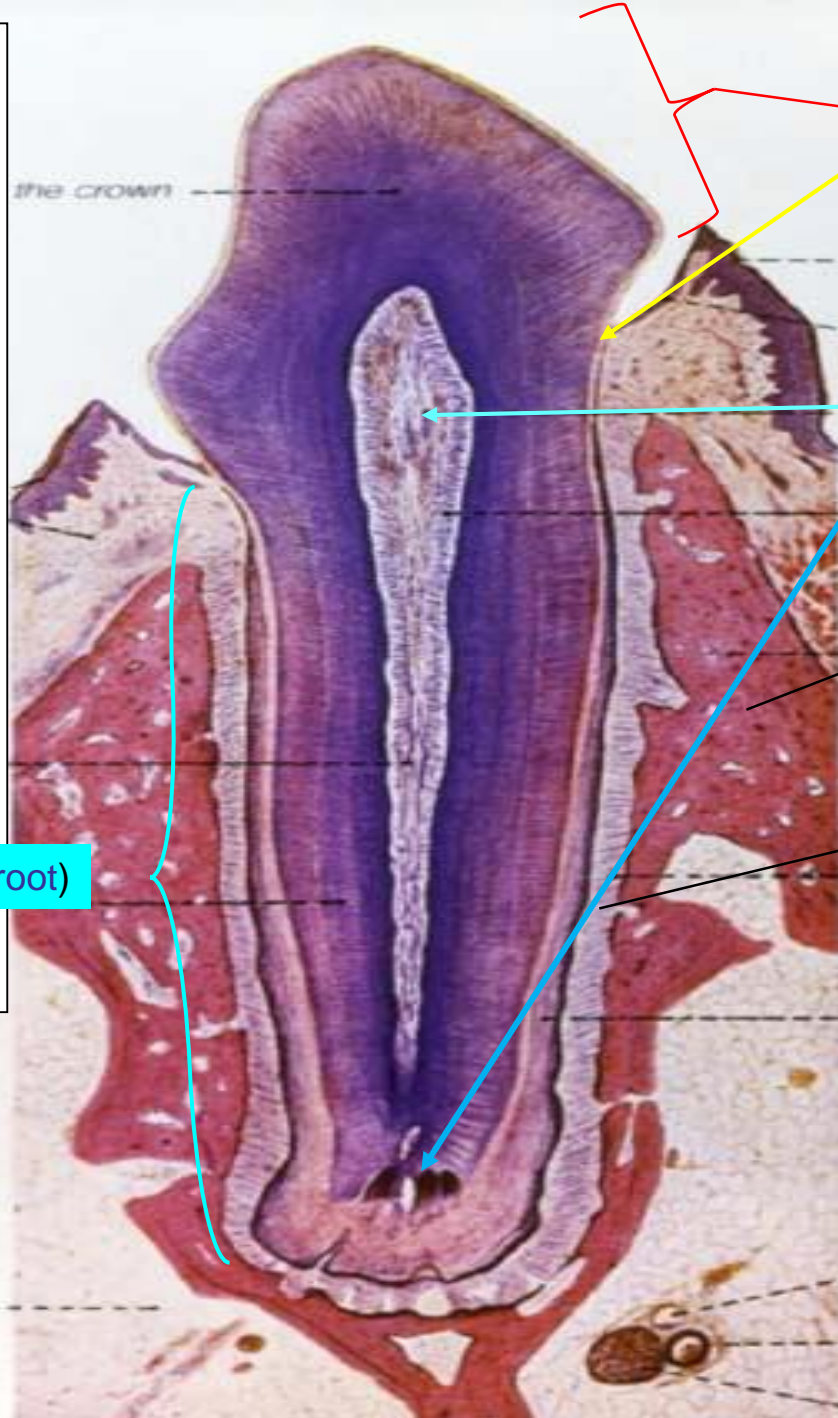

Anatomy

- Corona dentis (crown)
- Collum (neck)
- Radix (root)
- Cavum et canalis radices dentis (pulp cavity)
- Pulpa dentis
- Apex radices dentis + foramen apicis radices dentis (apical foramen)
- Alveoli
- Periodontal ligament (membrane)**
dense connective tissue fibers

Tooth

ROOT -----CROWN

cementum

enamel!!!!

dentin

dentinal tubules with odontoblast processes



Tooth – (HE) 5x

periodontium

cement

dentin

predentin

odontoblasts

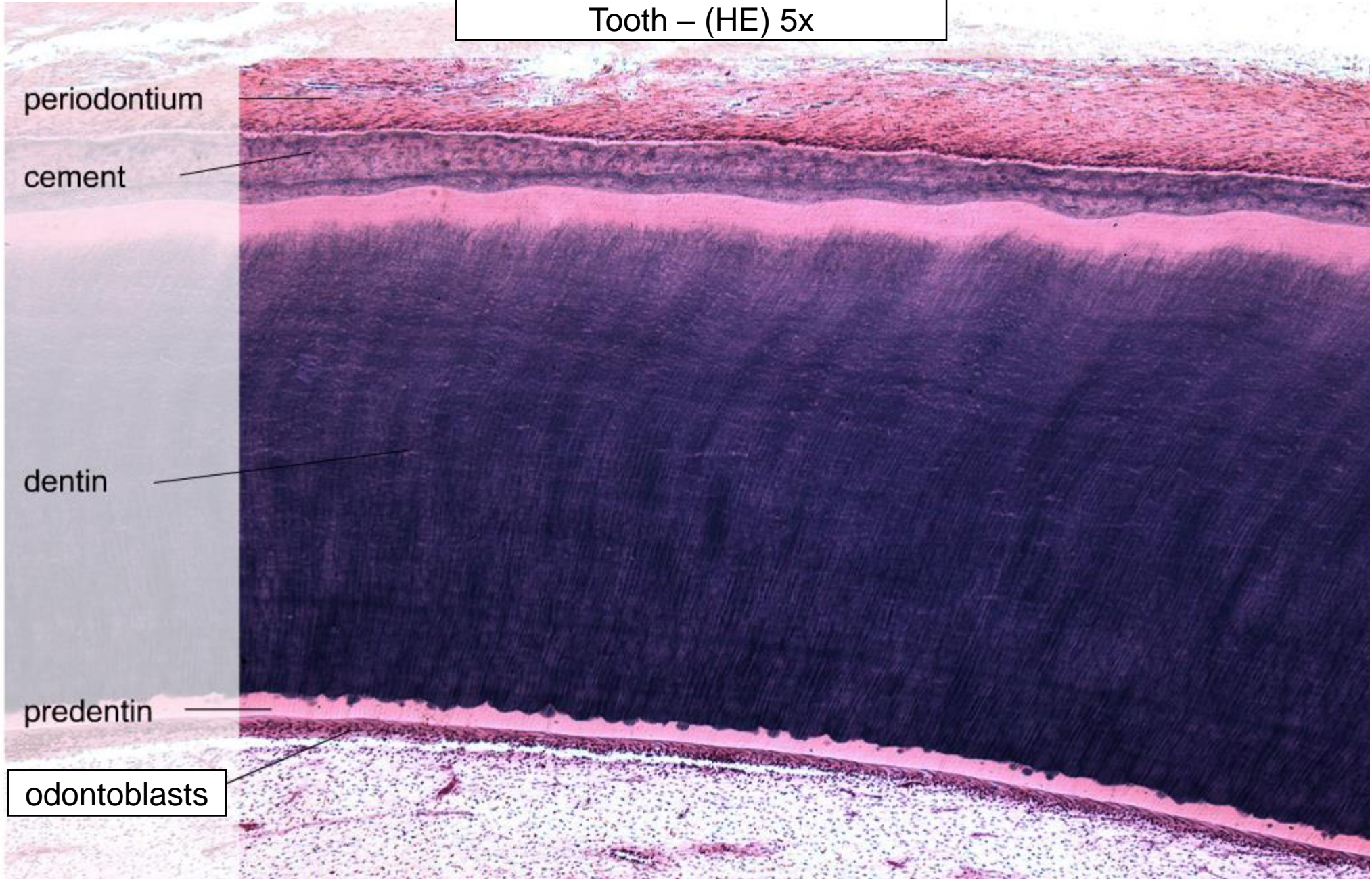



Enamel is missing!!!

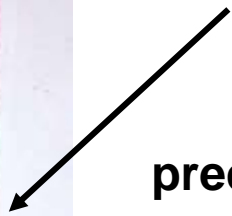

predentin – unmineralized dentin with nerve fibers

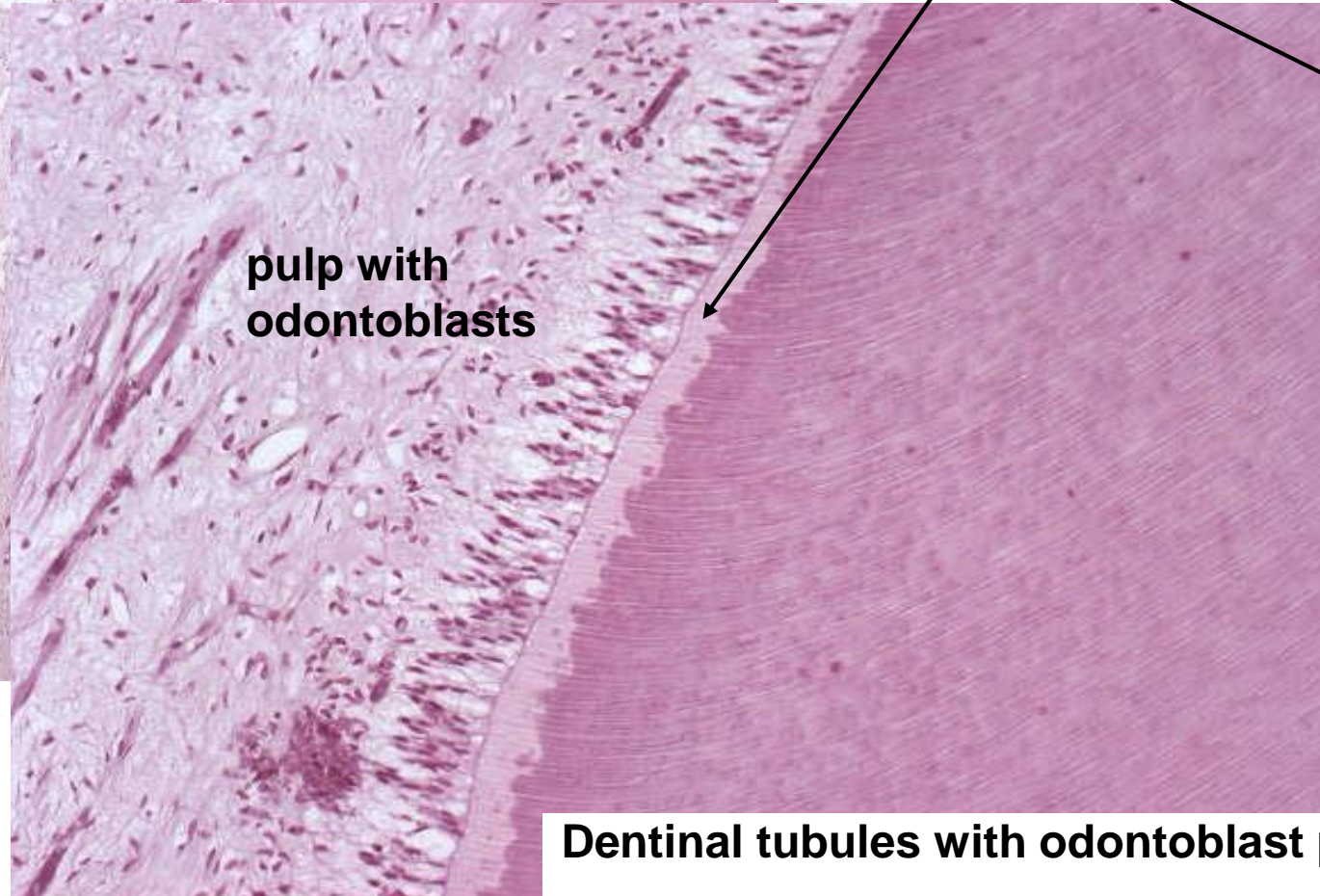
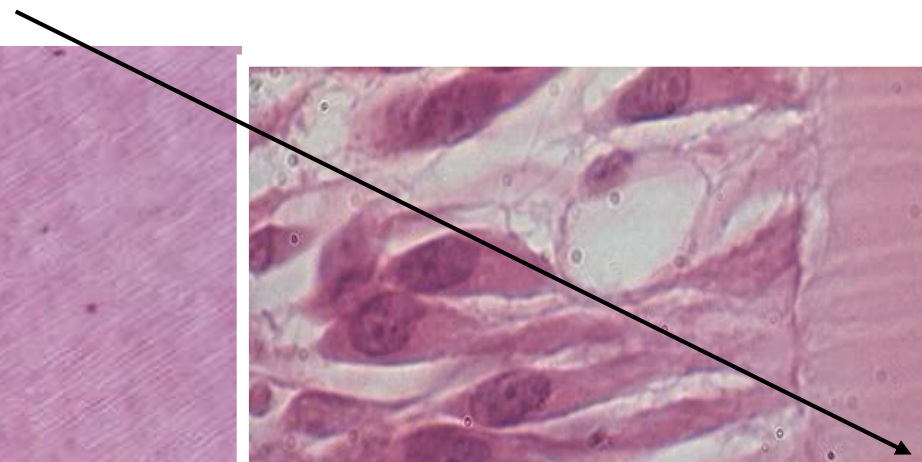

pulp with odontoblasts



Dentinal tubules with odontoblast processes



Periodontal ligament –
dense connective tissue
Alveolar bone – woven bone
Gingiva connective tissue
papillae+stratif.squamous ep.
**Epithelial attachment of
Gottlieb**

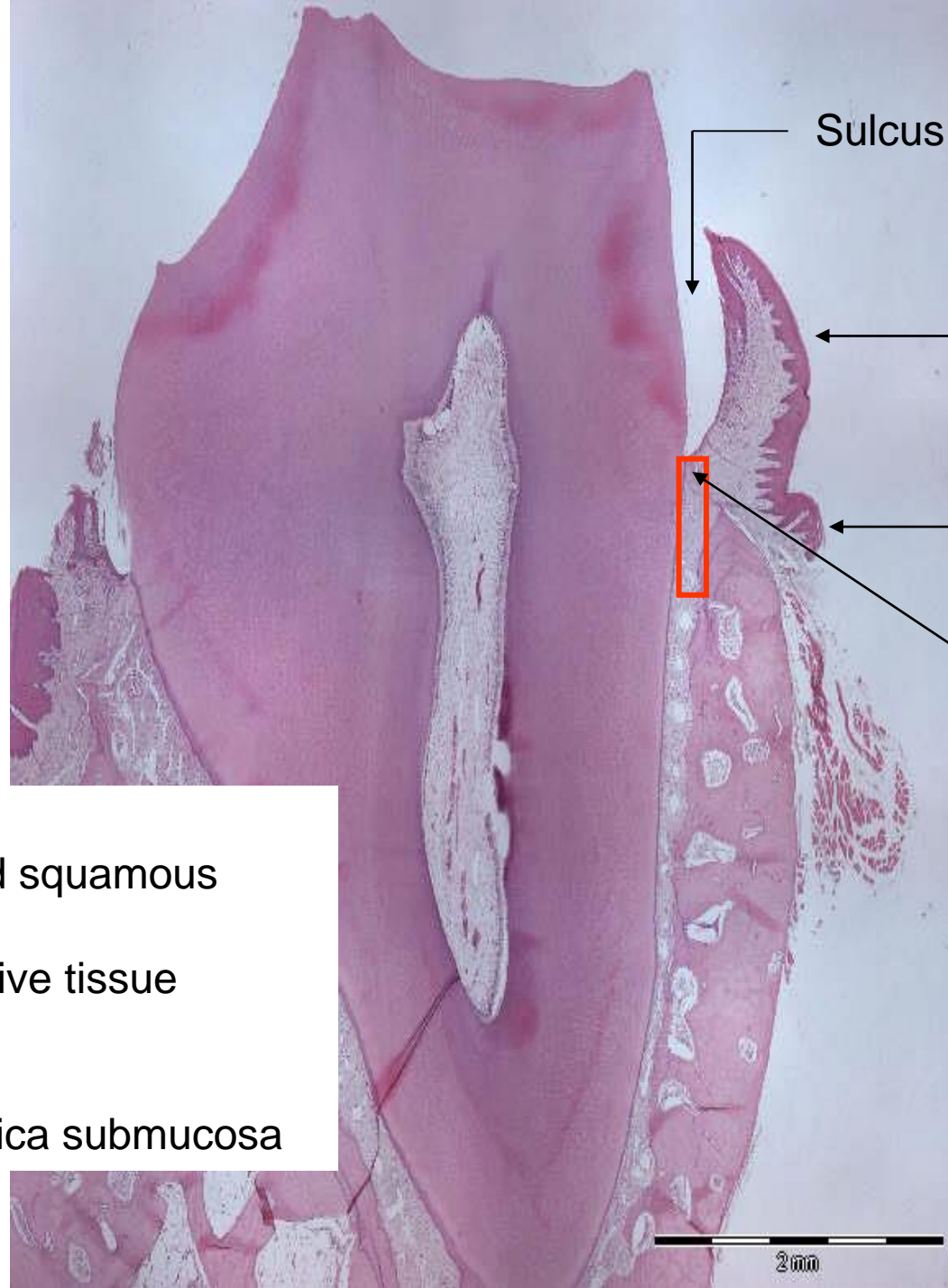

Sulcus gingivalis

Gingiva libera

Gingiva affixa

Epithelial attachment of Gottlieb
= epith. of gingiva is bound to the tooth enamel

GINGIVA

- Stratified squamous epith.
- Connective tissue papillae

NO!!! Tunica submucosa

2mm

Digestive system – I



Slides :

1. Labium oris (HE)
2. Apex linguae (HE)
3. Papilla circumvallata (HE)
5. Palatum molle (HE)
7. Tooth (HE)

Atlas:

Development of face (87)

Pharyngeal (branchial) apparatus. Development of tongue (88)

Development of the face, stomodeum and cervical region – embryo, day 24

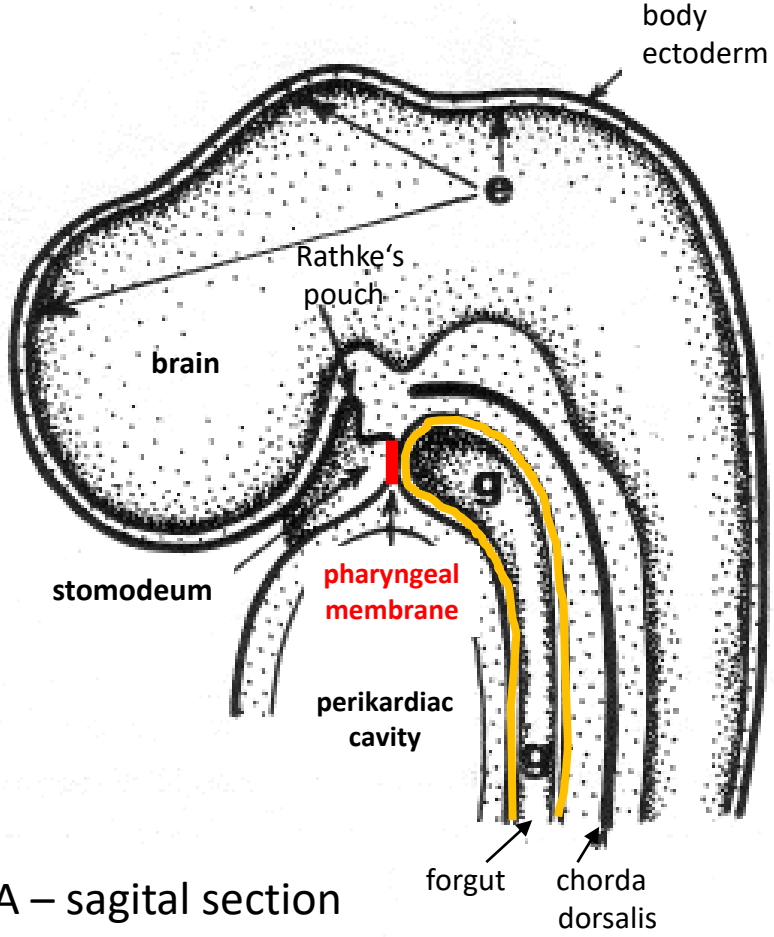

A – sagittal section

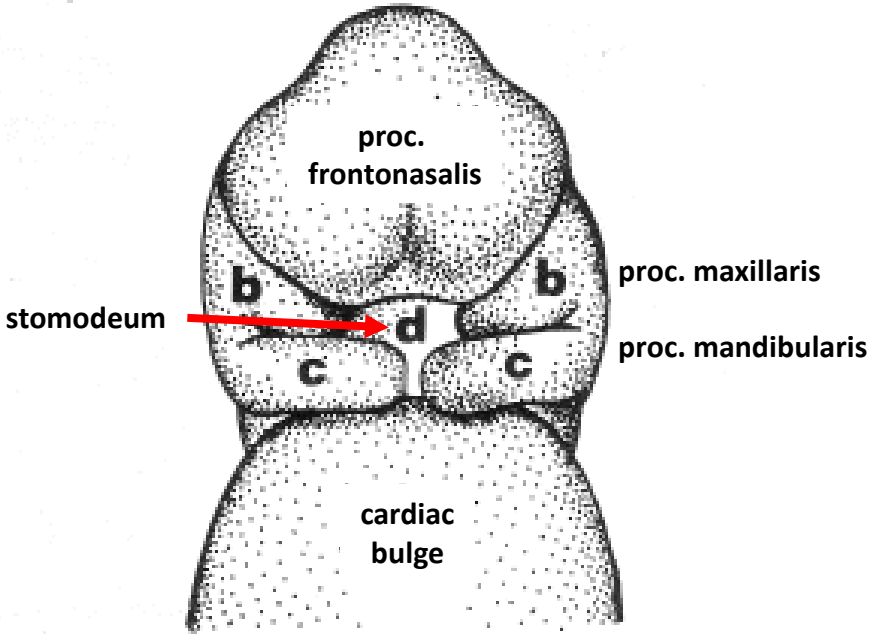

B – frontal view

Development of the face, stomodeum and cervical region – embryo, day 28

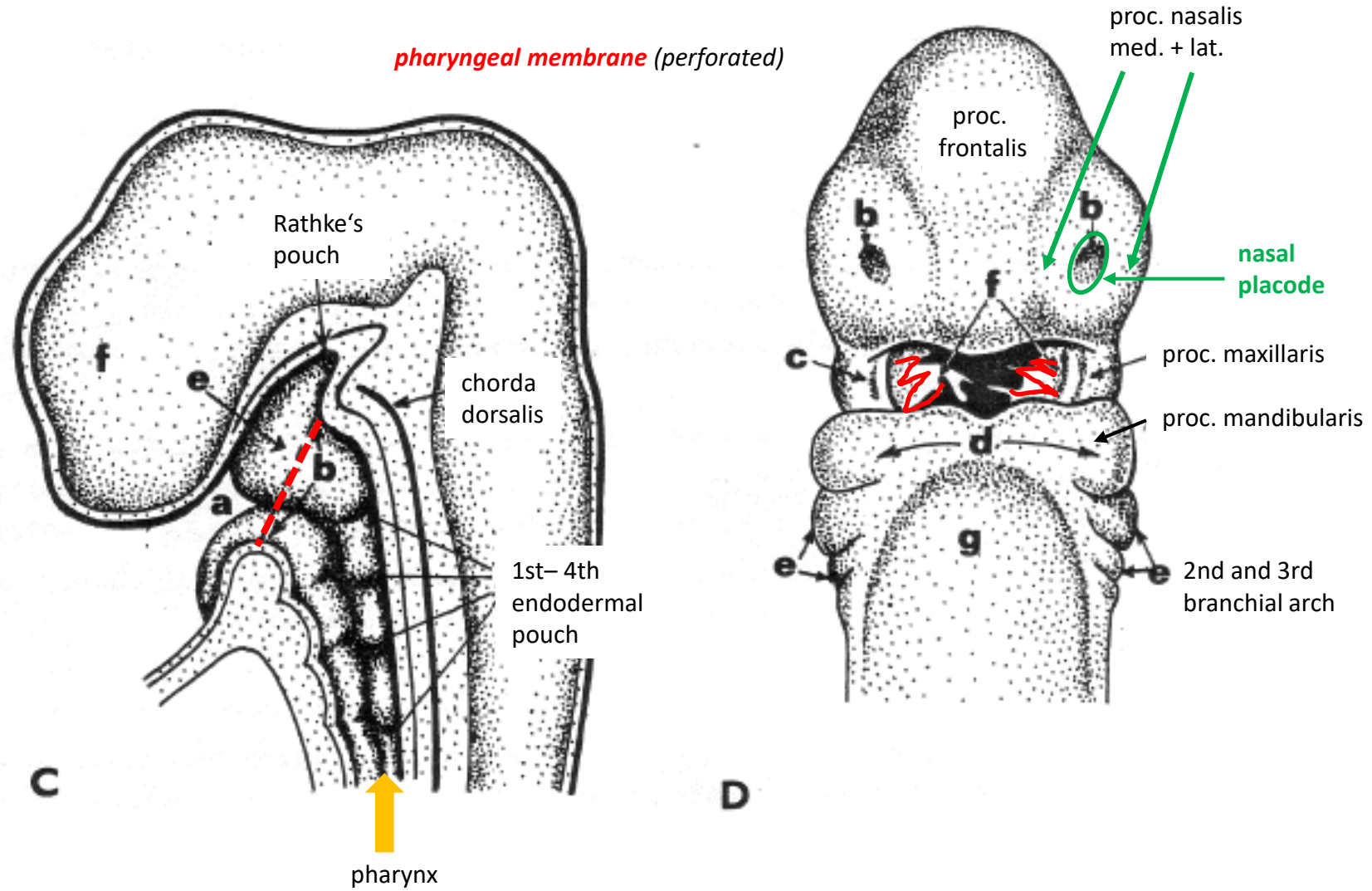

Development of the face – embryo , end of week 5

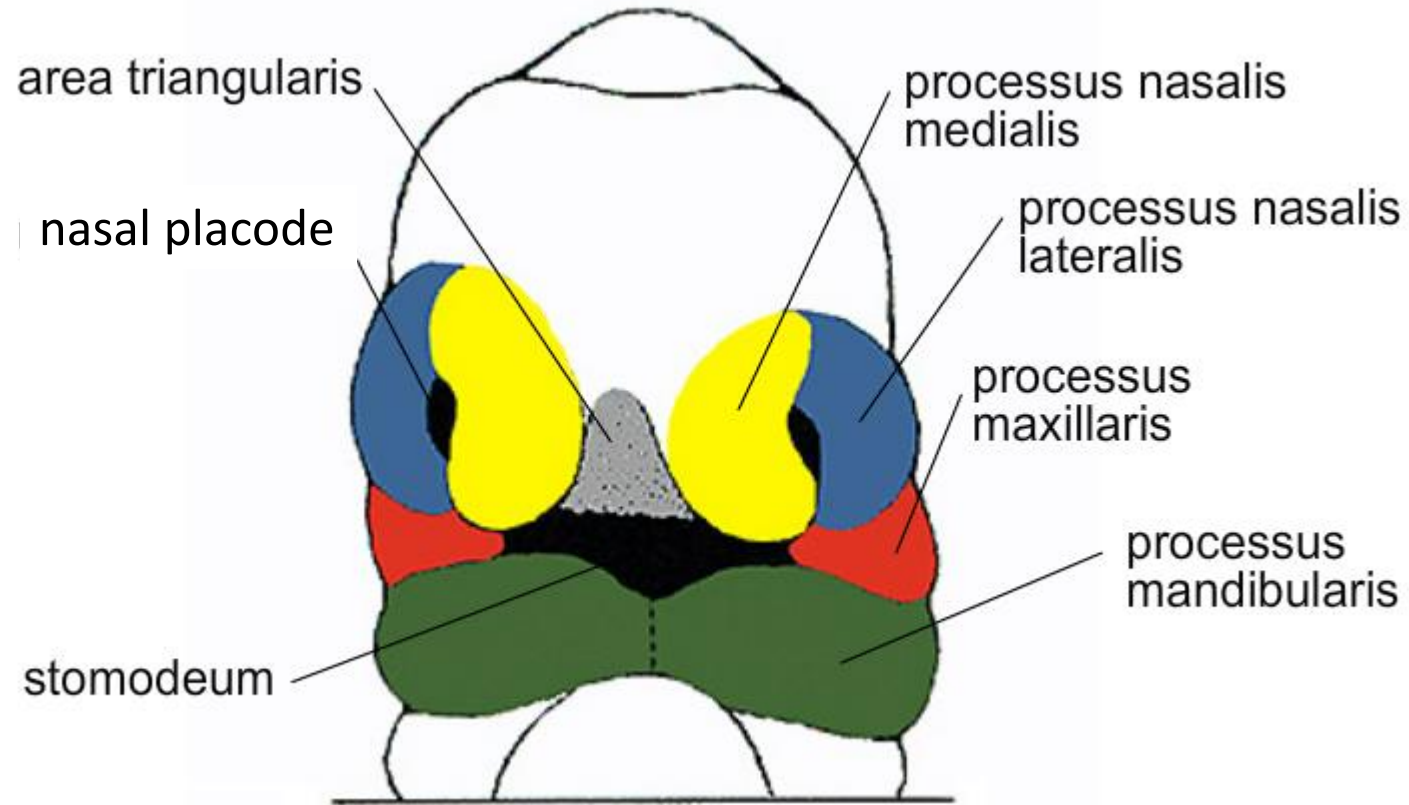
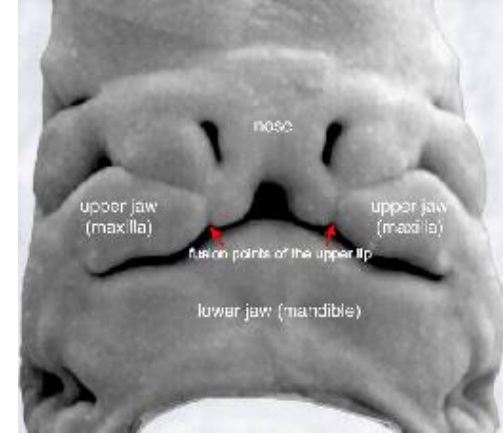

Development of pharyngeal (branchial) apparatus – embryo, week 6

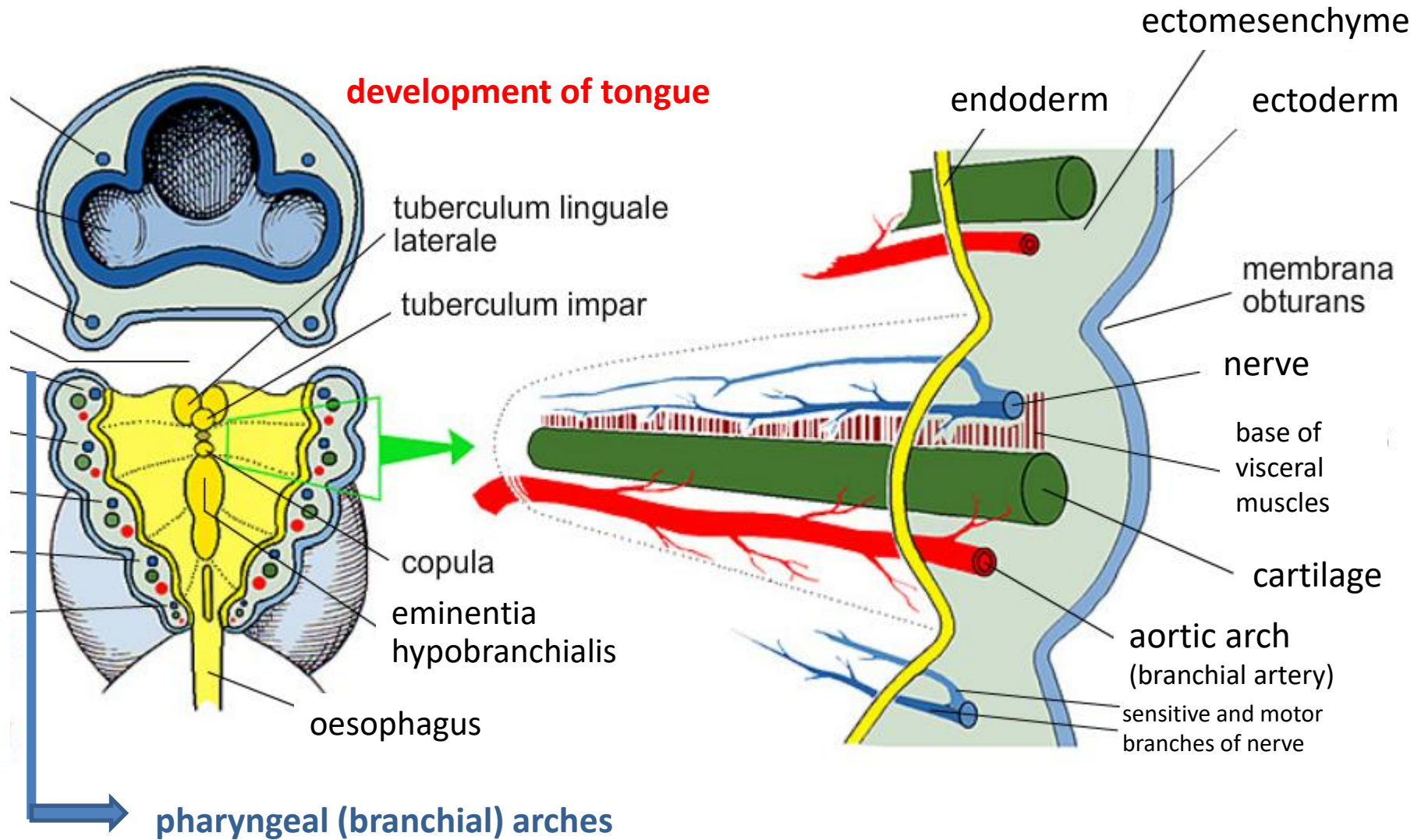

Development of tongue

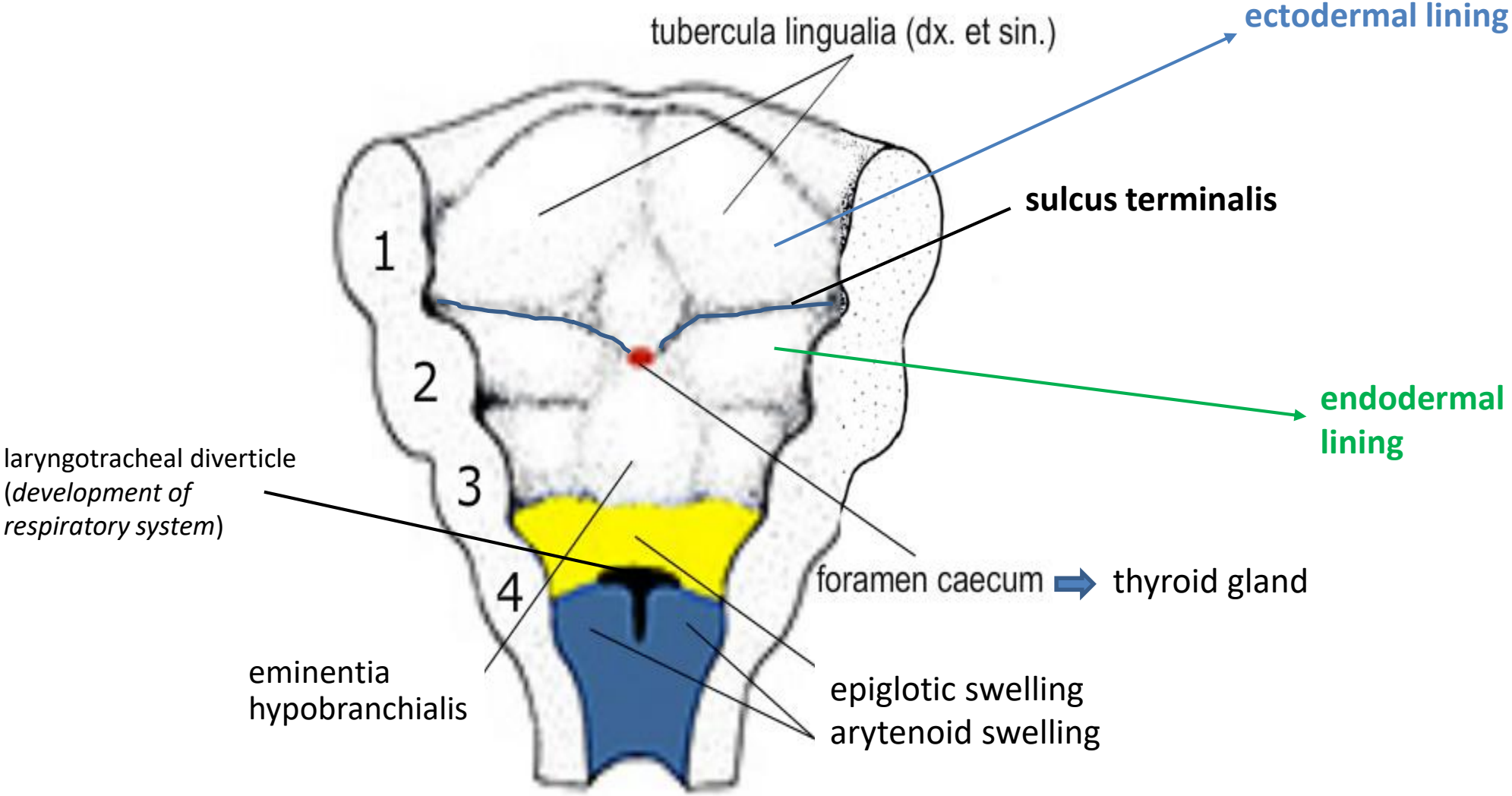

ECTODERMAL CLEFTS and **ENDODERMAL POUCHES** – embryo, week 5

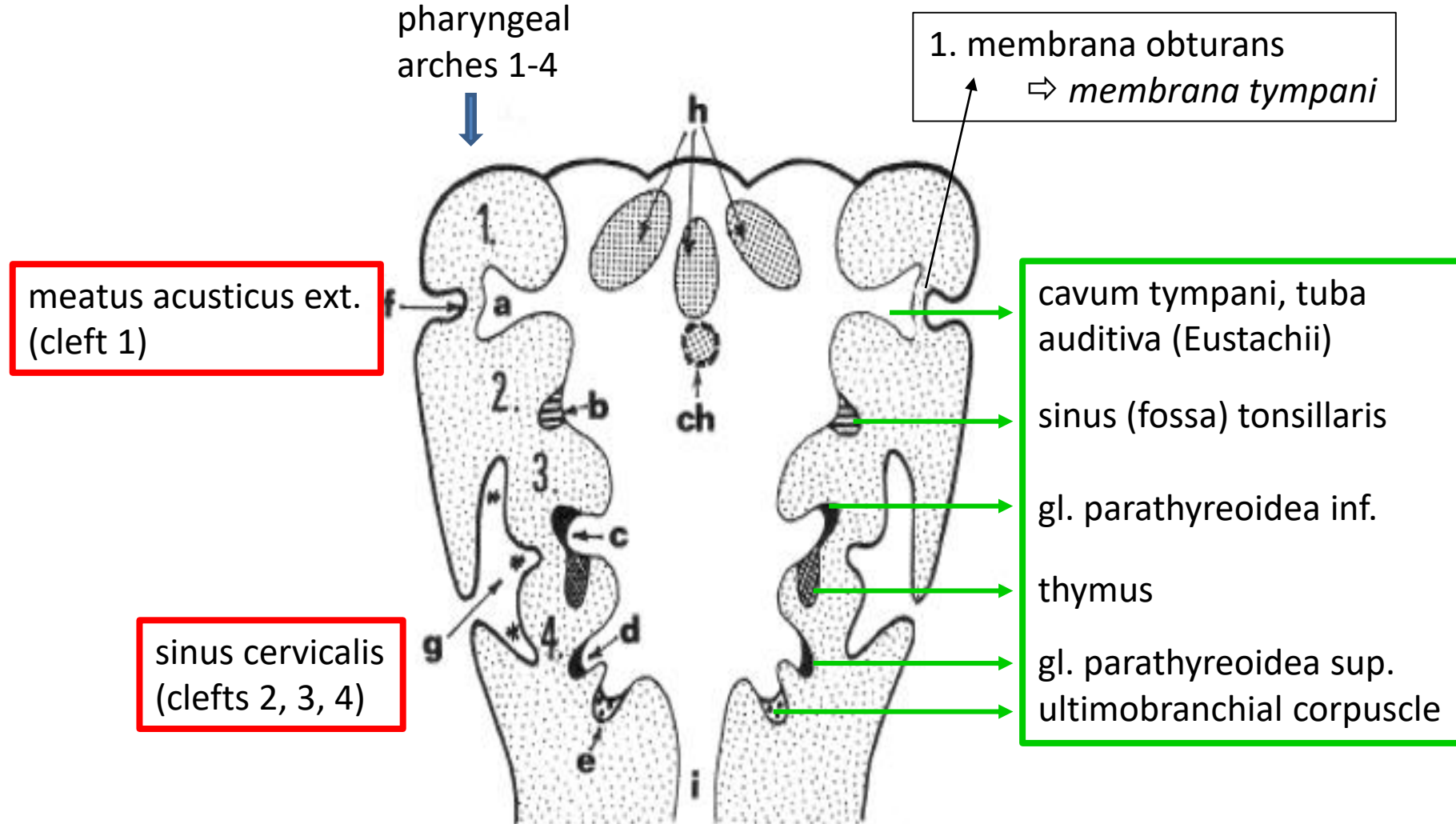

Descensus of thyroid gland and thymus with gl. parathyroideae inf. – embryo, week 6

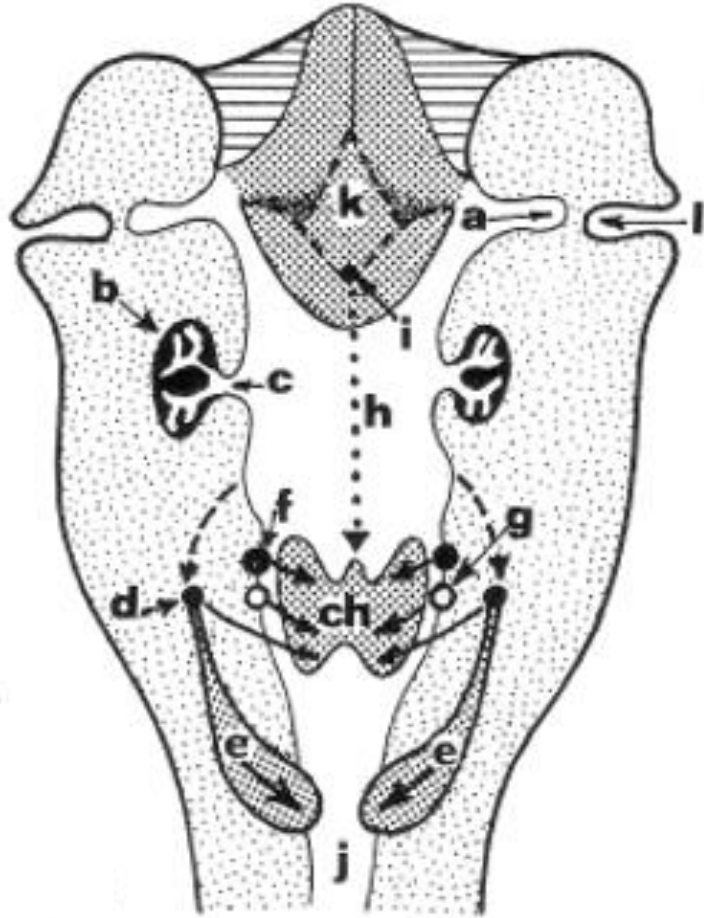

tongue (k),
foramen caecum (i),
ductus thyreoglossus (h),
gl. thyroidea(ch),
thymus (e),
gl. parathyroideae inf. (d),
gl. parathyroideae sup.(f),
ultimobranchial corpuscle (g)

Development of palate – embryo, A – week 7, B – week 8, C – week 10

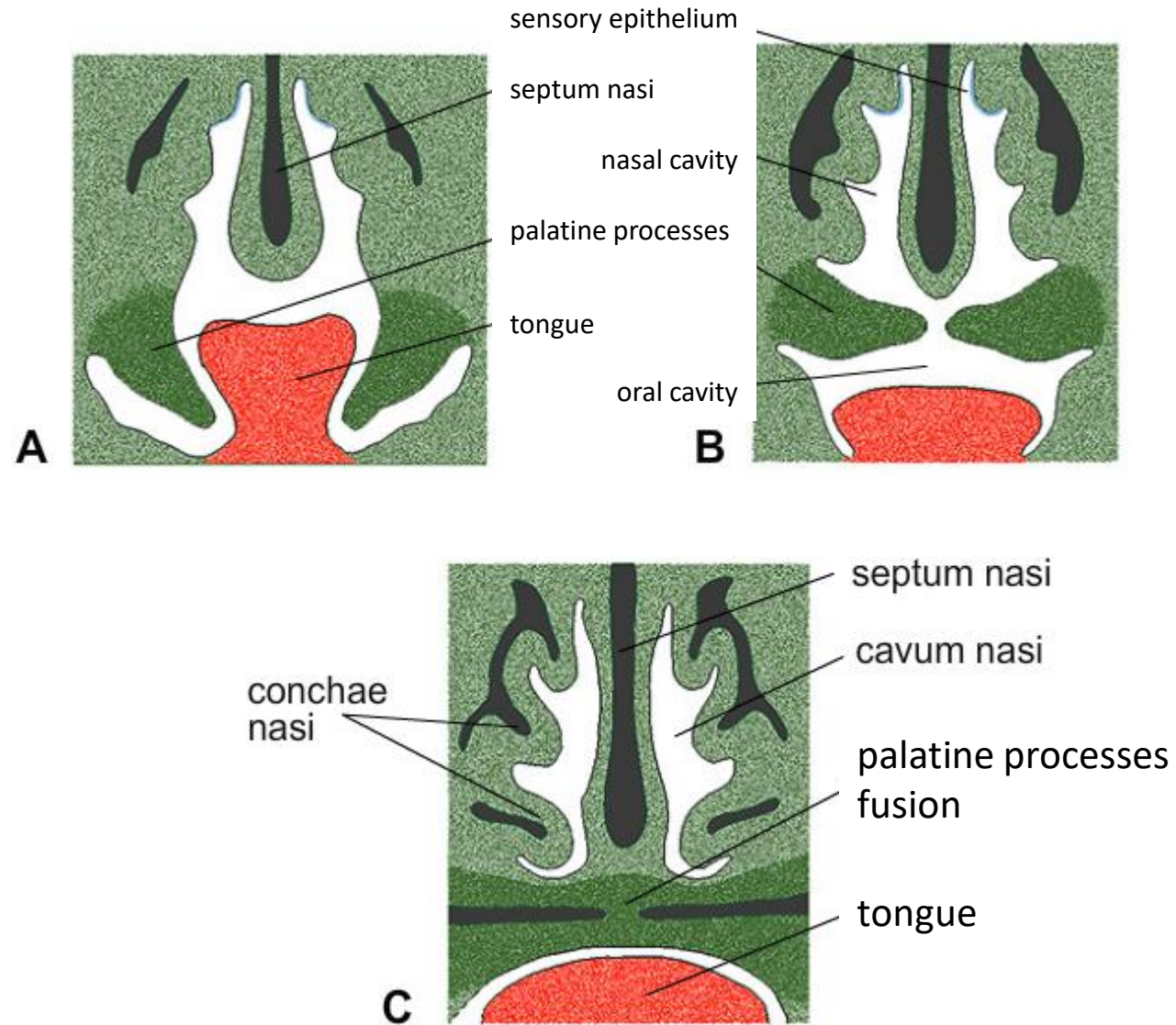

Development of the oral cavity and teeth – embryo, week 6

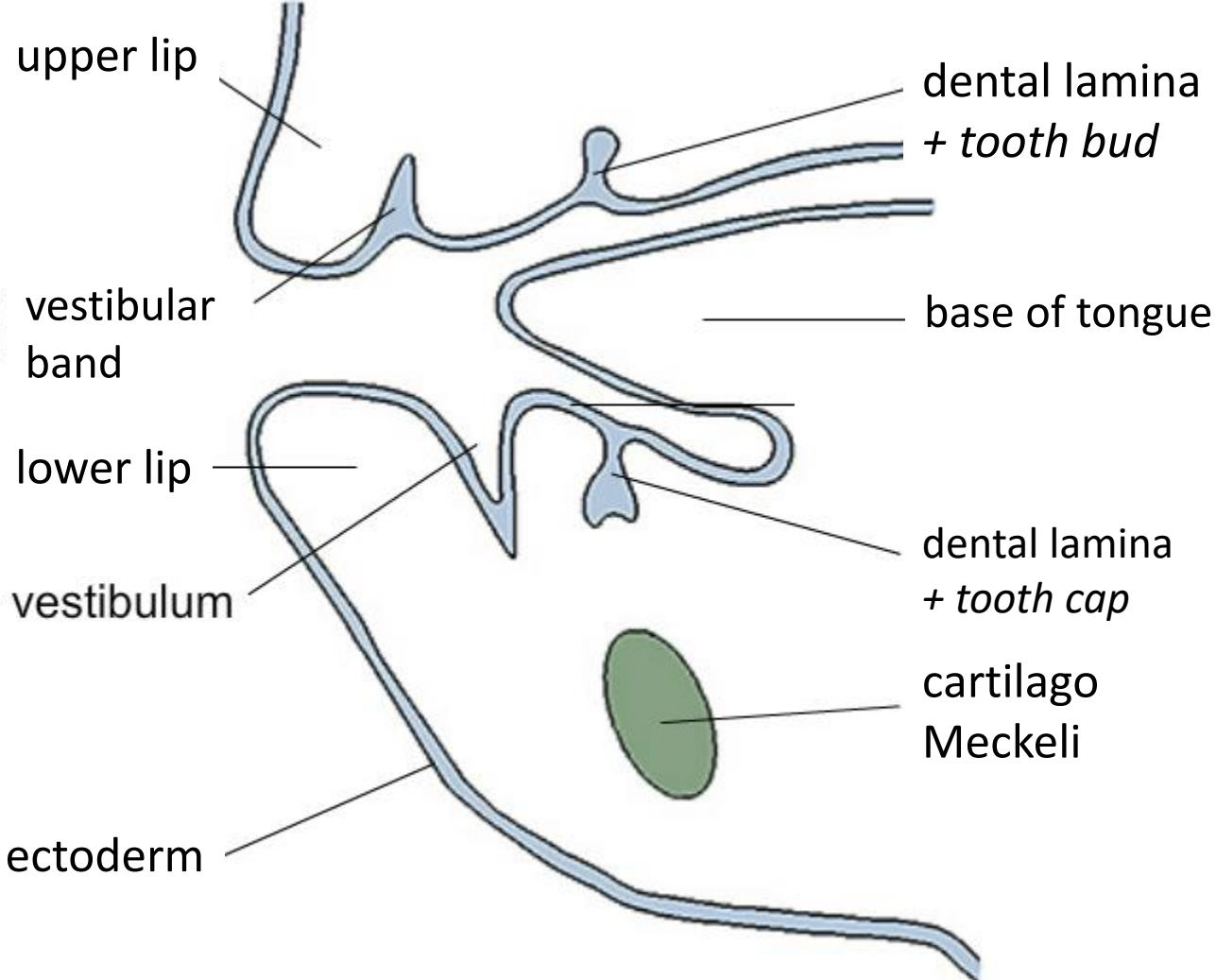

labium vestibulum dentogingival lamina

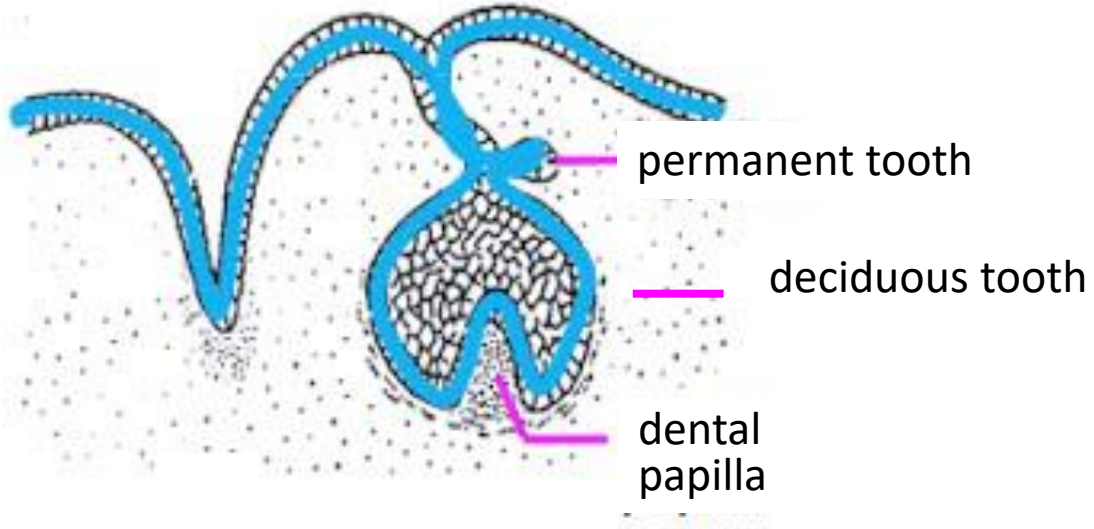
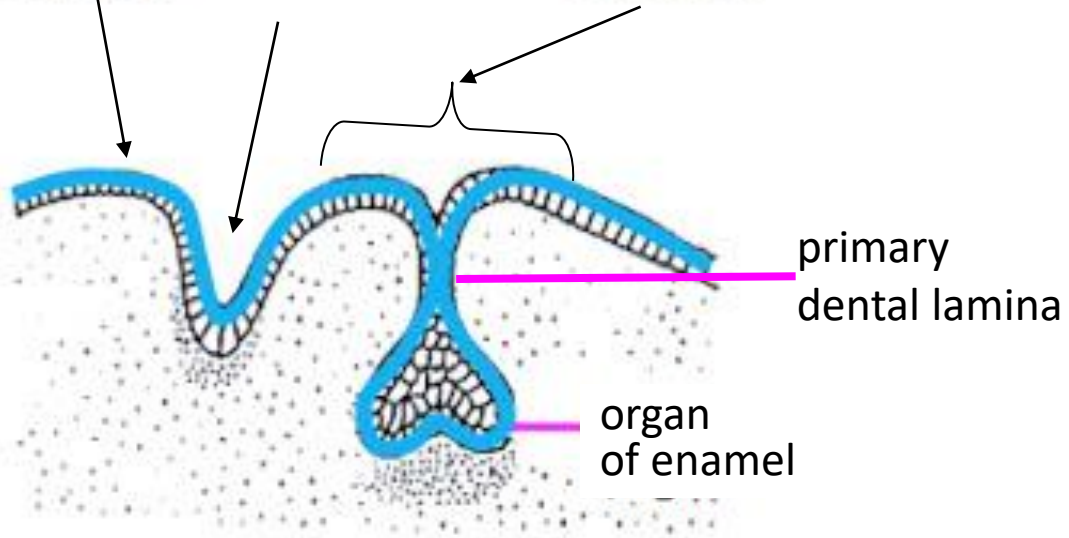

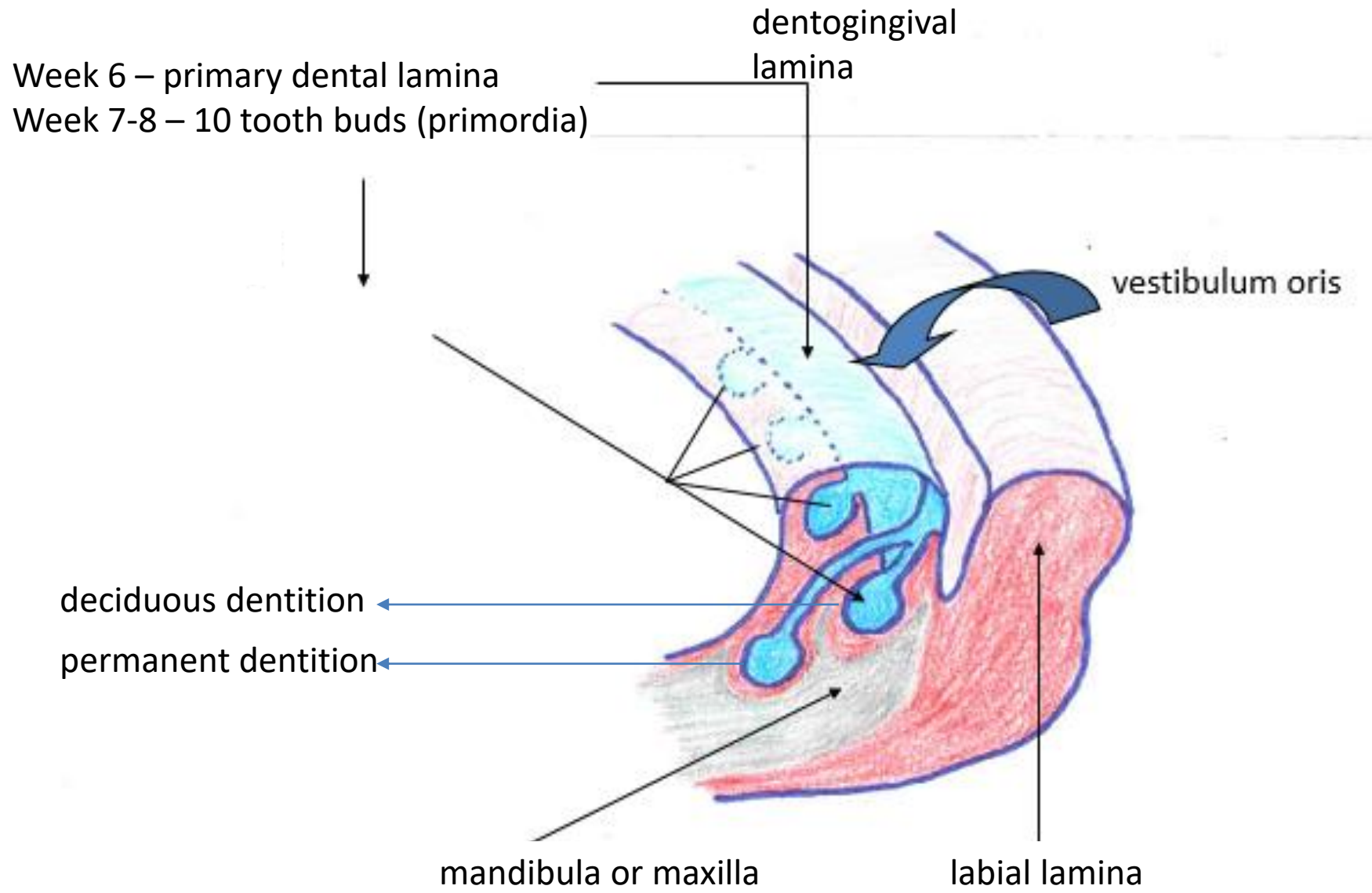

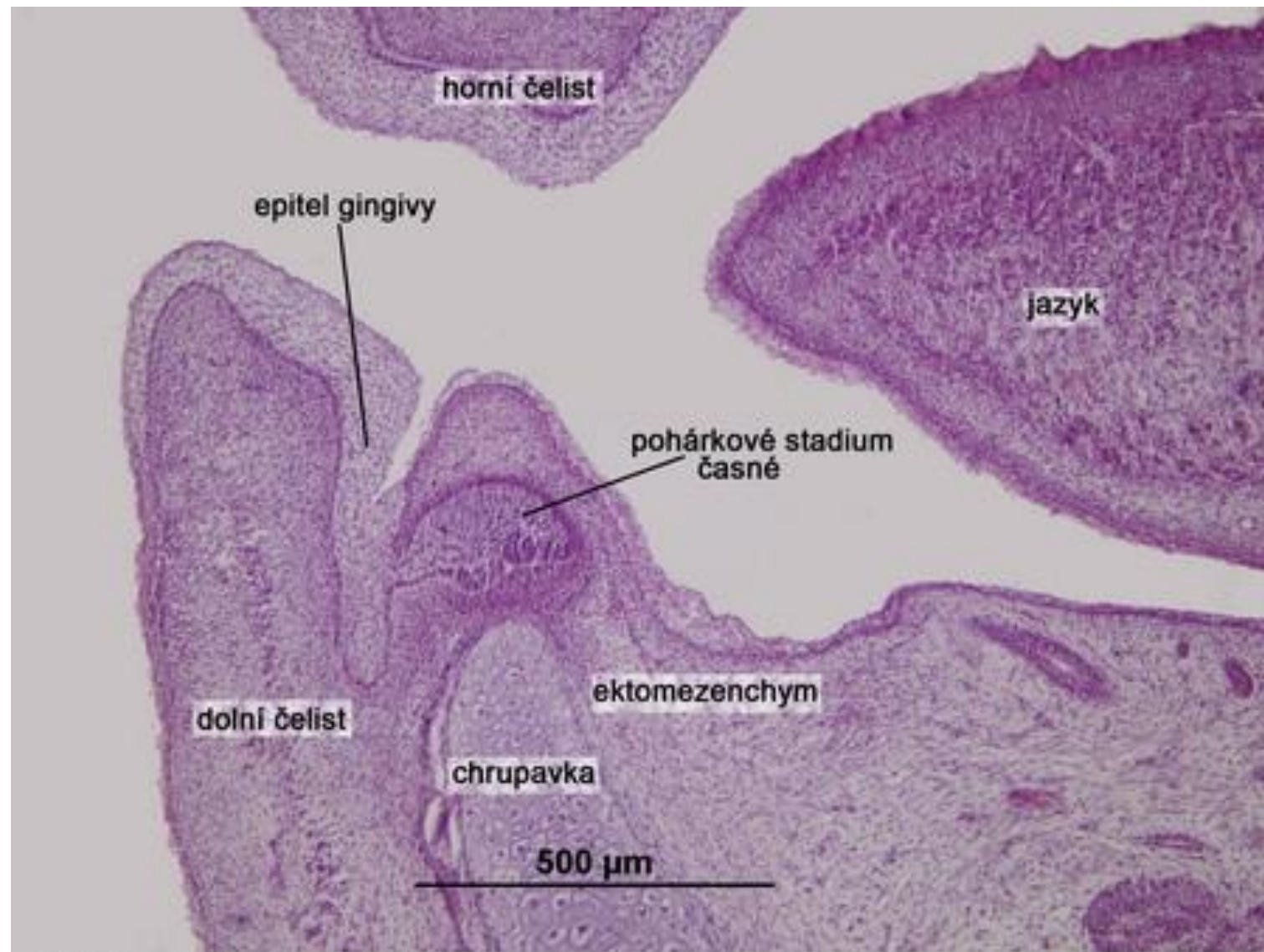

VÝVOJ ZUBU, barveno HE

Developmental stages of tooth

primary dental lamina

1. stage of dental bud (primordium)
2. stage of dental cap
3. stage of dental bell
4. stage of apposition
5. stage of eruption

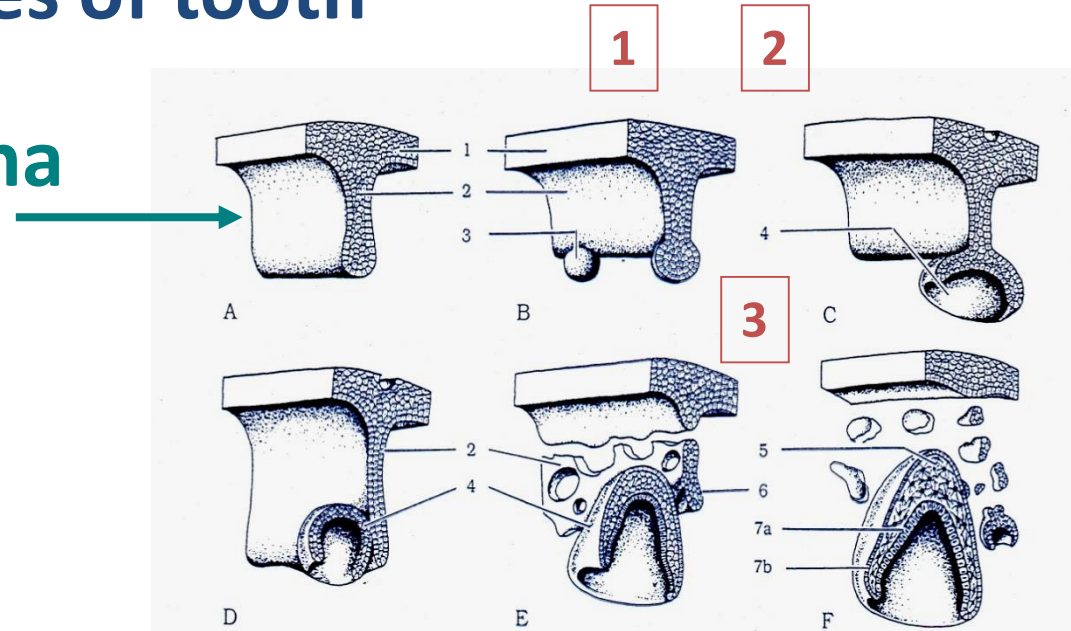

Obr. 13.12 Vývoj sklovinových orgánov zo zubnej lišty
Schematicky sú znázornené iba deriváty ektodermu: A - 6. týždeň, B - 7. týždeň, C - 8. týždeň, D - 10. týždeň, E - 14. týždeň, F - 18. týždeň vývoja: 1 - ektodermálny epitel ústnej dutiny, 2 - zubná lišta, 3 - epitelový uzlík, 4 - sklovinový orgán, 5 - sklovinová pulpa, 6 - základ trvalého zuba, 7a - vnútorné ameloblasty, 7b - vonkajšie ameloblasty

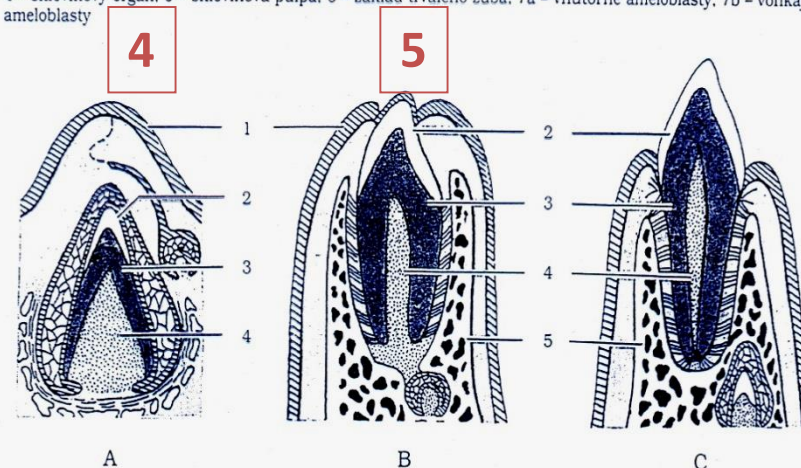

Obr. 13.13 Schematické znázornenie vývoja zuba (podľa Moorea, 1980)
A - 28. týždeň vývoja, B - asi 6. mesiac po narodení, C - prerezanie zuba po 6. mesiaci veku dieťaťa: 1 - epitel ústnej dutiny, 2 - email (biela), 3 - dentín (tmavosivá), 4 - zubná papila (pulpa), 5 - kosť zubnej alveoly (bielo-čierna)