

Lectures on Medical Biophysics

Endoscopes, tissue ablation devices and lithotripters

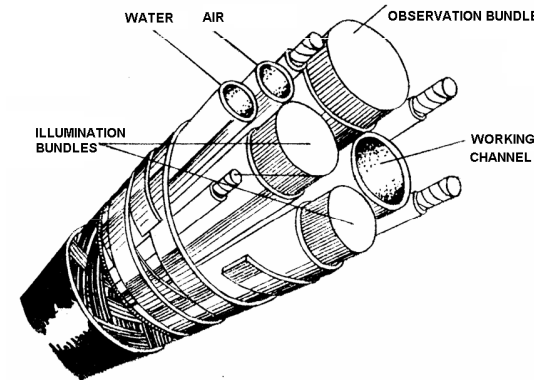

Lecture content

This lecture deals with the following biomedical devices:

- Endoscopes
- Lasers
- Electrosurgery devices
- Ultrasonic surgery devices
- Cryosurgery devices
- Water jet surgery devices
- Plasma scalpel
- Lithotripters

Keep in mind that endoscopes are often equipped with surgical tools including lasers (for tissue ablation). Lithotripsy is a minimally invasive method for removal of kidney stones and gallstones (helps avoid major surgery).

Endoscopy

- **Endoscopes** are devices for the visual examination of body cavities. They are based on the reflection and refraction of light.
- They are inserted into the body cavity to be examined either through natural body openings (nasal and pharyngeal cavity, larynx, airways, urethra, uterus, rectum) or surgical incisions (abdomen, thorax, joints).
- Endoscopes can be categorized according to their complexity, method of illumination and method of observation.
- There are groups of endoscopes with different complexity:
 - Endoscopic mirrors
 - Endoscopes with rigid tubes
 - Fiberscopes and videoendoscopes
 - Endoscopic capsules
- Endoscopes are used also for minor surgery as they can be equipped with small surgical tools.

Way of illumination and observation

- Lighting can be:
 - **Internal:** source of light is part of the device
 - **External:** examined cavity is illuminated by an external source (Endoscopic mirrors are typical representatives of the second group).
- In endoscopes with internal lighting, the source is directly inside the body cavity (*distal lighting*) or outside the cavity (light is guided into the cavity by an optical system, *proximal lighting*).
- The observation of the body cavity can be:
 - **direct** when the physician uses his/her own eyes aided by an optical system
 - **indirect** when the images are taken by a digital video camera and observed on a monitor

Endoscopic mirrors (specula)

- **Laryngoscope.** Spoon-like mirror used for the examination of the larynx and posterior part of the nasal cavity.
- **Otoscope.** Funnel-like endoscope inserted into the auditory meatus to examine its distal part and the ear drum.
- **Rhinoscope.** Pliers-like instrument with concave reflecting jaws – examination of anterior part of nasal cavity.
- **Ophthalmoscopic mirror.** Planar or concave mirror with an central orifice. It serves for induction of the so called red reflex – reflection of light from the retina.
- Retina is examined by direct ophthalmoscopy – an **ophthalmoscope**, a small see-through endoscope with light source and correction of the doctor's visual handicap.
- **Vaginal speculum** (colposcope). Pliers-like instrument with concave reflecting jaws – examination of vagina and cervix.

Endoscopic mirrors



Rhino-
scope

laryngoscope

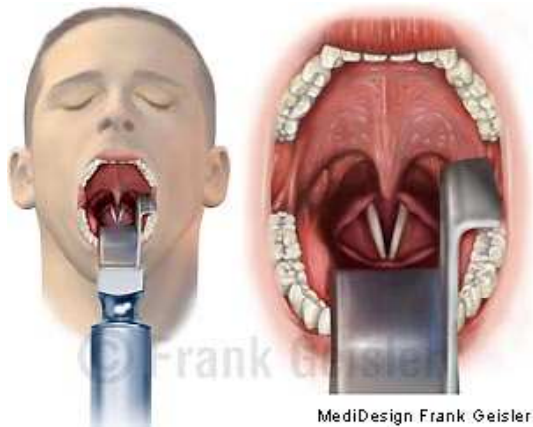

Magnifying glass viewing lens slides left or right for quick instrumentation.

Insufflator port creates closed system for pneumatic otoscopy to assess middle ear disorders. Apply positive and negative air pressure to view tympanic membrane. Flush-mounted for durability.

Choice of specula: Reusable and disposable KleenSpec® specula or comfortable SofSpec® specula for a snug fit and optimal seal.

Lightweight, durable material: High impact ABS construction is more resilient, offers unmatched durability.

Throat illuminator provides light in a handy built-in penlight.

Fiber optics transmit light through a 360-degree bundle of optical fibers for accurate, shadow-free exams. The fiber optics extend to the tip of the instrument for more light output, less glare and easier cleaning.

Our Halogen HPX lamp system is the newest innovation in lighting technology today. The lamp uses a high pressure mixture of halogen and xenon gases to provide 30% more light output than before.

otoscope

Endoscopic mirrors



vaginal speculum

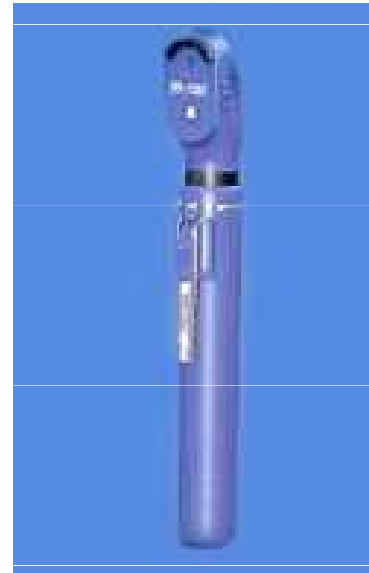

ophthalmoscope

Rigid tube endoscopes

- Rigid metallic tubes with optical system and built-in light source (proximal or distal). Disadvantages: relatively high light loss and the rigidity of tubes. The first gastroscopic examination was done by Adolf Kussmaul in 1868.
- **Cystoscope** – urinary bladder
- **Rectoscope** – rectum and sigmoid colon
- Endoscopes inserted surgically:
 - **Laparoscope** – abdominal cavity.
 - **Arthroscope** – joints (namely knee joint).

Rigid tube endoscope

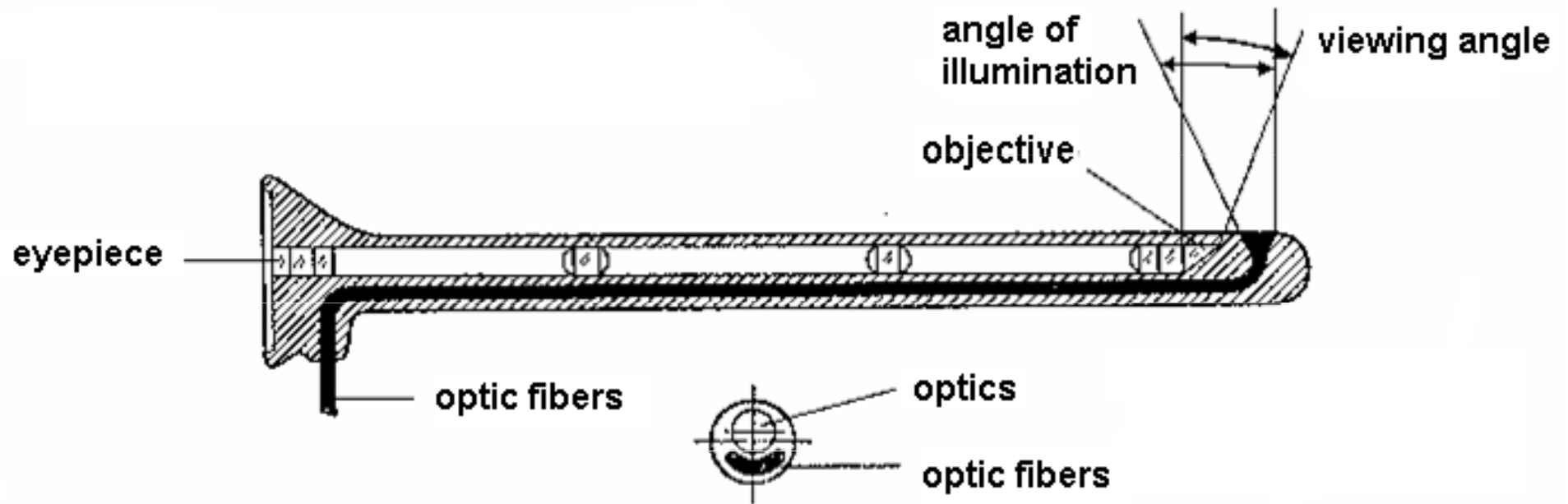

Rigid tube endoscope

rectoscope



cystoscope

M U N I

Fiberscopes

- trachea and bronchi (bronchoscopy)
- oesophageal mucosa (Oesophagoscopy)
- gastric mucosa (Gastroscope)
- colon (colonoscopy)

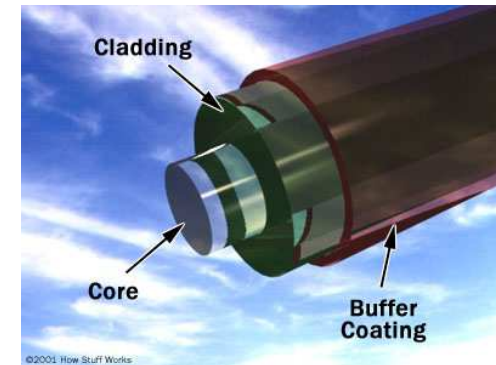

Fibre optics, total reflection, critical angle.

The lowest light loss is typical for two-layer optical fibres made of glass or plastics. The core has higher index of refraction n_1 than the coating n_2 . Total reflection occurs when $\sin \alpha < (n_1^2 - n_2^2)^{1/2}$. The fibres form bundles serving for illumination and image transfer.

In the image transferring bundle, the fibres are arranged in the same way both on input and the output of the bundle. Light signal loss: 0,001 - 0,005 dB per 1 m of length.

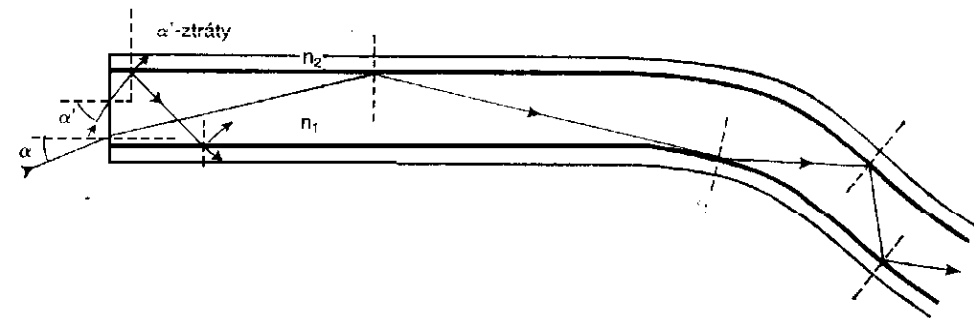

Fiberscopes

- The fiberscopes make possible to take tissue samples and to make minor surgery. They are flexible so we can examine body parts which are not accessible by rigid endoscopes. Length 130 - 140 cm.
- Inside the flexible cable we can see:
 - 3 bundles of optical fibres (2 for illumination, 1 for image transfer),
 - a tube for air or water,
 - a channel for insertion of surgical tools and
 - control drawbars enabling movement of the distal end with **objective** giving a sharp image from the distance of 3 - 100 mm.
- The proximal end is equipped by an **eyepiece** mounted in the rigid part of the tube. There is also the control device for distal end movement.
- A powerful source of light, air and water pump and vacuum pump are also parts of the device.

Fiberscopes

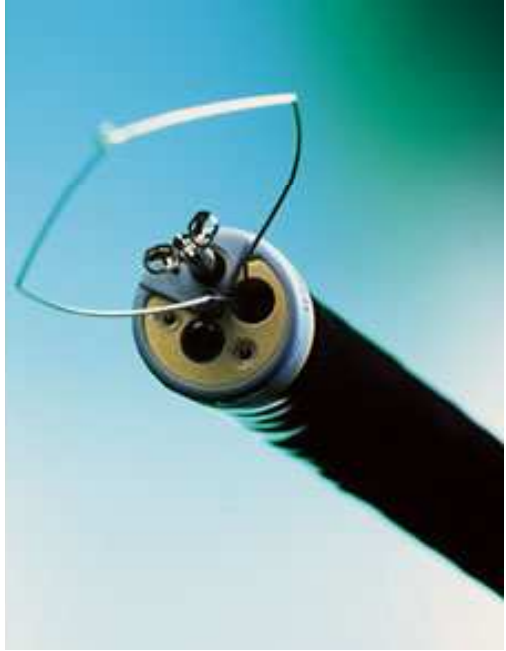
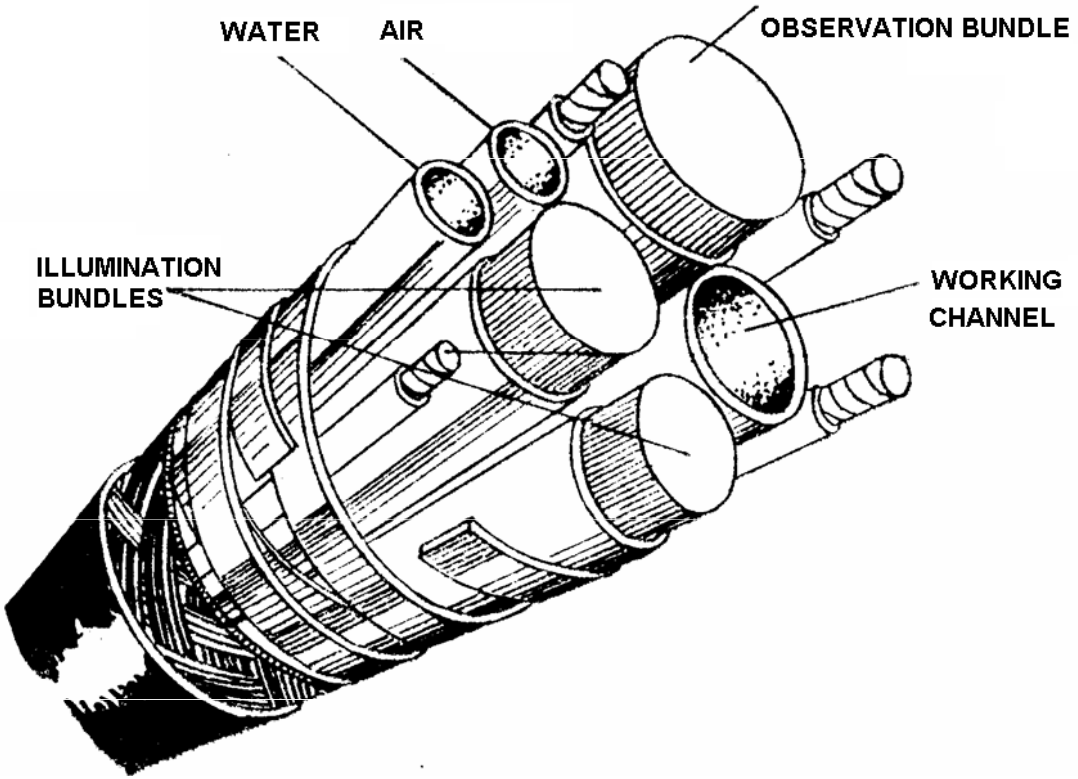

Frontal part of the colonoscope -
www.endoscopy.ru/diler/pentaxvideo.html.

Fiberscopes

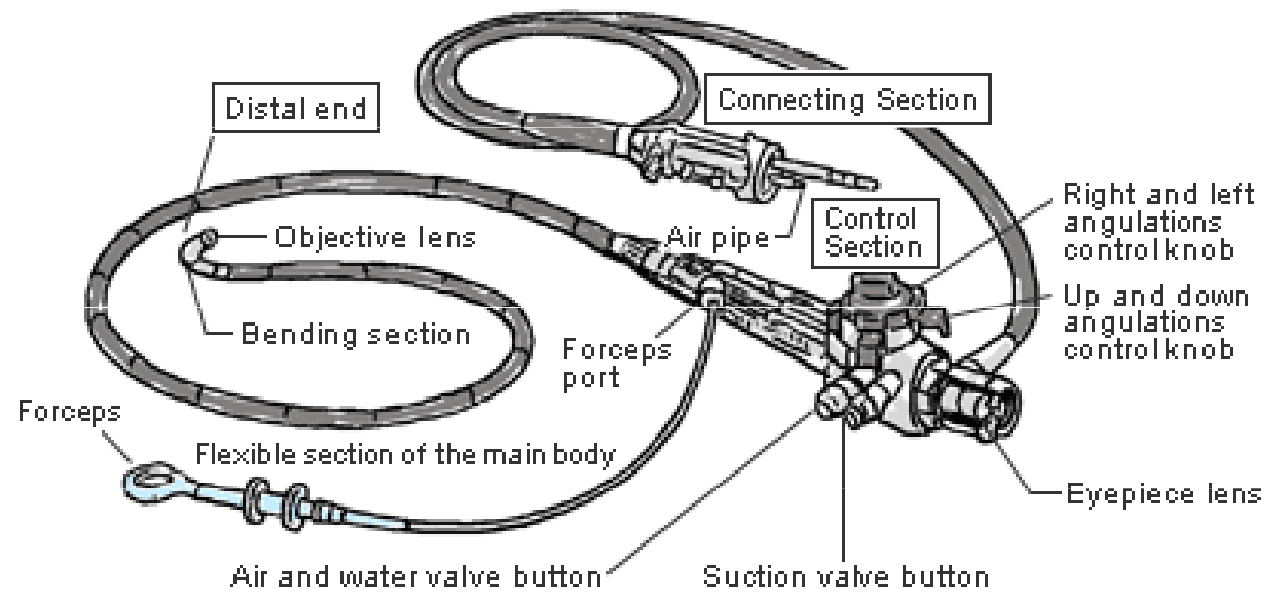

MUNI

Video-endoscopy

Videoendoscopy –
modern endoscopes with a
video camera. The image
is shown on a monitor.



<http://www.bethesda.de/kliniken/medizinische-klinik-ii---gastroenterologie/endoskopien-spiegelungen/index.php>

MUNI

Endoscopic capsule

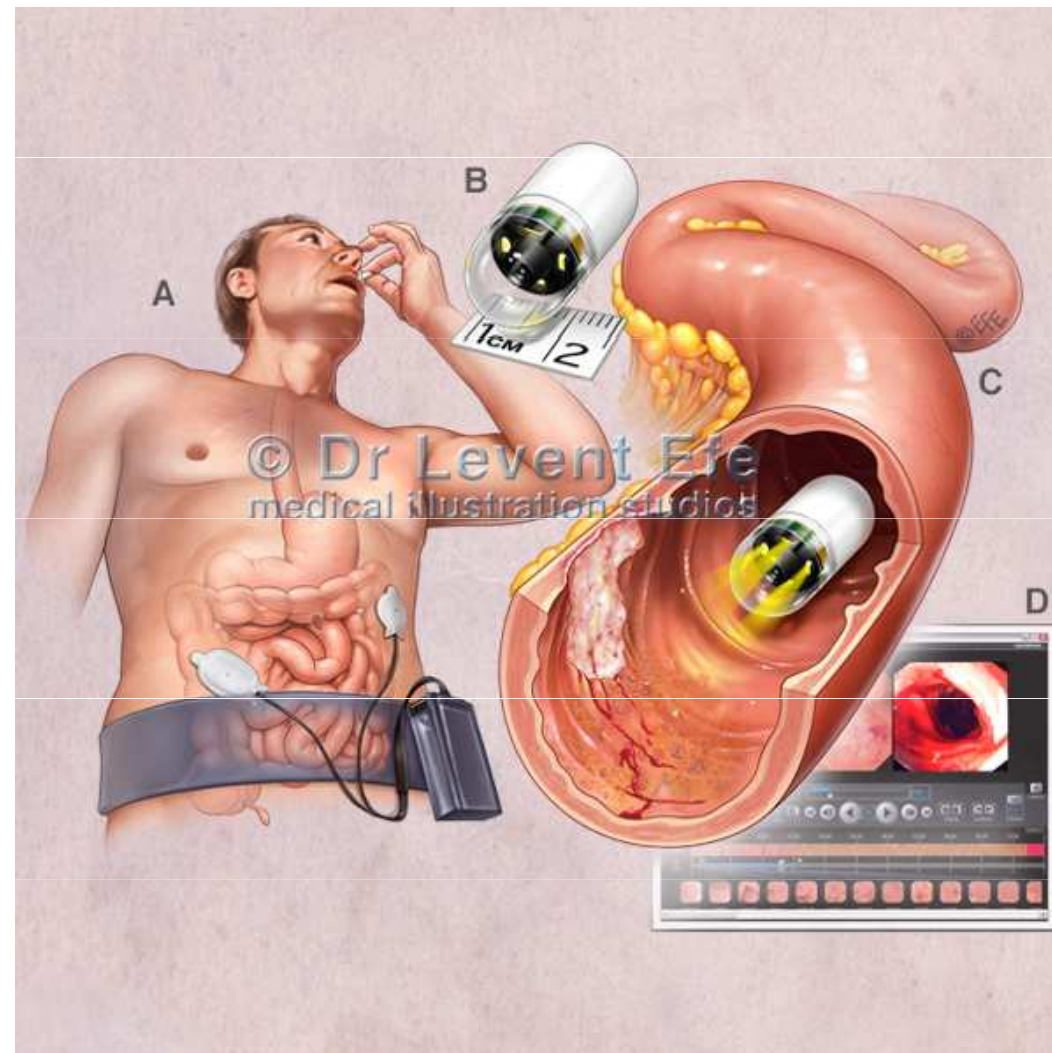

Laser

- *Light Amplification by Stimulated Emission of Radiation.*
- The first ruby laser was constructed by T.H. Maimann in 1960. Main parts of a laser:
 - **active medium**
 - **optical resonator**
 - **source of excitation energy**
- Principle of the laser: alternating excitation and deexcitation.
 - Electrons of the atoms of the active medium are **excited** (brought to a higher energy level) by the source energy („optical pumping“).
 - Thereafter they are **deexcited** by a stimulating photon, new photons of the same energy arise and the effect is repeated – amplification occurs.
 - In the so-called three-level laser, the third energy level is broad, thus it is not necessary to use monochromatic (i.e. monoenergetic) light for optical pumping. Because of small energy difference between the second and third energy level, the electron transition to the second energy level is spontaneous („thermal“) – electrons are waiting for the stimulating photon there.

Three-level laser

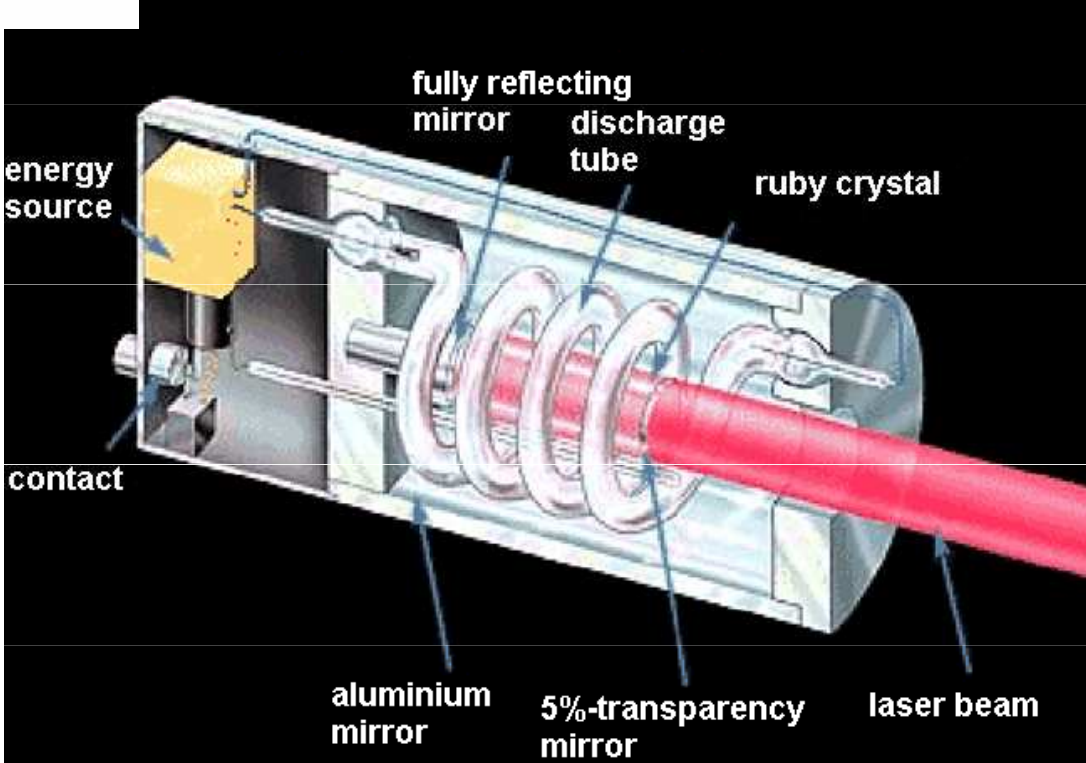
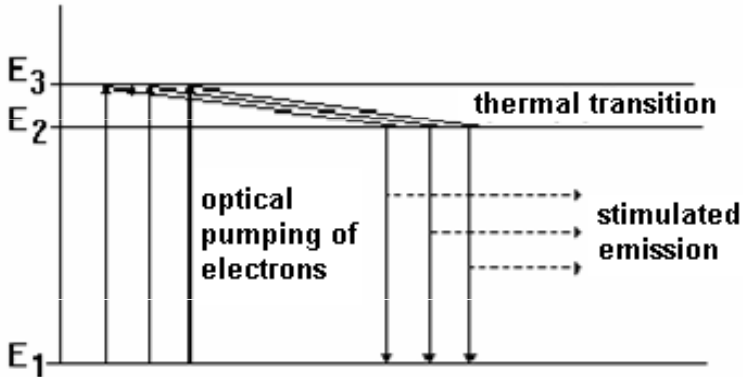

Scheme of the 1st ruby laser

<http://www.llnl.gov/nif/library/aboutlasers/Ruby%20cutaway.GIF>

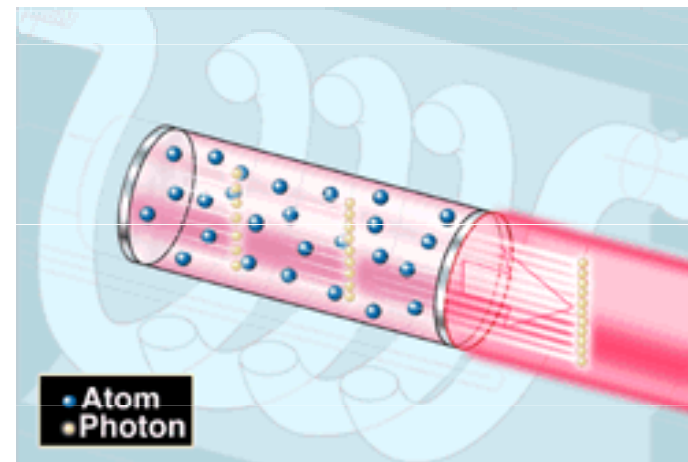
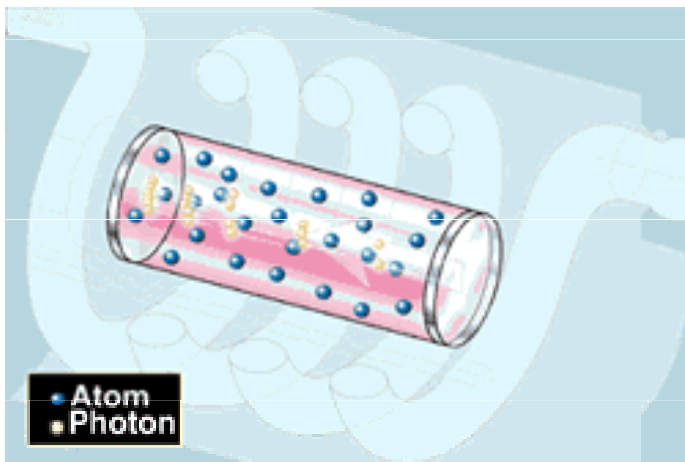
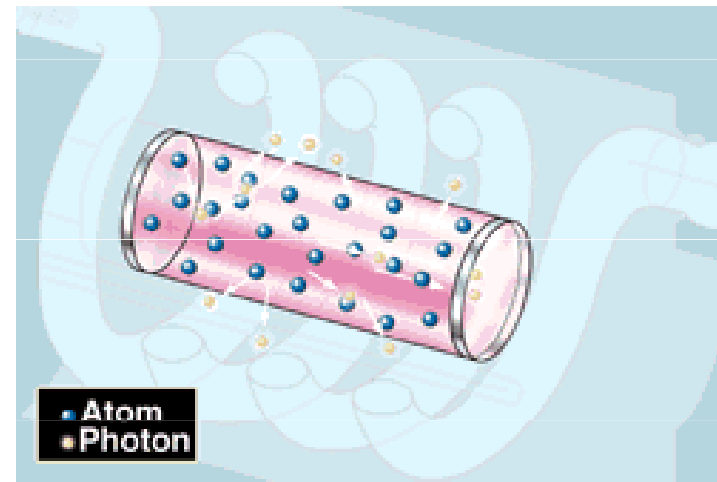
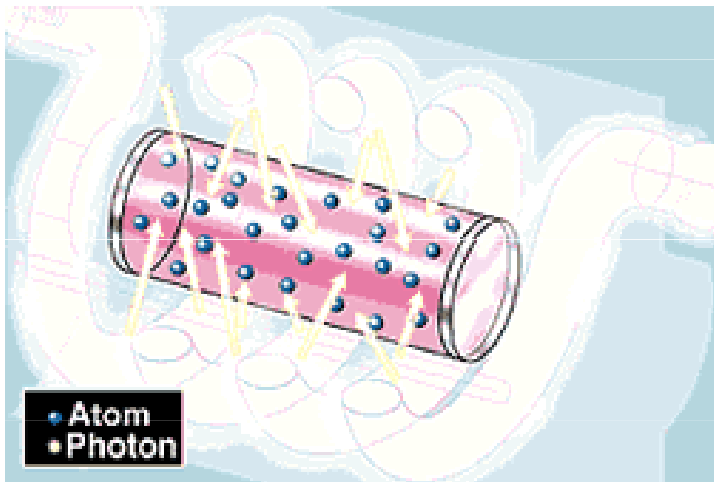

Lasers

- **Solid I.** (compact, semiconductor): ruby laser (694.3 nm), neodymium (1.06 μm),
- **Semiconductor I.** – based on the principle of electroluminescence.
- **Liquid I.** An organic dye solution is used as active medium. Advantage: can be tuned to different wavelengths (from near IR, VIS to UV range).
- **Gaseous I..** Important for medicine. Helium-neon laser (1.06 μm) and ion lasers (argon and krypton). CO₂-N₂-He-laser etc.
- **Plasma I.** Active medium is plasma, fully ionised carbon – irradiates soft X-rays.
- Lasers can operate in two modes: **continuous** and **pulsed**
- Laser power ranges from 10^{-3} to 10^4 W. Low-power lasers (soft-lasers) are used mainly in physical therapy. High-power lasers are used as surgical tools (laser scalpel).

Effects of laser radiation

- Laser light is **monochromatic** and **coherent**. This allows us to concentrate the laser beam on a small area and to reach a high output density, that makes this surgical instrument useful even in microsurgery. The laser beam can be guided by mirrors, lenses, or optical fibres. Photons are absorbed in the surface layers of tissues.
- **Thermal effects** depend on the power density of light and its wavelength. They are exploited mainly in surgery and microsurgery. **Non-thermal effects** are typical for soft-lasers, they depend little on the wavelength – based perhaps on a molecular action mechanism (action on enzymes of the respiratory chain, enhancement of mitochondrial DNA replication, enhancement of enzyme activity). Membrane potentials are also affected, possibly due to changes in membrane permeability for Na^+ , K^+ and Ca^{++} ions.
- Laser light also has a **photodynamic effect** – chemical changes of inactive substances irradiated by laser light of certain wavelength can lead to formation of biologically active (cytotoxic) derivatives.

Laser therapy – Safety



- In **non-invasive phototherapy**, powers below 500 mW are used. Classes of lasers used are:
 - II (power up to 1 mW),
 - IIIa (power up to 5 mW)
 - IIIb (power up to 500 mW).
- Surgery: Power lasers IV are used
- **Safety:**
 - Labels placed on lasers must state class,
 - from IIIb also warning on eye damage by focussed beam
 - Medical staff as well as the patient must wear goggles absorbing laser light of given wavelength.

Soft-laser therapy

- Surface applications – short wavelength, deep applications – long wavelength (near IR).
- *laser pens* are the simplest devices, based on laser diodes, fed by batteries, constant power setting.
- **Small lasers** (pocket) with exchangeable probe, different frequency modes are possible.
- **Tabletop lasers** – user comfort, many functions and applications.



Laser pen



Table-top soft-laser

MUNI

Soft-laser therapy

- **Analgesic effect:** increase of O₂ partial pressure, increase of resting potential → lowering of its excitability.
- **Anti-inflammatory effect** should be caused by activation of monocytes and macrophages, increased phagocytosis, increased proliferation of lymphocytes.
- **Biostimulating effect:** referred increased synthesis of collagen, better blood supply, faster regeneration of some tissues.
- Indications: laryngology, dentistry, orthopaedics and gynaecology.
Seldom used as monotherapy.
- Opinion of biophysicists: mostly **placebo** effect, specific action is supported by little research evidence.



?

Surgical laser unit

High-power laser application

General surgery:

A laser can serve as an optical lancet cutting without contact. The blood vessels are coagulated and the cut practically does not bleed. The cutting speed depends on intensity (output density) and on the properties of the tissue. The most frequently used lasers are infrared, namely CO₂ laser (10.6 μm) or solid Nd:YAG laser (1.064 μm).

Ophthalmology:

Besides being the light source of many optical instruments used for examination, the main use is photocoagulation of retina and photoablation of cornea to correct refraction defects.

Lasers used for **photocoagulation** are mostly Nd:YAG with green light 532 nm, adjustable output up to 1.5 W.

For corneal refraction defects removal – **photoablation** - ArF or KrF excimer (excited dimers) lasers are used. They emit UV radiation with 193 nm wavelength. It causes photochemical ablation of the collagen macromolecules in the cornea (every impulse removes 0.1 - 0.5 μm of the tissue). The aim is to change the curvature of the cornea and its refraction, thus improving the patient's vision.

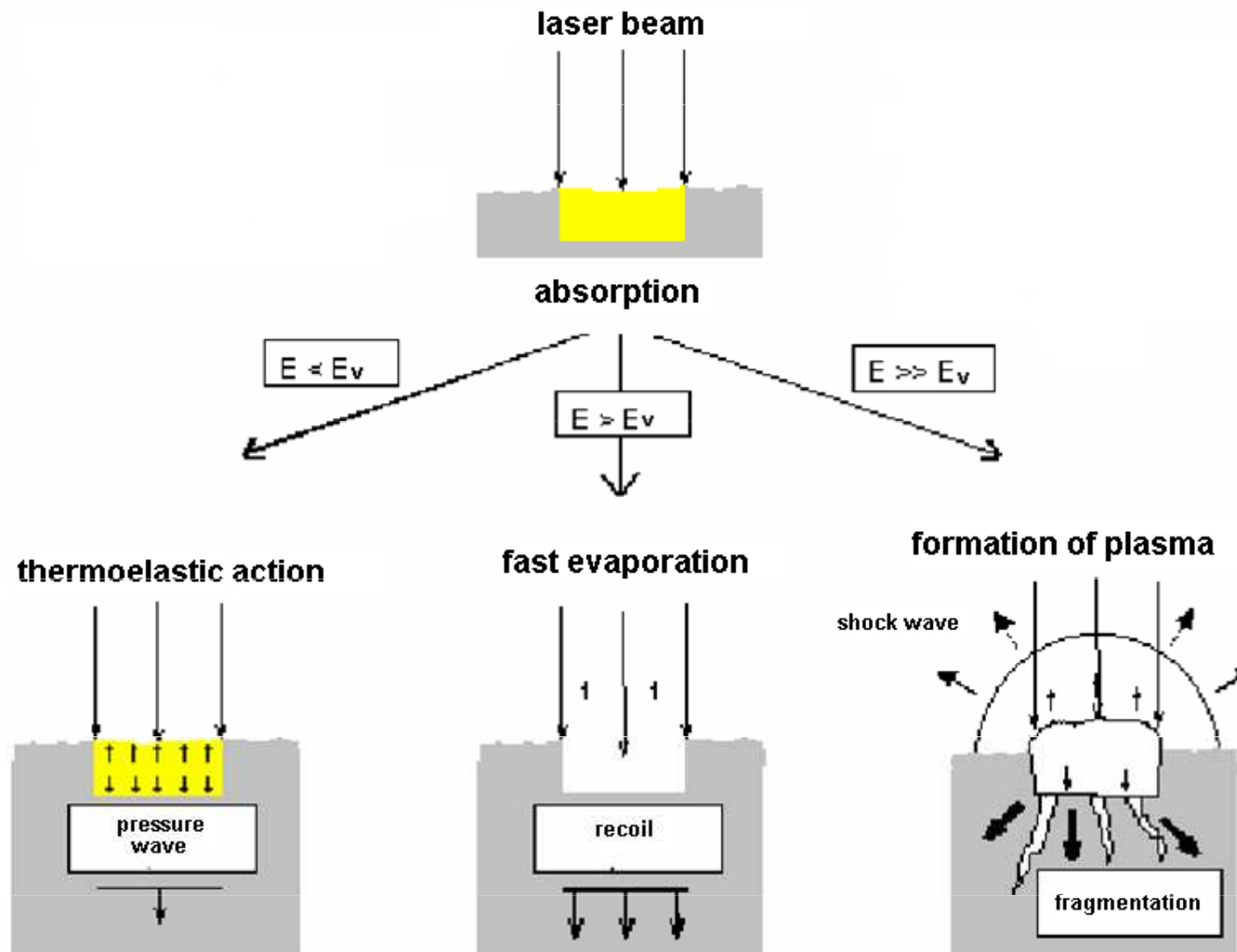

<http://www.dekamela.com/lasertessuto/fig5.gif>

High-power laser application

- In **dentistry**, neodymium and erbium YAG lasers are used. The Nd:YAG laser (1.064 μm) is used in oral surgery and endodontics. The Er:YAG laser (2.940 μm) is used for precise preparation of the tooth enamel and dentine.
- **Dermatology** uses ruby lasers (690 nm) or other laser types including Nd:YAG and alexandrite lasers (adjustable from 720 to 830 nm, well absorbed by skin melanin). The main applications are photocoagulation of varicose veins, wart removal, skin lifting, depilation and tattoo removal.

Laser applications



BEFORE



AFTER

Face lifting

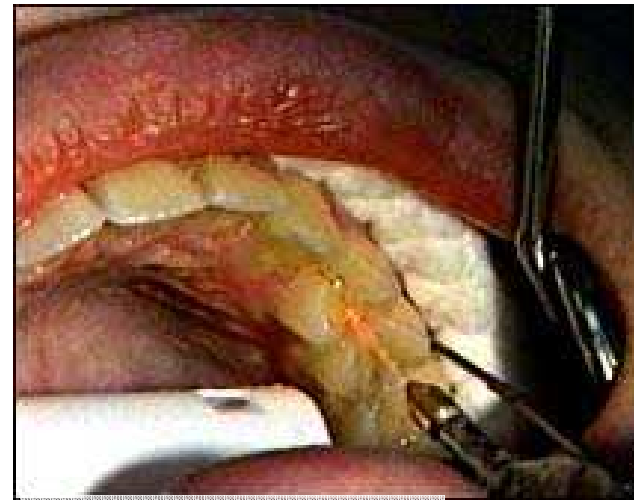

caries removal

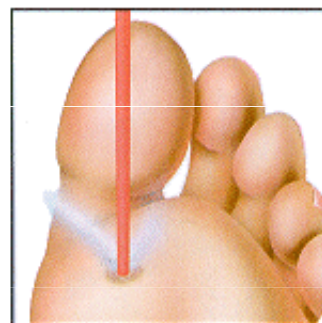

removal of warts

Electrosurgery

- These methods use **heating effects** of high frequency electrical currents. An electrode with a point or a sharp edge can develop a high density of current.
- Heat effects are so extensive that water evaporates in the cells, causing their destruction. The high temperature causes coagulation of the tissues and blood, so no bleeding (haemorrhage) occurs. The operating frequency of electrosurgical instruments is about 3 MHz, the output is adjustable up to 500 W. The power differs according to the aim of the surgical intervention (50 W is used in eye and teeth surgery, higher output in breast and abdominal surgery and traumatology).
- Electrosurgery devices are equipped with electrodes for **electrocoagulation**, which close bleeding vessels by coagulation of proteins.

Electrosurgery



Point electrode for removal skin defects

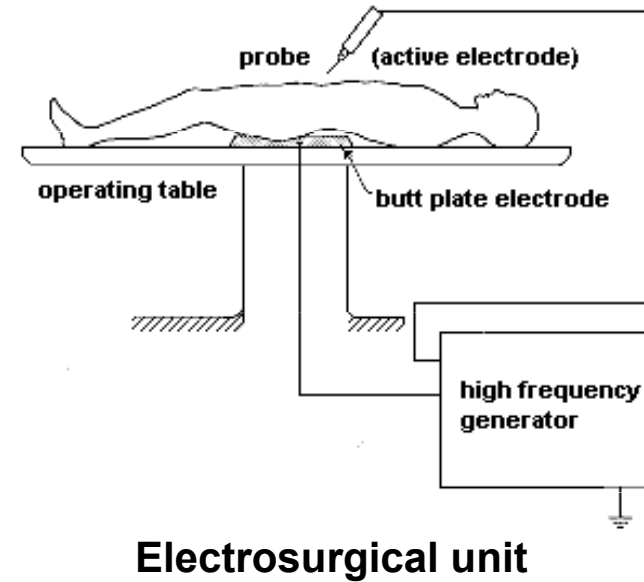

Electrosurgery

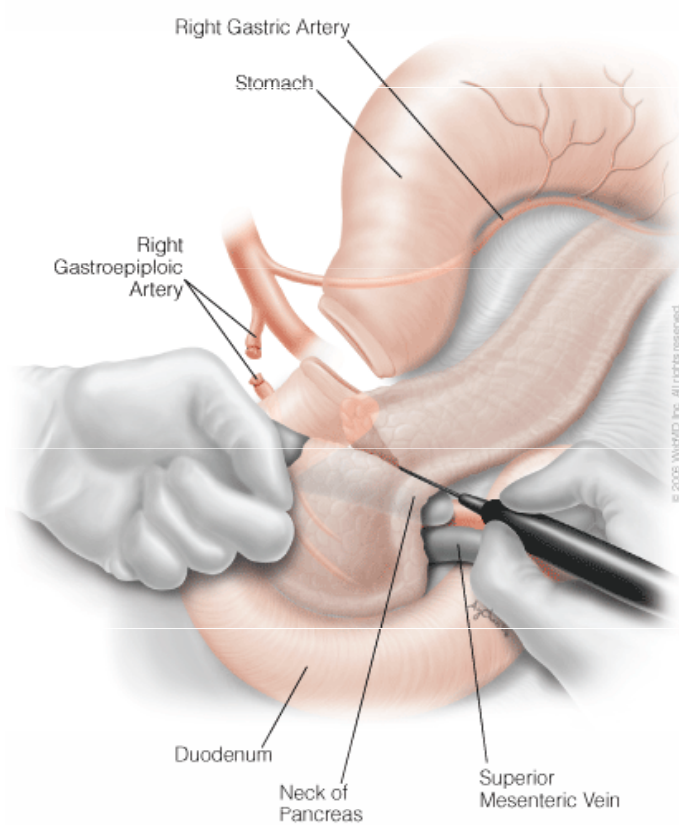

**Whipple procedure.
Transection of the neck
of the pancreas with
electrocautery.**

Endoscopic electrosurgery



Removal of the polypus from intestinal mucosa

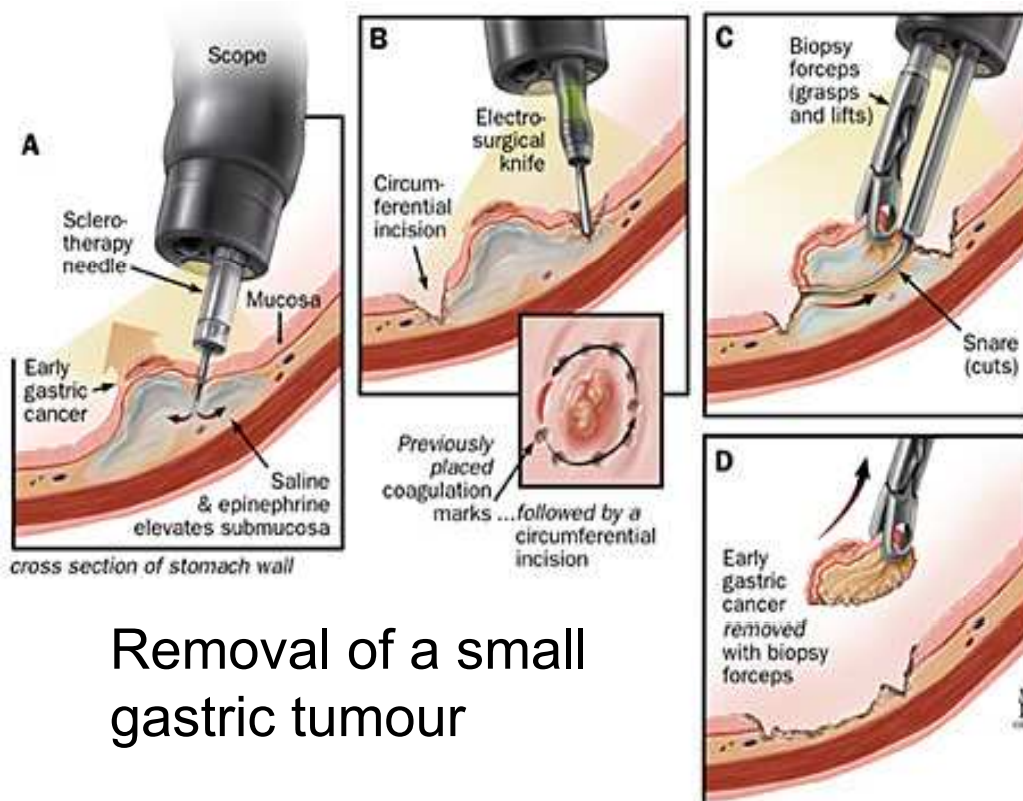

Removal of a small gastric tumour

Ultrasonic tools

- Ultrasound of high intensities ($50-1000 \text{ W}\cdot\text{cm}^{-2}$) can be used in surgery for selective tissue destruction.
- 1. **Focused ultrasound with high frequency (1-3 MHz)** for selective destruction of soft tissue structures. These systems are in clinical test for breast tumour ablation.
- 2. **Low frequency ultrasound (20 - 50 kHz)** has been developed for surgical use. Ultrasound produced by piezoelectric or magnetostrictive generators is transmitted to the tissue by special wave-guides, able to enhance the amplitude of ultrasound oscillations up to 10 times. A steel lancet or removable tip is attached to the end of the wave-guide. The removable tip is used also as an aspiration tube, so that the destroyed tissue can be sucked away (aspired).

Ultrasonic tools

Aspirator. The acoustic vibrator contracts and expands due to ultrasonic oscillations. The motion of the tip (stroke) is approximately 200 μm . The end of the tip experiences high velocities and accelerations that produce the effect of fragmenting contacted tissues.



Cavitation Ultrasonic Surgical Aspirator. This modified probe includes an extended flue and a vibrating tip for laparoscopic surgery.

Ultrasonic tools

Low frequency intensive ultrasound source – **phacoemulsifier** - is an indispensable aid for eye surgeons in the extraction of opaque eye lenses (cataracts). The emulsified lens is immediately sucked away (aspired).

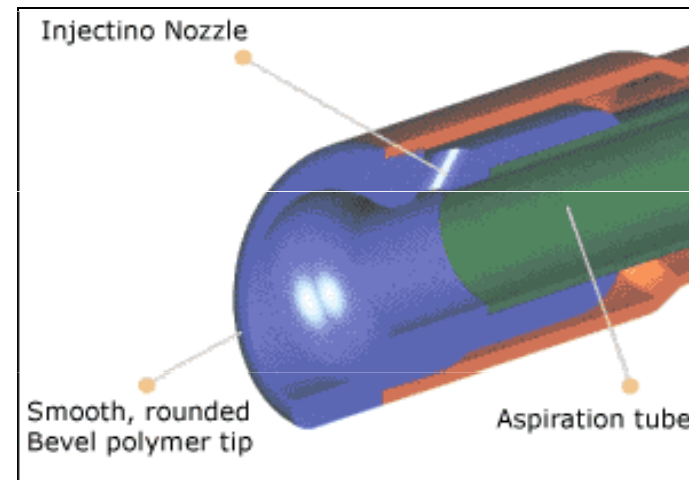

Ultrasonic tools in dentistry

- The main application field: tartar removal - scaling. **Ultrasonic scalers** are fast and efficient. They consist of two main parts: the source of electric oscillations necessary to driving generator of ultrasound, and a handpiece containing ultrasonic transducer, working at a frequency of about 40 kHz. The transducer is linked to variously shaped working tips. Some devices are equipped with water spray (rinsing and cooling).
- Ultrasonic scaling mechanisms:
 - **direct effect of ultrasonic oscillations of the working tip on the deposited tartar**
 - **ultrasonic cavitation**
 - **ultrasonic microstreaming**

Ultrasonic tools in dentistry

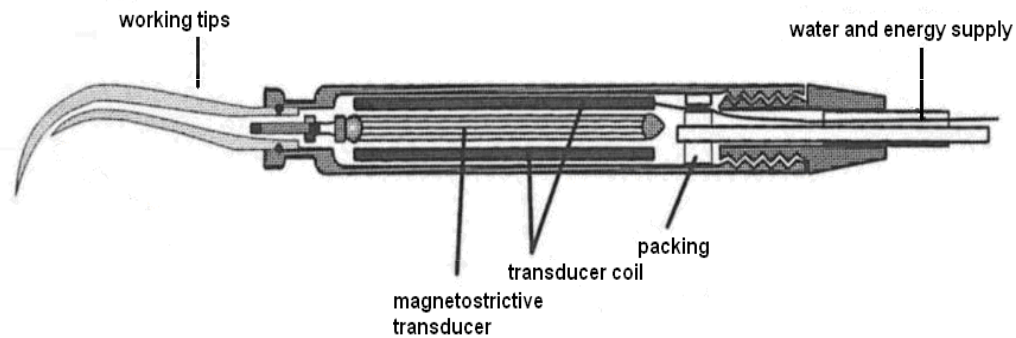

A schematic diagram of ultrasonic scaler (up with magnetostrictive, down with piezoelectric transducer)

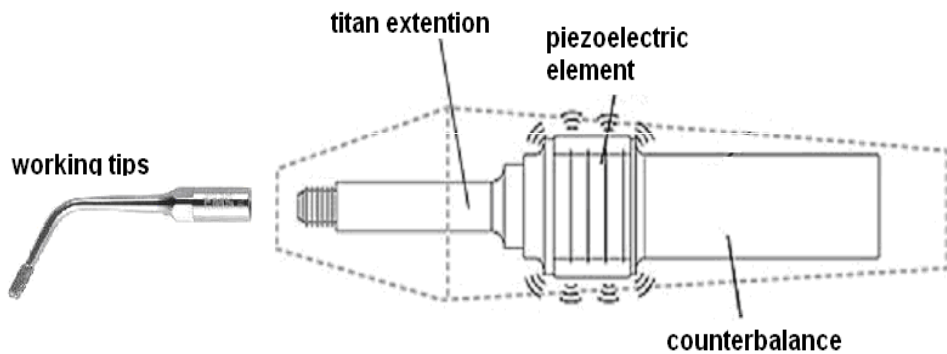

Ultrasonic tools in dentistry

- A somewhat simpler and cheaper alternative to the ultrasonic scaler is the **sonic scaler**. The audible sound oscillations are obtained mechanically with the help of an unbalanced air turbine.
- The next tools using ultrasonic oscillations are **endodontic root-canal devices**. Contrary to rotary tooth-canal tools they oscillate longitudinally with frequency of 30 - 50 kHz. They have either the form of a thin steel screw-shaped tip or a slightly conical tip with diamond coating. The main effective mechanism is mechanical abrasion of the root-canal walls enhanced by ultrasonic cavitation.

Cryosurgery

- The temperature $-25\text{ }^{\circ}\text{C}$ down to $-190\text{ }^{\circ}\text{C}$ creates ice crystals inside cells and in intracellular spaces. Cell lysis occurs when the ice thaws.
- The advantage is the limitation of tissue destruction to the frozen area sparing nearby healthy tissue. The freezing has an anaesthetic effect so that the cryosurgical intervention causes little pain. The wound practically does not bleed. The frozen tissue sometimes is fixed to the tool, which can be used to extract it (cryoextraction of the eye lens when the cataract is operated). Applications in eye surgery, urology, oncology, gynaecology and plastic surgery.
- Cryosurgical devices use liquid nitrogen ($-196\text{ }^{\circ}\text{C}$) or other gases to reach low temperature. The proper cryosurgical tool — has a freezing part on its distant end. The end part of the **cryocauter** is changeable and has a different shape according to the procedure performed. A digital thermometer displays the temperature.

Cryosurgery

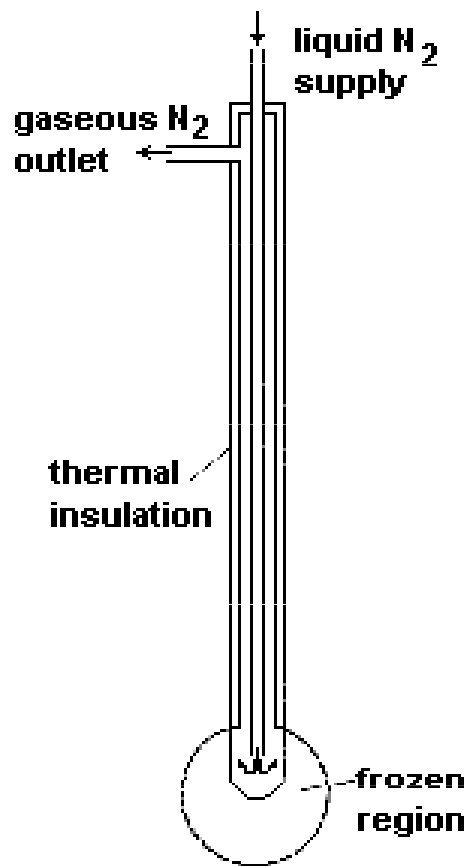

Cryosurgical equipment using nitrous oxide (N₂O) and carbon dioxide (CO₂)

Cryosurgery (liquid nitrogen)



Water jet dissector as a surgical tool

The device comprises a pressure pump, a high-pressure tube and a manipulation part with the thin jet of 0.1 mm diameter on its end.

Pressures in the range from 1.5 to 5.0 MPa are usually used.

The cut borders are smooth.

The jet is a sterile isotonic solution, sometimes with medicaments added to limit bleeding or resist infection.

It is said that it gives excellent control of the cut, which is especially significant at brain and parenchyma-tous organs (liver, spleen).

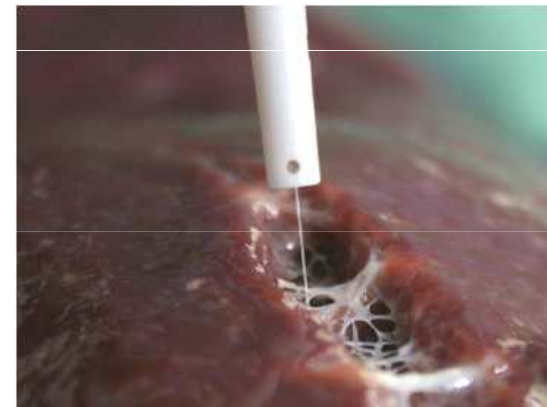
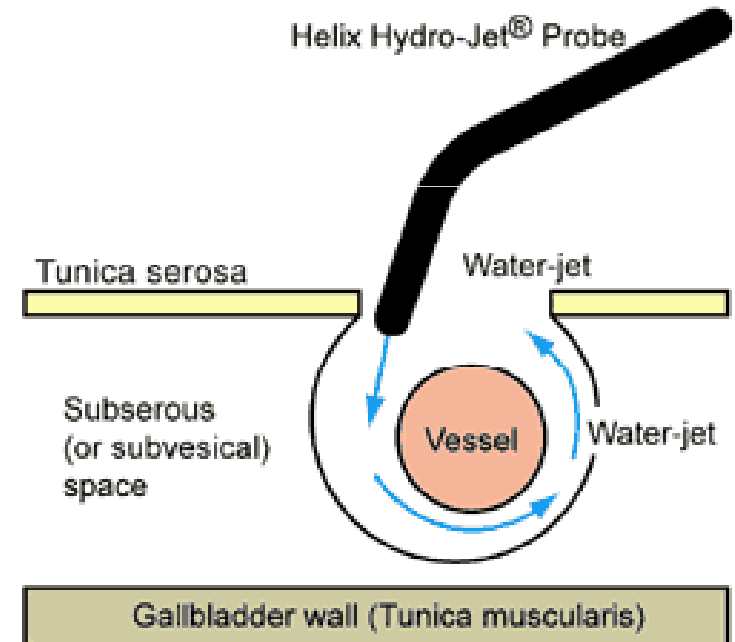

Plasma scalpel in fibroma removal

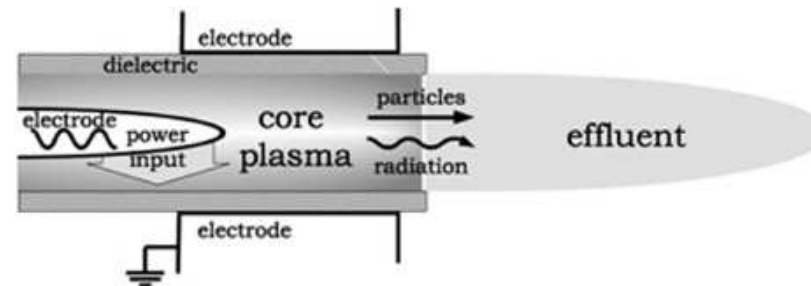

Lithotripsy

- In the early 80s, **extracorporeal shock-wave lithotripsy** (ESWL) was introduced in clinical practice. Destruction of stones (kidney, biliary) by the action of multiple **shock waves** – strong impulses of acoustic pressure. The debris is removed from the body via natural efferent ways. It is a minimally invasive method.
- A rapid onset of pressure gradient arises on an interface of two media as a result of difference in acoustic impedances. If the pressure force exceeds the mechanical resistance of a stone, its progressive fragmentation occurs. Pressures of about 10^8 Pa are necessary. Many shock waves (50 to 4000, on average 1000) must be applied (synchronously with heart beats).
- Main parts of the lithotripter: source of shock waves, focussing device, coupling medium, accurate device for stone targeting (ultrasonograph or X-ray device).

Lithotripsy

time-course of a shock wave

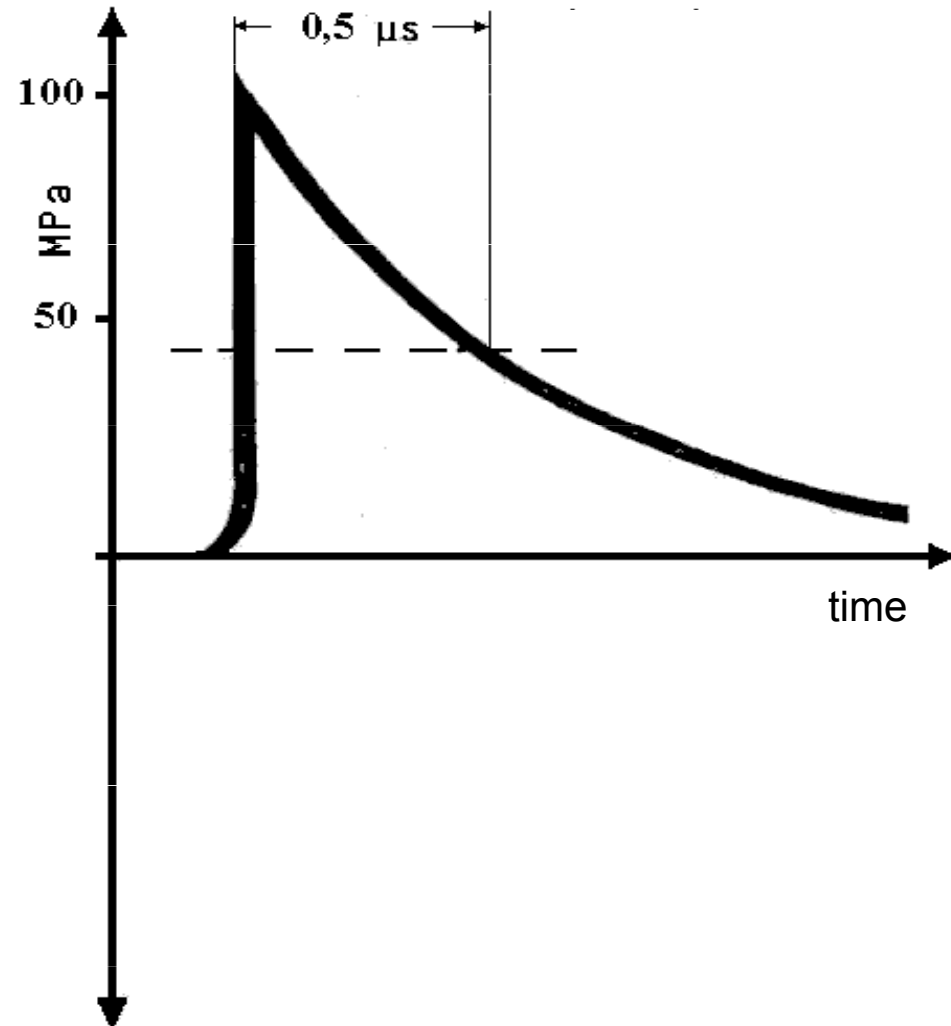

Lithotripsy

production of shock waves and their focussing

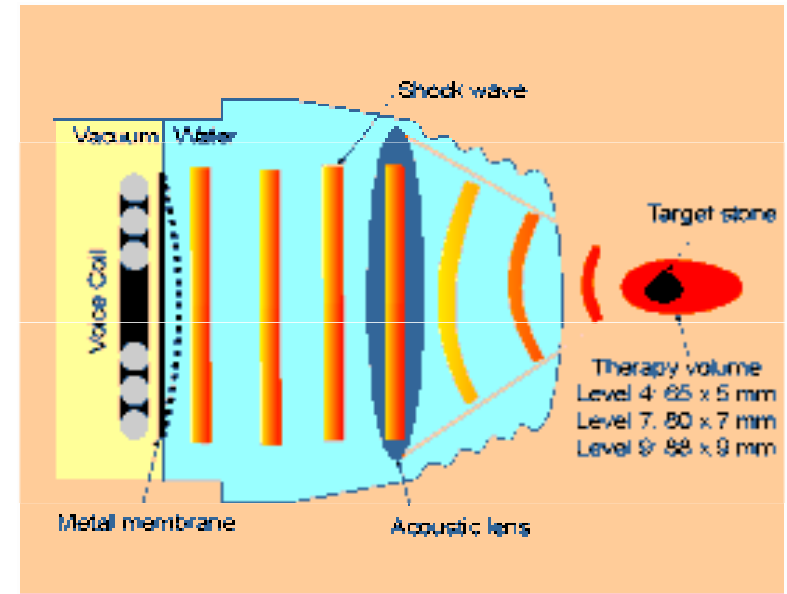
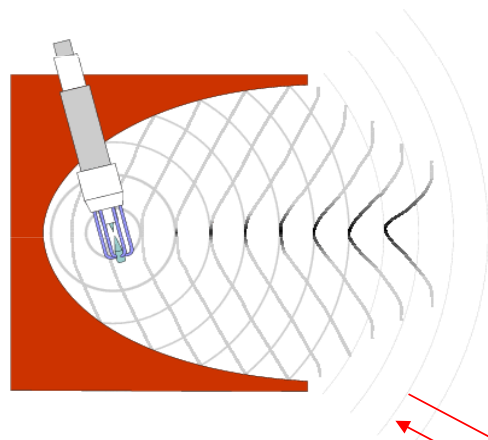

Ellipsoidal metallic mirrors.
Shock waves are produced in
one focus and are reflected to
the second focus.

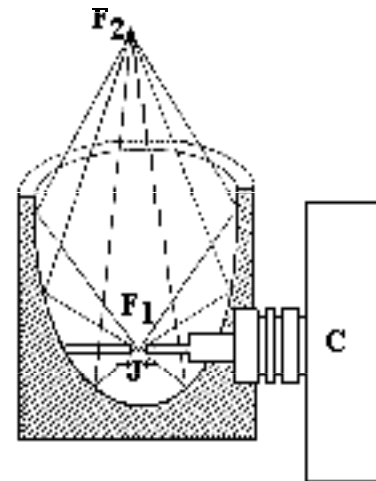

Lithotripsy

Destruction of a kidney stone

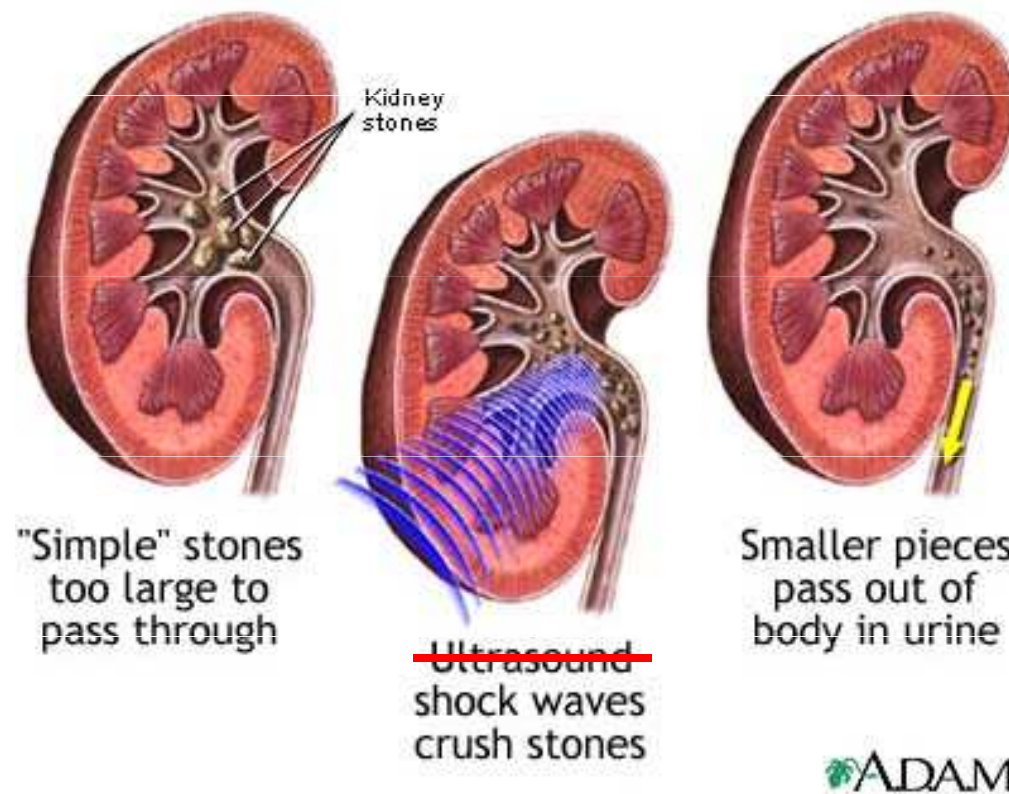

MUNI

Lithotripsy (beginnings – Munich - Germany)

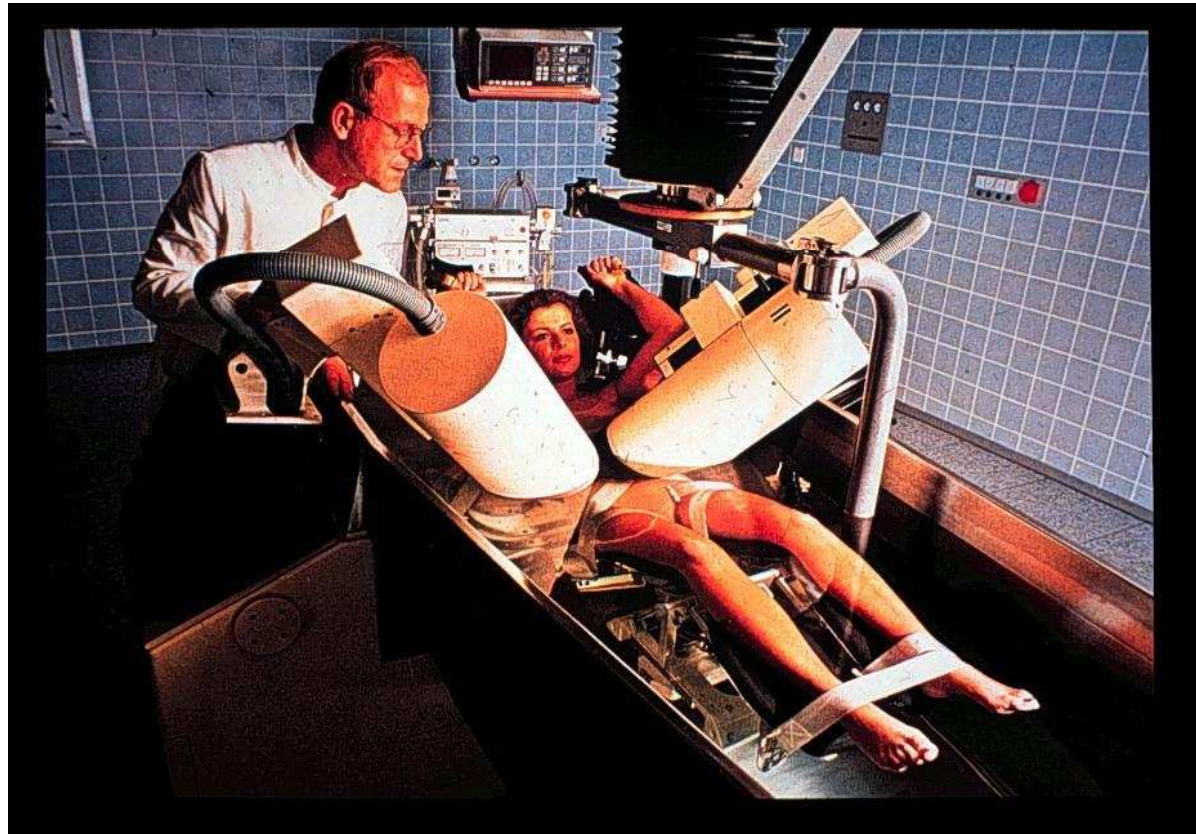

Lithotripsy - lithotripter in clinical practice



MUNI

Lithotripsy - Czech lithotripter MEDILIT M8



ESWT – extracorporeal shock-wave therapy



Calcification of tendons in shoulder, calcaneal spur, stimulation of fracture healing
www.physio-chelsea.co.uk/shockwave.htm.

The shock waves of energy 1.2-40 mJ have energy density of 0.14 – 1.8 mJ/mm² in focus. This energy is sufficient to penetrate to max. 60mm in depth. The frequency can be changed from 1 to 4 Hz. The focal pressure is 10 – 100-times lower than that produced by a lithotripter.



MUNI

M U N I

Author:
Vojtěch Mornstein

Content collaboration and language revision:
Carmel J. Caruana

Last revision November 2021,
soundtrack added December 2020