

MUNI

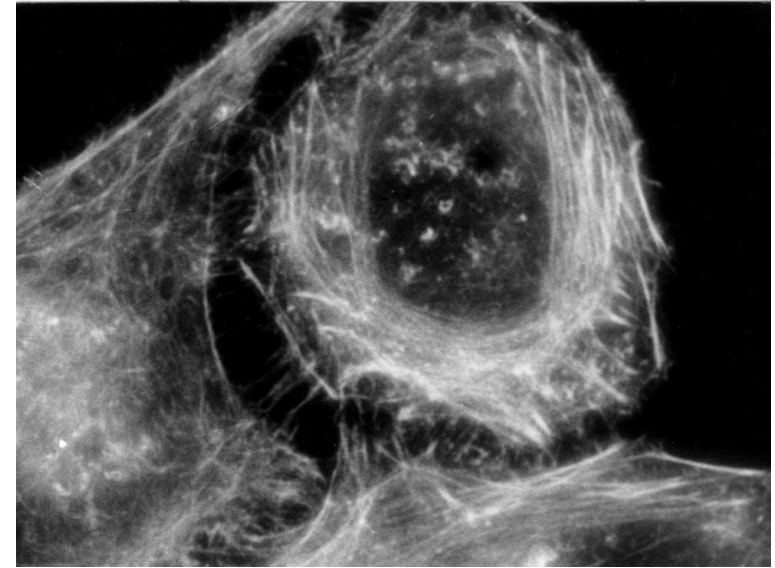

Lectures on Medical Biophysics

Microscopy

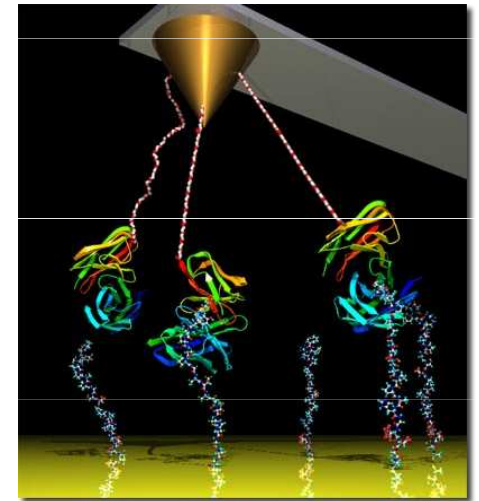

Lecture outline

- **Optical (light) microscopy**
 - Physical principles of microscopy
 - Variants of optical microscopes
 - Phase contrast
 - Fluorescence microscope
 - Special Optical microscopes
 - Laser confocal scanning microscope
 - Microscopes with superresolution
- **Electron microscopy**
 - Transmission electron microscopy
 - Scanning electron microscopy
- **Scanning probe microscopes**
 - Scanning tunnelling microscope
 - ATM - Atomic force microscopy
- **Acoustic microscopy**

Prerequisites

- What should you know?
 - Fundamentals of geometric and wave optics.

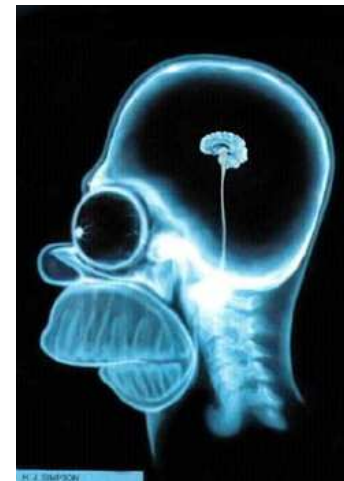

Compound microscope

- The spatial resolution (SR) of the unaided eye at a distance of 25 cm is about 14 lines per mm.
- The magnifying glass can increase this substantially (for high SR we require large diameter of lens and smaller focal length) However, it does not have a high enough SR to allow us to study the microstructure of living matter.
- The **first microscopes** were manufactured in The Netherlands in the end of 16th century. Anthony van Leuwenhoek (1632-1723) improved their construction and used it for many biological observations.
- The construction of the **electron microscope** (in 30th of 20th century) was the next milestone of microscopy. The SR of microscopes improved about 1000-times more than the optical microscope, so it was possible to see big molecules. Today we can resolve even individual atoms.
- In principle, we can use any wave motion to depict microscopic objects. The only condition is that the wavelength must be shorter than the dimensions of the observed object – **diffraction barrier**.

First compound microscopes

Robert Hooke 1635-1703

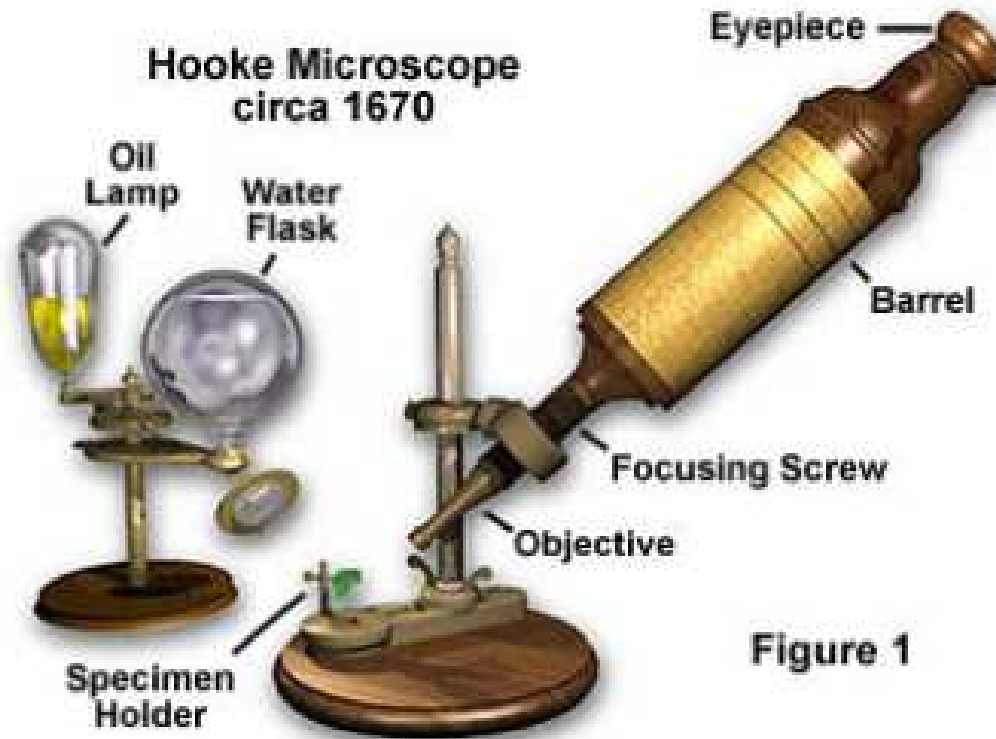

Figure 1

•<http://micro.magnet.fsu.edu>

Scheme of the microscope and properties of its optical system

- Basic parts: two systems of lenses - objective and eyepiece. (Both approx. converging lenses).
- Considering the quality of the image, the most important part is the **objective** which forms a real, magnified and inverted image. The observed object must be placed between F (position of the focus) and $2F$. The objective can be considered as a convex lens of very short focal length for high SR.
- The mechanical piece connecting the objective with the eyepiece is called the **drawtube**. The image formed by the objective (positioned just behind the front focus of the eyepiece) is observed by the **eyepiece** in the manner of a simple magnifying glass. A magnified, inverted and virtual image results.
- The **condenser** optical system focuses light onto the observed object, and ensures its perfect illumination.

Optical scheme and magnification of the microscope

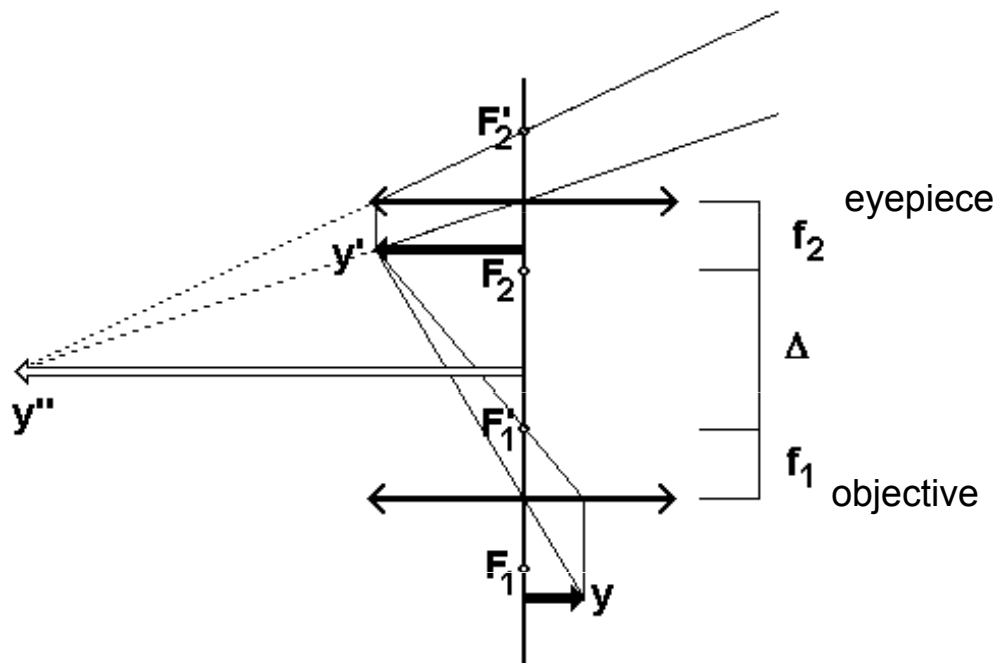

F – focal points, f – focal distances, y – object, y' – real image of the object formed by the objective, y'' – virtual image seen in the eyepiece, Δ – optical interval of the microscope.

$$M = M_{ob} \cdot M_{ep} = \frac{\Delta \cdot d}{f_{ep} \cdot f_{ob}}$$

d - distance of the most distinct vision (0.25 m), Δ - optical interval of the microscope, f_{ob} and f_{ep} are the respective focal distances.

Microscope Objectives

60x Plan Apochromat Objective



Figure 1

Objectives of microscopes



Different objectives with apochromatic correction of optical aberrations of the objective

•<http://micro.magnet.fsu.edu/>

•Plan–Apochromatic correction of optical aberrations is used in objectives for micrography and microcinematography

Correction of optical aberrations - **Achro** and **Achromat** (achromatic), **Fl**, **Fluar**, **Fluor**, **Neofluar**, **Fluotar** (fluorite lenses, better correction of spherical and chromatic aberrations), **Apo** (apochromatic, the best correction of these aberrations), **Plan**- correction of the field curvature (and focussing of the whole image plane in the vision field of the microscope)

Spherical aberrations

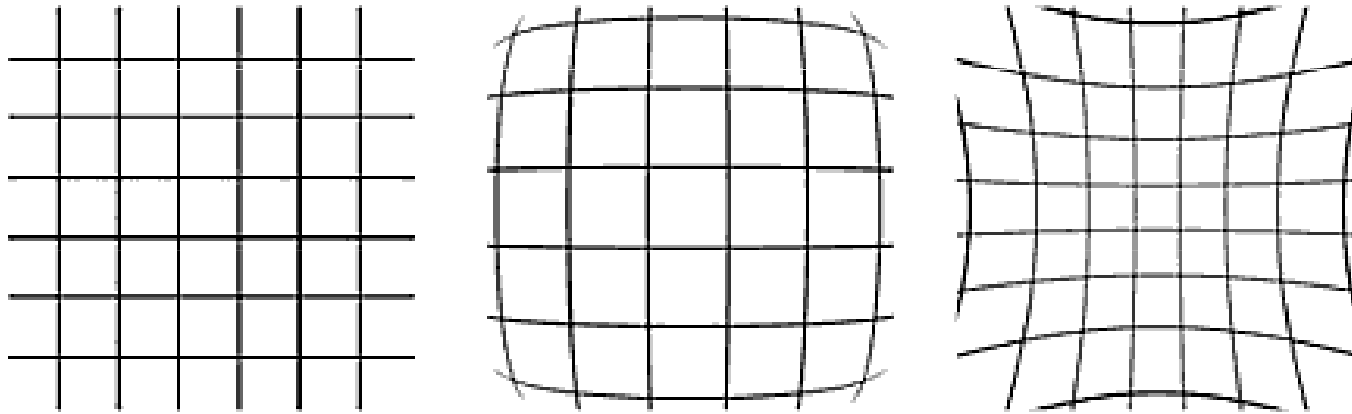

The spherical aberrations cause deformation of lines forming „barrels“ (in the middle) or „pillows“ (right)

• <http://apfyz.upol.cz/ucebnice/down/optmikro.pdf>

Chromatic aberrations

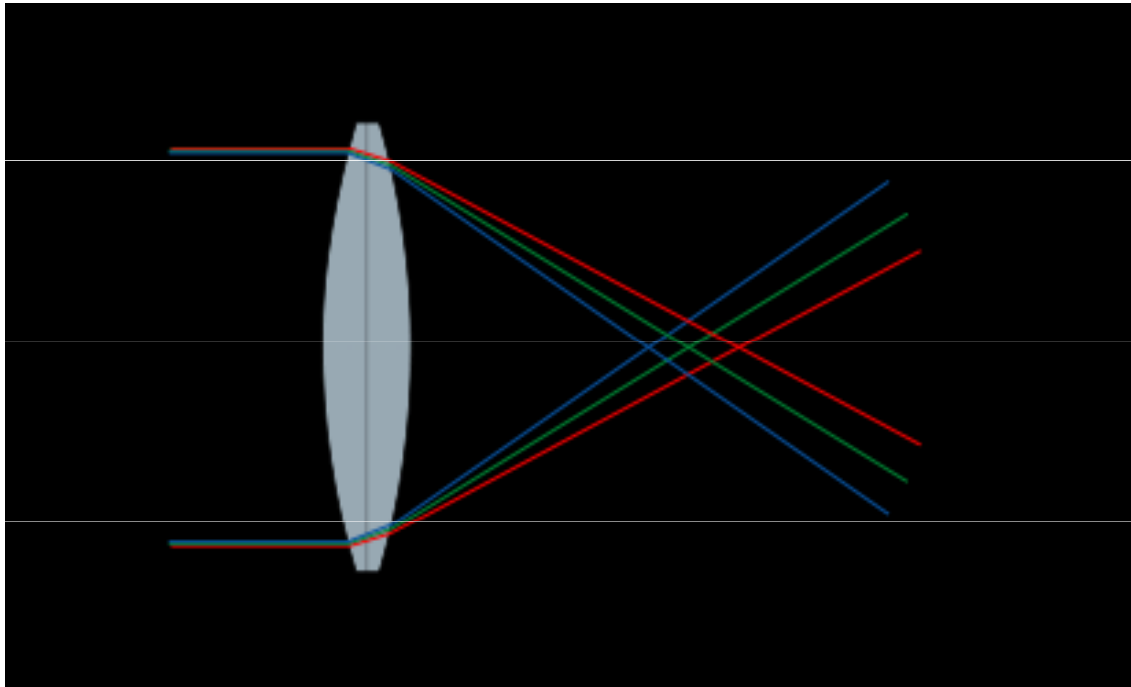

- White light is decomposed to individual spectral colours so we need correction for 2-3 colours, most often yellow, green and red.

- <http://cs.wikiversity.org/wiki/MedFyz>

Objective specifications – numerical aperture (NA)

Numerical aperture – This is the most important specification: it determines the light acceptance angle (which determines the brightness of the image, the higher the NA the higher the acceptance angle),

$$NA = n \cdot \sin\alpha$$

where n is the refraction index of the medium between the objective and the cover glass, α is the acceptance angle.

To increase NA we can use an immersion medium with higher index of refraction than the index of refraction of the air

- $n_{air} = 1.003$
- $n_{water} = 1.333$
- $n_{glycerol} = 1.473$
- $n_{cedar\ oil} = 1.515$
- $n_{bromnaphtalen} = 1.658$
- $n_{metyleniodide} = 1.740$

NA maximum value is about 1.5

Use of Immersion Media

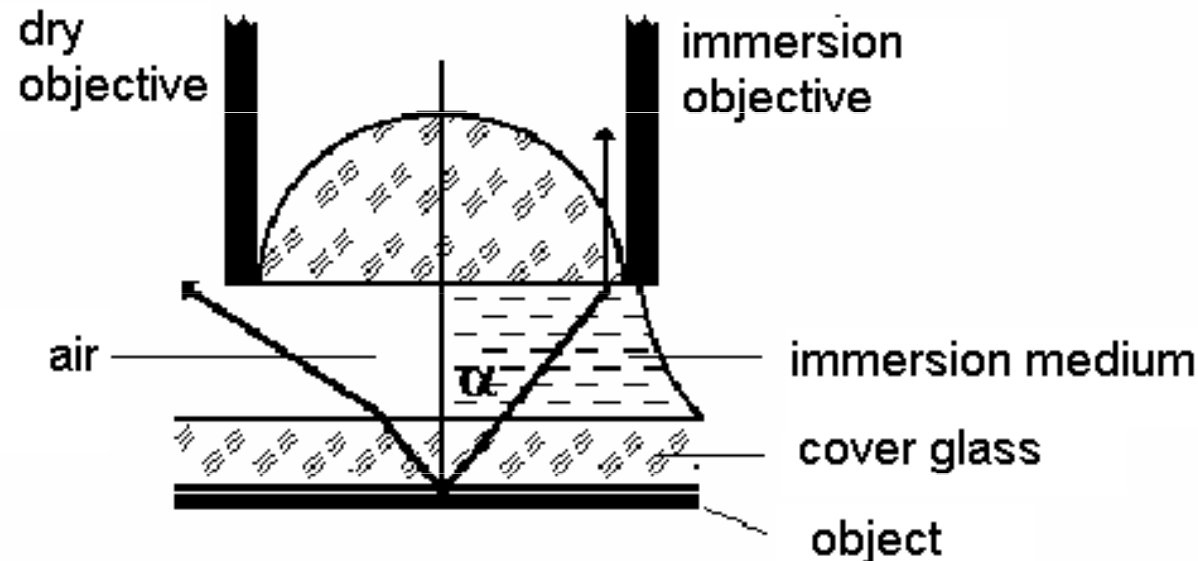

Immersion media are used to increase the NA.

The left ray leaving the slide is refracted on the interface between the cover glass and air away from the normal and cannot take part in the image formation. The right ray passing from glass into the immersion medium (which has a refractive index close to that of glass) does not change its direction and contributes to the image.

SR limit of the microscope

The space resolution (SR) limit is proportional to the NA and inversely proportional to the wavelength λ of light used (German physicist *Abbe*, 1840-1905). In some textbooks of microscopy, the SR is also defined by the formula:

$$\delta = \lambda/NA$$

where δ is **distance of two still distinguishable points** ($NA = n \cdot \sin\alpha$, n is refraction index of medium between the objective and the cover glass and α is the above mentioned acceptance angle).

SR increases with magnification. By combining strong converging lenses, we could construct a microscope with almost arbitrary magnification, however we find that beyond a certain limit (limit of 'useful magnification') there is no further increase in the limiting SR (just 'empty' magnification').

SR decreases if the condenser aperture is reduced however the contrast resolution (CR) increases! Hence for a given specimen one must choose a condenser aperture to provide a balance between SR and CR. If one just needs to reduce brightness it is best to turn down the voltage to the lamp then decrease the condenser aperture so that one does not reduce the SR.

Depth of Field Z

This is the thickness of objects along the z-axis which is simultaneously in focus. Important for thicker specimens.

$$Z = \frac{n}{NA^2}$$

n is refractive index of the specimen (liquid surrounding the microscopic object)

Objective Specifications

- **Cover Glass Thickness** (standard thickness 0.17 mm). Some objectives have a **correction collar** to compensate for any variation from this standard.
- **Working Distance** - Distance between objective front lens and top of cover glass when the specimen is in focus. Decreases as magnification increases. Newer objectives have the working distance in mm inscribed on the barrel.
- **Color Codes** - Microscope manufacturers label their objectives with color codes to help in rapid identification of the magnification and immersion media requirements.

Variants of optical microscopy

- Observation in **bright** or **dark field**
- **Stereomicroscope** (two microscopes with individual objectives and eyepieces with optical axes at an angle of about 15°) - stereoscopic vision. In medicine: **microsurgery**. The image must not be inverted. The surgery field is illuminated by optical fibres. The possibility of changes in the focal length of the objective produces zooming – a variable spatial resolution.
- Modern research microscopes are equipped with digital cameras for **microphotography** or **microcinematography (video recording)**.
- Image processing software: performs changes of contrast, brightness, sharpness etc. Advanced software enables quantitative analysis of images, searching for typical patterns etc.
- Most kinds of microscopes can be set up by changing the objectives, eyepieces, condensers, or by addition of some special optical elements. Many accessories are available, e.g. micromanipulators used to place microelectrodes into cells, separate organelles etc.

Stereomicroscope

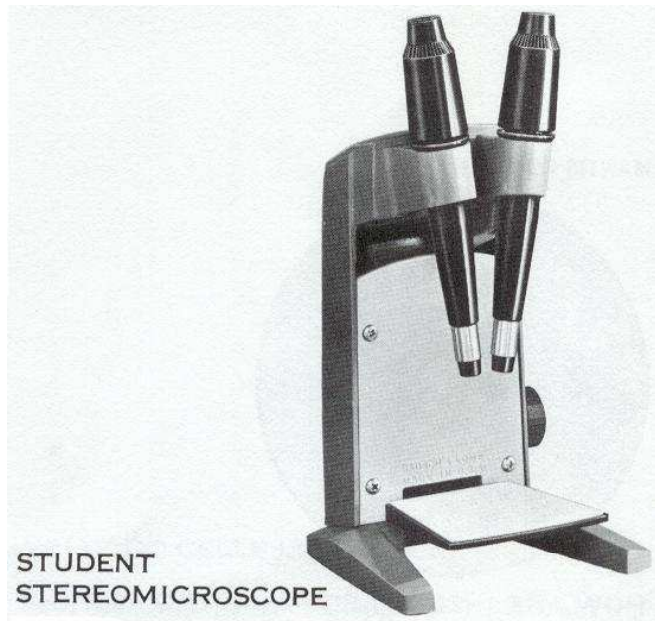

•The **OPMI® Vario/NC 33** surgical microscope

MUNI

Phase Contrast Microscopes

- A technique that produces contrast images of biological specimens, which structures have similar light attenuation (all equally transparent and therefore produce little contrast in normal transmission microscopy) but have slight differences in refractive index (and hence produce differential phase).
- *The phase contrast technique changes the phase differences into amplitude differences.* Living cells can be examined without being fixed, and stained.

Phase Contrast Microscopes

Principle: The annular diaphragm is added in condenser frontal focus plane - light passes through a narrow, ring-shaped slot. As the light passes through the object, the rays are deflected from the original direction. In the objective back focal plane is a **phase plate**, shaped like the annulus again, which shifts the phase by $+\pi/2$ or $-\pi/2$, i.e. by $1/4$ of the wavelength. This plate transmits rays which did not change their direction on phase objects. Other rays miss the plate, their phase is not shifted. The picture is formed by interference of the phase-shifted and non-shifted rays. The phase objects seem dark or bright in comparison with their surrounding (positive or negative contrast).

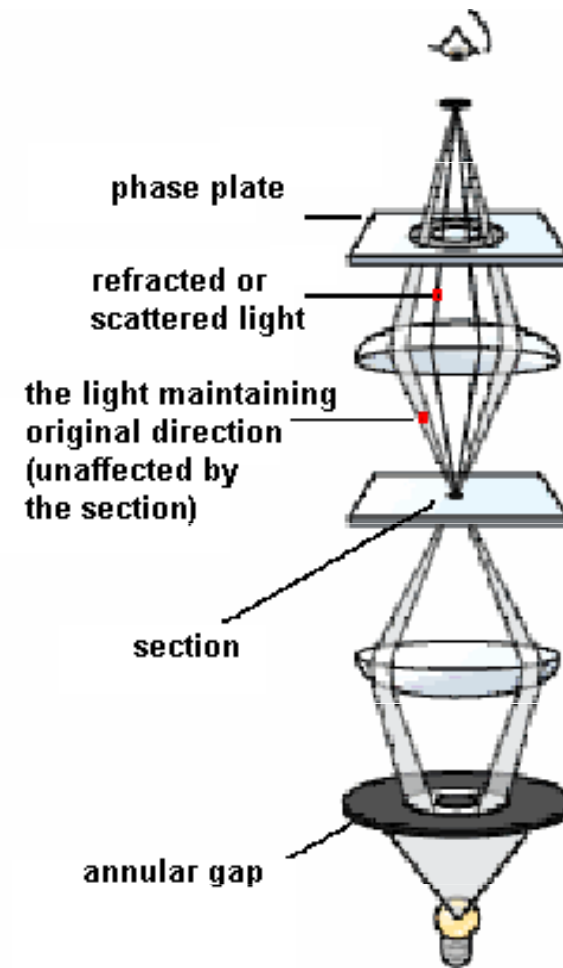

According to <http://www.nobel.se/physics/educational/microscopes/phase/>

Phase contrast microscope

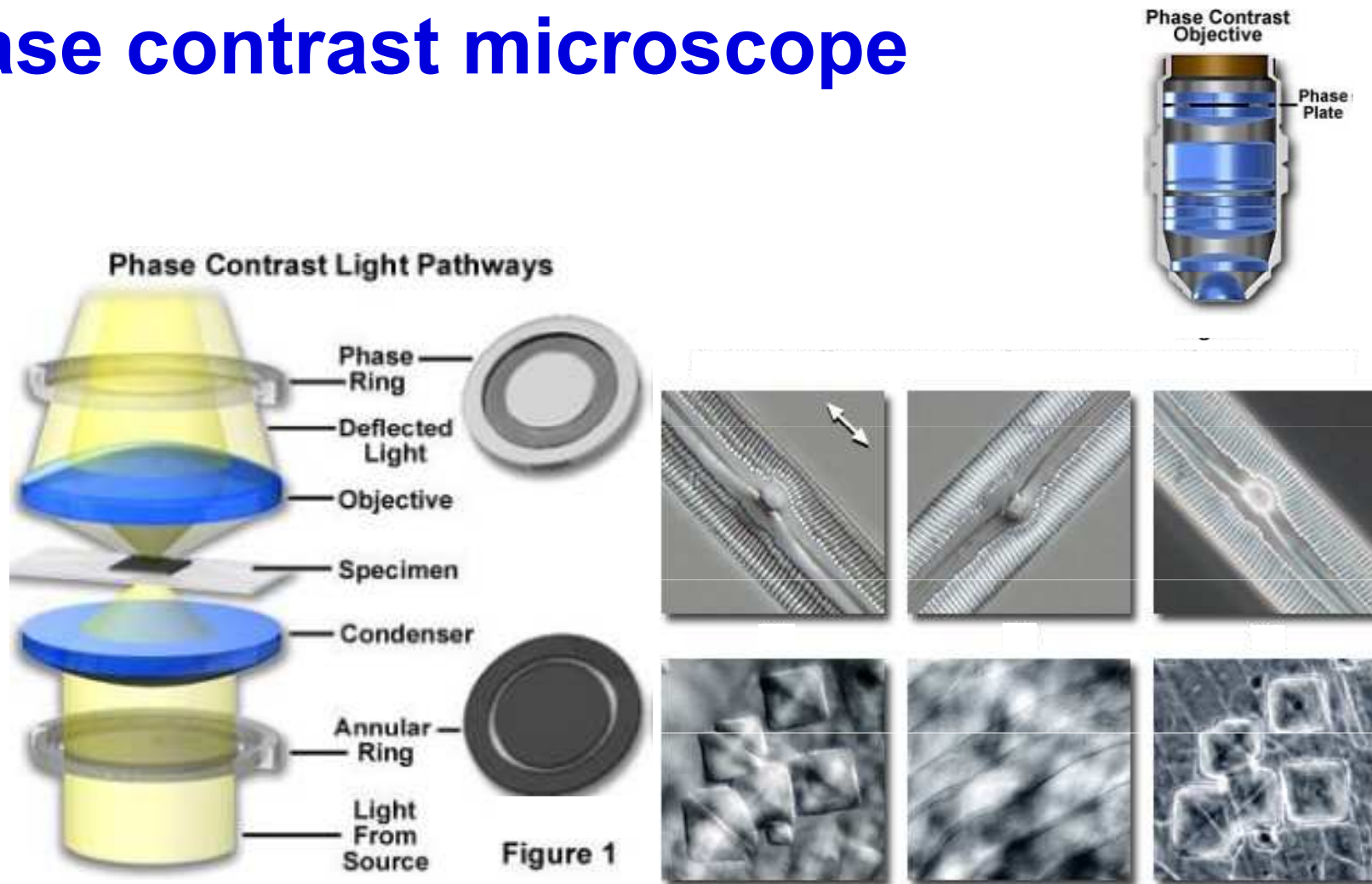

•<http://micro.magnet.fsu.edu/>

•<http://micro.magnet.fsu.edu/>

Phase contrast microscope

Many colourless biological objects (difficult to observe in a common microscope) are phase objects. Dyes and stains can make them visible, but they often poison the cells. Phase contrast microscopes allow to observe such objects without staining.

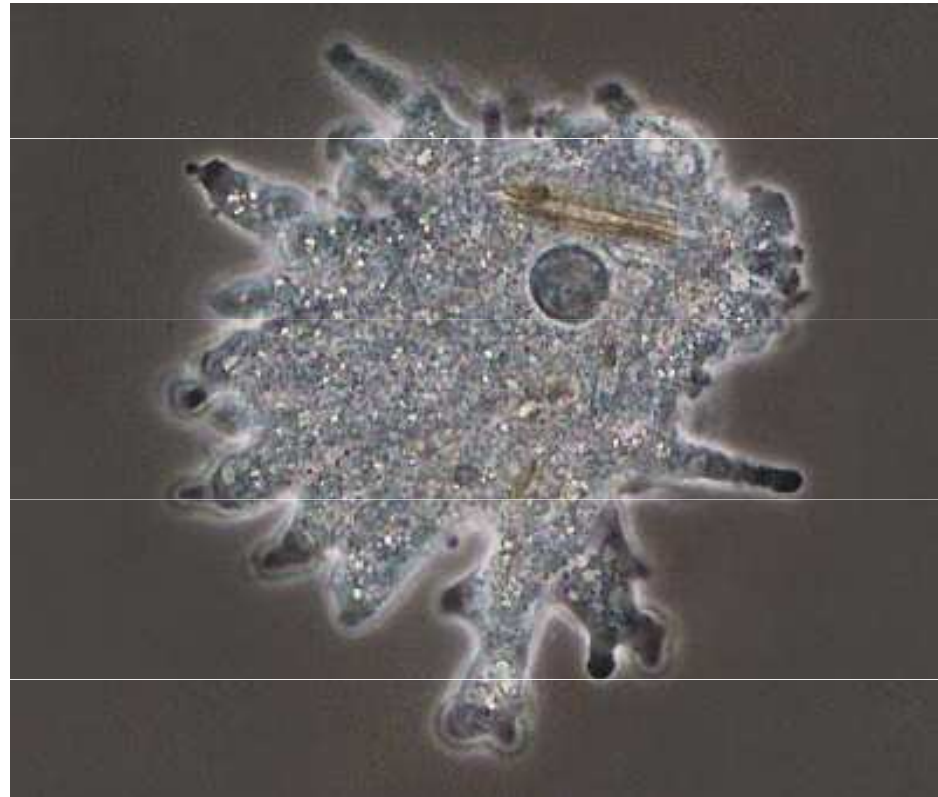

Amoeba seen in phase contrast – M = 250x
(www.durr.demon.co.uk/colour.html.)

Fluorescence microscope

- **Fluorescence microscopy** is based on the ability of some substances to emit visible light after irradiation by light of shorter wavelength (UV radiation or violet light).
- The optics of the condenser must be adapted to UV light, which can be also supplied through the objective (upper illumination). The remaining part of the microscope is identical with the same part of a common microscope. Eye protecting UV filters are needed.
- The fluorescence is exhibited e.g. by tryptophan or other compounds with an aromatic ring or heterocycle. In most cases, **fluorescent dyes** specifically interacting with various cell structures are added to the observed biological objects. Sometimes the dye (fluorochrome, fluorescence probe) is bound to an **antibody** specific for some protein. This immunofluorescence method can selectively visualise e.g. the cytoskeleton, chromatin, membrane proteins.

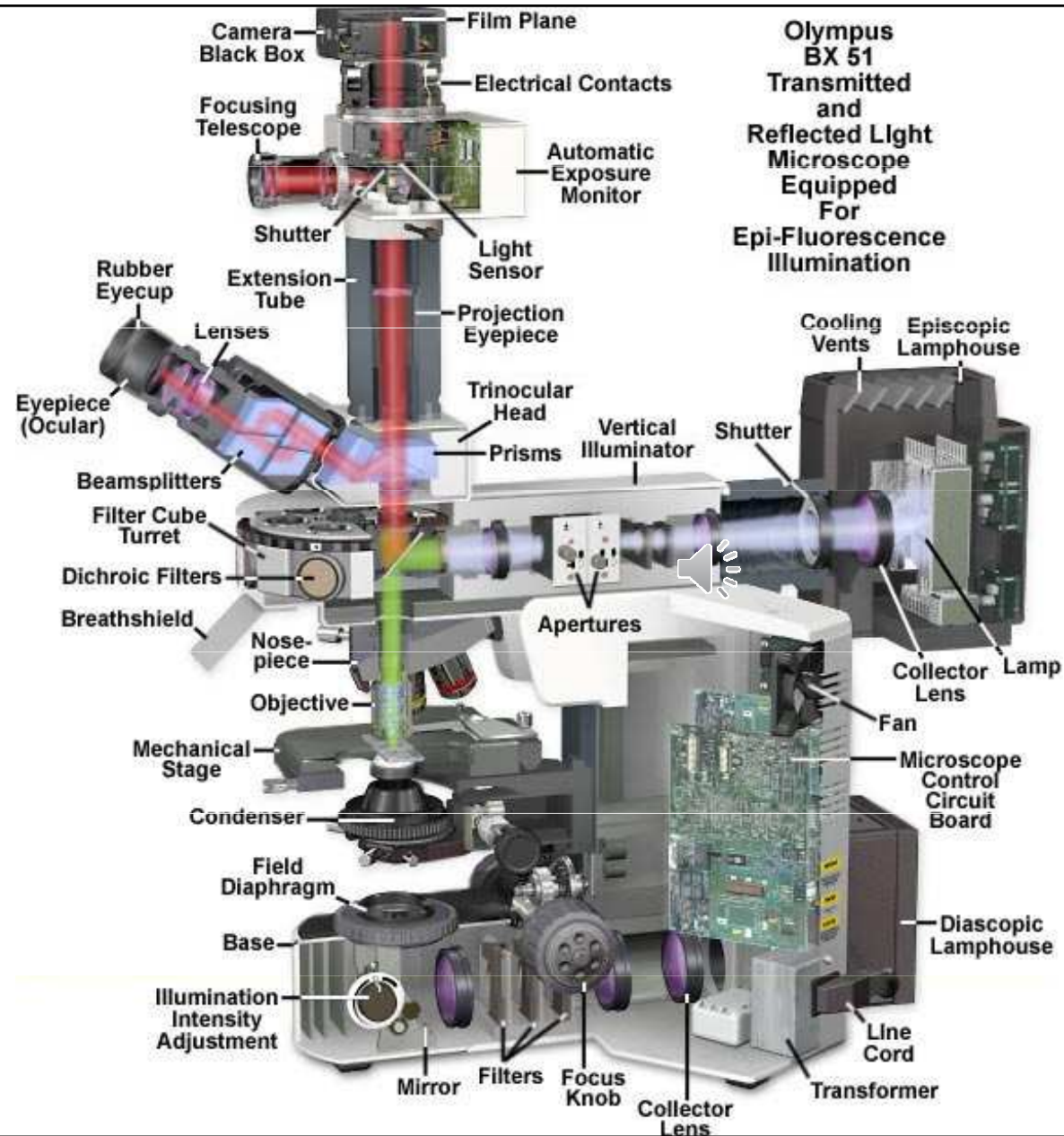

FM

Fluorescence microscope

MUNI

Fluorescence microscope

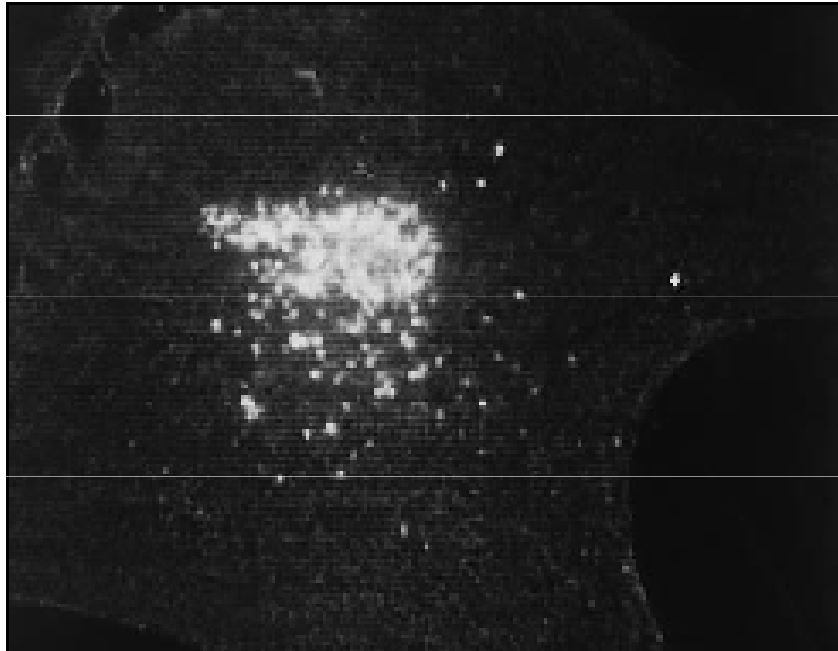

Virions in an infected cell -
<http://usa.hamamatsu.com/sys-biomedical/slc2400/slc-smpl.htm>

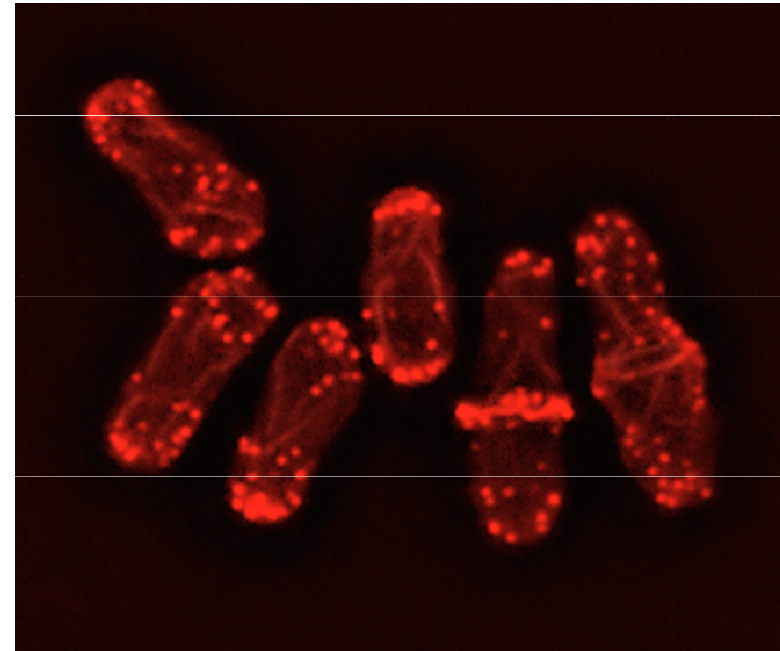

Actin fibres of yeasts visualised by fluorescence microscopy – stained by rhodamin-phalloidin

•www.paulgyoung.com/.../fission_yeast_actin_cytoskeleton.htm.

Fluorescence microscope

Cytoskeleton visualised by immunofluorescence method

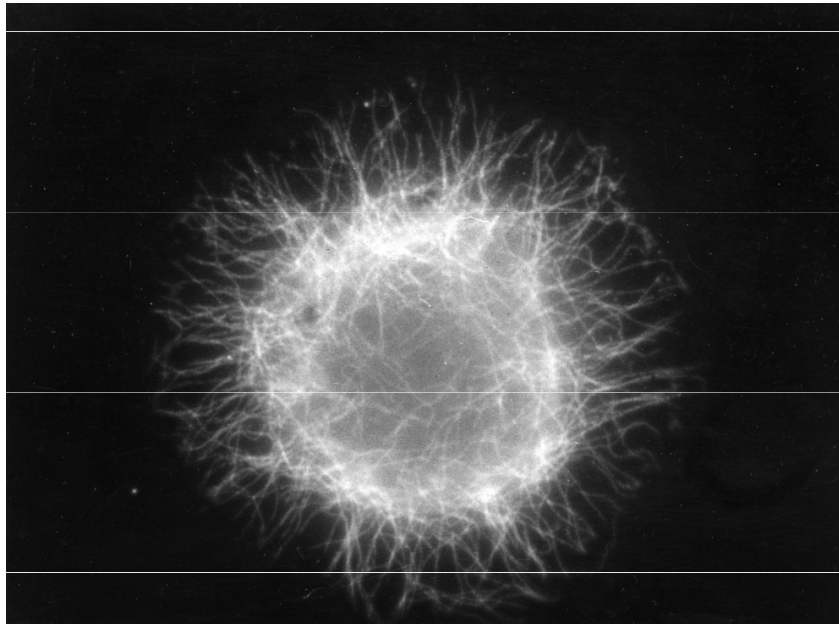

Microtubules of HeLa cells

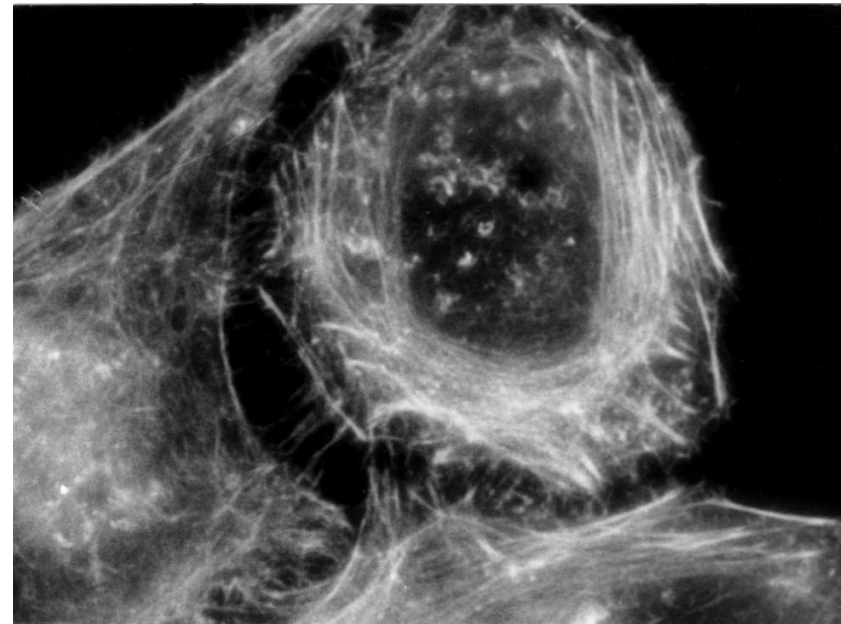

Microfilaments of HeLa cells

Confocal laser scanning microscope

Only rays reflected from point structures in the focus can pass through the diaphragm in front of the detector. Other rays (scattered) are stopped by the diaphragm. These rays would lower the image quality in a common microscope since they lower the contrast. Using this microscope, we can study relatively thick native sections. The scanning mechanism is a system of rotating mirrors which can move the focus along dense parallel lines.

L - laser, D_1 , D_2 – diaphragms with small circular openings, STM – semitransparent mirror, DET – light detector (photomultiplier), SM – scanning mechanism, OL - objective (projective) lens, F – focus (point object), SPEC – microscopic specimen.

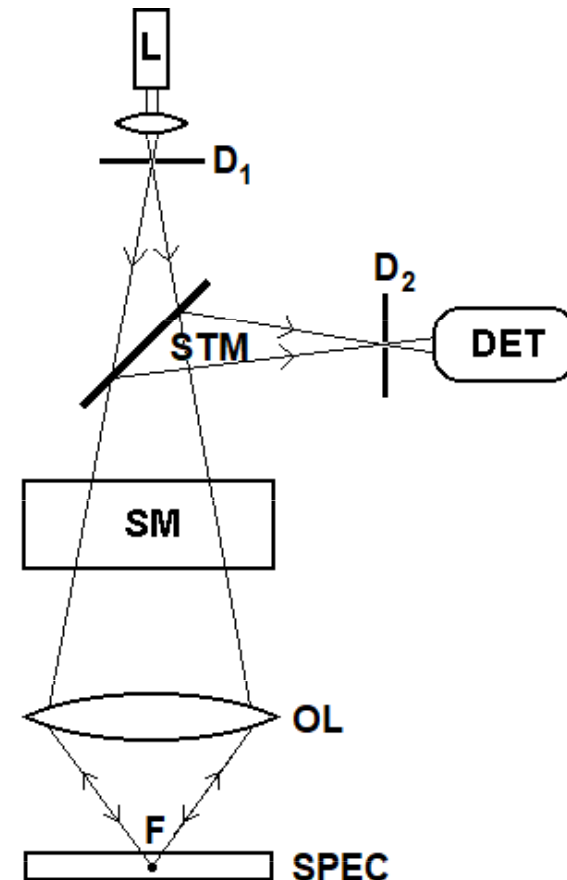

Confocal laser scanning microscope

Immunofluorescence method is often used for specification of observed structures
– to mark chromosomes, membrane receptors etc.

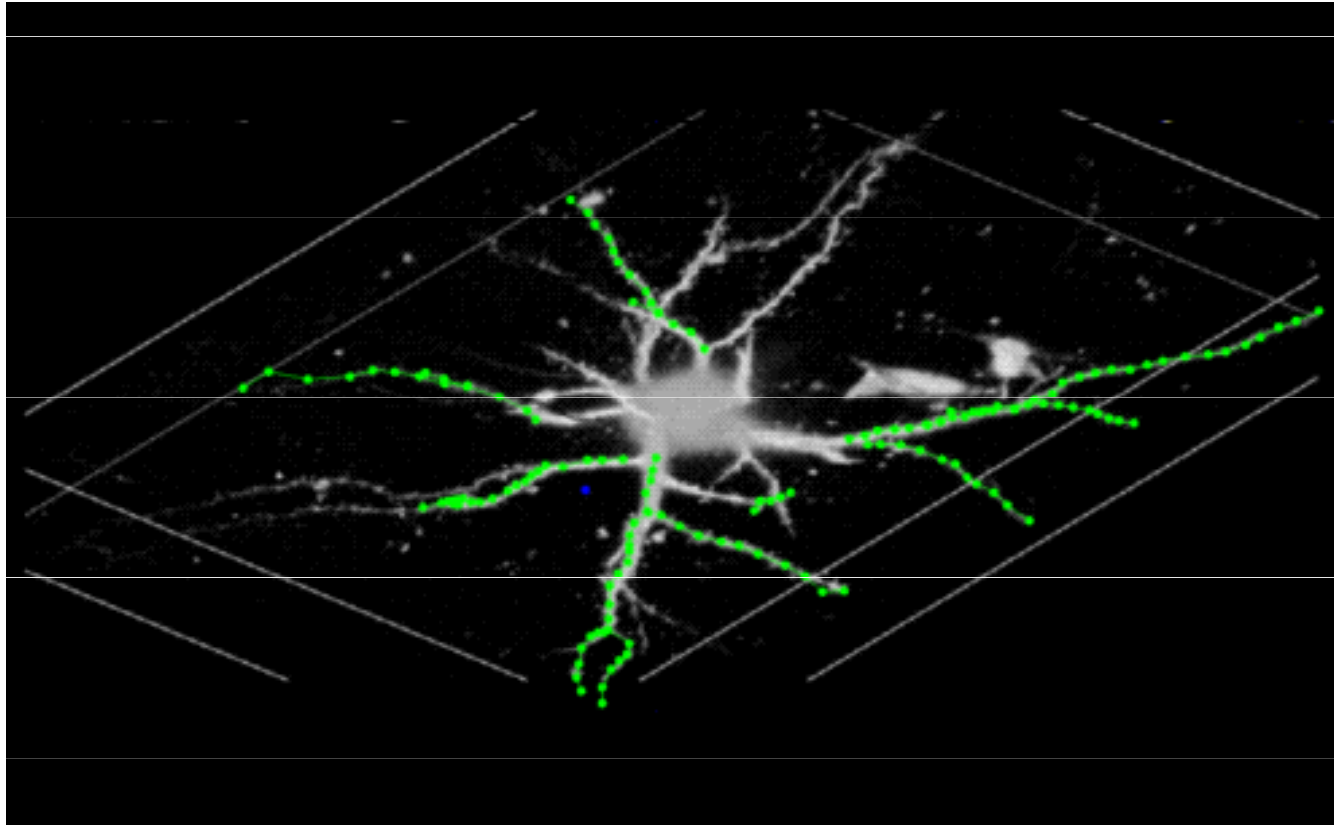

3D image of a neuron, fluorescence - <http://www.cs.ubc.ca/nest/magic/neuron.html>

Confocal laser scanning microscope

Live Cell Imaging - we can follow the growth of cell cultures in a flow-through cell in real time

We can follow direct effects of chemical or physical factors on cell cultures.

Leica SP2 AOBs microscope



Simultaneous use of an absorption spectrophotometer as a part of a confocal microscope.

Substitution of a common laser by a „white laser“, i.e. laser with tuneable wavelength of 470-670 nm, used for spectrophotometric analysis, e.g. to determine the concentration of a pharmaceutical in a sample during cell culture growth.

Superresolution – a breakthrough of the diffraction barrier

Near field optical scanning microscope

NFOSM = NSOM = SNOM

Scheme of the **near field optical scanning microscope**. A narrow beam of argon laser light passes through a very narrow opening (5 – 10 nm in diameter) in a metal-coated glass tip. A thin section moves above the opening at a constant distance. According Rontó and Tarján (1994, left).

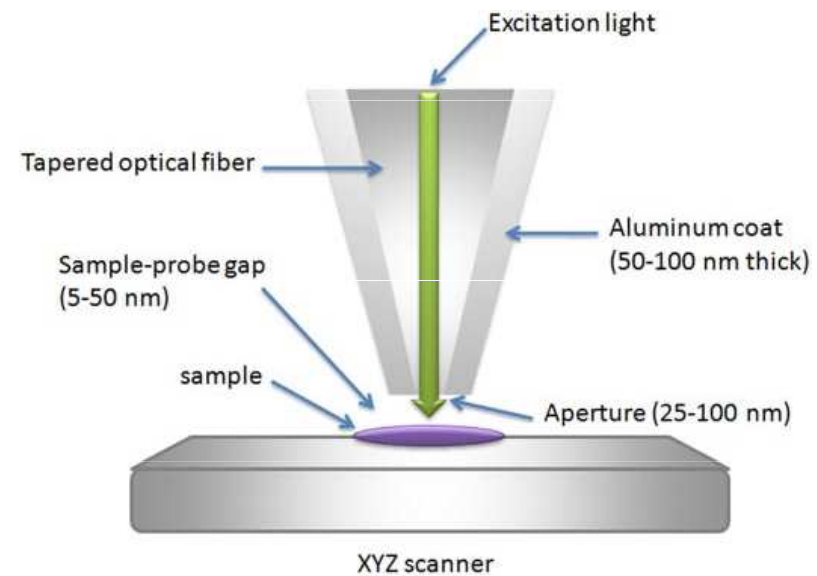
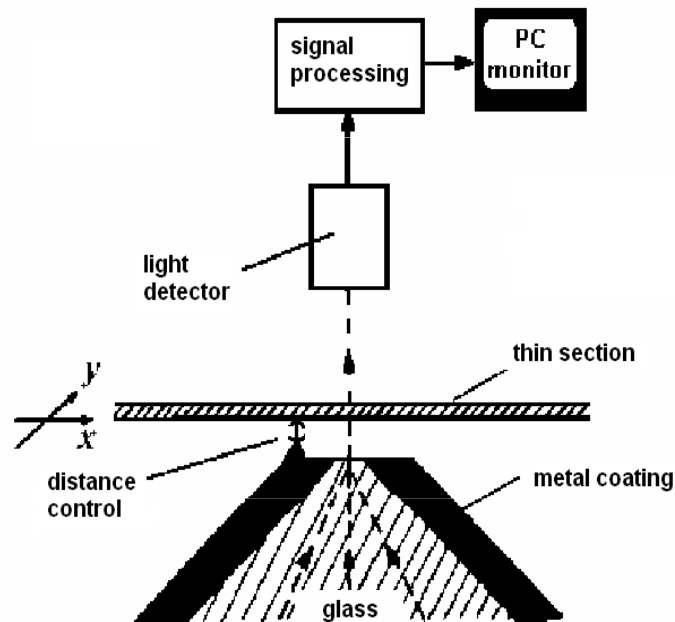

Superresolution – a breakthrough of the diffraction barrier

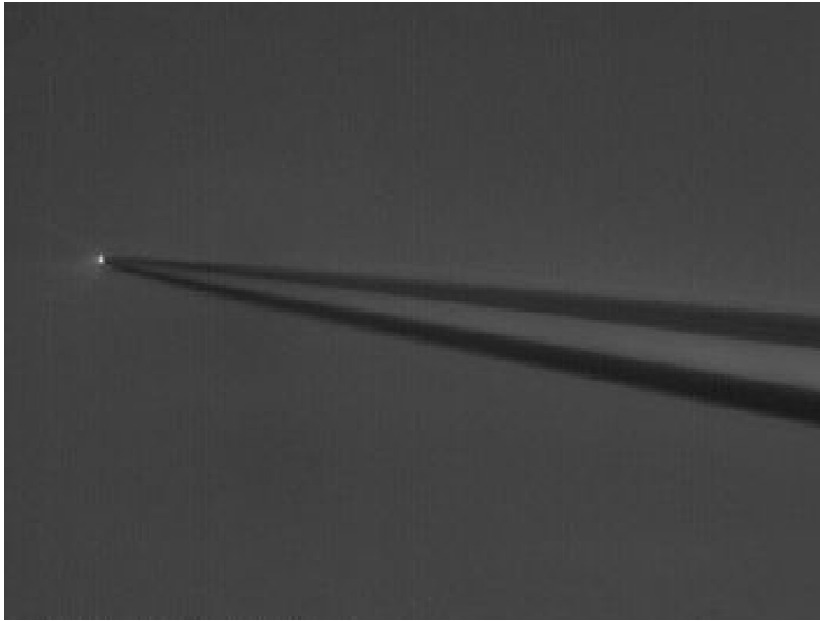

Light transmitting tip of NFOSM
seen in common optical microscope

<http://physics.nist.gov/Divisions/Div844/facilities/nsom/nsom.html>

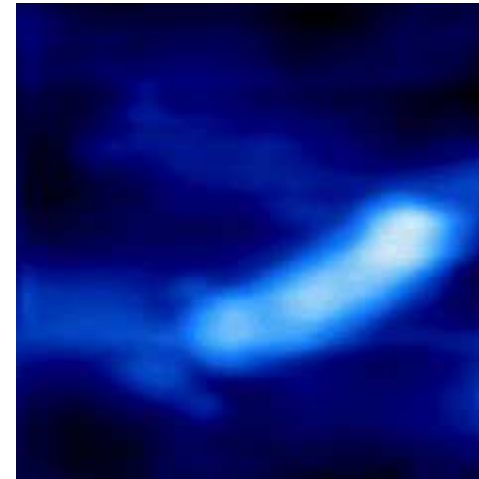

Plasmid DNA – 10 000
nucleotides

•http://www.snom.omicron.de/examples/twinsnom/x-tsnom_12.html

Superresolution – a breakthrough of the diffraction barrier

Stimulated Emission Depletion – STED (optional)

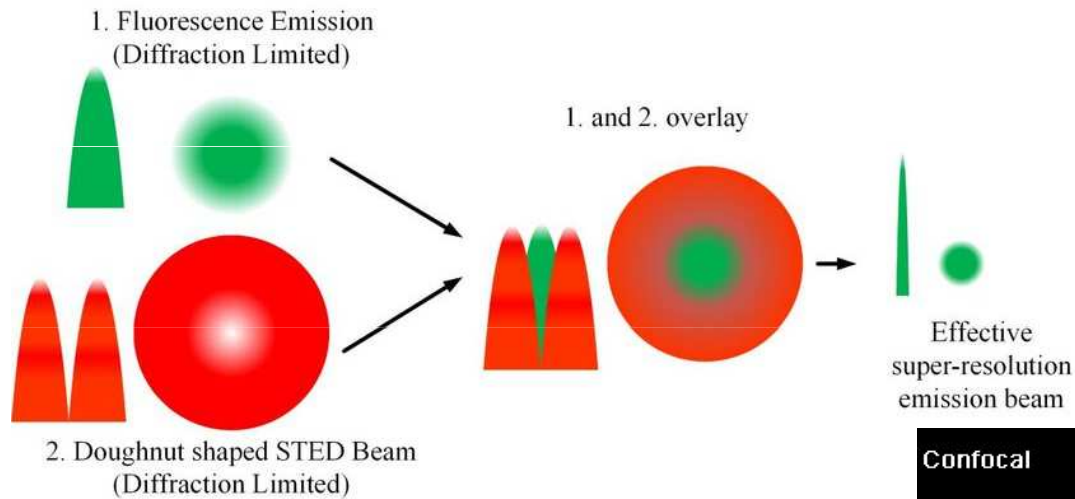

Analogy of a confocal microscope which utilises the fluorescence depletion for improvement of the resolution power – the so-called diffraction limit is reached.

Synaptické vezikuly

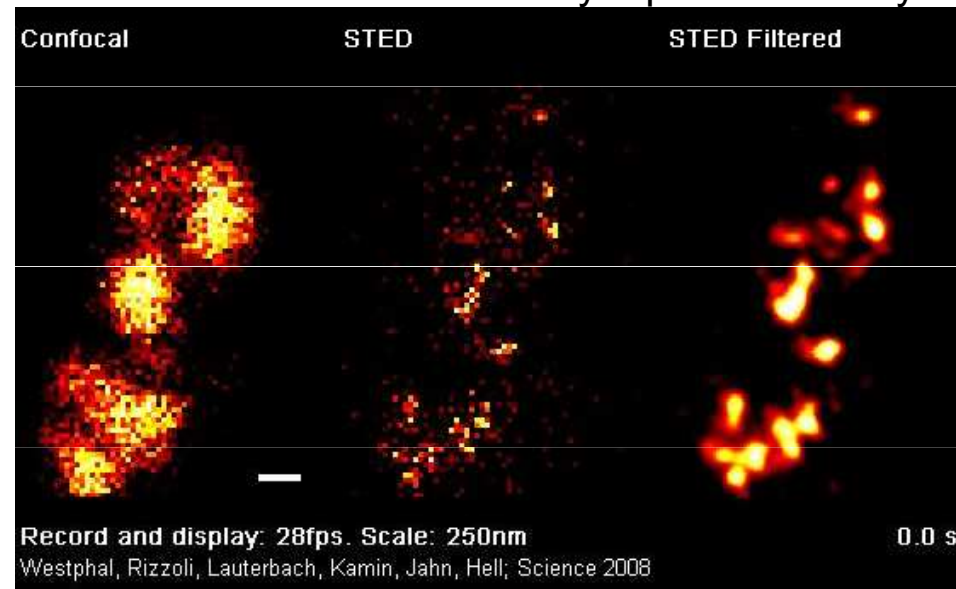

Electron microscopy

„Classical“ electron microscopes (EM) use beams of accelerated electrons for imaging. The electrons have wavelength of the so called **de Broglie matter waves**. Let us remind following formulas:

$$\lambda = \frac{h}{mv} \qquad eU = \frac{1}{2}mv^2$$

λ is the wavelength, h Planck constant, m relativistic mass of electron, v its velocity, e – its electric charge and U the accelerating voltage. When the size of observed objects is comparable with λ , diffraction occurs, and the image formation is disabled. An electron with energy of 1.5 eV has the wavelength of 1 nm. When using accelerated electrons, about 10^5 -times shorter λ can be reached. Remind $\delta = \lambda/n \cdot \sin\alpha$. However, big optical aberrations of the optical system cause the numeric aperture is very small - in the order of 10^{-2} . EM resolving power is several tenth of nm in practice.

Electron microscopy

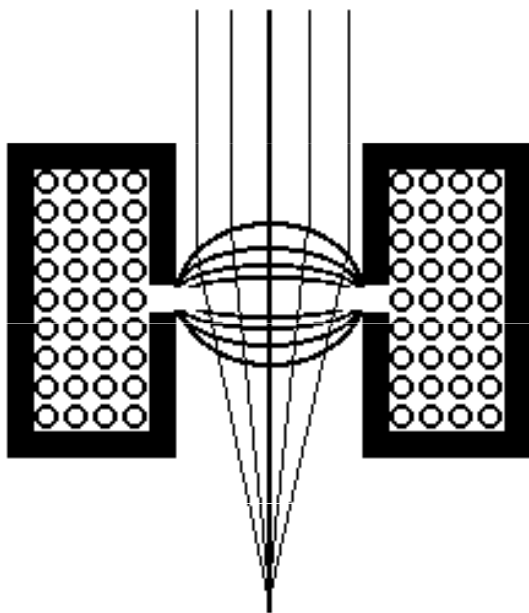

Magnetic lens

Transversal section of a coil which is magnetically shielded by cladding. The electron beam is focused in the place where is a gap in the cladding. The magnetic lens acts as a converging lens for electrons.

TEM – transmission electron microscope

according to:

<http://www.vetref.net/emscope/theorysch.html>

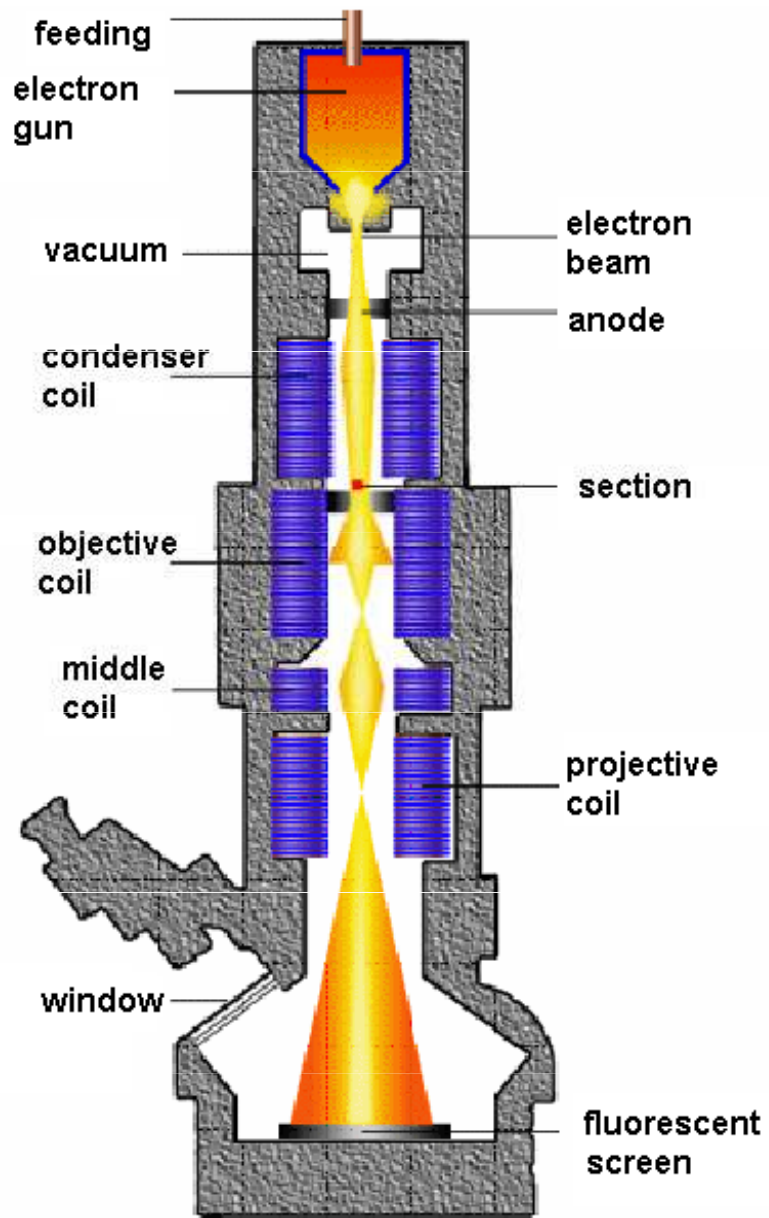

Transmission electron microscopy



Brookhaven TEM

Magnification 50 000 000x,
resolution 0.1 nm,
X-ray spectrophotometry for
chemical analysis is simultaneously
possible.

TEM – preparation and staining of sections

- The need of very thin sections (max. hundreds of nm) and positioning of the sections in vacuum requires special methods of preparation. Native (wet) sections can be observed only by modern environmental EM in which the sections are located in a relatively high pressure medium.
- The biological materials must be prepared by means of a special fixation – impregnated by different substances (epoxy resins) before cutting.
- The biological specimens are often metal-coated in vacuum from the side so that a „shadow“ appears behind the elevated parts of the specimen.
- To increase the scattering of electrons in the specimen, salts or oxides of heavy metals (osmium, tungsten, uranium) are used.

TEM – preparation and staining of sections

(optional)

- **Kryofixation** = an attempt to replace slow chemical fixation by faster fixation by freezing
- Rapid freezing of a native sample under high pressure (MPa) and temperature of liquid nitrogen (-190 °C)
- Disadvantage: the samples have to be manipulated using cooled devices (from –190°C to – 4°C), TEM is cooled by liquid nitrogen.

- **Freeze-etching method:** metallic replicas of surfaces of cellular membrane structures are prepared
- The sample is fractured in high vacuum (10^{-5} Pa) at temperature of –100°C.
- The exposed structures are coated by a thin layer of a heavy metal (Pt, Ta) under the angle of (45°), so that a „shadow“ appears behind the elevated parts of the specimen.
- A layer of carbon is added under an angle of 90°, which is necessary for fixation of the metallic structures
- Total layer thickness is about 25 nm
- Biological material is then removed chemically

Transmission electron microscope Section vs. replica

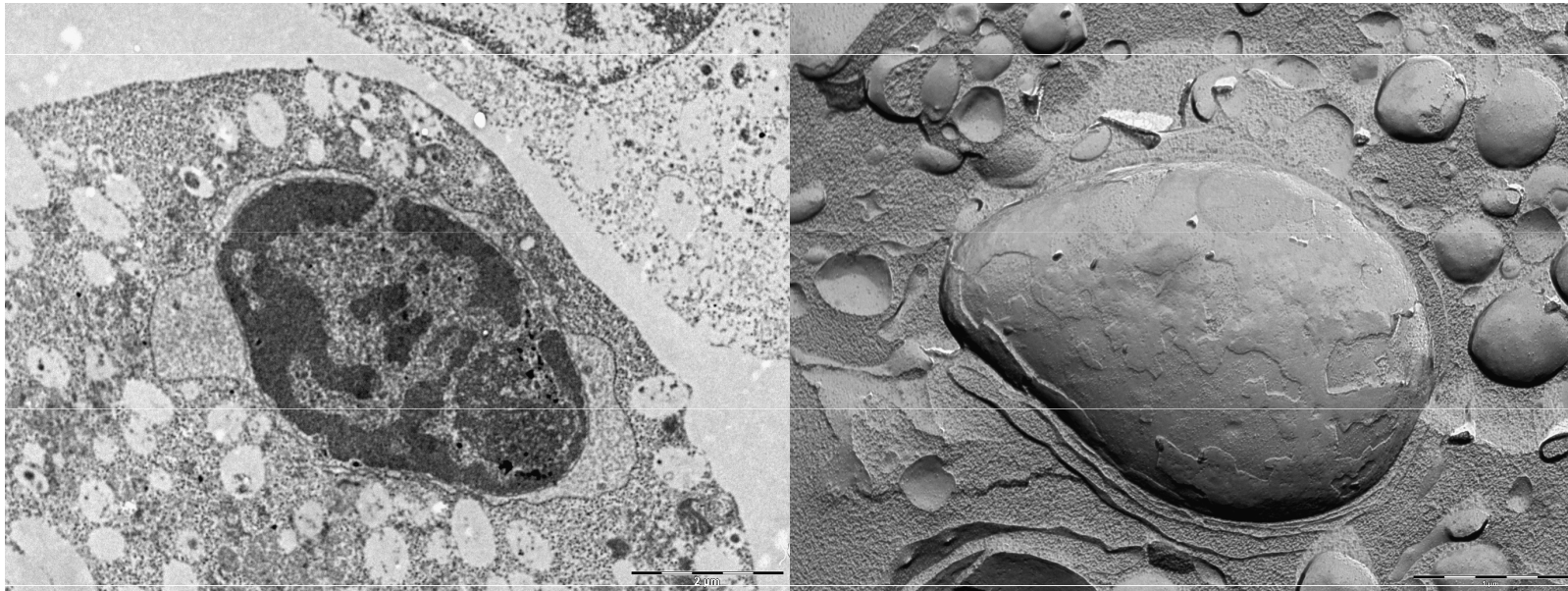

HL-60 cells, fragment of nucleus, morphological changes during apoptosis.

Left picture – ultrathin section, OsO_4 contrast.

Right picture - replica, coating by a layer of Pt and C.

Obtained using TEM MORGAGNI 268 D (Philips), recorded by a CCD camera.

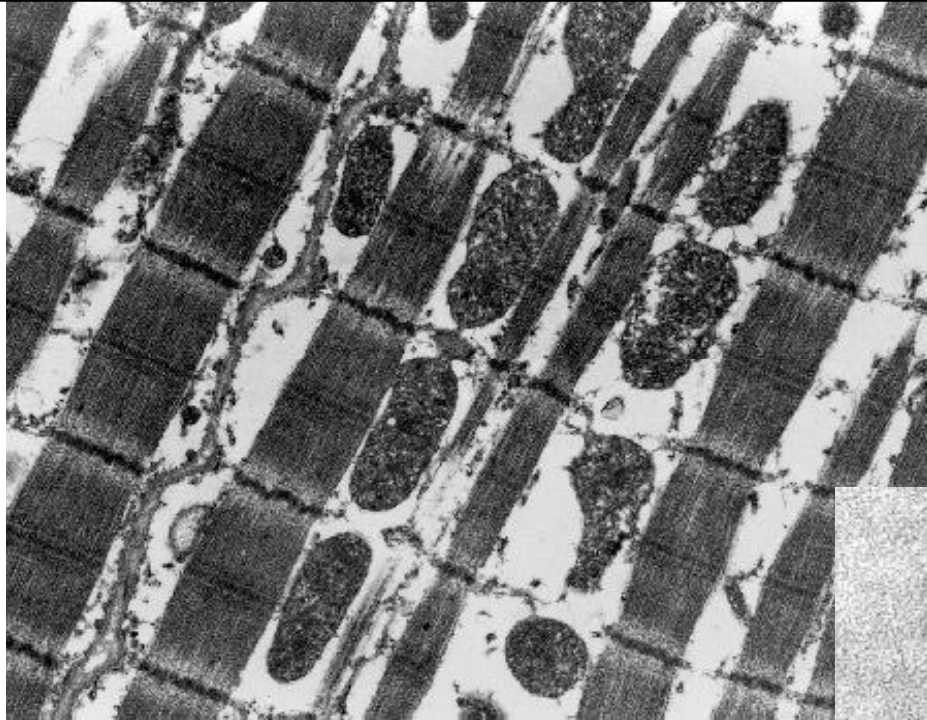

TEM

<http://www.ualberta.ca/~mingchen/tem.htm>

Cells of abdominal muscle ↑

Corona virus, negative staining →

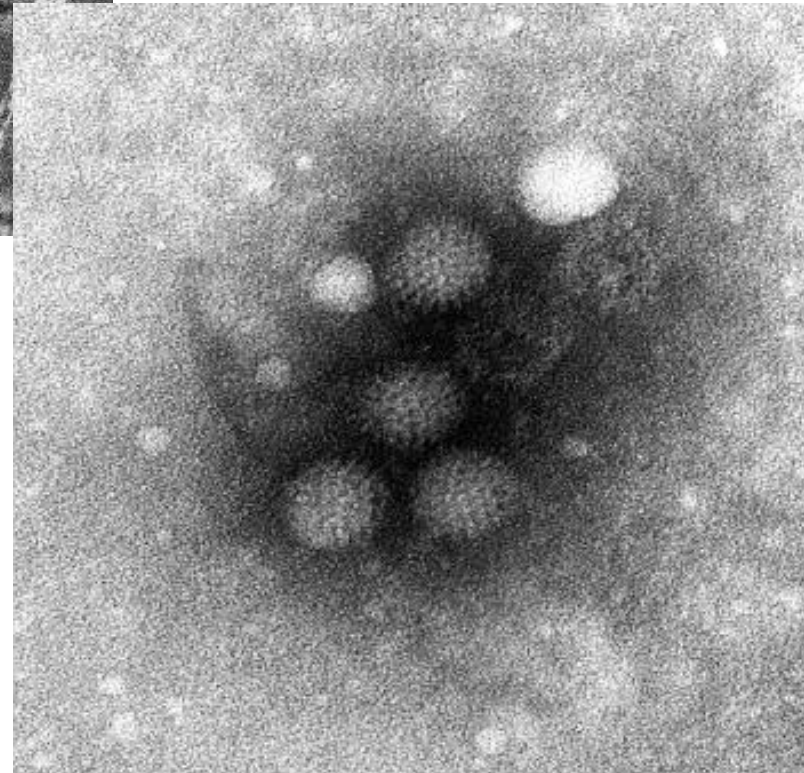

MUNI

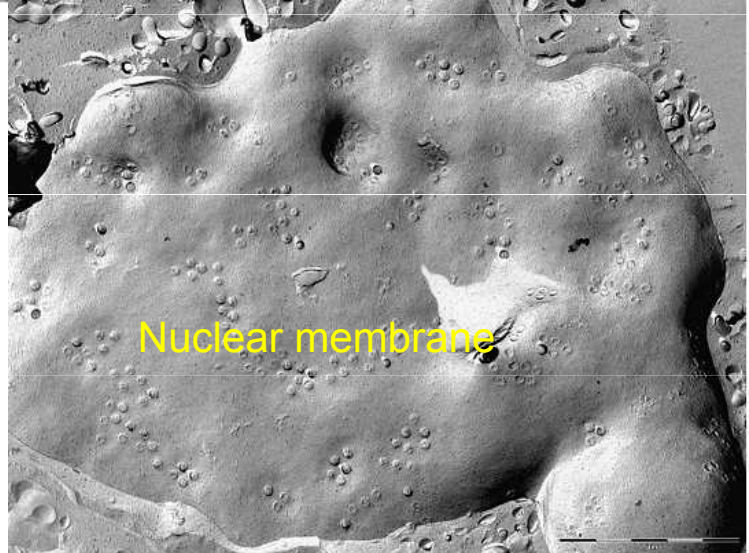
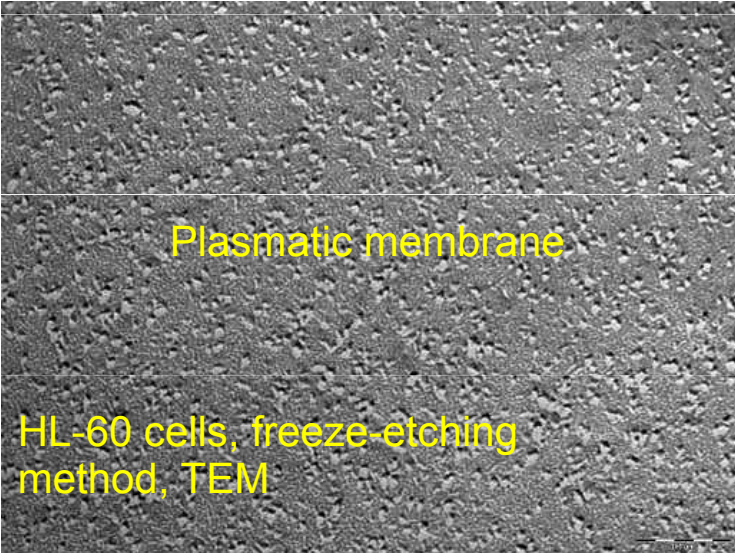
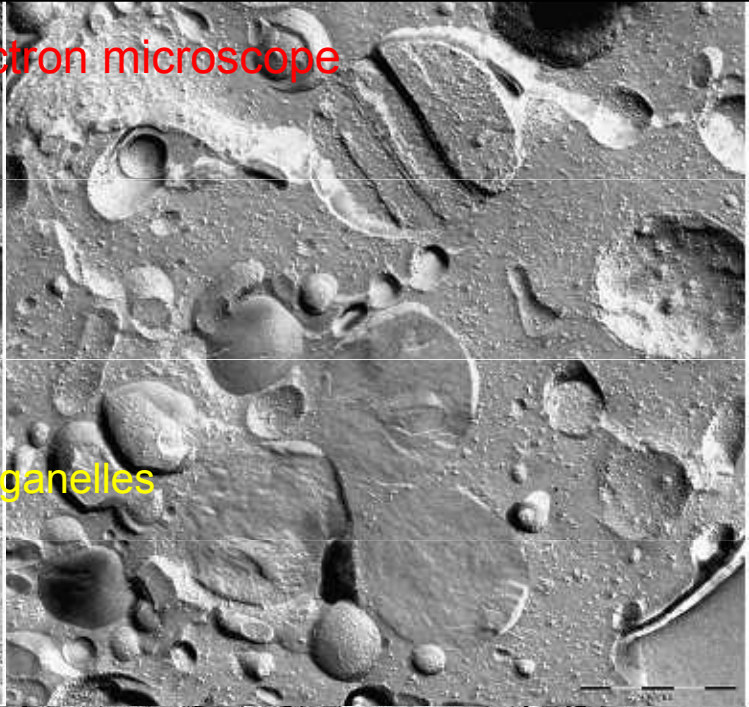
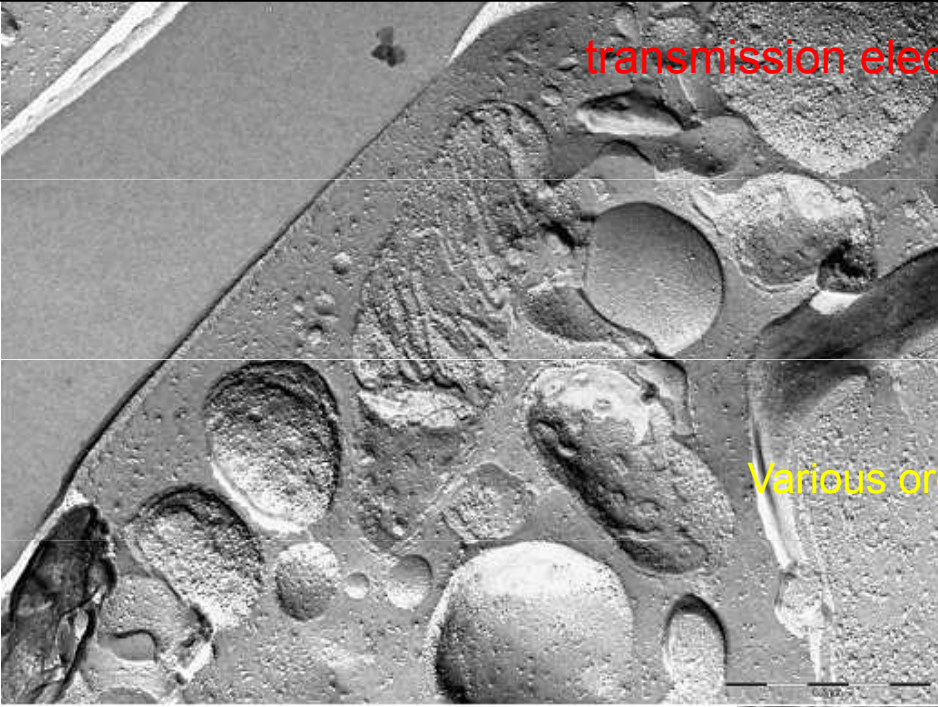

Scanning electron microscopy

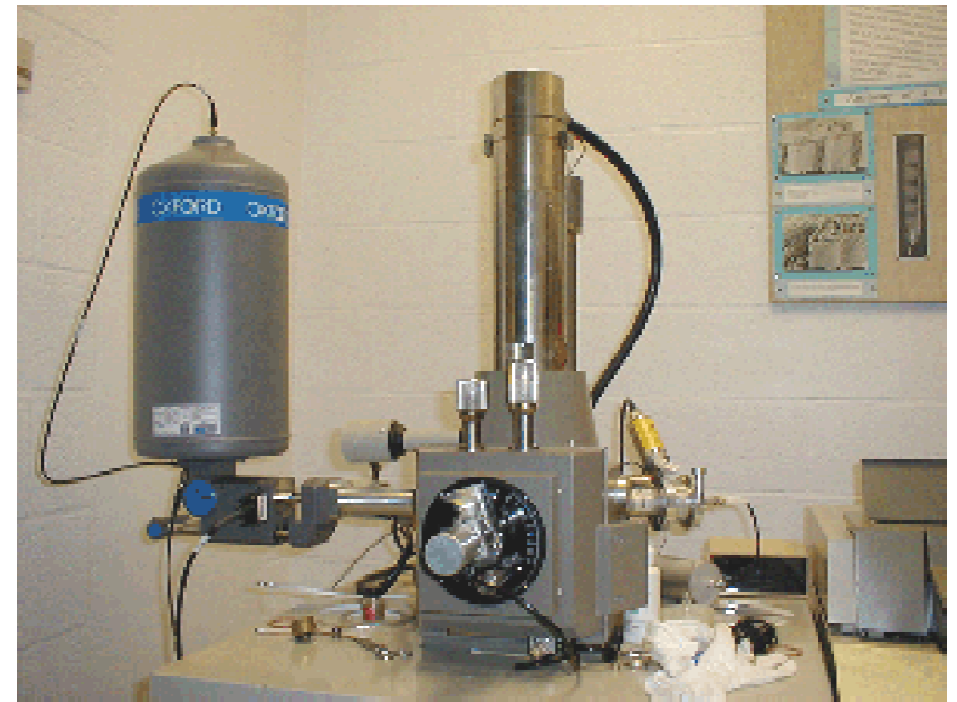

Scanning electron microscopy - SEM

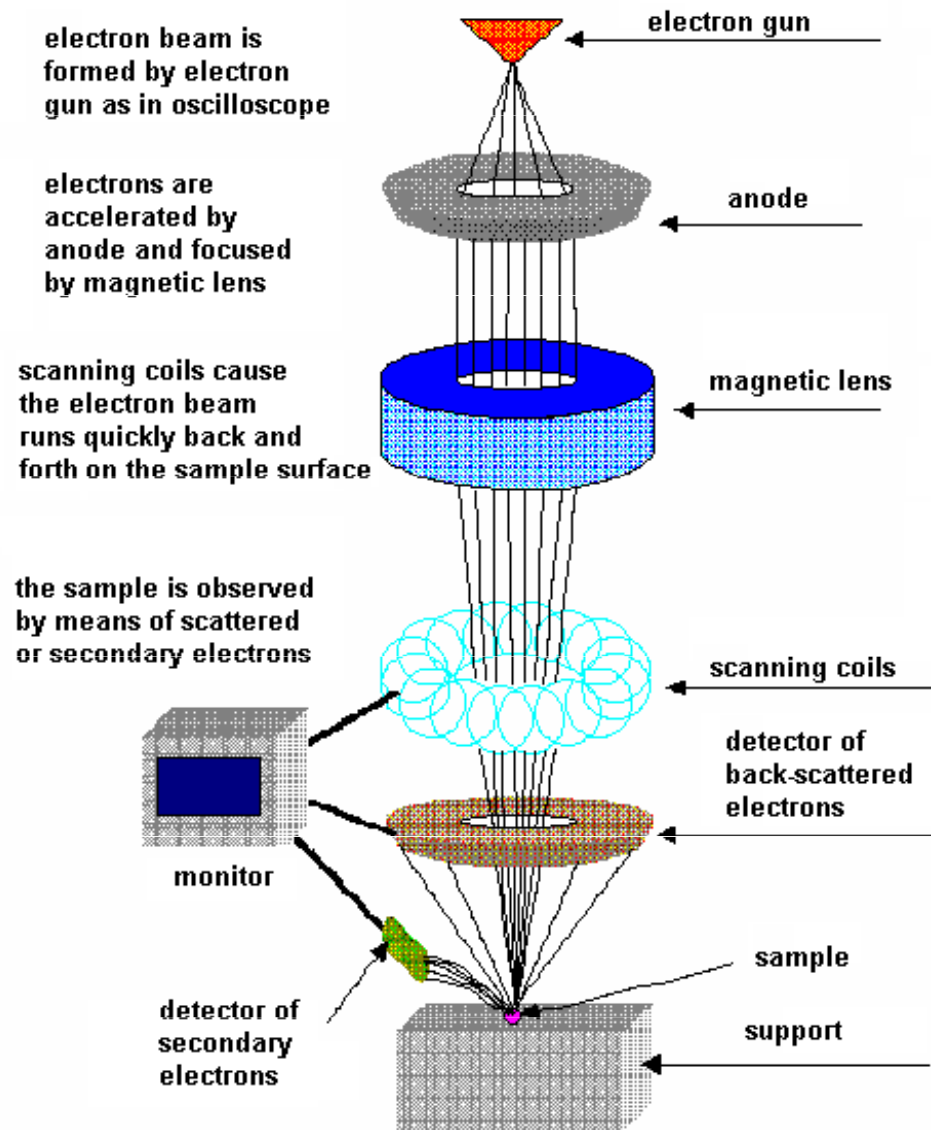

According to:
<http://www.rpi.edu/dept/materials/COURSES/NANO/shaw/BigSEM.gif>

Similarly to the TEM method, the specimens for SEM are also prepared in very complex way. They must be covered by thin metallic layer since their surface must be electrically conductive.

Scanning electron microscopy

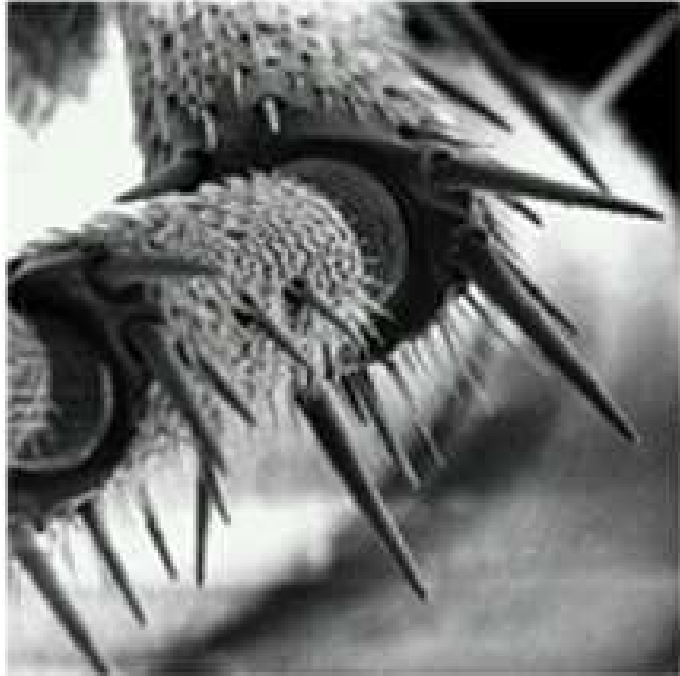

Ant leg detail in SEM -

<http://www.wtn.org/ss/story.phtml?storyId=33&type=EdOutreach>

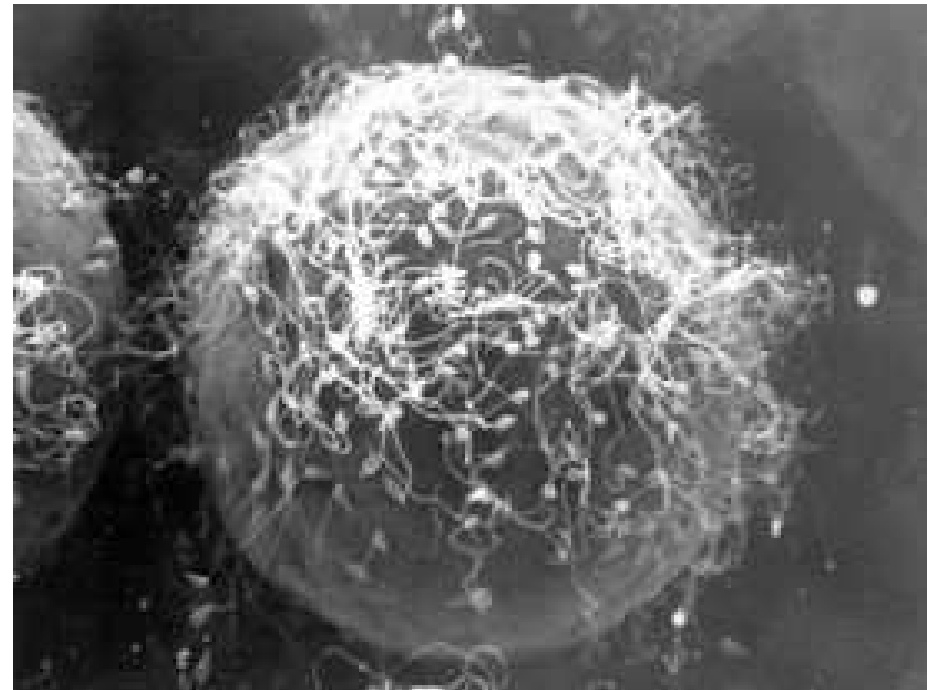

•Sea urchin egg surrounded by spermatozoa, SEM 3000x magnified -

<http://www.stanford.edu/dept/news/report/news/august9/sperm-89.html>

Scanning probe microscopy

Scanning tunnelling microscope (STM)

Scheme of the Scanning tunnelling electron microscope (STM). Detail of the metallic detecting needle can be seen below. The positively charged needle copies the sample surface. According to Rontó and Tarján (1994).

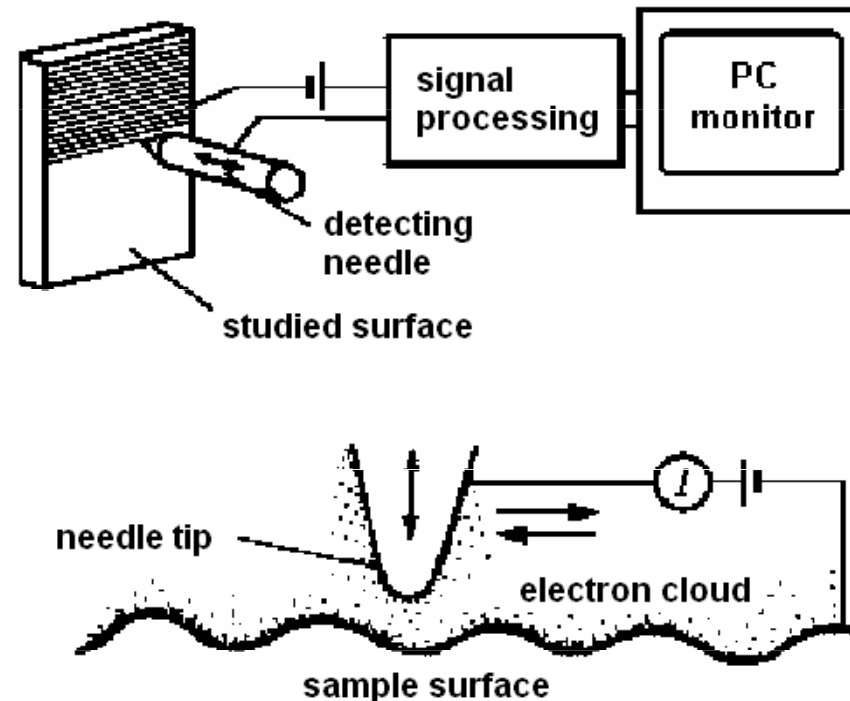

Scanning Tunelling Microscopy

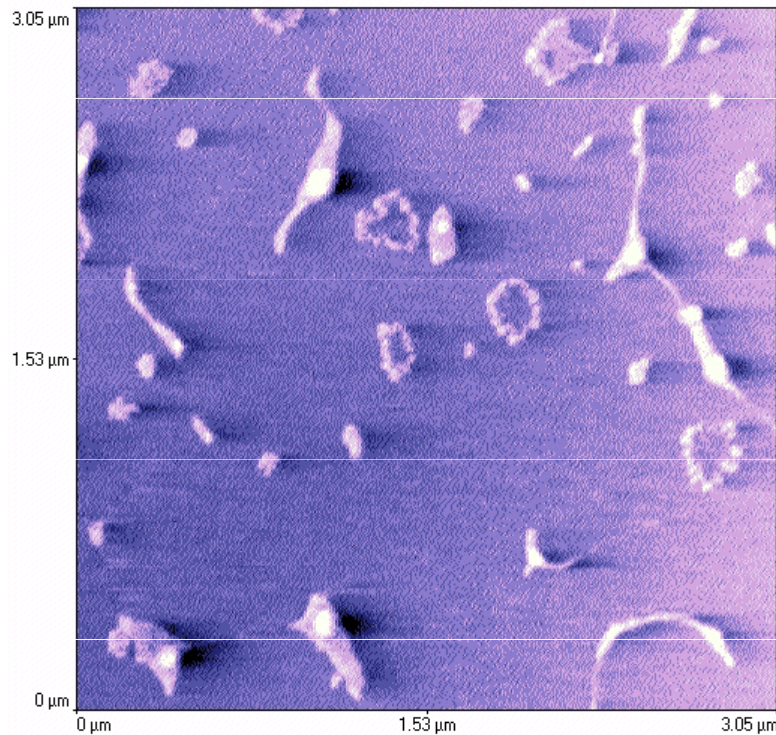

Split and intact circles of plasmid DNA

•<http://www.sci.port.ac.uk/spm/overfig5.htm>

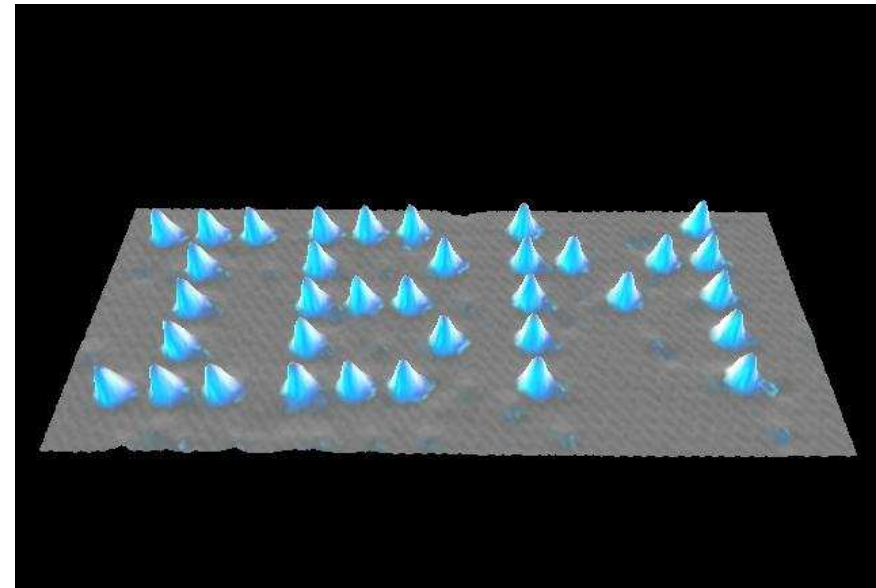

Letters IBM created from atoms of xenon on nickel support

<http://www.almaden.ibm.com/vis/stm/images/stm10.jpg>

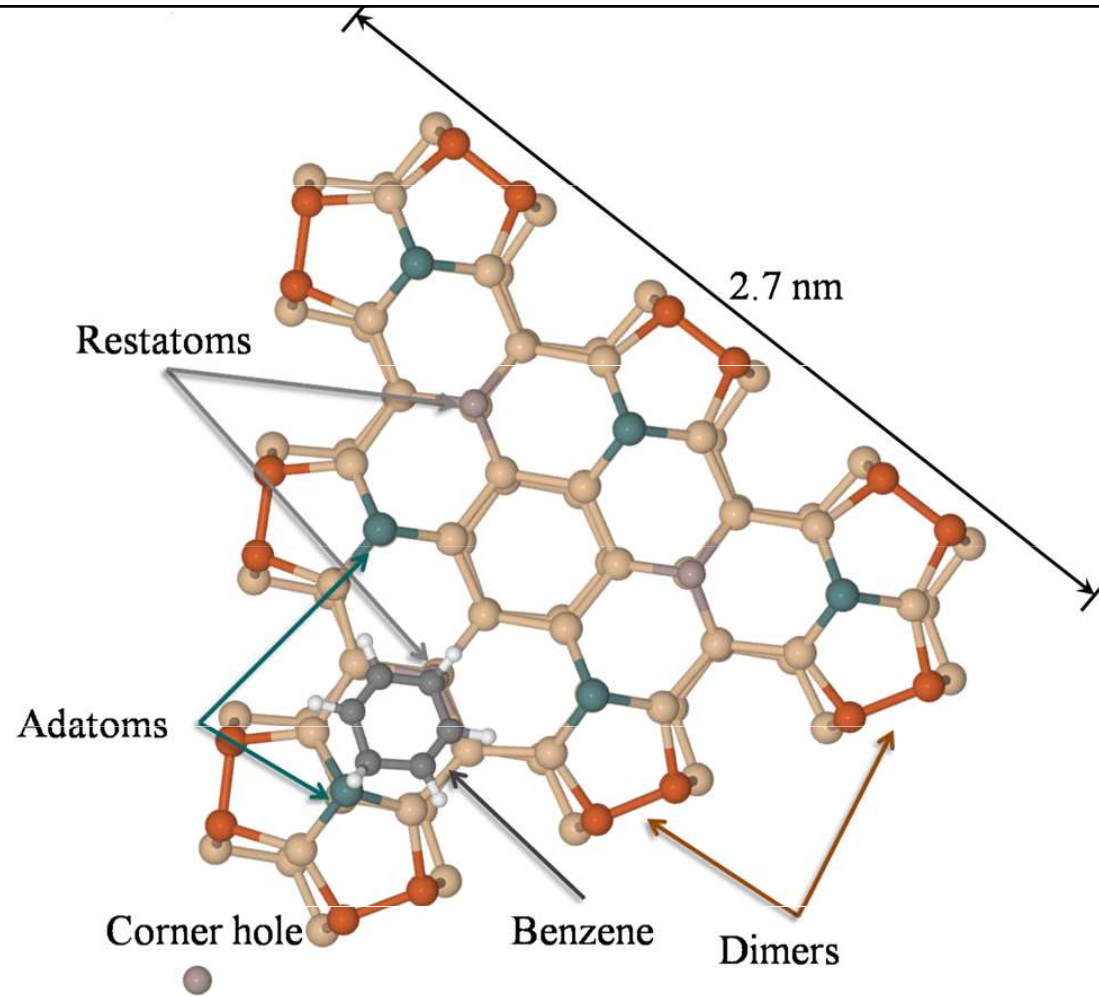

Top view

STM – Simulation of the silicon with the bound benzene molecule. This structure will be compared with the structure found experimentally.



The modern STM (and AFM) microscopes enable to verify complex molecular or crystalline structures which is of extraordinary importance for nanotechnologies in construction of computer chips.

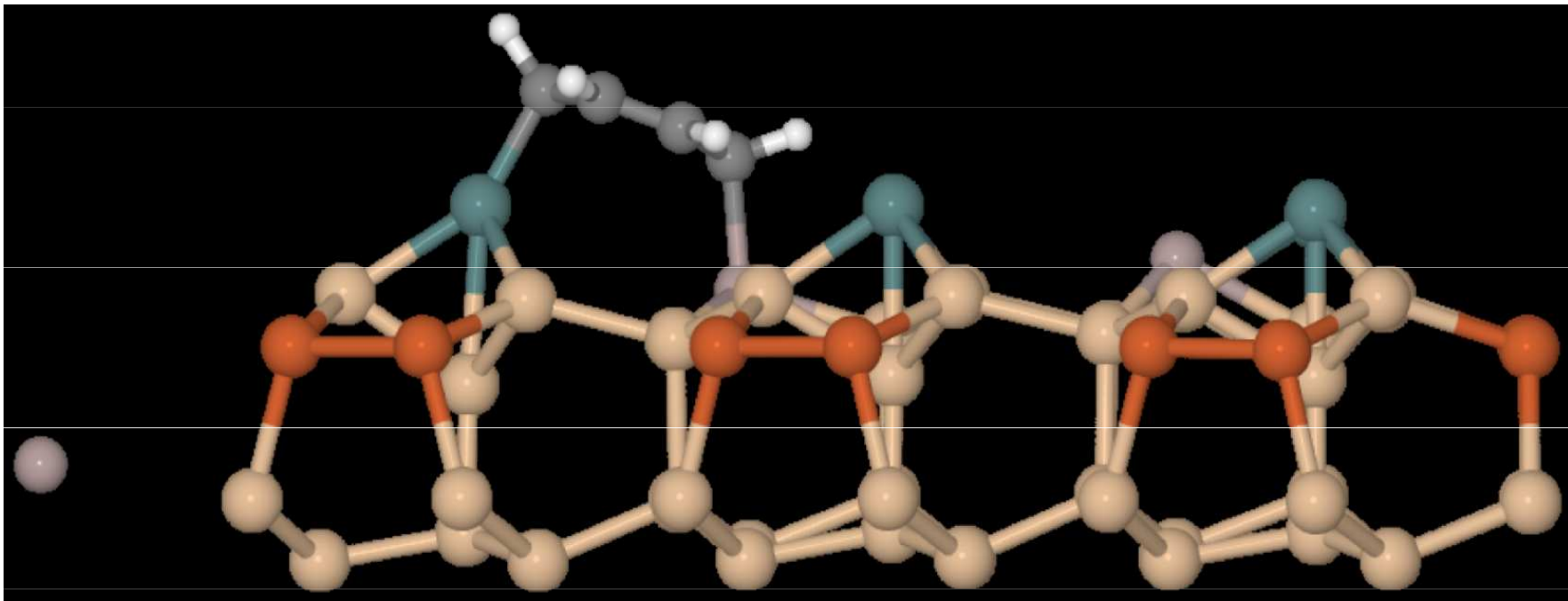

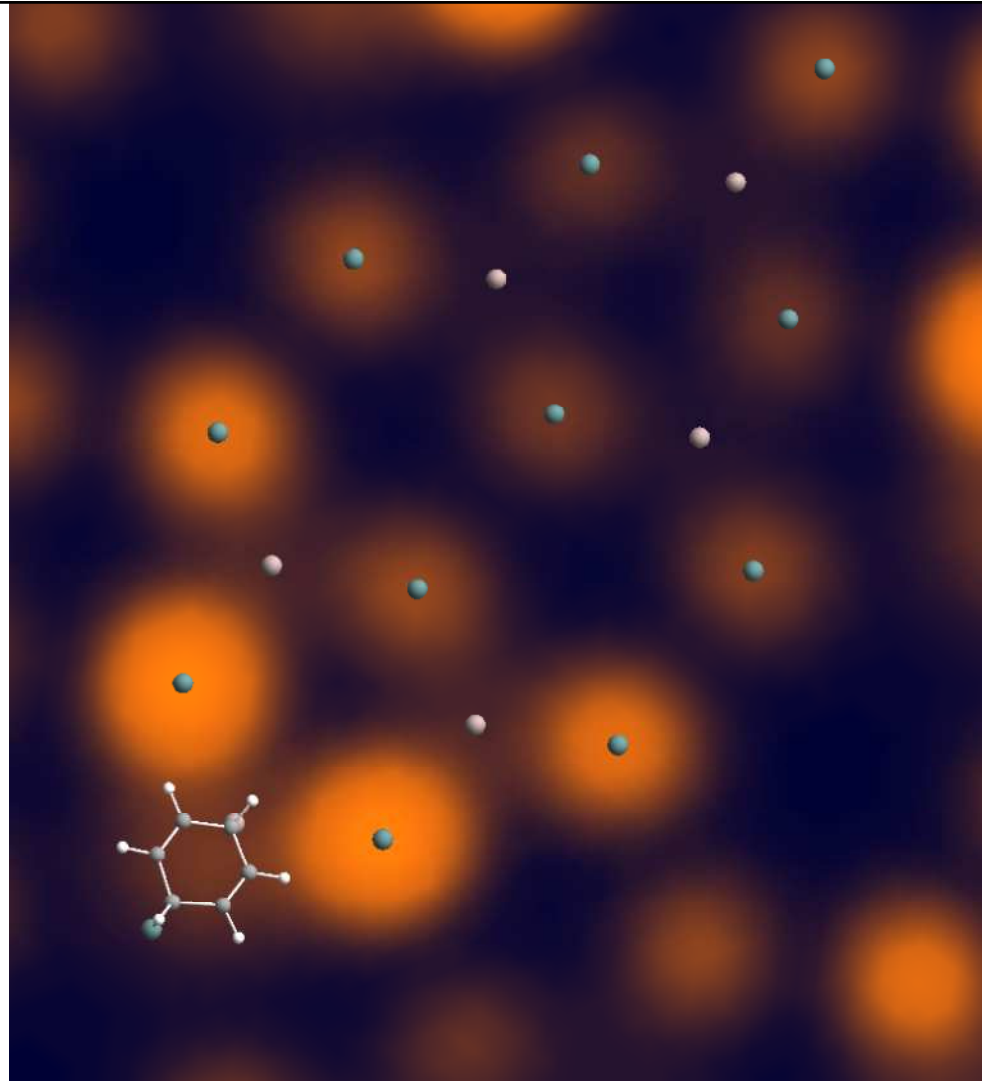

STM – Experimental data (image) with marked positions of silicon atoms and benzene molecule.

Atomic force microscopy

- AFM – Atomic force microscopy – a fine metallic tip follows the surface profile

- <http://physchem.ox.ac.uk/~rgc/research/afm/afm1.htm>

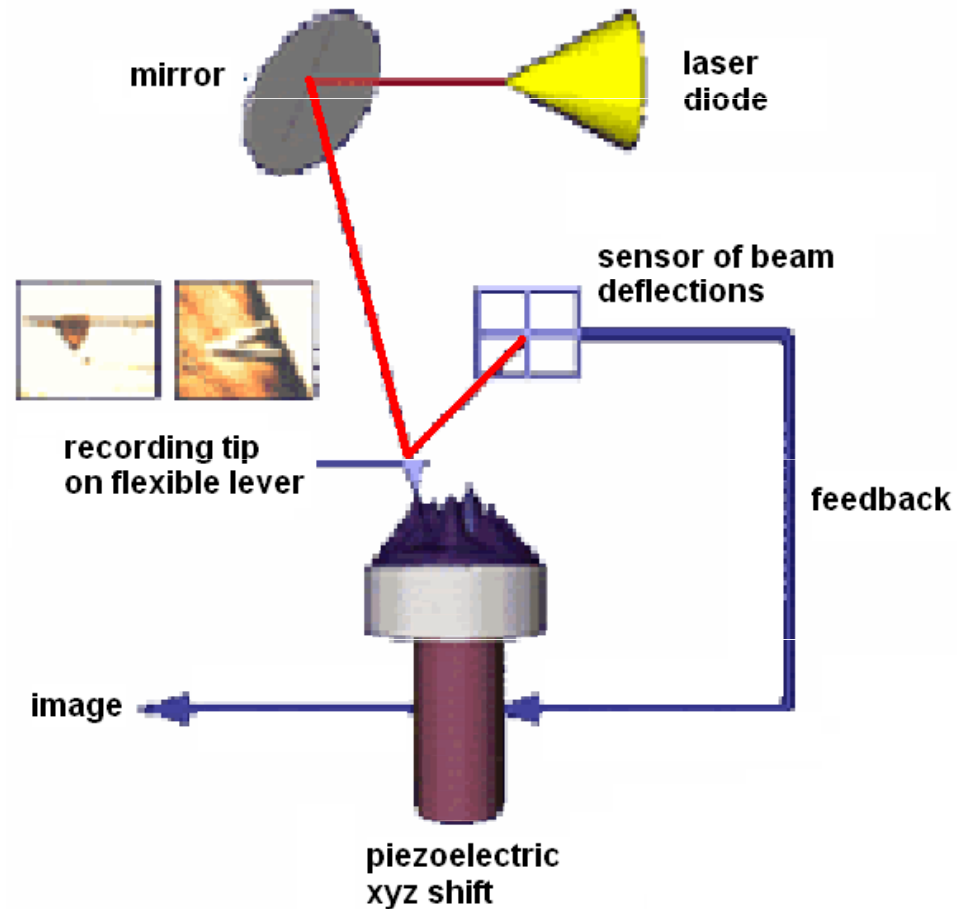

Atomic force microscopy

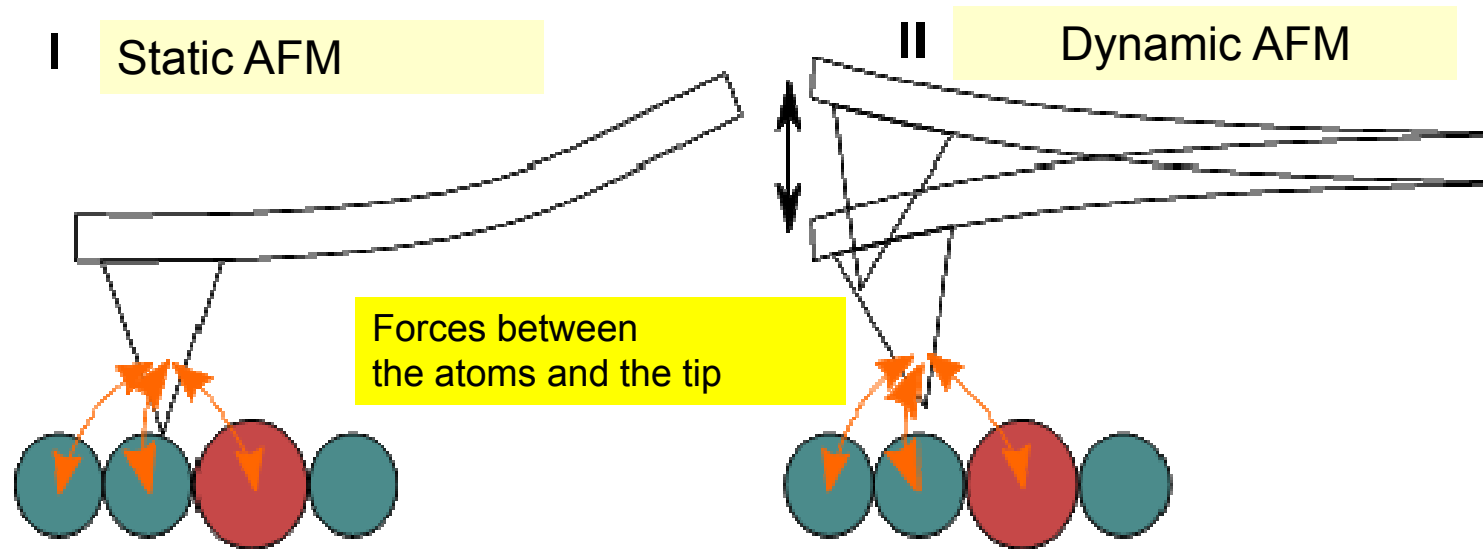

Courtesy of O. Krejčí

AFM – Atomic Force Microscopy

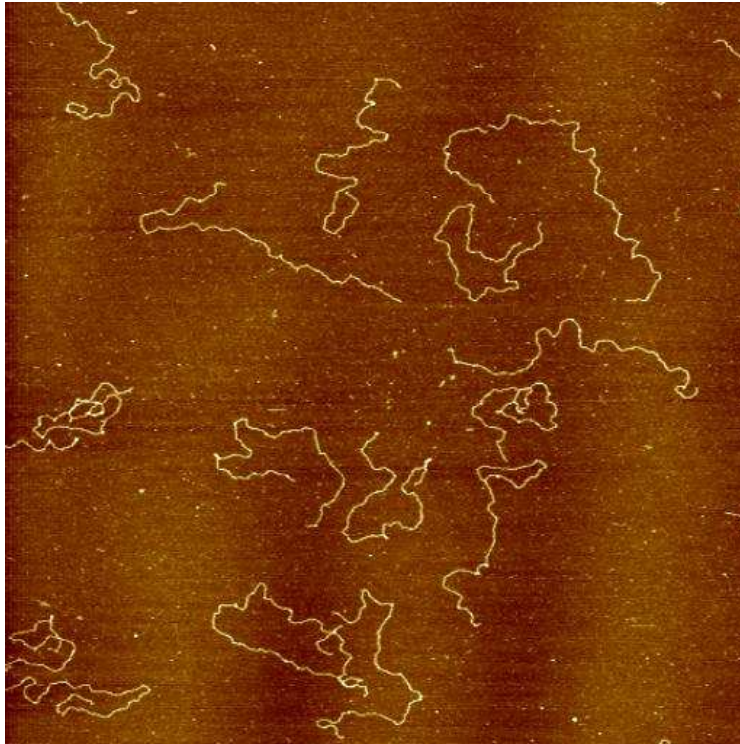

DNA image from AFM -

<http://spm.phy.bris.ac.uk/research/DNA/images/dna2.jpg>

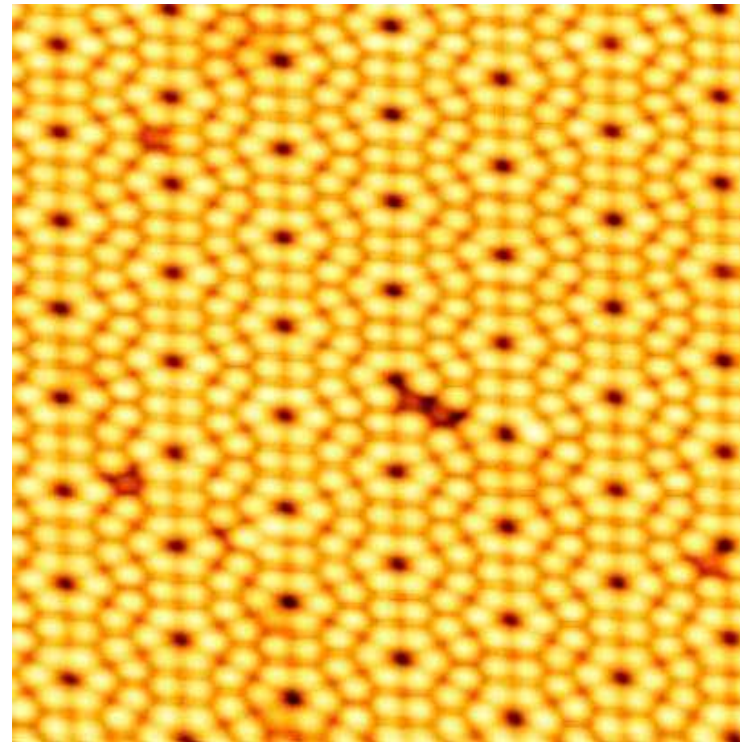

Surface of silicon – atomic resolution
incl. benzene molecules

Courtesy of O. Krejčí

4K Ultra-high-vacuum microscope

Iron Phtalocyanine on Gold (111) surface

Scanning Tunnelling
Microscopy

FePC metallic tip

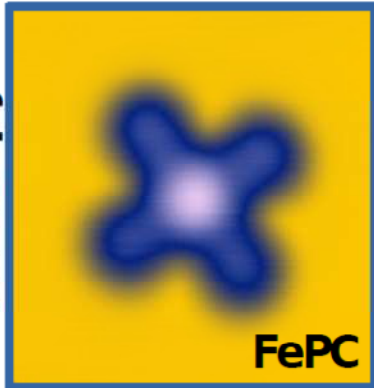

Possible,
but not-recorded

de la Torre et al. PRL 119,
166001 (2017)

frequency modulation
non-contact
Atom Force Microscopy

FePC CO-tip (flexible)

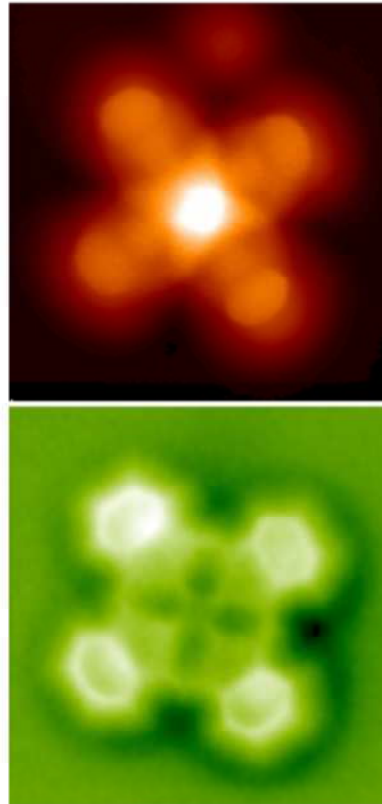

Theoretical
simulations
CO-tip

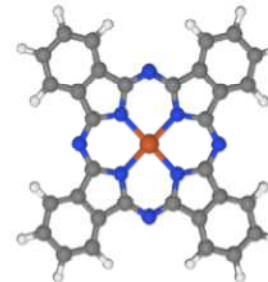
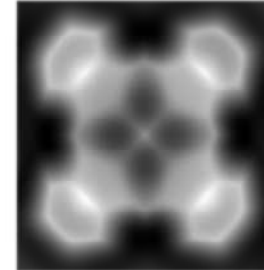
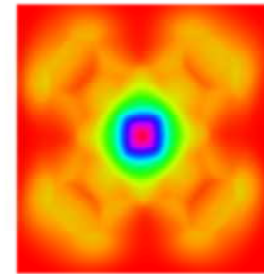

Structural
studies
using STM
and AFM

M U N I

Acoustic microscopy

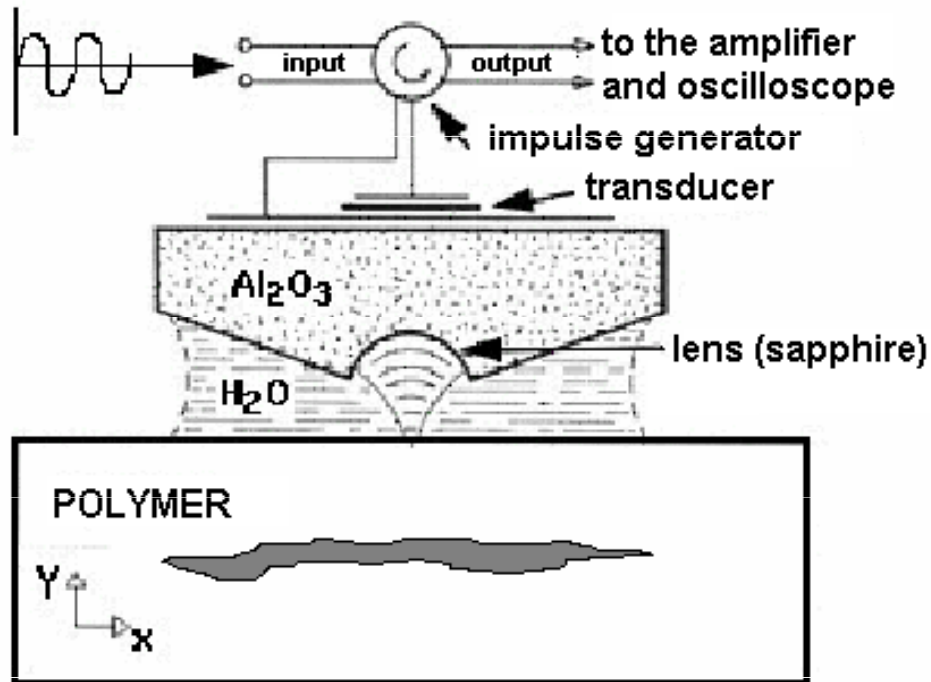

•According to:
http://www.sv.vt.edu/comp_sim/sam/full.gif

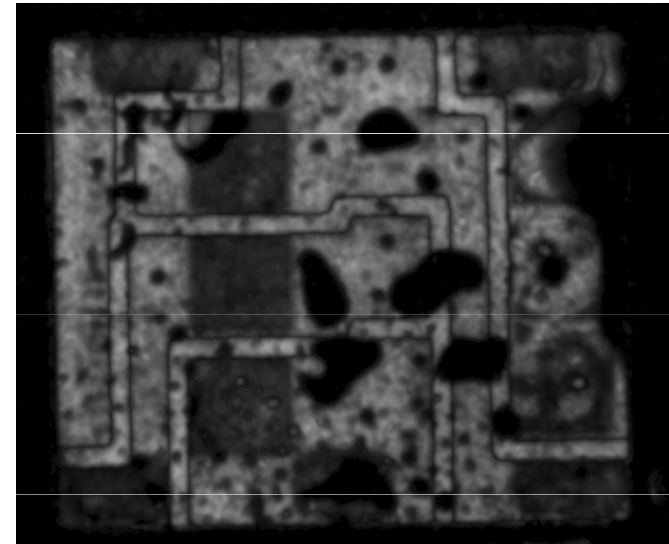

Acoustic scan of a chip with internal impairment

<http://www.predictiveimage.fr/en/applications/78/analyse-de-defaillance-pont-de-diodes-defectueux-microscopie-acoustique/>

M U N I

Authors:

Vojtěch Mornstein, Daniel Vlk,
Naděžda Vaškovicová

Content collaboration and language revision:

Carmel J. Caruana

**Last revision November 2021, soundtrack
addition December 2020**