

M U N I

M E D

4

Synapse a integrace informace na synaptické úrovni

Udržovací aktivity

Cytoplazma

- ✓ ...
- ✓ Syntéza
- ✓ Transport
- ✓ ...

Neuron

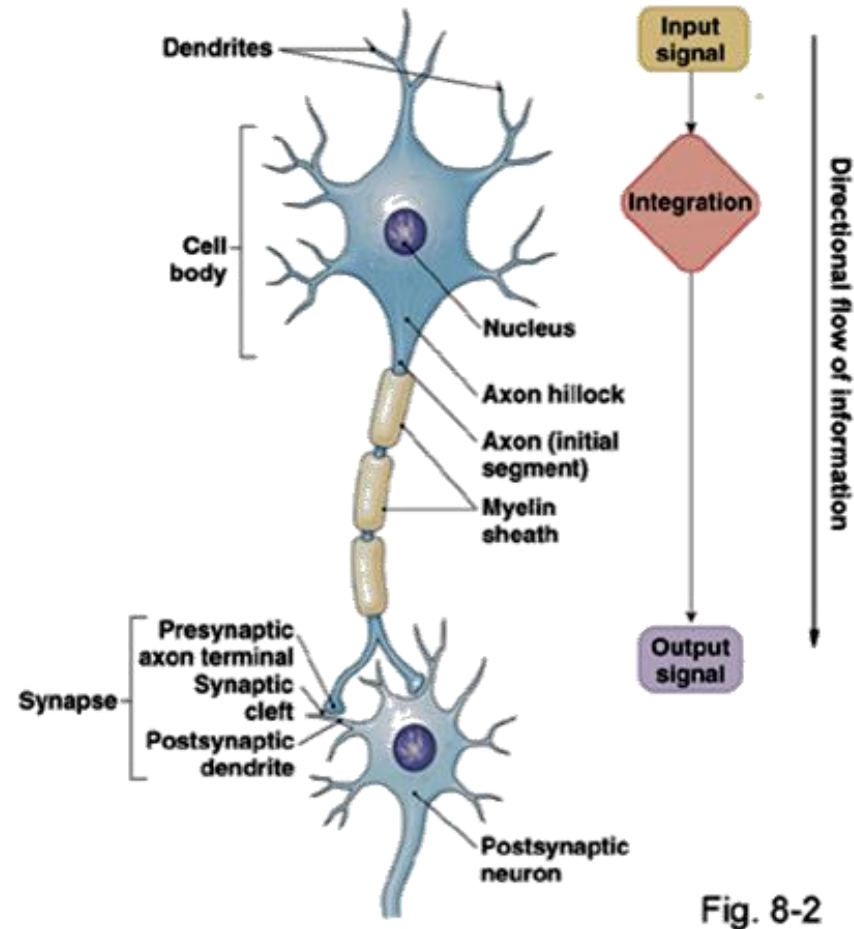

<http://www.slideshare.net/drpsdeb/presentations>

Zpracování a přenos informace

Membrána

- ✓ Recepce signálu
- ✓ Integrace signálu
- ✓ Generování AP
- ✓ Vedení AP
- ✓ Přenos signálu

Akční potenciál

- Rychlá změna napětí na membráně
- Vznik na axonovém hrbolu nebo iniciálním segmentu
- Šíří se membránou
- Princip vše nebo nic

Klidový potenciál
cca. -70 mV

Prahový potenciál
cca. -55 mV

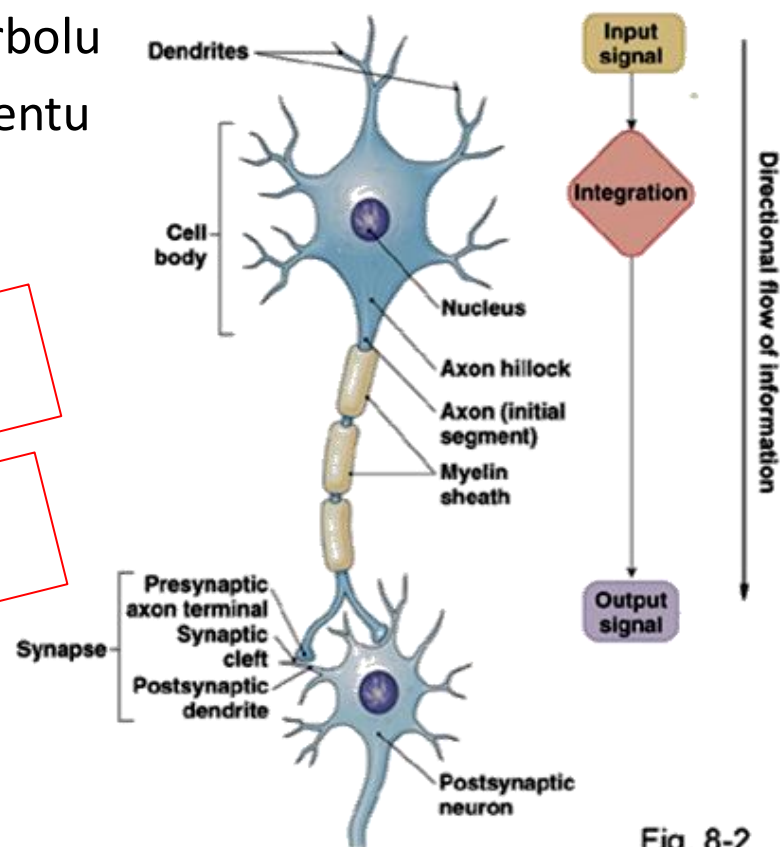
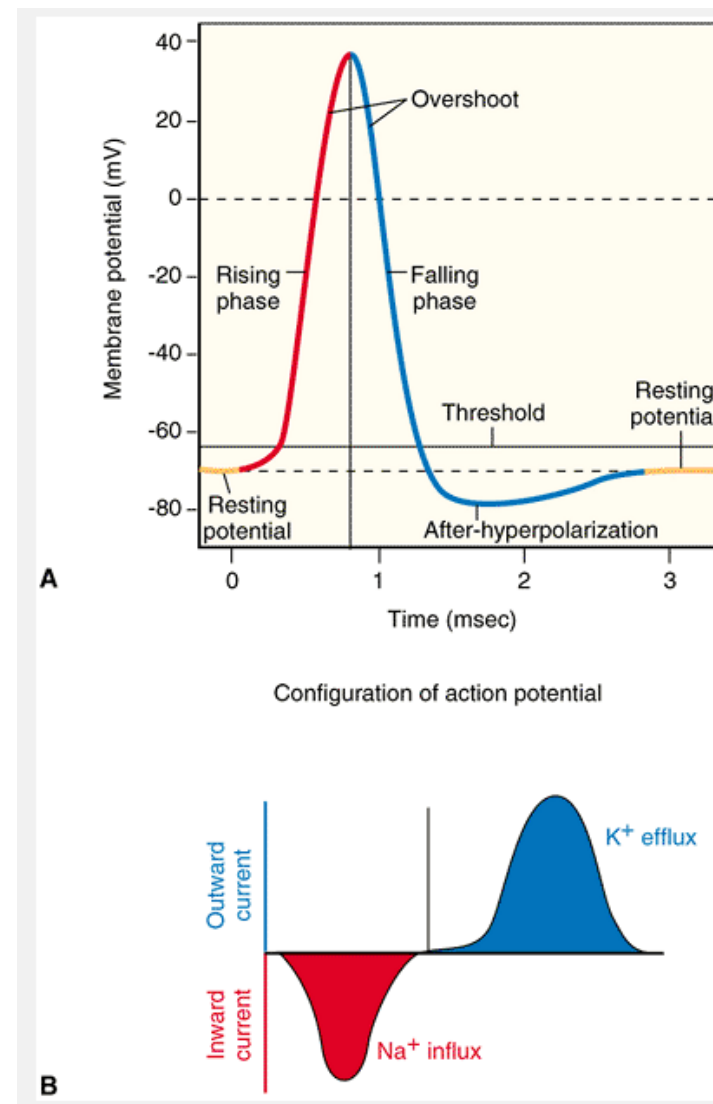

Fig. 8-2



Synapse

- Komunikace mezi neurony

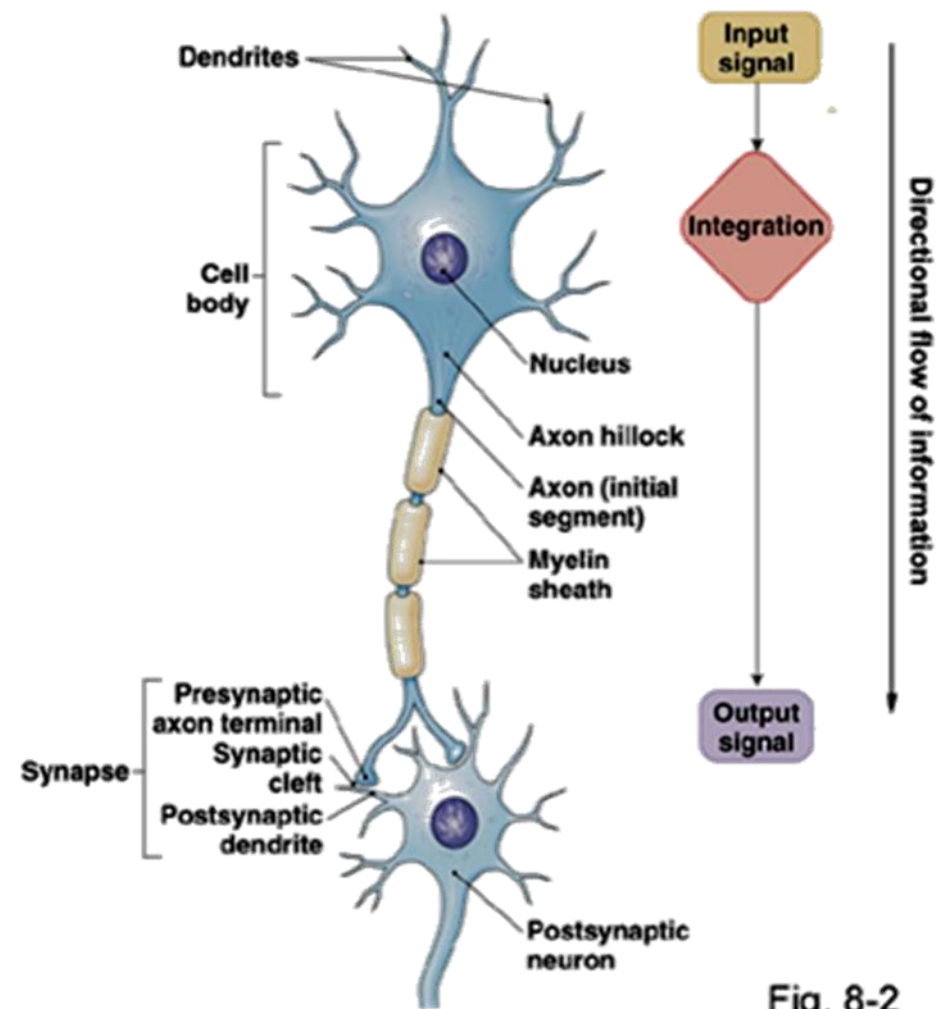

Fig. 8-2

<http://www.slideshare.net/CsillaEgri/presentations>

Synapse

- Komunikace mezi neurony
- Elektrické
- Chemické

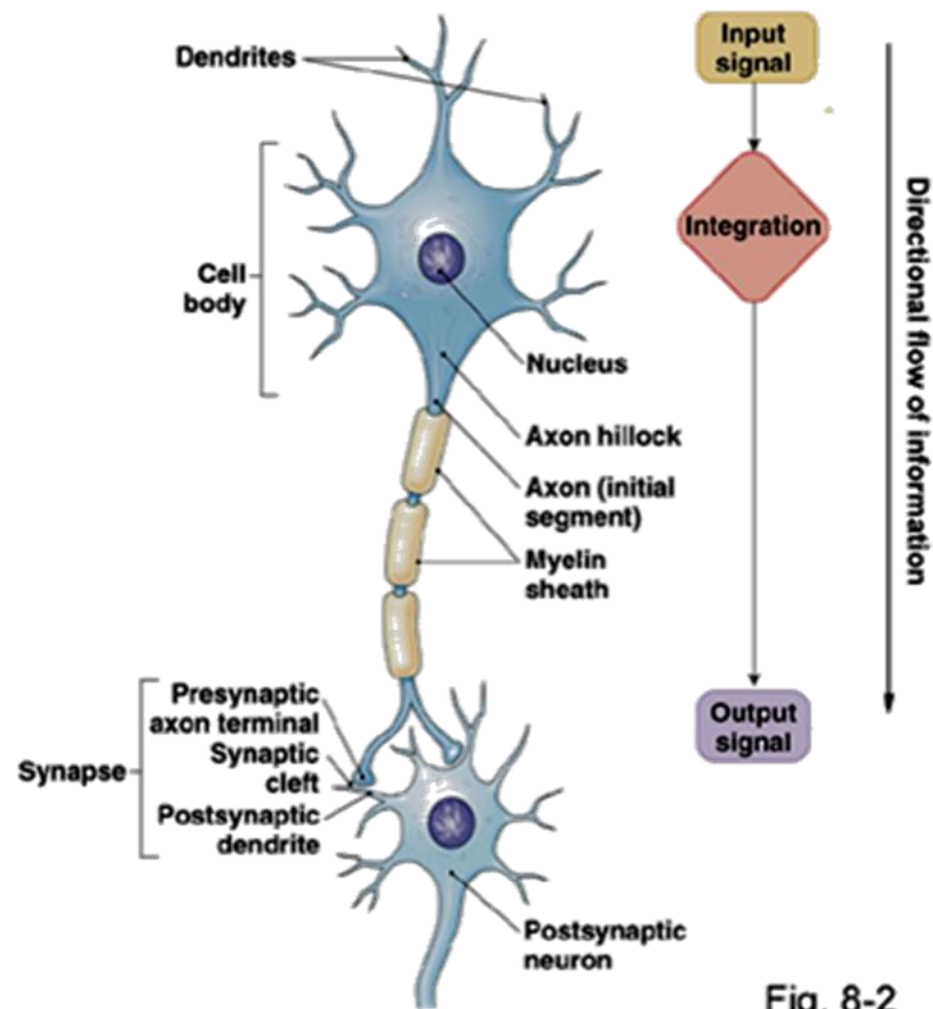
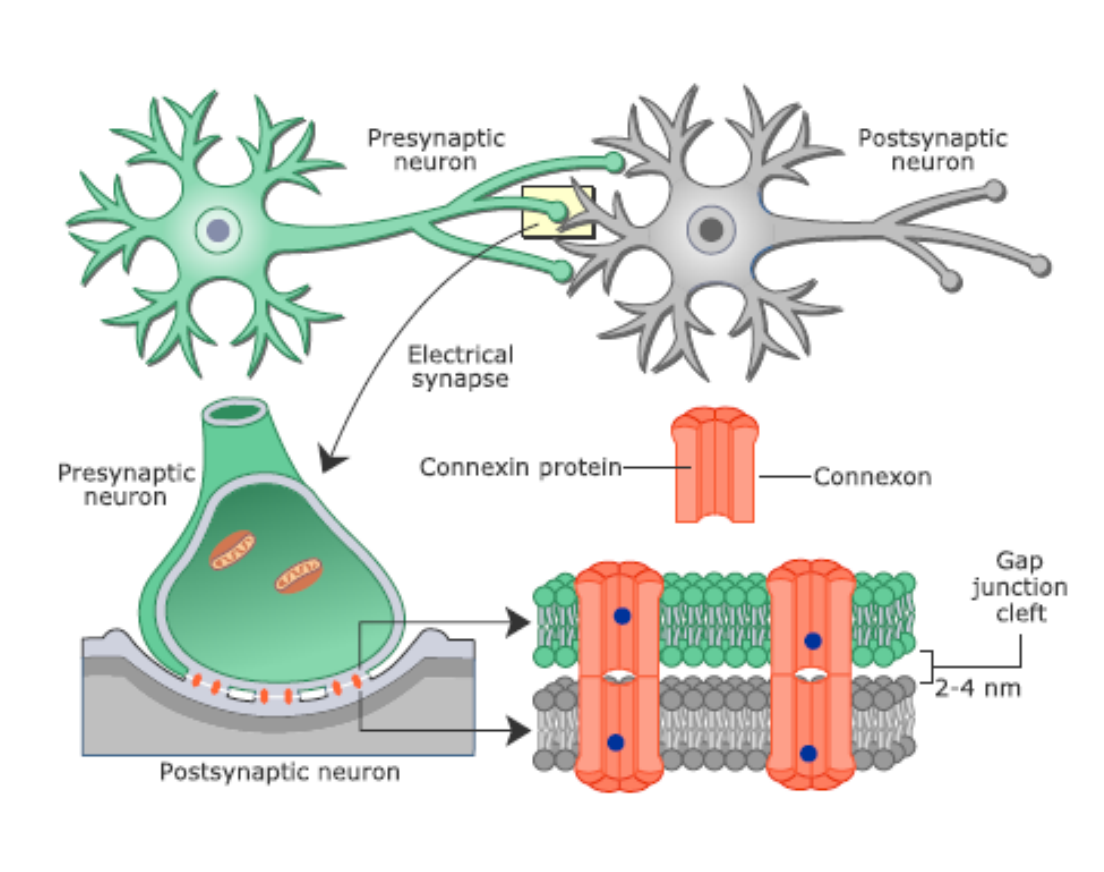

Fig. 8-2

<http://www.slideshare.net/CsillaEgri/presentations>

Elektrické synapse

- Evolučně staré
- Méně než chemických
- Ubikvitární



<http://www.slideshare.net/CsillaEgri/presentations>

Elektrické synapse

- Evolučně staré
- Méně než chemických
- Ubikvitární
- Gap junctions
- Obousměrný přenos
- Rychlost

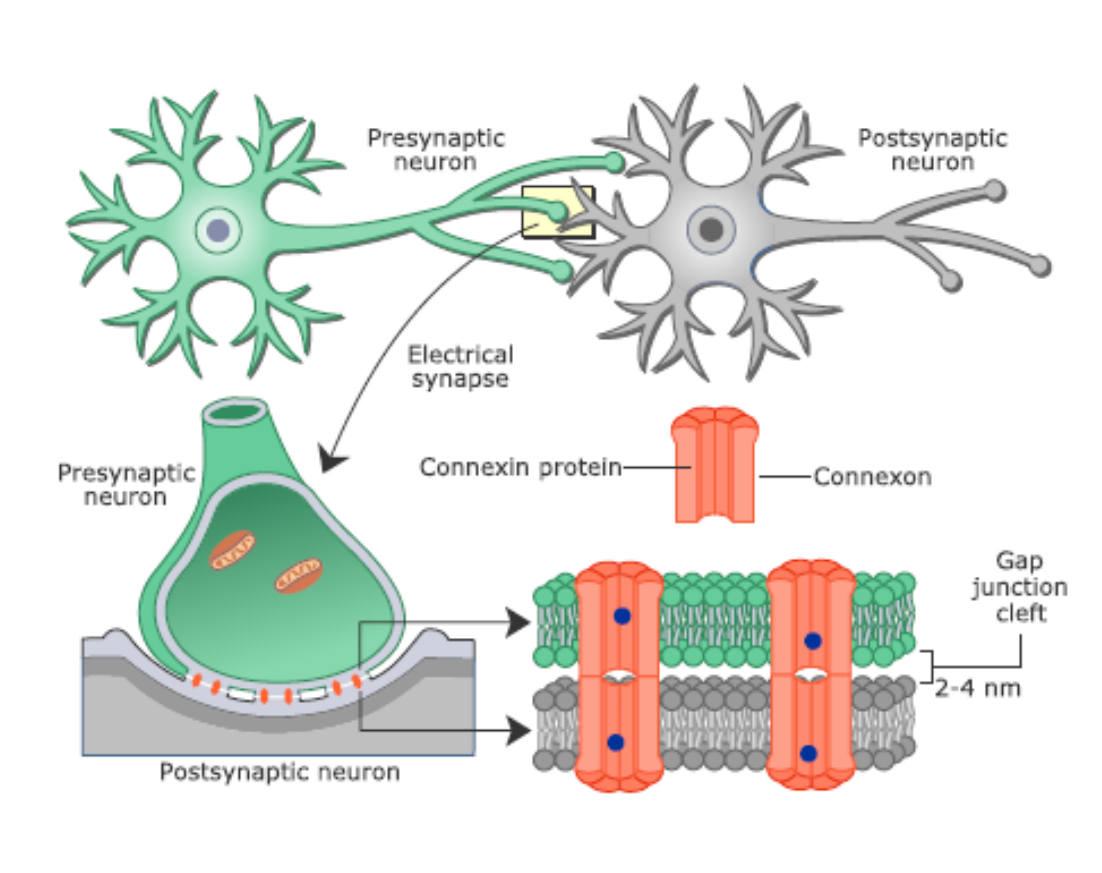

<http://www.slideshare.net/CsillaEgri/presentations>

Chemické synapse

- Evolučně mladší
- Většinový typ

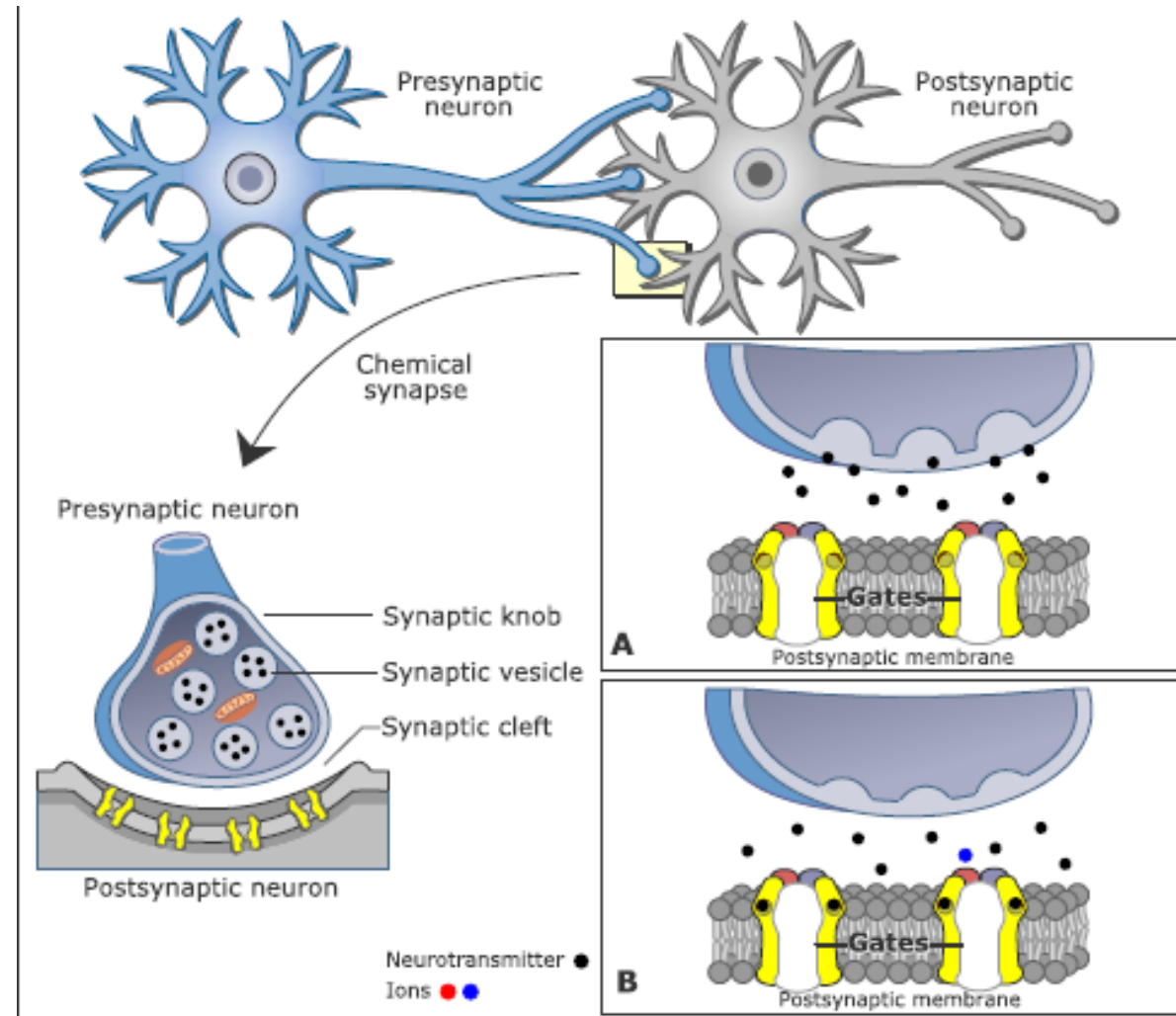

Chemické synapse

- Evolučně mladší
- Většinový typ
- Jednosměrný přenos
- Synaptická štěrbina
- Neurotransmitter

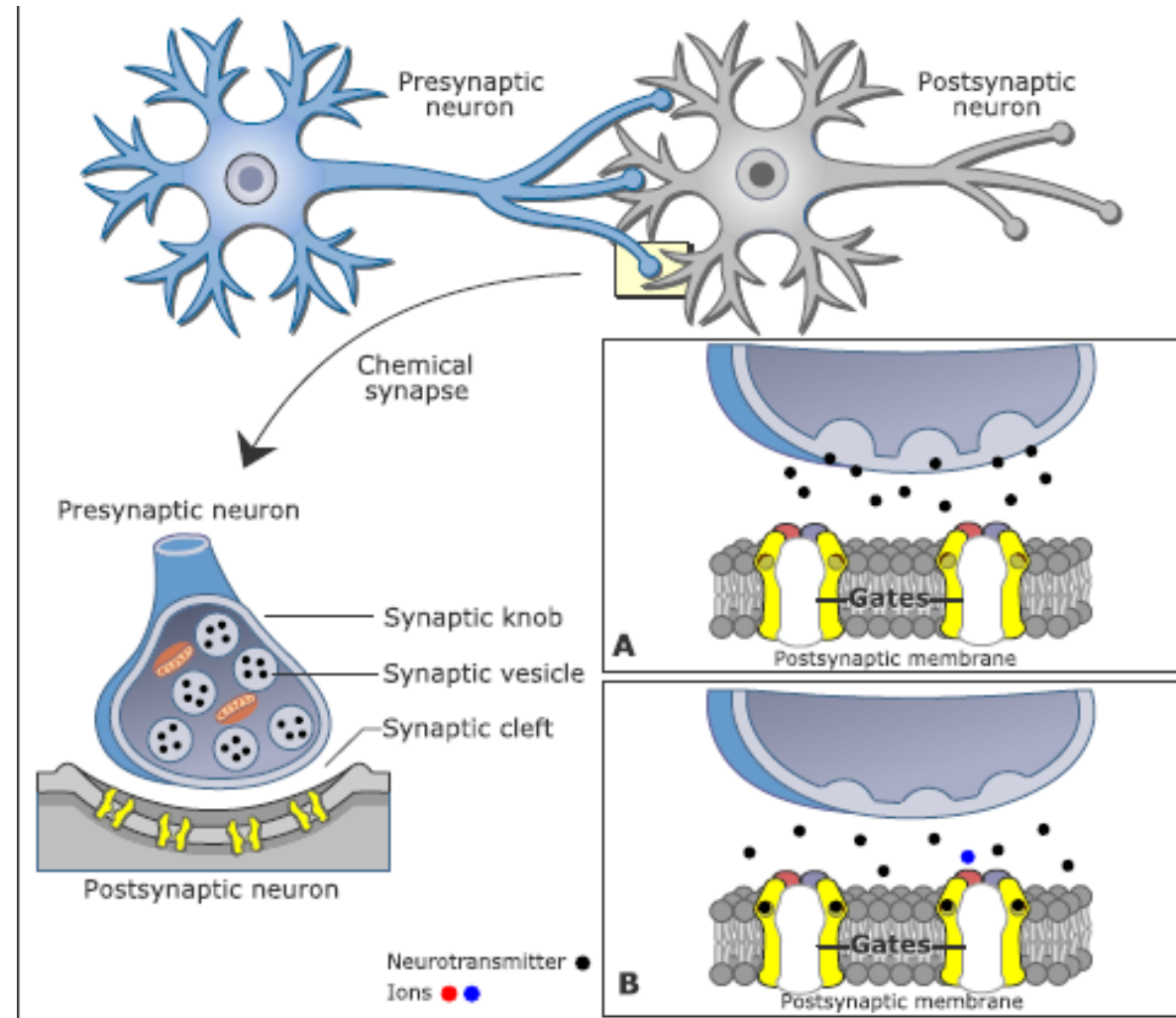

Neurotransmitter

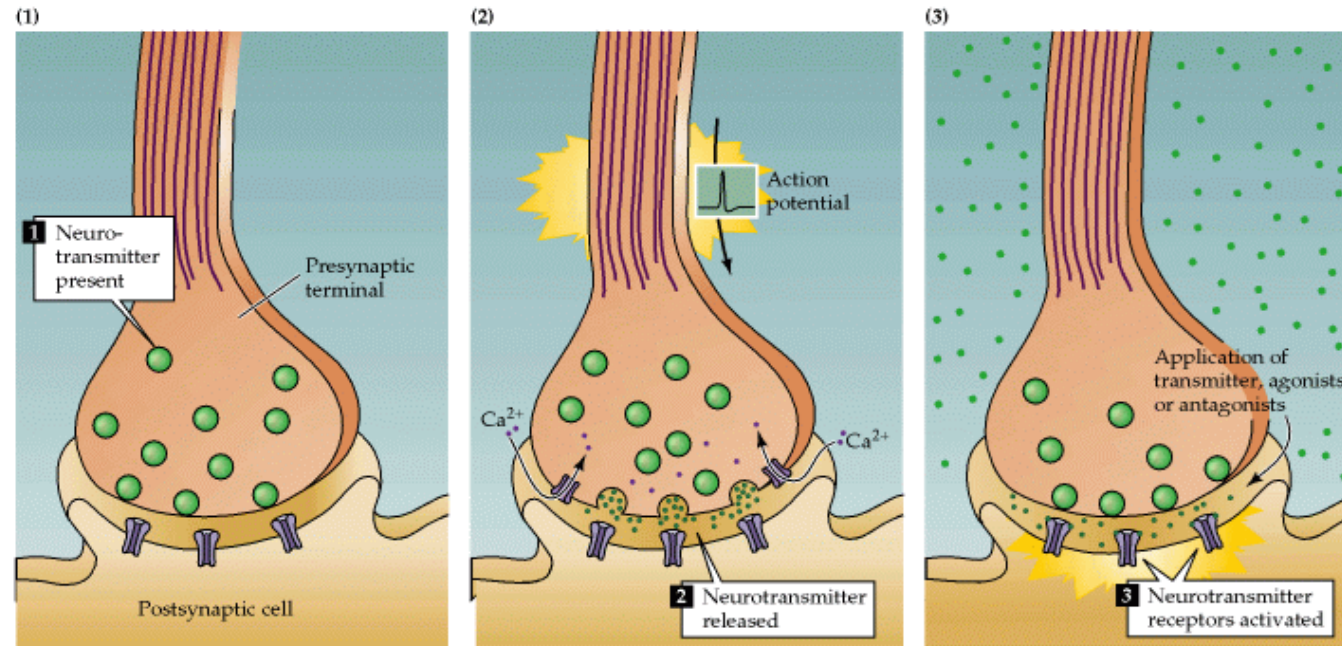

<http://www.slideshare.net/CsillaEgri/presentations>

- Přítomen v presynaptickém neuronu

Neurotransmitter

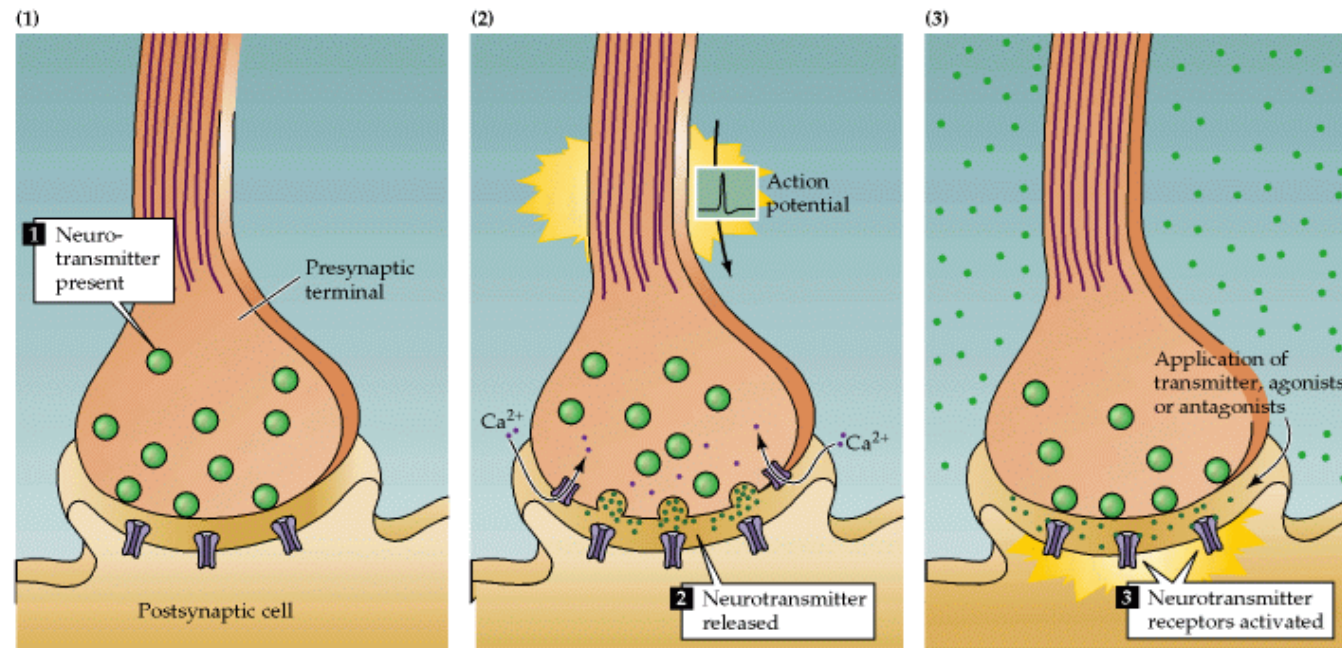

<http://www.slideshare.net/CsillaEgri/presentations>

- Přítomen v presynaptickém neuronu
- Uvolněn do synaptické štěrbině následkem depolarizace presynaptického neuronu (Ca^{2+} dependentní mechanismus)

Neurotransmitter

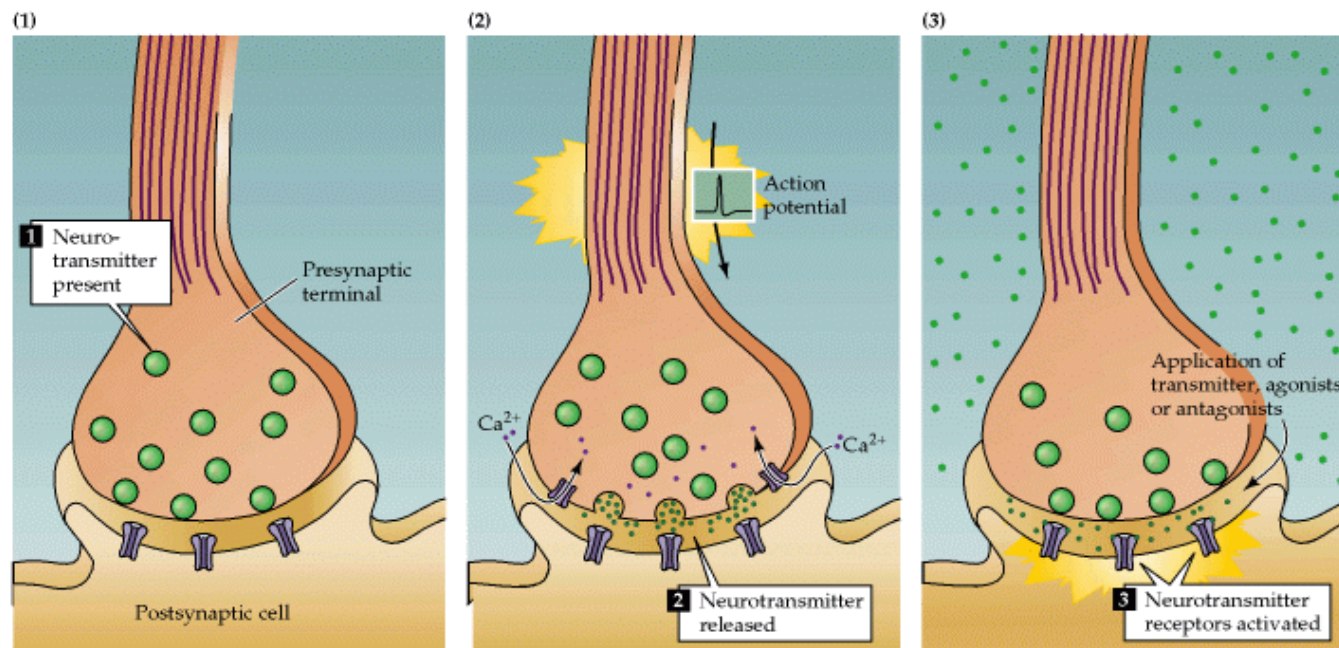

<http://www.slideshare.net/CsillaEgri/presentations>

- Přítomen v presynaptickém neuronu
- Uvolněn do synaptické štěrbině následkem depolarizace presynaptického neuronu (Ca^{2+} dependentní mechanismus)
- Postsynaptická membrána musí obsahovat specifické receptory

■ **FIGURE 4.2 Major Categories of Neurotransmitters, Neuromodulators, and Neurohormones**

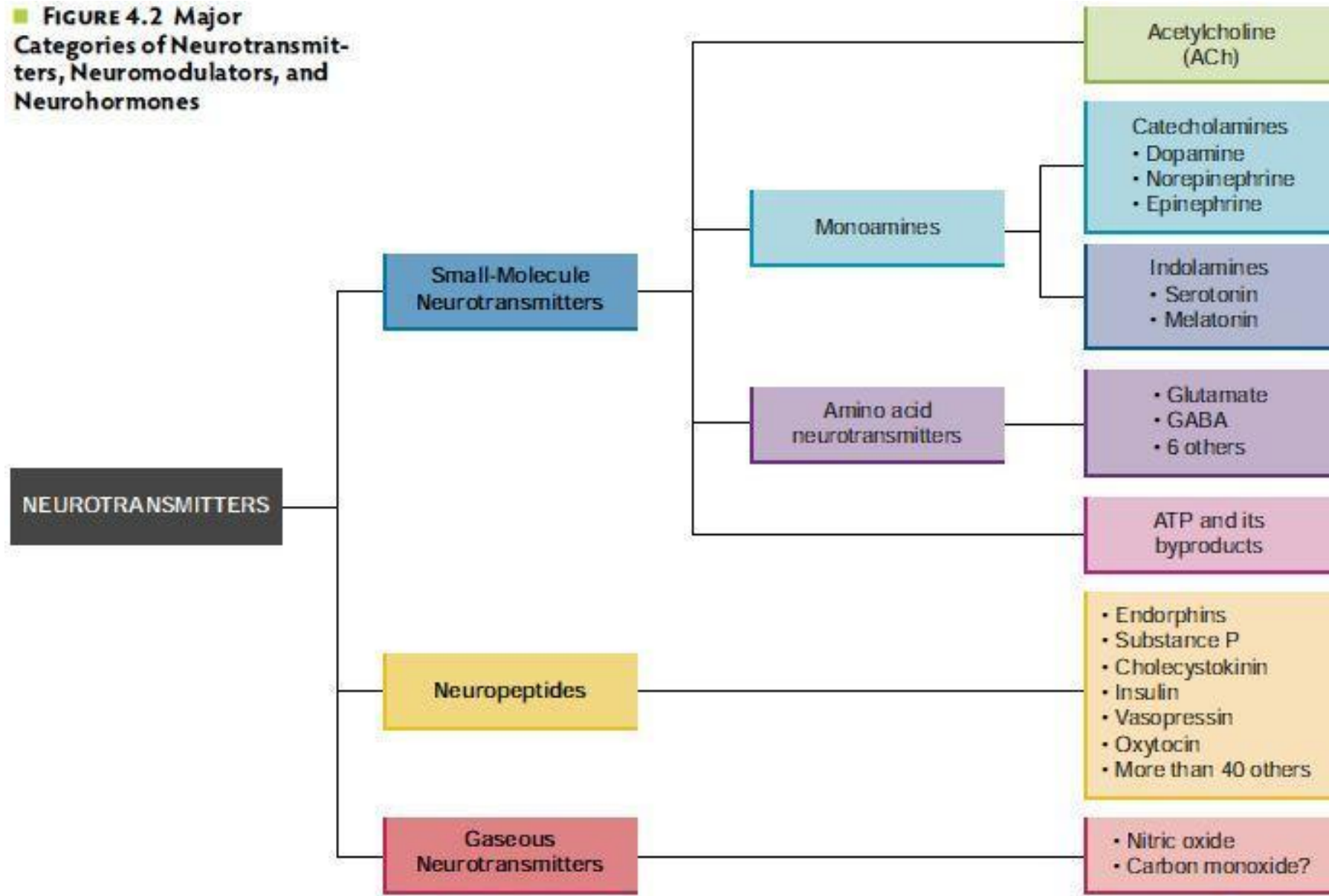

<https://classconnection.s3.amazonaws.com/108/flashcards/956108/jpg/bookpic421333407057201.jpg>

THE STRUCTURES OF NEUROTRANSMITTERS

STRUCTURE KEY: ● Carbon atom ○ Hydrogen atom ○ Oxygen atom (N) Nitrogen atom (R) Rest of molecule

ADRENALINE

Fight or flight neurotransmitter

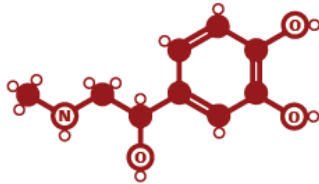

Produced in stressful or exciting situations. Increases heart rate & blood flow, leading to a physical boost & heightened awareness.

NORADRENALINE

Concentration neurotransmitter



Affects attention & responding actions in the brain, & involved in fight or flight response. Contracts blood vessels, increasing blood flow.

DOPAMINE

Pleasure neurotransmitter



Feelings of pleasure, and also addiction, movement, and motivation. People repeat behaviours that lead to dopamine release.

SEROTONIN

Mood neurotransmitter



Contributes to well-being & happiness; helps sleep cycle & digestive system regulation. Affected by exercise & light exposure.

GABA

Calming neurotransmitter



Calms firing nerves in CNS. High levels improve focus; low levels cause anxiety. Also contributes to motor control & vision.

ACETYLCHOLINE

Learning neurotransmitter



Involved in thought, learning, & memory. Activates muscle action in the body. Also associated with attention and awakening.

GLUTAMATE

Memory neurotransmitter



Most common brain neurotransmitter. Involved in learning & memory, regulates development & creation of nerve contacts.

ENDORPHINS

Euphoria neurotransmitters

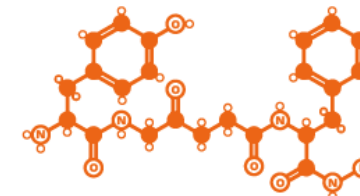

Released during exercise, excitement, & sex, producing well-being & euphoria, reducing pain. Biologically active section shown.



© COMPOUND INTEREST 2015 - WWW.COMPOUNDCHEM.COM | Twitter: @compoundchem | Facebook: www.facebook.com/compoundchem
This graphic is shared under a Creative Commons Attribution-NonCommercial-NoDerivatives licence.



THE STRUCTURES OF NEUROTRANSMITTERS

STRUCTURE KEY: ● Carbon atom ○ Hydrogen atom ⊙ Oxygen atom ⊙ Nitrogen atom ⊙ Rest of molecule

ADRENALINE

Fight or flight neurotransmitter

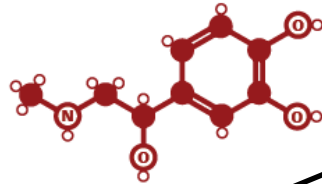

Produced in stressful or exciting situations. Increases heart rate & blood flow, leading to a physical boost & heightened awareness.

NORADRENALINE

Concentration neurotransmitter



Involved in thought, learning, & memory. Activates muscle action in the body. Also associated with attention and awakening.

ACETYLCHOLINE

Motor neurotransmitter



Most common brain neurotransmitter. Involved in learning & memory, regulates development & creation of nerve contacts.

SEROTONIN

Mood neurotransmitter



Contributes to well-being & happiness; helps sleep cycle & digestive system regulation. Affected by exercise & light exposure.

ENDORPHINS

Euphoria neurotransmitters

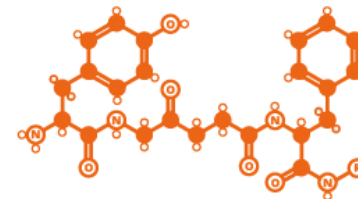

Released during exercise, excitement, & sex, producing well-being & euphoria, reducing pain. Biologically active section shown.

GABA

Calming neurotransmitter



Calms firing nerves in CNS. High levels improve focus; low levels cause anxiety. Also contributes to motor control & vision.

Excitační
(kyselina glutamová, acetylcholin)
X
Inhibiční
(GABA)



© COMPOUND INTEREST 2015 - WWW.COMPOUNDCHEM.COM | Twitter: @compoundchem | Facebook: www.facebook.com/compoundchem
This graphic is shared under a Creative Commons Attribution-NonCommercial-NoDerivatives licence.



Neuromuskulární spojení

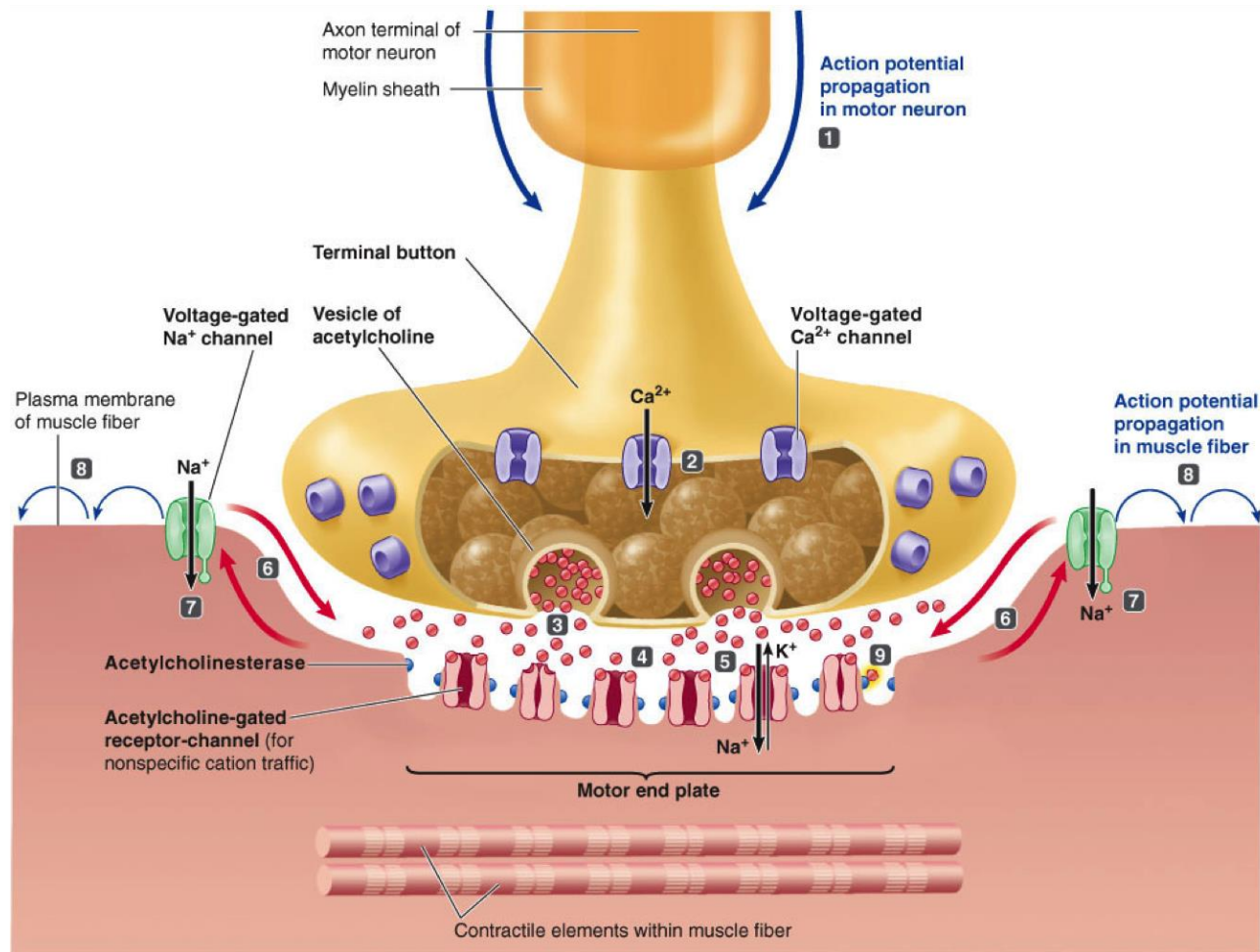

https://classconnection.s3.amazonaws.com/754/flashcards/2034754/png/ch_7_pic_41349381290275.png

Excitační/inhibiční postsynaptický potenciál

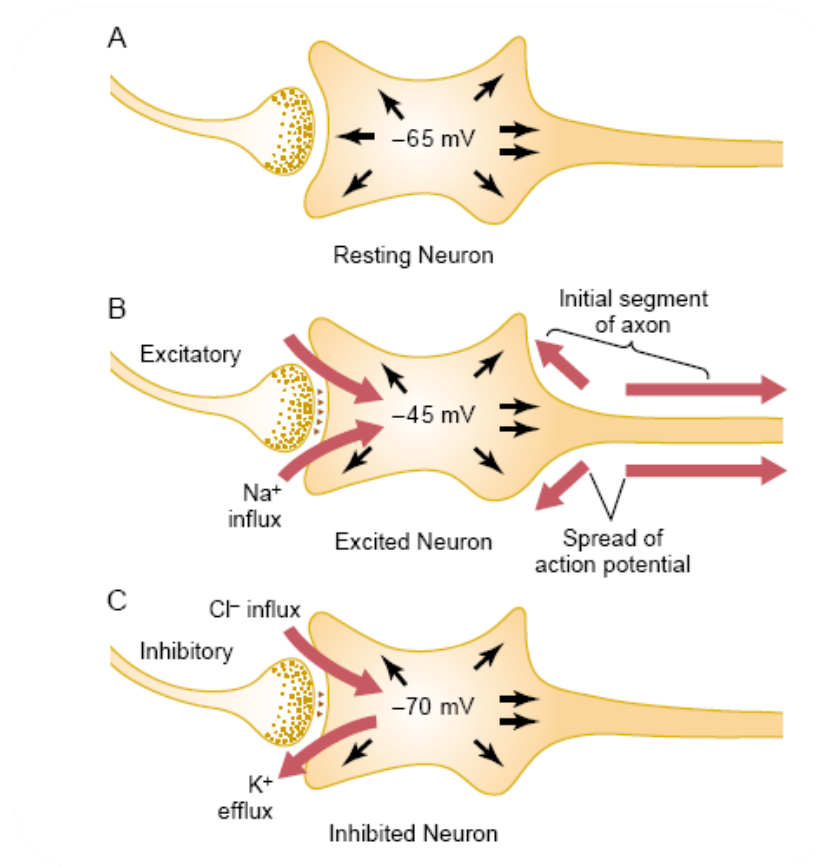

<http://www.slideshare.net/drpsdeb/presentations>

Sumace signálu

- Časová
- Prostorová

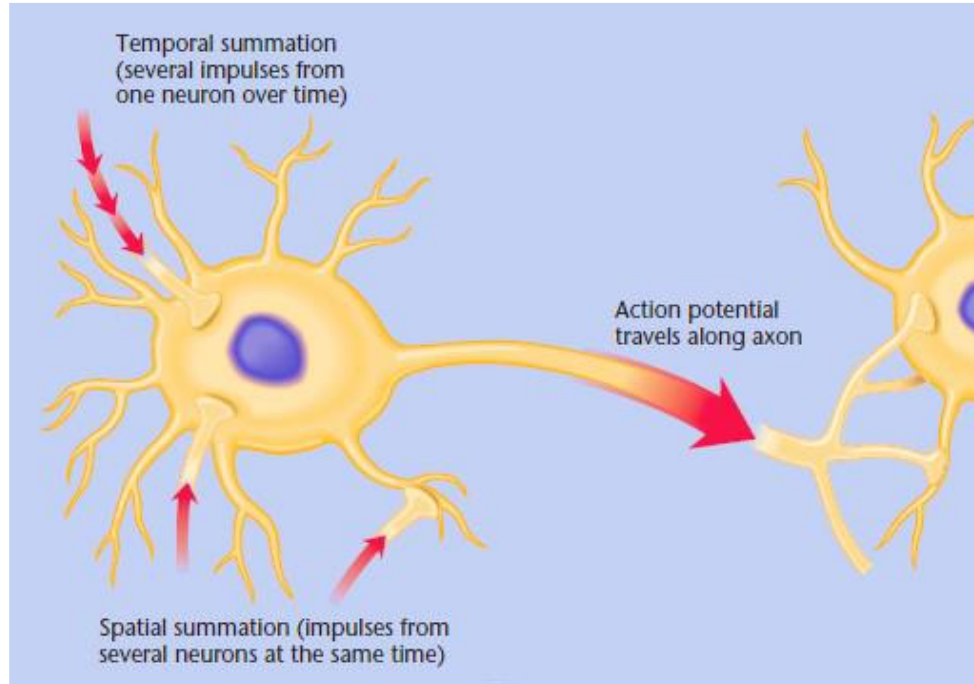

https://www.slideshare.net/drgabe/biological-psychology-synapses?from_action=save

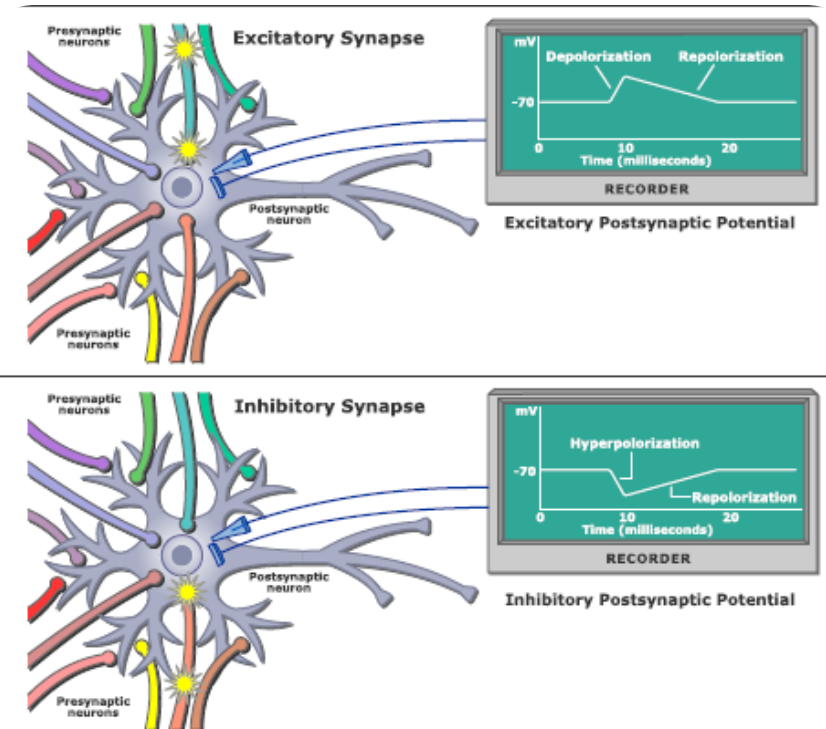

<http://www.slideshare.net/drpsdeb/presentations>

Sumace signálu

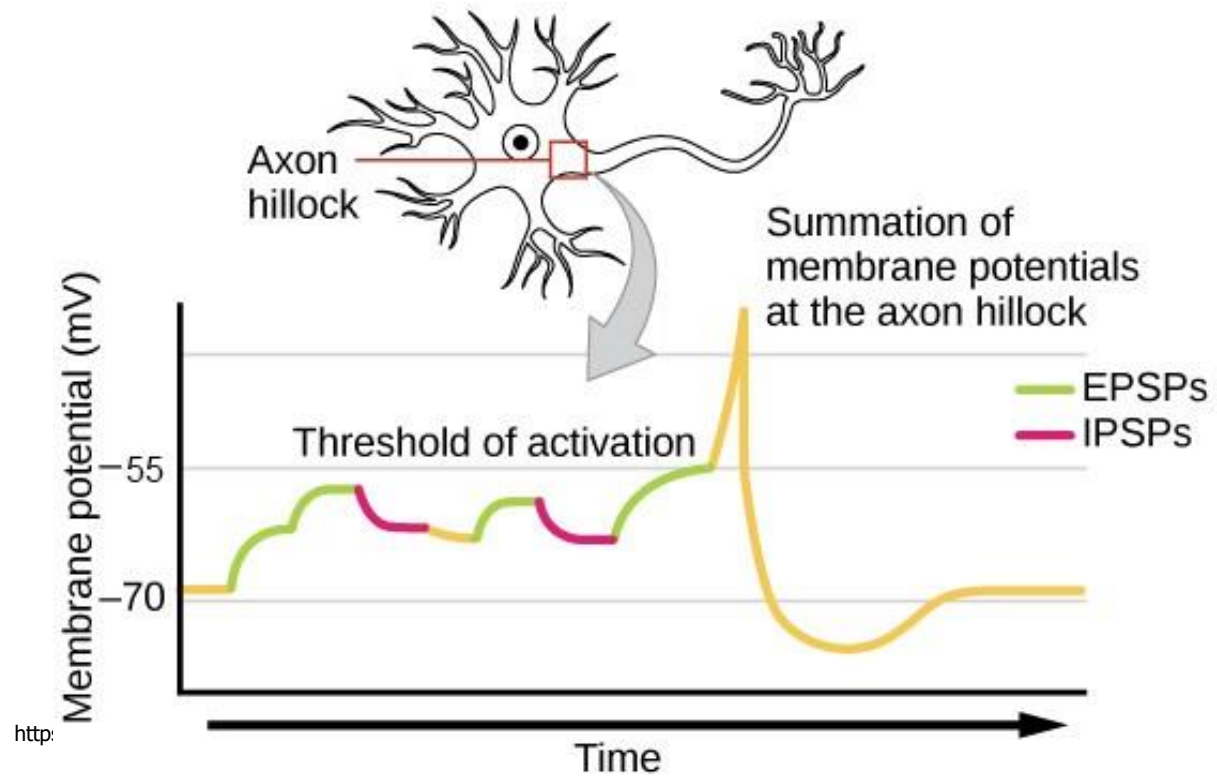

<http://www.geon.us/Memory/images/Summation.jpg>

Konvergence signálu

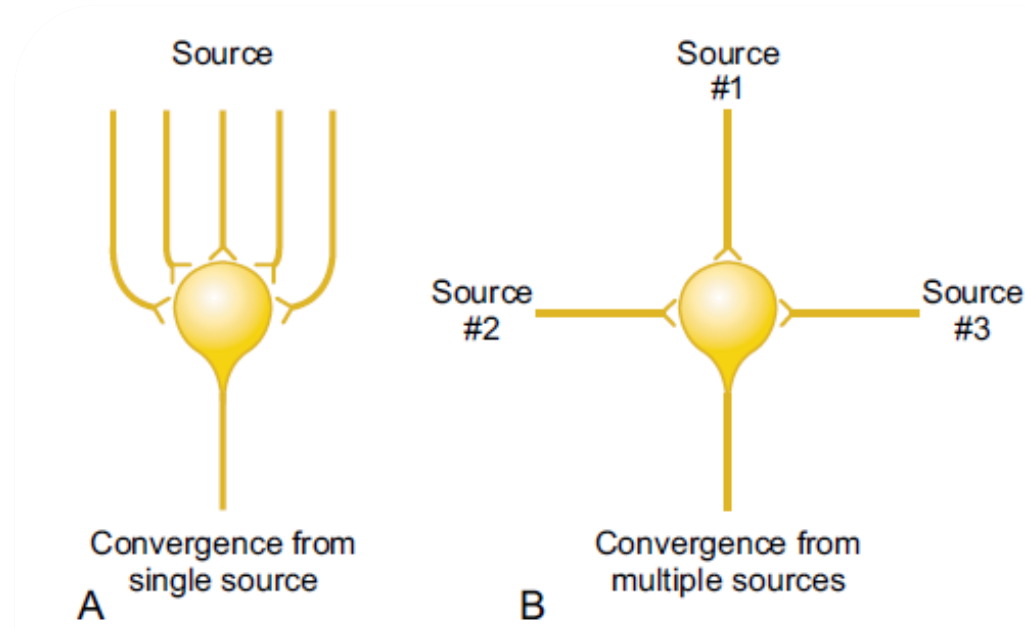

Figure 46-12

“Convergence” of multiple input fibers onto a single neuron. *A*, Multiple input fibers from a single source. *B*, Input fibers from multiple separate sources.

<http://www.slideshare.net/drpsdeb/presentations>

Divergence signálu

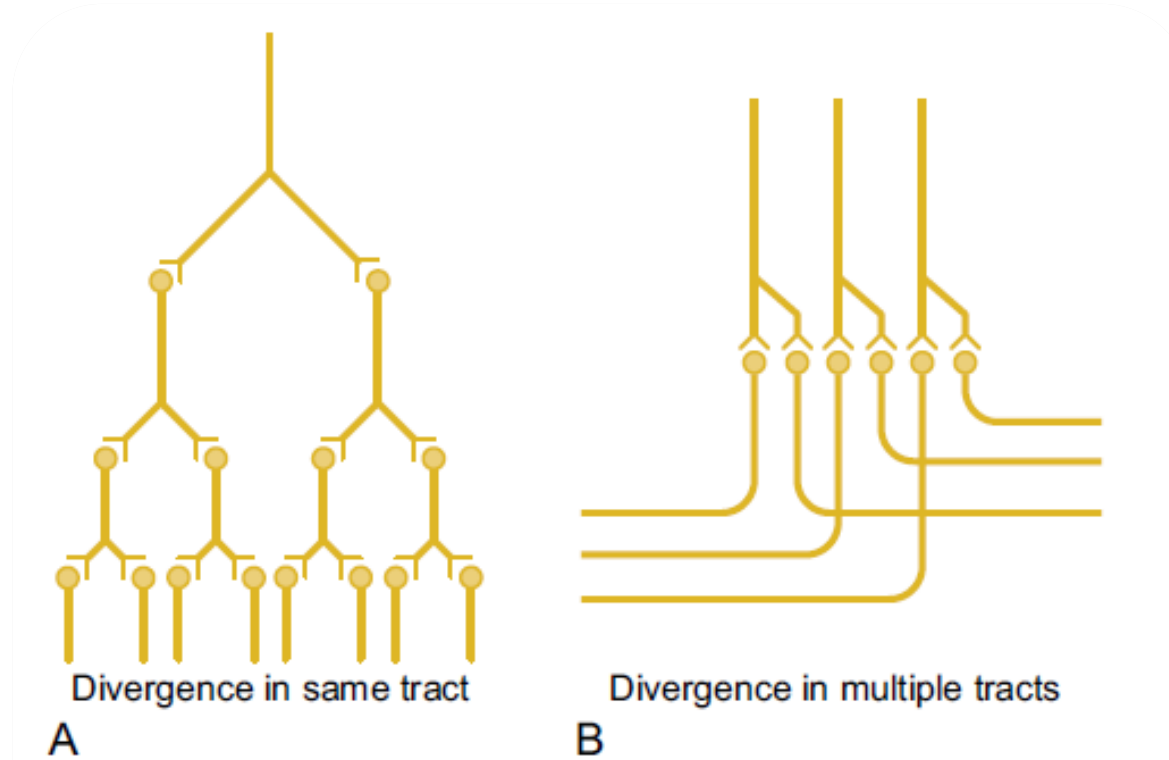

Figure 46-11

“Divergence” in neuronal pathways. *A*, Divergence within a pathway to cause “amplification” of the signal. *B*, Divergence into multiple tracts to transmit the signal to separate areas.

Synaptická konvergence a divergence

Průměrný počet synapsí
na neuron u primátů

✓ Primární zrakový
kortex (area17)
– cca. 4 000

✓ Primární motorický
kortex (area4)
– cca. 60 000

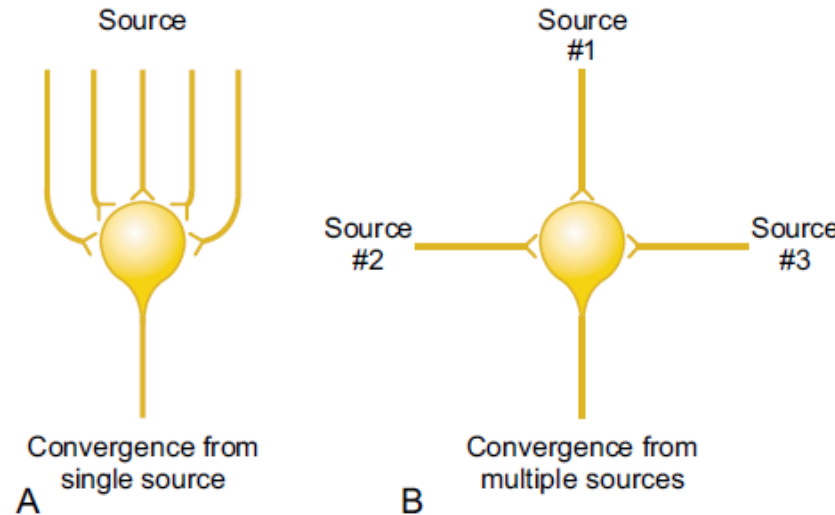

Figure 46-12

"Convergence" of multiple input fibers onto a single neuron. A, Multiple input fibers from a single source. B, Input fibers from multiple separate sources.

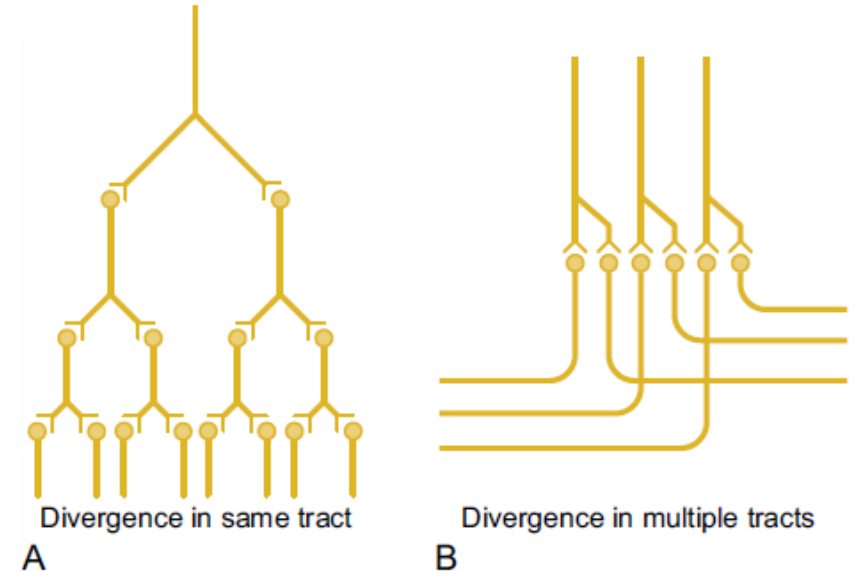
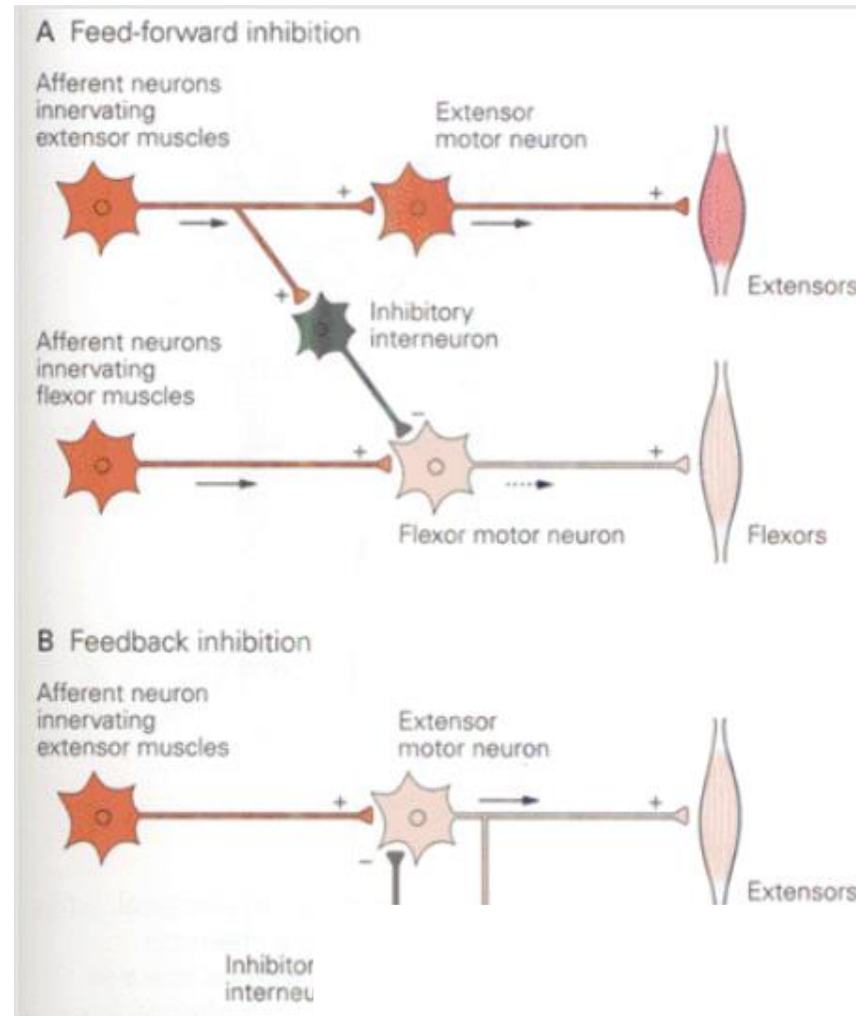

Figure 46-11

"Divergence" in neuronal pathways. A, Divergence within a pathway to cause "amplification" of the signal. B, Divergence into multiple tracts to transmit the signal to separate areas.

<http://www.slideshare.net/drpsdeb/presentations>

Networking



Networking

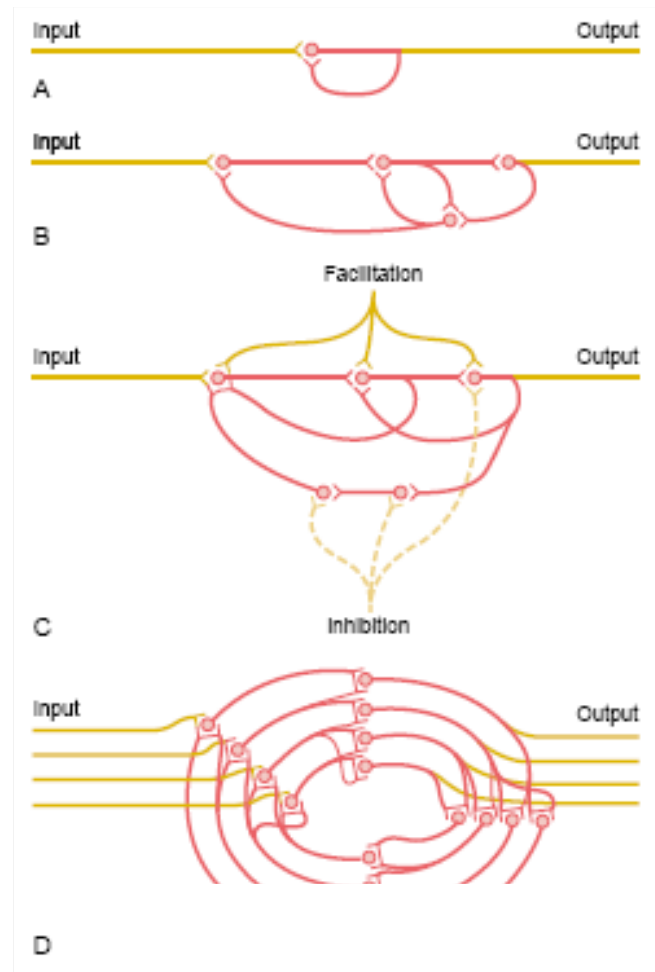

Neurotransmise

vs.

Neuromodulace

- Přenos informace

- Regulace aktivity NS

Neurotransmise

vs.

Neuromodulace

- Přenos informace
- Specifická

- Regulace aktivity NS
- Difúzní (volume transmission)

Neurotransmise

vs.

Neuromodulace

- Přenos informace
- Specifická
- Receptory
 - Iontové kanály

- Regulace aktivity NS
- Difúzní (volume transmission)
- Receptory
 - Pomalé G-proteiny

Neurotransmise

vs.

Neuromodulace

- Přenos informace
 - Specifická
 - Receptory
 - Iontové kanály
 - Krátký účinek
 - Změny membránového potenciálu
- Regulace aktivity NS
 - Difúzní (volume transmission)
 - Receptory
 - Pomalé G-proteiny
 - Déletrvající účinek
 - Změny vlastností synapsí atd.

Acetylcholin

- Nucleus basalis (Meynerti) a řada dalších jader
- Nikotinové receptory
- Muskarinové receptory

- Regulace spánku/bdění
- Kognitivní funkce
- Chování
- Emoce

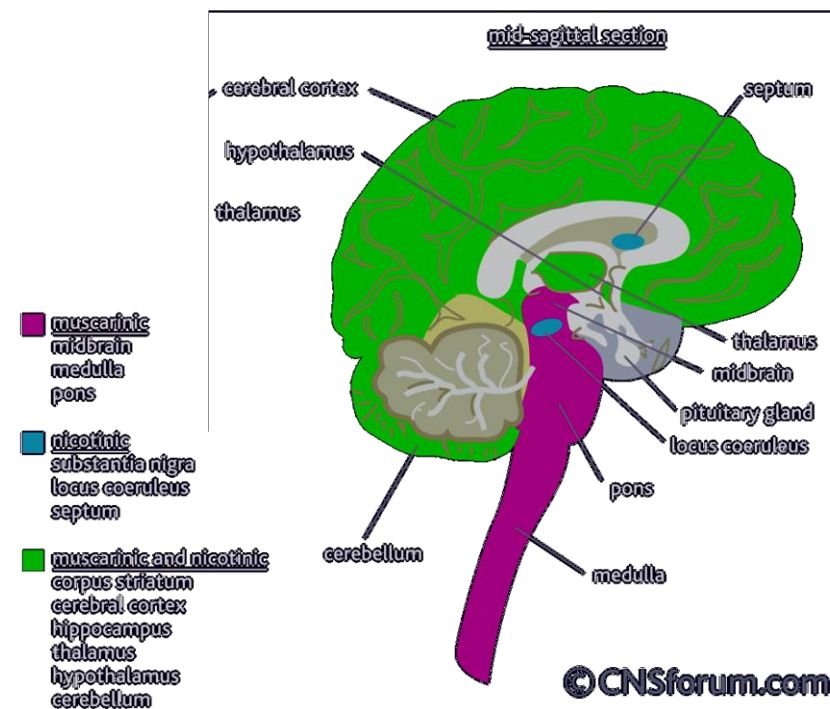
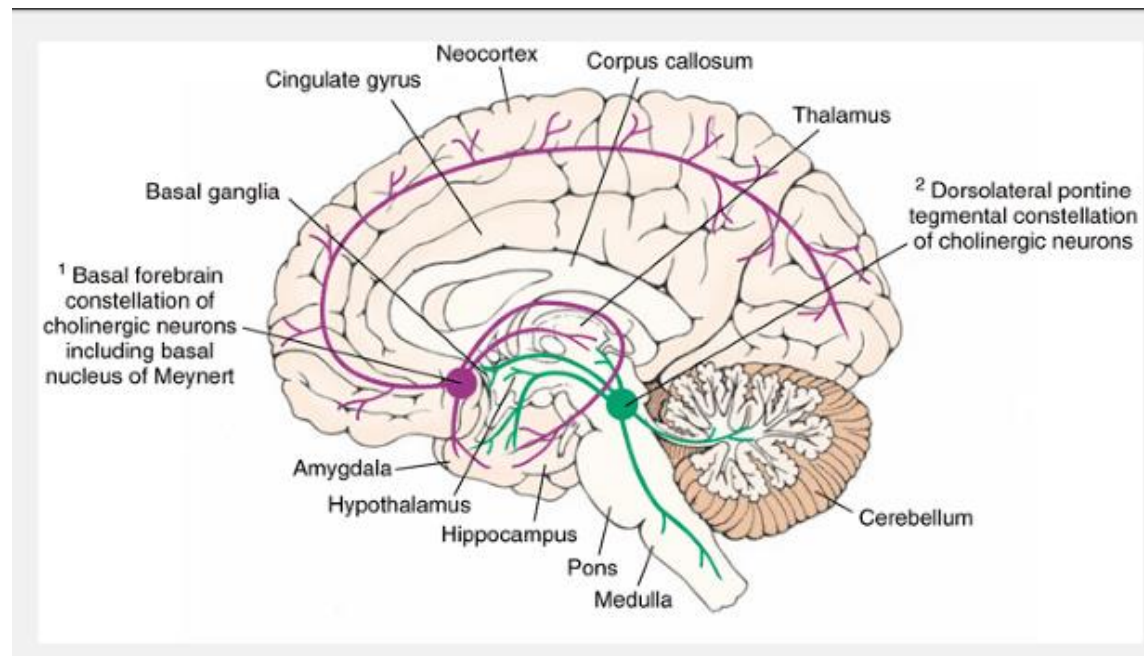

Noradrenalin

- Locus coeruleus
- Nuclei raphe caudalis

- Bdělost
- Responzivita na nečekané podmínky
- Paměť
- Učení

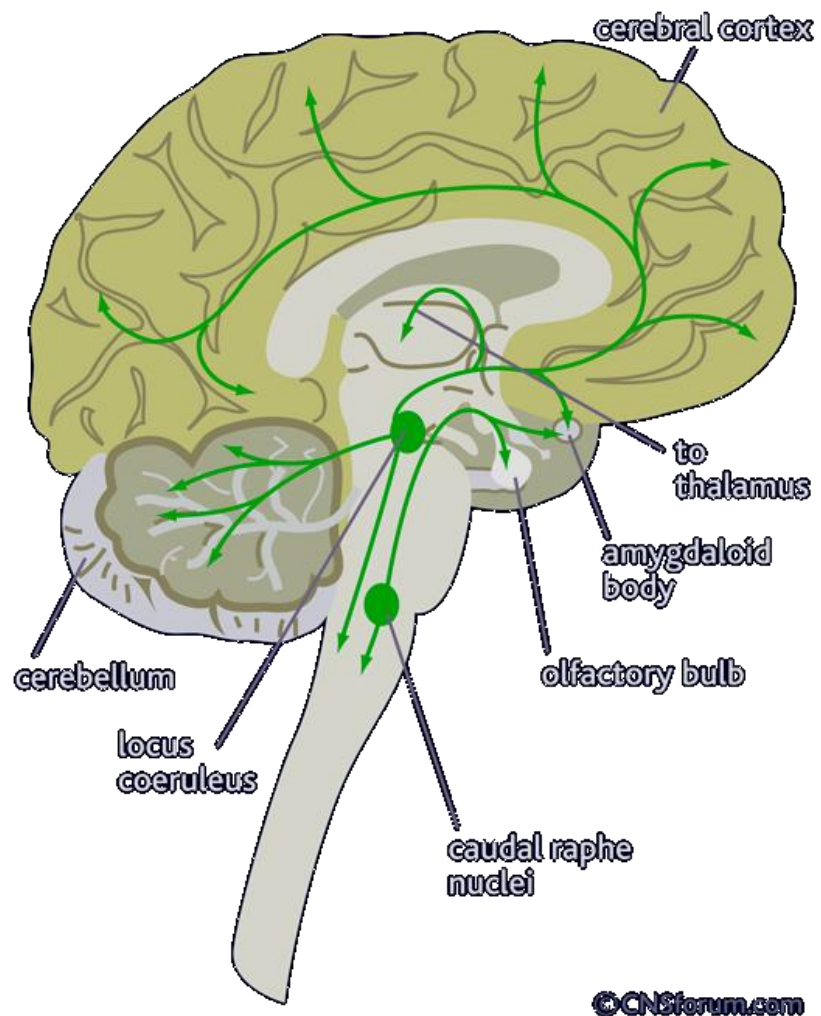

<http://www.slideshare.net/drpsdeb/presentations>

Dopamin

- Nigrostriatální systém
 - Pohyb
 - Senzorika
- Ventrosegmentno-meso-
limbicko-frontální systém
 - Systém odměny
 - Kognitivní funkce
 - Emoční chování
- Tubero-infundibulární systém
 - Regulace hypotalamo-
hypofyzárního systému
- D1 receptory – stimulační
- D2 receptory - inhibiční

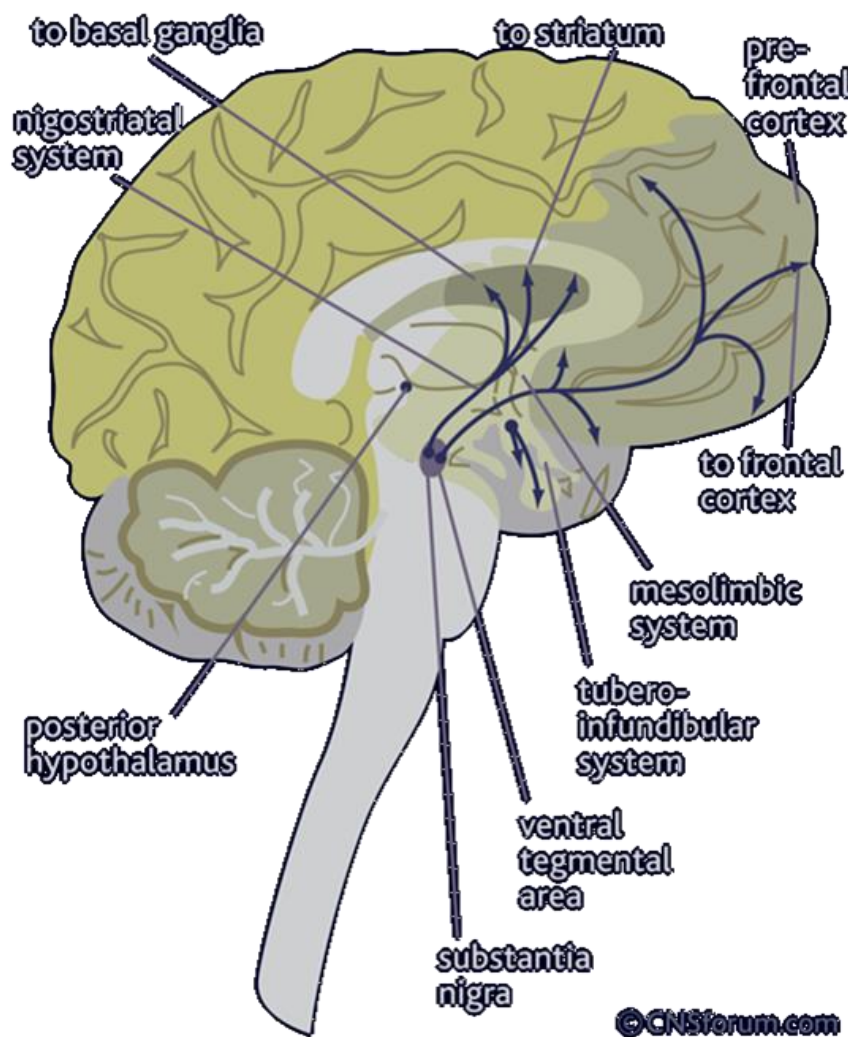

<http://www.slideshare.net/drpsdeb/presentations>

Serotonin

- Nuclei raphe rostralis
- Nuclei raphe caudalis

- Úzkost/relaxace
- Impulzivnost
- Spánek

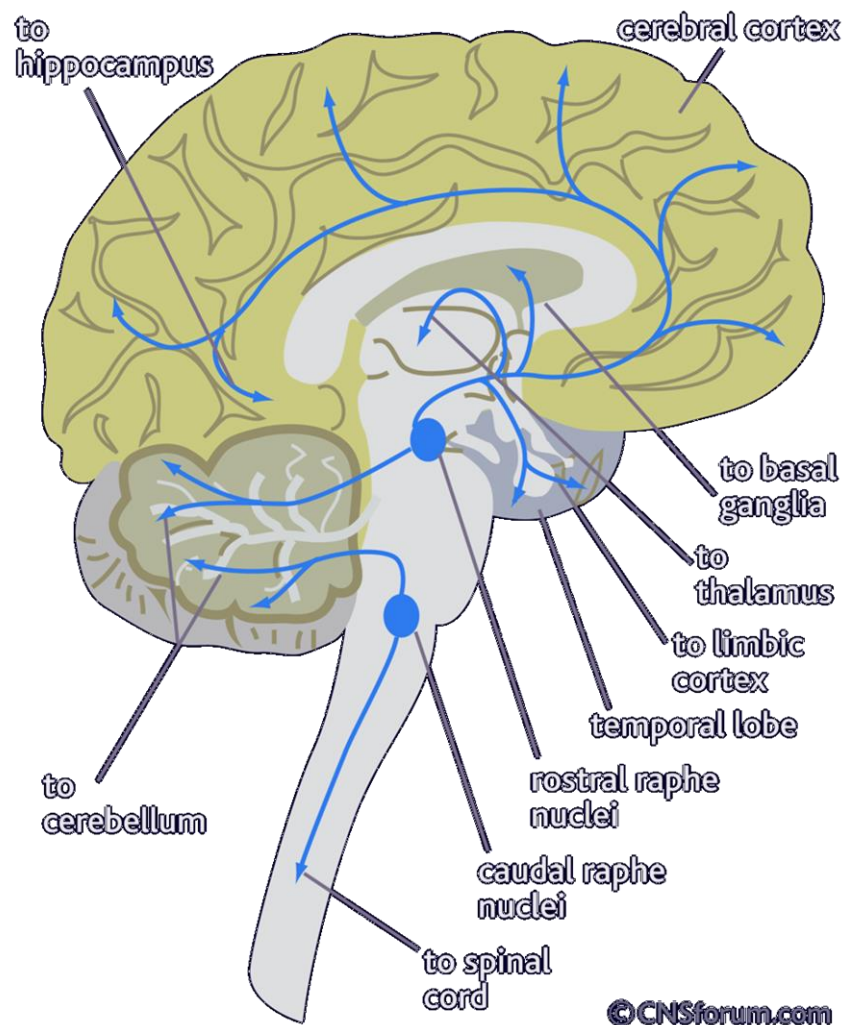

<http://www.slideshare.net/drpsdeb/presentations>

Neuromodulační systémy

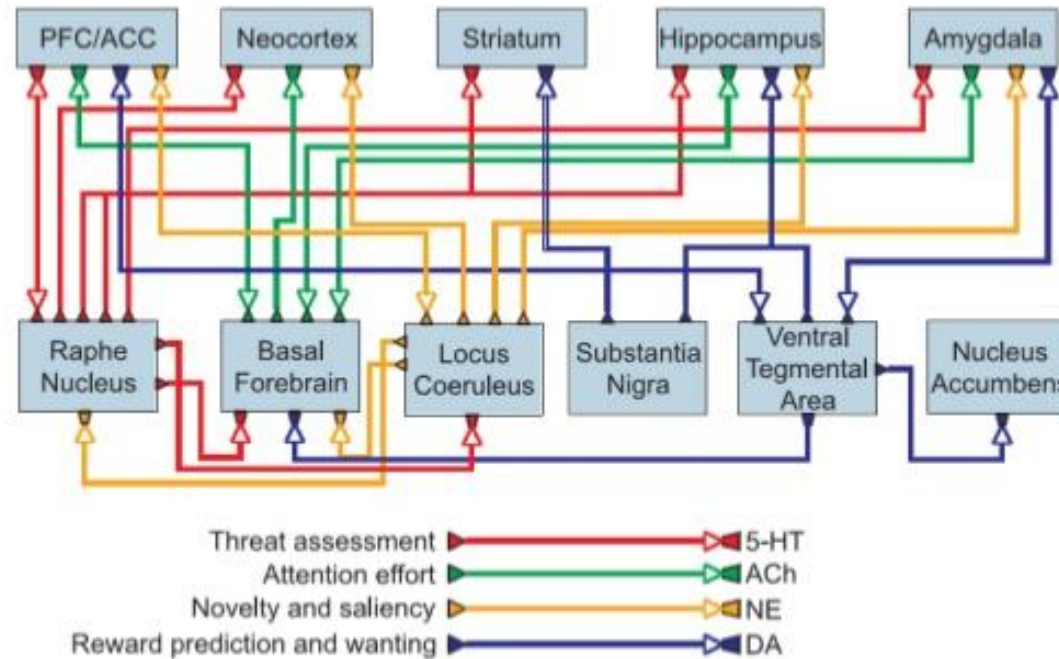

Jeffrey L. Krichmar, Adaptive Behavior 2008; 16; 385

<http://image.slidesharecdn.com/neuromodulationincognition-140119031056-phpapp02/95/neuromodulation-incognition-5-638.jpg?cb=1419657931>

Neuromodulační systémy

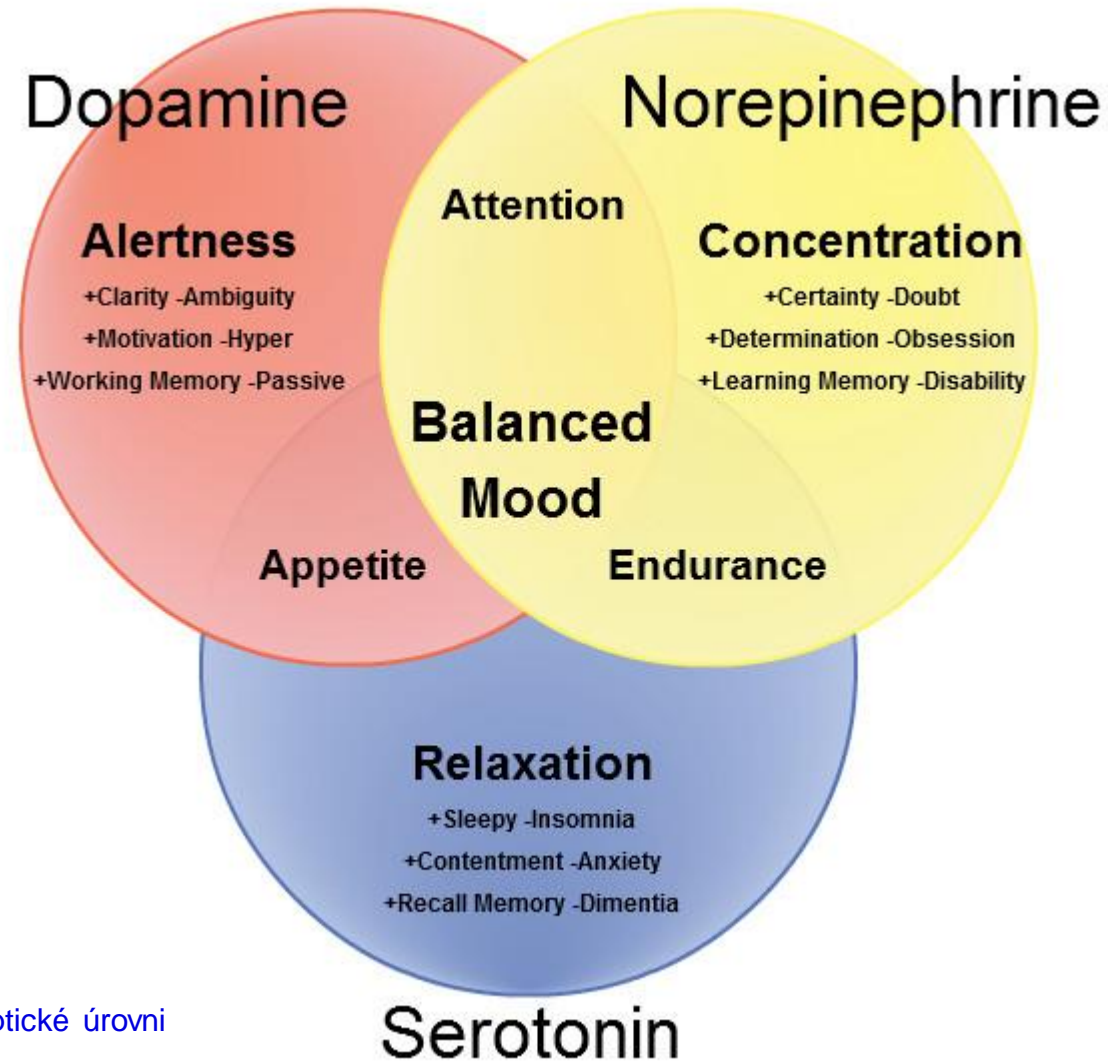

71. Synapse a integrace informace na synaptické úrovni, neurotransmise vs. neuromodulace

- ✓ Synapse
 - Definice
 - Elektrické vs. chemické
- ✓ Definice a základní klasifikace neurotransmiterů
- ✓ Excitační/inhibiční postsynaptické potenciály vs. Akční potenciál
 - Časová a místní sumace signálu
- ✓ Konvergence a divergence signálu
- ✓ Neurotransmise vs. neuromodulace
 - Příklady neuromodulačních systémů

M U N I

M E D